



**papiNet**

**Business Acknowledgement**

**papiNet Standard - Version 2.31**

**Documentation**

**Global Standard for the Paper and Forest  
Products Supply Chain**

**Build V2R31\_20100415**

**Date 2010-04-26**

**Production Release**

# Business Acknowledgement

## papiNet Standard - Version 2.31

---

---

### Copyright

Copyright 2000 – 2010 papiNet G.I.E (“papiNet”), International Digital Enterprise Alliance, Inc. (“IDEAlliance”), and American Forest & Paper Association, Inc. (“AF&PA”), collectively “Copyright Owner”. All rights reserved by the Copyright Owner under the laws of the United States, Belgium, the European Economic Community, and all states, domestic and foreign. This document may be downloaded and copied provided that all copies retain and display the copyright and any other proprietary notices contained in this document. This document may not be sold, modified, edited, or taken out of context such that it creates a false or misleading statement or impression as to the purpose or use of the papiNet specification, which is an open standard. Use of this Standard, in accord with the foregoing limited permission, shall not create for the user any rights in or to the copyright, which rights are exclusively reserved to the Copyright Owner.

papiNet (formerly known as the European Paper Consortium for e-business - EPC), IDEAlliance (formerly known as the Graphic Communications Association - GCA), the parent organisation of IDEAlliance the Printing Industries of America (PIA), the American Forest and Paper Association (AF&PA), and the members of the papiNet Working Group (collectively and individually, "Presenters") make no representations or warranties, express or implied, including, but not limited to, warranties of merchantability, fitness for a particular purpose, title, or non-infringement. The presenters do not make any representation or warranty that the contents of this document are free from error, suitable for any purpose of any user, or that implementation of such contents will not infringe any third party patents, copyrights, trademarks or other rights. By making use of this document, the user assumes all risks and waives all claims against Presenters.

In no event shall Presenters be liable to user (or other person) for direct, indirect, special or consequential damages arising from or related to any use of this document, including, without limitation, lost profits, business interruption, loss of programs, or other data on your information handling system even if Presenters are expressly advised of the possibility of such damages.

---

### Use of Documents in papiNet Implementations

Documents may be used as templates for a papiNet implementation. The Presenters grant the right to modify and edit them to fit an actual

---

## **Business Acknowledgement papiNet Standard - Version 2.31**

---

---

implementation project provided all copies display the copyright and any other proprietary notices contained in this document. Such modified documents must not be distributed beyond the trading partners implementing or maintaining a papiNet connection.

---

### **Additional Copyright Information**

Additional copyrights may be referenced throughout this document in the appropriate section.

# Business Acknowledgement papiNet Standard - Version 2.31

---

---

## Table of Contents

|  |    |
|--|----|
| Copyright.....   | 2  |
| Use of Documents in papiNet Implementations.....       | 2  |
| Additional Copyright Information.....                  | 3  |
| Table of Contents.....                                 | 4  |
| Business Acknowledgement Documentation.....            | 5  |
| An Overview of the Business Acknowledgement.....       | 5  |
| The Scope of the Business Acknowledgement Message..... | 5  |
| Business Rules for Business Acknowledgement.....       | 5  |
| Processing Business Acknowledgement.....               | 5  |
| Business Acknowledgement Structure.....                | 7  |
| Understanding the Diagrams and Content.....            | 8  |
| Business Acknowledgement Root Element.....             | 10 |
| BusinessAcknowledgement.....                           | 10 |
| Primary Elements.....                                  | 12 |
| BusinessAcknowledgementNumber.....                     | 12 |
| BusinessAcknowledgementDate.....                       | 12 |
| Document.....  | 13 |
| TransactionHistoryNumber.....                          | 20 |
| Error.....   | 20 |
| SenderParty.....                                       | 22 |
| ReceiverParty.....                                     | 28 |

# Business Acknowledgement papiNet Standard - Version 2.31

---

---

## Business Acknowledgement Documentation

---

### An Overview of the Business Acknowledgement

The message receiver uses the Business Acknowledgement message to notify the message sender how a message was processed in the receiver's ERP system. It can be used to acknowledge any papiNet message. Although the message is optional between two trading partners, its use is strongly recommended since it provides positive verification of the end result of an electronic exchange.

If the Business Acknowledgement message is used, the sender of the original message should have in place an error resolution process. This process should monitor errors received via the Business Acknowledgement, routing them to the correct organisation for resolution. The monitoring process may also check for unacknowledged messages to increase the verification that all sent messages have been processed.

---

### The Scope of the Business Acknowledgement Message

The Business Acknowledgement message includes:

- BusinessAcknowledgementNumber
- BusinessAcknowledgementDate
- Information on the Document acknowledged including DocumentName, DocumentNumber and DocumentDate
- If applicable, information on Errors found in processing the message
- Contact information for error resolution

---

### Business Rules for Business Acknowledgement

#### General Business Acknowledgement Business Rules

| Identifier | Business Rule   |
|------------|---|
| BA_001     | A Business Acknowledgement confirms the success or failure of a single document.                    |
| BA_002     | If the sent document failed, errors are required to describe what was wrong with the sent document. |

---

### Processing Business Acknowledgement

The message can be sent with one of two values in the Status attribute.

#### Status Values Used When Processing Business Acknowledgement

- Success, Indicates that the electronic transaction successfully processed in the receiver ERP system.
- Failure, Indicates that the electronic transaction failed to process in the receiver ERP system.

## **Business Acknowledgement papiNet Standard - Version 2.31**

---

---

- Per business rule BA002, when there is a failure, error(s) describe why the message failed.

# Business Acknowledgement papiNet Standard - Version 2.31

## Business Acknowledgement Structure

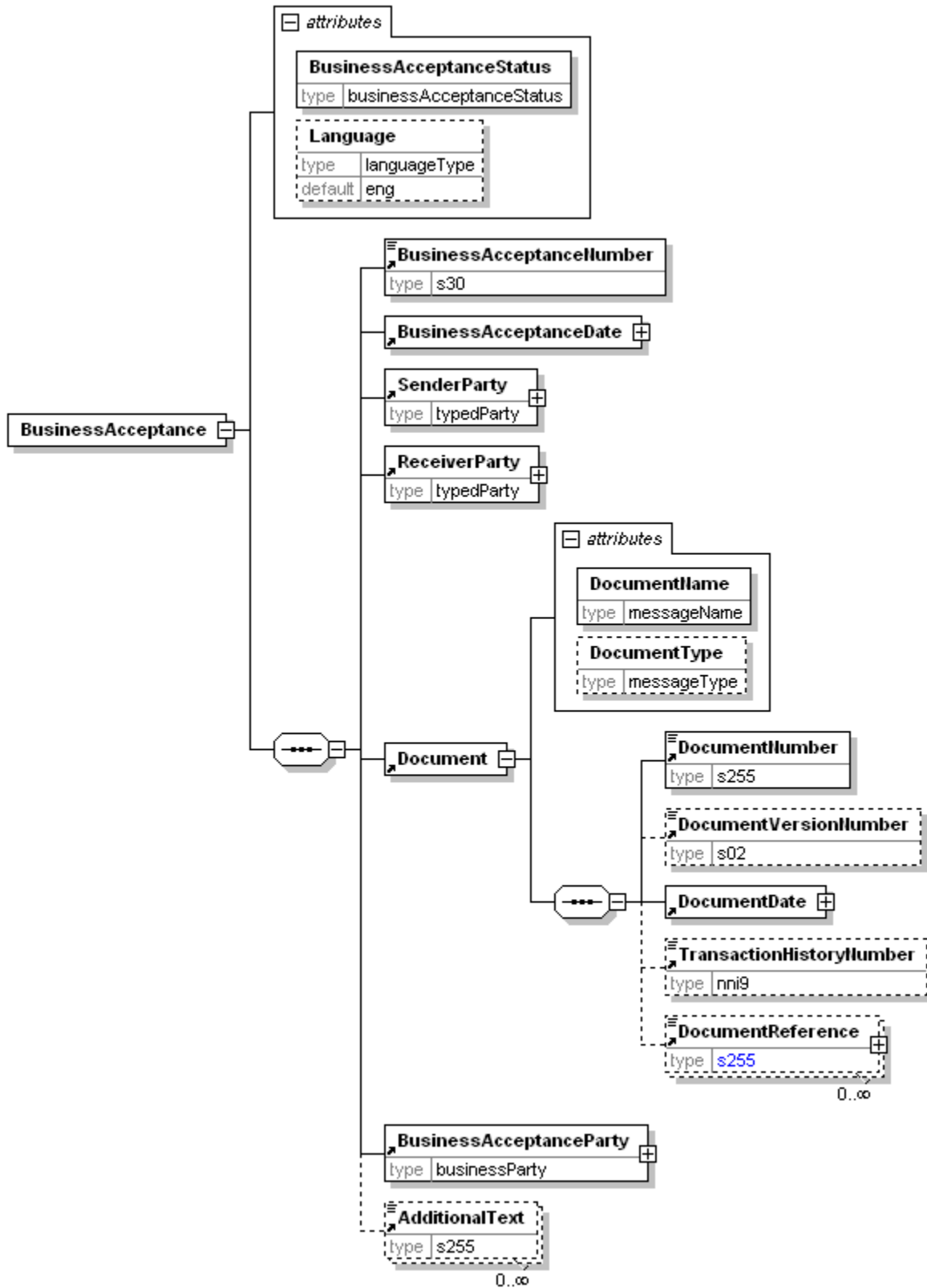

# Business Acknowledgement

## papiNet Standard - Version 2.31

---

---

### Understanding the Diagrams and Content

This section provides a graphical view of the schema structures, a discussion of the item's children. You can find additional information about papiNet and the standard at [www.papiNet.org](http://www.papiNet.org).

The graphics contain content model indicators, cardinality indicators, and data type information.

Associated with each graphic are the definitions for the parent item and any associated child items. All attributes are listed first, followed by the elements.

The following information should help you interpret and understand this standard. Please note the following:

- Content Model and Cardinality operate together to determine if the element or attribute are required in the instance document.
- The same attribute can never appear multiple times in the same element so, you will never see a multiple cardinality indicator.

#### Content model indicators:

There are three possible types of content: "sequence", "choice", and "all". The papiNet standard currently does not use the "all" construct.

- (sequence)  
The sequence of the items to the right of the graphic (or below the text) is required.
- (choice)  
A choice of the items to the right of the graphic (or below the text) is permitted.
- (all)  
All the items to the right of the graphic are required.

#### Cardinality indicators:

- Dotted line around element or attribute.  
A single instance of the item can optionally exist.
- Dotted line around item with range indicated below.  
Multiple instances of the item can optionally exist.
- Solid line around item.  
A single instance of the item must exist.
- Solid line around item with range indicated below  
At least one instance must exist; multiple instances can optionally exist.

#### Datatype indication:

When a data type is assigned to an element (either a simple type or complex type the name of the data type is presented beneath the item name in the graphic.

- In some cases additional information about the data type is presented (the default value).



## **Business Acknowledgement papiNet Standard - Version 2.31**

---

---

Elements can either have content that is textual/numeric in nature or content that is made up of additional elements and/or attributes.

- When the content is textual/numeric in nature “three straight horizontal lines” will appear in the upper left-hand corner of the graphic. Pay attention to these elements because they are where you will be entering your information.
- When the content is made up of additional elements and/or attributes a “gray-box” will appear on the right-hand side of the graphic.
- If the graphic shows both the horizontal lines and the gray-box then, in the papiNet standard, the content below the element are attributes.

# Business Acknowledgement papiNet Standard - Version 2.31

## Business Acknowledgement Root Element

### BusinessAcknowledgement

The root element of the BusinessAcknowledgement.

#### Status [attribute]

*Status is mandatory. A single instance is required.*

Defines whether or not the electronic transaction successfully

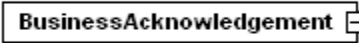

processed in the receiver ERP system.

Refer to Status definition for any enumerations.

#### Language [attribute]

*Language is optional. A single instance might exist.*

XML has embraced 2 and 3 digit language codes through the application of an addendum to the standard.

Refer to Language definition for any enumerations.

#### (sequence)

*The sequence of items below is mandatory. A single instance is required.*

#### BusinessAcknowledgementNumber

*BusinessAcknowledgementNumber is mandatory. A single instance is required.*

The unique identifier for the BusinessAcknowledgement.

#### BusinessAcknowledgementDate

*BusinessAcknowledgementDate is mandatory. A single instance is required.*

The Date and Time when the BusinessAcknowledgement was issued.

#### Document

*Document is mandatory. A single instance is required.*

A group item containing information applicable to the original document.

#### TransactionHistoryNumber

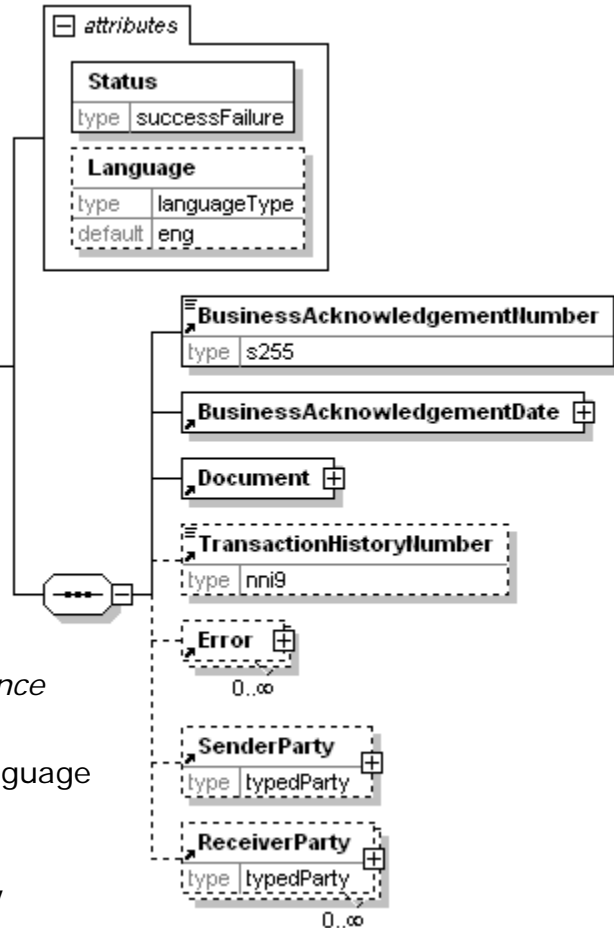

# Business Acknowledgement

## papiNet Standard - Version 2.31

---

---

*TransactionHistoryNumber is optional. A single instance might exist.*

A sequential number that keeps track of the version of a document being sent by the document originator except in the case where TransactionHistoryConfirmation is used, in which case the TransactionHistoryNumber refers to the trigger transaction for which the confirmation is being sent.

### **Error**

*Error is optional. Multiple instances might exist.*

A group item that details the errors that are delaying processing on an original document.

### **SenderParty**

*SenderParty is optional. A single instance might exist.*

The business entity issuing the business document, the source of the document.

- The entity responsible for the content. If the sender party has out sourced the message service to a third party the SenderParty is the issuer of the e-document and not the party performing the transmission service of the electronic message.

### **ReceiverParty**

*ReceiverParty is optional. Multiple instances might exist.*

The business entity for whom the business document is intended, the destination of the document.

- The entity interested in the content. If the receiver party has outsourced the message service to a third party the ReceiverParty is the intended party for the e-document and not the party performing the receiving service of the electronic message.

# Business Acknowledgement papiNet Standard - Version 2.31

## Primary Elements

### BusinessAcknowledgementNumber

The unique identifier for the BusinessAcknowledgement.

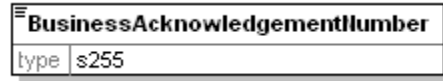

### BusinessAcknowledgementDate

The Date and Time when the BusinessAcknowledgement was issued.

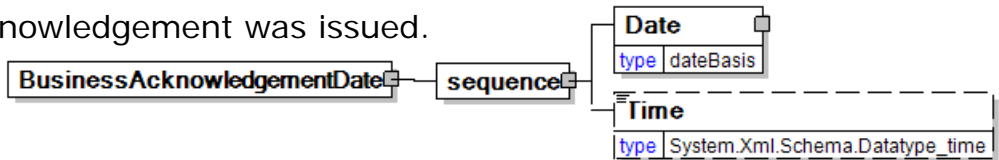

#### (sequence)

*The contents of (sequence) are mandatory. A single instance is required.*

#### Date

*Date is mandatory. A single instance is required.*

A group element that contains the specification of Year, Month, and Day.

#### Time

*Time is optional. A single instance might exist.*

Times are treated in a standard XML fashion with a special case used to indicate a generalized "local" time. The standard XML approach to time is hh:mm:ss, hh:mm:ssZ, or hh:mm:ss±hh:mm.

- hh:mm:ss±hh:mm is used to represent a time with a time zone. The time zone is communicated as the number of hours offset from the Universal Time Coordinate (UTC), a.k.a. Greenwich Mean Time.
- hh:mm:ssZ indicates the time at Zulu (another name for UTC). Based on the convention described in the next bullet it will be important for users within UTC to use "Z" when communicating a time in their time zone to other users.
- hh:mm:ss or hh:mm indicates in the XML standard the time at UTC however, within papiNet it is used to represent the applicable local time. Caution should be used when processing times of this nature as the papiNet approach may be in discord with other users of XML.

# Business Acknowledgement papiNet Standard - Version 2.31

## Document

A group item containing information applicable to the original document.

### DocumentName [attribute]

*DocumentName is mandatory. A single instance is required.*

Defines the document name for documents defined by papiNet.

*This item is restricted to the following list.*

**Availability**

**BookSpecification**

**BusinessAcceptance**

**BusinessAcknowledgement**

**Calendar**

**CallOff**

**CallOffWood**

**Complaint**

**ComplaintResponse**

**CreditDebitNote**

**DeliveryInstruction**

**DeliveryMessage**

**DeliveryMessageBook**

**DeliveryMessageWood**

**GoodsReceipt**

**InfoRequest**

**InventoryChange**

**InventoryDispositionInstructions**

**InventoryStatus**

**Invoice**

**InvoiceWood**

**LoadAvailable**

**LoadTender**

**LoadTenderResponse**

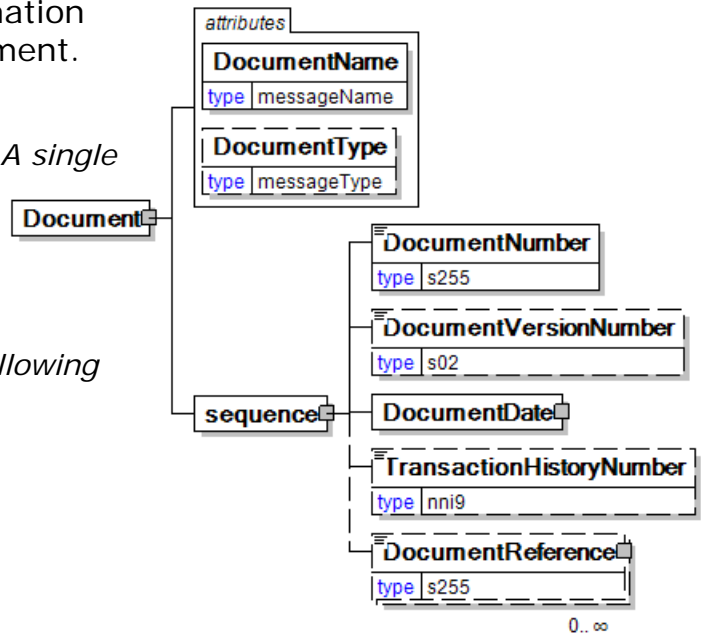

# Business Acknowledgement

## papiNet Standard - Version 2.31

---

---

MeasuringTicket  
OrderConfirmation  
OrderConfirmationWood  
OrderStatus  
PackingList  
Planning  
ProductAttributes  
ProductPerformance  
ProductQuality  
PurchaseOrder  
PurchaseOrderWood  
RFQ  
RFQResponse  
ScaleTicket  
ShipmentStatus  
ShippingInstructions  
Statement  
Usage  
Other

### **DocumentType [attribute]**

*DocumentType is optional. A single instance might exist.*

The type of e-business document being communicated.

*This item is restricted to the following list.*

#### **Agreement**

A legally binding exchange of promises between parties that the law will enforce.

#### **Approximate**

An invoice that is created to record ownership transfer without the material physically being moved. Typically what occurs is that the buyer has agreed to take ownership of the item at a certain point in time but has not arranged for transportation. Approximate invoices are invoices that are claiming payment.

#### **AvailabilityStatus**

#### **BlanketOrder**

An order that communicates the same information as a StandardOrder but also indicates that the order may be completed over a period of time or, until a certain volume is achieved or, until a certain currency amount is spent.

#### **Booking**

# Business Acknowledgement

## papiNet Standard - Version 2.31

---

---

An indication that time for a service is required. For example a booking that is part of a detail transport plan.

### **BookingConfirmation**

A communication affirming the placement of the booking with a particular party.

### **CalibrationCheckLog**

A MeasuringTicketType that contains a check log with information about calibration of measuring equipment.

### **CallOff**

Defines a call-off sent by the buyer to the seller.

### **CallOffConfirmation**

Defines a call-off confirmation sent in response to a call-off.

### **Claim**

A "Claim" type is used when there is a customer reaction that includes a financial compensation.

### **Complaint**

### **ConfirmingOrder**

A confirming order is used to electronically confirm an order that has not been placed electronically by the customer that is, it was placed using another mean such as fax, phone or email.

### **ConsumptionOrder**

A purchase order that is based upon consumption for a particular period of time or instance.

### **CreditNote**

Credits which are provided to the receiving party for amount reductions.

### **DebitNote**

Debits which are charged to the receiving party for additional charges.

### **DeliveryInstruction**

A Delivery Instruction can specify many delivery events. Each event can contain quantity for one or many loads. A sequence in a Delivery Instruction specifies all details for one event. The receiver of a Delivery Instruction can generate many Loading Instructions from one Delivery Instruction.

### **DeliveryMessage**

A delivery message type that contains optional routing information, quantities at the DeliveryMessageLineItem level, and details at the DeliveryMessageLineItemDetail level. The seller uses a DeliveryMessage to provide delivery details to the ship-to party and tracking information.

### **Duplicate**

To be removed in a future version. When an invoice is reissued as a duplicate the invoice type should be the same as on the original invoice. Use attribute Reissued

# Business Acknowledgement

## papiNet Standard - Version 2.31

---

---

= Yes to indicate a duplicate.

### **Feedback**

A "Feedback" type is used when there is a customer reaction that doesn't include any financial compensation.

### **InitialShipmentAdvice**

A delivery message type that contains detailed routing information, quantities at the DeliveryMessageLineItem level and optionally details at the DeliveryMessageLineItemDetail level. The seller uses the InitialShipmentAdvice to provide preliminary notification of shipment routing and quantities (can be used as an advanced notice of delivery). The quantities indicated may not necessarily be delivered—for example, if there is damage in transit or the delivery is rerouted to another destination.

### **InventoryChange**

### **InventoryStatus**

### **Invoice**

A regular invoice (referred to as an invoice) is a message claiming payment for goods supplied under conditions agreed to between seller and buyer. The invoice communicates, among other things, payment terms, payment method, and the payment amount required for one or more deliveries.

### **InvoiceSpecification**

A MeasuringTicketType that contains information about measured products including prices and amounts. This MeasuringTicketType is normally used as a detailed specification of billable or invoiced products.

### **LoadAvailable**

### **LoadAvailableConfirmation**

### **LoadedSpecification**

A Delivery Message type that contains a specification of loaded goods on a transport unit (e.g. container, rail wagon). A loading specification (LoadedSpecification) can contain goods belonging to many suppliers and buyers and is normally referring to a Loading Instruction.

### **LoadingInstruction**

A Loading Instruction specifies loading of transport units. A Forwarder receiving a Delivery Instruction from a supplier can convert it into many Loading Instructions, which are sent to a Warehouse Operator. A sequence in a Loading Instruction specifies all details how to load one transport unit. A Loading Instruction can include goods from many Delivery Instructions and also goods belonging to many suppliers.

### **LoadingOrder**

Specifies delivery schedule, the transport booking requirements and shipping instructions, as well as the internal work order for the shipment

### **LoadingSchedule**

The schedule for transport vehicle loading.



# Business Acknowledgement

## papiNet Standard - Version 2.31

---

---

### **LoadTender**

More than one carrier has been informed about the upcoming transport requirement (the load).

### **LoadTenderResponse**

Indicates the ability of the respondent to fulfill the load tender request.

### **MeasuringTicket**

A MeasuringTicketType that contains detailed information about measured products and items. This information can be used as a base for calculation of billable products.

### **OfficeSchedule**

The schedule for office personnel.

### **OrderStatus**

### **PackingSpecification**

A Packing Specification is a business transaction specifying the complete consignment being shipped from a consignor to a consignee. The specification describes in detail what is being shipped and how it is packed and marked.

### **PreBooking**

A requirement for a transport vehicle or unit reservation that has risen from a rough transport plan.

### **PreBookingConfirmation**

A communication of the requirement for a transport vehicle or unit reservation that has risen from a rough transport plan.

### **PrePayment**

A prepayment invoice is used as a notification of amounts to be paid in advance. It is not a legal invoice claiming payment for provided products or services.

### **PriceList**

Used when sending a pricelist

### **ProductCrossReference**

Used in the exchange of ProductIdentifier cross-references for the product codes used by two trading partners

### **ProductionTicket**

A MeasuringTicketType that contains information about produced products and items. A ProductionTicket can also contain measuring information for produced items.

### **ProductProperties**

Used when sending a list of ProductAttributes

### **ProForma**

A pro-forma invoice is not a legal invoice claiming payment. A pro-forma invoice is a document/message serving as a preliminary invoice, containing on the whole the

# Business Acknowledgement

## papiNet Standard - Version 2.31

---

---

same information as the final invoice, but not actually claiming payment. Pro-forma invoices are typically used in a cross-border shipment for customs purposes. Can travel with the product or be sent to a broker.

### **ReleaseOrder**

A release order is used to release a product to be made. This type of order refers to a previous order or agreement, such as a reservation order, a contract, or a blanket order. A release number version which is an incremented number, is used in this type.

### **ReservationOrder**

A reservation order is used to book a paper supplier's capacity for specific quantities of specific products, but it is not yet a firm commitment to buy. Consequently, all line items of a reservation order have a ProductionStatusType of NotFree. To release one or more purchase order line items of a reservation order, a buyer can use a standard order or a release order.

### **SampleMeasuringTicket**

A MeasuringTicketType that contains detailed information about measured samples taken from e.g. a delivery.

### **SelfBillingStatement**

A SelfBillingStatement is an invoice that is prepared by the buyer of the product (or the consumer of the service) for the provider of the product or service. The preparer will pay the invoice.

Typically logistics costs charges are the service that are communicated. They are incurred during a certain period of time between the party who provides the logistics services (typically the party with a LogisticsRole of "LogisticsProvider") and the requestor of such services (typically the party with a LogisticsRole of "Consignor").

Raw materials, maintenance, repair, and operating supplies are examples of products that can be entered on a self billing statement for products. This type of invoice is also referred to as an invoice for "evaluated receipts" because it developed from the receiving department's evaluation of their receipts and from that creating the invoice.

The SelfBillingStatement process exists when there is a great deal of trust between the trading partners that permits this cost savings business process.

### **ShipmentAdvice**

A Delivery Message type that contains a specification of goods, that are dispatched and will be delivered to a warehouse. A ShipmentAdvice can refer to a Delivery Instruction Sequence or a CallOff, but is normally also used for notifying a receiving warehouse operator of shipments to the warehouse.

### **ShippingInstructionsConfirmation**

Sent by the seller party in response to a ShippingInstructions message, to confirm the delivery schedule and product quantities.

- Sent by the seller party in response to a ShippingInstructions message, to confirm the delivery schedule and product quantities. This response is not mandatory.

# Business Acknowledgement

## papiNet Standard - Version 2.31

---

---

### **ShippingInstructionsPackaging**

Sent by the buyer party to specify packing information for the product(s) for example, quantities per carton and pallet type.

### **ShippingInstructionsRouting**

Sent by the buyer party (such as the customer or publisher) to specify delivery schedule(s), transportation information, and quantities for the product(s) in the purchase order.

### **SpecOrder**

Used when the BookSpecification message is intended for use with the Purchase Order transaction.

### **StandardOrder**

A standard order is a regular one-time order. It defines quantities for one or more products to be purchased and may also define a delivery location and date. A standard order may reference a previous agreement (for example, a quotation, a contract, or a reservation order) for information.

### **SpecRFQ**

Used when the BookSpecification message is intended for use with the Request for Quote (Estimate) transaction.

### **StandardRFQ**

### **SupplierSpec**

Will be removed in a future version. Recommended not to be used.  
(Used when the BookSpecification message is intended for use by the Supplier only and is not generated by, or transmitted to the Buyer)

### **SupportSchedule**

The support schedule for transport operations.

### **ThirdPartyShipmentAdvice**

Notification of a shipment from a warehouse to a party other than the party that ordered the product from the supplier.

### **TrialOrder**

A trial order is used whenever a seller has agreed to have a buyer sample a product. The seller needs to process this order differently from other orders, because a trial order may include a product sold at a discounted rate or even provided for free. A trial order typically is for small quantities.

### **UnloadingSchedule**

The schedule for transport vehicle unloading.

### **Waybill**

The forwarding agreement or carrying agreement between shipper and air carrier that is used as a receipt for cargo and as a contract of carriage.

### **(sequence)**

*The contents of (sequence) are mandatory. A single instance is required.*

# Business Acknowledgement papiNet Standard - Version 2.31

---

## DocumentNumber

*DocumentNumber is mandatory. A single instance is required.*

The unique identifier of the original document.

## DocumentVersionNumber

*DocumentVersionNumber is optional. A single instance might exist.*

The document version number, currently BookSpecification is the only message that has a Version Number.

## DocumentDate

*DocumentDate is mandatory. A single instance is required.*

The Date and optionally Time when the document that is referred to was issued.

## TransactionHistoryNumber

*TransactionHistoryNumber is optional. A single instance might exist.*

A sequential number that keeps track of the version of a document being sent by the document originator except in the case where TransactionHistoryConfirmation is used, in which case the TransactionHistoryNumber refers to the trigger transaction for which the confirmation is being sent.

## DocumentReference

*DocumentReference is optional. Multiple instances might exist.*

An element detailing relevant references pertaining to the papiNet business document, as indicated by the DocumentReferenceType and AssignedBy.

---

## TransactionHistoryNumber

A sequential number that keeps track of the version of a document being sent by the document originator except in the case where

TransactionHistoryConfirmation is used, in which case the TransactionHistoryNumber refers to the trigger transaction for which the confirmation is being sent.

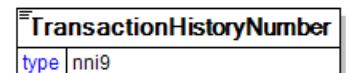

---

## Error

A group item that details the errors that are delaying processing on an original document.

### (sequence)

*The contents of (sequence) are mandatory. A single instance is required.*

### ErrorCode

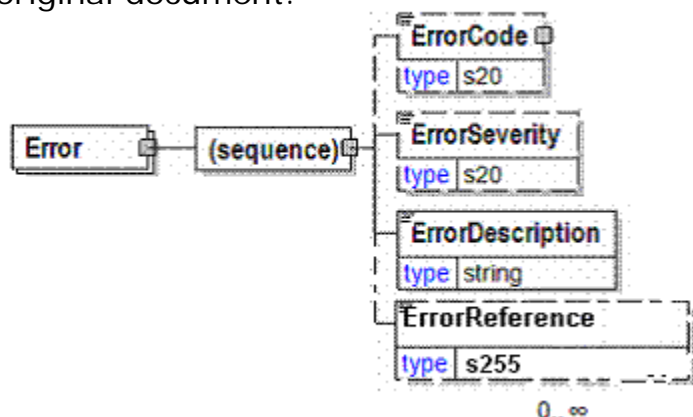

# Business Acknowledgement

## papiNet Standard - Version 2.31

---

---

*ErrorCode is optional. A single instance might exist.*

An optional code used to describe why an original document could not be processed

### **ErrorSeverity**

*ErrorSeverity is optional. A single instance might exist.*

An optional indicator as to whether an error is business content related or whether it is technical in nature. Use of this item is governed by a Trading Partner agreement.

### **ErrorDescription**

*ErrorDescription is mandatory. A single instance is required.*

A textual description of why an original document could not be processed.

### **ErrorReference**

*ErrorReference is optional. Multiple instances might exist.*

An item detailing relevant references (such as a Purchase Order Line Item) pertaining to the error. The type of reference is identified by the ErrorReferenceType attribute

# Business Acknowledgement papiNet Standard - Version 2.31

## SenderParty

The business entity issuing the business document, the source of the document.

- This is the same entity as the "From" party in the ebXML message service envelope. The entity responsible for the content. If the sender party has out sourced the transmission function to a third party the sender party is the original party not the party performing the transmission service.

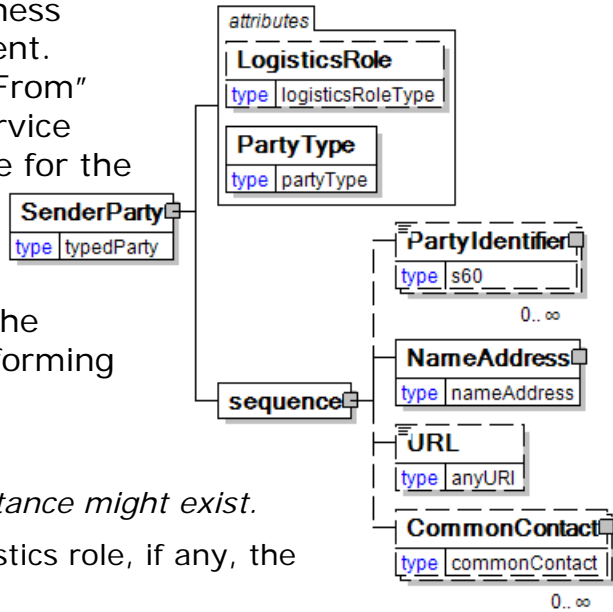

### LogisticsRole [attribute]

*LogisticsRole is optional. A single instance might exist.*

Communicates the nature of the logistics role, if any, the party plays in the transaction.

*This item is restricted to the following list.*

#### Consignee

The party to whom the goods are turned over to.

#### Consignor

The party who is responsible for the goods prior to the shipping process.

#### LogisticsProvider

The party who, by contract with the consignor, takes care of the requested logistics service (transport or others).

### PartyType [attribute]

*PartyType is mandatory. A single instance is required.*

Identifies the business role associated with the particular party

*This item is restricted to the following list.*

#### Auditor

A third party that is authorized for making audits and checkings.

#### Bank

The banking representative.

#### BillTo

The address where the invoice is to be sent.

#### BorderCrossing

A geographic location separating two countries authorised to validate customs documentation.

# Business Acknowledgement

## papiNet Standard - Version 2.31

---

---

### **Broker**

The organisation acting as a broker for the buyer or supplier.

### **Buyer**

The legal entity to which the product is sold. Also commonly referred to as the sold-to party or customer. If no OtherParty is defined as the "Payer", the "Buyer" is the "Payer".

### **BuyerAgent**

The entity acting for the buyer in the transaction.

### **Carrier**

The organisation or business entity that transports goods.

### **CarrierAssignmentResponsible**

The organisation to which the carrier has assigned some task.

### **ComponentVendor**

Vendor producing supplied components.

### **Consignee**

To be deprecated in version 3.0 (no date determined). Use LogisticsRole attribute to communicate this information.

### **Consignor**

To be deprecated in version 3.0 (no date determined). Use LogisticsRole attribute to communicate this information.

### **Consuming**

The eventual consumer of the material

### **Converter**

The organisation responsible for changing one form of paper into another form, providing specialised functions not available to the supplier.

### **CreditDepartment**

The party responsible for credit authorization.

### **CrossDock**

A third party involved in the transport of goods.

### **CustomerFacility**

The type of the origin or destination location of a transport leg in a route is a buyer facility, usually a print site, or a warehouse owned by the buyer.

### **CustomerStock**

A "virtual" location that indicates that the material is owned by the customer.

### **CustomsForwarder**

A forwarder responsible for managing the transfer of goods through customs.

### **DomesticForwarder**

# Business Acknowledgement

## papiNet Standard - Version 2.31

---

---

A forwarder responsible for managing the transfer of goods.

### **EndUser**

EndUser is the party using, consuming, or converting the product. For example, a printer using paper reels to print a job for a publisher (printer is the end user). The final ShipTo destination for a product is normally to the EndUser facilities.

### **ExportForwarder**

A forwarder responsible for managing the export process.

### **ForestForwarder**

The party responsible for transporting forest wood products from logging areas to roadside landings.

### **ForestHarvester**

The party responsible for harvesting of forest wood products at logging areas.

### **Forwarder**

The party responsible for shipping arrangements.

### **FreightPayer**

The party responsible for paying freight.

### **Insurer**

The party providing insurance coverage for the goods.

### **Landowner**

The party who owns the land upon which the product was produced.

### **LoadingOperator**

A party that is carrying out loading of transport units.

### **LoggingArea**

A geographic location in the forest where logging takes place.

### **MainCarrier**

The primary carrier involved in the movement of goods.

### **Measurer**

The party that's carrying out the measurement of the products quantity and/or quality. The party is doing this for example on behalf of both the buyer and seller and the result can be used as basis for invoicing.

### **Merchant**

A third party buying and reselling products.

### **Mill**

A production facility.

### **NotifyParty**

A party that needs to be notified of the status of the transaction.



# Business Acknowledgement

## papiNet Standard - Version 2.31

---

---

### **OnBehalfOf**

The activity in question is being made on behalf of this party.

### **OrderParty**

The organisation or business entity placing the order if different from the buyer party.

### **OriginalSupplier**

The first supplier in a supply chain. OriginalSupplier is only intended to identify the business party, not the origin of the product.

### **Payee**

The party handling and receiving payments on behalf of another party.

### **Payer**

The party handling and sending payments of behalf of another party.

### **PlaceFinalDestination**

The final destination of the goods.

### **PlaceOfAccept**

The location where acceptance of the goods is to take place.

### **PlaceOfDespatch**

The location where despatch took place.

### **PlaceOfDischarge**

The location where the goods were unloaded.

### **PlaceOfLoading**

The location where loading is to or took place.

### **PlaceOfReloading**

A location where the goods where transferred from one transport type to another.

### **Port**

The type of the origin or destination location of a transport leg in a route. It is a maritime location.

### **PreCarrier**

The party responsible for activities prior to carrier accepting the goods (but after shipping has taken place).

### **PrinterFacility**

The location of the printer who will be using the product.

### **ProFormalInvoice**

The organisation or business entity to which the pro-forma invoice will be sent.

### **Producer**

The manufacturer of the goods.

# Business Acknowledgement

## papiNet Standard - Version 2.31

---

---

### **RemitTo**

The organisation or business entity to which payment will be made.

### **Requestor**

The originator of the original purchase order requisition (for example, a printing plant ordering through a central purchasing organisation).

### **RoadKeeper**

The party who is responsible for the maintenance of the road.

### **RoadOwner**

The party who is the legal owner of the road.

### **SalesAgent**

The organisation or person responsible for product sales acting on behalf of the seller.

### **SalesOffice**

The functional unit in an organisation or business entity that is responsible for product sales.

### **Seller**

The seller of the product. SupplierParty is the seller of the product, if Seller is not specified as OtherParty = Seller.

### **ShipFromLocation**

The location the goods were shipped from.

### **ShipOwner**

The owner of the vessel used to ship the goods.

### **ShipTo**

The address the material should be shipped to.

### **SubCarrier**

A sub carrier of another the shipping company.

### **Supplier**

The organisation or business entity responsible for providing the product. SupplierParty is also the seller of the product, if Seller is not specified as OtherParty = Seller.

### **Terminal**

The type of the origin or destination location of a transport leg in a route. It can be a sea, road or rail terminal.

### **TerminalOperator**

The party providing facilities such as loading, unloading, or warehousing.

### **UnloadingOperator**

A party that is carrying out unloading of transport units.

# Business Acknowledgement

## papiNet Standard - Version 2.31

---

---

### **Warehouse**

A storage location. It can be the origin or destination location of a transport leg in a route.

### **WillAdvise**

Indicates that party will be identified at a later time

### **Other**

Any other organisation or business entity that may get involved in the transaction and that is not covered by the list.

### **(sequence)**

*The contents of (sequence) are mandatory. A single instance is required.*

### **PartyIdentifier**

*PartyIdentifier is optional. Multiple instances might exist.*

A unique identifier of a specific party. This element contains an attribute PartyIdentifierType that indicates the type of party.

### **NameAddress**

*NameAddress is mandatory. A single instance is required.*

A group item containing name and address of an organisation or business entity.

### **URL**

*URL is optional. A single instance might exist.*

Universal Resource Locator. While typically a web address you could use this field to hold an email address.

### **CommonContact**

*CommonContact is optional. Multiple instances might exist.*

Identifies a specific individual associated with the party.

# Business Acknowledgement papiNet Standard - Version 2.31

## ReceiverParty

The business entity for whom the business document is intended, the destination of the document.

- This is the same entity as the “To” party in the ebXML message service envelop. The entity interested in the content. If the receiver party has outsourced the message receipt function to a third party the receiver party is the intended party not the party performing the receiving process.

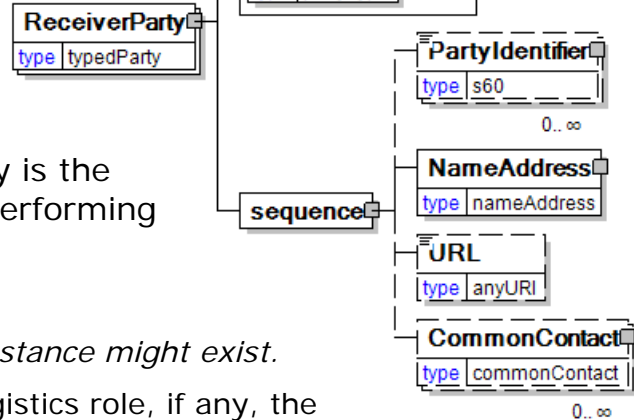

### LogisticsRole [attribute]

*LogisticsRole is optional. A single instance might exist.*

Communicates the nature of the logistics role, if any, the party plays in the transaction.

*This item is restricted to the following list.*

#### Consignee

The party to whom the goods are turned over to.

#### Consignor

The party who is responsible for the goods prior to the shipping process.

#### LogisticsProvider

The party who, by contract with the consignor, takes care of the requested logistics service (transport or others).

### PartyType [attribute]

*PartyType is mandatory. A single instance is required.*

Identifies the business role associated with the particular party

*This item is restricted to the following list.*

#### Auditor

A third party that is authorized for making audits and checkings.

#### Bank

The banking representative.

#### BillTo

The address where the invoice is to be sent.

#### BorderCrossing

A geographic location separating two countries authorised to validate customs

# Business Acknowledgement

## papiNet Standard - Version 2.31

---

---

documentation.

### **Broker**

The organisation acting as a broker for the buyer or supplier.

### **Buyer**

The legal entity to which the product is sold. Also commonly referred to as the sold-to party or customer. If no OtherParty is defined as the "Payer", the "Buyer" is the "Payer".

### **BuyerAgent**

The entity acting for the buyer in the transaction.

### **Carrier**

The organisation or business entity that transports goods.

### **CarrierAssignmentResponsible**

The organisation to which the carrier has assigned some task.

### **ComponentVendor**

Vendor producing supplied components.

### **Consignee**

To be deprecated in version 3.0 (no date determined). Use LogisticsRole attribute to communicate this information.

### **Consignor**

To be deprecated in version 3.0 (no date determined). Use LogisticsRole attribute to communicate this information.

### **Consuming**

The eventual consumer of the material

### **Converter**

The organisation responsible for changing one form of paper into another form, providing specialised functions not available to the supplier.

### **CreditDepartment**

The party responsible for credit authorization.

### **CrossDock**

A third party involved in the transport of goods.

### **CustomerFacility**

The type of the origin or destination location of a transport leg in a route is a buyer facility, usually a print site, or a warehouse owned by the buyer.

### **CustomerStock**

A "virtual" location that indicates that the material is owned by the customer.

### **CustomsForwarder**

A forwarder responsible for managing the transfer of goods through customs.

# Business Acknowledgement

## papiNet Standard - Version 2.31

---

---

### **DomesticForwarder**

A forwarder responsible for managing the transfer of goods.

### **EndUser**

EndUser is the party using, consuming, or converting the product. For example, a printer using paper reels to print a job for a publisher (printer is the end user). The final ShipTo destination for a product is normally to the EndUser facilities.

### **ExportForwarder**

A forwarder responsible for managing the export process.

### **ForestForwarder**

The party responsible for transporting forest wood products from logging areas to roadside landings.

### **ForestHarvester**

The party responsible for harvesting of forest wood products at logging areas.

### **Forwarder**

The party responsible for shipping arrangements.

### **FreightPayer**

The party responsible for paying freight.

### **Insurer**

The party providing insurance coverage for the goods.

### **Landowner**

The party who owns the land upon which the product was produced.

### **LoadingOperator**

A party that is carrying out loading of transport units.

### **LoggingArea**

A geographic location in the forest where logging takes place.

### **MainCarrier**

The primary carrier involved in the movement of goods.

### **Measurer**

The party that's carrying out the measurement of the products quantity and/or quality. The party is doing this for example on behalf of both the buyer and seller and the result can be used as basis for invoicing.

### **Merchant**

A third party buying and reselling products.

### **Mill**

A production facility.

### **NotifyParty**

# Business Acknowledgement

## papiNet Standard - Version 2.31

---

---

A party that needs to be notified of the status of the transaction.

### **OnBehalfOf**

The activity in question is being made on behalf of this party.

### **OrderParty**

The organisation or business entity placing the order if different from the buyer party.

### **OriginalSupplier**

The first supplier in a supply chain. OriginalSupplier is only intended to identify the business party, not the origin of the product.

### **Payee**

The party handling and receiving payments on behalf of another party.

### **Payer**

The party handling and sending payments of behalf of another party.

### **PlaceFinalDestination**

The final destination of the goods.

### **PlaceOfAccept**

The location where acceptance of the goods is to take place.

### **PlaceOfDespatch**

The location where despatch took place.

### **PlaceOfDischarge**

The location where the goods were unloaded.

### **PlaceOfLoading**

The location where loading is to or took place.

### **PlaceOfReloading**

A location where the goods where transferred from one transport type to another.

### **Port**

The type of the origin or destination location of a transport leg in a route. It is a maritime location.

### **PreCarrier**

The party responsible for activities prior to carrier accepting the goods (but after shipping has taken place).

### **PrinterFacility**

The location of the printer who will be using the product.

### **ProFormalInvoice**

The organisation or business entity to which the pro-forma invoice will be sent.

### **Producer**

# Business Acknowledgement

## papiNet Standard - Version 2.31

---

---

The manufacturer of the goods.

### **RemitTo**

The organisation or business entity to which payment will be made.

### **Requestor**

The originator of the original purchase order requisition (for example, a printing plant ordering through a central purchasing organisation).

### **RoadKeeper**

The party who is responsible for the maintenance of the road.

### **RoadOwner**

The party who is the legal owner of the road.

### **SalesAgent**

The organisation or person responsible for product sales acting on behalf of the seller.

### **SalesOffice**

The functional unit in an organisation or business entity that is responsible for product sales.

### **Seller**

The seller of the product. SupplierParty is the seller of the product, if Seller is not specified as OtherParty = Seller.

### **ShipFromLocation**

The location the goods were shipped from.

### **ShipOwner**

The owner of the vessel used to ship the goods.

### **ShipTo**

The address the material should be shipped to.

### **SubCarrier**

A sub carrier of another the shipping company.

### **Supplier**

The organisation or business entity responsible for providing the product. SupplierParty is also the seller of the product, if Seller is not specified as OtherParty = Seller.

### **Terminal**

The type of the origin or destination location of a transport leg in a route. It can be a sea, road or rail terminal.

### **TerminalOperator**

The party providing facilities such as loading, unloading, or warehousing.

### **UnloadingOperator**



# Business Acknowledgement

## papiNet Standard - Version 2.31

---

---

A party that is carrying out unloading of transport units.

### **Warehouse**

A storage location. It can be the origin or destination location of a transport leg in a route.

### **WillAdvise**

Indicates that party will be identified at a later time

### **Other**

Any other organisation or business entity that may get involved in the transaction and that is not covered by the list.

### **(sequence)**

*The contents of (sequence) are mandatory. A single instance is required.*

### **PartyIdentifier**

*PartyIdentifier is optional. Multiple instances might exist.*

A unique identifier of a specific party. This element contains an attribute PartyIdentifierType that indicates the type of party.

### **NameAddress**

*NameAddress is mandatory. A single instance is required.*

A group item containing name and address of an organisation or business entity.

### **URL**

*URL is optional. A single instance might exist.*

Universal Resource Locator. While typically a web address you could use this field to hold an email address.

### **CommonContact**

*CommonContact is optional. Multiple instances might exist.*

Identifies a specific individual associated with the party.