



papiNet

papiNet V2R31

Data Dictionary

**Global Standard for the Paper and Forest
Products Supply Chain**

Build V2R31_20111115

Date 2011-11-15

Production Release

papiNet V2R31

Copyright

Copyright 2000 – 2011 papiNet G.I.E (“papiNet”) and International Digital Enterprise Alliance, Inc. (“IDEAlliance”) collectively “Copyright Owner”. All rights reserved by the Copyright Owner under the laws of the United States, Belgium, the European Economic Community, and all states, domestic and foreign. This document may be downloaded and copied provided that all copies retain and display the copyright and any other proprietary notices contained in this document. This document may not be sold, modified, edited, or taken out of context such that it creates a false or misleading statement or impression as to the purpose or use of the papiNet specification, which is an open standard. Use of this Standard, in accord with the foregoing limited permission, shall not create for the user any rights in or to the copyright, which rights are exclusively reserved to the Copyright Owner.

papiNet, IDEAlliance, and the members of all papiNet Groups (collectively and individually, “Presenters”) make no representations or warranties, express or implied, including, but not limited to, warranties of merchantability, fitness for a particular purpose, title, or non-infringement. The presenters do not make any representation or warranty that the contents of this document are free from error, suitable for any purpose of any user, or that implementation of such contents will not infringe any third party patents, copyrights, trademarks or other rights. By making use of this document, the user assumes all risks and waives all claims against Presenters.

In no event shall Presenters be liable to user (or other person) for direct, indirect, special or consequential damages arising from or related to any use of this document, including, without limitation, lost profits, business interruption, loss of programs, or other data on your information handling system even if Presenters are expressly advised of the possibility of such damages.

Use of Documents in papiNet Implementations

Documents may be used as templates for a papiNet implementation. The Presenters grant the right to modify and edit them to fit an actual implementation project provided all copies display the copyright and any other proprietary notices contained in this document. Such modified documents must not be distributed beyond the trading partners implementing or maintaining a papiNet connection.

papiNet V2R31

Table of Contents

Copyright.....	2
Use of Documents in papiNet Implementations	2
Table of Contents	3
Data Dictionary: papiNet Version 2.31	37
a	37
Abrasion	38
AbsorptionInk	39
AbsorptionLight	41
AbsorptionWater	42
ActionType [attribute]	43
ActualNominal [attribute]	44
AdditionalTest	45
AdditionalTestName	46
AdditionalText	46
Address1	46
Address2	46
Address3	47
Address4	47
AdjustmentFixedAmount	47
AdjustmentPercentage	47
AdjustmentType (Financial) [attribute]	48
AdjustmentType (Tare) [attribute]	52
AdjustmentTypeReason	54
AdjustmentValue	54
Age	55
Agency [attribute]	55
AggregatedUsageLineItem	59
Alignment	60
Altitude	61
AmbientTemperature	61
Amount	62
AmountSubjectToTermsDiscount	62
AmountType [attribute]	62
Appearance	63
AppliesTo [attribute]	64
ArrivalDate	64
Ash	65
AssemblyInstructions	66
AssemblyType [attribute]	66
AssignedBy [attribute]	67
AttachmentFileName	72
AudioCassette	73
AudioCassetteCaseType [attribute]	75
AudioCassetteTapeLengthType [attribute]	75
Availability	76
AvailabilityDetail	77
AvailabilityHeader	79
AvailabilityIssueDate	80
AvailabilityNumber	81
AvailabilityStatusRequestDetail	81
b	83
Bale	83
BaleCharacteristics	84
BaleConversionCharacteristics	85
BaleDepth	85
BaleHeight	86
BaleItem	87

papiNet V2R31

BalePackagingCharacteristics	89
BaleReference	89
BaleReferenceType [attribute]	90
BalesPerUnit	90
BaleStandardWeight	90
BaleType [attribute]	91
BaleWidth	91
BandCharacteristics	92
BandColour	92
BandDirection [attribute]	93
BandLocationType [attribute]	93
BandMaterial	93
BandsRequired [attribute]	93
BandType [attribute]	94
BarcodeSuppliedByPublisher [attribute]	94
Bark	95
BaseAmountInfo	96
BaseNetAmount	96
BasisWeight	97
BasisWeightVariation	98
BendingResistance	99
BendingStiffness	101
BestBeforeDate	102
Billable [attribute]	102
BillOfMaterials	102
BillToParty	103
BinaryValue	104
BindingBackingType [attribute]	104
BindingBackStyleType [attribute]	104
BindingCoverScoring [attribute]	104
BindingExtras	105
BindingExtrasDescription	105
BindingMaterialCharacteristics	106
BindingMaterialDescription	107
BindingReinforcement [attribute]	107
BindingRibbon [attribute]	107
BindingStyleType [attribute]	107
BindingType [attribute]	111
Black	112
Blanket	112
BlanketPacking	113
BlanketType	113
BleachingProcess [attribute]	113
Bleed [attribute]	113
Blue	114
BookBlock	115
BookBlockBulk	115
BookBlockEdgeTrim	116
BookBlockFinishExtras	116
BookClassification	117
BookClassificationType [attribute]	117
BookManufacturing	119
BookPackageInformation	120
BookSpecification	122
BookSubClassification	124
BookSubClassificationType [attribute]	124
BookUnitPacking	132
BookUnitType [attribute]	133
BooleanValue	133

papiNet V2R31

BoxCharacteristics	134
BoxItem	136
BoxMeasurementsAppliesTo [attribute]	138
BoxReference	138
BoxReferenceType [attribute]	139
BoxType [attribute]	139
Brand	140
Brightness	140
Brilliance	141
BucketType [attribute]	142
Bulk	143
BulkNumberOfUnits	144
Burst	145
BurstIndex	146
BusinessAcceptance	148
BusinessAcceptanceDate	149
BusinessAcceptanceNumber	150
BusinessAcceptanceParty	150
BusinessAcceptanceStatus [attribute]	151
BusinessAcknowledgement	151
BusinessAcknowledgementDate	153
BusinessAcknowledgementNumber	153
BuyerParty	154
ByInvoice	154
ByJob	155
ByLoad	156
ByLoadType [attribute]	156
ByPeriod	157
ByProduct	157
ByPurchaseOrder	158
ByQualifiedDeliveryMessage	159
ByQualifiedPurchaseOrderInformation	159
ByShipTo	160
BySupplierOrder	161
BySupplierOrderNumber	162
Calendar	162
CalendarEntry	163
CalendarEntryPeriod [attribute]	164
CalendarHeader	164
CalendarIssueDate	165
CalendarNumber	166
CalendarRequestDetail	166
CalendarSequence	167
CalendarSequenceNumber	168
CalendarStatus [attribute]	168
CalendarType [attribute]	168
Calibration	169
CalibrationDate	169
CalibrationDescription	170
CalibrationNumber	170
Caliper	170
CallOff	171
CallOffConfirmationIssuedDate	172
CallOffConfirmationLineItemNumber	173
CallOffConfirmationNumber	173
CallOffHeader	174
CallOffHeaderStatusType [attribute]	176
CallOffInformation	177
CallOffIssuedDate	178

papiNet V2R31

CallOffLineItem	179
CallOffLineItemDocumentStatus [attribute]	181
CallOffLineItemDocumentStatus [attribute]	181
CallOffLineItemNumber	182
CallOffLineItemStatusType [attribute]	182
CallOffLineItemText	182
CallOffNumber	182
CallOffPaper	183
CallOffProduct	183
CallOffProductConversionType	185
CallOffPurchaseOrderLineItem	185
CallOffReel	186
CallOffReference	186
CallOffReferenceType [attribute]	186
CallOffSheet	187
CallOffStatusType [attribute]	187
CallOffSummary	188
CallOffType [attribute]	188
CallOffWood	189
CallOffWoodHeader	190
CallOffWoodLineItem	192
CallOffWoodProductGroup	194
CallOffWoodSummary	195
CarrierParty	196
Case	197
CaseBoardMaterials	198
CaseBoardType [attribute]	198
CaseFlushFoot [attribute]	199
CaseLining	199
CaseLiningDescription	199
CaseLocationType [attribute]	199
CaseMaking	200
CaseMaterial	200
CaseOversize	201
CaseShow	201
CaseShowType [attribute]	202
CaseSupers	202
CaseType [attribute]	202
CassetteCardReference	202
CassetteLabelCharacteristics	203
CassetteLabelSide [attribute]	203
CassetteLabelType [attribute]	203
CD	204
CDFormatType [attribute]	205
CDManufacturingProcess [attribute]	205
CDPackaging	206
CDType [attribute]	206
CertificationBody [attribute]	206
ChainOfCustody	206
ChangeDetailType [attribute]	207
Charge	207
ChargeAmount	208
ChargeContext [attribute]	208
ChargeInformation	209
ChargeNetAmount	210
ChargeOrAllowance	210
ChargeOrAllowanceType [attribute]	211
ChargePerUnit	215
ChargeType [attribute]	216

papiNet V2R31

ChildrensTitle [attribute]	218
Chip	218
ChipCharacteristics	219
ChipFraction	220
ChipFractionAnalysisDate.....	220
ChipFractionClass	221
ChipFractionDescription	221
ChipFractionInfo.....	221
ChipFractionNumber	222
ChipFractionPropertyType [attribute].....	222
ChipFractionValue.....	223
ChipPackagingCharacteristics	224
City	224
ClassIdentifier	225
Classification.....	225
ClassificationCode.....	226
ClassificationDescription	226
ClothCrossCut [attribute].....	226
CMYK.....	227
Coating	228
CoatingBottom [attribute].....	230
CoatingCoverageType [attribute]	230
CoatingLocation [attribute]	231
CoatingLocationType [attribute].....	231
CoatingTop [attribute].....	232
CoatWeight.....	233
Collated [attribute]	234
CoLoading	234
CoLoadingNumber	235
CoLoadingReference	235
CoLoadingReferenceType [attribute].....	236
CoLoadingType [attribute]	236
ColourCode.....	236
ColourDescription	237
ColourDetail.....	237
ColourLocation [attribute]	238
ColourMatchDescription	238
ColourShade	238
ColourSpecs	239
CommodityGoodsCode	240
CommonContact.....	240
CommunicationRole [attribute]	241
Complaint.....	242
ComplaintHeader.....	243
ComplaintInformation	245
ComplaintIssueDate.....	245
ComplaintLineItem	247
ComplaintLineItemDetail	249
ComplaintLineItemDetailNumber.....	250
ComplaintLineItemNumber	250
ComplaintLineNetChargeAmount.....	251
ComplaintNumber.....	251
ComplaintReason.....	251
ComplaintReasonCode.....	252
ComplaintReasonDescription	252
ComplaintReasonType [attribute].....	252
ComplaintReference	252
ComplaintReferenceType [attribute]	253
ComplaintResponse	253

papiNet V2R31

ComplaintResponseHeader.....	255
ComplaintResponseHeaderStatusType [attribute].....	257
ComplaintResponseIssueDate.....	258
ComplaintResponseLineItem.....	259
ComplaintResponseLineItemDetail.....	262
ComplaintResponseLineItemDetailNumber.....	263
ComplaintResponseLineItemNumber.....	263
ComplaintResponseLineNetChargeAmount.....	264
ComplaintResponseLineStyleType [attribute].....	264
ComplaintResponseNumber.....	264
ComplaintResponseReason.....	264
ComplaintResponseReasonCode.....	265
ComplaintResponseReasonDescription.....	265
ComplaintResponseReasonType [attribute].....	265
ComplaintResponseReference.....	266
ComplaintResponseReferenceType [attribute].....	266
ComplaintResponseSpecification.....	267
ComplaintResponseSummary.....	268
ComplaintResponseType [attribute].....	269
ComplaintSpecification.....	269
ComplaintSummary.....	270
ComplaintType [attribute].....	271
ComponentDueDate.....	271
ComponentNeededDate.....	272
ComponentShipDate.....	273
CompositeAndVeneerWoodPanels.....	273
CompoundAgency [attribute].....	274
CompoundType [attribute].....	274
ConcernIndicatorType [attribute].....	274
ConstructionPackagesAndPreFabPanels.....	274
ConsumptionProcess.....	275
ContactIdentifier.....	276
ContactIdentifierType [attribute].....	276
ContactName.....	277
ContactType [attribute].....	277
ConversionCode.....	278
CoordinateFormatType [attribute].....	279
Coordinates.....	279
CoreCharacteristics.....	280
CoreCode.....	280
CoreDiameterInside.....	281
CoreDiameterOutside.....	281
CoreEndType [attribute].....	282
CoreMaterialType [attribute].....	282
CorePlugs.....	283
CoreStrengthCode.....	283
CorrectiveAction.....	284
CostComponent.....	284
CostComponentCode.....	284
CostComponentDescription.....	285
Country.....	285
CountryOfConsumption.....	285
CountryOfDestination.....	286
CountryOfOrigin.....	286
County.....	286
CreditDebitNote.....	287
CreditDebitNoteAmountSubtotal.....	288
CreditDebitNoteBaseAmountInformation.....	288
CreditDebitNoteDate.....	288

papiNet V2R31

CreditDebitNoteHeader.....	290
CreditDebitNoteLineAmount.....	292
CreditDebitNoteLineItem.....	293
CreditDebitNoteLineItemNumber.....	296
CreditDebitNoteNumber.....	296
CreditDebitNoteReason.....	296
CreditDebitNoteReasonCode.....	296
CreditDebitNoteReasonType [attribute].....	297
CreditDebitNoteReference.....	297
CreditDebitNoteReferenceType [attribute].....	298
CreditDebitNoteSummary.....	298
CreditDebitNoteType [attribute].....	300
CurrencyFromType [attribute].....	300
CurrencyType [attribute].....	300
CurrencyValue.....	301
CustomerMarks.....	301
CustomerMarksType [attribute].....	301
CustomsParty.....	303
CustomsReferenceNumber.....	304
CustomsReferenceNumberType [attribute].....	304
CustomsStampDate.....	304
CustomsStampHeaderText.....	305
CustomsStampInformation.....	305
CustomsStampTrailerText.....	306
CustomsTariffCode.....	306
CustomsTotals.....	306
CuttingDetails.....	307
CuttingTemplateCode.....	307
Cyan.....	308
Date.....	309
DateFinished.....	309
DateMade.....	310
DateSheeted.....	310
DateTimeFrom.....	311
DateTimeRange.....	311
DateTimeTo.....	312
DateTimeValue.....	312
DateType [attribute].....	312
DateWound.....	316
Day.....	317
Days.....	317
Debarked [attribute].....	317
DeckAndPorchFlooringMaterials-NaturalWood.....	317
DeckAndPorchFlooringMaterials-NaturalWoodCharacteristics.....	318
DecorationCoverage.....	320
DecorationLocationType [attribute].....	320
DecorationSpecs.....	321
DecorationType [attribute].....	322
DeliveryDate.....	322
DeliveryDateType [attribute].....	323
DeliveryDateWindow.....	324
DeliveryDestination.....	326
DeliveryIndicator.....	327
DeliveryInfo.....	328
DeliveryInstruction.....	329
DeliveryInstructionDate.....	330
DeliveryInstructionHeader.....	331
DeliveryInstructionHeaderStatusType [attribute].....	332
DeliveryInstructionNumber.....	333

papiNet V2R31

DeliveryInstructionReference.....	333
DeliveryInstructionReferenceType [attribute].....	333
DeliveryInstructionSequence.....	334
DeliveryInstructionSequenceLineItem.....	337
DeliveryInstructionSequenceLineItemNumber.....	340
DeliveryInstructionSequenceNumber.....	340
DeliveryInstructionSequenceStatusType [attribute].....	340
DeliveryInstructionStatusType [attribute].....	341
DeliveryInstructionSummary.....	341
DeliveryInstructionType [attribute].....	342
DeliveryLastDateOfChange.....	342
DeliveryLeg.....	344
DeliveryLegReference.....	346
DeliveryLegReferenceType [attribute].....	347
DeliveryLegSequenceNumber.....	347
DeliveryLegType [attribute].....	347
DeliveryLineNumber.....	348
DeliveryMessage.....	348
DeliveryMessageBook.....	349
DeliveryMessageBookHeader.....	351
DeliveryMessageBookShipment.....	353
DeliveryMessageBookSummary.....	354
DeliveryMessageContextType [attribute].....	354
DeliveryMessageDate.....	355
DeliveryMessageHeader.....	356
DeliveryMessageLineItem.....	359
DeliveryMessageLineItemNumber.....	362
DeliveryMessageNumber.....	362
DeliveryMessageProductGroup.....	362
DeliveryMessageReelCharacteristics.....	363
DeliveryMessageReference.....	364
DeliveryMessageReferenceType [attribute].....	365
DeliveryMessageShipment.....	365
DeliveryMessageStatusType [attribute].....	366
DeliveryMessageSummary.....	366
DeliveryMessageType (Book) [attribute].....	367
DeliveryMessageType [attribute].....	368
DeliveryMessageType (Wood) [attribute].....	368
DeliveryMessageWood.....	369
DeliveryMessageWoodHeader.....	371
DeliveryMessageWoodSummary.....	373
DeliveryModeType [attribute].....	374
DeliveryOrigin.....	375
DeliveryRouteCode.....	376
DeliverySchedule.....	377
DeliveryScheduleReference.....	378
DeliveryScheduleReferenceType [attribute].....	379
DeliveryShipmentBookLineItem.....	380
DeliveryShipmentId.....	382
DeliveryShipmentLineItem.....	383
DeliveryShipmentLineItemNumber.....	386
DeliveryStatus.....	386
DeliveryStatusType [attribute].....	386
DeliveryTransitTime.....	387
Density.....	388
DepartureDate.....	389
DetailRangeMax.....	390
DetailRangeMin.....	390
DetailValue.....	390

papiNet V2R31

DiameterBreastHeight	390
DieCut [attribute]	391
DieCutDescription	391
DirectLoading [attribute]	391
DirectUnloading [attribute]	391
Dirt	392
DiscPrinting [attribute]	393
DistanceFromCore	393
DistanceFromEdge	394
DistanceMeasuredTo [attribute]	394
DistanceToNextStop	395
Document	395
DocumentContent	396
DocumentContentText	397
DocumentContentType [attribute]	397
DocumentDate	399
DocumentInformation	400
DocumentInstruction	400
DocumentName [attribute]	401
DocumentNumber	406
DocumentReference	406
DocumentReferenceID	407
DocumentReferenceIDLineNumber	407
DocumentReferenceIDType [attribute]	408
DocumentReferenceInformation	408
DocumentReferenceType [attribute]	409
DocumentRequired	409
DocumentRequiredType [attribute]	410
DocumentType [attribute]	410
DocumentType [attribute]	411
DocumentVersionNumber	416
DominantWavelength	417
DoubleBunked [attribute]	418
DownGradingInfo	418
DownGradingReason	419
DownGradingReasonCode	419
DownGradingReasonDescription	419
Downtime	419
DowntimeDescription	420
DowntimeReasonCode	420
DrainageResistance	421
Drilled [attribute]	422
DuplicationRatio [attribute]	422
DVD	423
DVDFormatType [attribute]	424
eAttachment	424
e-Attachment	425
Edge	425
Edge	426
EdgeFinish	426
EdgeLocation [attribute]	427
EdgeLocationType [attribute]	427
EdgeMachiningProfile	427
EdgePaddable [attribute]	428
EdgeType [attribute]	428
EdgeType [attribute]	428
Email	428
Embossing	429
EmbossingCode	429

papiNet V2R31

EmbossingDescription	429
EndCaps.....	429
EndIdentifierRange	430
EndsDiscountInformation.....	430
EndsDiscountPercent.....	431
EndsDiscountRule [attribute].....	431
EndsheetCopyDescription	431
EndsheetInformation.....	432
EndsheetLocationType [attribute]	432
EndsheetMaterials	433
EndsheetReinforcementMaterials	433
EndsheetReinforcementType [attribute]	434
EndsheetType [attribute].....	434
EndsLengthMax.....	434
EndsPermittedPercent	435
EndUserParty.....	435
EndUses.....	436
Error.....	436
ErrorCode.....	437
ErrorDescription	437
ErrorReference.....	437
ErrorReferenceType [attribute]	438
ErrorSeverity	438
EstimatedArrivalDate	438
EvenSpacing.....	439
EventDate	439
EventType [attribute].....	439
ExchangeRate.....	440
ExchangeRateType [attribute]	441
ExcitationPurity.....	441
ExLog	442
ExtraFeature.....	443
ExtraFeatureDescription	443
Face [attribute].....	443
Fax.....	443
FibreClassification.....	444
FibreLength	445
FibreSource [attribute].....	446
FinishedSize	448
FinishPrep	448
FinishPrepInput.....	449
FinishPrepInputType	449
FinishPrepOutputType [attribute]	450
FinishSpecs	450
FinishType [attribute].....	451
FireTreatment	453
FireTreatmentType [attribute]	453
FlapLocation [attribute]	453
FlapWidth.....	454
FlatAmountAdjustment.....	454
FlatSize.....	455
Floor.....	455
FloorLocationType [attribute]	455
FloorPackage	456
FloorPanel	456
FloorTruss	456
Folded [attribute]	456
Folding.....	457
Foot	458

papiNet V2R31

ForestWood	459
ForestWoodCharacteristics	460
ForestWoodClass	460
ForestWoodClassCode	461
ForestWoodClassDescription	461
ForestWoodClassType [attribute]	461
ForestWoodItemType [attribute]	461
ForestWoodPackagingCharacteristics	462
ForestWoodProcessingCharacteristics	462
ForestWoodType [attribute]	462
Formation	464
ForwarderParty	465
FountainSolutionConductivity	466
FountainSolutionpH	466
Freeness	467
FreightPayableAt	468
Friction	469
From	470
FromProduct	471
GeneralLedgerAccount	472
Gimmick	472
Gloss	473
GlueExposure	474
GlueExposure	474
GlueExposureID	475
GoodsLoadingPrinciple [attribute]	475
GoodsReceipt	476
GoodsReceiptAcceptance [attribute]	477
GoodsReceiptAcceptance [attribute]	478
GoodsReceiptArrivalDate	479
GoodsReceiptHeader	480
GoodsReceiptHeaderAcceptance [attribute]	482
GoodsReceiptIssueDate	483
GoodsReceiptLineItem	485
GoodsReceiptLineItemNumber	487
GoodsReceiptNumber	487
GoodsReceiptPackage	487
GoodsReceiptReference	488
GoodsReceiptReferenceType [attribute]	489
GoodsReceiptStatusType [attribute]	489
GoodsReceiptSummary	490
GoodsReceiptUnloadDate	490
GoodsReceivedRejectedType [attribute]	491
GPSCoordinates	492
GPSSystem [attribute]	493
Grade	493
GradeAgency [attribute]	493
GradeAgency	494
GradeCode	494
GradeName	495
GradeStamp	495
GradeStamped [attribute]	495
GradeStampLocation	495
GradeStampMillNumber	496
GradeType [attribute]	496
GradingRule [attribute]	504
GrainDirection	504
Green	505
Gutter	506

papiNet V2R31

Gypsum	506
Halftones	507
HardwoodLumber	507
HardwoodLumberCharacteristics	507
Head	508
Headband.....	509
HeatTreatment.....	509
HeatTreatmentType [attribute].....	510
Height	510
Height	511
HighlightedPlanningBucket.....	511
HolePunchInformation.....	512
HolePunchTemplateReference.....	512
HolePunchThroughCover [attribute]	512
HolePunchType	512
HoleReinforcement	513
HoleSpacing	513
Hours	513
HSB.....	514
Hue	515
Humidity	516
Identifier	516
IdentifierCodeType [attribute]	517
IdentifierFormatType [attribute]	519
IdentifierType [attribute]	520
Impressions.....	521
Incoterms [attribute]	521
IncotermsLocation	522
IncotermsVersion [attribute].....	523
IncrementalOrderQuantity	523
IncrementalValue	524
InfoRequest.....	525
InfoRequestType [attribute].....	527
InformationalAmount	528
InformationalPricePerUnit	529
InformationalPricePerUnitType [attribute]	529
InformationalQuantity	530
Ink.....	531
InkCharacteristics.....	532
InkCoverage.....	533
InkCoverageType [attribute]	533
InkDelivery.....	533
InkManufacturer.....	534
InkTack.....	534
InkTypeDescription.....	534
InkViscosity.....	534
InlayCardQuantity [attribute]	535
InsertReference.....	535
InstructionByType [attribute]	535
Insurance.....	536
InsuranceContractNo	536
InsuranceInfo	536
InsuredValue	536
Insurer	537
InventoryChange.....	537
InventoryChangeHeader.....	538
InventoryChangeIssuedDate	539
InventoryChangeLineItem.....	541
InventoryChangeLineItemDetail.....	543

papiNet V2R31

InventoryChangeLineItemDetailNumber	544
InventoryChangeLineItemNumber	545
InventoryChangeNumber	545
InventoryChangeReason	545
InventoryChangeReasonCode	545
InventoryChangeReference	546
InventoryChangeReferenceType [attribute]	546
InventoryChangeStatusType [attribute]	546
InventoryChangeSummary	547
InventoryChangeType [attribute]	548
InventoryClass	549
InventoryClassCode	550
InventoryClassDescription	550
InventoryClassLevel [attribute]	550
InventoryDispositionInstructions	551
InventoryDispositionInstructionsDetail	552
InventoryDispositionInstructionsHeader	554
InventoryDispositionInstructionsIssuedDate	555
InventoryDispositionInstructionsLineNumber	556
InventoryDispositionInstructionsNumber	556
InventoryDispositionInstructionsReference	556
InventoryDispositionInstructionsReferenceType [attribute]	557
InventoryDispositionInstructionsType [attribute]	557
InventoryInspectionDate	557
InventoryOwnedBy [attribute]	558
InventoryStatus	558
InventoryStatusHeader	560
InventoryStatusIssuedDate	561
InventoryStatusLineItem	562
InventoryStatusLineItemDetail	564
InventoryStatusLineItemDetailNumber	565
InventoryStatusLineItemNumber	565
InventoryStatusNumber	565
InventoryStatusReference	565
InventoryStatusReferenceType [attribute]	566
InventoryStatusReportingDetailType [attribute]	566
InventoryStatusRequestDetail	567
InventoryStatusRequestDetailType [attribute]	569
InventoryStatusSummary	569
InventoryStatusType [attribute]	570
Invoice	571
InvoiceContextType [attribute]	572
InvoiceDate	572
InvoiceDeliveryInformation	574
InvoiceHeader	576
InvoiceLineAmount	578
InvoiceLineBaseAmount	578
InvoiceLineBaseAmountInformation	579
InvoiceLineItem	580
InvoiceLineNumber	583
InvoiceNumber	583
InvoiceNumberMax	584
InvoiceNumberMin	584
InvoiceNumberRange	584
InvoicePrimaryStatus	584
InvoiceProductGroup	585
InvoiceReference	585
InvoiceReferenceType [attribute]	586
InvoiceSecondaryStatus	586

papiNet V2R31

InvoiceShipment	586
InvoiceStatusCode [attribute]	587
InvoiceSummary	588
InvoiceType [attribute].....	590
InvoiceWood.....	591
InvoiceWoodHeader	594
InvoiceWoodLineItem.....	597
InvoiceWoodSummary	601
IsAverageValue [attribute].....	603
IsBindingHandSeparation [attribute]	603
IsBoxed [attribute]	603
IsEaselBound [attribute].....	604
IsFinalInvoice [attribute]	604
IsHalftones [attribute].....	604
ISOCountryCode [attribute]	604
IsOptionalDestination [attribute].....	605
IsPalletized [attribute].....	605
IsPartialIndicator [attribute].....	605
IsPartialPalletsAllowed [attribute]	605
IssueOrEventID.....	605
IsThirdPartyAdvice [attribute]	606
IsThirdPartyShipment [attribute]	606
IsTradeRegionAvailable [attribute]	606
ItemCount	606
ItemDetails.....	607
ItemInfo	608
ItemInformation.....	609
ItemisedUsageLineItem	610
ItemMeasuringInfo	611
ItemReference	612
ItemReferenceType [attribute]	612
ItemsPerPallet.....	613
ItemsPerTier.....	613
ItemType [attribute]	613
JewelBox.....	614
JewelBoxType [attribute].....	615
JobCode.....	615
JobDateTimeRange	616
JobDescription	616
JobID.....	616
JobInformation.....	616
Joining.....	617
JoiningType [attribute]	617
L.....	618
Lab.....	619
LabelBrandName	620
LabelCharacteristics	620
LabelOrientation [attribute].....	621
LabelPosition	621
LabelStock.....	621
LabelStockCharacteristics	622
LabelStockLayer	622
LabelStockLayerNumber	623
LabelStockLayerType	623
LabelStyle	623
Language [attribute].....	623
LargeEndDiameter	624
LastDateOfChange.....	624
Latitude	624

papiNet V2R31

LayerMaterial	625
LayerMaterialName	625
LayersPerUnit	625
LegStageType [attribute]	625
Length	626
Length	627
Length	627
LengthCategory	628
LengthCutDescription	628
LengthCutType [attribute]	628
LengthFromCore	629
LengthSpecification	629
LicenceNumber	630
LightScattering	630
LineBaseAmount	631
LineItemSubTotal	631
LoadAvailable	632
LoadAvailableConfirmationIssuedDate	633
LoadAvailableHeader	634
LoadAvailableHeaderStatusType [attribute]	636
LoadAvailableInformation	637
LoadAvailableIssuedDate	638
LoadAvailableLineItem	639
LoadAvailableLineItemNumber	641
LoadAvailableLineItemStatusType [attribute]	641
LoadAvailableNumber	642
LoadAvailableReference	642
LoadAvailableReferenceType [attribute]	642
LoadAvailableStatusType [attribute]	643
LoadAvailableSummary	643
LoadAvailableType [attribute]	644
LoadingTolerance [attribute]	644
LoadNumber	644
LoadOpeningSide [attribute]	644
LoadReleaseNumber	645
LoadTender	645
LoadTenderAmount	646
LoadTenderHeader	647
LoadTenderHeaderStatusType [attribute]	649
LoadTenderIssueDate	649
LoadTenderLineItem	650
LoadTenderLineItemAmount	652
LoadTenderLineItemBaseAmountInformation	652
LoadTenderLineItemNumber	652
LoadTenderNumber	652
LoadTenderReference	653
LoadTenderReferenceType [attribute]	653
LoadTenderResponse	654
LoadTenderResponseHeader	656
LoadTenderResponseHeaderStatusType [attribute]	658
LoadTenderResponseIssueDate	659
LoadTenderResponseLineItem	660
LoadTenderResponseLineItemNumber	662
LoadTenderResponseNumber	662
LoadTenderResponseReference	662
LoadTenderResponseReferenceType [attribute]	663
LoadTenderResponseSegment	664
LoadTenderResponseSegmentDocumentStatus [attribute]	666
LoadTenderResponseSegmentNumber	667

papiNet V2R31

LoadTenderResponseSegmentStatusType [attribute]	667
LoadTenderResponseStatusType [attribute].....	667
LoadTenderResponseSummary	668
LoadTenderResponseType [attribute]	669
LoadTenderSegment	670
LoadTenderSegmentDocumentStatus [attribute]	672
LoadTenderSegmentNumber	672
LoadTenderSegmentStatusType [attribute]	672
LoadTenderStatusType [attribute].....	673
LoadTenderSummary	673
LoadTenderType [attribute]	674
LocationCode	674
LocationIdentifier	674
LocationInformation	675
LocationParty	676
LocationQualifier [attribute]	677
LocationType [attribute]	678
LocationType [attribute]	678
Log.....	679
LogCharacteristics	679
LogConversionRule [attribute]	680
LogisticsRole [attribute]	681
LogLengthType [attribute]	681
LogPackagingCharacteristics	681
Longitude	682
LumberGrade	683
LumberSpecies.....	684
Luminance.....	685
Machine	686
MachineConditions	687
MachineDownTime.....	687
MachineID	688
MachineLocation.....	688
MachineSpeed.....	688
MachineStoppage [attribute]	689
Magenta.....	689
MailAttachment	690
MailAttachmentType [attribute]	690
MakeTo	690
ManufacturingProcess	691
ManufacturingProcessAgency [attribute]	691
ManufacturingProcessType [attribute].....	692
ManufacturingSpecifications	694
MapCoordinates	695
MapCoordinateType [attribute]	695
MapPoint	697
MapPointComment.....	698
MapPointDisplayType [attribute]	698
MapPointName	698
MapPointType [attribute]	698
MapReferenceSystem [attribute].....	700
Margins.....	702
MasterReelWidth	702
MasterSource [attribute]	703
MasterStorageOption	703
MaterialCharacteristics	704
MaxCurrencyValue	706
MaximumClampingForce.....	706
MaximumGrossWeight.....	706

papiNet V2R31

MaximumHeight	707
MaximumNumberOfJoins	707
MaximumOffcut	708
MaximumOrderQuantity	708
MeasurementModule	709
MeasurementsAre [attribute]	709
MeasurementSystem.....	709
MeasuringAgency [attribute]	709
MeasuringCode	710
MeasuringDate	710
MeasuringDescription	711
MeasuringEquipment.....	711
MeasuringEquipmentCode.....	711
MeasuringLineID	712
MeasuringLocation	712
MeasuringMethod [attribute]	712
MeasuringMethodType [attribute]	712
MeasuringNumber	713
MeasuringParty	713
MeasuringSpecification	714
MeasuringTicket	715
MeasuringTicketHeader	716
MeasuringTicketIssueDate	717
MeasuringTicketNumber	718
MeasuringTicketReference	718
MeasuringTicketReferenceType [attribute].....	719
MeasuringTicketSequence	720
MeasuringTicketSequenceLineItem.....	723
MeasuringTicketSequenceLineItemNumber	725
MeasuringTicketSequenceNumber	725
MeasuringTicketStatusType [attribute]	725
MeasuringTicketSummary	726
MeasuringTicketType [attribute]	726
MeasuringType [attribute]	727
MechanicalMaterial	727
MechanicalMaterialCharacteristics	728
MechanicalMaterialDescription	728
Media	729
MediaLength	730
MediaType [attribute]	730
MerchantParty.....	731
Method [attribute]	731
MethodOfPayment	732
MillCharacteristics.....	732
MillJoinLocation	733
MillJoinNumber.....	733
MillOrderInformation	733
MillOrderLineItemNumber	734
MillOrderNumber	734
MillParty.....	734
MillProductionInformation	735
Millwork	735
MinCurrencyValue.....	736
MinimumOrderQuantity	736
Minutes.....	736
MixedProductPalletIndicator [attribute]	736
MixProductIndicator [attribute].....	737
MobilePhone	737
ModulusElasticity [attribute].....	737

papiNet V2R31

Moisture.....	738
MoistureContent.....	739
MoistureContentPercentage [attribute]	739
MonetaryAdjustment.....	741
MonetaryAdjustmentAmount.....	742
MonetaryAdjustmentLine.....	743
MonetaryAdjustmentReferenceLine.....	743
MonetaryAdjustmentStartAmount.....	743
MonetaryAdjustmentStartQuantity.....	743
Month.....	744
Mullen.....	744
MWeight.....	745
Name1.....	746
Name2.....	746
Name3.....	746
NameAddress.....	747
NASTA [attribute].....	748
NaturalWoodSiding.....	749
NaturalWoodSidingCharacteristics.....	750
NaturalWoodSiding-Other.....	752
NaturalWoodSiding-OtherCharacteristics.....	753
NetAmount.....	755
NetChargeAmount.....	755
NoiseReduction [attribute].....	755
NonPressComponent.....	756
NonStandardPulp.....	756
NumberOfAttachments.....	757
NumberOfBands.....	757
NumberOfBindComponents.....	757
NumberOfColours.....	757
NumberOfComplaintLineItemDetail.....	757
NumberOfComplaintResponseLineItemDetail.....	757
NumberOfDocuments.....	757
NumberOfDocumentsRequired.....	758
NumberOfGoodsReceiptPackages.....	758
NumberOfHits.....	758
NumberOfHoles.....	758
NumberOfInventoryChangeLineItemDetails.....	758
NumberOfInventoryStatusLineItemDetails.....	758
NumberOfItemMeasuringInfo.....	758
NumberOfLabels.....	759
NumberOfMillJoins.....	759
NumberOfPackages.....	759
NumberOfPackingListItems.....	759
NumberOfPages.....	759
NumberOfPlies.....	759
NumberOfRibbons.....	759
NumberOfSides.....	759
NumberOfSignatures.....	760
NumberOfUncompletedMeasuredItems.....	760
NumberOfWraps.....	760
NumberOrderDocumentRequired.....	760
NumberPerProduct.....	760
NumericValue.....	761
OldInformationalQuantity.....	762
OldInventoryClass.....	763
OldQuantity.....	764
Opacity.....	766
OrderConfirmation.....	767

papiNet V2R31

OrderConfirmationHeader	769
OrderConfirmationHeaderStatusType [attribute]	772
OrderConfirmationHeaderStatusTypeText	772
OrderConfirmationIssuedDate	772
OrderConfirmationLineItem	774
OrderConfirmationLineItemDocumentStatus [attribute]	778
OrderConfirmationLineItemDocumentStatus [attribute]	778
OrderConfirmationLineItemNumber	779
OrderConfirmationLineItemStatusType [attribute]	779
OrderConfirmationLineItemStatusTypeText	779
OrderConfirmationNumber	779
OrderConfirmationReference	780
OrderConfirmationReferenceType [attribute]	780
OrderConfirmationStatusType [attribute]	781
OrderConfirmationSummary	782
OrderConfirmationWood	784
OrderConfirmationWoodHeader	786
OrderConfirmationWoodLineItem	789
OrderConfirmationWoodProductGroup	793
OrderConfirmationWoodSummary	794
OrderContextType [attribute]	796
OrderDocumentRequired	796
OrderHeaderStatusType [attribute]	797
OrderLineItemDocumentStatus [attribute]	797
OrderLineItemStatusType [attribute]	797
OrderPrimaryStatus	798
OrderQuantities	798
OrderSecondaryStatus	799
OrderStatus	799
OrderStatusCode [attribute]	800
OrderStatusDetail	802
OrderStatusHeader	805
OrderStatusInformation	806
OrderStatusInformationDate	807
OrderStatusNumber	807
OrderStatusReference	807
OrderStatusReferenceType [attribute]	808
OrderStatusRequestDetail	809
OrderStatusRequestDetailType [attribute]	811
OrderStatusResponseDate	811
OrderStatusType [attribute]	812
OrderStatusType [attribute]	812
OrderType [attribute]	812
OrderType [attribute]	813
OrderType [attribute]	814
OrganisationUnit	815
OrganisationUnitCode	815
OrganisationUnitName	815
OrganisationUnitType [attribute]	815
OrientationWithFaceWoodPanelGrain [attribute]	816
Original [attribute]	816
OtherDate	816
OtherParty	818
OtherTreatment	818
Overlay	819
OverlaySide [attribute]	819
PackageAgency [attribute]	819
PackageCharacteristics	820
PackageCode	821

papiNet V2R31

PackageIdentifier.....	821
PackageIDInformation.....	821
PackageInformation.....	822
PackageLevel [attribute].....	825
PackageMeasuringInfo.....	825
PackageName.....	826
PackageReference.....	826
PackageReferenceType [attribute].....	826
PackagesPerWrap.....	827
PackageType [attribute].....	827
PackageType.....	828
Packaging.....	829
PackagingCharacteristics.....	829
PackagingCode.....	830
PackagingCodeSpecification.....	831
PackagingDescription.....	831
PackagingInformation.....	832
PackingList.....	833
PackingListDate.....	834
PackingListHeader.....	835
PackingListItem.....	837
PackingListItemNumber.....	838
PackingListItemType [attribute].....	839
PackingListNumber.....	839
PackingListReference.....	839
PackingListReferenceType [attribute].....	840
PackingListStatusType [attribute].....	840
PackingListSummary.....	840
PackingUnit.....	842
PackingUnitMeasurements.....	843
PackingUnitSerialNumber.....	843
PackingUnitType [attribute].....	844
PagesPerSet.....	844
PagesPerSignature.....	844
Pagination.....	844
PalletAdditionsType [attribute].....	844
PalletCharacteristics.....	845
PalletCoverType [attribute].....	847
PalletLedgeType [attribute].....	847
PalletLength.....	848
PalletPackagingCharacteristics.....	848
PalletTopType [attribute].....	849
PalletType [attribute].....	850
PalletWidth.....	851
Paper.....	851
PaperCharacteristics.....	852
PaperSizeType.....	858
PartyIdentifier.....	858
PartyIdentifierType [attribute].....	858
PartyType [attribute].....	862
PasteDiameter.....	867
PatternProfile.....	868
PatternProfileAgency [attribute].....	869
PatternProfileCode.....	869
PatternProfileType [attribute].....	870
PerCarton.....	875
Perforated [attribute].....	875
Perforation.....	876
PerforationType [attribute].....	876

papiNet V2R31

PeriodType [attribute]	876
Permeability	877
PerPallet	878
PerReam	878
PerTab	879
pH.....	879
PiecesPerRow.....	880
PlacementInOrderOfMatter.....	880
PlacementLocation [attribute]	881
PlacementReference [attribute]	881
PlacementSequence [attribute].....	882
Planning.....	882
PlanningBucket	883
PlanningBucketStatusType [attribute].....	884
PlanningHeader	885
PlanningIdentifier	886
PlanningIssueDate	886
PlanningLineItem.....	888
PlanningLineItemNumber.....	890
PlanningMessageNumber	890
PlanningProcessType [attribute]	890
PlanningReference	890
PlanningReferenceType [attribute]	891
PlanningRequestDetail.....	891
PlasticMaterial.....	892
PlasticMaterialType [attribute].....	893
PlasticPrinting [attribute]	893
PlasticPrintingDescription.....	893
Plate.....	893
PlateType.....	893
PlyAttributes.....	894
PlyBond	899
PlyNumber	900
PlySet.....	900
PlywoodLayupStructure	901
PlywoodMachining	901
PlywoodOSBGrade.....	902
PlywoodOSBSpecies.....	902
PlywoodPlyCharacteristics	903
PlywoodPlyGrade.....	903
PlywoodPlySet.....	903
Porosity	904
PositionInSheet	905
PositionMeasuredFrom [attribute]	905
PositionOnItem	906
PostalCode	906
PostConsumerWaste	907
PPI	908
PreConsumerWaste.....	909
PrepDueDate	910
PrepInformation	911
PrepNeededDate	912
PrepReference.....	912
PrepReferenceType [attribute].....	913
PrepShipDate.....	913
PrepType [attribute]	914
PressBreakLocation.....	915
PressComponent	915
PressConditions.....	916

papiNet V2R31

PressFormType	917
PressImpositionType [attribute].....	917
PressPrep.....	917
PressPrepInput.....	918
PressPrepInputType	918
PressPrepOutputType [attribute].....	919
PressType [attribute]	919
PressureTreatment	920
PressureTreatmentCompound.....	921
PressureTreatmentComStdorUseCategory	921
PressureTreatmentConcentration	922
PriceAdjustment	923
PriceAndAmountInfo	923
PriceDetails	924
PricePerUnit.....	925
PriceQuantityBasis [attribute].....	926
PriceTaxBasis [attribute]	927
PrintedMediaSpecs.....	928
PrintingMaterials	929
PrintParameters	930
PrintType [attribute]	930
PrintUnit	932
PrintUnitNumber.....	932
PrintUnitType [attribute].....	932
PriorityOrder [attribute]	933
ProcessingCode	933
ProcessingCodeSpecification.....	933
ProcessingDescription	933
Product	934
ProductAttributes	935
ProductAttributesHeader.....	937
ProductAttributesIssueDate.....	939
ProductAttributesLineItem	940
ProductAttributesLineItemStatusType [attribute].....	942
ProductAttributesProductURL.....	942
ProductAttributesReference.....	943
ProductAttributesReferenceType [attribute].....	943
ProductAttributesStatusType [attribute].....	944
ProductAttributesType [attribute].....	944
ProductBasisSizeType [attribute]	944
ProductDescription.....	945
ProductGroupID	946
ProductGroupIDType [attribute]	946
ProductGroupSummary	946
ProductIdentification	947
ProductIdentifier	947
ProductIdentifierType [attribute].....	948
ProductionLastDateOfChange	950
ProductionRunNumber.....	950
ProductionStatus	950
ProductionStatusType [attribute]	951
ProductPackaging	952
ProductPercentage.....	953
ProductPerformance.....	953
ProductPerformanceConcerns	954
ProductPerformanceConditions	955
ProductPerformanceDate	955
ProductPerformanceHeader	956
ProductPerformanceIssueDate.....	957

papiNet V2R31

ProductPerformanceLineItem.....	958
ProductPerformanceLineItemNumber.....	959
ProductPerformanceNumber.....	960
ProductPerformanceReference.....	960
ProductPerformanceReferenceType [attribute].....	960
ProductPerformanceStatusType [attribute].....	961
ProductPerformanceSummary.....	961
ProductQuality.....	962
ProductQualityHeader.....	963
ProductQualityIssueDate.....	965
ProductQualityMessageNumber.....	965
ProductQualityPeriod.....	966
ProductQualityPurchaseOrder.....	969
ProductQualityReference.....	971
ProductQualityReferenceType [attribute].....	972
ProductQualityRequestDetail.....	972
ProductQualityRequestDetailType [attribute].....	973
ProductQualityShipment.....	974
ProductQualityStatusType [attribute].....	976
ProductSummary.....	977
ProofApprovalDate.....	977
ProofDueDate.....	978
ProofInformationalQuantity.....	979
ProofType [attribute].....	980
PropertyAverageValue.....	981
PropertyType [attribute].....	982
PropertyValue.....	985
Pulp.....	986
PulpCharacteristics.....	988
PulpConcernCode.....	991
PulpConcernDescription.....	991
PulpConcerns.....	991
PulpingProcess [attribute].....	992
PulpUnitCharacteristics.....	993
PunchedHoleDetails.....	994
PurchaseOrder.....	995
PurchaseOrderDetail.....	996
PurchaseOrderHeader.....	998
PurchaseOrderHeaderStatusType [attribute].....	1000
PurchaseOrderInformation.....	1001
PurchaseOrderIssuedDate.....	1002
PurchaseOrderLineItem.....	1003
PurchaseOrderLineItemDocumentStatus [attribute].....	1006
PurchaseOrderLineItemNumber.....	1006
PurchaseOrderLineItemStatusType [attribute].....	1007
PurchaseOrderNumber.....	1007
PurchaseOrderReference.....	1007
PurchaseOrderReferenceType [attribute].....	1008
PurchaseOrderReleaseNumber.....	1008
PurchaseOrderStatusType [attribute].....	1008
PurchaseOrderSummary.....	1009
PurchaseOrderType [attribute].....	1009
PurchaseOrderWood.....	1011
PurchaseOrderWoodHeader.....	1013
PurchaseOrderWoodLineItem.....	1016
PurchaseOrderWoodProductGroup.....	1020
PurchaseOrderWoodSummary.....	1021
Quantity.....	1023
QuantityByProperty.....	1024

papiNet V2R31

QuantityDeviation	1025
QuantityInformation	1025
QuantityInUnit	1026
QuantityOrderedInformation	1026
QuantityType [attribute]	1027
QuantityTypeContext [attribute]	1029
QuoteInCurrency	1032
RangeMax	1032
RangeMin	1032
RawMaterialSet	1032
ReamItem	1033
ReamType	1034
ReamWeight	1035
ReasonCode [attribute]	1035
ReasonDescription	1035
ReceiverParty	1036
RecoveredPaper	1037
RecoveredPaperAttributes	1037
Recycled	1038
RecycledCharacteristics	1039
RecycledRequired [attribute]	1039
Red	1040
Reel	1040
ReelArm	1041
ReelBreakDiameter	1041
ReelConversionCharacteristics	1042
ReelDiameter	1043
ReelItem	1044
ReelLength	1045
ReelPackagingCharacteristics	1046
ReelsPerPack	1047
ReelStandUnit	1048
ReelWidth	1048
referenceType [simple type]	1048
Reissued [attribute]	1064
RelativeLocation [attribute]	1064
RemitToParty	1065
RequestedAction	1065
RequestingParty	1066
RequestNumber	1066
Resistance	1067
RespondByDate	1068
RespondToParty	1069
ResultSource [attribute]	1069
ReturnReason	1070
ReturnReasonCode	1071
ReturnReasonDescription	1071
ReturnType [attribute]	1071
RewoundIndicator [attribute]	1071
RFQ	1072
RFQHeader	1073
RFQHeaderStatusType [attribute]	1075
RFQInformation	1076
RFQIssuedDate	1076
RFQLineItem	1077
RFQLineItemDocumentStatus [attribute]	1080
RFQLineItemNumber	1080
RFQLineItemStatusType [attribute]	1080
RFQNumber	1080

papiNet V2R31

RFQReference	1081
RFQReferenceType [attribute]	1081
RFQRespondByDate	1081
RFQResponse	1082
RFQResponseHeader	1084
RFQResponseHeaderStatusType [attribute]	1086
RFQResponseHeaderStatusTypeText	1087
RFQResponseIssuedDate	1087
RFQResponseLineItem	1088
RFQResponseLineItemDocumentStatus [attribute]	1091
RFQResponseLineItemPriceDetail	1091
RFQResponseLineItemStatusType [attribute]	1092
RFQResponseLineItemStatusTypeText	1092
RFQResponseNumber	1092
RFQResponseReference	1093
RFQResponseReferenceType [attribute]	1093
RFQResponseStatusType [attribute]	1094
RFQResponseSummary	1095
RFQResponseValidityDate	1097
RFQStatusType [attribute]	1097
RFQSummary	1098
RFQType [attribute]	1098
RGB	1099
Ribbon	1100
RibbonExposure	1100
RibbonFacingType [attribute]	1100
RibbonMaterialCharacteristics	1101
RingCrush	1102
RoadAccessibilityType [attribute]	1103
RoadAvailability	1103
RoadBearingCapacity	1104
RoadBearingCapacityType [attribute]	1104
RoadCharacteristics	1105
RoadClassification	1106
RoadClassificationCode	1107
RoadClassificationDescription	1107
RoadKeeperType [attribute]	1107
RoadName	1107
RoadNumber	1107
RoadObstruction	1108
RoadObstructionType [attribute]	1109
RoadOwnerType [attribute]	1110
RoadPassingPossibility [attribute]	1110
RoadSlopePercent	1110
RoadTurningPointType [attribute]	1110
RoadTurningPossibilityType [attribute]	1110
Roof	1111
RoofingSidingDeckingFencing	1111
RoofPackage	1112
RoofPanel	1112
RoofTruss	1112
Roughness	1113
RoundCornered [attribute]	1114
Route	1114
RouteComment	1115
RouteDefinition	1116
RouteDefinitionFormat [attribute]	1116
RouteLeg	1116
RouteLegLength	1117

papiNet V2R31

RouteLegName.....	1117
RouteLegNumber.....	1118
RouteLength.....	1118
RouteName.....	1118
RouteType [attribute].....	1118
RowsPerUnit.....	1119
RunnabilityIndex.....	1119
SafetyAndEnvironmentalCertification.....	1120
SafetyAndEnvironmentalInformation.....	1121
SafetyAndEnvironmentalType [attribute].....	1122
SalesOfficeParty.....	1124
SampleSize.....	1125
SampleType [attribute].....	1125
Saturation.....	1126
Sawdust.....	1127
ScaleHouseID.....	1128
ScaleHouseIn.....	1128
ScaleHouseInfo.....	1129
ScaleHouseName.....	1130
ScaleHouseOut.....	1130
ScaleHouseTicketNumber.....	1131
ScalerID.....	1131
ScalerName.....	1131
ScaleTicket.....	1132
ScaleTicketAcceptance [attribute].....	1133
ScaleTicketHeader.....	1134
ScaleTicketIssueDate.....	1136
ScaleTicketLineItem.....	1137
ScaleTicketLineNumber.....	1138
ScaleTicketNumber.....	1138
ScaleTicketReference.....	1138
ScaleTicketReferenceType [attribute].....	1139
ScaleTicketRejectedType [attribute].....	1139
ScaleTicketStatusType [attribute].....	1140
ScaleTicketSummary.....	1141
Scored [attribute].....	1141
Screened [attribute].....	1142
Seasoning.....	1142
SeasoningType [attribute].....	1142
Secure [attribute].....	1143
SenderParty.....	1143
SenderProductAttributesDescription.....	1144
SenderProductAttributesIdentifier.....	1144
SenderProductAttributesName.....	1144
SequenceNumber.....	1145
ServiceLevel.....	1145
ServiceLevelContextType [attribute].....	1145
ServiceLevelReference.....	1146
ServiceLevelReferenceType [attribute].....	1146
ServiceLevelText.....	1146
ShapeOfHole [attribute].....	1146
SetNumber.....	1147
SetPosition.....	1147
ShapeOfHole [attribute].....	1147
Sheet.....	1147
SheetConcern.....	1148
SheetConcernCode.....	1148
SheetConcernDescription.....	1149
SheetConcernType [attribute].....	1149

papiNet V2R31

SheetConversionCharacteristics	1150
SheetCount	1151
SheetCountMethodType [attribute]	1152
SheeterConcerns	1152
SheeterConditions	1153
SheetItem	1153
SheetPackagingCharacteristics	1155
SheetSize	1156
ShellColour	1157
ShellType [attribute]	1157
ShipFromCharacteristics	1157
ShipFromParty	1158
ShipmentComplete [attribute]	1159
ShipmentDetails	1159
ShipmentDetailsType [attribute]	1160
ShipmentEventDate	1160
ShipmentEventDuration	1161
ShipmentEventIdentifier	1161
ShipmentEventInformation	1162
ShipmentEventQualifierType [attribute]	1163
ShipmentEventReference	1164
ShipmentEventReferenceType [attribute]	1164
ShipmentEventType [attribute]	1164
ShipmentID	1165
ShipmentIDType [attribute]	1165
ShipmentIncident	1166
ShipmentIncidentAccountability	1167
ShipmentIncidentCategory	1167
ShipmentIncidentCause	1168
ShipmentIncidentCode	1169
ShipmentIncidentDate	1170
ShipmentIncidentPartOfSupplyChain	1170
ShipmentLoadDetails	1171
ShipmentMethodOfPayment	1173
ShipmentStatus	1173
ShipmentStatusDate	1174
ShipmentStatusDescription	1174
ShipmentStatusHeader	1175
ShipmentStatusIdentifier	1176
ShipmentStatusIssueDate	1176
ShipmentStatusNumber	1177
ShipmentStatusReference	1177
ShipmentStatusReferenceType [attribute]	1177
ShipmentStatusRequestDetail	1178
ShipmentStatusSearchReference	1179
ShipmentStatusSearchReferenceType [attribute]	1179
ShipmentStatusShipment	1180
ShipmentStatusType [attribute]	1181
ShipmentSummary	1182
ShippingInstructions	1183
ShippingInstructionsConfirmationIssuedDate	1184
ShippingInstructionsHeader	1185
ShippingInstructionsHeaderStatusType [attribute]	1186
ShippingInstructionsInformation	1187
ShippingInstructionsIssuedDate	1188
ShippingInstructionsLineItemByProduct	1189
ShippingInstructionsLineItemByShipTo	1190
ShippingInstructionsLineItemNumber	1192
ShippingInstructionsLineItemStatusType [attribute]	1192

papiNet V2R31

ShippingInstructionsNumber	1192
ShippingInstructionsPurchaseOrderLineItem	1193
ShippingInstructionsReference	1193
ShippingInstructionsReferenceType [attribute]	1194
ShippingInstructionsRequestDetail	1195
ShippingInstructionsStatusType [attribute]	1196
ShippingInstructionsSummary	1196
ShippingInstructionsType [attribute]	1197
ShippingMark	1197
ShipToCharacteristics	1197
ShipToInformation	1198
ShipToParty	1199
ShowThrough	1200
Side	1201
SideOneTime	1202
SideTwoTime	1202
SignatureID	1202
Signatures	1202
SingleWidthReel	1202
SingleWidthReelConversionCharacteristics	1203
SizeOfHolePunch	1204
Sizing	1205
Sleeve	1206
SleeveInsertType	1206
Slide	1207
SlideContainerDescription	1208
SlideContainerMail	1208
SlideMailerSizeDescription	1208
SlideMountCaptions [attribute]	1209
SlideMountDescription	1209
SlideMountMaterial	1209
SlideMountNumbering [attribute]	1209
SlidesPerPage	1209
SlitReel	1210
SlitReelLineNumber	1210
SlitReelOrderQuantity	1211
SlitReelReference	1212
SlitReelReferenceType [attribute]	1212
SlitReelsInSet	1212
SlitReelWidth	1213
Slurry	1213
SmallEndDiameter	1214
Smoothness	1215
SoftwoodLumber	1216
SoftwoodLumberCharacteristics	1217
SoftwoodPlywood	1220
SpanRating	1222
SpecAssembly	1223
SpecAssemblyType [attribute]	1224
SpecBinding	1225
SpecComponent	1228
SpecGeneral	1230
SpecGroupingID	1231
SpeciesAgency [attribute]	1231
SpeciesCode	1232
SpeciesOrigin [attribute]	1232
SpeciesType [attribute]	1233
SpecificationNumber	1238
SpecInformation	1238

papiNet V2R31

SpecIssueDate	1238
SpecPacking	1239
SpecReference	1240
SpecReferenceType [attribute]	1241
SpecStatusType [attribute]	1241
SpecType [attribute]	1241
SpecVersion.....	1242
SpeedType [attribute]	1242
SpineLabel [attribute]	1242
SpineLabel [attribute]	1242
SpineSize	1242
StackingMethod	1243
StacksPerPallet	1243
StandardDeviation	1243
StandardSpacing	1243
StartIdentifierRange	1243
Statement	1244
StatementDetail	1245
StatementHeader	1247
StatementInformation.....	1248
StatementNumber	1249
StatementRequestDetail	1249
StatementRequestType [attribute]	1250
StatementResponseDate	1250
StatementType [attribute]	1251
StateOrProvince	1251
StateOrProvince [attribute]	1251
StatisticalGoodsInformation	1251
Status [attribute]	1252
StatusAsOfDate.....	1252
StencilCharacteristics	1253
StencilContent [attribute]	1254
StencilFormat [attribute]	1256
StencilInkType [attribute].....	1256
StencilLocation [attribute]	1257
StencilText	1257
StencilType [attribute]	1257
Stiffness.....	1258
StopOffInformation.....	1259
StrengthGroup	1259
Stretch	1260
SubClassification	1261
SubClassificationCode	1261
SupersType [attribute]	1262
Supplemental.....	1262
SupplementalSpecification [attribute]	1262
SuppliedComponentFinishSpecs.....	1263
SuppliedComponentInformation.....	1264
SuppliedComponentReference	1266
SuppliedComponentReferenceType [attribute]	1266
SuppliedComponentType [attribute]	1266
SupplierCustomsReference.....	1267
SupplierCustomsReferenceType [attribute]	1267
SupplierMarks	1267
SupplierOrderLineItemNumber	1268
SupplierOrderNumber	1268
SupplierParty	1268
SupplyPoint	1269
SupplyPointCode	1269

papiNet V2R31

SupplyPointDescription	1270
Surface	1270
SurfaceStrength	1271
SurfaceType [attribute]	1272
Tabs [attribute]	1272
TambourID	1273
TapeDescription	1273
TargetMoisture	1273
TargetProductWeight	1273
TargetSolidsContent	1274
TaxAdjustment	1275
TaxAmount	1276
TaxCategoryType [attribute]	1276
TaxLocation	1276
TaxPercent	1276
TaxStatement	1277
TaxStatementCode	1277
TaxStatementDescription	1277
TaxType [attribute]	1278
TEA	1279
Tear	1280
TearIndex	1282
TearStripType [attribute]	1283
Telephone	1283
Tensile	1284
TensileIndex	1285
Tension	1286
TermsAndDisclaimers	1287
TermsBasisDate	1287
TermsBasisDateType [attribute]	1288
TermsDescription	1289
TermsDiscountDaysDue	1289
TermsDiscountDueDate	1289
TermsDiscountPercent	1290
TermsInformation	1290
TermsInterestPenaltyPercent	1291
TermsNetDaysDue	1291
TermsNetDueDate	1291
TermsOfChartering	1292
TermsOfCharteringType [attribute]	1292
TermsOfDelivery	1292
TermsOfPayment	1294
TermsOfPaymentCode	1295
TestAgency [attribute]	1295
TestMethod [attribute]	1296
TextValue	1296
Thickness	1297
Thickness	1298
Thumb	1298
TiersPerPallet	1299
TimberCharacteristics	1299
Time	1299
TimePeriod	1300
TimeSlot	1301
TimeSlotAvailability [attribute]	1301
TimeSlotInformation	1301
To	1302
ToProduct	1302
TopSide [attribute]	1304

papiNet V2R31

TotalAdjustments	1304
TotalAmount	1304
TotalBlanketOrderValue	1304
TotalFASAmount	1305
TotalInformationalAmount	1305
TotalInformationalQuantity	1306
TotalNetAmount	1307
TotalNetOfTermsDiscount	1308
TotalNumberOfLineItems	1309
TotalNumberOfPackingListItems	1309
TotalNumberOfPackingListPackingUnits	1309
TotalNumberOfSequences	1309
TotalNumberOfShipments	1309
TotalNumberOfUnits	1309
TotalOldInformationalQuantity	1310
TotalOldQuantity	1312
TotalOpenAmount	1313
TotalPageCount	1313
TotalPaymentAmount	1313
TotalQuantity	1314
TotalQuantityInformation	1315
TotalRunningLength	1316
TotalSetNumbers	1317
TotalSetPositions	1317
TotalTaxAmount	1317
TotalTermsDiscountAmount	1317
TotalTermsDiscountAmountDue	1317
TotalTermsDiscountNetAmount	1318
TotalTermsDiscountNetAmountDue	1318
TotalTermsDiscountNetAmountTax	1318
TotalTermsDiscountTaxAmount	1319
TotalTime	1319
TrackingReferenceID	1319
TrackingReferenceIDType [attribute]	1320
TrackType [attribute]	1320
TradeRegion	1320
TransactionHistoryConfirmationNumber	1320
TransactionHistoryNumber	1321
TransportationComment	1321
TransportContextType [attribute]	1321
TransportDeckOption [attribute]	1321
TransportInformation	1322
TransportInstructionCode	1323
TransportInstructionText	1323
TransportInstructionType [attribute]	1324
TransportLoadingCharacteristics	1324
TransportLoadingCode	1325
TransportLoadingCodeDescription	1326
TransportLoadingText	1326
TransportLoadingType [attribute]	1326
TransportModeCharacteristics	1327
TransportModeCode	1327
TransportModeText	1328
TransportModeType [attribute]	1328
TransportOtherInstructions	1329
TransportPackageInformation	1330
TransportPropertyType [attribute]	1332
TransportPropertyValue	1333
TransportStatus	1334

papiNet V2R31

TransportStatusIssueDate.....	1334
TransportUnitCharacteristics	1335
TransportUnitCode.....	1336
TransportUnitCount	1336
TransportUnitDetail.....	1337
TransportUnitDetailCode.....	1337
TransportUnitDetailType [attribute].....	1338
TransportUnitEquipment	1340
TransportUnitEquipmentCode	1340
TransportUnitEquipmentDescription	1341
TransportUnitHeight	1341
TransportUnitIdentifier	1342
TransportUnitIdentifierType [attribute]	1342
TransportUnitLength	1343
TransportUnitLevel [attribute]	1344
TransportUnitMeasurements.....	1344
TransportUnitText.....	1345
TransportUnitType [attribute].....	1345
TransportUnitVariable [attribute]	1346
TransportUnitWeight	1346
TransportUnitWidth.....	1347
TransportUnloadingCharacteristics	1347
TransportUnloadingCode.....	1348
TransportUnloadingCodeDescription	1348
TransportUnloadingText	1349
TransportUnloadingType [attribute].....	1349
TransportVehicleCharacteristics	1350
TransportVehicleCode	1351
TransportVehicleCount	1351
TransportVehicleEquipment.....	1351
TransportVehicleEquipmentCode.....	1351
TransportVehicleEquipmentDescription	1352
TransportVehicleHeight	1352
TransportVehicleIdentifier.....	1353
TransportVehicleIdentifierType [attribute].....	1353
TransportVehicleLength	1354
TransportVehicleMeasurements	1355
TransportVehicleText	1355
TransportVehicleType [attribute]	1355
TransportVehicleWeight.....	1356
TransportVehicleWidth	1357
TrayColourType [attribute]	1357
TreeSpeciesGroup	1358
TreeSpeciesGroupCode.....	1358
TreeSpeciesGroupDescription	1358
Trim	1358
TrimmedOrderType.....	1359
TrimmedReel	1359
TrimmedReelConversionCharacteristics.....	1360
TrimSize	1361
TrimType [attribute]	1361
TwoSigmaLower	1362
TwoSigmaUpper	1362
UnCompletedMeasurement [attribute].....	1362
UnevenSpacing	1362
UnitCharacteristics.....	1363
UnitDimension	1363
UnitItem	1364
UnitReference	1365

papiNet V2R31

UnitReferenceType [attribute]	1366
UnitsPerCarton	1366
UOM [attribute]	1366
URL	1374
URLContext [attribute]	1374
Usage	1375
UsageHeader	1376
UsageHeaderReference	1377
UsageIssuedDate	1378
UsageLineItem	1379
UsageLineItemDetail	1380
UsageLineItemNumber	1381
UsageNumber	1381
UsageReference	1382
UsageReferenceType [attribute]	1382
UsageStatus [attribute]	1382
UsageStatusType [attribute]	1383
UsageSummary	1384
ValidityPeriod	1384
Value	1385
VarianceType [attribute]	1385
VideoCassette	1386
VideoCassetteCaseType [attribute]	1387
VideoFormatType [attribute]	1387
VirginFibre	1388
Viscosity	1389
Wall	1390
WallPackage	1390
WallPanel	1390
WasteImpressions	1391
WasteQuantity	1391
WasteType [attribute]	1391
Watermark	1392
WatermarkCode	1392
WatermarkDescription	1392
Webbing	1392
WebBreak	1393
WebBreakCause	1393
WebBreakCauseAgency [attribute]	1394
WebBreakCauseCode	1398
WebBreakCauseType [attribute]	1398
WebBreakDate	1399
WebBreakDescription	1399
WebBreaks	1399
WebBreakType [attribute]	1400
WebConcerns	1400
WebConfiguration	1400
Week	1400
Weight	1401
Whiteness	1402
Width	1403
Width	1404
Width	1405
WindingDirection	1405
WireCoating [attribute]	1406
WireGauge	1406
WireMaterial	1406
WithGrain [attribute]	1407
WoodBasedPanelGrade	1407

papiNet V2R31

WoodItem	1408
WoodPanelCharacteristics.....	1409
WoodPanelManufacturingMethod.....	1410
WoodPanelProducts	1411
WoodPanelSpecies	1412
WoodProducts	1413
WoodTimbersDimensionalLumberBoards	1414
Wrap	1415
WrapCharacteristics	1416
WrapLocation [attribute]	1416
WrapProperties [attribute]	1416
WrapType [attribute]	1417
Year	1417
Yellow.....	1418

Data Dictionary: papiNet Version 2.31

a

The "a" portion of the method of colour represented by L*a*b.

(sequence)

The sequence of items below is mandatory. A single instance is required.

DetailValue

DetailValue is mandatory. A single instance is required.

A numeric value expressed in the unit of measure (UOM).

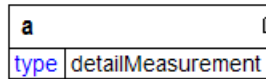

DetailRangeMin

DetailRangeMin is optional. A single instance might exist.

The minimum value (lower boundary) allowed for the DetailValue that is the parent of this element.

DetailRangeMax

DetailRangeMax is optional. A single instance might exist.

The maximum value (upper boundary) allowed for the DetailValue that is the parent of this element.

StandardDeviation

StandardDeviation is optional. A single instance might exist.

A statistic used as a measure of dispersion in a distribution.

SampleSize

SampleSize is optional. A single instance might exist.

The number of samples used to determine the product characteristic in question.

TwoSigmaLower

TwoSigmaLower is optional. A single instance might exist.

Two sigma (a measure of dispersion associated with standard deviation) on the lower side of the standard deviation.

TwoSigmaUpper

TwoSigmaUpper is optional. A single instance might exist.

Two sigma (a measure of dispersion associated with standard deviation) on the upper side of the standard deviation.

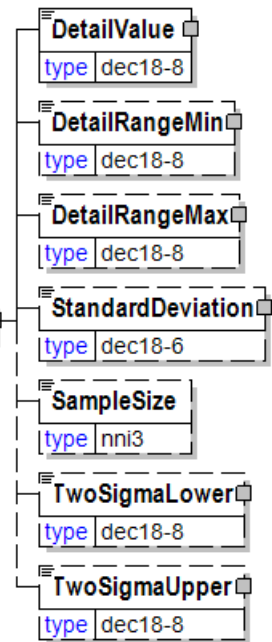

Abrasion

A group item used to communicate abrasion loss target or test value.

TestMethod [attribute]

TestMethod is optional. A single instance might exist.

The method used to determine the results of the test under consideration.

TestAgency [attribute]

TestAgency is optional. A single instance might exist.

The agency that has set the parameters for the testing

Refer to TestAgency definition for any enumerations.

SampleType [attribute]

SampleType is optional. A single instance might exist.

Communicates how sampling was done to measure the product characteristics.

Refer to SampleType definition for any enumerations.

ResultSource [attribute]

ResultSource is optional. A single instance might exist.

Used to define the data source of the specified test

Refer to ResultSource definition for any enumerations.

(sequence)

The sequence of items below is mandatory. A single instance is required.

DetailValue

DetailValue is mandatory. A single instance is required.

A numeric value expressed in the unit of measure (UOM).

DetailRangeMin

DetailRangeMin is optional. A single instance might exist.

The minimum value (lower boundary) allowed for the DetailValue that is the parent of this element.

DetailRangeMax

DetailRangeMax is optional. A single instance might exist.

The maximum value (upper boundary) allowed for the DetailValue that is the parent of this element.

StandardDeviation

StandardDeviation is optional. A single instance might exist.

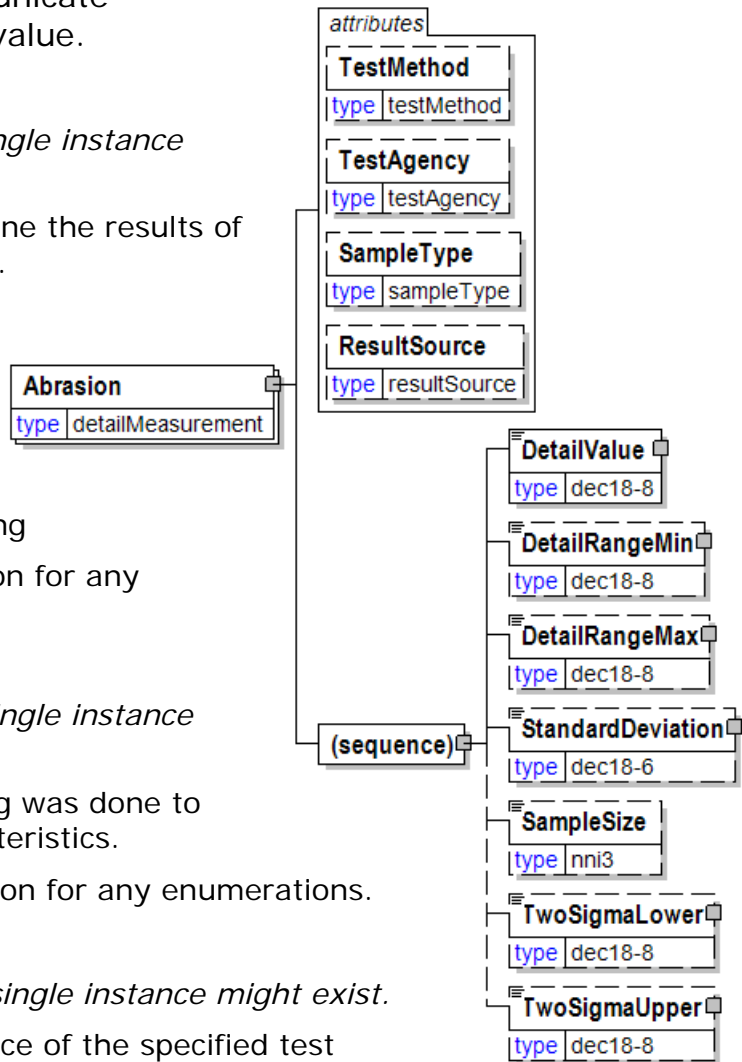

papiNet V2R31

A statistic used as a measure of dispersion in a distribution.

SampleSize

SampleSize is optional. A single instance might exist.

The number of samples used to determine the product characteristic in question.

TwoSigmaLower

TwoSigmaLower is optional. A single instance might exist.

Two sigma (a measure of dispersion associated with standard deviation) on the lower side of the standard deviation.

TwoSigmaUpper

TwoSigmaUpper is optional. A single instance might exist.

Two sigma (a measure of dispersion associated with standard deviation) on the upper side of the standard deviation.

AbsorptionInk

A group item used to communicate ink absorption target or test value.

TestMethod [attribute]

TestMethod is optional. A single instance might exist.

The method used to determine the results of the test under consideration.

TestAgency [attribute]

TestAgency is optional. A single instance might exist.

The agency that has set the parameters for the testing

Refer to TestAgency definition for any enumerations.

SampleType [attribute]

SampleType is optional. A single instance might exist.

Communicates how sampling was done to measure the product characteristics.

Refer to SampleType definition for any enumerations.

ResultSource [attribute]

ResultSource is optional. A single instance might exist.

Used to define the data source of the specified test

Refer to ResultSource definition for any enumerations.

(sequence)

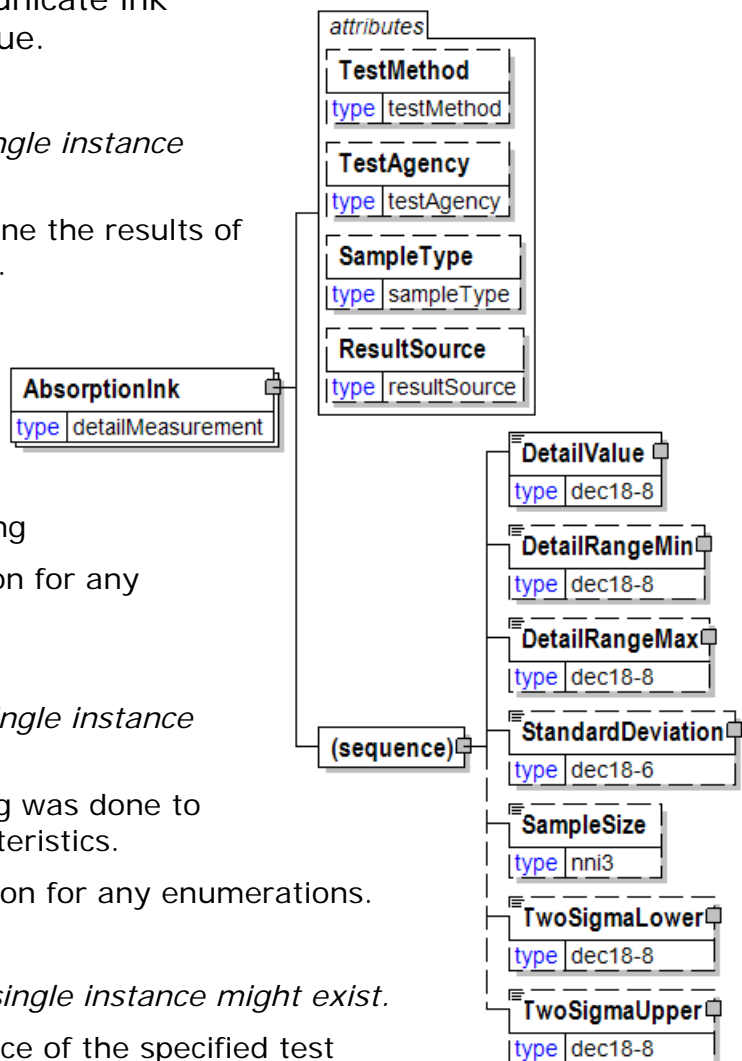

papiNet V2R31

The sequence of items below is mandatory. A single instance is required.

DetailValue

DetailValue is mandatory. A single instance is required.

A numeric value expressed in the unit of measure (UOM).

DetailRangeMin

DetailRangeMin is optional. A single instance might exist.

The minimum value (lower boundary) allowed for the DetailValue that is the parent of this element.

DetailRangeMax

DetailRangeMax is optional. A single instance might exist.

The maximum value (upper boundary) allowed for the DetailValue that is the parent of this element.

StandardDeviation

StandardDeviation is optional. A single instance might exist.

A statistic used as a measure of dispersion in a distribution.

SampleSize

SampleSize is optional. A single instance might exist.

The number of samples used to determine the product characteristic in question.

TwoSigmaLower

TwoSigmaLower is optional. A single instance might exist.

Two sigma (a measure of dispersion associated with standard deviation) on the lower side of the standard deviation.

TwoSigmaUpper

TwoSigmaUpper is optional. A single instance might exist.

Two sigma (a measure of dispersion associated with standard deviation) on the upper side of the standard deviation.

AbsorptionLight

A group item used to communicate light absorption target or test value.

TestMethod [attribute]

TestMethod is optional. A single instance might exist.

The method used to determine the results of the test under consideration.

TestAgency [attribute]

TestAgency is optional. A single instance might exist.

The agency that has set the parameters for the testing

Refer to TestAgency definition for any enumerations.

SampleType [attribute]

SampleType is optional. A single instance might exist.

Communicates how sampling was done to measure the product characteristics.

Refer to SampleType definition for any enumerations.

ResultSource [attribute]

ResultSource is optional. A single instance might exist.

Used to define the data source of the specified test

Refer to ResultSource definition for any enumerations.

(sequence)

The sequence of items below is mandatory. A single instance is required.

DetailValue

DetailValue is mandatory. A single instance is required.

A numeric value expressed in the unit of measure (UOM).

DetailRangeMin

DetailRangeMin is optional. A single instance might exist.

The minimum value (lower boundary) allowed for the DetailValue that is the parent of this element.

DetailRangeMax

DetailRangeMax is optional. A single instance might exist.

The maximum value (upper boundary) allowed for the DetailValue that is the parent of this element.

StandardDeviation

StandardDeviation is optional. A single instance might exist.

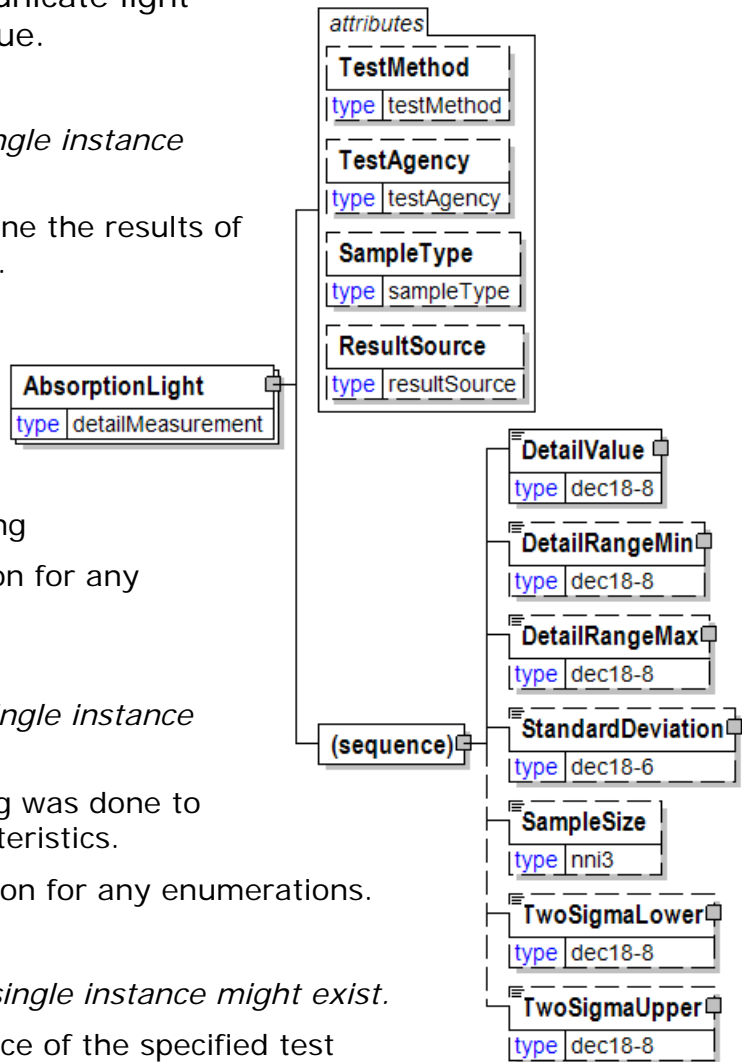

A statistic used as a measure of dispersion in a distribution.

SampleSize

SampleSize is optional. A single instance might exist.

The number of samples used to determine the product characteristic in question.

TwoSigmaLower

TwoSigmaLower is optional. A single instance might exist.

Two sigma (a measure of dispersion associated with standard deviation) on the lower side of the standard deviation.

TwoSigmaUpper

TwoSigmaUpper is optional. A single instance might exist.

Two sigma (a measure of dispersion associated with standard deviation) on the upper side of the standard deviation.

AbsorptionWater

A group item used to communicate water absorption target or test value.

TestMethod [attribute]

TestMethod is optional. A single instance might exist.

The method used to determine the results of the test under consideration.

TestAgency [attribute]

TestAgency is optional. A single instance might exist.

The agency that has set the parameters for the testing

Refer to TestAgency definition for any enumerations.

SampleType [attribute]

SampleType is optional. A single instance might exist.

Communicates how sampling was done to measure the product characteristics.

Refer to SampleType definition for any enumerations.

ResultSource [attribute]

ResultSource is optional. A single instance might exist.

Used to define the data source of the specified test

Refer to ResultSource definition for any enumerations.

(sequence)

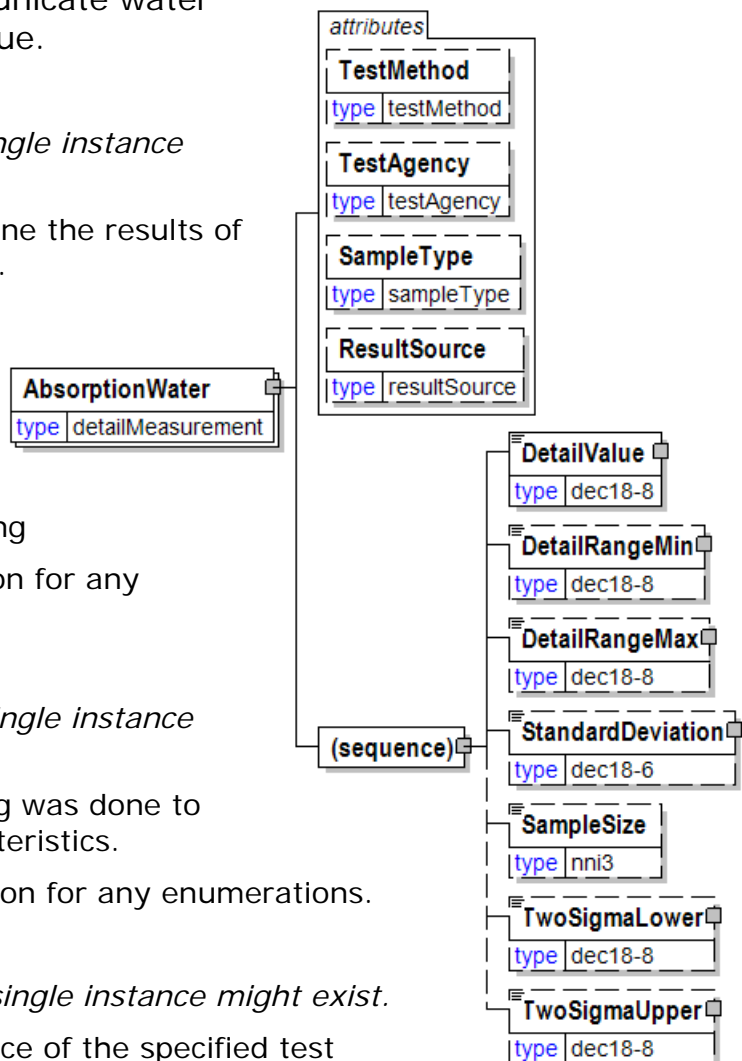

papiNet V2R31

The sequence of items below is mandatory. A single instance is required.

DetailValue

DetailValue is mandatory. A single instance is required.

A numeric value expressed in the unit of measure (UOM).

DetailRangeMin

DetailRangeMin is optional. A single instance might exist.

The minimum value (lower boundary) allowed for the DetailValue that is the parent of this element.

DetailRangeMax

DetailRangeMax is optional. A single instance might exist.

The maximum value (upper boundary) allowed for the DetailValue that is the parent of this element.

StandardDeviation

StandardDeviation is optional. A single instance might exist.

A statistic used as a measure of dispersion in a distribution.

SampleSize

SampleSize is optional. A single instance might exist.

The number of samples used to determine the product characteristic in question.

TwoSigmaLower

TwoSigmaLower is optional. A single instance might exist.

Two sigma (a measure of dispersion associated with standard deviation) on the lower side of the standard deviation.

TwoSigmaUpper

TwoSigmaUpper is optional. A single instance might exist.

Two sigma (a measure of dispersion associated with standard deviation) on the upper side of the standard deviation.

ActionType [attribute]

Used to trigger an action concerning the element to which it refers.

This item is restricted to the following list.

Special

Specifies that an action is required.

Standard

Specifies that no action is required.

attribute	
ActionType	
type	actionType
default	Standard

ActualNominal [attribute]

Indicates the measurement approach used to communicate the dimensions of the individual pieces.

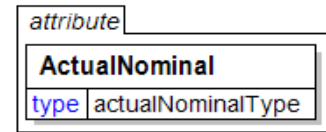

This item is restricted to the following list.

Actual

The measurement approach is based on the actual dimensions of the piece.

Covering

The measurement approach is based on an overlay of the piece.

Modal

The measurement approach is based on statistical data.

Nominal

A stated value rather than the actual value.

AdditionalTest

AdditionalTest exists to enable the inclusion of a test that has not been identified by papiNet.org. It is always a single-instance element so it is very important that users, who come upon a test that papiNet.org has not identified, communicate the need for this test to us at www.papiNet.org.

TestMethod [attribute]

TestMethod is optional. A single instance might exist.

The method used to determine the results of the test under consideration.

TestAgency [attribute]

TestAgency is optional. A single instance might exist.

The agency that has set the parameters for the testing

Refer to TestAgency definition for any enumerations.

SampleType [attribute]

SampleType is optional. A single instance might exist.

Communicates how sampling was done to measure the product characteristics.

Refer to SampleType definition for any enumerations.

ResultSource [attribute]

ResultSource is optional. A single instance might exist.

Used to define the data source of the specified test

Refer to ResultSource definition for any enumerations.

(sequence)

The sequence of items below is mandatory. A single instance is required.

AdditionalTestName

AdditionalTestName is mandatory. A single instance is required.

The name of the additional test being communicated in the product definition.

DetailValue

DetailValue is mandatory. A single instance is required.

A numeric value expressed in the unit of measure (UOM).

DetailRangeMin

DetailRangeMin is optional. A single instance might exist.

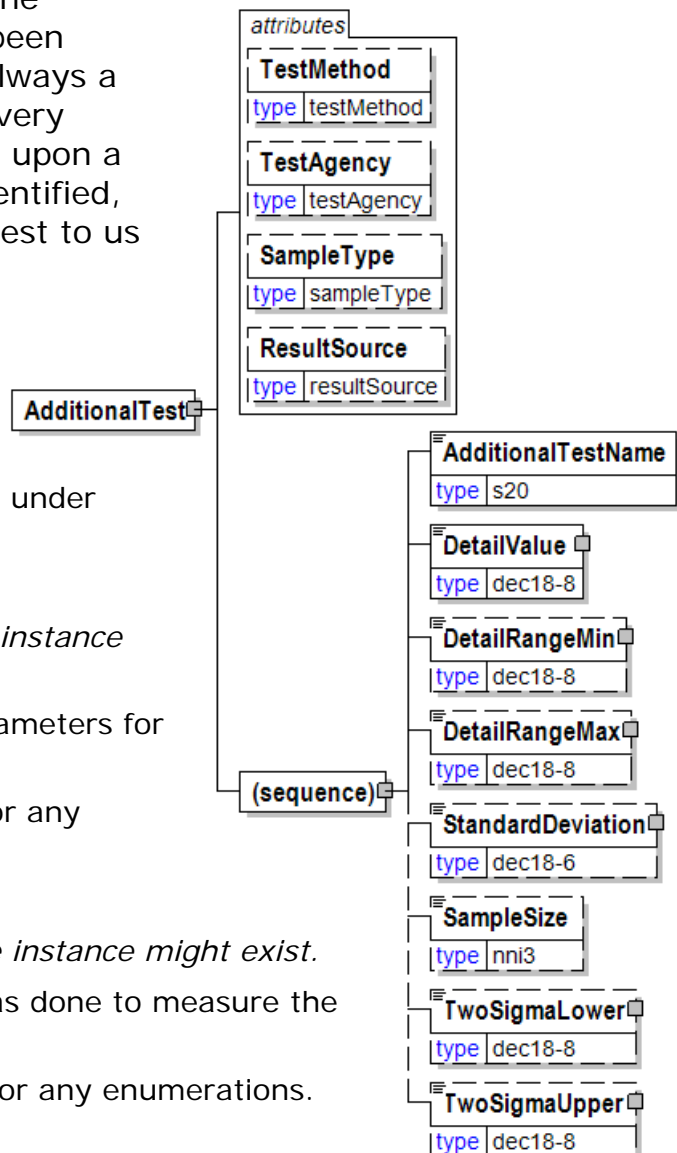

papiNet V2R31

The minimum value (lower boundary) allowed for the DetailValue that is the parent of this element.

DetailRangeMax

DetailRangeMax is optional. A single instance might exist.

The maximum value (upper boundary) allowed for the DetailValue that is the parent of this element.

StandardDeviation

StandardDeviation is optional. A single instance might exist.

A statistic used as a measure of dispersion in a distribution.

SampleSize

SampleSize is optional. A single instance might exist.

The number of samples used to determine the product characteristic in question.

TwoSigmaLower

TwoSigmaLower is optional. A single instance might exist.

Two sigma (a measure of dispersion associated with standard deviation) on the lower side of the standard deviation.

TwoSigmaUpper

TwoSigmaUpper is optional. A single instance might exist.

Two sigma (a measure of dispersion associated with standard deviation) on the upper side of the standard deviation.

AdditionalTestName

The name of the additional test being communicated in the product definition.

AdditionalTestName	
type	s20

AdditionalText

A text field that is used to communicate information not previously defined or for special instructions. To be used only for circumstances not covered by specific elements.

AdditionalText	
type	s255

Address1

The primary-level address of an organisation or business entity (for example, street name, and number).

Address1	
type	s60

Address2

The second-level address of an organisation or business entity.

Address2	
type	s60

Address3

The third-level address of an organisation or business entity.

Address3	
type	s60

Address4

The fourth-level address of an organisation or business entity.

Address4	
type	s60

AdjustmentFixedAmount

A fixed monetary amount, either negative or positive, that is the value of the adjustment being applied in an instance of the MonetaryAdjustment structure.

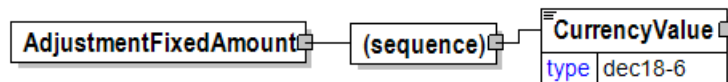

(sequence)

The sequence of items below is mandatory. A single instance is required.

CurrencyValue

CurrencyValue is mandatory. A single instance is required.

The amount in the referenced currency as defined by the CurrencyType attribute.

AdjustmentPercentage

A percentage, either negative or positive, that is applied to either the price, or a starting amount to determine the value of the particular MonetaryAdjustment.

(sequence)

The sequence of items below is mandatory. A single instance is required.

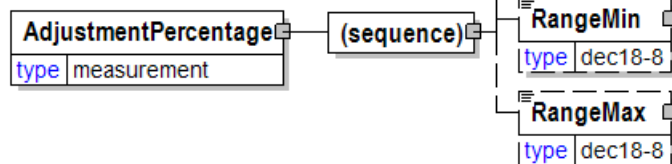

Value

Value is mandatory. A single instance is required.

A numeric value expressed in the unit of measure (UOM).

RangeMin

RangeMin is optional. A single instance might exist.

The minimum value (lower boundary) allowed for the Measurement that is the parent of this element.

RangeMax

RangeMax is optional. A single instance might exist.

The maximum value (upper boundary) allowed for the Measurement that is the parent of this element. Some elements use the RangeMax element with an extended list of unit of measures. (Note: the red colour in the picture is an artifact of how the graphic was captured and should be disregarded.)

AdjustmentType (Financial) [attribute]

Describes the type of adjustment applied to a monetary oriented element. Adjustment values should always be given as negative or positive adjustments even if AdjustmentType indicates the sign. For example, a rebate of 1% on an Invoice should be given as an adjustment percentage of -1%.

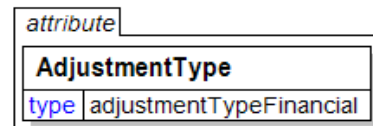

This item is restricted to the following list.

BillOfLadingCharge

An extra charge for creating a Bill of Lading.

CancellationCharge

A charge applied because a cancellation was late (after the last date of change) and all or part of the ordered product has already been made.

CashDiscount

A reduction due to a discount applied.

CertificateCharge

An extra charge for creating a certificate. Some countries requires Certificates in which different characteristics of the delivery, transport unit, route, product, and others must be proved.

There are certificates for gasen pallets, for the place of production, for the age of the ship/vessel, for not departing from one country's harbour when delivering to another.

ChargesForward

A pending Invoice amount brought forward from a previous Invoice.

ClaimAdjustment

An adjustment related to a filed complaint.

Commission

Commission costs paid to the trading agency or trader.

CompetitiveAllowance

An allowance provided for competitive reasons.

CongestionCharge

An extra fee from ports for waiting time of ships in ports, railcars on a siding, trucks at a dock. (Synonym: Demurrage.)

ConsigneeUnloadCharge

An unloading charge that is the responsibility of the consignee.

ContractAllowance

An allowance for a volume discount, usually because the agreed amount has been exceeded.

CurrencyAdjustmentCharge

An extra fee to adjust for currency variations.

DecimalRounding

Adjustments for rounding of amounts to fit the business agreement or national monetary legislation. This adjustment is typically used for decimal rounding of amounts not including tax.

N.B. Use InformationalAmount with AmountType "DecimalRounding" for specification of decimal rounding of amounts including tax.

DefectiveAllowance

An allowance provided for defective material.

DeliveryCharge

The charge for delivering the product.

DeliveryNonConformanceAllowance

An allowance due to non-conformance with the purchase agreement regarding a delivery.

DeliveryTimeBonus

A bonus given for deliveries of products within a certain time period.

EarlyShipAllowance

An allowance due to a delivery that took place earlier than planned. The seller may be charged a penalty. If this is found before issuing the Invoice, it can be handled through this allowance. If found later, it will be handled through a credit note.

EnergySurcharge

A charge related to increases in the cost of energy.

Environmental

An allowance applied due to environmental regulations.

ExpeditedShipmentCharge

An extra cost charged due to unexpected or emergency requirements (for example, breaking off a run in the mill to reach the production date for a rush order).

ExportClearanceCharge

An extra fee for customs administration.

FlatRateCharge

A general flat charge.

FreightAllowance

The freight cost allowed by the mill. This amount is negative, and will be deducted from the Invoice (U.S. business practice, in the European Union (EU), use only Freight Charge).

FreightCharge

The actual cost incurred to deliver the product. This amount is positive, and will be added to the Invoice.

FuelAdjustmentCharge

An extra fee, usually from shipping companies, to adjust fuel prices.

HandlingCharge

A charge related to the handling of the product.

Inspection

The cost associated with performing an inspection of the product.

InterestCharge

A charge applied for interest on overdue payments.

LabourAllowance

An allowance due to additional labour required in the use or acceptance of the product.

LabourCharge

A charge due to additional labour required in the use or acceptance of the product.

LoggingDamage

An adjustment caused by logging damages on Forest Wood products. Logging damages normally cause a reduction of the product price.

LotCharge

A charge applied to the lot of material.

MetalDetection

A charge for additional metal detection applied to the goods.

ModelHomeDiscount

A discount associated with the building of the model home.

NewStoreCouponDiscount

A discount associated with entry into a new store.

OrderQuantity

A charge or allowance for small/big ordered quantities.

PalletCharge

A charge that represents the cost or rental of the pallet.

PickUpAllowance

An allowance provided to compensate for the cost of picking up the product.

PromotionalAllowance

An allowance provided for the promotion of the product.

PromotionalCharge

A charge associated with the promotion of the product.

PriceCorrection

An adjustment associated with a correction of the product's price.

ProductionSetUpCharge

A special charge applied due to specific buyer requests.

Provision

The act of making ready or equipping for use.

Rebate

A rebate accepted by the buyer and seller based on the agreed price and volume.

ReelDiscount

An allowance for purchasing reels instead of sheets.

ReturnedLoadAllowance

An allowance applied due to the return of the load.

ReturnLoadCharge

A charge applied due to the return of the load.

RoadFeeCharge

A freight charge for a special tax applied to road transports in some countries, e.g. Germany

ScrapAndDunnageCharge

A charge that represents the scrapping of the material and its removal.

ServiceCharge

A charge associated with a miscellaneous service.

SpecialConversionCharge

Additional charge for a special conversion of the product.

SpecialDeliveryCharge

A special charge for delivering the product differently from the usual or agreed-to method.

SpecialHandlingCharge

A special charge for handling the product differently from the usual or agreed-to method.

SpecialPackagingCharge

A special charge for packaging the product differently from the usual or agreed-to method, or if packaging as requested is out of spec.

StopOffAllowance

An allowance for a delivery stop-off.

StopOffCharge

A charge for a delivery stop-off.

StorageAllowance

An allowance for storing the product.

StorageCharge

An extra cost charged for storing the product on location (in the plant).

Tax

An adjustment that reflects a tax item.

TestingCharge

A charge related to testing a paper grade.

TradeDiscount

A discount based on the terms of the trade given on the agreed price. Usually a percentage.

TrialDiscount

A discount applied for a trial run of a new or improved product.

TransferCharge

A freight charge incurred by the goods transfer from one location to another location not previously agreed upon.

UnloadingAllowance

An allowance to compensate for the unloading the product.

UnloadingCharge

A charge for the unloading the product.

VolumeDiscount

A rebate accepted by the buyer and the seller based on the agreed volume

WarRiskCharge

An extra fee from transport companies for transport units that cross war zones.

Other

Any other adjustment not covered by the attribute list.

AdjustmentType (Tare) [attribute]

Describes the type of adjustment associated with a quantity.

This item is restricted to the following list.

attribute
AdjustmentType
type adjustmentTypeTare

Advances

Product samples that are typically used by the Publisher sales people as product samples in the selling cycle.

Core

The adjustment is describing the core.

Ends

The volume of short pieces for calculation of the "ends discount". In the timber

business traditionally 'ends' refers to a time when ships were stowed tightly. Short timber pieces were used in this job and customers were given a discount because of the possible damage to these pieces. Today short lengths are in some cases sold for lower price because folks can't use these efficiently (short lengths are between 1.8 - 2.4 m).

Excess

The adjustment is describing a quantity that is the difference between the actual quantity and the contractual quantity. An Excess quantity can e.g. occur when actual dimensions are greater than contractual dimensions.

IncludesOverage

Quantity contains an amount over the order quantity for purposes of spoilage and contractual overproduction.

Example: PO to Printer/Binder has an order quantity of 10,000 and there is a supplied component for the cover under one of the line-items with a quantity of 10,800. Including the AdjustmentType attribute with a setting of IncludesOverage explains the difference in the order quantity for the book vs. the supplied component quantity.

IncludesPlannedOverProduction

The adjustment is describing a quantity that is a planned overrun production of the component or product.

MeasuringCorrection

The adjustment is describing a correction that is based on measuring statistics for populations of products.

None

Used to indicate that there is no adjustment. (Typically used in the scenario where trading partners always want to communicate an adjustment type attribute.)

Pallet

The adjustment is describing the pallet.

Reduction

The adjustment is describing a quantity that is reduced from the actual quantity because of inappropriate content, e.g. a log pile containing snow, ice or logging residues.

Samples

Product samples that are sent to the buyer as an example of the production.

SchoolAdoption

The adjustment is describing text books that will be used by the school districts in that state.

Straps

The adjustment is describing the straps.

Total

The adjustment is describing the total adjustments.

Wrap

The weight adjustment value is the weight of the wrapper for a reel, the weight of a box for a box of reams, or the weight of any wrapping applied to a pallet.

WrapCore

The adjustment is describing the wrapping plus the core

AdjustmentTypeReason

Provides additional information about the type of adjustment. Can be viewed as a sub-classification of the adjustment type attribute or as a textual explanation.

AdjustmentTypeReason
type s255

AdjustmentValue

A group element that contains a currency value, either positive or negative, and a measurement value (in other words a price per unit structure) that will be used in the price adjustment AdjustmentValue.

(sequence)

The sequence of items below is mandatory. A single instance is required.

AdjustmentValue
type pricePerUnit

(sequence)

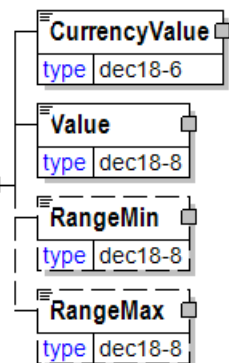

CurrencyValue

CurrencyValue is mandatory. A single instance is required.

The amount in the referenced currency as defined by the CurrencyType attribute.

Value

Value is mandatory. A single instance is required.

A numeric value expressed in the unit of measure (UOM).

RangeMin

RangeMin is optional. A single instance might exist.

The minimum value (lower boundary) allowed for the Measurement that is the parent of this element.

RangeMax

RangeMax is optional. A single instance might exist.

The maximum value (upper boundary) allowed for the Measurement that is the parent of this element. Some elements use the RangeMax element with an extended list of unit of measures. (Note: the red colour in the picture is an artifact of how the graphic was captured and should be disregarded.)

Age

Used to report the age of the wood.

(sequence)

The sequence of items below is mandatory. A single instance is required.

Value

Value is mandatory. A single instance is required.

A numeric value expressed in the unit of measure (UOM).

RangeMin

RangeMin is optional. A single instance might exist.

The minimum value (lower boundary) allowed for the Measurement that is the parent of this element.

RangeMax

RangeMax is optional. A single instance might exist.

The maximum value (upper boundary) allowed for the Measurement that is the parent of this element. Some elements use the RangeMax element with an extended list of unit of measures. (Note: the red colour in the picture is an artifact of how the graphic was captured and should be disregarded.)

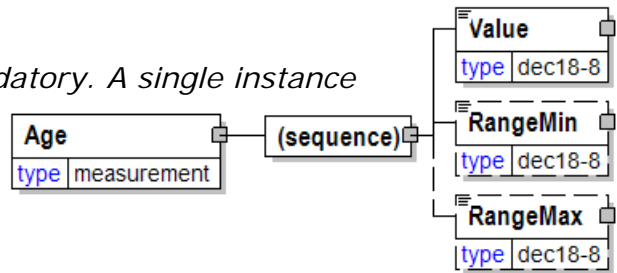

Agency [attribute]

Describes the agency maintaining the list of codes. To be included in this list the agency must be a recognized standards body or industry organisation.

For the element that owns this attribute.

For another attribute in the list of attributes associated with the parent element.

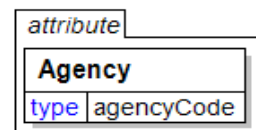

This item is restricted to the following list.

AFPA

American Forest and Paper Association.

ANSI

American National Standards Institute.

APPITA

Technical Association of the Australian and NZ Pulp and Paper Industry

ATA

ATA (American Truckers Association)

BISAC

Book Industry Study Group

Bowker

The agency that issues the StandardAddressNumber (www.bowker.com).

BSI

British Standards Institute (refer to bsi-global.com for more information).

Buyer

The buyer has defined the codes used in the particular element of the transaction. Care must be used when using this agency to assure that the recipient of the e-Document understands what is being communicated. (Not to be used for logistics buyer, see LogisticsBuyer.)

Carrier

The carrier has defined the codes used in the particular element of the transaction. Care must be used when using this agency to assure that the recipient of the e-Document understands what is being communicated.

CCTI

Composite Can and Tube Institute

CEN

European Committee for Standardisation (<http://www.cenorm.be>)

CEPI

Confederation of European Paper Industries.

CoSe

Agency for the the wood processing industry. (www.commonsense.at)

Customs

Any customs agency.

DUNS

Dun & Bradstreet.

EAN

European Article Numbering Agency.

ECTA-EPCA-CEFIC

European Chemical Transport Association, European Petrochemical Association, European Chemical Council. Information about the joint guidelines developed by these agencies can be found at www.ecta.be.

EndUser

The end-user has defined the codes used in the particular element of the transaction. Care must be used when using this agency to assure that the recipient of the e-Document understands what is being communicated

FINFO

Article numbering agency and system in some Nordic countries for all building products. (www.finno.se)

Forwarder

The OtherParty indicated by party type "Forwarder" or when communicating OrderStatus the party indicated by ForwarderParty.

FSC

Forest Stewardship Council

GCA

Graphic Communications Association. (This agency now calls itself IDEAlliance.)

GCA-CCTI

The GCA and CCTI combined coding

GOST

Russian federal agency on technical regulating and metrology
(<http://www.gost.ru>)

IFRA

INCA FIEJ Research Association (Technical Research and Consulting Association for the Newspaper Industry).

Intrastat

The agency responsible for collecting statistics on the physical trade of goods between the members of the EU.

ISO

International Organisation for Standardisation.

ISRI

Institute of Scrap Recycling Industries

LogisticsBuyer

The buyer of the logistics service has defined the codes used in the particular element of the transaction. Care must be used when using this agency to assure that the recipient of the e-Document understands what is being communicated.

LogisticsSeller

The seller of the logistics service has defined the codes used in the particular element of the transaction. Care must be used when using this agency to assure that the recipient of the e-Document understands what is being communicated.

LogisticsSupplier

The supplier of the logistics service has defined the codes used in the particular element of the transaction. Care must be used when using this agency to assure that the recipient of the e-Document understands what is being communicated.

Mill

The OtherParty indicated by party type "Mill" or when available the party indicated by MillParty.

NOBB

Norwegian Building Products database, (Norsk ByggvareBase)

NMFTA

National Motor Freight Traffic Association (NMFTA)

NPTA

National Paper Trade Association.

Ondule

European Association of Corrugated Base Papers Manufacturers (actually Ondule).

PEFC

www.pefc.org

PMS

Pantone Matching System is a colour matching system that is widely used in the book industry. See www.pantone.com for more information.

PPPC

Pulp and Paper Products Council

Publisher

The person, company or organization responsible for placing a book, journal, or other publication on the market (as opposed to the printer or bookseller); also referred to as the "buyer".

RASI

Article numbering agency and system in Finland for building products. (www.rasi.fi)

RevenueCanada

Canadian Revenue Agency. See www.cra.gc.ca

RVR

Agency maintaining codes for the German wood supply segment. RVR is the abbreviation for "RahmenVereinbarung für den Rohholzhandel in Deutschland". (www.rvr-deutschland.de).

SD

Agency maintaining codes for the Norwegian wood supply segment (www.skogdata.no).

SDC

Agency maintaining codes for the Swedish wood supply segment (www.sdc.se).

Seller

The seller of the product has defined the codes used in the particular element of the transaction. Care must be used when using this agency to assure that the recipient of the e-Document understands what is being communicated. (Not to be used for logistics seller, see LogisticsSeller.)

Supplier

The supplier has defined the codes used in the particular element of the transaction. Care must be used when using this agency to assure that the recipient of the e-Document understands what is being communicated. (Not to be used for logistics supplier, see LogisticsSupplier.)

TAPPI

Technical Association for the Paper and Pulp Industry

UCC

The Uniform Code Council.

UIC

International Union of Railways. (<http://www.uic.org>)
(Union Internationale des Chemins de fer)

UN/ECE

The United Nations – Economic Commission for Europe

WarehouseOperator

WCO

World Customs Organization (refer to wcoomd.org for more information).

XBITS

XML Book Industry Transaction Standards

Other

Used when the agency responsible for a coding system is not defined in the attribute list, or there is no agency responsible for the codes used.

AggregatedUsageLineItem

A group item that summarises item usage at the Product level or at the Product plus PurchaseOrder level. Details concerning the individual items used are not included.

(sequence)

The sequence of items below is mandatory. A single instance is required.

Product

Product is

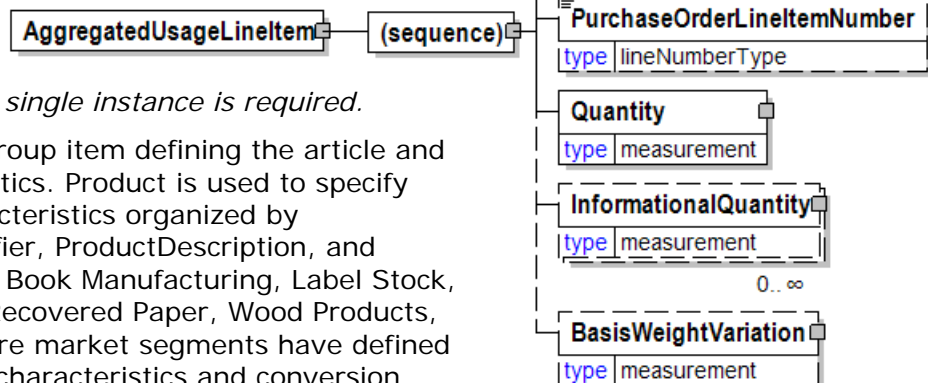

mandatory. A single instance is required.

Product is a group item defining the article and its characteristics. Product is used to specify product characteristics organized by ProductIdentifier, ProductDescription, and Classification. Book Manufacturing, Label Stock, Paper, Pulp, Recovered Paper, Wood Products, and Virgin Fibre market segments have defined their product characteristics and conversion features for implementation in papiNet.

OtherParty

OtherParty is optional. Multiple instances might exist.

An organisation or business entity other than those specifically detailed within a e-

Document.

PurchaseOrderInformation

PurchaseOrderInformation is optional. A single instance might exist.

A group item containing information unique to this PurchaseOrder, which is provided by the buyer. PurchaseOrderInformation can be optional in the supply chain. Invoices are created without having a PurchaseOrder in Vendor Managed Inventory. Freight invoices also will not have a PurchaseOrder number.

PurchaseOrderLineItemNumber

PurchaseOrderLineItemNumber is optional. A single instance might exist.

The sequential number that uniquely identifies the PurchaseOrder line item.

Quantity

Quantity is mandatory. A single instance is required.

The Quantity element contains attributes that provide information about the type of quantity that is being communicated, the context in which the particular quantity is to be viewed, and (if the quantity represents an adjustment) an adjustment type.

The Quantity element contains three child elements that enable you to communicate a range of values for the quantity and a target or actual value. It is at this level (Value, RangeMin, and RangeMax) that the unit of measure is specified. This permits the range to be specified in a different unit of measure than the target.

InformationalQuantity

InformationalQuantity is optional. Multiple instances might exist.

A quantity given in a valid UOM used for information purposes only (not for calculation). For example, an ordered quantity was 100 reels as opposed to the invoice quantity of 20,000 pounds.

BasisWeightVariation

BasisWeightVariation is optional. A single instance might exist.

BasisWeightVariation is the measured difference between the mill target basis weight and the mill actual basis weight.

Alignment

A measurement of how the reel is aligned on printing press

(sequence)

The sequence of items below is mandatory. A single instance is required.

Value

Value is mandatory. A single instance is required.

A numeric value expressed in the unit of measure (UOM).

RangeMin

RangeMin is optional. A single instance might exist.

The minimum value (lower boundary) allowed for the Measurement that is the parent of this element.

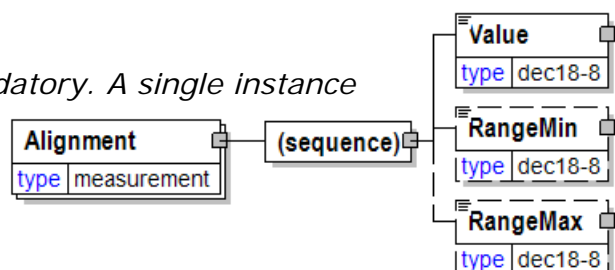

RangeMax

RangeMax is optional. A single instance might exist.

The maximum value (upper boundary) allowed for the Measurement that is the parent of this element. Some elements use the RangeMax element with an extended list of unit of measures. (Note: the red colour in the picture is an artifact of how the graphic was captured and should be disregarded.)

Altitude

The height of a location above a ground reference point as specified by the map reference system.

(sequence)

The sequence of items below is mandatory. A single instance is required.

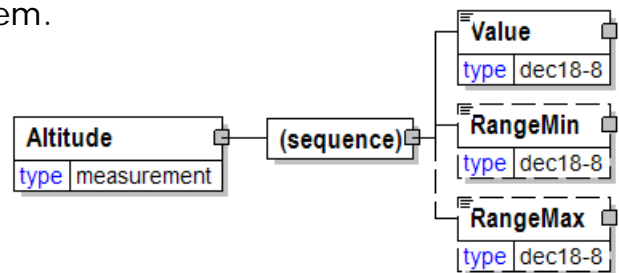

Value

Value is mandatory. A single instance is required.

A numeric value expressed in the unit of measure (UOM).

RangeMin

RangeMin is optional. A single instance might exist.

The minimum value (lower boundary) allowed for the Measurement that is the parent of this element.

RangeMax

RangeMax is optional. A single instance might exist.

The maximum value (upper boundary) allowed for the Measurement that is the parent of this element. Some elements use the RangeMax element with an extended list of unit of measures. (Note: the red colour in the picture is an artifact of how the graphic was captured and should be disregarded.)

AmbientTemperature

The temperature of the surrounding environment.

(sequence)

The sequence of items below is mandatory. A single instance is required.

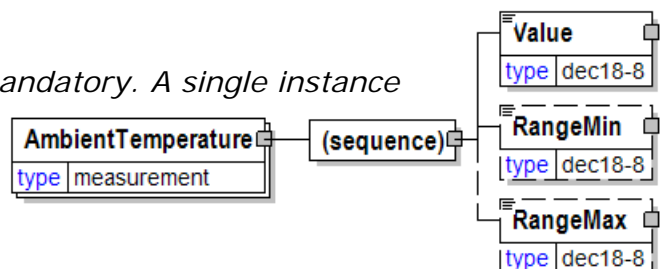

Value

Value is mandatory. A single instance is required.

A numeric value expressed in the unit of measure (UOM).

RangeMin

RangeMin is optional. A single instance might exist.

The minimum value (lower boundary) allowed for the Measurement that is the parent of this element.

RangeMax

RangeMax is optional. A single instance might exist.

The maximum value (upper boundary) allowed for the Measurement that is the parent of this element. Some elements use the RangeMax element with an extended list of unit of measures. (Note: the red colour in the picture is an artifact of how the graphic was captured and should be disregarded.)

Amount

An element that contains the amount including tax. The Amount encapsulates CurrencyValue.

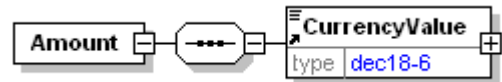

(sequence)

The sequence of items below is mandatory. A single instance is required.

CurrencyValue

CurrencyValue is mandatory. A single instance is required.

The amount in the referenced currency as defined by the CurrencyType attribute.

AmountSubjectToTermsDiscount

The amount against which prompt payment terms can be applied.

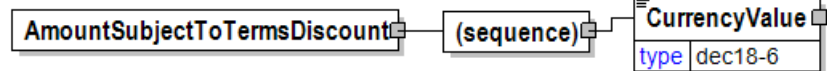

(sequence)

The sequence of items below is mandatory. A single instance is required.

CurrencyValue

CurrencyValue is mandatory. A single instance is required.

The amount in the referenced currency as defined by the CurrencyType attribute.

AmountType [attribute]

Defines the type of amount.

This item is restricted to the following list.

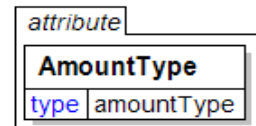

Adjustment

Adjustment amount, i.e. the sum of all instances of PriceAdjustment and FlatAmountAdjustment but excluding tax amounts.

DecimalRounding

Amount applied for decimal rounding of amounts due for payment.

For example, Finland does not use smaller than 5 cent coins. All cash payments are rounded to a 5 cent divisible amount according to national legislation. Alternatively, certain market segments prefer to remove all decimals.

Net

Net amount, i.e. an amount excluding tax

Tax

Tax amount

TermsDiscountNet

The prompt payment discount amount excluding tax.

Total

Total amount, i.e. an amount including tax.

Appearance

A group item used to communicate appearance.

TestMethod [attribute]

TestMethod is optional. A single instance might exist.

The method used to determine the results of the test under consideration.

TestAgency [attribute]

TestAgency is optional. A single instance might exist.

The agency that has set the parameters for the testing

Refer to TestAgency definition for any enumerations.

SampleType [attribute]

SampleType is optional. A single instance might exist.

Communicates how sampling was done to measure the product characteristics.

Refer to SampleType definition for any enumerations.

ResultSource [attribute]

ResultSource is optional. A single instance might exist.

Used to define the data source of the specified test

Refer to ResultSource definition for any enumerations.

(sequence)

The sequence of items below is mandatory. A single instance is required.

DetailValue

DetailValue is mandatory. A single instance is required.

A numeric value expressed in the unit of measure (UOM).

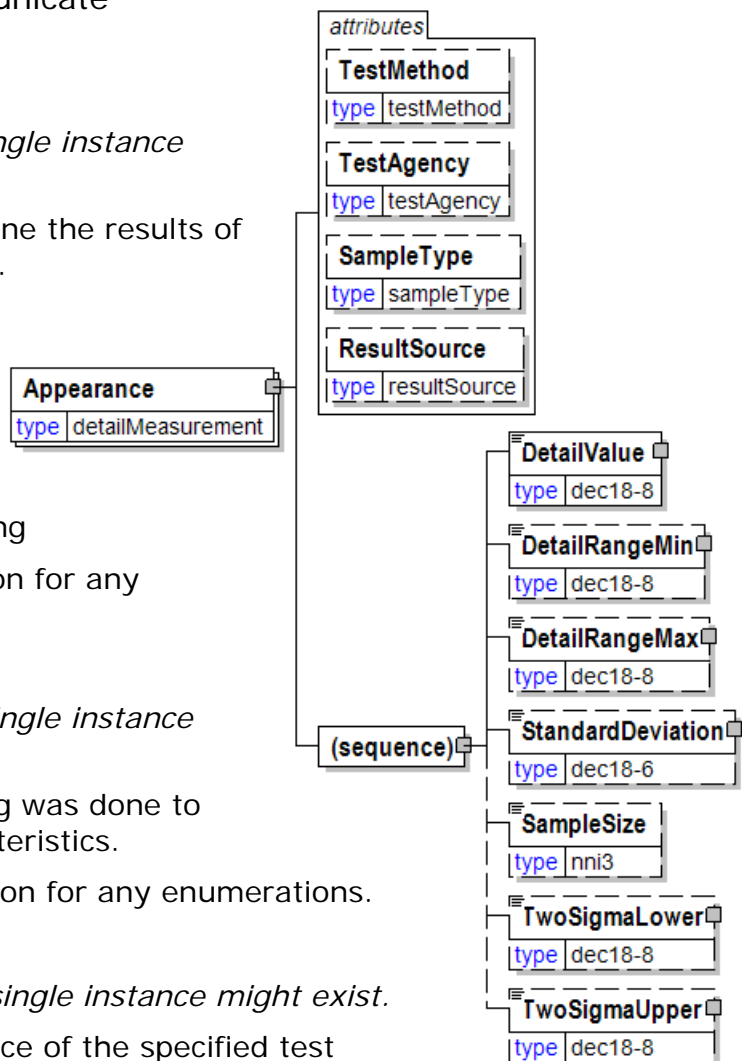

DetailRangeMin

DetailRangeMin is optional. A single instance might exist.

The minimum value (lower boundary) allowed for the DetailValue that is the parent of this element.

DetailRangeMax

DetailRangeMax is optional. A single instance might exist.

The maximum value (upper boundary) allowed for the DetailValue that is the parent of this element.

StandardDeviation

StandardDeviation is optional. A single instance might exist.

A statistic used as a measure of dispersion in a distribution.

SampleSize

SampleSize is optional. A single instance might exist.

The number of samples used to determine the product characteristic in question.

TwoSigmaLower

TwoSigmaLower is optional. A single instance might exist.

Two sigma (a measure of dispersion associated with standard deviation) on the lower side of the standard deviation.

TwoSigmaUpper

TwoSigmaUpper is optional. A single instance might exist.

Two sigma (a measure of dispersion associated with standard deviation) on the upper side of the standard deviation.

AppliesTo [attribute]

Specifies the type of item to which measurements apply to.

This item is restricted to the following list.

Payload

Measurements apply to the payload.

Unit

Measurements apply to the transport unit.

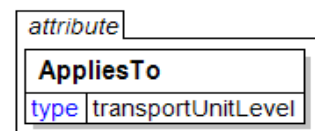

ArrivalDate

The date of arrival.

(sequence)

The sequence of items below is mandatory. A single instance is required.

Date

Date is mandatory. A single instance is required.

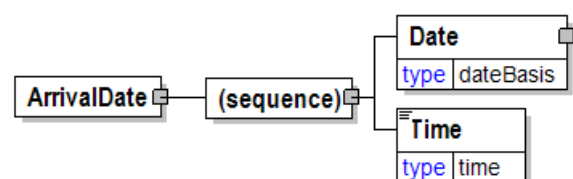

papiNet V2R31

A group element that contains the specification of Year, Month, and Day.

Time

Time is mandatory. A single instance is required.

Times are treated in a standard XML fashion with a special case used to indicate a generalized "local" time. The standard XML approach to time is hh:mm:ss, hh:mm:ssZ, or hh:mm:ss±hh:mm.

hh:mm:ss±hh:mm is used to represent a time with a time zone. The time zone is communicated as the number of hours offset from the Universal Time Coordinate (UTC), a.k.a. Greenwich Mean Time.

hh:mm:ssZ indicates the time at Zulu (another name for UTC). Based on the convention described in the next bullet it will be important for users within UTC to use "Z" when communicating a time in their time zone to other users.

hh:mm:ss or hh:mm indicates in the XML standard the time at UTC however, within papiNet it is used to represent the applicable local time. Caution should be used when processing times of this nature as the papiNet approach may be in discord with other users of XML.

Ash

A group item used to communicate the ash content of the product according to a particular TestMethod.

TestMethod [attribute]

TestMethod is optional. A single instance might exist.

The method used to determine the results of the test under consideration.

TestAgency [attribute]

TestAgency is optional. A single instance might exist.

The agency that has set the parameters for the testing

Refer to TestAgency definition for any enumerations.

SampleType [attribute]

SampleType is optional. A single instance might exist.

Communicates how sampling was done to measure the product characteristics.

Refer to SampleType definition for any enumerations.

ResultSource [attribute]

ResultSource is optional. A single instance might exist.

Used to define the data source of the specified test

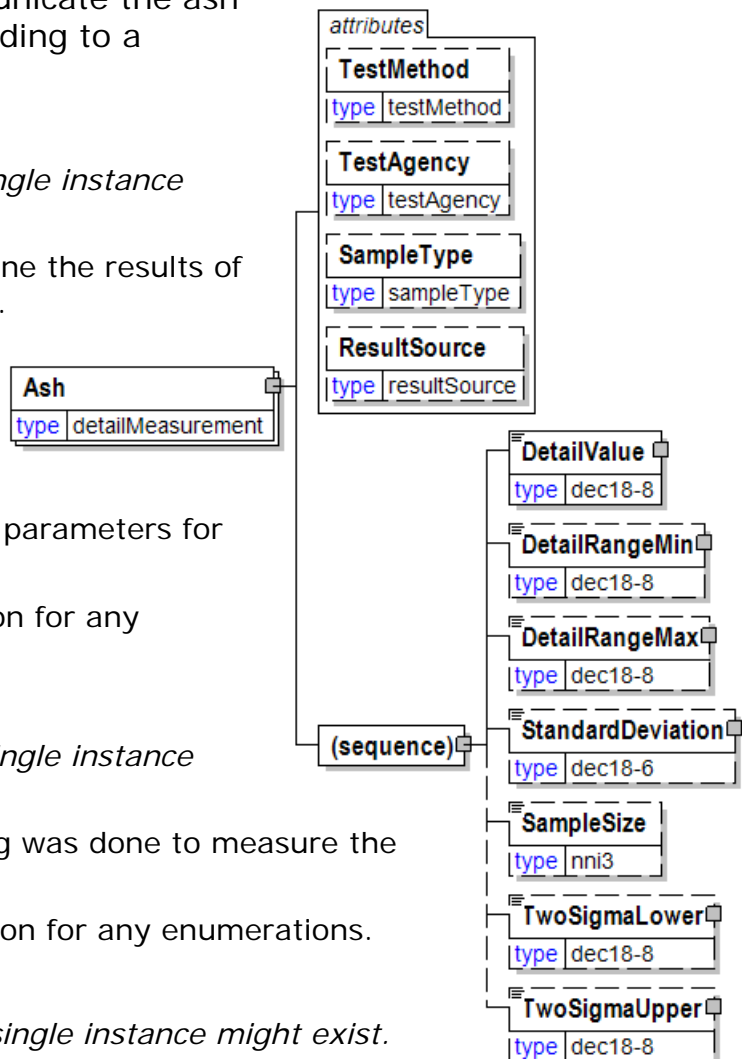

papiNet V2R31

Refer to ResultSource definition for any enumerations.

(sequence)

The sequence of items below is mandatory. A single instance is required.

DetailValue

DetailValue is mandatory. A single instance is required.

A numeric value expressed in the unit of measure (UOM).

DetailRangeMin

DetailRangeMin is optional. A single instance might exist.

The minimum value (lower boundary) allowed for the DetailValue that is the parent of this element.

DetailRangeMax

DetailRangeMax is optional. A single instance might exist.

The maximum value (upper boundary) allowed for the DetailValue that is the parent of this element.

StandardDeviation

StandardDeviation is optional. A single instance might exist.

A statistic used as a measure of dispersion in a distribution.

SampleSize

SampleSize is optional. A single instance might exist.

The number of samples used to determine the product characteristic in question.

TwoSigmaLower

TwoSigmaLower is optional. A single instance might exist.

Two sigma (a measure of dispersion associated with standard deviation) on the lower side of the standard deviation.

TwoSigmaUpper

TwoSigmaUpper is optional. A single instance might exist.

Two sigma (a measure of dispersion associated with standard deviation) on the upper side of the standard deviation.

AssemblyInstructions

Instructions for assembly.

AssemblyInstructions	
type	s255

AssemblyType [attribute]

Assembly type

This item is restricted to the following list.

AVC

BulkPack

attribute	
AssemblyType	
type	assemblyType

Capsule
CDBookStyle
CDOSleeve
CDWallet
CO/CR/CF-1
CO/CR/CF-2
CO/CR/CF-3
CO/CR/CF-4
CPN1
CPN2
CPN3
CPN4
DCN1
DCN2
ICanRead
OCard
PVCBag
UAB
UAS6
UAS8

AssignedBy [attribute]

Identifies the type of party that has assigned the associated item, e.g. a reference of type OrderNumber.

This item is restricted to the following list.

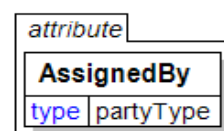

Auditor

A third party that is authorized for making audits and checkings.

Bank

The banking representative.

BillTo

The address where the Invoice is to be sent. (Not to be used for logistics BillTo, see LogisticsBillTo.)

BorderCrossing

A geographic location separating two countries authorised to validate customs documentation.

Broker

The organisation acting as a broker for the buyer or supplier.

Buyer

The legal entity to which the product is sold. Also commonly referred to as the sold-to party or customer. If no OtherParty is defined as the "Payer", the "Buyer" is the "Payer". (Not to be used for logistics buyer, see LogisticsBuyer.)

BuyerAgent

The entity acting for the buyer in the transaction. (Not to be used for logistics BuyerAgent, see LogisticsBuyerAgent.)

Carrier

The organisation or business entity that transports goods.

CarrierAssignmentResponsible

The organisation to which the carrier has assigned some task.

ComponentVendor

Vendor producing supplied components.

Consignee

To be deprecated in version 3.0 (no date determined). Use LogisticsRole attribute to communicate this information.

Consignor

To be deprecated in version 3.0 (no date determined). Use LogisticsRole attribute to communicate this information.

Consuming

The eventual consumer of the material

Converter

The organisation responsible for changing one form of paper into another form, providing specialised functions not available to the supplier.

CreditDepartment

The party responsible for credit authorization.

CrossDock

A third party involved in the transport of goods.

CustomerFacility

The type of the origin or destination location of a transport leg in a route is a buyer facility, usually a print site, or a warehouse owned by the buyer.

CustomerStock

A "virtual" location that indicates that the material is owned by the customer.

Customs

Any customs agency.

CustomsForwarder

A forwarder responsible for managing the transfer of goods through customs.

DomesticForwarder

A forwarder responsible for managing the transfer of goods.

EndUser

EndUser is the party using, consuming, or converting the product. For example, a printer using paper reels to print a job for a publisher (printer is the end user). The final ShipTo destination for a product is normally to the EndUser facilities.

ExportForwarder

A forwarder responsible for managing the export process.

ForestForwarder

The party responsible for transporting forest wood products from logging areas to roadside landings.

ForestHarvester

The party responsible for harvesting of forest wood products at logging areas.

Forwarder

The party responsible for shipping arrangements.

FreightPayer

The party responsible for paying freight.

Insurer

The party providing insurance coverage for the goods.

Landowner

The party who owns the land upon which the product was produced.

LoadingOperator

A party that is carrying out loading of transport units.

LoggingArea

A geographic location in the forest where logging takes place.

LogisticsBillTo

The address where the logistics Invoice is to be sent.

LogisticsBuyer

The buyer of logistics services. The legal entity to which the service is sold. Also commonly referred to as the sold-to party or customer. If no OtherParty is defined as the "LogisticsPayer", the "LogisticsBuyer" is the payer.

LogisticsBuyerAgent

The entity acting for the logistics buyer in the transaction.

LogisticsSeller

The seller of logistics services. LogisticsSupplier is the seller of the service, if logistics seller is not specified as OtherParty = LogisticsSeller

LogisticsSupplier

The party responsible for providing the service. LogisticsSupplier is also the seller of the service, if logistics seller is not specified as OtherParty = LogisticsSeller

LogisticsPayee

The party handling and receiving logistics payments on behalf of another party.

LogisticsPayer

The party handling and sending logistics payments of behalf of another party.

MainCarrier

The primary carrier involved in the movement of goods.

Measurer

The party that's carrying out the measurement of the products quantity and/or quality. The party is doing this for example on behalf of both the buyer and seller and the result can be used as basis for invoicing.

Merchant

A third party buying and reselling products.

Mill

A production facility.

NotifyParty

A party that needs to be notified of the status of the transaction.

OnBehalfOf

The activity in question is being made on behalf of this party.

OrderParty

The organisation or business entity placing the order if different from the buyer party.

OriginalSupplier

The first supplier in a supply chain. OriginalSupplier is only intended to identify the business party, not the origin of the product.

Payee

The party handling and receiving payments on behalf of another party. (Not to be used for logistics payee, see LogisticsPayee.)

Payer

The party handling and sending payments of behalf of another party. (Not to be used for logistics payer, see LogisticsPayer.)

PlaceFinalDestination

The final destination of the goods.

PlaceOfAccept

The location where acceptance of the goods is to take place.

PlaceOfDespatch

The location where despatch took place.

PlaceOfDischarge

The location where the goods were unloaded.

PlaceOfLoading

The location where loading is to or took place.

PlaceOfMeasuring

The location where the products are measured.

PlaceOfReloading

A location where the goods were transferred from one transport type to another.

Port

The type of the origin or destination location of a transport leg in a route. It is a maritime location.

PreCarrier

The party responsible for activities prior to carrier accepting the goods (but after shipping has taken place).

PrinterFacility

The location of the printer who will be using the product.

ProFormal nvoice

The organisation or business entity to which the pro-forma Invoice will be sent.

Producer

The manufacturer of the goods.

RemitTo

The organisation or business entity to which payment will be made.

Requestor

The originator of the original PurchaseOrder requisition (for example, a printing plant ordering through a central purchasing organisation).

RoadKeeper

The party who is responsible for the maintenance of the road.

RoadOwner

The party who is the legal owner of the road.

SalesAgent

The organisation or person responsible for product sales acting on behalf of the seller.

SalesOffice

The functional unit in an organisation or business entity that is responsible for product sales.

Seller

The seller of the product. SupplierParty is the seller of the product, if Seller is not specified as OtherParty = Seller. (Not to be used for logistics seller, see LogisticsSeller.)

ShipFromLocation

The location the goods were shipped from.

ShipOwner

The owner of the vessel used to ship the goods.

ShipTo

The address the material should be shipped to.

SubCarrier

A sub carrier of another the shipping company.

Supplier

The organisation or business entity responsible for providing the product. SupplierParty is also the seller of the product, if Seller is not specified as OtherParty = Seller. (Not to be used for logistics supplier, see LogisticsSupplier.)

Terminal

The type of the origin or destination location of a transport leg in a route. It can be a sea, road or rail terminal.

TerminalOperator

The party providing facilities such as loading, unloading, or warehousing.

UnloadingOperator

A party that is carrying out unloading of transport units.

Warehouse

A storage location. It can be the origin or destination location of a transport leg in a route.

WillAdvise

Indicates that party will be identified at a later time

Other

Any other organisation or business entity that may get involved in the transaction and that is not covered by the list.

AttachmentFileName

The name of the attached file.

AttachmentFileName
type s60

AudioCassette

Audio cassette

SpineLabel [attribute]

SpineLabel is optional. A single instance might exist.

Is there a spine label?

Refer to SpineLabel definition for any enumerations.

NoiseReduction [attribute]

NoiseReduction is optional. A single instance might exist.

The noise reduction method

Refer to NoiseReduction definition for any enumerations.

DuplicationRatio [attribute]

DuplicationRatio is optional. A single instance might exist.

Duplication ratio

Any valid string

TrackType [attribute]

TrackType is optional. A single instance might exist.

The type of track

Refer to TrackType definition for any enumerations.

Tabs [attribute]

Tabs is optional. A single instance might exist.

The type of tabs

Refer to Tabs definition for any enumerations.

AudioCassetteCaseType [attribute]

AudioCassetteCaseType is optional. A single instance might exist.

Describes the type of audio cassette case.

Refer to AudioCassetteCaseType definition for any enumerations.

AudioCassetteTapeLengthType [attribute]

AudioCassetteTapeLengthType is optional. A single instance might exist.

Describes the length of the tape used in the audio cassette. The number indicates the expected number of minutes the tape will run.

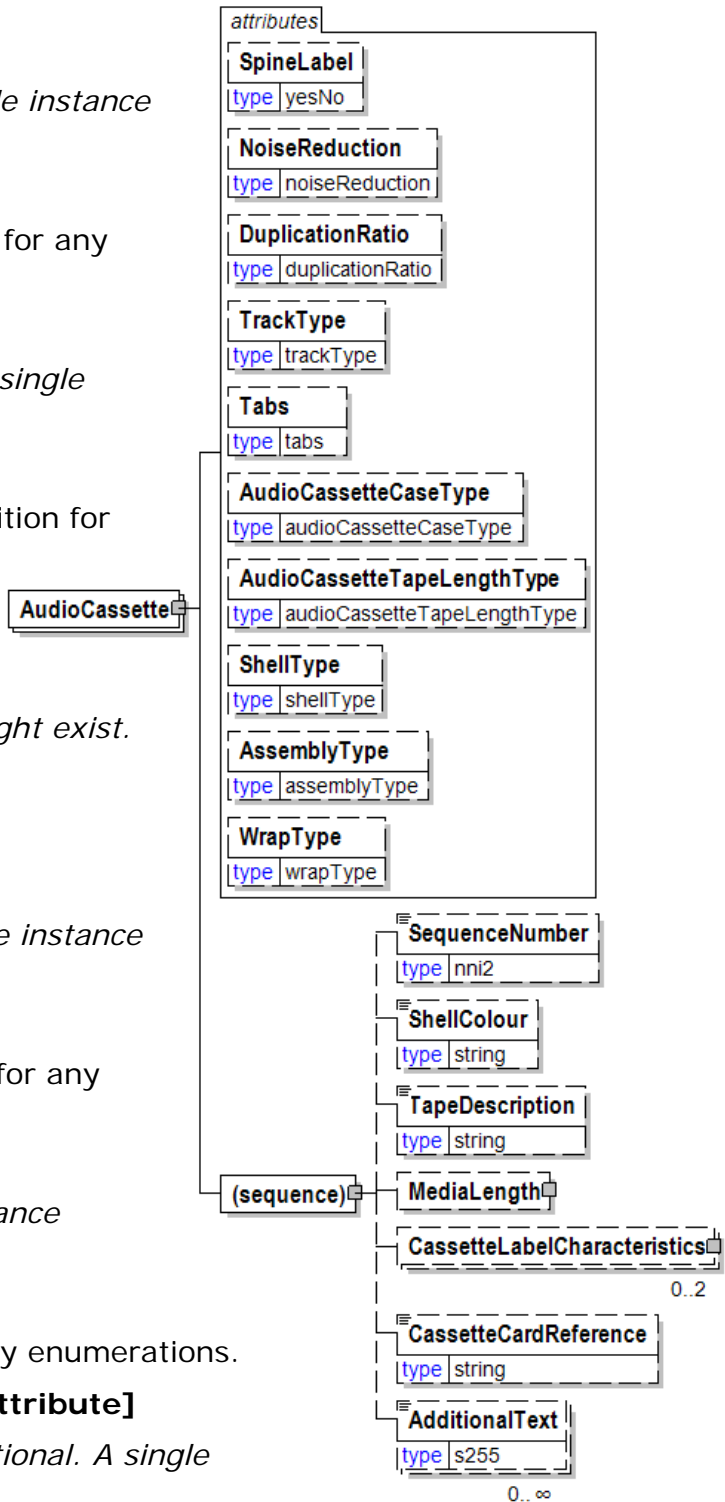

Refer to AudioCassetteTapeLengthType definition for any enumerations.

ShellType [attribute]

ShellType is optional. A single instance might exist.

The type of shell

Refer to ShellType definition for any enumerations.

AssemblyType [attribute]

AssemblyType is optional. A single instance might exist.

Assembly type

Refer to AssemblyType definition for any enumerations.

WrapType [attribute]

WrapType is optional. A single instance might exist.

Communicates the type of material used to wrap the product.

Refer to WrapType definition for any enumerations.

(sequence)

The sequence of items below is mandatory. A single instance is required.

SequenceNumber

SequenceNumber is optional. A single instance might exist.

ShellColour

ShellColour is optional. A single instance might exist.

Shell colour

TapeDescription

TapeDescription is optional. A single instance might exist.

Tape description

MediaLength

MediaLength is optional. A single instance might exist.

Media length

CassetteLabelCharacteristics

CassetteLabelCharacteristics is optional.

Cassette label characteristics

CassetteCardReference

CassetteCardReference is optional. A single instance might exist.

Cassette card reference

AdditionalText

AdditionalText is optional. Multiple instances might exist.

A text field that is used to communicate information not previously defined or for special instructions. To be used only for circumstances not covered by specific elements.

AudioCassetteCaseType [attribute]

Describes the type of audio cassette case.

This item is restricted to the following list.

PolyBox

BlackClearNorelco

ClearClearNorelco

OCard



AudioCassetteTapeLengthType [attribute]

Describes the length of the tape used in the audio cassette. The number indicates the expected number of minutes the tape will run.

This item is restricted to the following list.

C-10

A tape length of 10 minutes.

C-15

A tape length of 15 minutes.

C-20

A tape length of 20 minutes.

C-25

A tape length of 25 minutes.

C-30

A tape length of 30 minutes.

C-35

A tape length of 35 minutes.

C-40

A tape length of 40 minutes.

C-45

A tape length of 45 minutes.

C-50

A tape length of 50 minutes.

C-55

A tape length of 55 minutes.

C-60

A tape length of 60 minutes.

C-65



A tape length of 65 minutes.

C-70

A tape length of 70 minutes.

C-75

A tape length of 75 minutes.

C-80

A tape length of 80 minutes.

C-85

A tape length of 85 minutes.

C-90

A tape length of 90 minutes.

C-95

A tape length of 95 minutes.

C-100

A tape length of 100 minutes.

C-105

A tape length of 105 minutes.

C-110

A tape length of 110 minutes.

C-115

A tape length of 115 minutes.

C-120

A tape length of 120 minutes.

Availability

The Availability element is the root element for the Availability e-Document.

The purpose of the Availability e-Document is to provide a means to ask about the availability of the specified product. The amount of the product immediately available (on-hand) is anticipated to be returned. Optionally, the anticipated availability of the product at a point in future can be communicated.

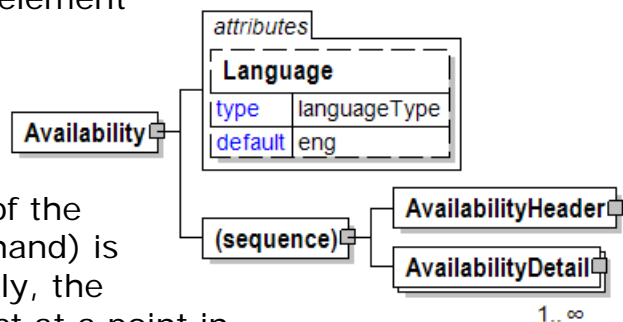

Language [attribute]

Language is optional. A single instance might exist.

XML has embraced 2 and 3 digit language codes through the application of an addendum to the standard.

Refer to Language definition for any enumerations.

(sequence)

The sequence of items below is mandatory. A single instance is required.

AvailabilityHeader

AvailabilityHeader is mandatory. A single instance is required.

The AvailabilityHeader contains items that apply to the entire Availability e-Document.

AvailabilityDetail

AvailabilityDetail is mandatory. One instance is required, multiple instances might exist.

AvailabilityDetail provides the detailed availability information for the requested product.

AvailabilityDetail

AvailabilityDetail provides the detailed availability information for the requested product.

(sequence)

The sequence of items below is mandatory. A single instance is required.

Product

Product is mandatory. A single instance is required.

Product is a group item defining the article and its characteristics. Product is used to specify product characteristics organized by ProductIdentifier, ProductDescription, and Classification.
Book



Manufacturing, Label Stock, Paper, Pulp, Recovered Paper, Wood Products, and Virgin Fibre market segments have defined their product characteristics and conversion features for implementation in papiNet.

TimePeriod

TimePeriod is mandatory. A single instance is required.

The TimePeriod element is used to communicate a duration period of time as indicated in PeriodType.

Quantity

Quantity is optional. A single instance

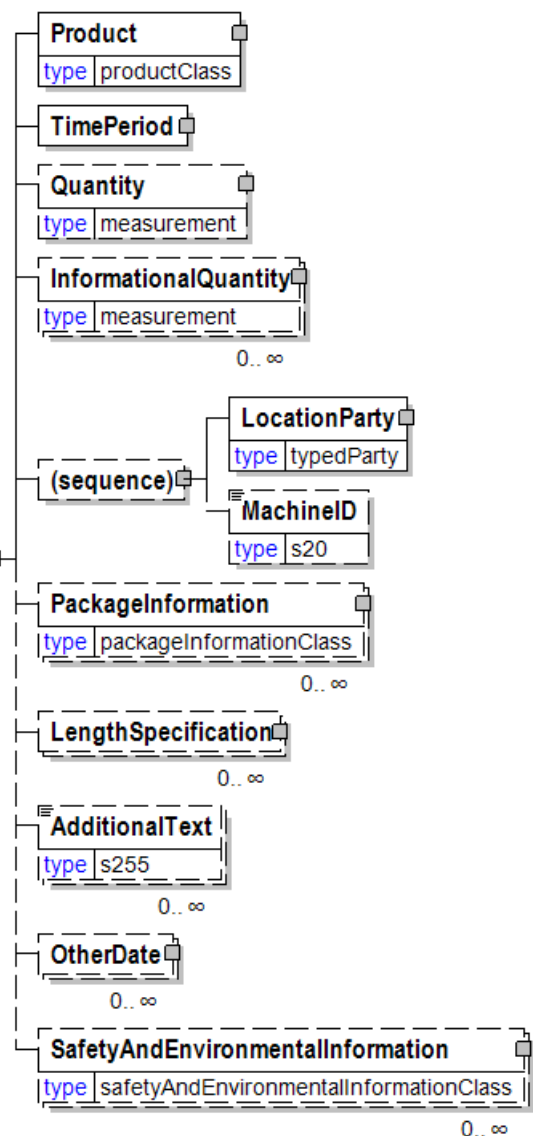

might exist.

The Quantity element contains attributes that provide information about the type of quantity that is being communicated, the context in which the particular quantity is to be viewed, and (if the quantity represents an adjustment) an adjustment type.

The Quantity element contains three child elements that enable you to communicate a range of values for the quantity and a target or actual value. It is at this level (Value, RangeMin, and RangeMax) that the unit of measure is specified. This permits the range to be specified in a different unit of measure than the target.

InformationalQuantity

InformationalQuantity is optional. Multiple instances might exist.

A quantity given in a valid UOM used for information purposes only (not for calculation). For example, an ordered quantity was 100 reels as opposed to the invoice quantity of 20,000 pounds.

(sequence)

The sequence of items below is optional. A single instance might exist.

LocationParty

LocationParty is mandatory. A single instance is required.

The organization or business entity where the business event took place or will take place.

MachineID

MachineID is optional. A single instance might exist.

An identifier assigned to the particular machine being referenced. For example, a machine could be a paper machine, an off-line coater, a sheeter, or a printing press. The particular machine being referenced will be determined by the business event being supported.

PackageInformation

PackageInformation is optional. Multiple instances might exist.

The purpose of the PackageInformation structure is to clearly identify physical handling items that constitute the delivery.

PackageInformation is the highest level of product packaging it describes the shipping or warehousing unit.

If you are communicating a package, usually for logistics or transport purposes, you should include the PackageType, Identifier, ItemCount, and Quantity. (Note: you still have the ability to describe the item with one of the "named" items.)

If you are communicating one of the named Items there is no need to include PackageType, Identifier, ItemCount, and Quantity.

Since either of these two approaches can be used the entire contents of this element are optional even though the parent may be required. It is expected that you will fill in the appropriate details.

LengthSpecification

LengthSpecification is optional. Multiple instances might exist.

Length specification of the wood product.

AdditionalText

AdditionalText is optional. Multiple instances might exist.

A text field that is used to communicate information not previously defined or for special instructions. To be used only for circumstances not covered by specific elements.

OtherDate

OtherDate is optional. Multiple instances might exist.

A date that may not be specifically detailed within a document (example: print date at the PurchaseOrderLineItem).

SafetyAndEnvironmentalInformation

SafetyAndEnvironmentalInformation is optional. Multiple instances might exist.

Name of certification type, if any, on the goods (For example, FSC, PEFC). SafetyAndEnvironmental needs a value or measurement to communicate the percentage of the product is certified (for example, 75% is certified by the indicated agency).

AvailabilityHeader

The AvailabilityHeader contains items that apply to the entire Availability e-Document.

(sequence)

The sequence of items below is mandatory. A single instance is required.

AvailabilityNumber

AvailabilityNumber is mandatory. A single instance is required.

An element that contains the unique identifying number of the Availability e-Document.

AvailabilityIssueDate

AvailabilityIssueDate is mandatory. A single instance is required.

The date and time that the Availability was issued.

RequestNumber

RequestNumber is optional. A single instance might exist.

A unique tracking number specifically identifying the InfoRequest e-Document to the originator. The tracking number is returned with the "information", the answer, to help match the answer to the request.

SenderParty

SenderParty is optional. A single instance might exist.

The business entity issuing the e-Document, the source of the document.

The entity responsible for the content. If the sender party has out sourced the message service to a third party the SenderParty is the issuer of the e-Document and not the party performing the transmission service of the electronic message.

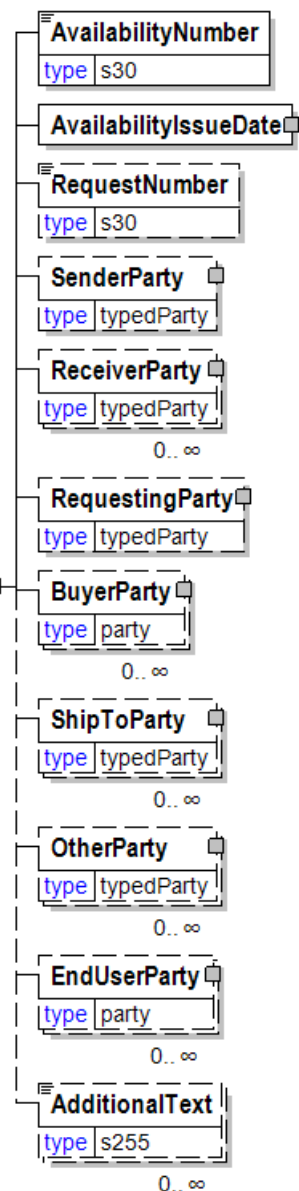

ReceiverParty

ReceiverParty is optional. Multiple instances might exist.

The business entity for whom the e-Document is intended, the destination of the document.

The entity interested in the content. If the receiver party has outsourced the message service to a third party the ReceiverParty is the intended party for the e-Document and not the party performing the receiving service of the electronic message.

RequestingParty

RequestingParty is optional. A single instance might exist.

The party requesting the information.

BuyerParty

BuyerParty is optional. Multiple instances might exist.

The legal entity to which the product is sold. Also commonly referred to as the sold-to party or customer. If no OtherParty is defined as the Payer, the Buyer is the Payer.

ShipToParty

ShipToParty is optional. Multiple instances might exist.

The name and/or address to which the goods should be delivered with the party type indicated by the PartyType attribute.

OtherParty

OtherParty is optional. Multiple instances might exist.

An organisation or business entity other than those specifically detailed within a e-Document.

EndUserParty

EndUserParty is optional. Multiple instances might exist.

The party using, consuming, or converting the product. For example, a printer using paper reels for a print job for a publisher. The final ShipTo destination for a product is normally to the end user's facilities.

AdditionalText

AdditionalText is optional. Multiple instances might exist.

A text field that is used to communicate information not previously defined or for special instructions. To be used only for circumstances not covered by specific elements.

AvailabilityIssueDate

The date and time that the Availability was issued.

(sequence)

The sequence of items below is mandatory. A single instance is required.

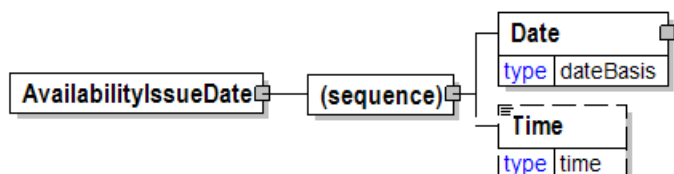

Date

Date is mandatory. A single instance is required.

A group element that contains the specification of Year, Month, and Day.

Time

Time is optional. A single instance might exist.

Times are treated in a standard XML fashion with a special case used to indicate a generalized "local" time. The standard XML approach to time is hh:mm:ss, hh:mm:ssZ, or hh:mm:ss±hh:mm.

hh:mm:ss±hh:mm is used to represent a time with a time zone. The time zone is communicated as the number of hours offset from the Universal Time Coordinate (UTC), a.k.a. Greenwich Mean Time.

hh:mm:ssZ indicates the time at Zulu (another name for UTC). Based on the convention described in the next bullet it will be important for users within UTC to use "Z" when communicating a time in their time zone to other users.

hh:mm:ss or hh:mm indicates in the XML standard the time at UTC however, within papiNet it is used to represent the applicable local time. Caution should be used when processing times of this nature as the papiNet approach may be in discord with other users of XML.

AvailabilityNumber

An element that contains the unique identifying number of the Availability e-Document.

AvailabilityNumber	
type	s30

AvailabilityStatusRequestDetail

A grouping element that provides the parameters to be used when responding with an Availability e-Document.

(sequence)

The sequence of items below is mandatory. A single instance is required.

Product

Product is mandatory. A single instance is required.

Product is a group item defining the article and its characteristics. Product is used to specify product characteristics organized by ProductIdentifier, ProductDescription, and Classification. Book Manufacturing, Label Stock, Paper, Pulp, Recovered Paper, Wood Products, and Virgin Fibre market segments have defined their product characteristics and conversion features for implementation in papiNet.

TimePeriod

TimePeriod is optional. A single instance might exist.

The TimePeriod element is used to communicate a duration period of time as indicated in PeriodType.

Quantity

Quantity is optional. A single instance might exist.

The Quantity element contains attributes that provide information about the type of quantity that is being communicated, the context in which the particular quantity is to be viewed, and (if the quantity represents an adjustment) an adjustment type.

The Quantity element contains three child elements that enable you to communicate a range of values for the quantity and a target or actual value. It is at this level (Value, RangeMin, and RangeMax) that the unit of measure is specified. This permits the range to be specified in a different unit of measure than the target.

InformationalQuantity

InformationalQuantity is optional. Multiple instances might exist.

A quantity given in a valid UOM used for information purposes only (not for calculation). For example, an ordered quantity was 100 reels as opposed to the invoice quantity of 20,000 pounds.

LocationParty

LocationParty is optional. Multiple instances might exist.

The organization or business entity where the business event took place or will take place.

BuyerParty

BuyerParty is optional. Multiple instances might exist.

The legal entity to which the product is sold. Also commonly referred to as the sold-to party or customer. If no OtherParty is defined as the Payer, the Buyer is the Payer.

ShipToParty

ShipToParty is optional. Multiple instances might exist.

The name and/or address to which the goods should be delivered with the party type indicated by the PartyType attribute.

EndUserParty

EndUserParty is optional. Multiple instances might exist.

The party using, consuming, or converting the product. For example, a printer using paper reels for a print job for a publisher. The final ShipTo destination for a product is normally to the end user's facilities.

b

The "b" component of the method of communicating colour termed L^*a^*b .

(sequence)

The sequence of items below is mandatory. A single instance is required.

DetailValue

DetailValue is mandatory. A single instance is required.

A numeric value expressed in the unit of measure (UOM).

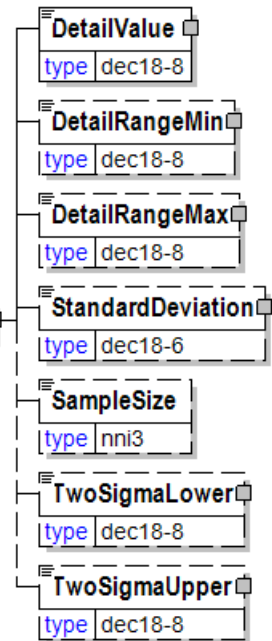
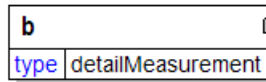

DetailRangeMin

DetailRangeMin is optional. A single instance might exist.

The minimum value (lower boundary) allowed for the DetailValue that is the parent of this element.

DetailRangeMax

DetailRangeMax is optional. A single instance might exist.

The maximum value (upper boundary) allowed for the DetailValue that is the parent of this element.

StandardDeviation

StandardDeviation is optional. A single instance might exist.

A statistic used as a measure of dispersion in a distribution.

SampleSize

SampleSize is optional. A single instance might exist.

The number of samples used to determine the product characteristic in question.

TwoSigmaLower

TwoSigmaLower is optional. A single instance might exist.

Two sigma (a measure of dispersion associated with standard deviation) on the lower side of the standard deviation.

TwoSigmaUpper

TwoSigmaUpper is optional. A single instance might exist.

Two sigma (a measure of dispersion associated with standard deviation) on the upper side of the standard deviation.

Bale

A single or rectangular grouping of product

BaleType [attribute]

BaleType is mandatory. A single instance is required.

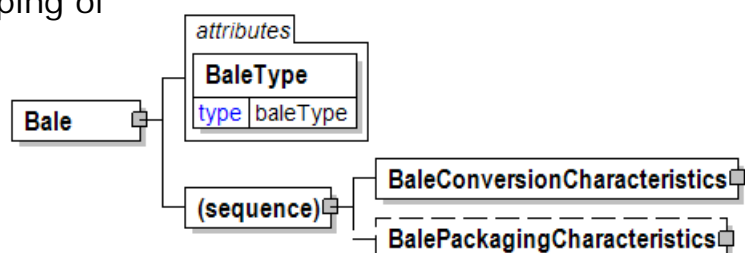

Defines the type of bale being produced. A different production process is indicated by each type.

Refer to BaleType definition for any enumerations.

(sequence)

The sequence of items below is mandatory. A single instance is required.

BaleConversionCharacteristics

BaleConversionCharacteristics is mandatory. A single instance is required.

A group element that contains data relevant to the physical characteristics of a bale of product.

BalePackagingCharacteristics

BalePackagingCharacteristics is optional. A single instance might exist.

A group element containing information relating to packaging of a bale.

BaleCharacteristics

A group item for actual measurement and manufacturing characteristics for a bale.

(sequence)

The sequence of items below is mandatory. A single instance is required.

BaleHeight

BaleHeight is optional. A single instance might exist.

A measurement of one side of the bale, which, in conjunction with the BaleDepth a BaleWidth make up the three measurements of the bale.

BaleWidth

BaleWidth is optional. A single instance might exist.

A measurement of one side of the bale, which, in conjunction with the BaleDepth and BaleHeight make up the three measurements of the bale.

BaleDepth

BaleDepth is optional. A single instance might exist.

A measurement of one side of the bale, in conjunction with BaleHeight and BaleWidth makes up the three measurements of the bale.

DateMade

DateMade is optional. A single instance might exist.

The Date and optionally the Time when an item was produced. DateMade is normally a date before the wrapping and labelling date of the item.

DateFinished

DateFinished is optional. A single instance might exist.

The Date and optionally the Time that an item was finished. For example, this could be the wrapping date for a reel or ream or the date the sheet(s) were packaged in preparation for shipment

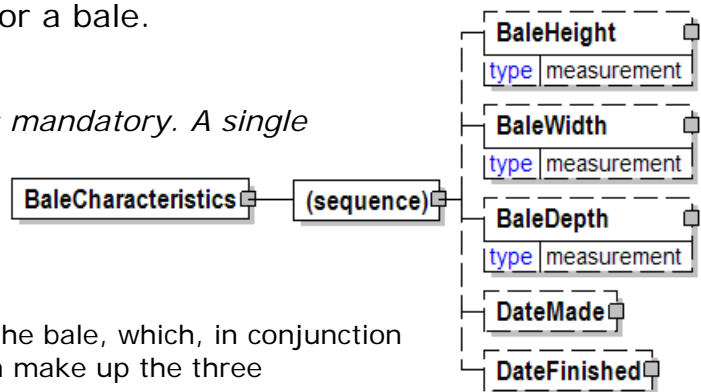

BaleConversionCharacteristics

A group element that contains data relevant to the physical characteristics of a bale of product.

(sequence)

The sequence of items below is mandatory. A single instance is required.

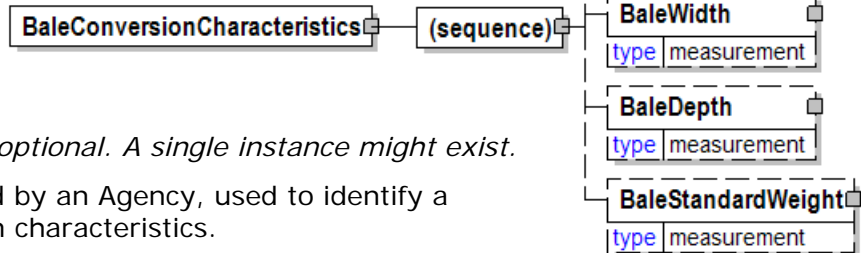

ConversionCode

ConversionCode is optional. A single instance might exist.

A code, as assigned by an Agency, used to identify a group of conversion characteristics.

BaleHeight

BaleHeight is optional. A single instance might exist.

A measurement of one side of the bale, which, in conjunction with the BaleDepth and BaleWidth make up the three measurements of the bale.

BaleWidth

BaleWidth is optional. A single instance might exist.

A measurement of one side of the bale, which, in conjunction with the BaleDepth and BaleHeight make up the three measurements of the bale.

BaleDepth

BaleDepth is optional. A single instance might exist.

A measurement of one side of the bale, in conjunction with BaleHeight and BaleWidth makes up the three measurements of the bale.

BaleStandardWeight

BaleStandardWeight is optional. A single instance might exist.

An individual mill usually produces bales of a target uniform weight to facilitate storage and stowage.

BaleDepth

A measurement of one side of the bale, in conjunction with BaleHeight and BaleWidth makes up the three measurements of the bale.

(sequence)

The sequence of items below is mandatory. A single instance is required.

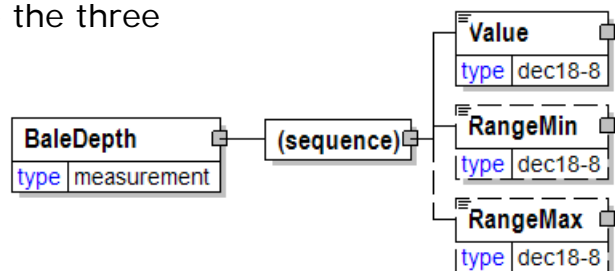

Value

Value is mandatory. A single instance is required.

A numeric value expressed in the unit of measure (UOM).

RangeMin

RangeMin is optional. A single instance might exist.

The minimum value (lower boundary) allowed for the Measurement that is the parent of this element.

RangeMax

RangeMax is optional. A single instance might exist.

The maximum value (upper boundary) allowed for the Measurement that is the parent of this element. Some elements use the RangeMax element with an extended list of unit of measures. (Note: the red colour in the picture is an artifact of how the graphic was captured and should be disregarded.)

BaleHeight

A measurement of one side of the bale, which, in conjunction with the BaleDepth a BaleWidth make up the three measurements of the bale.

(sequence)

The sequence of items below is mandatory. A single instance is required.

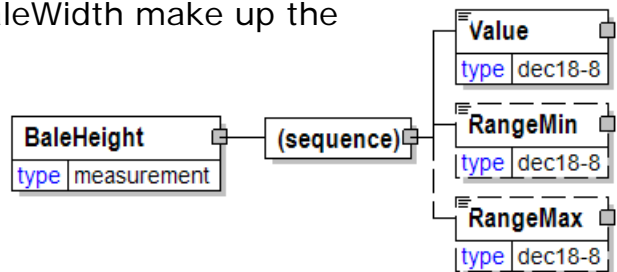

Value

Value is mandatory. A single instance is required.

A numeric value expressed in the unit of measure (UOM).

RangeMin

RangeMin is optional. A single instance might exist.

The minimum value (lower boundary) allowed for the Measurement that is the parent of this element.

RangeMax

RangeMax is optional. A single instance might exist.

The maximum value (upper boundary) allowed for the Measurement that is the parent of this element. Some elements use the RangeMax element with an extended list of unit of measures. (Note: the red colour in the picture is an artifact of how the graphic was captured and should be disregarded.)

BaleItem

An individual bale included as part of a delivery.

(sequence)

The sequence of items below is mandatory. A single instance is required.

Identifier

Identifier is optional. Multiple instances might exist.

An Identifier is required for packages and items (pallets, reel packages, boxes, ream items, reel items, etc). The Identifier element contains the actual item identifier code. Identifier is repeatable so more than one identifier can be communicated. For example, the printed identifier on a label may be different from the barcode printed on the label.

(choice)

[choice] is optional because of choice construct.

(sequence)

The sequence of items below is mandatory. A single instance is required.

PartyIdentifier

PartyIdentifier is mandatory. One instance is required, multiple instances might exist.

A unique identifier of a specific party. This element contains an attribute PartyIdentifierType that indicates the type of party.

MachineID

MachineID is optional. A single instance might exist.

An identifier assigned to the particular machine being referenced. For example, a machine could be a paper machine, an off-line coater, a sheeter, or a printing press. The particular machine being referenced will be determined by the business event being supported.

Product

Product is optional because of choice construct.

Product is a group item defining the article and its characteristics. Product is used to specify product characteristics organized by ProductIdentifier, ProductDescription, and Classification. Book Manufacturing, Label Stock, Paper, Pulp, Recovered Paper, Wood Products, and Virgin Fibre market segments have defined their product characteristics and conversion features for implementation in papiNet.

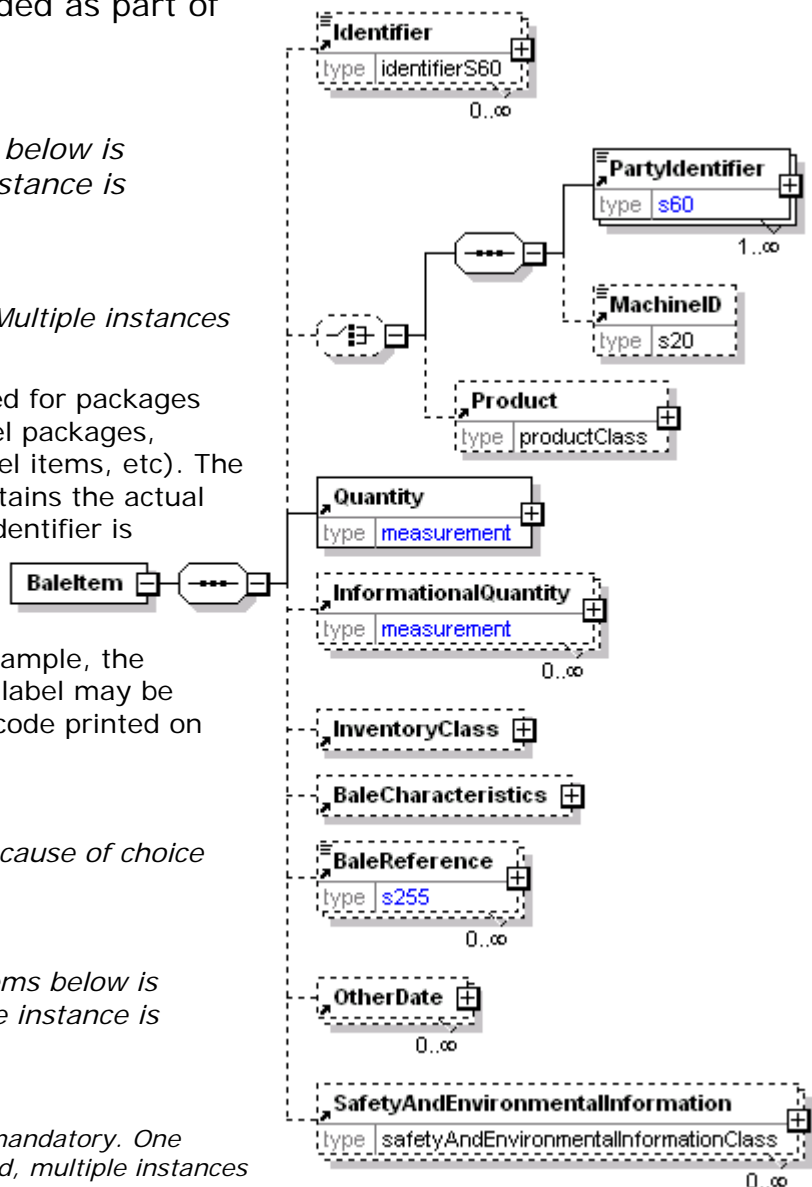

Quantity

Quantity is mandatory. A single instance is required.

The Quantity element contains attributes that provide information about the type of quantity that is being communicated, the context in which the particular quantity is to be viewed, and (if the quantity represents an adjustment) an adjustment type.

The Quantity element contains three child elements that enable you to communicate a range of values for the quantity and a target or actual value. It is at this level (Value, RangeMin, and RangeMax) that the unit of measure is specified. This permits the range to be specified in a different unit of measure than the target.

InformationalQuantity

InformationalQuantity is optional. Multiple instances might exist.

A quantity given in a valid UOM used for information purposes only (not for calculation). For example, an ordered quantity was 100 reels as opposed to the invoice quantity of 20,000 pounds.

InventoryClass

InventoryClass is optional. A single instance might exist.

A group item containing information about status of inventory and goods items.

BaleCharacteristics

BaleCharacteristics is optional. A single instance might exist.

A group item for actual measurement and manufacturing characteristics for a bale.

BaleReference

BaleReference is optional. Multiple instances might exist.

An element detailing relevant references pertaining to the Bale. The type of reference is identified by the attributes BaleReferenceType and AssignedBy.

OtherDate

OtherDate is optional. Multiple instances might exist.

A date that may not be specifically detailed within a document (example: print date at the PurchaseOrderLineItem).

SafetyAndEnvironmentalInformation

SafetyAndEnvironmentalInformation is optional. Multiple instances might exist.

Name of certification type, if any, on the goods (For example, FSC, PEFC). SafetyAndEnvironmental needs a value or measurement to communicate the percentage of the product is certified (for example, 75% is certified by the indicated agency).

BalePackagingCharacteristics

A group element containing information relating to packaging of a bale.

(sequence)

The sequence of items below is mandatory. A single instance is required.

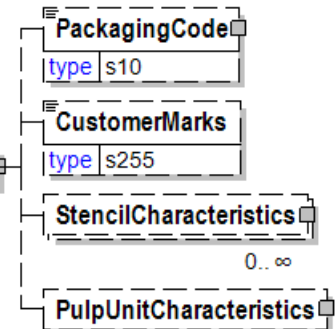

PackagingCode

PackagingCode is optional. A single instance might exist.

PackagingCode is a code describing the packaging of the product.

CustomerMarks

CustomerMarks is optional. A single instance might exist.

The text that the buyer wants the seller to print on the package label or elsewhere.

StencilCharacteristics

StencilCharacteristics is optional. Multiple instances might exist.

A group element specifying attributes of a stencil to be applied to an item, and optional text.

PulpUnitCharacteristics

PulpUnitCharacteristics is optional. A single instance might exist.

A group element that contains information primarily of use for ordering.

BaleReference

An element detailing relevant references pertaining to the Bale. The type of reference is identified by the attributes BaleReferenceType and AssignedBy.

BaleReferenceType [attribute]

BaleReferenceType is mandatory. A single instance is required.

Provides a contextual explanation of the specific reference identifier. Many items are currently prefixed by "Buyer", "Forwarder", "Manufacturer", "Mill", "Seller", "Supplier", "Warehouse", or "Vendor". Check for an existing non-prefixed version and use the non-prefixed version instead. In the (yet to be announced release date) version 3.0 the prefixed versions will be removed. Instead the attribute @AssignedBy will communicate the information previously communicated in the prefix.

Refer to BaleReferenceType definition for any enumerations.

AssignedBy [attribute]

AssignedBy is mandatory. A single instance is required.

Identifies the type of party that has assigned the associated item, e.g. a

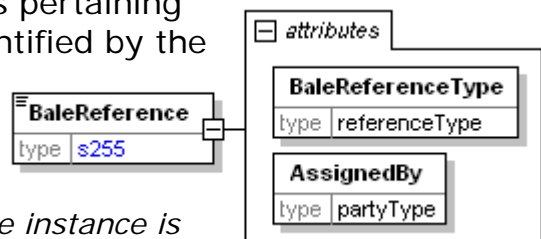

reference of type OrderNumber.

Refer to AssignedBy for any enumerations.

BaleReferenceType [attribute]

Provides a contextual explanation of the specific reference identifier. Many items are currently prefixed by "Buyer", Forwarder", "Manufacturer", "Mill", "Seller", "Supplier", Warehouse" or Vendor". Check for an existing non-prefixed version and use the non-prefixed version instead. In the (yet to be announced release date) version 3.0 the prefixed versions will be removed. Instead the attribute AssignedBy will communicate the information previously communicated in the prefix.

BaleReferenceType	
type	referenceType

Refer to the [referenceType](#) entry for the list of enumerations and their definitions.

BalesPerUnit

The number of bales included on the shipping, handling, or delivery unit.

BalesPerUnit	
type	nni2

BaleStandardWeight

An individual mill usually produces bales of a target uniform weight to facilitate storage and stowage.

(sequence)

The sequence of items below is mandatory. A single instance is required.

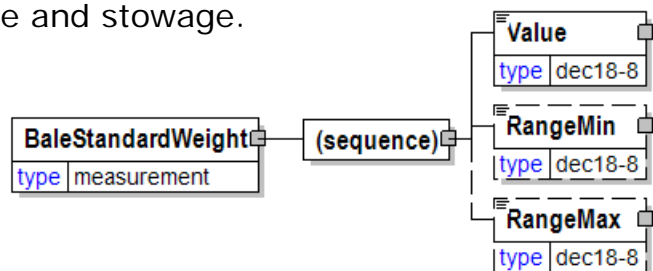

Value

Value is mandatory. A single instance is required.

A numeric value expressed in the unit of measure (UOM).

RangeMin

RangeMin is optional. A single instance might exist.

The minimum value (lower boundary) allowed for the Measurement that is the parent of this element.

RangeMax

RangeMax is optional. A single instance might exist.

The maximum value (upper boundary) allowed for the Measurement that is the parent of this element. Some elements use the RangeMax element with an extended list of unit of measures. (Note: the red colour in the picture is an artifact of how the graphic was captured and should be disregarded.)

BaleType [attribute]

Defines the type of bale being produced. A different production process is indicated by each type.

This item is restricted to the following list.

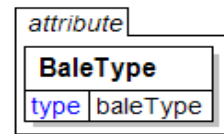

FlashDried

Fibres pressed together to form a bale.

Sheet

A dried and cut product, stacked, pressed, and packaged together.

WetLap

A pressed sheet stacked and usually placed on pallets.

BaleWidth

A measurement of one side of the bale, which, in conjunction with the BaleDepth and BaleHeight make up the three measurements of the bale.

(sequence)

The sequence of items below is mandatory. A single instance is required.

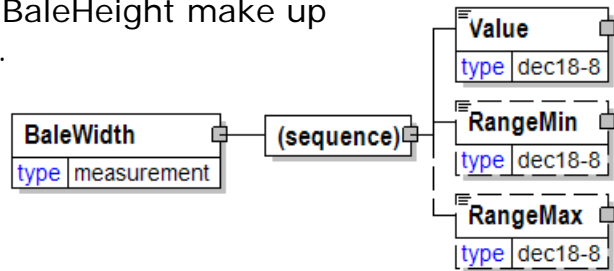

Value

Value is mandatory. A single instance is required.

A numeric value expressed in the unit of measure (UOM).

RangeMin

RangeMin is optional. A single instance might exist.

The minimum value (lower boundary) allowed for the Measurement that is the parent of this element.

RangeMax

RangeMax is optional. A single instance might exist.

The maximum value (upper boundary) allowed for the Measurement that is the parent of this element. Some elements use the RangeMax element with an extended list of unit of measures. (Note: the red colour in the picture is an artifact of how the graphic was captured and should be disregarded.)

BandCharacteristics

A group item that organises the packaging band detail information.

BandType [attribute]

BandType is optional. A single instance might exist.

Communicates the type of band to be used on the product package (metal, nylon, plastic)

Refer to BandType definition for any enumerations.

BandsRequired [attribute]

BandsRequired is optional. A single instance might exist.

Communicates whether or not bands are required or not on the product. When this optional element is not included bands are assumed not to be required.

Refer to BandsRequired definition for any enumerations.

BandDirection [attribute]

BandDirection is optional. A single instance might exist.

The direction of the binding material.

Refer to BandDirection definition for any enumerations.

(sequence)

The sequence of items below is mandatory. A single instance is required.

NumberOfBands

NumberOfBands is optional. A single instance might exist.

The number of bands to be applied to the package.

BandColour

BandColour is optional. Multiple instances might exist.

The colour of the packaging bands to be applied to the package.

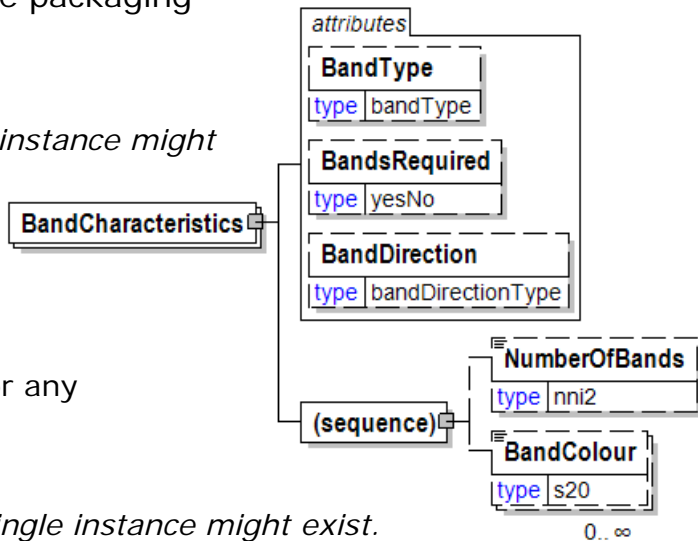

BandColour

The colour of the packaging bands to be applied to the package.

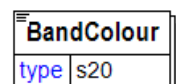

BandDirection [attribute]

The direction of the binding material.

This item is restricted to the following list.

Long

The binding material is on the long side.

Short

The binding material is on the short side.

Both

The binding material is on both the long and the short sides.

attribute
BandDirection
type bandDirectionType

BandLocationType [attribute]

Band location type

This item is restricted to the following list.

Head

The band is located on the top.

Foot

The band is located on the bottom.

Both

The band is located on the top and on the bottom.

None

There is no band.

attribute
BandLocationType
type bandLocationType

BandMaterial

Band material

BandMaterial
type s30

BandsRequired [attribute]

Communicates whether or not bands are required or not on the product. When this optional element is not included bands are assumed not to be required.

This item is restricted to the following list.

Yes

No

attribute
BandsRequired
type yesNo

BandType [attribute]

Communicates the type of band to be used on the product package (metal, nylon, plastic)

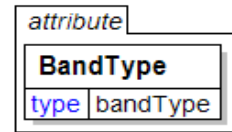

This item is restricted to the following list.

Metal

The band(s) applied to the packaging on the article is/are made of metal.

Nylon

The band(s) applied to the packaging on the article is/are made of nylon.

Plastic

The band(s) applied to the packaging on the article is/are made of plastic.

Standard

The bands used are agreed to by the trading partners involved.

BarcodeSuppliedByPublisher [attribute]

Barcode supplied by publisher

This item is restricted to the following list.



Yes

No

Bark

Used to report bark content in chips as a detail measurement.

TestMethod [attribute]

TestMethod is optional. A single instance might exist.

The method used to determine the results of the test under consideration.

TestAgency [attribute]

TestAgency is optional. A single instance might exist.

The agency that has set the parameters for the testing

Refer to TestAgency definition for any enumerations.

SampleType [attribute]

SampleType is optional. A single instance might exist.

Communicates how sampling was done to measure the product characteristics.

Refer to SampleType definition for any enumerations.

ResultSource [attribute]

ResultSource is optional. A single instance might exist.

Used to define the data source of the specified test

Refer to ResultSource definition for any enumerations.

(sequence)

The sequence of items below is mandatory. A single instance is required.

DetailValue

DetailValue is mandatory. A single instance is required.

A numeric value expressed in the unit of measure (UOM).

DetailRangeMin

DetailRangeMin is optional. A single instance might exist.

The minimum value (lower boundary) allowed for the DetailValue that is the parent of this element.

DetailRangeMax

DetailRangeMax is optional. A single instance might exist.

The maximum value (upper boundary) allowed for the DetailValue that is the parent of this element.

StandardDeviation

StandardDeviation is optional. A single instance might exist.

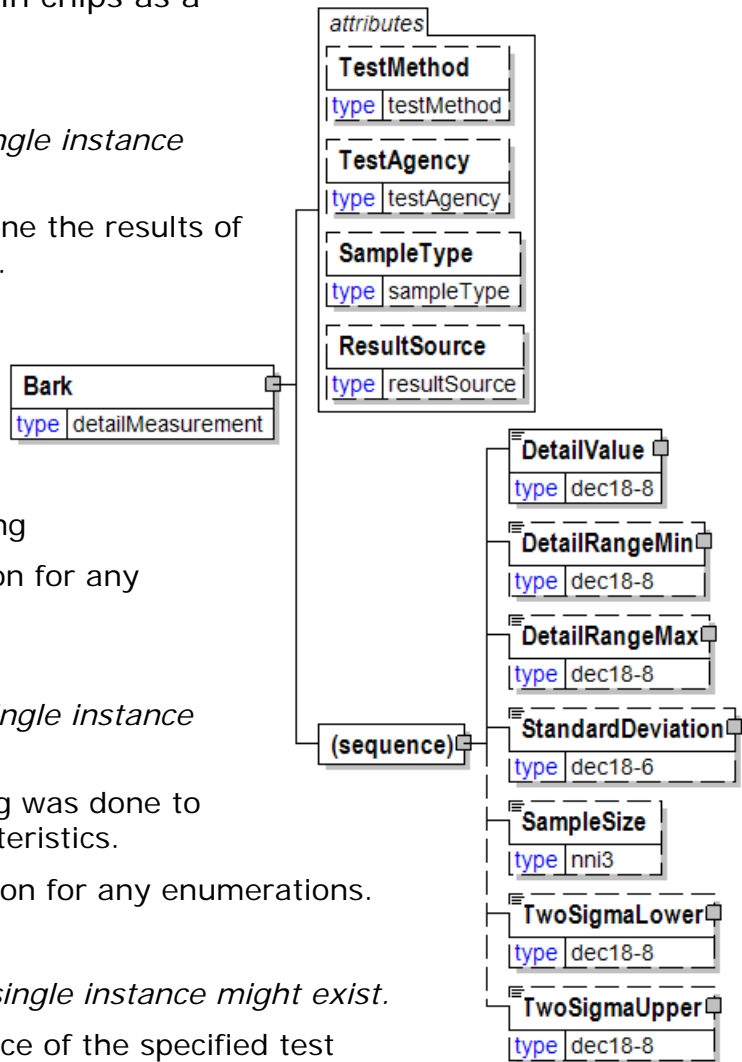

A statistic used as a measure of dispersion in a distribution.

SampleSize

SampleSize is optional. A single instance might exist.

The number of samples used to determine the product characteristic in question.

TwoSigmaLower

TwoSigmaLower is optional. A single instance might exist.

Two sigma (a measure of dispersion associated with standard deviation) on the lower side of the standard deviation.

TwoSigmaUpper

TwoSigmaUpper is optional. A single instance might exist.

Two sigma (a measure of dispersion associated with standard deviation) on the upper side of the standard deviation.

BaseAmountInfo

A grouping element that contains information about price and base amount without any taxes.

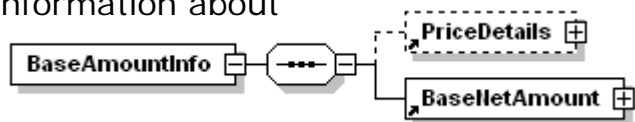

(sequence)

The sequence of items below is mandatory. A single instance is required.

PriceDetails

PriceDetails is optional. A single instance might exist.

An element that groups together price information.

BaseNetAmount

BaseNetAmount is mandatory. A single instance is required.

An element that contains the result of the calculation Quantity times the PricePerUnit. As such it does not include any taxes. The BaseNetAmount encapsulates CurrencyValue.

BaseNetAmount

An element that contains the result of the calculation Quantity times the PricePerUnit. As such it does not include any taxes. The BaseNetAmount encapsulates CurrencyValue.

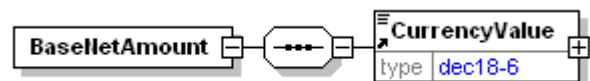

(sequence)

The sequence of items below is mandatory. A single instance is required.

CurrencyValue

CurrencyValue is mandatory. A single instance is required.

The amount in the referenced currency as defined by the CurrencyType attribute.

BasisWeight

The weight of the paper expressed as a mass for a given surface area. In countries using the metric system, the basis weight is expressed as the weight in grams of one sheet of paper that is one square meter in area—not dependent on basic sheet size. In countries using the imperial system, the weight is expressed in pounds for a given ProductBasisSizeType.

TestMethod [attribute]

TestMethod is optional. A single instance might exist.

The method used to determine the results of the test under consideration.

TestAgency [attribute]

TestAgency is optional. A single instance might exist.

The agency that has set the parameters for the testing

Refer to TestAgency definition for any enumerations.

SampleType [attribute]

SampleType is optional. A single instance might exist.

Communicates how sampling was done to measure the product characteristics.

Refer to SampleType definition for any enumerations.

ResultSource [attribute]

ResultSource is optional. A single instance might exist.

Used to define the data source of the specified test

Refer to ResultSource definition for any enumerations.

ProductBasisSizeType [attribute]

ProductBasisSizeType is optional. A single instance might exist.

An attribute list that indicates the size of paper used as the base for the basis weight calculation

Refer to ProductBasisSizeType definition for any enumerations.

(sequence)

The sequence of items below is mandatory. A single instance is required.

DetailValue

DetailValue is mandatory. A single instance is required.

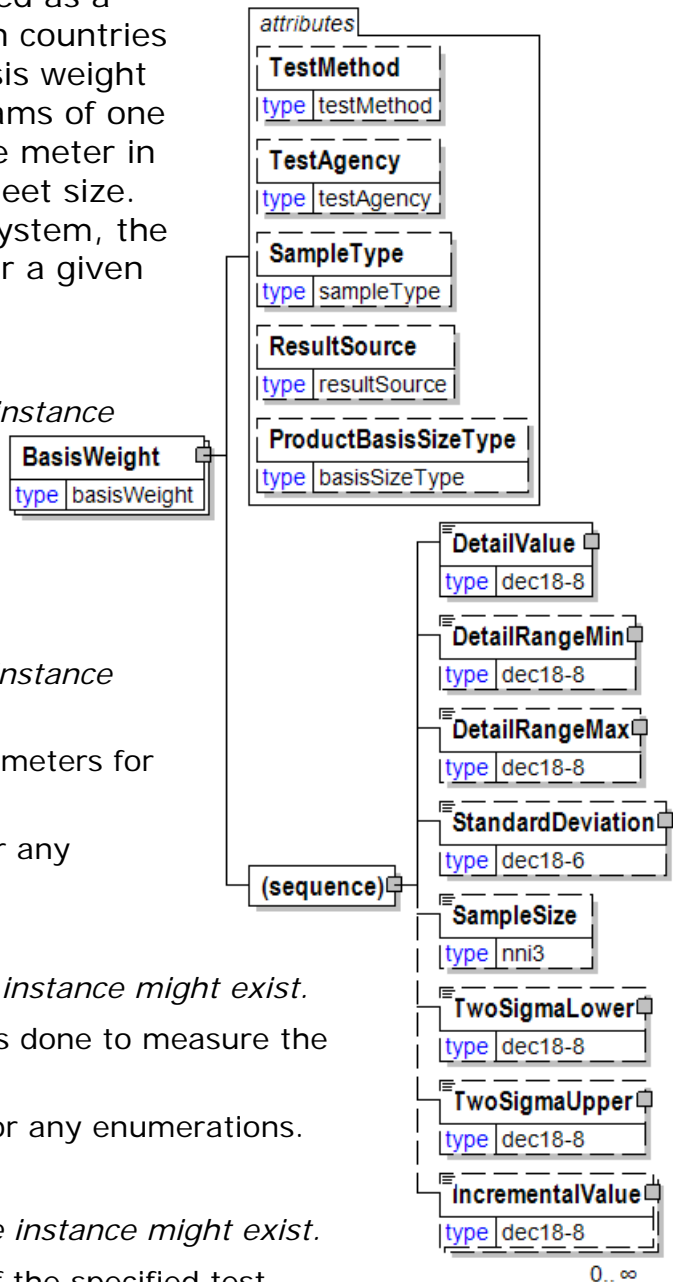

papiNet V2R31

A numeric value expressed in the unit of measure (UOM).

DetailRangeMin

DetailRangeMin is optional. A single instance might exist.

The minimum value (lower boundary) allowed for the DetailValue that is the parent of this element.

DetailRangeMax

DetailRangeMax is optional. A single instance might exist.

The maximum value (upper boundary) allowed for the DetailValue that is the parent of this element.

StandardDeviation

StandardDeviation is optional. A single instance might exist.

A statistic used as a measure of dispersion in a distribution.

SampleSize

SampleSize is optional. A single instance might exist.

The number of samples used to determine the product characteristic in question.

TwoSigmaLower

TwoSigmaLower is optional. A single instance might exist.

Two sigma (a measure of dispersion associated with standard deviation) on the lower side of the standard deviation.

TwoSigmaUpper

TwoSigmaUpper is optional. A single instance might exist.

Two sigma (a measure of dispersion associated with standard deviation) on the upper side of the standard deviation.

IncrementalValue

IncrementalValue is optional. Multiple instances might exist.

Many times paper is produce in BasisWeights of discreet values. This element permits the expression of those increments.

BasisWeightVariation

BasisWeightVariation is the measured difference between the mill target basis weight and the mill actual basis weight.

(sequence)

The sequence of items below is mandatory. A single instance is required.

Value

Value is mandatory. A single instance is required.

A numeric value expressed in the unit of measure (UOM).

RangeMin

RangeMin is optional. A single instance might exist.

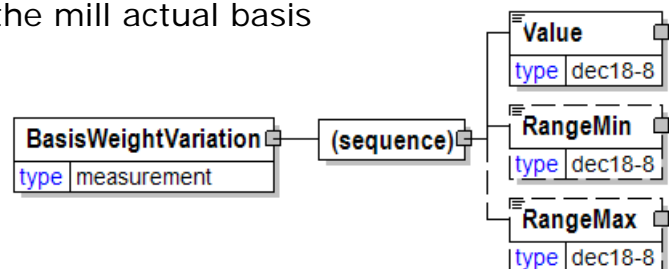

The minimum value (lower boundary) allowed for the Measurement that is the parent of this element.

RangeMax

RangeMax is optional. A single instance might exist.

The maximum value (upper boundary) allowed for the Measurement that is the parent of this element. Some elements use the RangeMax element with an extended list of unit of measures. (Note: the red colour in the picture is an artifact of how the graphic was captured and should be disregarded.)

BendingResistance

Bending resistance

TestMethod [attribute]

TestMethod is optional. A single instance might exist.

The method used to determine the results of the test under consideration.

TestAgency [attribute]

TestAgency is optional. A single instance might exist.

The agency that has set the parameters for the testing

Refer to TestAgency definition for any enumerations.

SampleType [attribute]

SampleType is optional. A single instance might exist.

Communicates how sampling was done to measure the product characteristics.

Refer to SampleType definition for any enumerations.

ResultSource [attribute]

ResultSource is optional. A single instance might exist.

Used to define the data source of the specified test

Refer to ResultSource definition for any enumerations.

(sequence)

The sequence of items below is mandatory. A single instance is required.

DetailValue

DetailValue is mandatory. A single instance is required.

A numeric value expressed in the unit of measure (UOM).

DetailRangeMin

DetailRangeMin is optional. A single instance might exist.

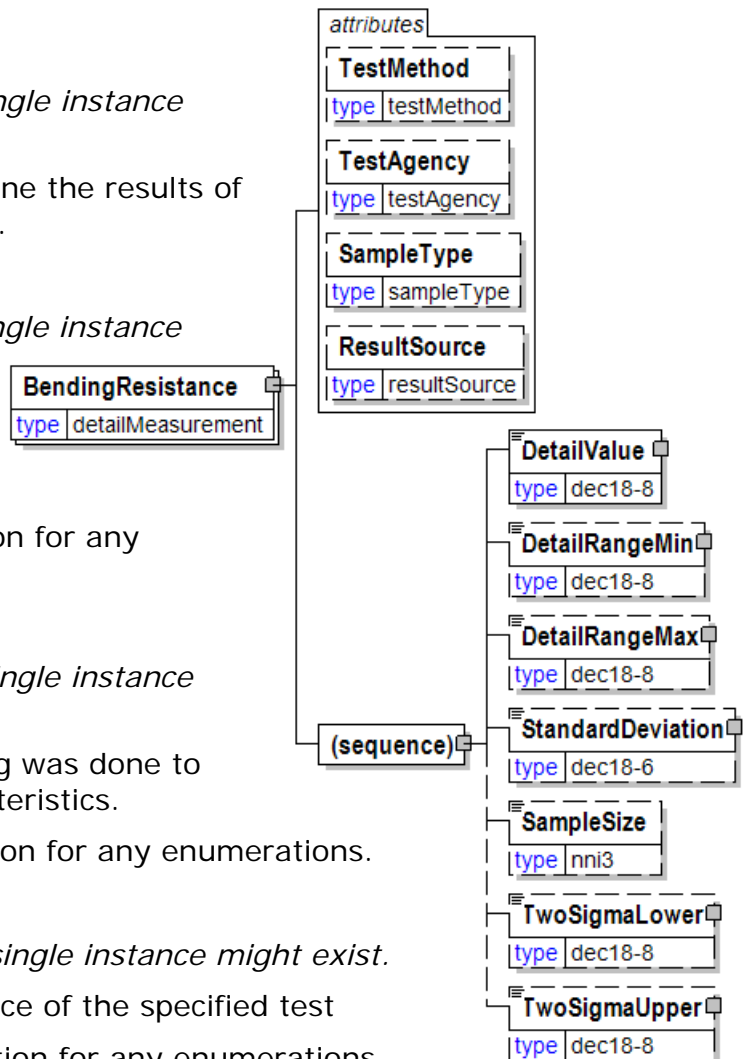

The minimum value (lower boundary) allowed for the DetailValue that is the parent of this element.

DetailRangeMax

DetailRangeMax is optional. A single instance might exist.

The maximum value (upper boundary) allowed for the DetailValue that is the parent of this element.

StandardDeviation

StandardDeviation is optional. A single instance might exist.

A statistic used as a measure of dispersion in a distribution.

SampleSize

SampleSize is optional. A single instance might exist.

The number of samples used to determine the product characteristic in question.

TwoSigmaLower

TwoSigmaLower is optional. A single instance might exist.

Two sigma (a measure of dispersion associated with standard deviation) on the lower side of the standard deviation.

TwoSigmaUpper

TwoSigmaUpper is optional. A single instance might exist.

Two sigma (a measure of dispersion associated with standard deviation) on the upper side of the standard deviation.

BendingStiffness

BendingStiffness

TestMethod [attribute]

TestMethod is optional. A single instance might exist.

The method used to determine the results of the test under consideration.

TestAgency [attribute]

TestAgency is optional. A single instance might exist.

The agency that has set the parameters for the testing

Refer to TestAgency definition for any enumerations.

SampleType [attribute]

SampleType is optional. A single instance might exist.

Communicates how sampling was done to measure the product characteristics.

Refer to SampleType definition for any enumerations.

ResultSource [attribute]

ResultSource is optional. A single instance might exist.

Used to define the data source of the specified test

Refer to ResultSource definition for any enumerations.

(sequence)

The sequence of items below is mandatory. A single instance is required.

DetailValue

DetailValue is mandatory. A single instance is required.

A numeric value expressed in the unit of measure (UOM).

DetailRangeMin

DetailRangeMin is optional. A single instance might exist.

The minimum value (lower boundary) allowed for the DetailValue that is the parent of this element.

DetailRangeMax

DetailRangeMax is optional. A single instance might exist.

The maximum value (upper boundary) allowed for the DetailValue that is the parent of this element.

StandardDeviation

StandardDeviation is optional. A single instance might exist.

A statistic used as a measure of dispersion in a distribution.

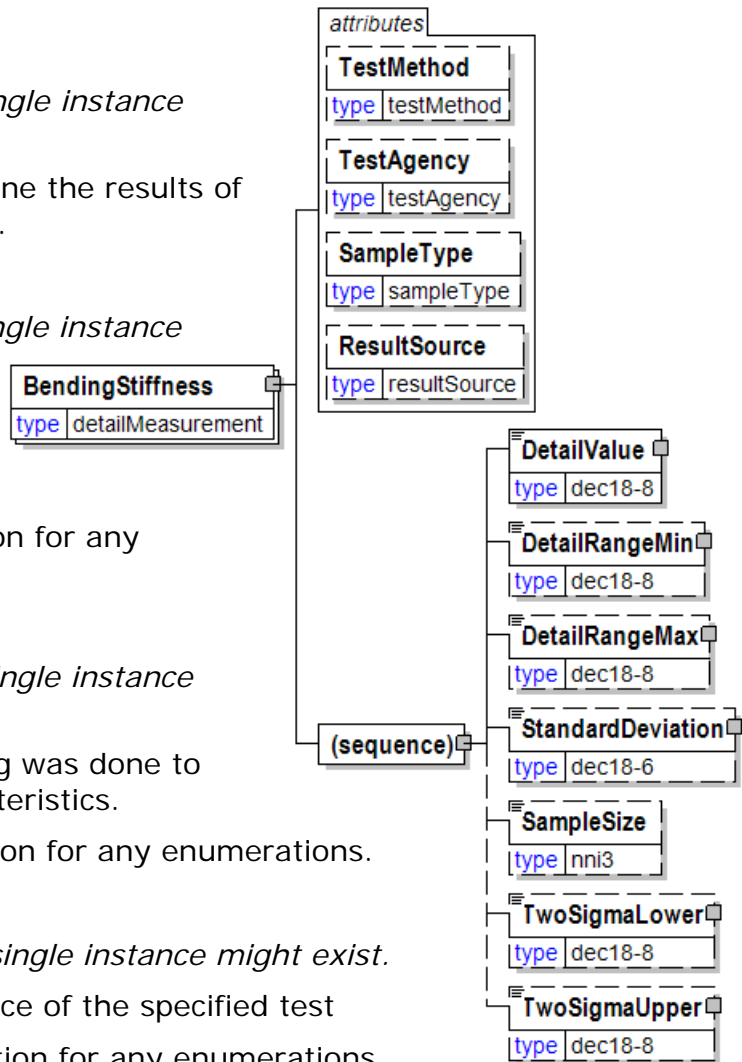

SampleSize

SampleSize is optional. A single instance might exist.

The number of samples used to determine the product characteristic in question.

TwoSigmaLower

TwoSigmaLower is optional. A single instance might exist.

Two sigma (a measure of dispersion associated with standard deviation) on the lower side of the standard deviation.

TwoSigmaUpper

TwoSigmaUpper is optional. A single instance might exist.

Two sigma (a measure of dispersion associated with standard deviation) on the upper side of the standard deviation.

BestBeforeDate

The date, prior to which, the product is suggested to be used.

(sequence)

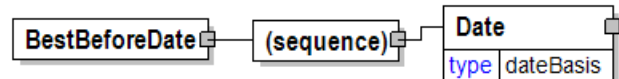

The sequence of items below is mandatory. A single instance is required.

Date

Date is mandatory. A single instance is required.

A group element that contains the specification of Year, Month, and Day.

Billable [attribute]

Either "Yes" or "No".

This item is restricted to the following list.

Yes

No

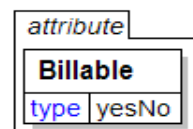

BillOfMaterials

A specification of the components and other items that are used to produce the item in question.

(sequence)

The sequence of items below is mandatory. One instance is required, multiple instances might exist.

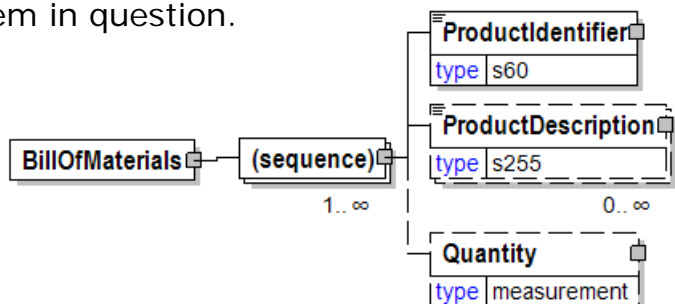

ProductIdentifier

ProductIdentifier is mandatory. A single instance is required.

Used to communicate the code of the article, in a variety of formats designated by

the type.

ProductDescription

ProductDescription is optional. Multiple instances might exist.

An element used to communicate a human readable description of the product in the language specified by the Language attribute.

Quantity

Quantity is optional. A single instance might exist.

The Quantity element contains attributes that provide information about the type of quantity that is being communicated, the context in which the particular quantity is to be viewed, and (if the quantity represents an adjustment) an adjustment type.

The Quantity element contains three child elements that enable you to communicate a range of values for the quantity and a target or actual value. It is at this level (Value, RangeMin, and RangeMax) that the unit of measure is specified. This permits the range to be specified in a different unit of measure than the target.

BillToParty

The address where the Invoice is to be sent.

LogisticsRole [attribute]

LogisticsRole is optional. A single instance might exist.

Communicates the nature of the logistics role, if any, the party plays in the transaction.

Refer to LogisticsRole definition for any enumerations.

(sequence)

The sequence of items below is mandatory. A single instance is required.

PartyIdentifier

PartyIdentifier is optional. Multiple instances might exist.

A unique identifier of a specific party. This element contains an attribute PartyIdentifierType that indicates the type of party.

NameAddress

NameAddress is mandatory. A single instance is required.

A group item containing name and address of an organisation or business entity.

URL

URL is optional. A single instance might exist.

Universal Resource Locator. While typically a web address you could use this field to hold an email address.

CommonContact

CommonContact is optional. Multiple instances might exist.

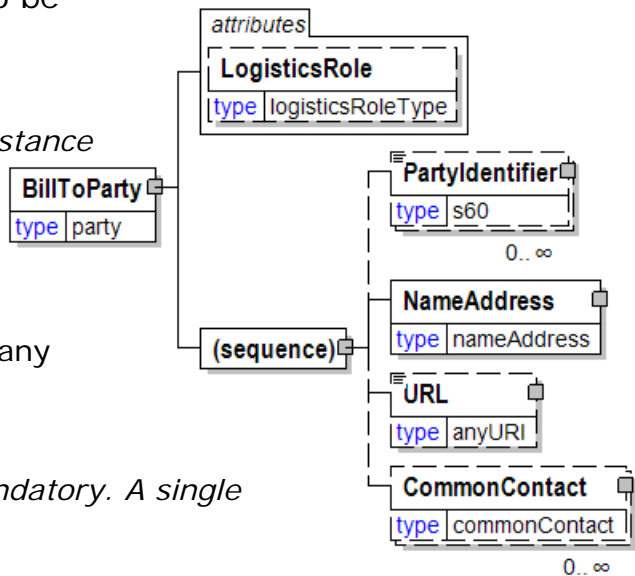

Identifies a specific individual associated with the party.

BinaryValue

A value in base-64-encoded binary format.

BinaryValue	
type	xs:base64Binary

BindingBackingType [attribute]

Specifies the shape of the book spine during the binding operation.

This item is restricted to the following list.

Round

Spine shape is rounded before cover is applied; used primarily for hardcover books.

Flat

Spine shape is flattened before cover is applied, used primarily for softcover books.

BindingBackStyleType [attribute]

Specifies that the book cover is either attached or detached from the spine.

This item is restricted to the following list.

Tight

Specifies the book cover is attached to the spine.

Loose

Specifies the book cover is detached from the spine.

BindingCoverScoring [attribute]

Indicates if scoring of the front cover close to the spine allowing the cover to easily stay open is required.

This item is restricted to the following list.

Yes

Scoring is required.

No

Scoring is not required.

BindingExtras

Binding extras

EdgeLocationType [attribute]

EdgeLocationType is optional. A single instance might exist.

Edge location type.

Refer to EdgeLocationType definition for any enumerations.

(sequence)

The sequence of items below is mandatory. A single instance is required.

BindingExtrasDescription

BindingExtrasDescription is mandatory. A single instance is required.

Binding Extras Description

Quantity

Quantity is optional. A single instance might exist.

The Quantity element contains attributes that provide information about the type of quantity that is being communicated, the context in which the particular quantity is to be viewed, and (if the quantity represents an adjustment) an adjustment type.

The Quantity element contains three child elements that enable you to communicate a range of values for the quantity and a target or actual value. It is at this level (Value, RangeMin, and RangeMax) that the unit of measure is specified. This permits the range to be specified in a different unit of measure than the target.

UnitCharacteristics

UnitCharacteristics is optional. A single instance might exist.

Unit characteristics.

BindingMaterialCharacteristics

BindingMaterialCharacteristics is optional. Multiple instances might exist.

Binding Material Characteristics

AdditionalText

AdditionalText is optional. Multiple instances might exist.

A text field that is used to communicate information not previously defined or for special instructions. To be used only for circumstances not covered by specific elements.

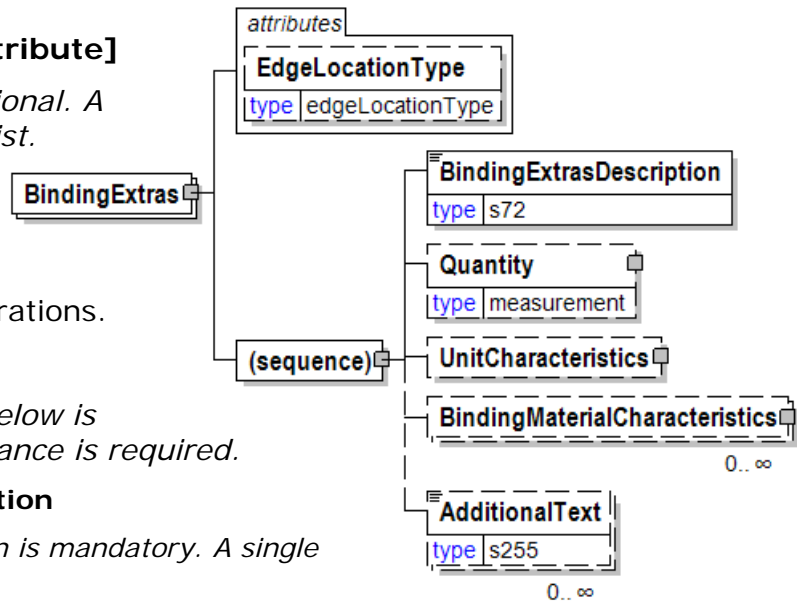

BindingExtrasDescription

Binding Extras Description

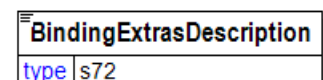

BindingMaterialCharacteristics

Binding Material Characteristics

FinishType [attribute]

FinishType is optional. A single instance might exist.

Defines the finish of a sheet of paper, which means the condition of its surface (refer to Embossing for more information).

Finishes may be produced on or off machine. Finishes that are created off-machine are called embossed. (Embossing is a child element of ReelConversionCharacteristics and SheetConversionCharacteristics.)

Note:

Embossed" as a finish type is just a generalized choice for one of the more specific choices listed.

Unsupercalendered" as a finish type would be indicated by not communicating a finish type.

Refer to FinishType definition for any enumerations.

(sequence)

The sequence of items below is mandatory. A single instance is required.

BindingMaterialDescription

BindingMaterialDescription is mandatory. A single instance is required.

Specifications for the materials used in binding.

BasisWeight

BasisWeight is optional. A single instance might exist.

The weight of the paper expressed as a mass for a given surface area. In countries using the metric system, the basis weight is expressed as the weight in grams of one sheet of paper that is one square meter in area—not dependent on basic sheet size. In countries using the imperial system, the weight is expressed in pounds for a given ProductBasisSizeType.

ColourCode

ColourCode is optional. A single instance might exist.

A code indicating the colour.

ColourDescription

ColourDescription is optional. A single instance might exist.

A free form description of the colour.

ProductIdentification

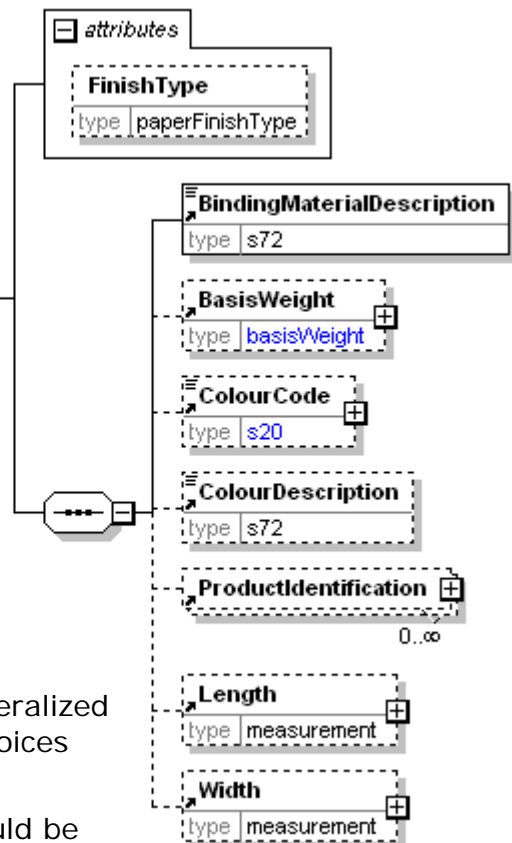

ProductIdentification is optional. Multiple instances might exist.

A grouping element designed to communicate product identification related to the parent element that contains this item.

Length

Length is optional. A single instance might exist

The length of the object.

Width

Width is optional. A single instance might exist

The width of the object.

BindingMaterialDescription

Specifications for the materials used in binding.

BindingReinforcement [attribute]

Specifies if spine reinforcement materials are included in the binding operation.

This item is restricted to the following list.

Yes

Reinforcement materials are required.

No

Reinforcement materials are not required.

BindingRibbon [attribute]

Specifies if a ribbon (bookmark) is to be included in the binding.

This item is restricted to the following list.

Yes

Ribbons are included.

No

Ribbons are not included.

BindingStyleType [attribute]

Indicates the style of binding used.

This item is restricted to the following list.

Accordion

Pages of the book are formed by folding the paper in zig-zag form and the cover is applied to each end; this type of binding allows the book to stand firmly on the head or foot edges.



Adhesive

Type of binding in which single leaves are secured together solely with an adhesive applied to the spine.

AdhesiveBurst

A line of slots is cut from the spine at the fold so that the glue adheres to the cut edge of each slot; sections are not milled before gluing.

Will be deprecated in version V3R00.

AdhesiveSewn

Softcover book where the pages are sewn prior to the cover being applied using with adhesives.

BoardBook

Cover and pages of the book printed on thick paperboard.

BookLock

Alternating left-right perforations along the sides of the spine, the alternating protruding flaps along the spine when the signature is folded and the casting of these alternating flaps into the spine glue.

Burst

The spine of each section is slotted or perforated during the folding operation. Glue is pushed up between the perforations during binding and the cover is then drawn on.

CombinationBinding

Will be deprecated in version V3R00.

Custom

Highly stylized binding in an unusual way compared to standard manufacturing.

Durasew

Will be deprecated in version V3R00.

FlexiBind

A system for binding books includes a flexible binding material in the form of a stud having top and bottom caps.

IMS

Will be deprecated in version V3R00.

LayFlatSoft

Will be deprecated in version V3R00.

See LayFlatBind

LayflatBind

Softcover book where the cover is glued only to the sides of the spine so that the book can lay flat when open. A strip of gauze is glued to the spine edge of the book block to hold the signatures or pages together.

LooseLeaf

Consisting of loose leaves (pages), often collected in a binder, rather than being bound like a book or stap.

McCainSideSewn

Brand Name of the machine used for Sidesewn bookbinding; see SideSewn
Will be deprecated in version V3R00.

Notch

The gouging of grooves (commonly 1/8 inch wide) in the spine of a book block to facilitate the penetration of adhesive during subsequent perfect binding.

Pad

A number of sheets of paper fastened together along one edge.

Patent

Will be deprecated in version V3R00.

PerfectAdhesive

Will be deprecated in version V3R00.

See PerfectBound

PerfectBound

A process in which the binding edge of the folded sections of a book are trimmed (to separate the leaves) before being glued to the cover's spine.

PlasticComb

Mechanical binding in which the pages are bound together by means of a plastic comb consisting of a plastic strip off which extend a series of curved plastic prongs, which are inserted into drilled or punched holes along the binding edge of the pages.

Repkover

Brand Name of the machine used for layflat bookbinding; see LayflatBind
Will be deprecated in version V3R00.

Ring

Binding technique where pages are punched or drilled at one edge and inserted into two or more metal rings held inside a stiff cover.

RoundBound

Will be deprecated in version V3R00.

SaddleStitch

Method of binding a small booklet by stitching it through the center fold of the sheets that comprise its pages; stitching materials can be regular binding thread, saddle wire, or staples.

SaddleWire

SaddleStitch binding using wire staples.

SelfCover

Will be deprecated in version V3R00.

SemiConcealedWireO

WireO binding where the wire is partially visible in the spine of the book.

SideSewn

Compiled signatures are sewn together with stitches running top down through the book block and parallel to the binding edge.

Sidewire

Stapling through the sides of the folded sheets.

SmythSewn

Brand name for ThreadSewing equipment: see ThreadSewn.

Spiral

A continuous wire or plastic coil is threaded through holes drilled or punched along the binding side of the book including the separate front and back covers.

SpiralHardFrontHardBack

Spiral binding with separate case covers on the front and back of the book.

SpiralSoftFrontHardBack

Spiral binding with a soft /paper cover on the front and a case cover on the back.

SpiralSoftFrontSoftBack

Spiral binding with separate soft /paper covers on the front and back

SquareBackSaddleWire

Saddlewire binding method where the spine is flattened rather than folded.

Thermal

Binding method that uses a one piece cover with glue down the spine to quickly and easily bind documents.

Threadseal

The spine of each individual signature is stitched or stapled with a plastic coated thread, then the threads are sealed with an application of heat.

ThreadSewn

Binding process where all of the signatures are sewn individually together with threads going through each page several times.

Trim4SideDrill

All 4 sides of the book block are trimmed and then holepunched.

Will be deprecated in version V3R00.

TrimFourSides

All 4 sides of the book block are trimmed.

Will be deprecated in version V3R00.

UltraFan

Will be deprecated in version V3R00.

WireO

Punch-and-bind spiral wire binding where there are twin-loops of wire as opposed to single-loop in typical spiral binding.

WireOConcealed

WireO binding where the wire is concealed in the spine of the book

Other

BindingType [attribute]

Identifies the primary binding category of the book.

This item is restricted to the following list.

Hardcover

Method of binding where the pages are bound between rigid boards covered in cloth, paper, leather, or film.

Softcover

Having covers made of paper or thin cardboard.

Layflat

Method of perfect binding that allows a publication to lie fully open.

Loose

Finished product consists of loose pages or signatures rather than bound; example is a packet of loose leaf pages that are drilled for insertion into a ring binder.

Mechanical

Method of binding which secures pre-trimmed leaves by the insertion of wire or plastic spirals through holes drilled in the binding edge.

Self

Method of binding where the cover is comprised of the outside pages of the text.

Black

The Black component of a colour.

(sequence)

The sequence of items below is mandatory. A single instance is required.

DetailValue

DetailValue is mandatory. A single instance is required.

A numeric value expressed in the unit of measure (UOM).

DetailRangeMin

DetailRangeMin is optional. A single instance might exist.

The minimum value (lower boundary) allowed for the DetailValue that is the parent of this element.

DetailRangeMax

DetailRangeMax is optional. A single instance might exist.

The maximum value (upper boundary) allowed for the DetailValue that is the parent of this element.

StandardDeviation

StandardDeviation is optional. A single instance might exist.

A statistic used as a measure of dispersion in a distribution.

SampleSize

SampleSize is optional. A single instance might exist.

The number of samples used to determine the product characteristic in question.

TwoSigmaLower

TwoSigmaLower is optional. A single instance might exist.

Two sigma (a measure of dispersion associated with standard deviation) on the lower side of the standard deviation.

TwoSigmaUpper

TwoSigmaUpper is optional. A single instance might exist.

Two sigma (a measure of dispersion associated with standard deviation) on the upper side of the standard deviation.

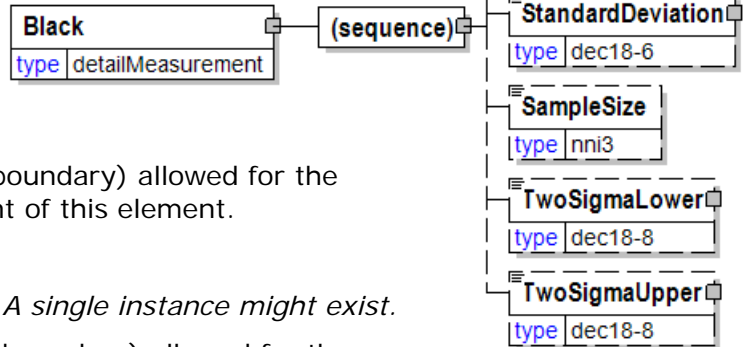

Blanket

Blanket is a group element that contains elements that describe this component of the printing process.

(sequence)

The sequence of items below is mandatory. A single instance is required.

BlanketType

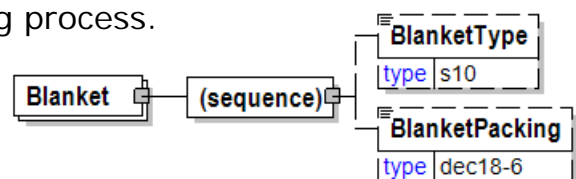

papiNet V2R31

BlanketType is optional. A single instance might exist.

Rubber coated pad mounted on the cylinder of an offset press that receives the inked image and transfers it to the print surface.

BlanketPacking

BlanketPacking is optional. A single instance might exist.

The thickness of the paper that is placed between the cylinder and the blanket to obtain the proper pressure for printing. Usually this ranges from .010 to .008 inches.

BlanketPacking

The thickness of the paper that is placed between the cylinder and the blanket to obtain the proper pressure for printing. Usually this ranges from .010 to .008 inches.

BlanketPacking
type dec18-6

BlanketType

Rubber coated pad mounted on the cylinder of an offset press that receives the inked image and transfers it to the print surface.

BlanketType
type s10

BleachingProcess [attribute]

Communicates the type of bleaching process used to make the pulp fibre

This item is restricted to the following list.

ChlorineBleached

The product is bleached using chlorine.

ElementaryChlorineFree

The product is bleached using a process that does not use chlorine in its basic or elementary form.

TotallyChlorineFree

The product is bleached using a process that does not use chlorine in either its basic (elementary form) or in its bound (compound form),

Unbleached

The product has not gone through a bleaching process.

attribute
BleachingProcess
type bleachingProcess

Bleed [attribute]

Specifies if the printing of an illustration, design, or text to the edge of the page.

This item is restricted to the following list.

Yes

Bleeds are present in the printing.

No

Bleeds are not present in the printing.

Blue

The "Blue" portion of the method of representing colour termed RGB.

(sequence)

The sequence of items below is mandatory. A single instance is required.

DetailValue

DetailValue is mandatory. A single instance is required.

A numeric value expressed in the unit of measure (UOM).

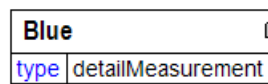

DetailRangeMin

DetailRangeMin is optional. A single instance might exist.

The minimum value (lower boundary) allowed for the DetailValue that is the parent of this element.

DetailRangeMax

DetailRangeMax is optional. A single instance might exist.

The maximum value (upper boundary) allowed for the DetailValue that is the parent of this element.

StandardDeviation

StandardDeviation is optional. A single instance might exist.

A statistic used as a measure of dispersion in a distribution.

SampleSize

SampleSize is optional. A single instance might exist.

The number of samples used to determine the product characteristic in question.

TwoSigmaLower

TwoSigmaLower is optional. A single instance might exist.

Two sigma (a measure of dispersion associated with standard deviation) on the lower side of the standard deviation.

TwoSigmaUpper

TwoSigmaUpper is optional. A single instance might exist.

Two sigma (a measure of dispersion associated with standard deviation) on the upper side of the standard deviation.

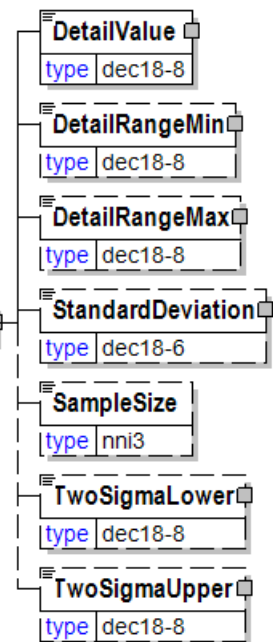

BookBlock

The text block plus the endpapers and other materials added by the binder before cover is applied.

(sequence)

The sequence of items below is mandatory. A single instance is required.

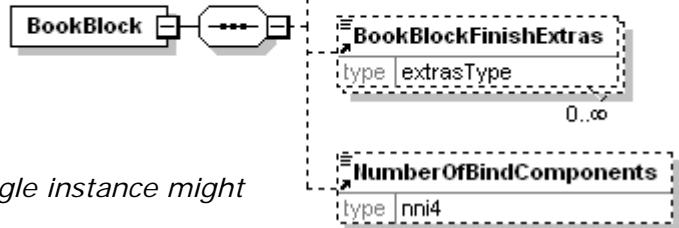

BookBlockBulk

BookBlockBulk is optional. A single instance might exist.

Measurement of the thickness of the book block.

BookBlockEdgeTrim

BookBlockEdgeTrim is optional. Multiple instances might exist.

Specifications for the trimming the edges of the book.

BookBlockFinishExtras

BookBlockFinishExtras is optional. Multiple instances might exist.

Additional instructions for finishing.

Refer to BookBlockFinishExtras definition for any enumerations.

NumberOfBindComponents

NumberOfBindComponents is optional. A single instance might exist.

Total number of components contained in the book block.

BookBlockBulk

Measurement of the thickness of the book block.

(sequence)

The sequence of items below is mandatory. A single instance is required.

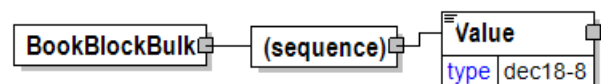

Value

Value is mandatory. A single instance is required.

A numeric value expressed in the unit of measure (UOM).

BookBlockEdgeTrim

Specifications for the trimming the edges of the book.

EdgeLocationType [attribute]

EdgeLocationType is optional. A single instance might exist.

Edge location type.

Refer to EdgeLocationType definition for any enumerations.

(sequence)

The sequence of items below is mandatory. One instance is required, multiple instances might exist.

EdgeFinish

EdgeFinish is mandatory. A single instance is required.

The finish applied to the edge.

Refer to EdgeFinish definition for any enumerations.

ColourSpecs

ColourSpecs is optional. A single instance might exist.

Colour specs

AdditionalText

AdditionalText is optional. Multiple instances might exist.

A text field that is used to communicate information not previously defined or for special instructions. To be used only for circumstances not covered by specific elements.

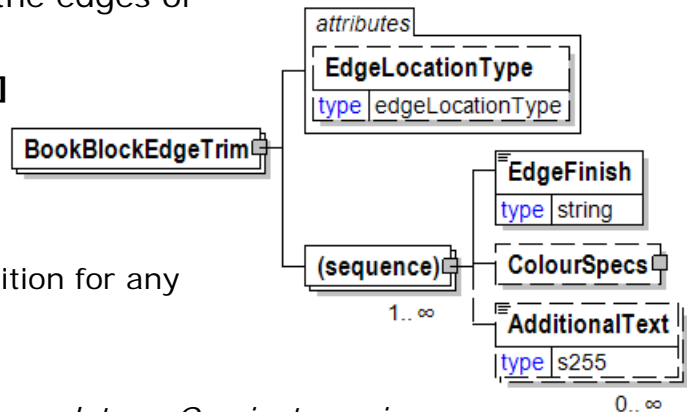

BookBlockFinishExtras

Additional instructions for finishing.

This item is restricted to the following list.

DieCut

Cut irregular shapes in paper or paperboard using a die.

RoundedCorners

Process of using a die to cut the thumb-edge corners into a rounded shape.

ThumbCuts

Notch on the open ends of a page making it easy to grasp. ThumbCuts.

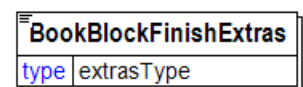

BookClassification

Category under which the product or a component within the product is classified.

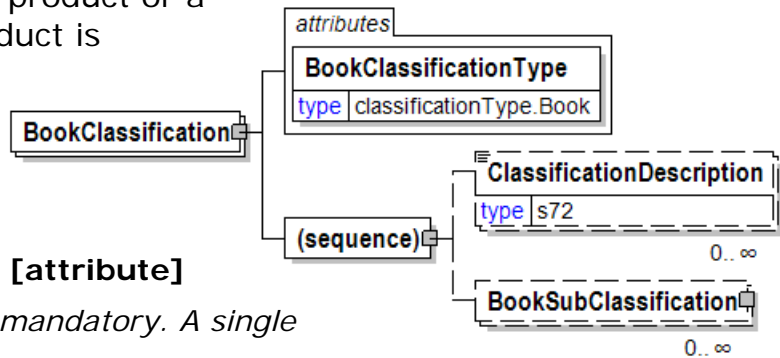

BookClassificationType [attribute]

BookClassificationType is mandatory. A single instance is required.

Category under which the product or a component within the product is classified.

Refer to BookClassificationType definition for any enumerations.

(sequence)

The sequence of items below is mandatory. A single instance is required.

ClassificationDescription

ClassificationDescription is optional. Multiple instances might exist.

A free form description of the classification.

BookSubClassification

BookSubClassification is optional. Multiple instances might exist.

Sub Category of the BookClassification under which the product or a component within the product is classified.

BookClassificationType [attribute]

Category under which the product or a component within the product is classified.

This item is restricted to the following list.

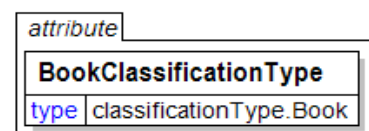

Assembly

A finished product or component consisting of components that have been fitted together.

Audio

Audio component such as an audio CD or DVD containing recording of acoustic signals.

Binding

Component used in the book binding process.

Book

Written work or composition printed on pages bound together that have been published.

Box

A container with a flat base and sides, typically square or rectangular and

having a lid or flaps that close.

Cover

Component used as a protective covering to bind together the pages of a book.

Endsheet

The pages at the beginning and end of a volume are added to both protect the textblock and to secure it into the cover.

Envelope

A paper or cardboard wrapper used to enclose and small, flat items such as a letter for mailing.

FinishedGoods

Goods that have completed the manufacturing process but have not yet been sold or distributed to the end user.

Insert

A loose page or section that is manufactured separately from the text pages.

Jacket

A paper cover sometimes called the "dust cover" of a hardbound book.

Kit

Assembled components that comprise a finished product or package.

Label

A piece of paper, polymer, cloth, metal, or other material affixed to a container or article, on which is printed a legend, information concerning the product, addresses, etc. A label may also be printed directly on the container or article.

Material

Tangible substance that goes into the makeup of the finished product.

Media

Films, tapes, and other audio-visual materials that require the use of special listening or viewing equipment.

MediaHolder

Device specifically designed to hold the media material.

MultiVolumeSet

Product that is comprised of multiple books/volumes.

Other

Part of a finished product that is not a book component such as a toy. The ClassificationDescription can be used to describe the part in more detail.

Packaging

Materials used for the containment, protection, handling, delivery and presentation of goods and the activities of placing and securing goods in those materials.

Prep

Materials or files required in the preparation for printing.

SlipCase

Four or five-sided box, usually made of high-quality cardboard, into which binders, books or book sets are slipped for protection.

Text

The main body of a book or other piece of writing.

Video

Video component such as a CD or DVD containing moving visual images.

Wrap

The covering (usually paper or cellophane) in which something is wrapped.

BookManufacturing

BookManufacturing is a group element that contains the elements that describe the book manufacturing process.

(sequence)

The sequence of items below is mandatory. A single instance is required.

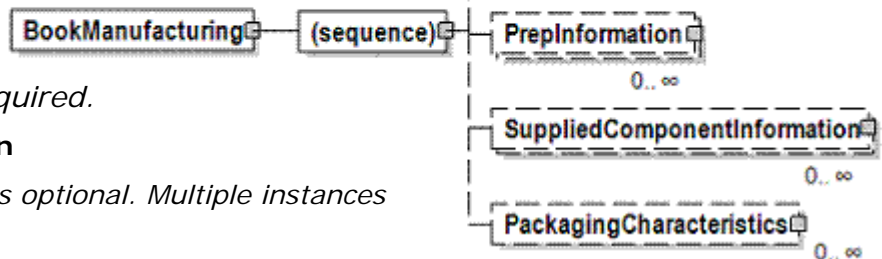

BookClassification

BookClassification is optional. Multiple instances might exist.

Category under which the product or a component within the product is classified.

ProofInformationalQuantity

ProofInformationalQuantity is optional. Multiple instances might exist.

ProofInformationalQuantity

PreInformation

PreInformation is optional. Multiple instances might exist.

Information related to the preparation of the Book.

SuppliedComponentInformation

SuppliedComponentInformation is optional. Multiple instances might exist.

Information about components supplied by the publisher to the vendor i.e. paper supplied to the print vendor or jackets supplied to the bind vendor.

PackagingCharacteristics

PackagingCharacteristics is optional and repeatable.

An element containing carton or pallet packing information. PackagingCharacteristics can either have the BoxCharacteristics or PalletPackagingCharacteristics element not both.

BookPackageInformation

The purpose of the BookPackageInformation structure is to clearly identify physical handling items that constitute the delivery.

BookPackageInformation is the highest level of product packaging and describes the shipping or warehousing unit.

PackageType [attribute]

PackageType is mandatory. A single instance is required.

Communicates the configuration of the item being reported.

Refer to PackageType definition for any enumerations.

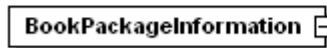

MixedProductPalletIndicator [attribute]

MixedProductPalletIndicator is optional. A single instance might exist.

Specifies whether a product can be mixed with other products on the same pallet

Refer to MixedProductPalletIndicator definition for any enumerations.

IsPartialIndicator [attribute]

IsPartialIndicator is optional. A single instance might exist.

Specifies if the container (e.g. pallet, box) is partially full or not.

Refer to IsPartialIndicator definition for any enumerations.

(sequence)

The sequence of items below is mandatory. A single instance is required.

Identifier

Identifier is mandatory. One instance is required, multiple instances might exist.

An Identifier is required for packages and items (pallets, reel packages, boxes, ream items, reel items, etc). The Identifier element contains the actual item identifier code. Identifier is repeatable so more than one identifier can be communicated. For example, the printed identifier on a label may be different from the barcode printed on the label.

RawMaterialSet

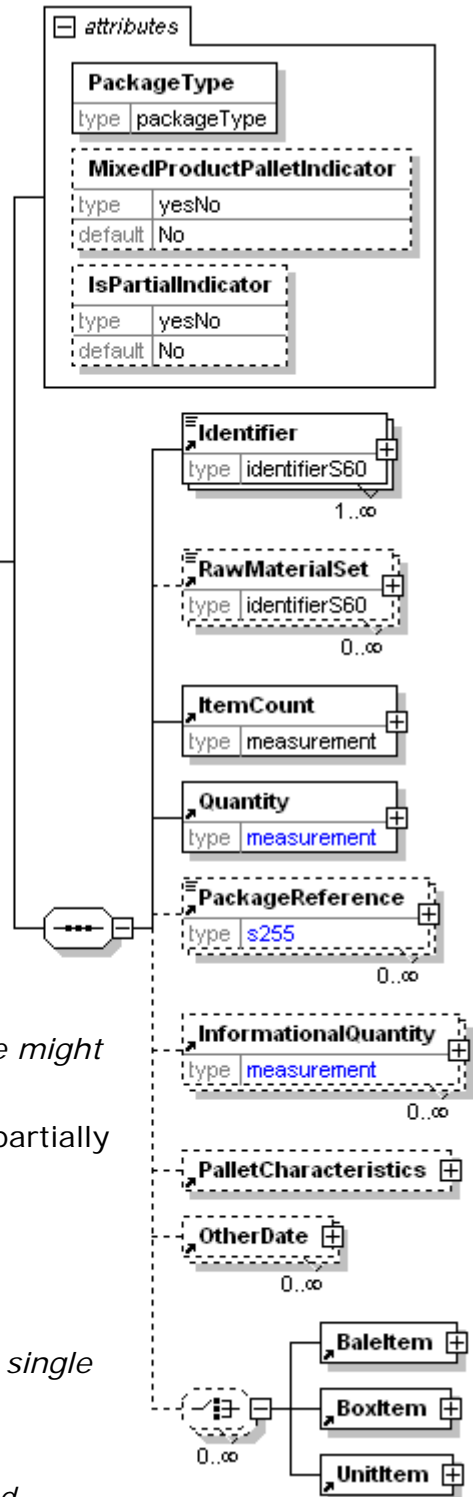

papiNet V2R31

RawMaterialSet is optional. Multiple instances might exist.

This identifier derived element indicates a grouping of raw materials that were used to manufacture the product.

ItemCount

ItemCount is mandatory. A single instance is required.

A count of the number of items (examples: a count of the number of boxes on a pallet or of reams in a box).

Quantity

Quantity is mandatory. A single instance is required.

The Quantity element contains attributes that provide information about the type of quantity that is being communicated, the context in which the particular quantity is to be viewed, and (if the quantity represents an adjustment) an adjustment type.

The Quantity element contains three child elements that enable you to communicate a range of values for the quantity and a target or actual value. It is at this level (Value, RangeMin, and RangeMax) that the unit of measure is specified. This permits the range to be specified in a different unit of measure than the target.

PackageReference

PackageReference is optional. Multiple instances might exist.

An element detailing the relevant references pertaining to a package. The type of reference is identified by the attributes PackageReferenceType and AssignedBy.

InformationalQuantity

InformationalQuantity is optional. Multiple instances might exist.

A quantity given in a valid UOM used for information purposes only (not for calculation). For example, an ordered quantity was 100 reels as opposed to the invoice quantity of 20,000 pounds.

PalletCharacteristics

PalletCharacteristics is optional. A single instance might exist.

A group item that provides pallet detail information.

OtherDate

OtherDate is optional. Multiple instances might exist.

A date that may not be specifically detailed within a document (example: print date at the PurchaseOrderLineItem).

(choice)

[choice] is optional because of choice construct.

BaleItem

BaleItem is optional because of choice construct.

An individual bale included as part of a delivery.

BoxItem

BoxItem is optional because of choice construct.

A four-sided container for reams or sheet items. A pallet can contain zero or more boxes. The term Carton is a synonym for BoxItem. The term "Box" is used as constraint within the ItemType attribute of the UsageLineItemDetail to refer to a box that contains other boxes.

UnitItem

UnitItem is optional because of choice construct.

Unit Item.

BookSpecification

The BookSpecification element is the root element for the BookSpecification e-Document.

The BookSpecification e-Document represents established product specifications that can be referenced by multiple transactions in the manufacturing life cycle of a product from RFQ through Invoice and subsequent reprints and/or reorders. It captures unique book manufacturing industry data elements as established by the buyer that are needed by the supplier for manufacturing.

SpecType [attribute]

SpecType is optional. A single instance might exist.

Used to identify what type of BookSpecification e-Document this transaction is.

Refer to SpecType definition for any enumerations.

SpecStatusType [attribute]

SpecStatusType is optional. A single instance might exist.

Identifies the status of the entire BookSpecification e-Document (in other words, at the root level).

Refer to SpecStatusType definition for any enumerations.

NASTA [attribute]

NASTA is optional. A single instance might exist.

Indicates if the specification must conform to the NASTA (National Association of State Textbook Administrators) requirements.

Refer to NASTA definition for any enumerations.

ChildrensTitle [attribute]

ChildrensTitle is optional. A single instance might exist.

Specifies if the book product is designated for use by children 12 and under or

BookSpecification

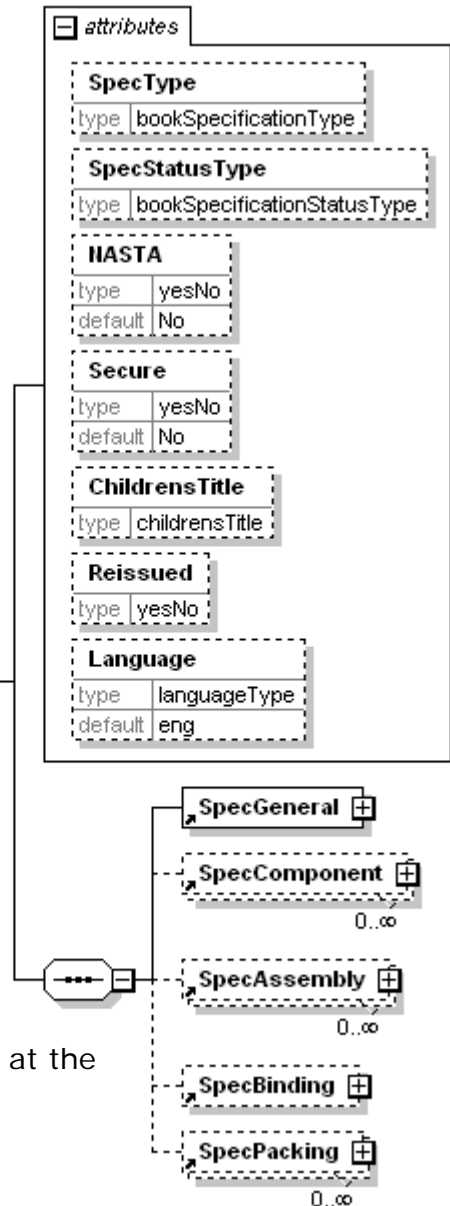

not.

Refer to ChildrensTitle definition for any enumerations.

Secure [attribute]

Secure is optional. A single instance might exist.

This attribute indicates that the product requires a secure manufacturing plant. For example when manufacturing ACT booklets and other testing products.

Refer to Secure definition for any enumerations.

Reissued [attribute]

Reissued is optional. A single instance might exist.

Either "Yes" or "No".

Refer to Reissued definition for any enumerations.

Language [attribute]

Language is optional. A single instance might exist.

XML has embraced 2 and 3 digit language codes through the application of an addendum to the standard.

Refer to Language definition for any enumerations.

(sequence)

The sequence of items below is mandatory. A single instance is required.

SpecGeneral

SpecGeneral is mandatory. A single instance is required.

Spec General

SpecComponent

SpecComponent is optional. Multiple instances might exist.

Group element used to identify all the necessary component information for this BookSpecification.

Each occurrence of this construct identifies a single component.

SpecAssembly

SpecAssembly is optional. Multiple instances might exist.

SpecAssembly contains assemblies that are used in the manufacturing of books.

SpecBinding

SpecBinding is optional. A single instance might exist.

SpecBinding describes the binding process.

SpecPacking

SpecPacking is optional. Multiple instances might exist.

SpecPacking defines the book packaging parameters.

BookSubClassification

Sub Category of the BookClassification under which the product or a component within the product is classified.

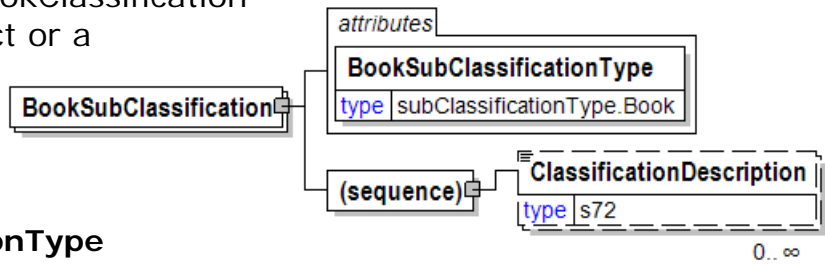

BookSubClassificationType [attribute]

BookSubClassificationType is mandatory. A single instance is required.

Sub Category of the BookClassification under which the product or a component within the product is classified.

Refer to BookSubClassificationType definition for any enumerations.

(sequence)

The sequence of items below is mandatory. A single instance is required.

ClassificationDescription

ClassificationDescription is optional. Multiple instances might exist.

A free form description of the classification.

BookSubClassificationType [attribute]

Sub Category of the BookClassification under which the product or a component within the product is classified.



This item is restricted to the following list.

2PieceCarton

Type of box where there is a lid that is separate from the bottom.

AccessCode

A printed card or page that contains a unique code for the purpose of accessing a secure service or device

Acetate

Component produced with Acetate material which is a transparent or translucent plastic sheet material of a variety of colors, used as a basis for artwork and overlays.

AdvertisingBrochure

Component printed for purpose of advertising.

Album

Product manufactured with loose-leaf pages bound by drilling (hole punching).

Assembly

Product that requires assembly to complete the finished good that usually includes the book and other items such as CDs, toys, etc.

Audio

Audio is a form of multimedia that allows the listener to hear information.

BackCoverPanelwShrinkwrap

Component packaged on the back cover of the book by shrinkwrapping.

BackMatter

Printed matter (usually explanatory) following the main body text of a book, e.g. appendices, bibliography, index etc.

BarCode

Printed matter (usually explanatory) following the main body text of a book, e.g. appendices, bibliography, index etc.

BellyBand

Small strip of paper that wraps around the cover of a book like a dust jacket that usually contains brief publishing information, such as price, printing statement, etc.

also known as a "book band" or "jacket band".

Binder

A cover or holder for unbound papers, pages etc.

Binding

Process of physically assembling a book from a number of folded or unfolded sheets of paper or other material; it also usually involves attaching covers to the resulting book-block.

Bind-inSleeve

Plastic or paper insert that contains a pocket for holding a CD or DVD and is bound inside of the book.

BlisterPak

Pre-formed clear plastic packaging.

BlownIn

Printed promotional piece that is inserted by machine using a "fanning" process during the final production stage of a publication.

BluRay

An optical disc storage medium designed to supersede the standard DVD format.

Book

A written work or composition that has been published (printed on pages bound together).

Bookblock

The gathered and glued or sewn signatures, inserts and other components of the book before the cover is added.

Bookmark

A marker (a piece of paper or ribbon) placed between the pages of a book to

mark the reader's place.

Bound

Secured with a cover or binding.

Box

Box describes a variety of containers and receptacles.

BoxWrap

Material for wrapping the box.

Brochure

A booklet of printed informational matter, like a pamphlet, often for promotional purposes.

BubbleBag

Bags made from bubble cushioning material constructed of pockets of air locked between a top and bottom layer of linear low density polyethylene film.

Card

Type of insert that is usually printed on heavy card stock and placed somewhere in the finished product.

Carton

A specific type of box or container usually made of paperboard and often of corrugated paperboard in which the finished product is packaged.

CaseCover

The cover of a Hardback (casebound) book, usually made of cloth or similar material and boards.

Cassette

A container that holds a magnetic tape used for recording or playing sound or video.

CassetteHolder

A holder usually made of plastic designed to hold the cassette.

CD

Compact Disc; High density storage media based on a 4.75" reflective optical disc.

CD-ROM

Version of the CD that allows the information to be stored and retrieved; once a CD-ROM is pressed, new data cannot be stored and the disc cannot be erased for reuse.

Cloth

Material used for making a casecover.

CompanyOwnedStock

Refers to material that is owned by the publisher.

Cover

Material used on the outside of the book block; refers to the front, back and spine of the book.

CoverBack

Indicates the back cover location.

CoverFront

Indicates the front cover location.

Disk

Generic term for Diskettes, CDs, DVDs.

Diskette

A flexible, oxide-coated disk used to store data.

DisketteSleeve

Plastic or paper insert that contains a pocket for holding the diskette.

Divider

Type of insert that is usually printed on heavy paper and used to divide sections or chapters of a book.

Documentation

The systematic collection of research materials via writing, interviewing, audio and video recording, and photography.

DoubleWallCarton

Corrugated card consisting of a layer of paper / corrugated paper / paper / corrugated paper and finally another layer of paper.

DVD

Digital Versatile Disk; high-capacity optical disk that looks like a CD, but can store much more information.

EconoWrap

A 'fit to book size' low cost thin layer paper container used to package a single book.

EndSheet

Four pages each at the beginning and end of a casebound book, one leaf of each being solidly pasted against the inside board of the case; stock is stronger and heavier than text stock and may be white or colored stock, printed or unprinted. Also called Endpapers, End-leaves or Lining Papers.

EndsheetBack

Specifies the Endsheets that is used to attach the back cover to the book block.

EndsheetFront

Specifies the Endsheets that is used to attach the front cover to the book block.

Envelope

Packaging product, usually made of flat, planar material such as paper or cardboard, and designed to contain a flat object, which in a postal-service context is usually a letter, card or bills.

FinishedGood

Completed products awaiting sale.

FlatSheet

State of a printed sheetfed component before the flatcut/trimming process.

FoldedAndGatheredSig

State of the signature before the trimming process.

FrontMatter

Printed matter preceding the main body text of a book, e.g. teacher's guide.

Gatefold

Flap from the fore-edge, with a fold running parallel to the spine of the book. The finished page is marginally smaller than the normal trimmed page. A double fold, usually of card or heavy board, from the two outside edges of a folder. The two folded pages meet in the centre of the page, edge to edge, rather like a double gate.

HalfJacket

Component, similar to a Jacket, placed around a book to protect the cover; the difference is that this component only partially covers the cover and is glued inside.

Handbook

A reference book that provides concise, useful data and other information on a specific subject.

HollowWrap

A 'fit to book size' low cost paperboard and fluted material container used to package a single book.

Insert

Specially printed piece for insertion in a publication.

Jacket

Component placed around a case-bound book to protect the cover.

Jcard

Paper card that forms a "J" shape when folded, similar to a Ucard, that is inserted in the plastic storage case of most pre-recorded audio cassette releases; the j-card usually contains an image of the album cover, a track listing, credits, and copyright information.

JewelCase

The hinged plastic case in which most CDs are often stored.

Jiffy

Thick envelope.

Jwrap

Cover-like wrapper that is used to wrap gathered and trimmed signatures.

Label

Piece of paper, polymer, cloth, metal, or other material affixed to a container or article, on which is printed a legend, information concerning the product, addresses, etc.; a label may also be printed directly on the container or article.

LaserDisc

A record-like storage medium that uses analogue and laser optical technology to store images.

Liner-Corrugation

Generic term for any paper that functions as a covering for other paper or board material through adhesion, making it a part of the finished product.

Loose

Insert that is not bound into the book.

MakeReady

Machine preparation for each operation in the manufacturing process.

Map

Visual representation of an area.

Material

Refers to paper, cloth or other tangible substance used in the manufacturing of the component or finished good.

Media

Storage devices for audio, video.

MediaHolder

Holder designed for storing/protection of the media.

OWrap

Wrap that fully circles the book (head to foot) and is usually used on shrinkwrapped products.

Packaging

Enclosing or protecting products for distribution, storage, sale, and use.

Paper

Material made of cellulose pulp derived mainly from wood used for the printing process.

PaperCover

Printed sheet used for the outside cover of the book.

PeelStickCD

CD package is made from an adhesive paper-backed material that is applied by removing the paper and exposing the adhesive.

Pocket

Paper, cloth, vinyl or other material made into a pocket either with or without gussets and affixed inside the front or back cover of the book.

PolyBag

Bags are made from 100% virgin polyethylene resin.

Prep

Creation of plates from film or electronic files for the printing process.

Preprinted

Component is printed prior to the manufacturing step.

PreprintedCaseside

Indicates a hardcover created from a printed cover vs. case material.

Proof

A facsimile of press pages for review

ReplyCard

Sender-addressed card included in a mailing on which the recipient indicates a response (positive or negative) to an offer.

Run

"Good" copies produced in each operation in the manufacturing process.

SheetSignature

Refers to the printing of a signature on a sheetfed press.

SheetWise

Sheetfed process where the frontside of all of the components are imposed on one side of the sheet and printed; the plates are changed and then the sheets are then turned over and run back through the press thus completing both sides of the components.

Shrinkwrapping

Protective wrapping for the product made from heat-shrink polyfilm.

Signature

Folded, printed sheet or part of a sheet which forms a section of multiple pages of a book or publication in numerical sequence.

SingleWallCarton

Corrugated card consisting of an outer paper (usually kraft), a single layer of corrugated paper followed by a further layer of paper (usually test).

Skagg

A low cost thin layer paper container used to package a single book.

Sleeve

Plastic or paper insert that contains a pocket for holding another component, usually a type of media.

Slide

Still, positive image created on a transparent base using photochemical means.

SlimPack

CD or DVD slim hinged plastic case in which CDs are stored.

SlipCase

Protective box that holds a book or set of books; slip cases can be made from any material, most often cloth or paper covered cardboard.

SlipCaseWrap

Protective wrapping for a slipcase.

SoftwareAccessCode

A printed card or page that contains a unique code for the purpose of accessing protected software.

SoftwareStyle

A folding carton with top & bottom flaps that includes a "door" on the front of the package with a velcro closure; the purpose is to allow 4 complete surfaces to hold marketing copy.

Spine

Part of a book's cover or jacket, visible when the book is on a shelf.

Sticker

Gummed or adhesive label.

SubAssembly

Group of components that is part of the completed project.

SuperJWrap

Same as Jwrap with the addition of a scored tab which covers the bottom portion of the spine of the book.

TCarton

A carton including a wraparound corner locking flap construction comprising a T-shaped first element joined to part of the carton and two other elements joined to another part of the carton.

Tab

Insert form where a small flap projects out from the thumb edge used for quick access.

Text

The written or printed material which forms the main body of a book.

Transparency

Piece of clear or colored plastic or film used with an overhead projector to make presentations.

Transvision

Set of transparencies that are placed together to create a "full" image but individually contain separate images such as the human body systems.

Ucard

Paper card that forms a "U" shape when folded, similar to a Jcard, that is inserted in the plastic storage case of mostpre-recorded audio cassette releases; the j-card usually contains an image of the album cover, a track listing, credits, and copyright information

Video

Series of framed images put together, one after another, to simulate motion and interactivity.

VinylPack

Vinyl material for vacuum packing.

WebSignature

Component printed on a web press.

WorkAndBack

Sheetfed process where the press contains enough units to print the front and back of each component in one press run.

WorkAndTurn

Sheetfed process where the frontside of half of the components and the backside of the remaining components are imposed on one side of the sheet and printed; the sheets are then turned over and run back through the press in the exact same position thus completing both sides of the components without changing the plates.

Wrap

The cover of a paperback book or covers of a magazine, often printed on colored paper.

ZipLockBag

Disposable, re-sealable zipper storage bags and containers.

BookUnitPacking

Book unit packing information

BookUnitType [attribute]

BookUnitType is optional. A single instance might exist.

Book unit type

Refer to BookUnitType definition for any enumerations.

PackageType [attribute]

PackageType is optional. A single instance might exist.

Communicates the configuration of the item being reported.

Refer to PackageType definition for any enumerations.

(sequence)

The sequence of items below is mandatory. A single instance is required.

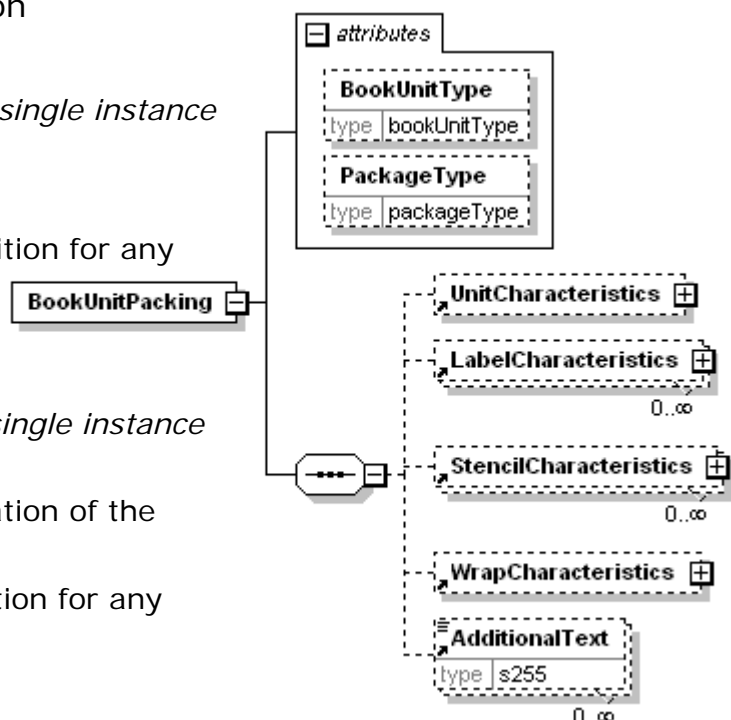

UnitCharacteristics

UnitCharacteristics is optional. A single instance might exist.

Unit characteristics.

LabelCharacteristics

LabelCharacteristics is optional. Multiple instances might exist.

A group item that organises the labeling information.

StencilCharacteristics

StencilCharacteristics is optional. Multiple instances might exist.

A group element specifying attributes of a stencil to be applied to an item, and optional text.

WrapCharacteristics

WrapCharacteristics is optional. A single instance might exist.

A group element that contains elements that describe the manner in which the item is wrapped.

AdditionalText

AdditionalText is optional. Multiple instances might exist.

A text field that is used to communicate information not previously defined or for special instructions. To be used only for circumstances not covered by specific elements.

BookUnitType [attribute]

Book unit type

This item is restricted to the following list.

Unit

The book unit is free standing.

Unit pre-Assembly

The book unit requires previous assembly.

Unit post-Assembly

The book unit requires post assembly.

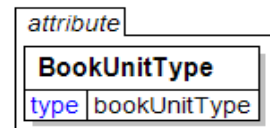

BooleanValue

A value in boolean format.

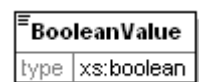

BoxCharacteristics

BoxCharacteristics is a group element that contains information about the box (or carton)

BoxType [attribute]

BoxType is optional. A single instance might exist.

Communicates the type of carton to use
Refer to BoxType definition for any enumerations.

BoxCharacteristics

BoxMeasurementsAppliesTo [attribute]

BoxMeasurementsAppliesTo is optional. A single instance might exist.

Used to indicate the nature of the endpoints of the measurement type.
Refer to BoxMeasurementsAppliesTo definition for any enumerations.

(sequence)

The sequence of items below is mandatory. A single instance is required.

ProductIdentification

ProductIdentification is optional. A single instance might exist.

A grouping element designed to communicate product identification related to the parent element that contains this item.

Height

Height is optional. A single instance might exist.

The height of the object.

Length

Length is optional. A single instance might exist.

The length of the object.

Width

Width is optional. A single instance might exist.

The width of the object.

Weight

Weight is optional. A single instance might exist.

The weight of the item.

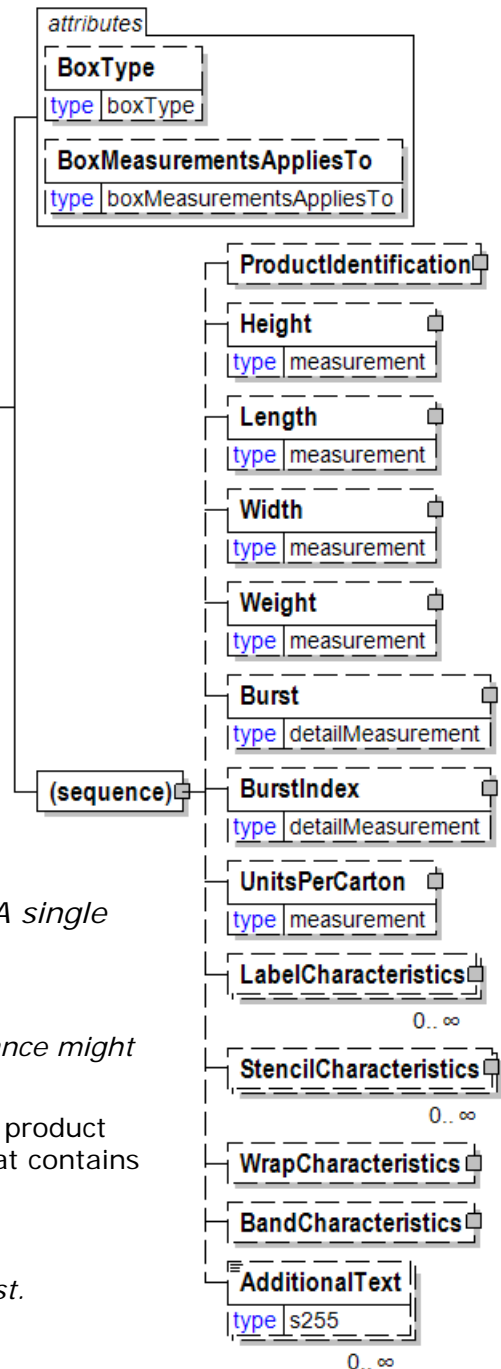

Burst

Burst is optional. A single instance might exist.

A group item used to communicate bursting strength target or test value according to a particular TestMethod.

BurstIndex

BurstIndex is optional. A single instance might exist.

The burst index.

UnitsPerCarton

UnitsPerCarton is optional. A single instance might exist.

The number of units per box.

LabelCharacteristics

LabelCharacteristics is optional. Multiple instances might exist.

A group item that organises the labeling information.

StencilCharacteristics

StencilCharacteristics is optional. Multiple instances might exist.

A group element specifying attributes of a stencil to be applied to an item, and optional text.

WrapCharacteristics

WrapCharacteristics is optional. A single instance might exist.

A group element that contains elements that describes the manner in which the item is wrapped.

BandCharacteristics

BandCharacteristics is optional. A single instance might exist.

A group item that organises the packaging band detail information.

AdditionalText

AdditionalText is optional. Multiple instances might exist.

A text field that is used to communicate information not previously defined or for special instructions. To be used only for circumstances not covered by specific elements.

BoxItem

A four-sided container for reams or sheet items. A pallet can contain zero or more boxes. The term Carton is a synonym for BoxItem. The term "Box" is used as constraint within the ItemType attribute of the UsageLineItemDetail to refer to a box that contains other boxes.

MixProductIndicator [attribute]

MixProductIndicator is optional. A single instance might exist.

Specifies whether a product can be mixed with other products on the same shipment.

Refer to MixProductIndicator definition for any enumerations.

IsPartialIndicator [attribute]

IsPartialIndicator is optional. A single instance might exist.

Specifies if the container (e.g. pallet, box) is partially full or not.

Refer to IsPartialIndicator definition for any enumerations.

(sequence)

The sequence of items below is mandatory. A single instance is required.

Identifier

Identifier is optional. Multiple instances might exist.

An Identifier is required for packages and items (pallets, reel packages, boxes, ream items, reel items, etc). The Identifier element contains the actual item identifier code. Identifier is repeatable so more than one identifier can be communicated. For example, the printed identifier on a label may be

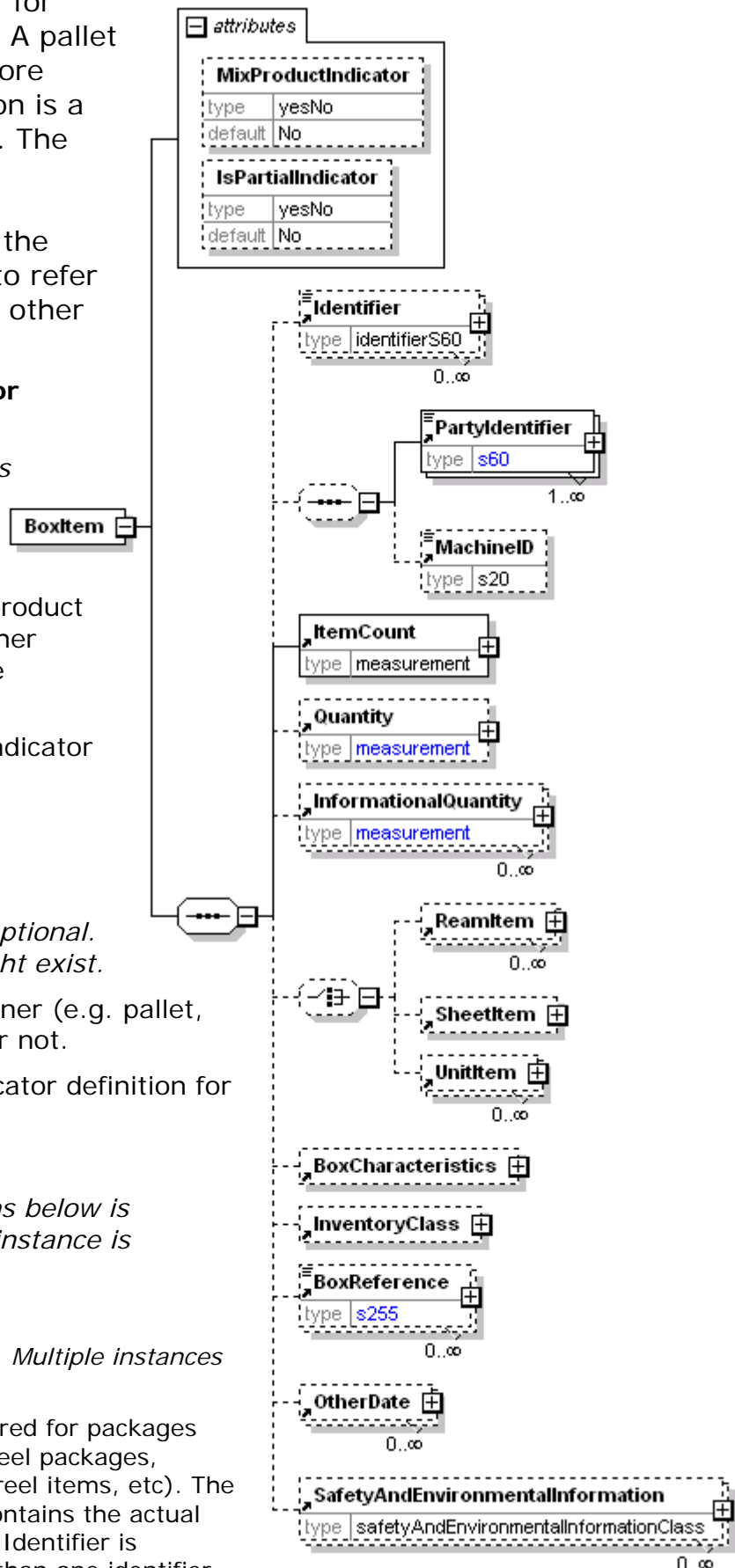

different from the barcode printed on the label.

(sequence)

The sequence of items below is optional. A single instance might exist.

PartyIdentifier

PartyIdentifier is mandatory. One instance is required, multiple instances might exist.

A unique identifier of a specific party. This element contains an attribute PartyIdentifierType that indicates the type of party.

MachineID

MachineID is optional. A single instance might exist.

An identifier assigned to the particular machine being referenced. For example, a machine could be a paper machine, an off-line coater, a sheeter, or a printing press. The particular machine being referenced will be determined by the business event being supported.

ItemCount

ItemCount is mandatory. A single instance is required.

A count of the number of items (examples: a count of the number of boxes on a pallet or of reams in a box).

Quantity

Quantity is optional. A single instance might exist.

The Quantity element contains attributes that provide information about the type of quantity that is being communicated, the context in which the particular quantity is to be viewed, and (if the quantity represents an adjustment) an adjustment type.

The Quantity element contains three child elements that enable you to communicate a range of values for the quantity and a target or actual value. It is at this level (Value, RangeMin, and RangeMax) that the unit of measure is specified. This permits the range to be specified in a different unit of measure than the target.

InformationalQuantity

InformationalQuantity is optional. Multiple instances might exist.

A quantity given in a valid UOM used for information purposes only (not for calculation). For example, an ordered quantity was 100 reels as opposed to the invoice quantity of 20,000 pounds.

(choice)

[choice] is optional because of choice construct.

ReamItem

ReamItem is optional because of choice construct.

A wrapped quantity of SheetItem(s).

SheetItem

SheetItem is optional because of choice construct.

A group item consisting potentially of the date the sheets were converted into sheets and/or packaged or finished.

UnitItem

UnitItem is optional because of choice construct.

Unit Item.

BoxCharacteristics

BoxCharacteristics is optional. A single instance might exist.

BoxCharacteristics is a group element that contains information about the box (or carton)

InventoryClass

InventoryClass is optional. A single instance might exist.

A group item containing information about status of inventory and goods items.

BoxReference

BoxReference is optional. Multiple instances might exist.

An element detailing relevant references pertaining to the Box. The type of reference is identified by the attributes BoxReferenceType and AssignedBy.

OtherDate

OtherDate is optional. Multiple instances might exist.

A date that may not be specifically detailed within a document (example: print date at the PurchaseOrderLineItem).

SafetyAndEnvironmentalInformation

SafetyAndEnvironmentalInformation is optional. Multiple instances might exist.

Name of certification type, if any, on the goods (For example, FSC, PEFC). SafetyAndEnvironmental needs a value or measurement to communicate the percentage of the product is certified (for example, 75% is certified by the indicated agency).

BoxMeasurementsAppliesTo [attribute]

Used to indicate the nature of the endpoints of the measurement type.

This item is restricted to the following list.

Inside

The measurements provided are for the inside of the box.

Outside

The measurements provided apply to the outside of the box.

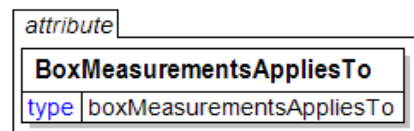

BoxReference

An element detailing relevant references pertaining to the Box. The type of reference is identified by the attributes BoxReferenceType and AssignedBy.

BoxReferenceType [attribute]

BoxReferenceType is mandatory. A single instance is required.

Provides a contextual explanation of the specific reference identifier. Many

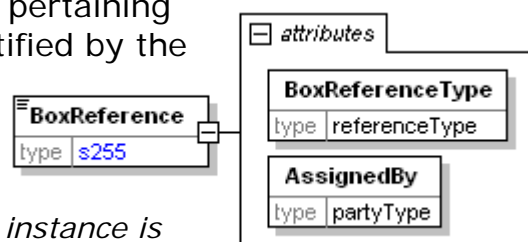

items are currently prefixed by "Buyer", "Forwarder", "Manufacturer", "Mill", "Seller", "Supplier", "Warehouse", or "Vendor". Check for an existing non-prefixed version and use the non-prefixed version instead. In the (yet to be announced release date) version 3.0 the prefixed versions will be removed. Instead the attribute @AssignedBy will communicate the information previously communicated in the prefix.

Refer to BoxReferenceType definition for any enumerations.

AssignedBy [attribute]

AssignedBy is mandatory. A single instance is required.

Identifies the type of party that has assigned the associated item, e.g. a reference of type OrderNumber.

Refer to AssignedBy for any enumerations.

BoxReferenceType [attribute]

Provides a contextual explanation of the specific reference identifier. Many items are currently prefixed by "Buyer", "Forwarder", "Manufacturer", "Mill", "Seller", "Supplier", "Warehouse" or "Vendor". Check for an existing non-prefixed version and use the non-prefixed version instead. In the (yet to be announced release date) version 3.0 the prefixed versions will be removed. Instead the attribute AssignedBy will communicate the information previously communicated in the prefix.

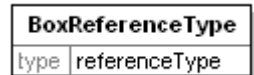

Refer to the [referenceType](#) entry for the list of enumerations and their definitions.

BoxType [attribute]

Communicates the type of carton to use

This item is restricted to the following list.

Corrugated

The carton type is grooved.

DoubleWall

The carton type has a double wall.

SingleWall

The carton type has a single wall.

TripleWall

The carton type has a triple wall.

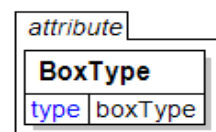

Brand

Specifies a brand or trade name of wrapping material to be used when wrapping the product.

Brand	
type	s30

Brightness

A measurement of the degree of light reflectivity of the product.

TestMethod [attribute]

TestMethod is optional. A single instance might exist.

The method used to determine the results of the test under consideration.

TestAgency [attribute]

TestAgency is optional. A single instance might exist.

The agency that has set the parameters for the testing

Refer to TestAgency definition for any enumerations.

SampleType [attribute]

SampleType is optional. A single instance might exist.

Communicates how sampling was done to measure the product characteristics.

Refer to SampleType definition for any enumerations.

ResultSource [attribute]

ResultSource is optional. A single instance might exist.

Used to define the data source of the specified test

Refer to ResultSource definition for any enumerations.

(sequence)

The sequence of items below is mandatory. A single instance is required.

DetailValue

DetailValue is mandatory. A single instance is required.

A numeric value expressed in the unit of measure (UOM).

DetailRangeMin

DetailRangeMin is optional. A single instance might exist.

The minimum value (lower boundary) allowed for the DetailValue that is the parent of this element.

DetailRangeMax

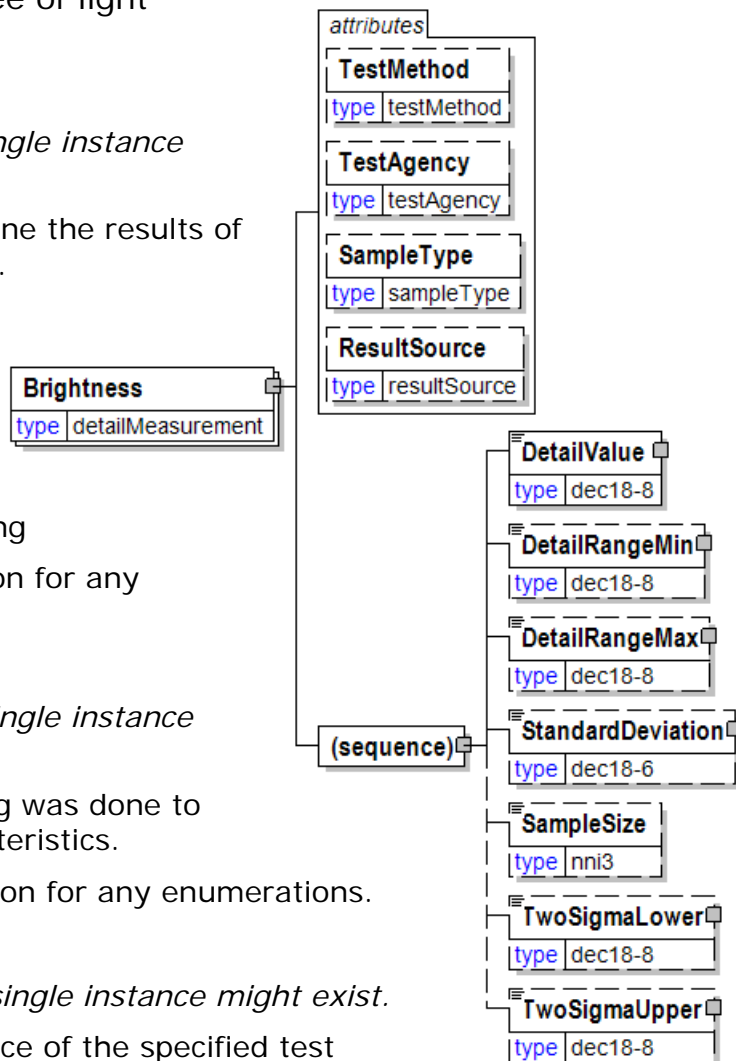

DetailRangeMax is optional. A single instance might exist.

The maximum value (upper boundary) allowed for the DetailValue that is the parent of this element.

StandardDeviation

StandardDeviation is optional. A single instance might exist.

A statistic used as a measure of dispersion in a distribution.

SampleSize

SampleSize is optional. A single instance might exist.

The number of samples used to determine the product characteristic in question.

TwoSigmaLower

TwoSigmaLower is optional. A single instance might exist.

Two sigma (a measure of dispersion associated with standard deviation) on the lower side of the standard deviation.

TwoSigmaUpper

TwoSigmaUpper is optional. A single instance might exist.

Two sigma (a measure of dispersion associated with standard deviation) on the upper side of the standard deviation.

Brilliance

Measure of brilliance in the HSB colour approach.

(sequence)

The sequence of items below is mandatory. A single instance is required.

DetailValue

DetailValue is mandatory. A single instance is required.

A numeric value expressed in the unit of measure (UOM).

DetailRangeMin

DetailRangeMin is optional. A single instance might exist.

The minimum value (lower boundary) allowed for the DetailValue that is the parent of this element.

DetailRangeMax

DetailRangeMax is optional. A single instance might exist.

The maximum value (upper boundary) allowed for the DetailValue that is the parent of this element.

StandardDeviation

StandardDeviation is optional. A single instance might exist.

A statistic used as a measure of dispersion in a distribution.

SampleSize

SampleSize is optional. A single instance might exist.

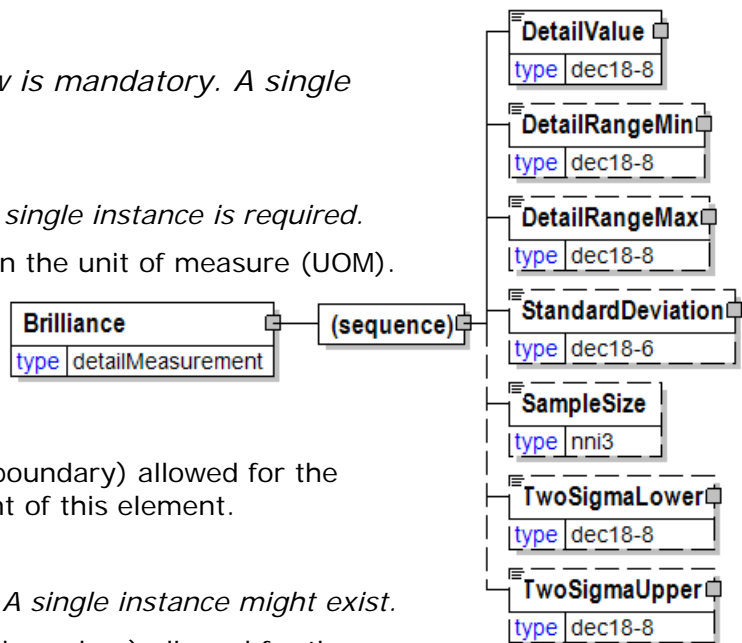

papiNet V2R31

The number of samples used to determine the product characteristic in question.

TwoSigmaLower

TwoSigmaLower is optional. A single instance might exist.

Two sigma (a measure of dispersion associated with standard deviation) on the lower side of the standard deviation.

TwoSigmaUpper

TwoSigmaUpper is optional. A single instance might exist.

Two sigma (a measure of dispersion associated with standard deviation) on the upper side of the standard deviation.

BucketType [attribute]

The type of planning information being communicated in the bucket.

This item is restricted to the following list.

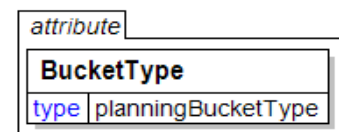

Actual

The planning information communicates incurred values.

Demand

The planning information communicates requested values.

Forecast

The planning information communicates estimated values.

Budget

The planning information communicates budgeted values.

Bulk

A group item used to communicate bulking thickness target or test value.

TestMethod [attribute]

TestMethod is optional. A single instance might exist.

The method used to determine the results of the test under consideration.

TestAgency [attribute]

TestAgency is optional. A single instance might exist.

The agency that has set the parameters for the testing

Refer to TestAgency definition for any enumerations.

SampleType [attribute]

SampleType is optional. A single instance might exist.

Communicates how sampling was done to measure the product characteristics.

Refer to SampleType definition for any enumerations.

ResultSource [attribute]

ResultSource is optional. A single instance might exist.

Used to define the data source of the specified test

Refer to ResultSource definition for any enumerations.

(sequence)

The sequence of items below is mandatory. A single instance is required.

DetailValue

DetailValue is mandatory. A single instance is required.

A numeric value expressed in the unit of measure (UOM).

DetailRangeMin

DetailRangeMin is optional. A single instance might exist.

The minimum value (lower boundary) allowed for the DetailValue that is the parent of this element.

DetailRangeMax

DetailRangeMax is optional. A single instance might exist.

The maximum value (upper boundary) allowed for the DetailValue that is the parent of this element.

StandardDeviation

StandardDeviation is optional. A single instance might exist.

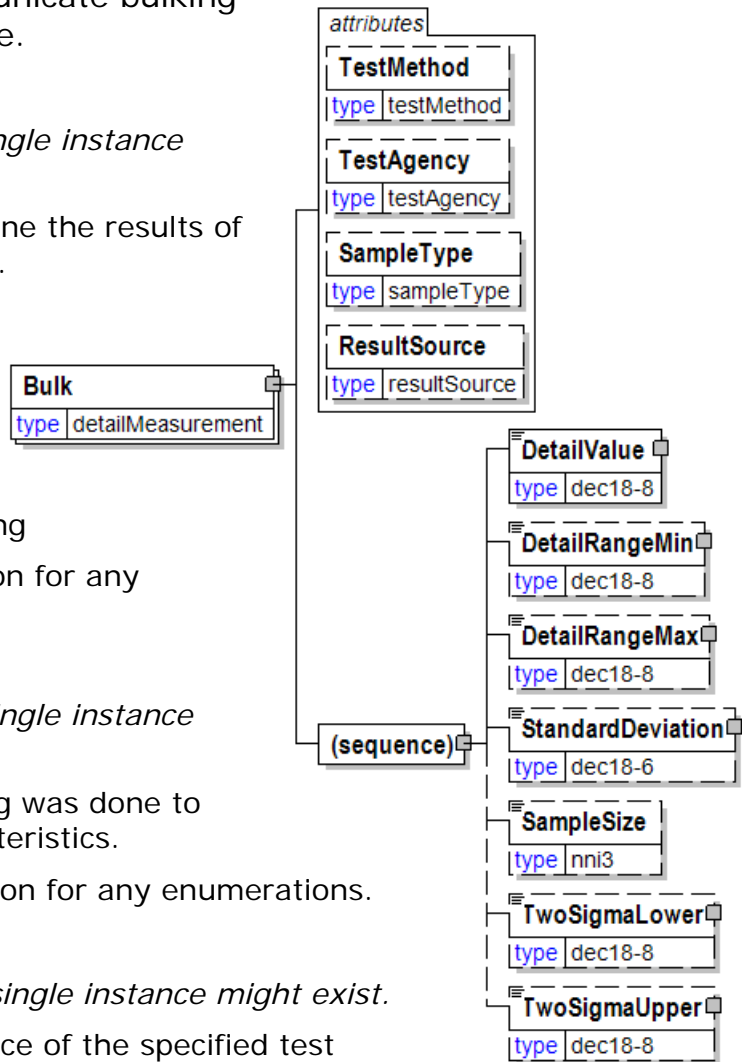

papiNet V2R31

A statistic used as a measure of dispersion in a distribution.

SampleSize

SampleSize is optional. A single instance might exist.

The number of samples used to determine the product characteristic in question.

TwoSigmaLower

TwoSigmaLower is optional. A single instance might exist.

Two sigma (a measure of dispersion associated with standard deviation) on the lower side of the standard deviation.

TwoSigmaUpper

TwoSigmaUpper is optional. A single instance might exist.

Two sigma (a measure of dispersion associated with standard deviation) on the upper side of the standard deviation.

BulkNumberOfUnits

Bulk number of units

BulkNumberOfUnits
type nni2

Burst

A group item used to communicate bursting strength target or test value according to a particular TestMethod.

TestMethod [attribute]

TestMethod is optional. A single instance might exist.

The method used to determine the results of the test under consideration.

TestAgency [attribute]

TestAgency is optional. A single instance might exist.

The agency that has set the parameters for the testing

Refer to TestAgency definition for any enumerations.

SampleType [attribute]

SampleType is optional. A single instance might exist.

Communicates how sampling was done to measure the product characteristics.

Refer to SampleType definition for any enumerations.

ResultSource [attribute]

ResultSource is optional. A single instance might exist.

Used to define the data source of the specified test

Refer to ResultSource definition for any enumerations.

(sequence)

The sequence of items below is mandatory. A single instance is required.

DetailValue

DetailValue is mandatory. A single instance is required.

A numeric value expressed in the unit of measure (UOM).

DetailRangeMin

DetailRangeMin is optional. A single instance might exist.

The minimum value (lower boundary) allowed for the DetailValue that is the parent of this element.

DetailRangeMax

DetailRangeMax is optional. A single instance might exist.

The maximum value (upper boundary) allowed for the DetailValue that is the parent of this element.

StandardDeviation

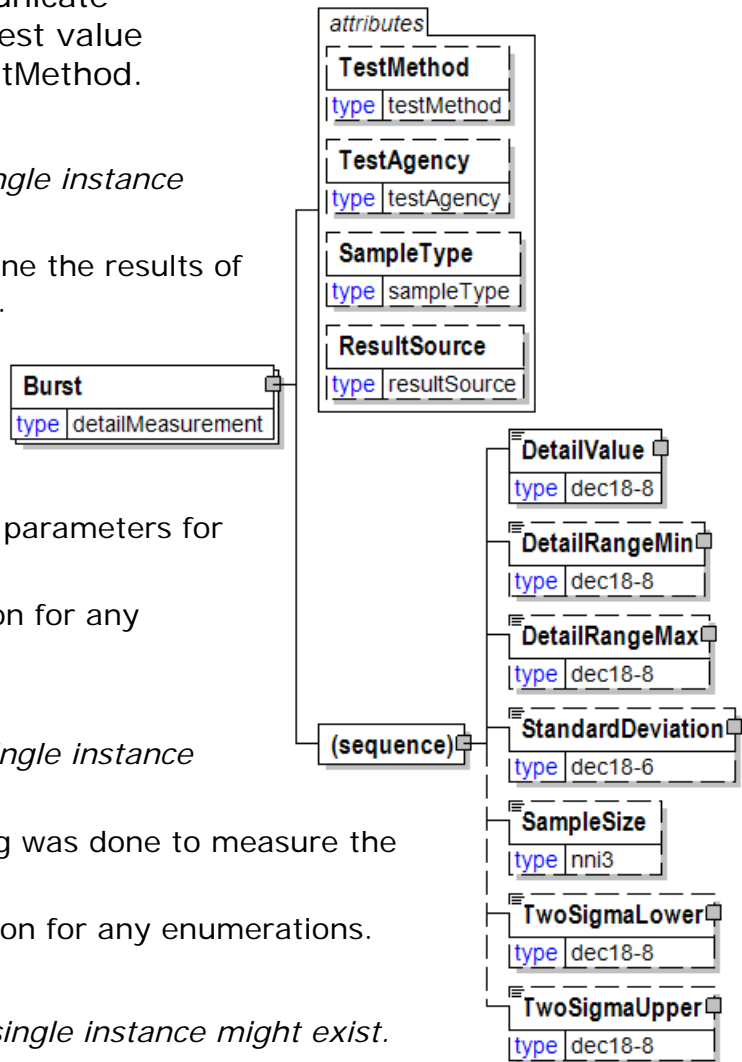

StandardDeviation is optional. A single instance might exist.

A statistic used as a measure of dispersion in a distribution.

SampleSize

SampleSize is optional. A single instance might exist.

The number of samples used to determine the product characteristic in question.

TwoSigmaLower

TwoSigmaLower is optional. A single instance might exist.

Two sigma (a measure of dispersion associated with standard deviation) on the lower side of the standard deviation.

TwoSigmaUpper

TwoSigmaUpper is optional. A single instance might exist.

Two sigma (a measure of dispersion associated with standard deviation) on the upper side of the standard deviation.

BurstIndex

The burst index.

TestMethod [attribute]

TestMethod is optional. A single instance might exist.

The method used to determine the results of the test under consideration.

TestAgency [attribute]

TestAgency is optional. A single instance might exist.

The agency that has set the parameters for the testing

Refer to TestAgency definition for any enumerations.

SampleType [attribute]

SampleType is optional. A single instance might exist.

Communicates how sampling was done to measure the product characteristics.

Refer to SampleType definition for any enumerations.

ResultSource [attribute]

ResultSource is optional. A single instance might exist.

Used to define the data source of the specified test

Refer to ResultSource definition for any enumerations.

(sequence)

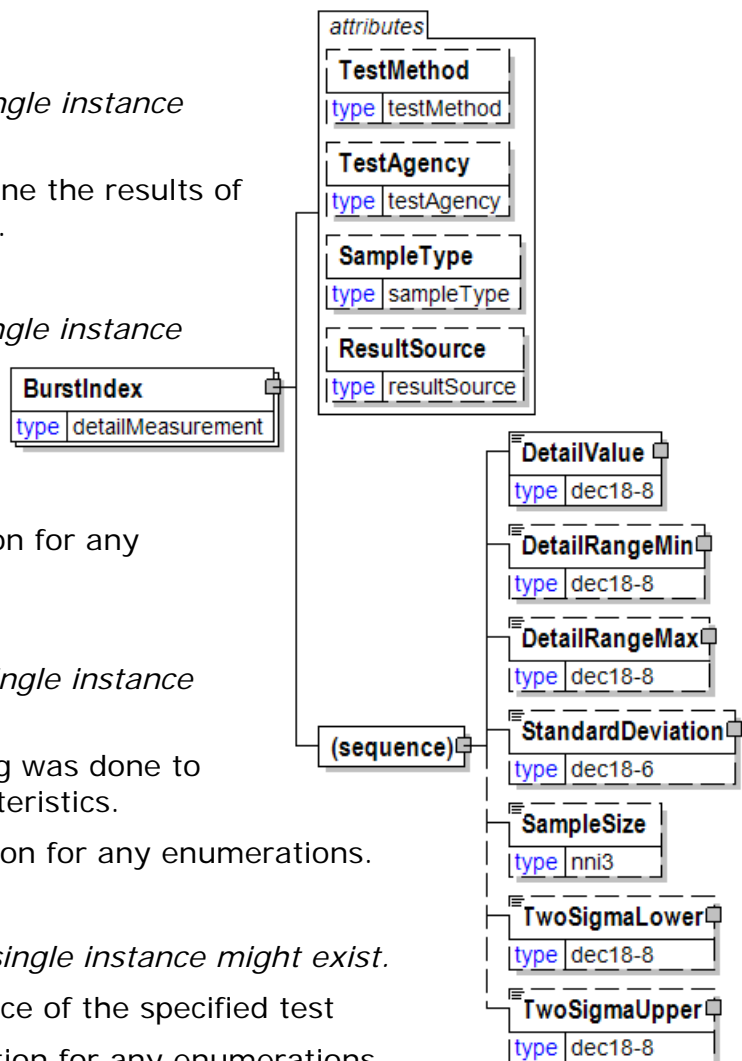

papiNet V2R31

The sequence of items below is mandatory. A single instance is required.

DetailValue

DetailValue is mandatory. A single instance is required.

A numeric value expressed in the unit of measure (UOM).

DetailRangeMin

DetailRangeMin is optional. A single instance might exist.

The minimum value (lower boundary) allowed for the DetailValue that is the parent of this element.

DetailRangeMax

DetailRangeMax is optional. A single instance might exist.

The maximum value (upper boundary) allowed for the DetailValue that is the parent of this element.

StandardDeviation

StandardDeviation is optional. A single instance might exist.

A statistic used as a measure of dispersion in a distribution.

SampleSize

SampleSize is optional. A single instance might exist.

The number of samples used to determine the product characteristic in question.

TwoSigmaLower

TwoSigmaLower is optional. A single instance might exist.

Two sigma (a measure of dispersion associated with standard deviation) on the lower side of the standard deviation.

TwoSigmaUpper

TwoSigmaUpper is optional. A single instance might exist.

Two sigma (a measure of dispersion associated with standard deviation) on the upper side of the standard deviation.

BusinessAcceptance

The BusinessAcceptance element is the root element for the BusinessAcceptance e-Document.

The receiver of a document uses the BusinessAcceptance to confirm to the sender that the document is accepted or rejected. The BusinessAcceptance can be used as a confirmation of acceptance when there is not a papiNet-designed confirmation e-Document available. Although the BusinessAcceptance is optional between two trading partners, its use is strongly recommended when it is important to get a BusinessAcceptance.

BusinessAcceptance

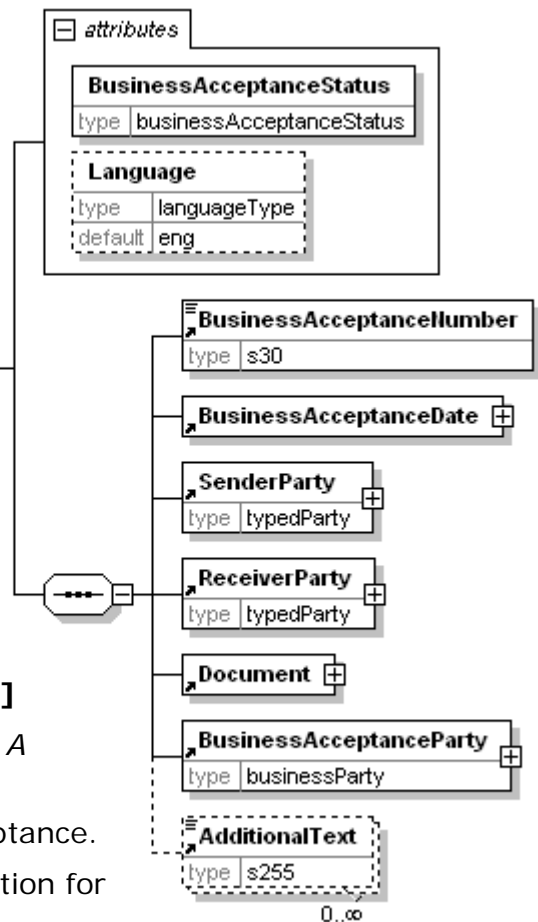

BusinessAcceptanceStatus [attribute]

BusinessAcceptanceStatus is mandatory. A single instance is required.

Identifies the status of the BusinessAcceptance.

Refer to BusinessAcceptanceStatus definition for any enumerations.

Language [attribute]

Language is optional. A single instance might exist.

XML has embraced 2 and 3 digit language codes through the application of an addendum to the standard.

Refer to Language definition for any enumerations.

(sequence)

The sequence of items below is mandatory. A single instance is required.

BusinessAcceptanceNumber

BusinessAcceptanceNumber is mandatory. A single instance is required.

The unique identifier for the BusinessAcceptance.

BusinessAcceptanceDate

BusinessAcceptanceDate is mandatory. A single instance is required.

The Date and Time when the BusinessAcceptance was issued.

SenderParty

SenderParty is mandatory. A single instance is required.

The business entity issuing the e-Document, the source of the document.

The entity responsible for the content. If the sender party has out sourced the message service to a third party the SenderParty is the issuer of the e-Document and not the party performing the transmission service of the

electronic message.

ReceiverParty

ReceiverParty is mandatory. A single instance is required.

The business entity for whom the e-Document is intended, the destination of the document.

The entity interested in the content. If the receiver party has outsourced the message service to a third party the ReceiverParty is the intended party for the e-Document and not the party performing the receiving service of the electronic message.

Document

Document is mandatory. A single instance is required.

A group item containing information applicable to the original document.

BusinessAcceptanceParty

BusinessAcceptanceParty is mandatory. A single instance is required.

The organisation or legal entity authorised to accept or reject e-Document.

AdditionalText

AdditionalText is optional. Multiple instances might exist.

A text field that is used to communicate information not previously defined or for special instructions. To be used only for circumstances not covered by specific elements.

BusinessAcceptanceDate

The Date and Time when the BusinessAcceptance was issued.

(sequence)

The sequence of items below is mandatory. A single instance is required.

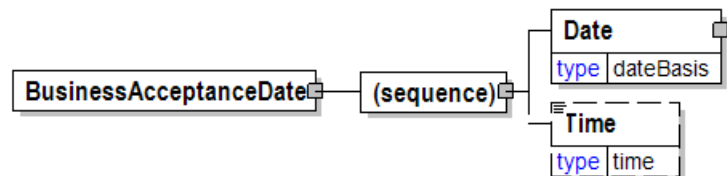

Date

Date is mandatory. A single instance is required.

A group element that contains the specification of Year, Month, and Day.

Time

Time is optional. A single instance might exist.

Times are treated in a standard XML fashion with a special case used to indicate a generalized "local" time. The standard XML approach to time is hh:mm:ss, hh:mm:ssZ, or hh:mm:ss±hh:mm.

hh:mm:ss±hh:mm is used to represent a time with a time zone. The time zone is communicated as the number of hours offset from the Universal Time Coordinate (UTC), a.k.a. Greenwich Mean Time.

hh:mm:ssZ indicates the time at Zulu (another name for UTC). Based on the convention described in the next bullet it will be important for users within UTC to use "Z" when communicating a time in their time zone to other users.

hh:mm:ss or hh:mm indicates in the XML standard the time at UTC however, within papiNet it is used to represent the applicable local time. Caution should

be used when processing times of this nature as the papiNet approach may be in discord with other users of XML.

BusinessAcceptanceNumber

The unique identifier for the BusinessAcceptance.

BusinessAcceptanceNumber
type s30

BusinessAcceptanceParty

The organisation or legal entity authorised to accept or reject e-Document.

PartyType [attribute]

PartyType is mandatory. A single instance is required.

Identifies the business role associated with the particular party

Refer to PartyType definition for any enumerations.

(sequence)

The sequence of items below is mandatory. A single instance is required.

PartyIdentifier

PartyIdentifier is mandatory. One instance is required, multiple instances might exist.

A unique identifier of a specific party. This element contains an attribute PartyIdentifierType that indicates the type of party.

NameAddress

NameAddress is mandatory. A single instance is required.

A group item containing name and address of an organisation or business entity.

URL

URL is optional. A single instance might exist.

Universal Resource Locator. While typically a web address you could use this field to hold an email address.

CommonContact

CommonContact is mandatory. One instance is required, multiple instances might exist.

Identifies a specific individual associated with the party.

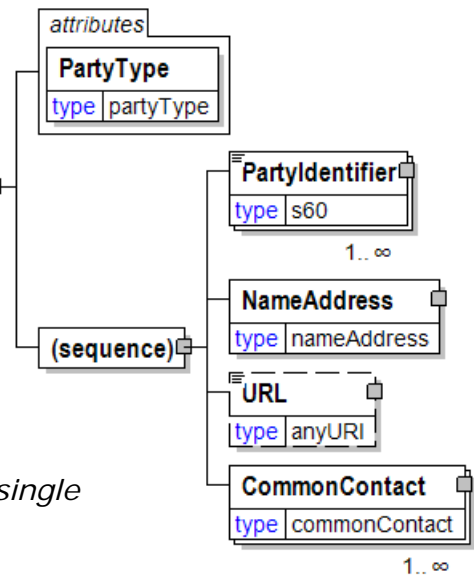

BusinessAcceptanceStatus [attribute]

Identifies the status of the BusinessAcceptance.

This item is restricted to the following list.

BusinessAcceptanceStatus	
type	businessAcceptanceStatus

Accepted

Content of the e-Document is accepted. The receiver has got a Confirmation of Acceptance for an earlier sent e-Document

Rejected

Content of the e-Document is rejected. The receiver of a BusinessAcceptance should have in place a resolution process. The resolution process is typically based on manual actions when the content is rejected.

BusinessAcknowledgement

The BusinessAcknowledgement element is the root element for the BusinessAcknowledgement e-Document.

An e-Document receiver uses the BusinessAcknowledgement to notify the sender that a document has been successfully

presented to the receiver's ERP system. The BusinessAcknowledgement can be used to acknowledge any papiNet e-Document. Although the BusinessAcknowledgement is optional between two trading partners, its use is strongly recommended since it provides positive verification of the beginning of the transaction by the receiver.

Status [attribute]

Status is mandatory. A single instance is required.

Defines whether or not the electronic transaction successfully processed in the receiver ERP system.

Refer to Status definition for any enumerations.

Language [attribute]

Language is optional. A single instance might exist.

XML has embraced 2 and 3 digit language codes through the application of an addendum to the standard.

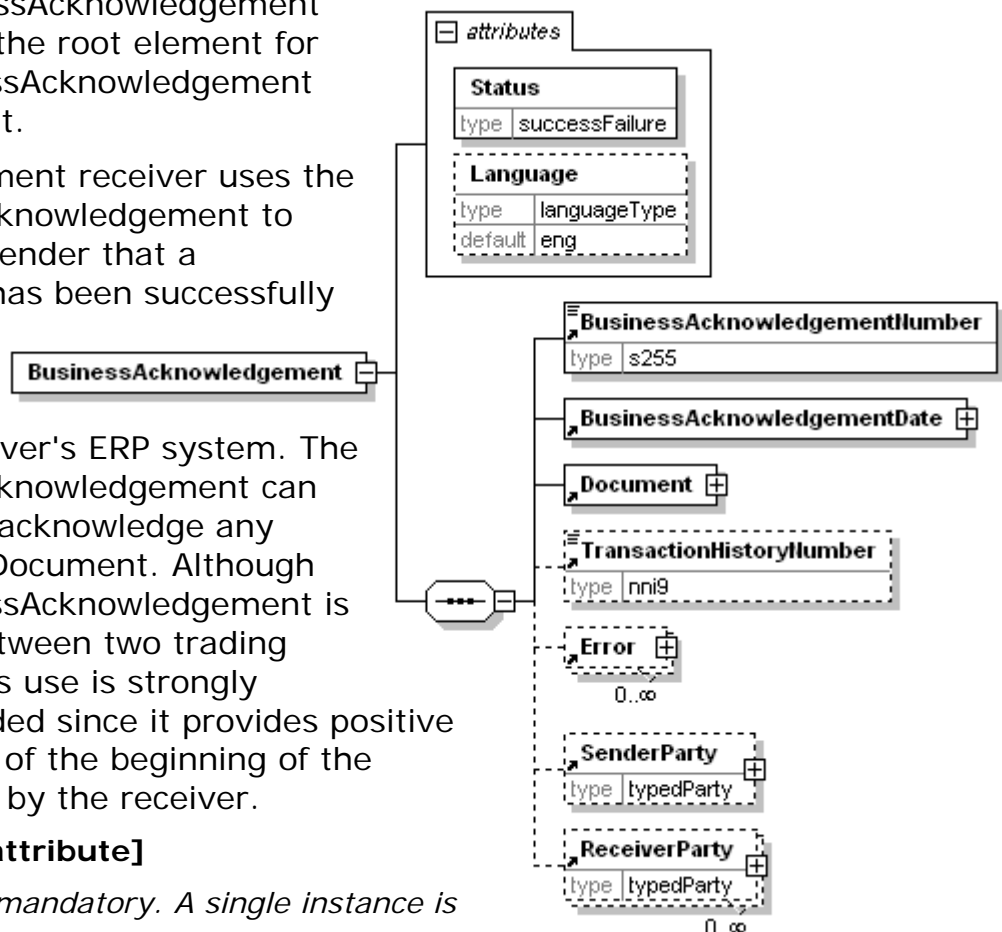

Refer to Language definition for any enumerations.

(sequence)

The sequence of items below is mandatory. A single instance is required.

BusinessAcknowledgementNumber

BusinessAcknowledgementNumber is mandatory. A single instance is required.

The unique identifier for the BusinessAcknowledgement.

BusinessAcknowledgementDate

BusinessAcknowledgementDate is mandatory. A single instance is required.

The Date and Time when the BusinessAcknowledgement was issued.

Document

Document is mandatory. A single instance is required.

A group item containing information applicable to the original document.

TransactionHistoryNumber

TransactionHistoryNumber is optional. A single instance might exist.

A sequential number that keeps track of the version of a document being sent by the document originator except in the case where TransactionHistoryConfirmation is used, in which case the TransactionHistoryNumber refers to the trigger transaction for which the confirmation is being sent.

Error

Error is optional. Multiple instances might exist.

A group item that details the errors that are delaying processing on an original document.

SenderParty

SenderParty is optional. A single instance might exist.

The business entity issuing the e-Document, the source of the document.

The entity responsible for the content. If the sender party has out sourced the message service to a third party the SenderParty is the issuer of the e-Document and not the party performing the transmission service of the electronic message.

ReceiverParty

ReceiverParty is optional. Multiple instances might exist.

The business entity for whom the e-Document is intended, the destination of the document.

The entity interested in the content. If the receiver party has outsourced the message service to a third party the ReceiverParty is the intended party for the e-Document and not the party performing the receiving service of the electronic message.

BusinessAcknowledgementDate

The Date and Time when the BusinessAcknowledgement was issued.

(sequence)

The sequence of items below is mandatory. A single instance is required.

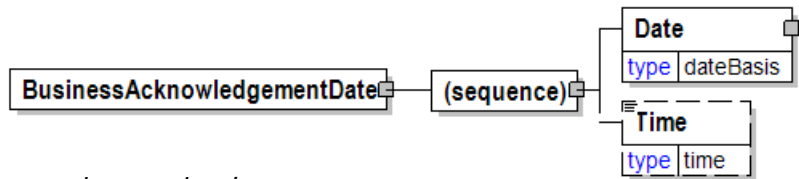

Date

Date is mandatory. A single instance is required.

A group element that contains the specification of Year, Month, and Day.

Time

Time is optional. A single instance might exist.

Times are treated in a standard XML fashion with a special case used to indicate a generalized "local" time. The standard XML approach to time is hh:mm:ss, hh:mm:ssZ, or hh:mm:ss±hh:mm.

hh:mm:ss±hh:mm is used to represent a time with a time zone. The time zone is communicated as the number of hours offset from the Universal Time Coordinate (UTC), a.k.a. Greenwich Mean Time.

hh:mm:ssZ indicates the time at Zulu (another name for UTC). Based on the convention described in the next bullet it will be important for users within UTC to use "Z" when communicating a time in their time zone to other users.

hh:mm:ss or hh:mm indicates in the XML standard the time at UTC however, within papiNet it is used to represent the applicable local time. Caution should be used when processing times of this nature as the papiNet approach may be in discord with other users of XML.

BusinessAcknowledgementNumber

The unique identifier for the BusinessAcknowledgement.

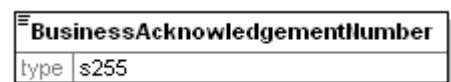

BuyerParty

The legal entity to which the product is sold. Also commonly referred to as the sold-to party or customer. If no OtherParty is defined as the Payer, the Buyer is the Payer.

LogisticsRole [attribute]

LogisticsRole is optional. A single instance might exist.

Communicates the nature of the logistics role, if any, the party plays in the transaction.

Refer to LogisticsRole definition for any enumerations.

(sequence)

The sequence of items below is mandatory. A single instance is required.

PartyIdentifier

PartyIdentifier is optional. Multiple instances might exist.

A unique identifier of a specific party. This element contains an attribute PartyIdentifierType that indicates the type of party.

NameAddress

NameAddress is mandatory. A single instance is required.

A group item containing name and address of an organisation or business entity.

URL

URL is optional. A single instance might exist.

Universal Resource Locator. While typically a web address you could use this field to hold an email address.

CommonContact

CommonContact is optional. Multiple instances might exist.

Identifies a specific individual associated with the party.

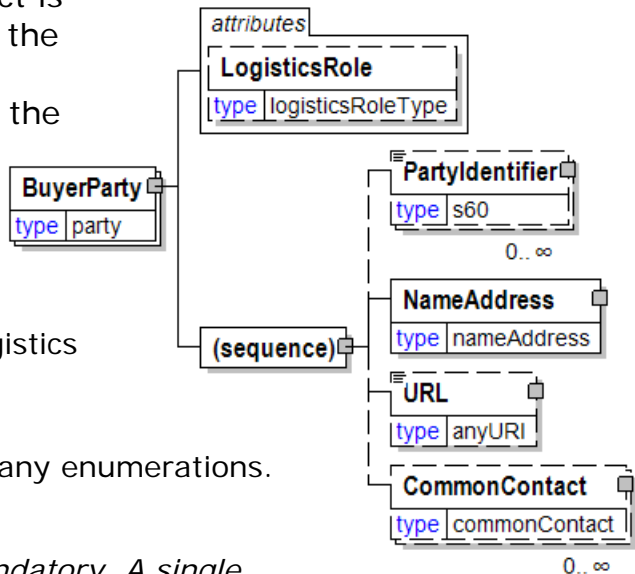

ByInvoice

Selection criteria for invoice information.

(choice)

[choice] is optional because of choice construct.

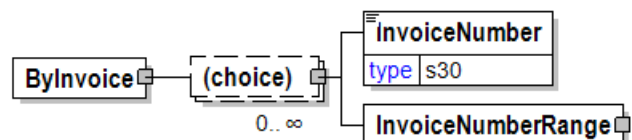

InvoiceNumber

InvoiceNumber is optional because of choice construct.

The identification number of the Invoice, generated by the seller.

InvoiceNumberRange

InvoiceNumberRange is optional because of choice construct.

papiNet V2R31

A range of invoices to be considered or reported on.

ByJob

Information about the job being communicated.

(sequence)

The sequence of items below is mandatory. A single instance is required.

JobID

JobID is optional. A single instance might exist.

An element used to communicate the unique identifier of the Job

JobDescription

JobDescription is optional. A single instance might exist.

A textual description of the job.

IssueOrEventID

IssueOrEventID is optional. A single instance might exist.

Used to communicate the identifier for a job.

EndUserParty

EndUserParty is optional. A single instance might exist.

The party using, consuming, or converting the product. For example, a printer using paper reels for a print job for a publisher. The final ShipTo destination for a product is normally to the end user's facilities.

Quantity

Quantity is mandatory. A single instance is required.

The Quantity element contains attributes that provide information about the type of quantity that is being communicated, the context in which the particular quantity is to be viewed, and (if the quantity represents an adjustment) an adjustment type.

The Quantity element contains three child elements that enable you to communicate a range of values for the quantity and a target or actual value. It is at this level (Value, RangeMin, and RangeMax) that the unit of measure is specified. This permits the range to be specified in a different unit of measure than the target.

InformationalQuantity

InformationalQuantity is optional. Multiple instances might exist.

A quantity given in a valid UOM used for information purposes only (not for calculation). For example, an ordered quantity was 100 reels as opposed to the invoice quantity of 20,000 pounds.

JobDateTimeRange

JobDateTimeRange is optional. A single instance might exist.

The specification of the date range for the job.

PurchaseOrderDetail

PurchaseOrderDetail is optional. Multiple instances might exist.

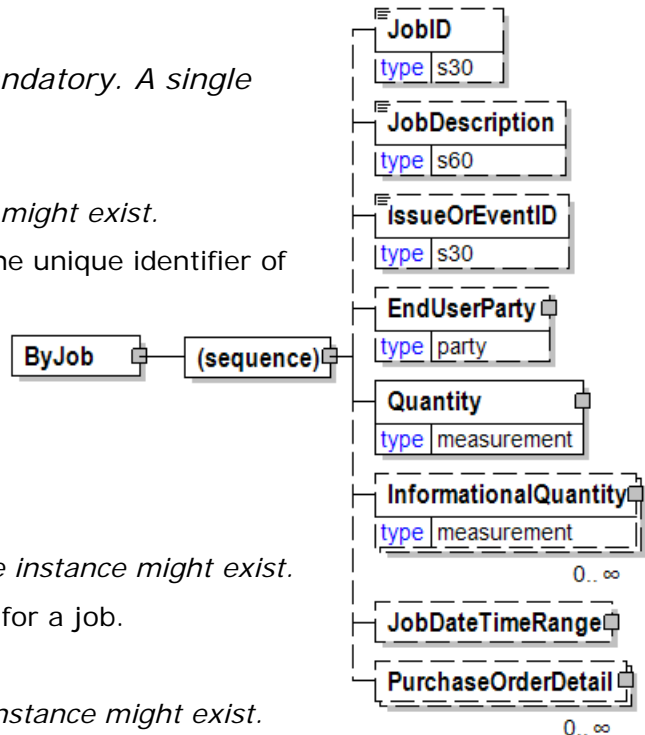

Multiple PurchaseOrderDetail instances are allowed.

ByLoad

By Load

ByLoadType [attribute]

ByLoadType is mandatory. A single instance is required.

By Load Type

Refer to ByLoadType definition for any enumerations.

(sequence)

The sequence of items below is mandatory. A single instance is required.

LoadNumber

LoadNumber is mandatory. A single instance is required.

An element used to communicate the unique identifier of the LoadNumber.

Quantity

Quantity is mandatory. A single instance is required.

The Quantity element contains attributes that provide information about the type of quantity that is being communicated, the context in which the particular quantity is to be viewed, and (if the quantity represents an adjustment) an adjustment type.

The Quantity element contains three child elements that enable you to communicate a range of values for the quantity and a target or actual value. It is at this level (Value, RangeMin, and RangeMax) that the unit of measure is specified. This permits the range to be specified in a different unit of measure than the target.

InformationalQuantity

InformationalQuantity is optional. Multiple instances might exist.

A quantity given in a valid UOM used for information purposes only (not for calculation). For example, an ordered quantity was 100 reels as opposed to the invoice quantity of 20,000 pounds.

ShipmentLoadDetails

ShipmentLoadDetails is optional. Multiple instances might exist.

A group element that containing information that relates to the shipment load details for the line item. Carrier and transport information may be detailed.

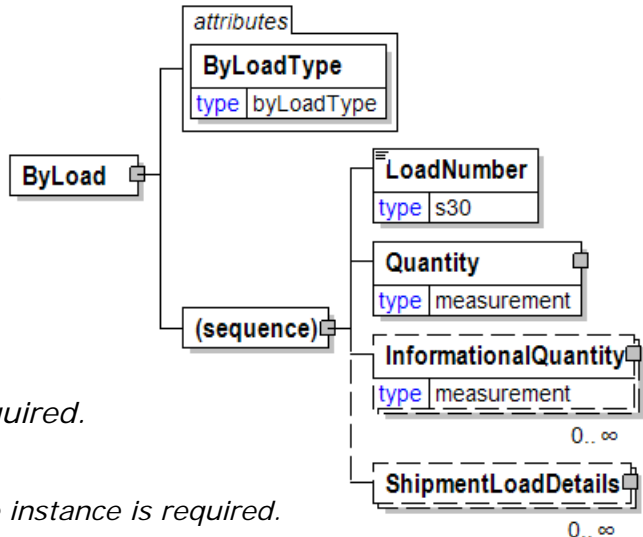

ByLoadType [attribute]

By Load Type

This item is restricted to the following list.

Forecast

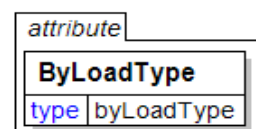

The load is projected.

Shipment

The load is actually shipped.

ByPeriod

This element is mutually exclusive of ByQualifiedPurchaseOrderInformation and ByQualifiedDeliveryMessage.

(sequence)

The sequence of items below is mandatory. A single instance is required.

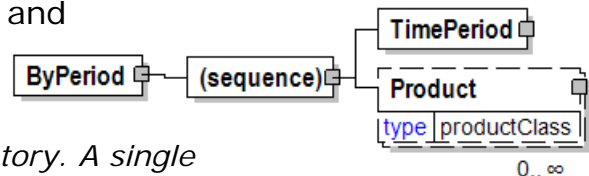

TimePeriod

TimePeriod is mandatory. A single instance is required.

The TimePeriod element is used to communicate a duration period of time as indicated in PeriodType.

Product

Product is optional. Multiple instances might exist.

Product is a group item defining the article and its characteristics. Product is used to specify product characteristics organized by ProductIdentifier, ProductDescription, and Classification. Book Manufacturing, Label Stock, Paper, Pulp, Recovered Paper, Wood Products, and Virgin Fibre market segments have defined their product characteristics and conversion features for implementation in papiNet.

ByProduct

Identification takes place by product.

(sequence)

The sequence of items below is mandatory. A single instance is required.

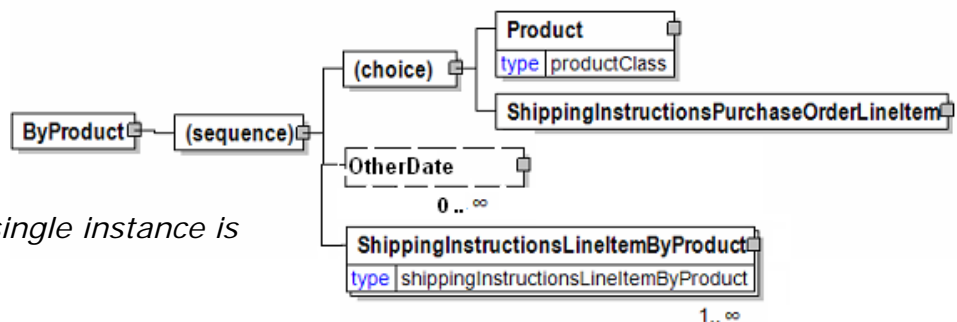

(choice)

[choice] is optional because of choice construct.

Product

Product is optional because of choice construct.

Product is a group item defining the article and its characteristics. Product is used to specify product characteristics organized by ProductIdentifier, ProductDescription, and Classification. Book Manufacturing, Label Stock, Paper, Pulp, Recovered Paper, Wood Products, and Virgin Fibre market segments have defined their product characteristics and conversion features for implementation in papiNet.

ShippingInstructionsPurchaseOrderLineItem

ShippingInstructionsPurchaseOrderLineItem is optional because of choice construct.

PurchaseOrder line item information for purchase order being referenced in ShippingInstructions.

OtherDate

OtherDate is optional. More than one instance can occur.

A date that may not be specifically detailed within a document (example: print date at the PurchaseOrderLineItem).

ShippingInstructionsLineItemByProduct

ShippingInstructionsLineItemByProduct is mandatory. One instance is required, multiple instances might exist.

ShippingInstructionsLineItemByProduct

ByPurchaseOrder

Selection criteria for communicating purchase order information.

(sequence)

The

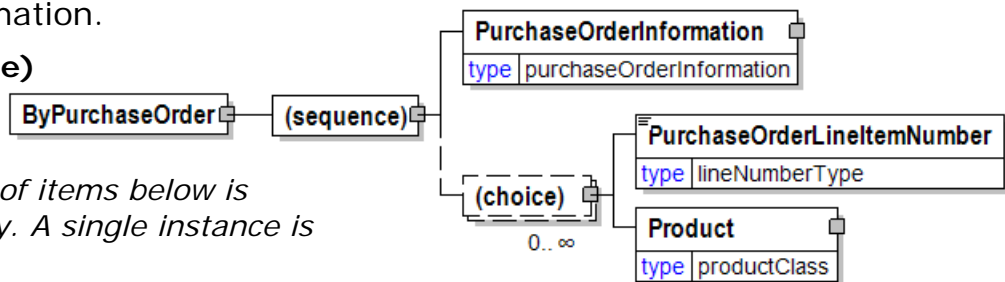

sequence of items below is mandatory. A single instance is required.

PurchaseOrderInformation

PurchaseOrderInformation is mandatory. A single instance is required.

A group item containing information unique to this PurchaseOrder, which is provided by the buyer. PurchaseOrderInformation can be optional in the supply chain. Invoices are created without having a PurchaseOrder in Vendor Managed Inventory. Freight invoices also will not have a PurchaseOrder number.

(choice)

[choice] is optional because of choice construct.

PurchaseOrderLineItemNumber

PurchaseOrderLineItemNumber is optional because of choice construct.

The sequential number that uniquely identifies the PurchaseOrder line item.

Product

Product is optional because of choice construct.

Product is a group item defining the article and its characteristics. Product is used to specify product characteristics organized by ProductIdentifier, ProductDescription, and Classification. Book Manufacturing, Label Stock, Paper, Pulp, Recovered Paper, Wood Products, and Virgin Fibre market segments have defined their product characteristics and conversion features for implementation in papiNet.

ByQualifiedDeliveryMessage

ByQualifiedDeliveryMessage is a conditional element. This element is mutually exclusive of

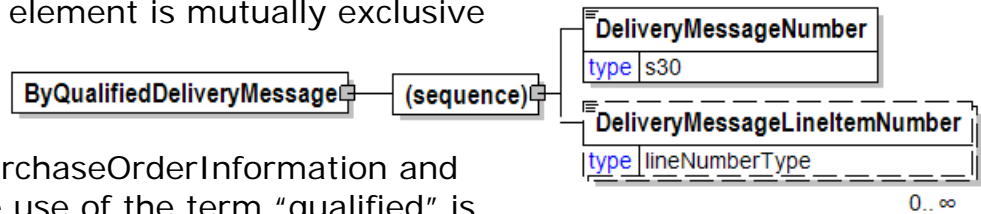

ByQualifiedPurchaseOrderInformation and ByPeriod. The use of the term “qualified” is to indicate that DeliveryMessageNumber is qualified by the use of DeliveryMessageLineItemNumber.

(sequence)

The sequence of items below is mandatory. A single instance is required.

DeliveryMessageNumber

DeliveryMessageNumber is mandatory. A single instance is required.

A unique delivery identifier assigned to each DeliveryMessage as agreed between the trading partners.

DeliveryMessageLineItemNumber

DeliveryMessageLineItemNumber is optional. Multiple instances might exist.

The sequential number that uniquely identifies the delivery line item.

ByQualifiedPurchaseOrderInformation

ByQualifiedPurchaseOrderInformation is a conditional element. This element is mutually

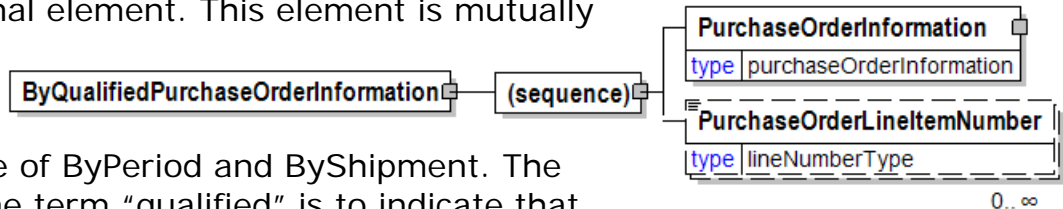

exclusive of ByPeriod and ByShipment. The use of the term “qualified” is to indicate that PurchaseOrderInformation is qualified by the use of PurchaseOrderLineItemNumber.

(sequence)

The sequence of items below is mandatory. A single instance is required.

PurchaseOrderInformation

PurchaseOrderInformation is mandatory. A single instance is required.

A group item containing information unique to this PurchaseOrder, which is provided by the buyer. PurchaseOrderInformation can be optional in the supply chain. Invoices are created without having a PurchaseOrder in Vendor Managed Inventory. Freight invoices also will not have a PurchaseOrder number.

PurchaseOrderLineItemNumber

PurchaseOrderLineItemNumber is optional. Multiple instances might exist.

The sequential number that uniquely identifies the PurchaseOrder line item.

ByShipTo

ByShipTo

(sequence)

The sequence of items below is mandatory. A single instance is required.

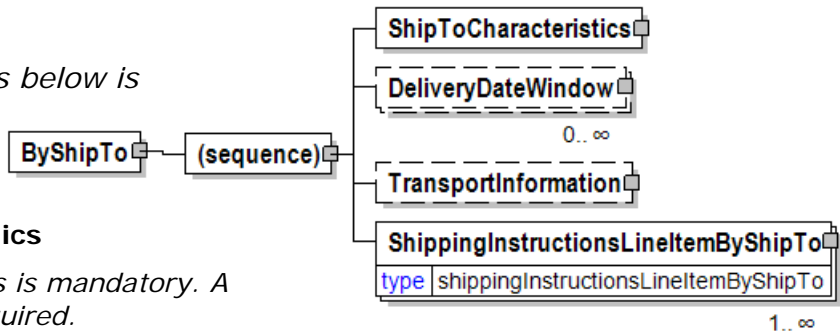

ShipToCharacteristics

ShipToCharacteristics is mandatory. A single instance is required.

A group item that provides information important for the Ship-To Party.

A group item that provides information important for the Ship-To Party. ShipToCharacteristics may be referenced at both the header and line item level. The reference at the header is required and acts as a default for the value at the line level, unless overridden at the line level.

DeliveryDateWindow

DeliveryDateWindow is optional. Multiple instances might exist.

A group item defining the date/time interval for delivery to take place. An element which may contain the estimated date for which delivery is expected. This date is not absolute.

TransportInformation

TransportInformation is optional. A single instance might exist.

A grouping element for transport information.

ShippingInstructionsLineItemByShipTo

ShippingInstructionsLineItemByShipTo is mandatory. One instance is required, multiple instances might exist.

ShippingInstructions Line Item By Ship To

BySupplierOrder

Selection criteria for communicating Supplier Order information.

(sequence)

The sequence of items below is mandatory. A single instance is required.

SupplierOrderNumber

SupplierOrderNumber is mandatory. A single instance is required.



required.

The number of the supplier order.

SupplierOrderLineItemNumber

SupplierOrderLineItemNumber is mandatory. A single instance is required.

The number of the line item on the supplier order.

(sequence)

The sequence of items below is optional. A single instance might exist.

PurchaseOrderNumber

PurchaseOrderNumber is mandatory. A single instance is required.

The unique order identifier as designated by the customer.

PurchaseOrderLineItemNumber

PurchaseOrderLineItemNumber is optional. A single instance might exist.

The sequential number that uniquely identifies the PurchaseOrder line item.

Quantity

Quantity is mandatory. A single instance is required.

The Quantity element contains attributes that provide information about the type of quantity that is being communicated, the context in which the particular quantity is to be viewed, and (if the quantity represents an adjustment) an adjustment type.

The Quantity element contains three child elements that enable you to communicate a range of values for the quantity and a target or actual value. It is at this level (Value, RangeMin, and RangeMax) that the unit of measure is specified. This permits the range to be specified in a different unit of measure than the target.

InformationalQuantity

InformationalQuantity is optional. Multiple instances might exist.

A quantity given in a valid UOM used for information purposes only (not for calculation). For example, an ordered quantity was 100 reels as opposed to the invoice quantity of 20,000 pounds.

ShipmentLoadDetails

ShipmentLoadDetails is optional. Multiple instances might exist.

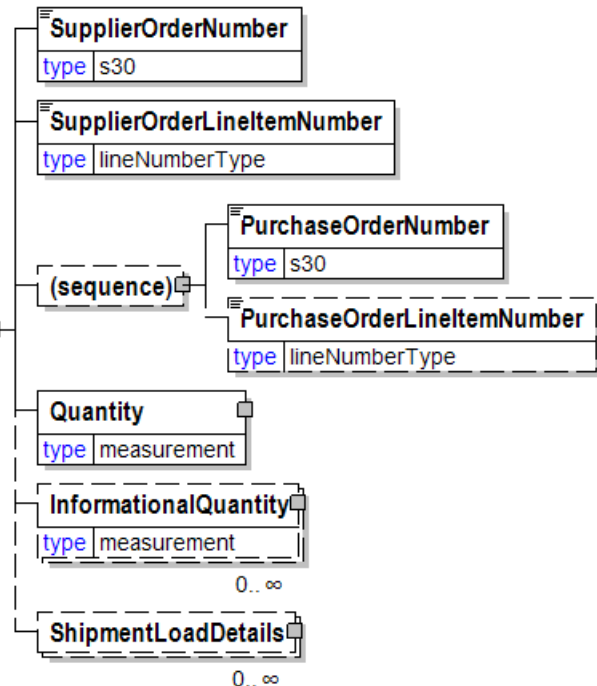

A group element that containing information that relates to the shipment load details for the line item. Carrier and transport information may be detailed.

BySupplierOrderNumber

Selection criteria for communicating Supplier Order information

(sequence)

The sequence of items below is mandatory. A single instance is required.

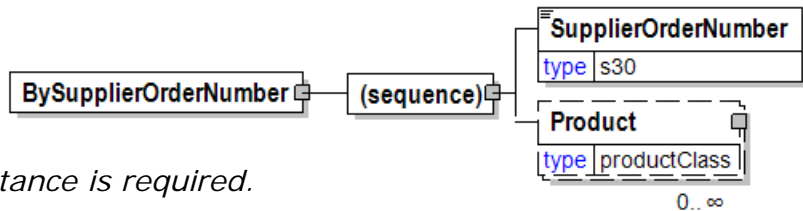

SupplierOrderNumber

SupplierOrderNumber is mandatory. A single instance is required.

The number of the supplier order.

Product

Product is optional. Multiple instances might exist.

Product is a group item defining the article and its characteristics. Product is used to specify product characteristics organized by ProductIdentifier, ProductDescription, and Classification. Book Manufacturing, Label Stock, Paper, Pulp, Recovered Paper, Wood Products, and Virgin Fibre market segments have defined their product characteristics and conversion features for implementation in papiNet.

Calendar

The Calendar element is the root element for the Calendar e-Document.

The Calendar e-Document is intended to communicate opening times or other details for a location or locations.

CalendarType [attribute]

CalendarType is mandatory. A single instance is required.

Identifies the intention of the entire Calendar e-Document.

Refer to CalendarType definition for any enumerations.

CalendarStatus [attribute]

CalendarStatus is optional. A single instance might exist.

Identifies the status of the entire Calendar e-Document.

Refer to CalendarStatus definition for any enumerations.

Language [attribute]

Language is optional. A single instance might exist.

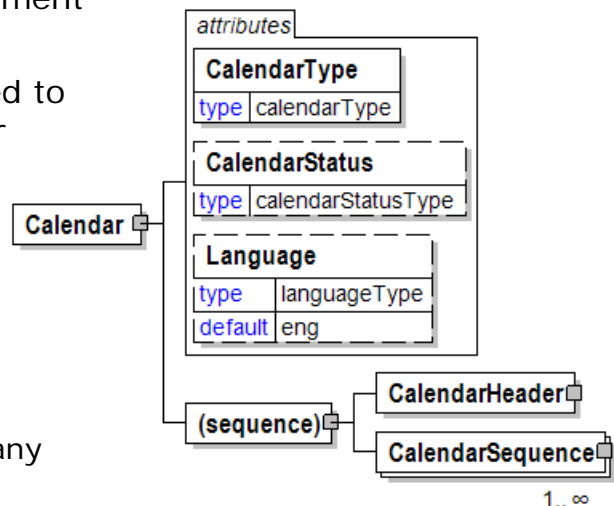

XML has embraced 2 and 3 digit language codes through the application of an addendum to the standard.

Refer to Language definition for any enumerations.

(sequence)

The sequence of items below is mandatory. A single instance is required.

CalendarHeader

CalendarHeader is mandatory. A single instance is required.

A group item containing generic information applicable to the entire Calendar.

CalendarSequence

CalendarSequence is mandatory. One instance is required, multiple instances might exist.

A group item containing information that relates to a line on the Calendar.

CalendarEntry

Detailed description of the times and contingencies for the given LocationParty.

CalendarEntryPeriod [attribute]

CalendarEntryPeriod is mandatory. A single instance is required.

Describes the period to which the given times and contingencies apply. This can be either a weekday or a date range. If it is a date range, the DateTimeRange element is used to specify the range.

Refer to CalendarEntryPeriod definition for any enumerations.

(sequence)

The sequence of items below is mandatory. A single instance is required.

TimeSlotInformation

TimeSlotInformation is mandatory. One instance is required, multiple instances might exist.

Description of the beginning and end of a time slot and the contingencies it contains.

DateTimeRange

DateTimeRange is mandatory. One instance is required, multiple instances might exist.

Specifies a date and/or time range.

AdditionalText

AdditionalText is optional. Multiple instances might exist.

A text field that is used to communicate information not previously defined or for special instructions. To be used only for circumstances not covered by specific

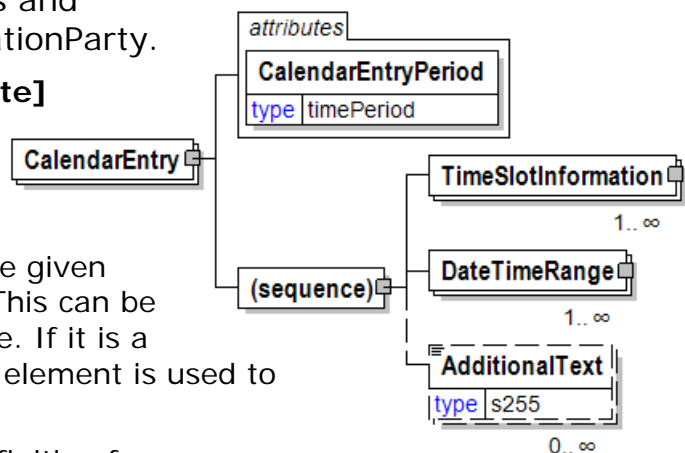

elements.

CalendarEntryPeriod [attribute]

Describes the period to which the given times and contingencies apply. This can be either a weekday or a date range. If it is a date range, the DateTimeRange element is used to specify the range.

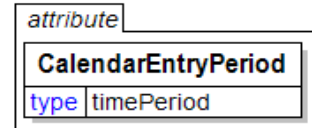

This item is restricted to the following list.

- Monday**
- Tuesday**
- Wednesday**
- Thursday**
- Friday**
- Saturday**
- Sunday**
- DateTimeRange**

CalendarHeader

A group item containing generic information applicable to the entire Calendar.

(sequence)

The sequence of items below is mandatory. A single instance is required.

CalendarNumber

CalendarNumber is mandatory. A single instance is required.

The sequential number that uniquely identifies the Calendar e-Document.

CalendarIssueDate

CalendarIssueDate is mandatory. A single instance is required.

The date and optionally time when the Calendar e-Document was created.

RequestNumber

RequestNumber is optional. A single instance might exist.

A unique tracking number specifically identifying the InfoRequest e-Document to the originator. The tracking number is returned with the "information", the answer, to help match the answer to the request.

SenderParty

SenderParty is mandatory. A single instance is required.

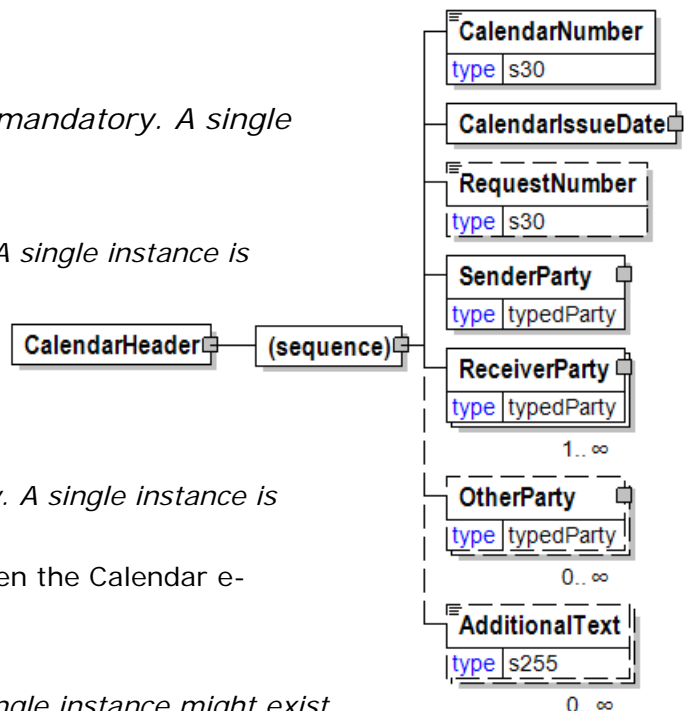

The business entity issuing the e-Document, the source of the document.

The entity responsible for the content. If the sender party has out sourced the message service to a third party the SenderParty is the issuer of the e-Document and not the party performing the transmission service of the electronic message.

ReceiverParty

ReceiverParty is mandatory. One instance is required, multiple instances might exist.

The business entity for whom the e-Document is intended, the destination of the document.

The entity interested in the content. If the receiver party has outsourced the message service to a third party the ReceiverParty is the intended party for the e-Document and not the party performing the receiving service of the electronic message.

OtherParty

OtherParty is optional. Multiple instances might exist.

An organisation or business entity other than those specifically detailed within a e-Document.

AdditionalText

AdditionalText is optional. Multiple instances might exist.

A text field that is used to communicate information not previously defined or for special instructions. To be used only for circumstances not covered by specific elements.

CalendarIssueDate

The date and optionally time when the Calendar e-Document was created.

(sequence)

The sequence of items below is mandatory. A single instance is required.

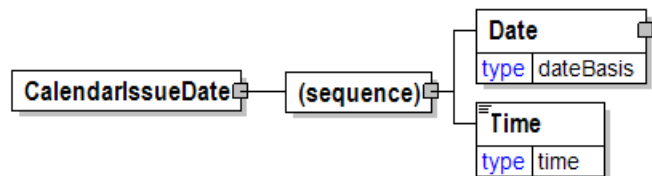

Date

Date is mandatory. A single instance is required.

A group element that contains the specification of Year, Month, and Day.

Time

Time is mandatory. A single instance is required.

Times are treated in a standard XML fashion with a special case used to indicate a generalized "local" time. The standard XML approach to time is hh:mm:ss, hh:mm:ssZ, or hh:mm:ss±hh:mm.

hh:mm:ss±hh:mm is used to represent a time with a time zone. The time zone is communicated as the number of hours offset from the Universal Time Coordinate (UTC), a.k.a. Greenwich Mean Time.

hh:mm:ssZ indicates the time at Zulu (another name for UTC). Based on the convention described in the next bullet it will be important for users within UTC to use "Z" when communicating a time in their time zone to other users.

hh:mm:ss or hh:mm indicates in the XML standard the time at UTC however, within papiNet it is used to represent the applicable local time. Caution should be used when processing times of this nature as the papiNet approach may be in discord with other users of XML.

CalendarNumber

The sequential number that uniquely identifies the Calendar e-Document.

CalendarNumber
type s30

CalendarRequestDetail

A grouping element that provides the parameters to be used when responding with a Calendar e-Document.

CalendarType [attribute]

CalendarType is mandatory. A single instance is required.

Identifies the intention of the entire Calendar e-Document.

Refer to CalendarType definition for any enumerations.

(sequence)

The sequence of items below is mandatory. A single instance is required.

SupplierParty

SupplierParty is optional. Multiple instances might exist.

The organisation or business entity responsible for providing the product. SupplierParty is also the seller of the product, if Seller is not specified as OtherParty = Seller.

CalendarNumber

CalendarNumber is optional. A single instance might exist.

The sequential number that uniquely identifies the Calendar e-Document.

CalendarIssueDate

CalendarIssueDate is optional. A single instance might exist.

The date and optionally time when the Calendar e-Document was created.

DateTimeRange

DateTimeRange is optional. A single instance might exist.

Specifies a date and/or time range.

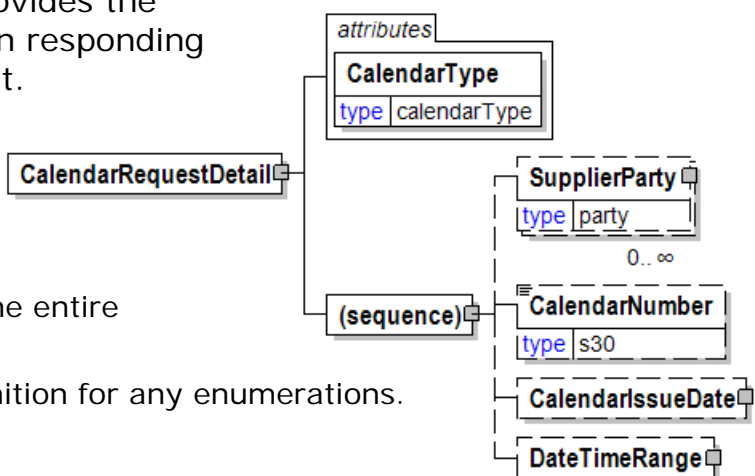

CalendarSequence

A group item containing information that relates to a line on the Calendar.

(sequence)

The sequence of items below is mandatory. A single instance is required.

CalendarSequenceNumber

CalendarSequenceNumber is mandatory. A single instance is required.

The sequential number that uniquely identifies the Calendar sequence within the Calendar e-Document.

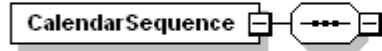

LocationParty

LocationParty is mandatory. A single instance is required.

The organization or business entity where the business event took place or will take place.

(choice)

[choice] is optional because of choice construct.

SupplyPoint

SupplyPoint is optional because of choice construct.

Grouping element that contains items describing a supply point. A SupplyPoint belongs to a LocationParty, e.g. in a DeliveryOrigin or DeliveryDestination, and describes where goods are stored and can be loaded or unloaded. A SupplyPoint can for example be a loading or unloading gate at a warehouse or a road side landing at a logging area in the forest.

LocationCode

LocationCode is optional because of choice construct.

A code used to identify a specific physical location within a site identified by a party, e.g. a loading station in a warehouse or an unloading station at a printer site.

LocationCode will be deprecated in a future version. Use SupplyPoint instead of LocationCode.

TransportInformation

TransportInformation is optional. A single instance might exist.

A grouping element for transport information.

CalendarEntry

CalendarEntry is mandatory. One instance is required, multiple instances might exist.

Detailed description of the times and contingencies for the given LocationParty.

AdditionalText

AdditionalText is optional. Multiple instances might exist.

A text field that is used to communicate information not previously defined or for special instructions. To be used only for circumstances not covered by specific

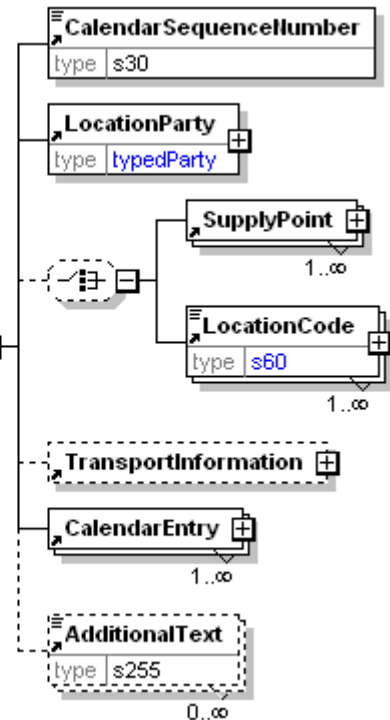

elements.

CalendarSequenceNumber

The sequential number that uniquely identifies the Calendar sequence within the Calendar e-Document.

CalendarSequenceNumber	
type	s30

CalendarStatus [attribute]

Identifies the status of the entire Calendar e-Document.

This item is restricted to the following list.

attribute
CalendarStatus
type calendarStatusType

Amended

The supplied information is changed.

Cancelled

The supplied information has been cancelled. Items that have been cancelled are not included in totals on the summary levels of the e-Document.

Original

The supplied information is the first version of that information.

CalendarType [attribute]

Identifies the intention of the entire Calendar e-Document.

This item is restricted to the following list.

attribute
CalendarType
type calendarType

LoadingSchedule

The schedule for transport vehicle loading.

OfficeSchedule

The schedule for office personnel.

SupportSchedule

The support schedule for transport operations.

UnloadingSchedule

The schedule for transport vehicle unloading.

Calibration

A grouping element that contains information about calibration of the measuring equipment.

(sequence)

The sequence of items below is mandatory. A single instance is required.

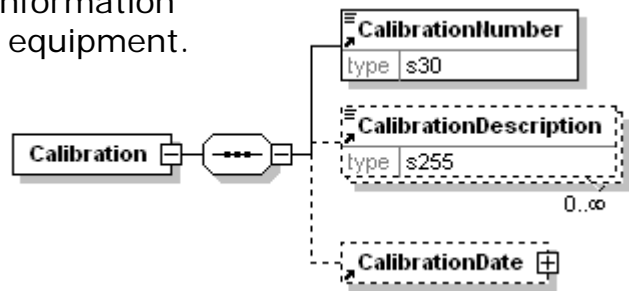

CalibrationNumber

CalibrationNumber is mandatory. A single instance is required.

A unique identifier for the calibration event.

CalibrationDescription

CalibrationDescription is optional. Multiple instances might exist.

A text element describing the calibration event.

CalibrationDate

CalibrationDate is optional. A single instance is required.

The date when calibration of the measuring equipment was done.

CalibrationDate

The date when calibration of the measuring equipment was done.

(sequence)

The sequence of items below is mandatory. A single instance is required.

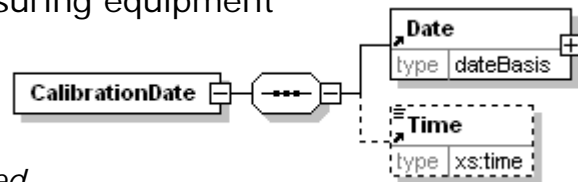

Date

Date is mandatory. A single instance is required.

A group element that contains the specification of Year, Month, and Day.

Time

Time is optional. A single instance might exist.

Times are treated in a standard XML fashion with a special case used to indicate a generalized "local" time. The standard XML approach to time is hh:mm:ss, hh:mm:ssZ, or hh:mm:ss±hh:mm.

- hh:mm:ss±hh:mm is used to represent a time with a time zone. The time zone is communicated as the number of hours offset from the Universal Time Coordinate (UTC), a.k.a. Greenwich Mean Time.
- hh:mm:ssZ indicates the time at Zulu (another name for UTC). Based on the convention described in the next bullet it will be important for users within UTC to use "Z" when communicating a time in their time zone to other users.
- hh:mm:ss or hh:mm indicates in the XML standard the time at UTC however, within papiNet it is used to represent the applicable local time. Caution should be used when processing times of this nature as the papiNet approach may be in discord with other users of XML.

CalibrationDescription

A text element describing the calibration event.

CalibrationDescription	
type	s255

CalibrationNumber

A unique identifier for the calibration event.

CalibrationNumber	
type	s30

Caliper

The thickness of a sheet of paper under standard test conditions.

TestMethod [attribute]

TestMethod is optional. A single instance might exist.

The method used to determine the results of the test under consideration.

TestAgency [attribute]

TestAgency is optional. A single instance might exist.

The agency that has set the parameters for the testing

Refer to TestAgency definition for any enumerations.

SampleType [attribute]

SampleType is optional. A single instance might exist.

Communicates how sampling was done to measure the product characteristics.

Refer to SampleType definition for any enumerations.

ResultSource [attribute]

ResultSource is optional. A single instance might exist.

Used to define the data source of the specified test

Refer to ResultSource definition for any enumerations.

(sequence)

The sequence of items below is mandatory. A single instance is required.

DetailValue

DetailValue is mandatory. A single instance is required.

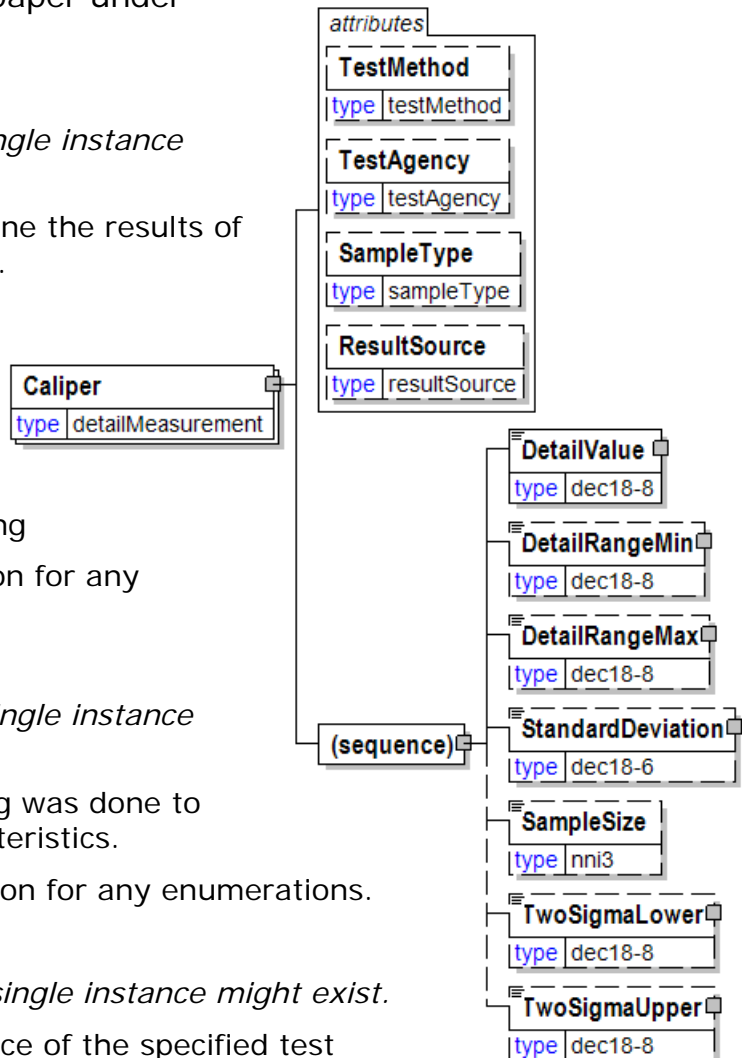

A numeric value expressed in the unit of measure (UOM).

DetailRangeMin

DetailRangeMin is optional. A single instance might exist.

The minimum value (lower boundary) allowed for the DetailValue that is the parent of this element.

DetailRangeMax

DetailRangeMax is optional. A single instance might exist.

The maximum value (upper boundary) allowed for the DetailValue that is the parent of this element.

StandardDeviation

StandardDeviation is optional. A single instance might exist.

A statistic used as a measure of dispersion in a distribution.

SampleSize

SampleSize is optional. A single instance might exist.

The number of samples used to determine the product characteristic in question.

TwoSigmaLower

TwoSigmaLower is optional. A single instance might exist.

Two sigma (a measure of dispersion associated with standard deviation) on the lower side of the standard deviation.

TwoSigmaUpper

TwoSigmaUpper is optional. A single instance might exist.

Two sigma (a measure of dispersion associated with standard deviation) on the upper side of the standard deviation.

CallOff

The CallOff element is the root element for the CallOff e-Document.

A CallOff is a delivery schedule for product(s). Products to be delivered can be specified by product specifications or by purchase orders. Any party as agreed in a Trading Partner Agreement can send a CallOff. Each line item in a CallOff refers either to a product included in a PurchaseOrder or to the product specifications contained in the line item. The CallOff specifies delivery schedule(s) and quantities for product(s) to be delivered. The schedule may define a specific date and/or time for delivery or include a time range. All products covered by a CallOff must be delivered to a single location.

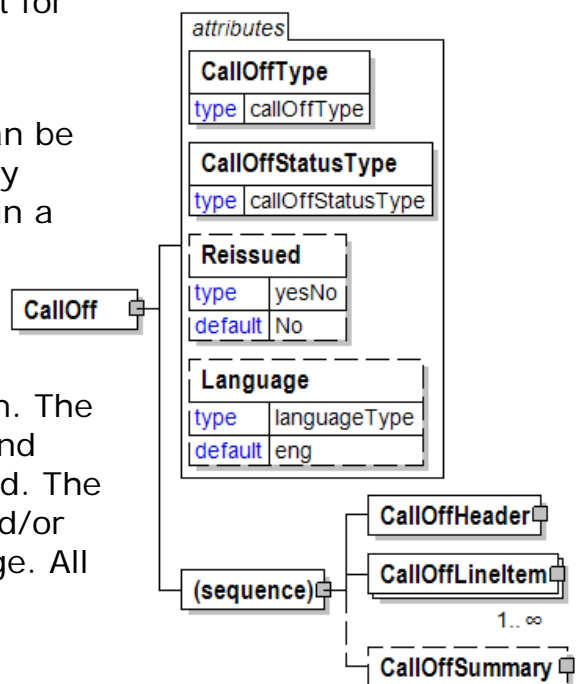

CallOffType [attribute]

CallOffType is mandatory. A single instance is required.

CallOffType defines the type of CallOff.

Refer to CallOffType definition for any enumerations.

CallOffStatusType [attribute]

CallOffStatusType is mandatory. A single instance is required.

Identifies the status of the entire CallOff (in other words, at the root level).

Refer to CallOffStatusType definition for any enumerations.

Reissued [attribute]

Reissued is optional. A single instance might exist.

Either "Yes" or "No".

Refer to Reissued definition for any enumerations.

Language [attribute]

Language is optional. A single instance might exist.

XML has embraced 2 and 3 digit language codes through the application of an addendum to the standard.

Refer to Language definition for any enumerations.

(sequence)

The sequence of items below is mandatory. A single instance is required.

CallOffHeader

CallOffHeader is mandatory. A single instance is required.

A group item containing generic information applicable to the entire CallOff.

CallOffLineItem

CallOffLineItem is mandatory. One instance is required, multiple instances might exist.

A group item containing information that relates to a line on the CallOff.

CallOffSummary

CallOffSummary is optional. A single instance might exist.

Contains summary information that applies to the CallOff.

CallOffConfirmationIssuedDate

The Date and Time on which the CallOff confirmation was issued.

(sequence)

The sequence of items below is mandatory. A single instance is required.

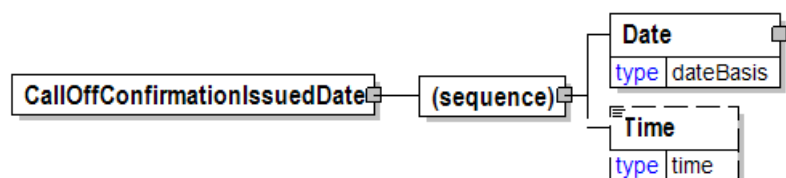

Date

Date is mandatory. A single instance is required.

papiNet V2R31

A group element that contains the specification of Year, Month, and Day.

Time

Time is optional. A single instance might exist.

Times are treated in a standard XML fashion with a special case used to indicate a generalized "local" time. The standard XML approach to time is hh:mm:ss, hh:mm:ssZ, or hh:mm:ss±hh:mm.

hh:mm:ss±hh:mm is used to represent a time with a time zone. The time zone is communicated as the number of hours offset from the Universal Time Coordinate (UTC), a.k.a. Greenwich Mean Time.

hh:mm:ssZ indicates the time at Zulu (another name for UTC). Based on the convention described in the next bullet it will be important for users within UTC to use "Z" when communicating a time in their time zone to other users.

hh:mm:ss or hh:mm indicates in the XML standard the time at UTC however, within papiNet it is used to represent the applicable local time. Caution should be used when processing times of this nature as the papiNet approach may be in discord with other users of XML.

CallOffConfirmationLineItemNumber

The sequential number that uniquely identifies the CallOff confirmation line item.

CallOffConfirmationLineItemNumber	
type	lineNumberType

CallOffConfirmationNumber

The unique identifier given to the CallOff confirmation.

CallOffConfirmationNumber	
type	s30

CallOffHeader

A group item containing generic information applicable to the entire CallOff.

CallOffHeaderStatusType [attribute]

CallOffHeaderStatusType is optional. A single instance might exist.

CallOffHeaderStatusType defines the status of the CallOff header.

Refer to CallOffHeaderStatusType definition for any enumerations.

(sequence)

The sequence of items below is mandatory. A single instance is required.

CallOffInformation

CallOffInformation is mandatory. A single instance is required.

A group item containing information unique to the CallOff which is generated and supplied by the buyer, seller, or any party involved.

BuyerParty

BuyerParty is mandatory. A single instance is required.

The legal entity to which the product is sold. Also commonly referred to as the sold-to party or customer. If no OtherParty is defined as the Payer, the Buyer is the Payer.

BillToParty

BillToParty is optional. A single instance might exist.

The address where the Invoice is to be sent.

SupplierParty

SupplierParty is mandatory. A single instance is required.

The organisation or business entity responsible for providing the product. SupplierParty is also the seller of the product, if Seller is not specified as OtherParty = Seller.

CarrierParty

CarrierParty is optional. A single instance might exist.

The party performing the transport of the product from the pickup location to the

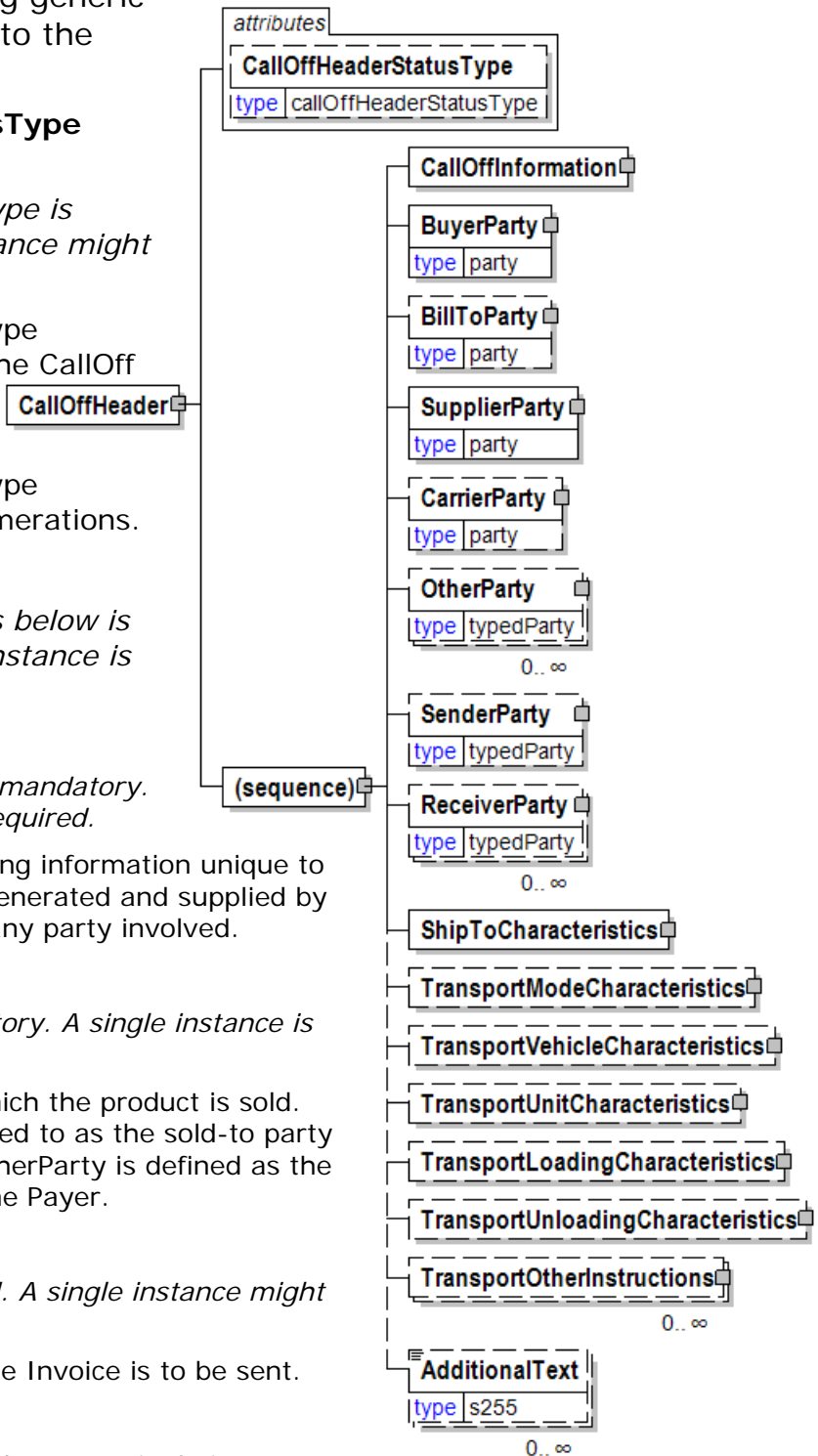

ship-to location; could be a hauler.

OtherParty

OtherParty is optional. Multiple instances might exist.

An organisation or business entity other than those specifically detailed within a e-Document.

SenderParty

SenderParty is optional. A single instance might exist.

The business entity issuing the e-Document, the source of the document.

The entity responsible for the content. If the sender party has out sourced the message service to a third party the SenderParty is the issuer of the e-Document and not the party performing the transmission service of the electronic message.

ReceiverParty

ReceiverParty is optional. Multiple instances might exist.

The business entity for whom the e-Document is intended, the destination of the document.

The entity interested in the content. If the receiver party has outsourced the message service to a third party the ReceiverParty is the intended party for the e-Document and not the party performing the receiving service of the electronic message.

ShipToCharacteristics

ShipToCharacteristics is mandatory. A single instance is required.

A group item that provides information important for the Ship-To Party.

A group item that provides information important for the Ship-To Party. ShipToCharacteristics may be referenced at both the header and line item level. The reference at the header is required and acts as a default for the value at the line level, unless overridden at the line level.

TransportModeCharacteristics

TransportModeCharacteristics is optional. A single instance might exist.

A group item defining the primary mode of transport.

TransportVehicleCharacteristics

TransportVehicleCharacteristics is optional. A single instance might exist.

A group item defining the primary means of transporting the goods, such as a side port vessel. In some instances, the transport unit and vehicle are the same.

TransportUnitCharacteristics

TransportUnitCharacteristics is optional. A single instance might exist.

A group item defining and identifying the primary means of containing the goods. In some instances, the transport unit and vehicle are the same.

TransportLoadingCharacteristics

TransportLoadingCharacteristics is optional. A single instance might exist.

A group item defining how the transported items are to be loaded.

TransportUnloadingCharacteristics

TransportUnloadingCharacteristics is optional. A single instance might exist.

A group item defining how the transported items are to be unloaded.

TransportOtherInstructions

TransportOtherInstructions is optional. Multiple instances might exist.

A group item defining any other instructions for the transport not covered in the description of transport mode, vehicle, unit, and loading characteristics or defining an alternative description for the categories mentioned above.

AdditionalText

AdditionalText is optional. Multiple instances might exist.

A text field that is used to communicate information not previously defined or for special instructions. To be used only for circumstances not covered by specific elements.

CallOffHeaderStatusType [attribute]

CallOffHeaderStatusType defines the status of the CallOff header.

This item is restricted to the following list.

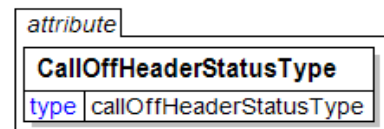

Accepted

The supplied information is accepted.

Amended

The supplied information is changed.

Cancelled

The supplied information has been cancelled. Items that have been cancelled are not included in totals on the summary levels of the e-Document.

NoAction

The supplied information has not been amended and thereby requires no action.

Original

The supplied information is the first version of that information.

Rejected

The supplied information is rejected.

CallOffInformation

A group item containing information unique to the CallOff which is generated and supplied by the buyer, seller, or any party involved.

(sequence)

The sequence of items below is mandatory. A single instance is required.

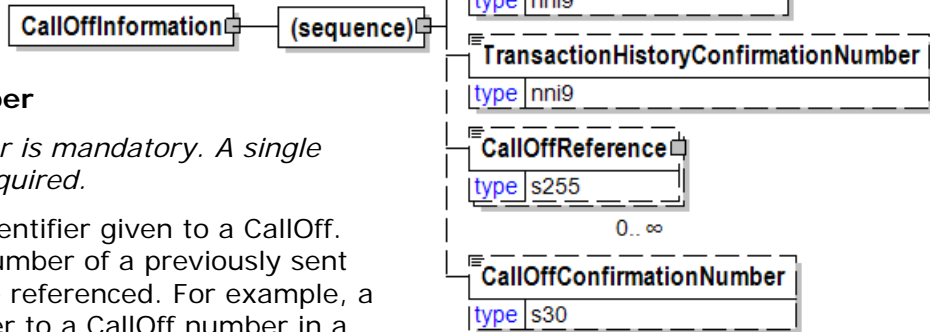

CallOffNumber

CallOffNumber is mandatory. A single instance is required.

The unique identifier given to a CallOff. The CallOff number of a previously sent CallOff can be referenced. For example, a seller can refer to a CallOff number in a DeliveryMessage.

CallOffIssuedDate

CallOffIssuedDate is mandatory. A single instance is required.

The Date and Time when the CallOff was issued.

CallOffConfirmationIssuedDate

CallOffConfirmationIssuedDate is optional. A single instance might exist.

The Date and Time on which the CallOff confirmation was issued.

TransactionHistoryNumber

TransactionHistoryNumber is optional. A single instance might exist.

A sequential number that keeps track of the version of a document being sent by the document originator except in the case where TransactionHistoryConfirmation is used, in which case the TransactionHistoryNumber refers to the trigger transaction for which the confirmation is being sent.

TransactionHistoryConfirmationNumber

TransactionHistoryConfirmationNumber is optional. A single instance might exist.

A sequential number that indicates the version of the confirmation document being sent.

CallOffReference

CallOffReference is optional. Multiple instances might exist.

An element item detailing relevant references pertaining to the CallOff. CallOffReference uses the CallOffReferenceType attribute.

CallOffConfirmationNumber

CallOffConfirmationNumber is optional. A single instance might exist.

The unique identifier given to the CallOff confirmation.

CallOffIssuedDate

The Date and Time when the CallOoff was issued.

(sequence)

The sequence of items below is mandatory. A single instance is required.

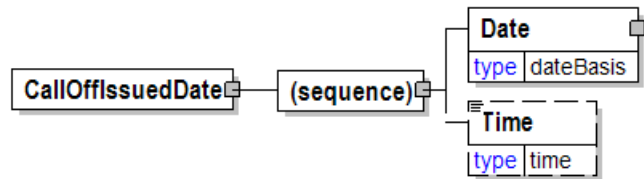

Date

Date is mandatory. A single instance is required.

A group element that contains the specification of Year, Month, and Day.

Time

Time is optional. A single instance might exist.

Times are treated in a standard XML fashion with a special case used to indicate a generalized "local" time. The standard XML approach to time is hh:mm:ss, hh:mm:ssZ, or hh:mm:ss±hh:mm.

hh:mm:ss±hh:mm is used to represent a time with a time zone. The time zone is communicated as the number of hours offset from the Universal Time Coordinate (UTC), a.k.a. Greenwich Mean Time.

hh:mm:ssZ indicates the time at Zulu (another name for UTC). Based on the convention described in the next bullet it will be important for users within UTC to use "Z" when communicating a time in their time zone to other users.

hh:mm:ss or hh:mm indicates in the XML standard the time at UTC however, within papiNet it is used to represent the applicable local time. Caution should be used when processing times of this nature as the papiNet approach may be in discord with other users of XML.

CallOffLineItem

A group item containing information that relates to a line on the CallOff.

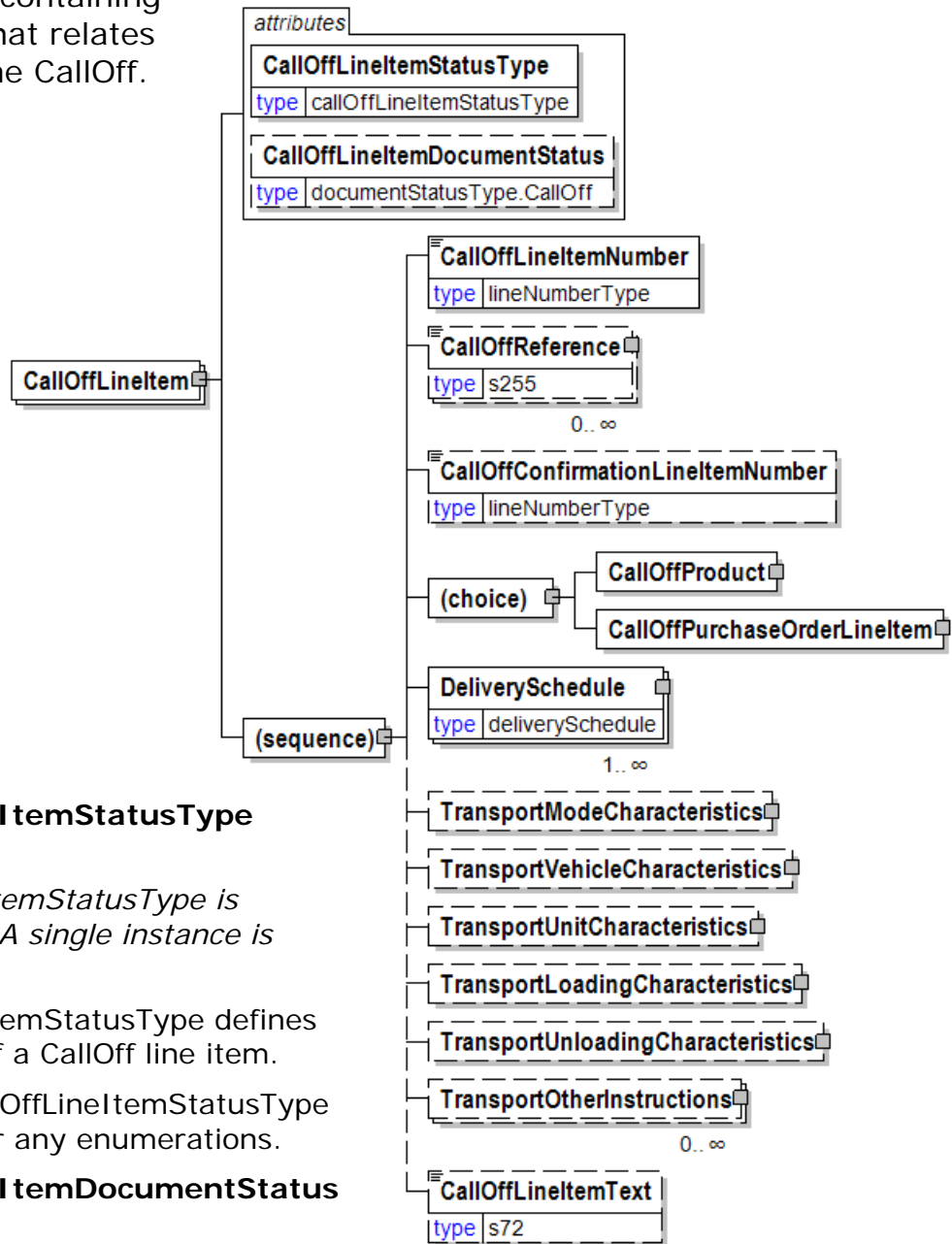

CallOffLineItemStatusType [attribute]

CallOffLineItemStatusType is mandatory. A single instance is required.

CallOffLineItemStatusType defines the status of a CallOff line item.

Refer to CallOffLineItemStatusType definition for any enumerations.

CallOffLineItemDocumentStatus [attribute]

CallOffLineItemDocumentStatus is optional. A single instance might exist.

Defines the actual document status for the CallOffLineItem.

Refer to CallOffLineItemDocumentStatus definition for any enumerations.

(sequence)

The sequence of items below is mandatory. A single instance is required.

CallOffLineItemNumber

CallOffLineItemNumber is mandatory. A single instance is required.

The sequential number that uniquely identifies the CallOff line item.

CallOffReference

CallOffReference is optional. Multiple instances might exist.

An element item detailing relevant references pertaining to the CallOff.
CallOffReference uses the CallOffReferenceType attribute.

CallOffConfirmationLineItemNumber

CallOffConfirmationLineItemNumber is optional. A single instance might exist.

The sequential number that uniquely identifies the CallOff confirmation line item.

(choice)

[choice] is optional because of choice construct.

CallOffProduct

CallOffProduct is optional because of choice construct.

A group item identifying the product to be called off.

CallOffPurchaseOrderLineItem

CallOffPurchaseOrderLineItem is optional because of choice construct.

A group item referring to a PurchaseOrder line item.

DeliverySchedule

DeliverySchedule is mandatory. One instance is required, multiple instances might exist.

A group item defining a series of DeliveryDateWindow(s) in which specified quantities must be delivered.

TransportModeCharacteristics

TransportModeCharacteristics is optional. A single instance might exist.

A group item defining the primary mode of transport.

TransportVehicleCharacteristics

TransportVehicleCharacteristics is optional. A single instance might exist.

A group item defining the primary means of transporting the goods, such as a side port vessel. In some instances, the transport unit and vehicle are the same.

TransportUnitCharacteristics

TransportUnitCharacteristics is optional. A single instance might exist.

A group item defining and identifying the primary means of containing the goods. In some instances, the transport unit and vehicle are the same.

TransportLoadingCharacteristics

TransportLoadingCharacteristics is optional. A single instance might exist.

A group item defining how the transported items are to be loaded.

TransportUnloadingCharacteristics

TransportUnloadingCharacteristics is optional. A single instance might exist.

A group item defining how the transported items are to be unloaded.

TransportOtherInstructions

TransportOtherInstructions is optional. Multiple instances might exist.

A group item defining any other instructions for the transport not covered in the description of transport mode, vehicle, unit, and loading characteristics or defining an alternative description for the categories mentioned above.

CallOffLineItemText

CallOffLineItemText is optional. A single instance might exist.

A free text field to be used for special item instructions.

CallOffLineItemDocumentStatus [attribute]

Defines the actual document status for the CallOffLineItem.

This item is restricted to the following list.

attribute
CallOffLineItemDocumentStatus
type documentStatusType.CallOff

Cancelled

The supplied information of the document item is cancelled. Items that have been cancelled are not included in totals on the summary level of e- Documents.

Confirmed

The supplied information of the document item is agreed. If a requested change or cancellation of an existing document item can not be accepted, then the earlier agreed information of the document item will be re-confirmed.

Pending

The supplied information of the document item is being investigated.

Rejected

The supplied information of the document item can not be accepted. The document item is new or not earlier confirmed.

Requested

The supplied information of the document item is ordered.

CallOffLineItemDocumentStatus [attribute]

Defines the actual document status for the CallOffLineItem.

This item is restricted to the following list.

attribute
CallOffLineItemDocumentStatus
type documentStatusType.CallOffWood

Cancelled

The supplied information of the document item is cancelled. Items that have been cancelled are not included in totals on the summary level of e- Documents.

Confirmed

The supplied information of the document item is agreed. If a requested change or cancellation of an existing document item can not be accepted, then the earlier agreed information of the document item will be re-confirmed.

Pending

The supplied information of the document item is being investigated.

Rejected

The supplied information of the document item can not be accepted. The document item is new or not earlier confirmed.

Requested

The supplied information of the document item is ordered.

CallOffLineItemNumber

The sequential number that uniquely identifies the CallOff line item.

CallOffLineItemNumber	
type	lineNumberType

CallOffLineItemStatusType [attribute]

CallOffLineItemStatusType defines the status of a CallOff line item.

attribute	
CallOffLineItemStatusType	
type	callOffLineItemStatusType

This item is restricted to the following list.

Accepted

The supplied information is accepted.

Amended

The supplied information is changed.

Cancelled

The supplied information has been cancelled. Items that have been cancelled are not included in totals on the summary levels of the e-Document.

NoAction

The supplied information has not been amended and thereby requires no action.

Original

The supplied information is the first version of that information.

Pending

The supplied information is not complete and will be updated later.

Rejected

The supplied information is rejected.

CallOffLineItemText

A free text field to be used for special item instructions.

CallOffLineItemText	
type	s72

CallOffNumber

The unique identifier given to a CallOff. The CallOff number of a previously sent CallOff can be referenced. For example, a seller can refer to a CallOff number in a DeliveryMessage.

CallOffNumber	
type	s30

CallOffPaper

A group item containing elements that describe the paper item.

(sequence)

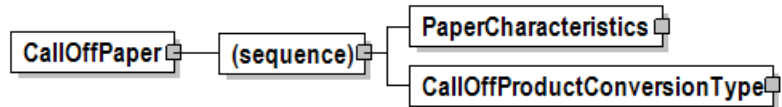

The sequence of items below is mandatory. A single instance is required.

PaperCharacteristics

PaperCharacteristics is mandatory. A single instance is required.

The identifying characteristics of paper most important to the ordering of the item. These are the characteristics that, when associated with a given grade, allow the manufacturer to produce but not convert or package, the paper.

CallOffProductConversionType

CallOffProductConversionType is mandatory. A single instance is required.

A call off reel or a call off sheet.

CallOffProduct

A group item identifying the product to be called off.

(sequence)

The sequence of items below is mandatory. A single instance is required.

(sequence)

The sequence of items below is mandatory. One instance is required, multiple instances might exist.

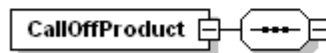

ProductIdentifier

ProductIdentifier is mandatory. A single instance is required.

Used to communicate the code of the article, in a variety of formats designated by the type.

ProductDescription

ProductDescription is optional. Multiple instances might exist.

An element used to communicate a human readable description of the product in the language specified by the Language attribute.

MillCharacteristics

MillCharacteristics is optional. A single instance

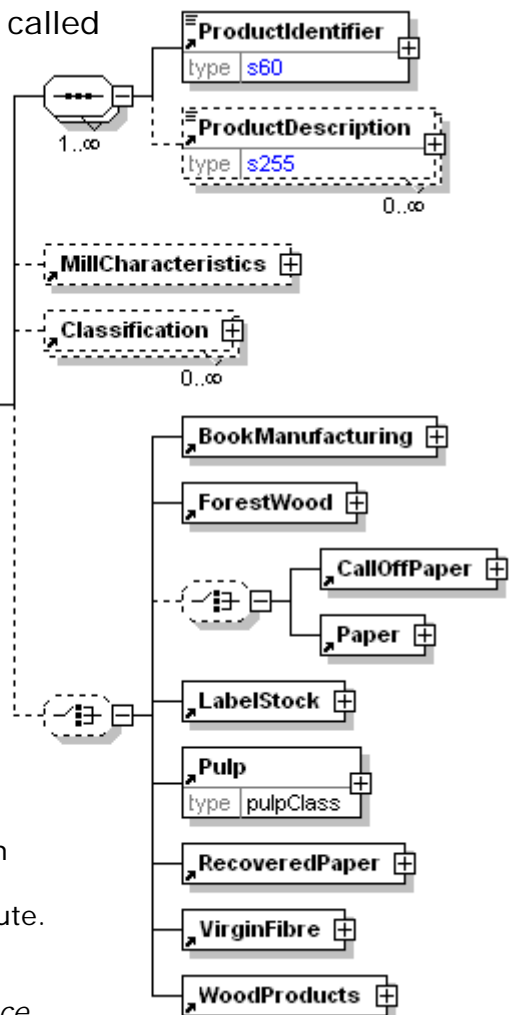

might exist.

A group item defining the mill party and machine identifier where a product is or was produced.

Classification

Classification is optional. Multiple instances might exist.

A group item that details the product classification according to a particular organization's scheme. An item across multiple classifications would still be recognized as the same item. Examples of some product classifications are: Containerboard, Pulp-Dissolving, or Newsprint.

(choice)

[choice] is optional because of choice construct.

BookManufacturing

BookManufacturing is optional because of choice construct.

BookManufacturing is a group element that contains the elements that describe the book manufacturing process.

ForestWood

ForestWood is optional because of choice construct.

A grouping element with information about characteristics for Forest Wood products.

(choice)

[choice] is optional because of choice construct.

CallOffPaper

CallOffPaper is optional because of choice construct.

A group item containing elements that describe the paper item.

Paper

Paper is optional because of choice construct.

A group item defining the characteristics of the paper product.

LabelStock

LabelStock is optional because of choice construct.

LabelStock contains the attributes and characteristics that define the label stock product.

Pulp

Pulp is optional because of choice construct.

A group item defining the characteristics of pulp that are not dependent on a particular conversion process.

RecoveredPaper

RecoveredPaper is optional because of choice construct.

A group item defining the characteristics of recycled fibre that are not dependent on a particular conversion process.

VirginFibre

VirginFibre is optional because of choice construct.

Virgin Fibre

WoodProducts

WoodProducts is optional because of choice construct.

A grouping element for all wood products.

CallOffProductConversionType

A call off reel or a call off sheet.

(choice)

[choice] is optional because of choice construct.

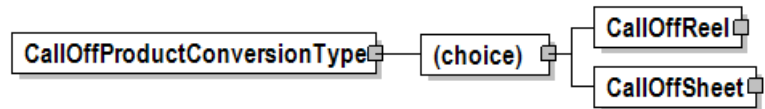

CallOffReel

CallOffReel is optional because of choice construct.

A group item containing reel information for the CallOff.

CallOffSheet

CallOffSheet is optional because of choice construct.

A group item containing sheet information for the CallOff.

CallOffPurchaseOrderLineItem

A group item referring to a PurchaseOrder line item.

(sequence)

The

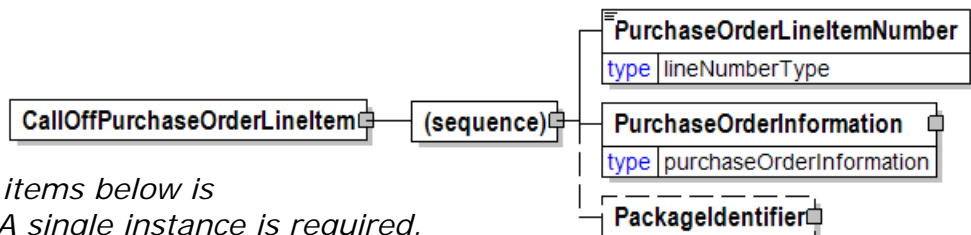

sequence of items below is mandatory. A single instance is required.

PurchaseOrderLineItemNumber

PurchaseOrderLineItemNumber is mandatory. A single instance is required.

The sequential number that uniquely identifies the PurchaseOrder line item.

PurchaseOrderInformation

PurchaseOrderInformation is mandatory. A single instance is required.

A group item containing information unique to this PurchaseOrder, which is provided by the buyer. PurchaseOrderInformation can be optional in the supply chain. Invoices are created without having a PurchaseOrder in Vendor Managed Inventory. Freight invoices also will not have a PurchaseOrder number.

PackageIdentifier

PackageIdentifier is optional. A single instance might exist.

The identifier of the productpackage (such as reel ID or pallet ID) that is used along with the PurchaseOrderLineItemNumber to call off the product.

CallOffReel

A group item containing reel information for the CallOff.

(sequence)

The sequence of items below is mandatory. A single instance is required.

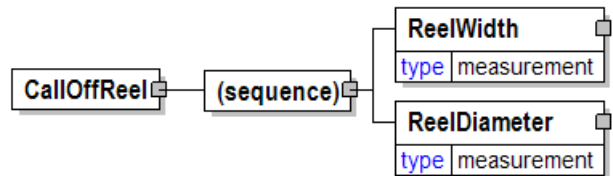

ReelWidth

ReelWidth is mandatory. A single instance is required.

The width of reel from edge to edge excluding packaging.

ReelDiameter

ReelDiameter is mandatory. A single instance is required.

The diameter measurement of reel excluding packaging.

CallOffReference

An element item detailing relevant references pertaining to the CallOff. CallOffReference uses the CallOffReferenceType attribute.

CallOffReferenceType [attribute]

CallOffReferenceType is mandatory. A single instance is required.

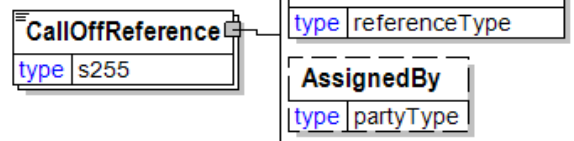

Provides a contextual explanation of the specific reference identifier. Many items are currently prefixed by "Buyer", "Forwarder", "Manufacturer", "Mill", "Seller", "Supplier", "Warehouse", or "Vendor". Check for an existing non-prefixed version and use the non-prefixed version instead. In the (yet to be announced release date) version 3.0 the prefixed versions will be removed. Instead the attribute @AssignedBy will communicate the information previously communicated in the prefix.

Refer to CallOffReferenceType definition for any enumerations.

AssignedBy [attribute]

AssignedBy is optional. A single instance might exist.

Identifies the type of party that has assigned the associated item, e.g. a reference of type OrderNumber.

Refer to AssignedBy for any enumerations.

CallOffReferenceType [attribute]

Provides a contextual explanation of the specific reference identifier. Many items are currently prefixed by "Buyer", "Forwarder", "Manufacturer", "Mill", "Seller", "Supplier", "Warehouse", or "Vendor". Check for an existing non-prefixed version and use the non-prefixed version instead. In the (yet to be announced release date) version 3.0 the prefixed versions will be removed. Instead

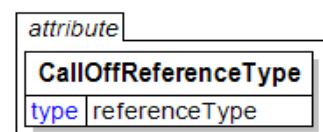

the attribute @AssignedBy will communicate the information previously communicated in the prefix.

Refer to the [referenceType](#) entry for the list of enumerations and their definitions.

CallOffSheet

A group item containing sheet information for the CallOff.

(sequence)

The sequence of items below is mandatory. A single instance is required.

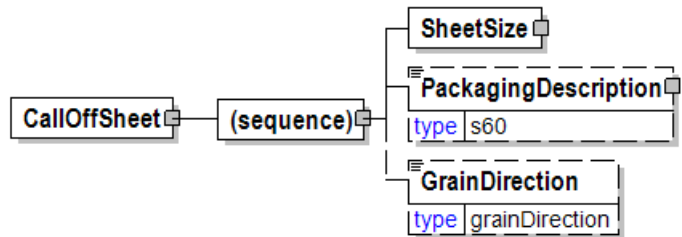

SheetSize

SheetSize is mandatory. A single instance is required.

A group item that contains elements relative to the sheet size.

PackagingDescription

PackagingDescription is optional. A single instance might exist.

A text field element describing the packaging of a product.

GrainDirection

GrainDirection is optional. A single instance might exist.

Defines the primary orientation/alignment (Long or Short) of the cellulose fibres in a sheet or web of paper, which results from the flow of fibres in a water suspension during the papermaking process.

Refer to GrainDirection definition for any enumerations.

CallOffStatusType [attribute]

Identifies the status of the entire CallOff (in other words, at the root level).

This item is restricted to the following list.

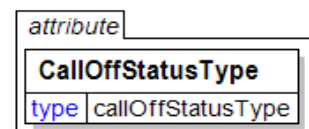

Accepted

The supplied information is accepted.

Amended

The supplied information is changed.

Cancelled

The supplied information has been cancelled. Items that have been cancelled are not included in totals on the summary levels of the e-Document.

Original

The supplied information is the first version of that information.

Rejected

The supplied information is rejected.

CallOffSummary

Contains summary information that applies to the CallOff.

(sequence)

The sequence of items below is mandatory. A single instance is required.

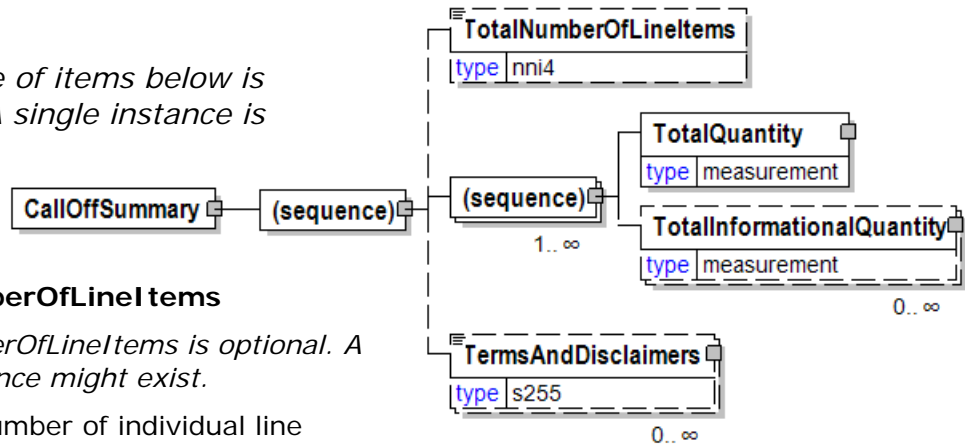

TotalNumberOfLineItems

TotalNumberOfLineItems is optional. A single instance might exist.

The total number of individual line items in the document, regardless of the status or type.

(sequence)

The sequence of items below is mandatory. One instance is required, multiple instances might exist.

TotalQuantity

TotalQuantity is mandatory. A single instance is required.

The total quantity of similar items in the e-Document. TotalQuantity is primarily used in the summary section of documents where it is repeatable to permit totaling for different units of measure.

TotalInformationalQuantity

TotalInformationalQuantity is optional. Multiple instances might exist.

A quantity that is used to communicate related information about the parent element. This element represents a total that is derived from individual line items.

TermsAndDisclaimers

TermsAndDisclaimers is optional. Multiple instances might exist.

An element that contains legal information with an indication of what the Language is.

CallOffType [attribute]

CallOffType defines the type of CallOff.

This item is restricted to the following list.

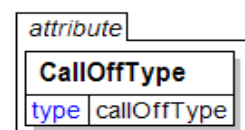

CallOff

Defines a CallOff sent by the buyer to the seller.

CallOffConfirmation

Defines a CallOff confirmation sent in response to a CallOff.

CallOffWood

The CallOffWood element is the root element for the CallOffWood e-Document.

A CallOffWood is a business transaction instructing the consignor (normally the seller) to despatch goods belonging to one or several orders. A CallOffWood contains information about how the goods are to be loaded, quantities, marking instructions etc. It may also contain information about where borders are to be crossed and information concerning transport, such as name of ship and shipping agent. In cases where the CallOffWood is not used, delivery information is included in the order.

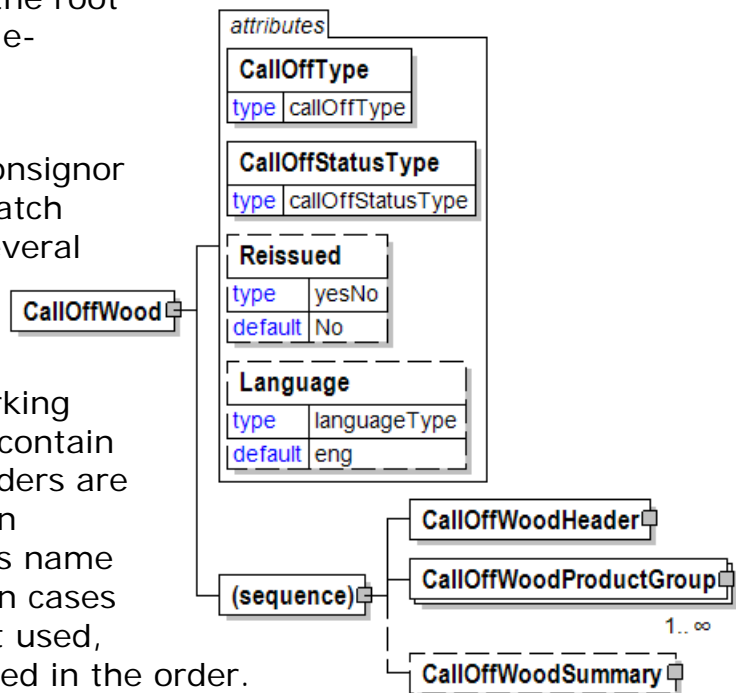

CallOffType [attribute]

CallOffType is mandatory. A single instance is required.

CallOffType defines the type of CallOff.

Refer to CallOffType definition for any enumerations.

CallOffStatusType [attribute]

CallOffStatusType is mandatory. A single instance is required.

Identifies the status of the entire CallOff (in other words, at the root level).

Refer to CallOffStatusType definition for any enumerations.

Reissued [attribute]

Reissued is optional. A single instance might exist.

Either "Yes" or "No".

Refer to Reissued definition for any enumerations.

Language [attribute]

Language is optional. A single instance might exist.

XML has embraced 2 and 3 digit language codes through the application of an addendum to the standard.

Refer to Language definition for any enumerations.

(sequence)

The sequence of items below is mandatory. A single instance is required.

CallOffWoodHeader

CallOffWoodHeader is mandatory. A single instance is required.

papiNet V2R31

Information that applies to the entire Wood market segment CallOff e-Document.

CallOffWoodProductGroup

CallOffWoodProductGroup is mandatory. One instance is required, multiple instances might exist.

CallOffWoodProductGroup provides for groupings of line items in the CallOff e-Document.

This construct was introduced in version v2r30. It is recognized that the introduction of this construct is not in conformance with the papiNet policy of backward compatibility within releases of the same version.

CallOffWoodSummary

CallOffWoodSummary is optional. A single instance might exist.

Summary information that applies to the Wood market segment CallOff e-Document.

CallOffWoodHeader

Information that applies to the entire Wood market segment CallOff e-Document.

CallOffHeaderStatusType [attribute]

CallOffHeaderStatusType is optional. A single instance might exist.

CallOffHeaderStatusType defines the status of the CallOff header.

Refer to CallOffHeaderStatusType definition for any enumerations.

(sequence)

The sequence of items below is mandatory. A single instance is required.

CallOffInformation

CallOffInformation is mandatory. A single instance is required.

A group item containing information unique to the CallOff which is generated and supplied by the buyer, seller, or any party involved.

BuyerParty

BuyerParty is mandatory. A single instance is required.

The legal entity to which the product is sold. Also commonly referred to as the sold-to party or customer. If no OtherParty is defined as the Payer, the Buyer is the Payer.

BillToParty

BillToParty is optional. A single instance might exist.

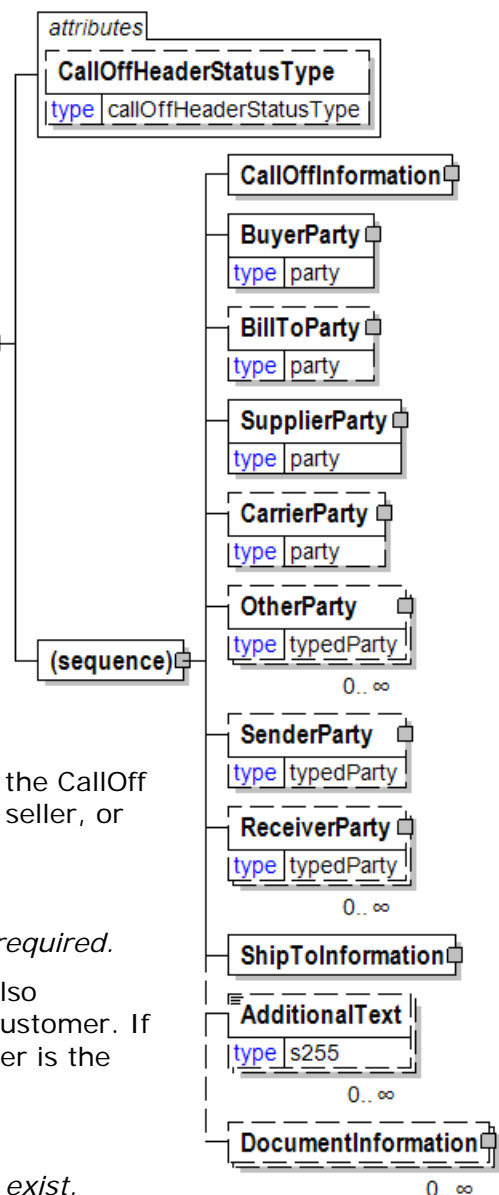

The address where the invoice is to be sent.

SupplierParty

SupplierParty is mandatory. A single instance is required.

The organisation or business entity responsible for providing the product. SupplierParty is also the seller of the product, if Seller is not specified as OtherParty = Seller.

CarrierParty

CarrierParty is optional. A single instance might exist.

The party performing the transport of the product from the pickup location to the ship-to location; could be a hauler.

OtherParty

OtherParty is optional. Multiple instances might exist.

An organisation or business entity other than those specifically detailed within a e-Document.

SenderParty

SenderParty is optional. A single instance might exist.

The business entity issuing the e-Document, the source of the document.

The entity responsible for the content. If the sender party has out sourced the message service to a third party the SenderParty is the issuer of the e-Document and not the party performing the transmission service of the electronic message.

ReceiverParty

ReceiverParty is optional. Multiple instances might exist.

The business entity for whom the e-Document is intended, the destination of the document.

The entity interested in the content. If the receiver party has outsourced the message service to a third party the ReceiverParty is the intended party for the e-Document and not the party performing the receiving service of the electronic message.

ShipToInformation

ShipToInformation is mandatory. A single instance is required.

Group element containing information about the ship to and delivery of a product.

AdditionalText

AdditionalText is optional. Multiple instances might exist.

A text field that is used to communicate information not previously defined or for special instructions. To be used only for circumstances not covered by specific elements.

DocumentInformation

DocumentInformation is optional. Multiple instances might exist.

A group element containing a specification of required documents in the business process. Additional free text to be printed on documents can also be specified.

CallOffWoodLineItem

CallOffWoodLineItem has a required attribute that indicates the status of the line item.

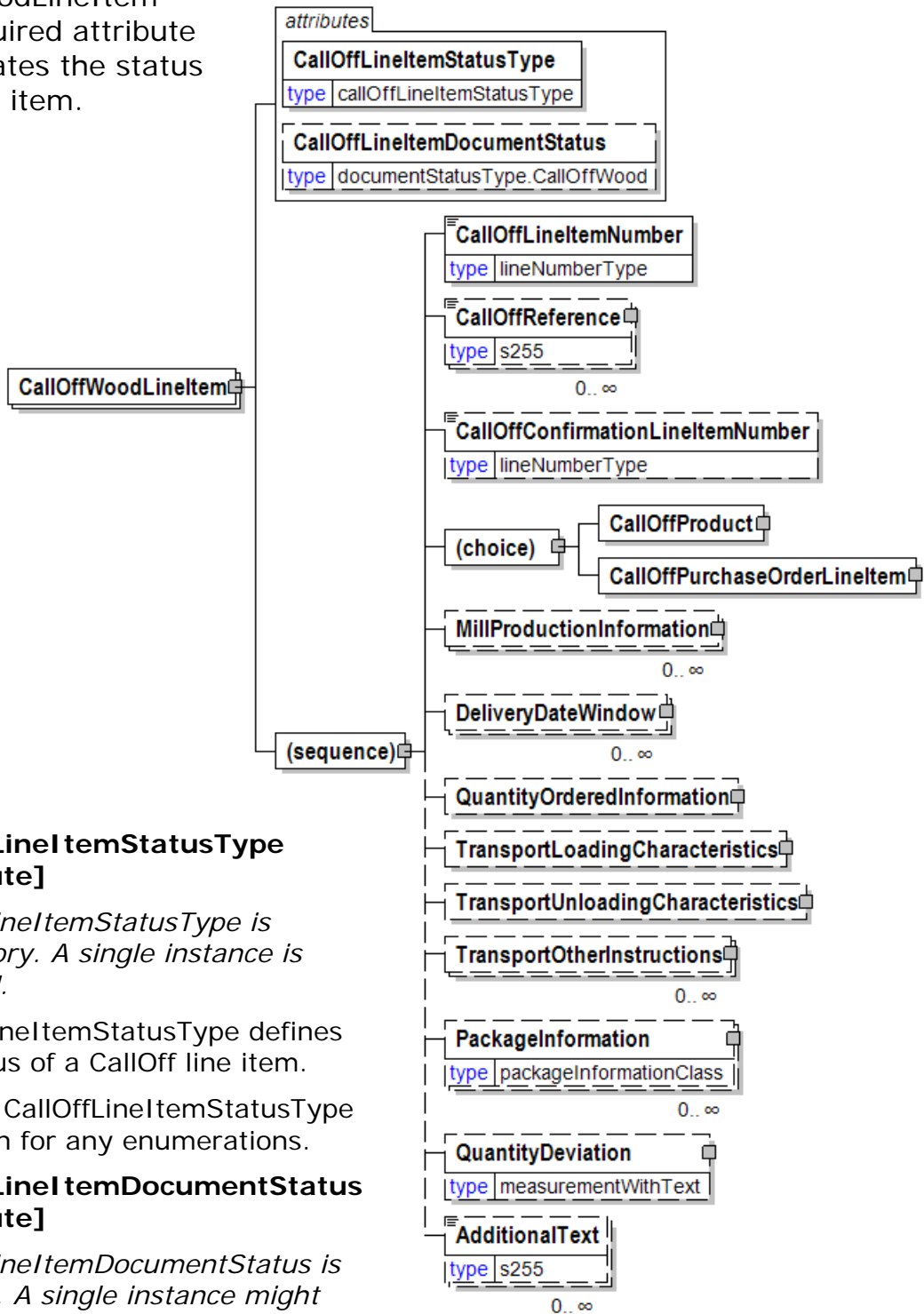

CallOffLineItemStatusType [attribute]

CallOffLineItemStatusType is mandatory. A single instance is required.

CallOffLineItemStatusType defines the status of a CallOff line item.

Refer to CallOffLineItemStatusType definition for any enumerations.

CallOffLineItemDocumentStatus [attribute]

CallOffLineItemDocumentStatus is optional. A single instance might exist.

Defines the actual document status for the CallOffLineItem.

Refer to CallOffLineItemDocumentStatus definition for any enumerations.

(sequence)

The sequence of items below is mandatory. A single instance is required.

CallOffLineItemNumber

CallOffLineItemNumber is mandatory. A single instance is required.

The sequential number that uniquely identifies the CallOff line item.

CallOffReference

CallOffReference is optional. Multiple instances might exist.

An element item detailing relevant references pertaining to the CallOff. CallOffReference uses the CallOffReferenceType attribute.

CallOffConfirmationLineItemNumber

CallOffConfirmationLineItemNumber is optional. A single instance might exist.

The sequential number that uniquely identifies the CallOff confirmation line item.

(choice)

[choice] is optional because of choice construct.

CallOffProduct

CallOffProduct is optional because of choice construct.

A group item identifying the product to be called off.

CallOffPurchaseOrderLineItem

CallOffPurchaseOrderLineItem is optional because of choice construct.

A group item referring to a PurchaseOrder line item.

MillProductionInformation

MillProductionInformation is optional. Multiple instances might exist.

A grouping element that contains information about production at the mill.

DeliveryDateWindow

DeliveryDateWindow is optional. Multiple instances might exist.

A group item defining the date/time interval for delivery to take place. An element which may contain the estimated date for which delivery is expected. This date is not absolute.

QuantityOrderedInformation

QuantityOrderedInformation is optional. A single instance might exist.

Used to identify quantity. The construct provides via InformationalQuantity the ability to provide the Quantity in another UOM. Length is also provided to further specify the quantity.

TransportLoadingCharacteristics

TransportLoadingCharacteristics is optional. A single instance might exist.

A group item defining how the transported items are to be loaded.

TransportUnloadingCharacteristics

TransportUnloadingCharacteristics is optional. A single instance might exist.

A group item defining how the transported items are to be unloaded.

TransportOtherInstructions

TransportOtherInstructions is optional. Multiple instances might exist.

A group item defining any other instructions for the transport not covered in the description of transport mode, vehicle, unit, and loading characteristics or defining an alternative description for the categories mentioned above.

PackageInformation

papiNet V2R31

PackageInformation is optional. Multiple instances might exist.

The purpose of the PackageInformation structure is to clearly identify physical handling items that constitute the delivery.

PackageInformation is the highest level of product packaging it describes the shipping or warehousing unit.

If you are communicating a package, usually for logistics or transport purposes, you should include the PackageType, Identifier, ItemCount, and Quantity. (Note: you still have the ability to describe the item with one of the "named" items.)

If you are communicating one of the named Items there is no need to include PackageType, Identifier, ItemCount, and Quantity.

Since either of these two approaches can be used the entire contents of this element are optional even though the parent may be required. It is expected that you will fill in the appropriate details.

QuantityDeviation

QuantityDeviation is optional. A single instance might exist.

To be deprecated in a future version. Use the Quantity element with a QuantityContext of "Deviation".

AdditionalText

AdditionalText is optional. Multiple instances might exist.

A text field that is used to communicate information not previously defined or for special instructions. To be used only for circumstances not covered by specific elements.

CallOffWoodProductGroup

CallOffWoodProductGroup provides for groupings of line items in the CallOff e-Document.

This construct was introduced in version v2r30.

It is recognized that the introduction

of this construct is not in conformance with the papiNet policy of backward compatibility within releases of the same version.

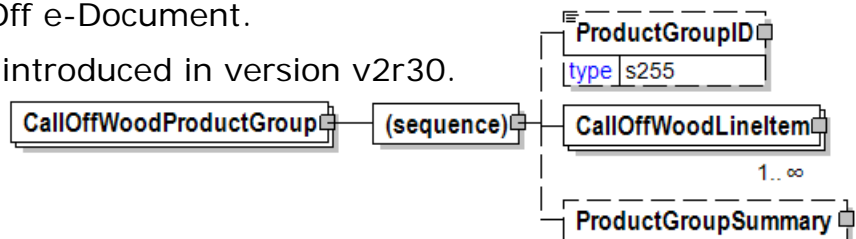

(sequence)

The sequence of items below is mandatory. A single instance is required.

ProductGroupID

ProductGroupID is optional. A single instance might exist.

Possibility to group packages or Shipments. Example: Creating temporary group ID's for logistic reasons or lot number.

CallOffWoodLineItem

CallOffWoodLineItem is mandatory. One instance is required, multiple instances might exist.

CallOffWoodLineItem has a required attribute that indicates the status of the line item.

ProductGroupSummary

ProductGroupSummary is optional. A single instance might exist.

Group of elements to provide summary information on product level.

CallOffWoodSummary

Summary information that applies to the Wood market segment CallOff e-Document.

(sequence)

The sequence of items below is mandatory. A single instance is required.

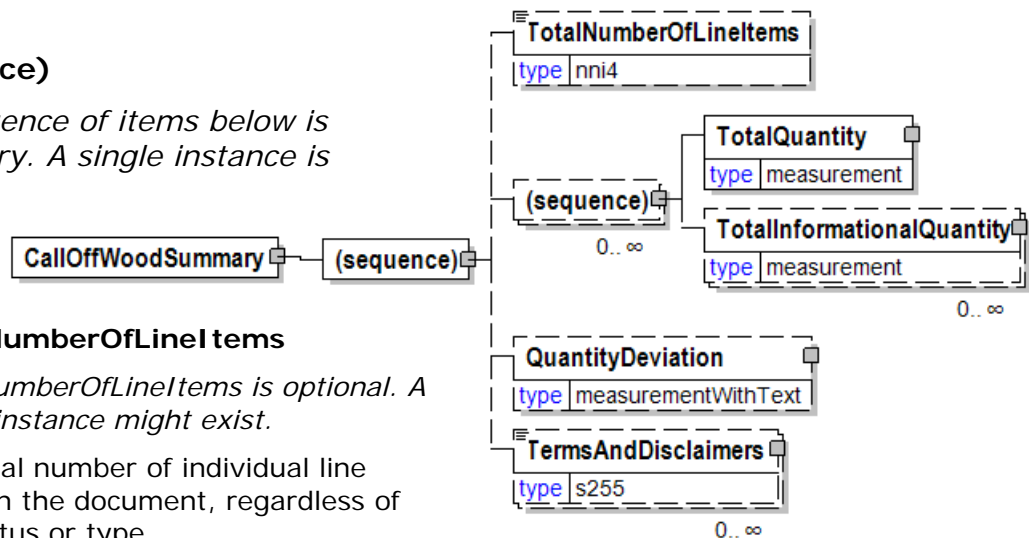

TotalNumberOfLineItems

TotalNumberOfLineItems is optional. A single instance might exist.

The total number of individual line items in the document, regardless of the status or type.

(sequence)

The sequence of items below is optional. Multiple instances might exist.

TotalQuantity

TotalQuantity is mandatory. A single instance is required.

The total quantity of similar items in the e-Document. TotalQuantity is primarily used in the summary section of documents where it is repeatable to permit totaling for different units of measure.

TotalInformationalQuantity

TotalInformationalQuantity is optional. Multiple instances might exist.

A quantity that is used to communicate related information about the parent element. This element represents a total that is derived from individual line items.

QuantityDeviation

QuantityDeviation is optional. A single instance might exist.

To be deprecated in a future version. Use the Quantity element with a QuantityContext of "Deviation".

TermsAndDisclaimers

TermsAndDisclaimers is optional. Multiple instances might exist.

An element that contains legal information with an indication of what the Language is.

CarrierParty

The party performing the transport of the product from the pickup location to the ship-to location; could be a hauler.

LogisticsRole [attribute]

LogisticsRole is optional. A single instance might exist.

Communicates the nature of the logistics role, if any, the party plays in the transaction.

Refer to LogisticsRole definition for any enumerations.

(sequence)

The sequence of items below is mandatory. A single instance is required.

PartyIdentifier

PartyIdentifier is optional. Multiple instances might exist.

A unique identifier of a specific party. This element contains an attribute PartyIdentifierType that indicates the type of party.

NameAddress

NameAddress is mandatory. A single instance is required.

A group item containing name and address of an organisation or business entity.

URL

URL is optional. A single instance might exist.

Universal Resource Locator. While typically a web address you could use this field to hold an email address.

CommonContact

CommonContact is optional. Multiple instances might exist.

Identifies a specific individual associated with the party.

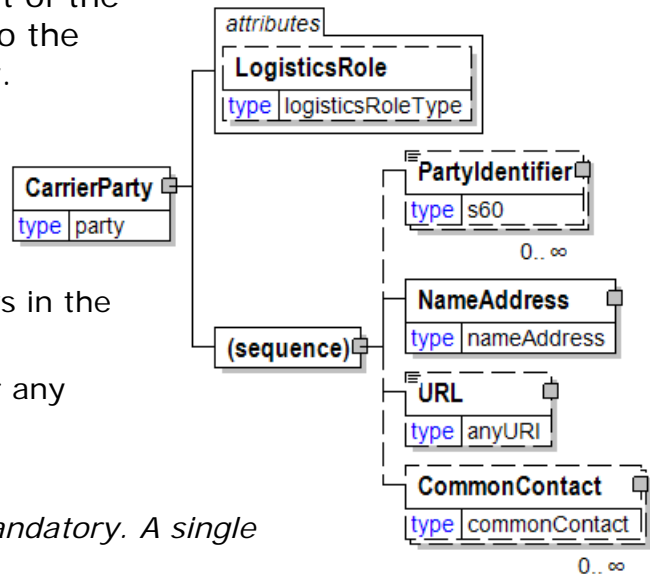

Case

Case information

BindingBackingType [attribute]

BindingBackingType is optional. A single instance might exist.

Specifies the shape of the book spine during the binding operation.

Refer to BindingBackingType definition for any enumerations.

ClothCrossCut [attribute]

ClothCrossCut is optional. A single instance might exist.

Either "Yes" or "No".

Refer to ClothCrossCut definition for any enumerations.

(sequence)

The sequence of items below is mandatory. A single instance is required.

CaseLining

CaseLining is optional. A single instance might exist.

Case lining

CaseSupers

CaseSupers is optional. A single instance might exist.

Case supers

Headband

Headband is optional. Multiple instances might exist.

Headband.

CaseMaking

CaseMaking is optional. A single instance might exist.

Case making

DecorationSpecs

DecorationSpecs is optional. Multiple instances might exist.

Decoration specifications

AdditionalText

AdditionalText is optional. Multiple instances might exist.

A text field that is used to communicate information not previously defined or for special instructions. To be used only for circumstances not covered by specific elements.

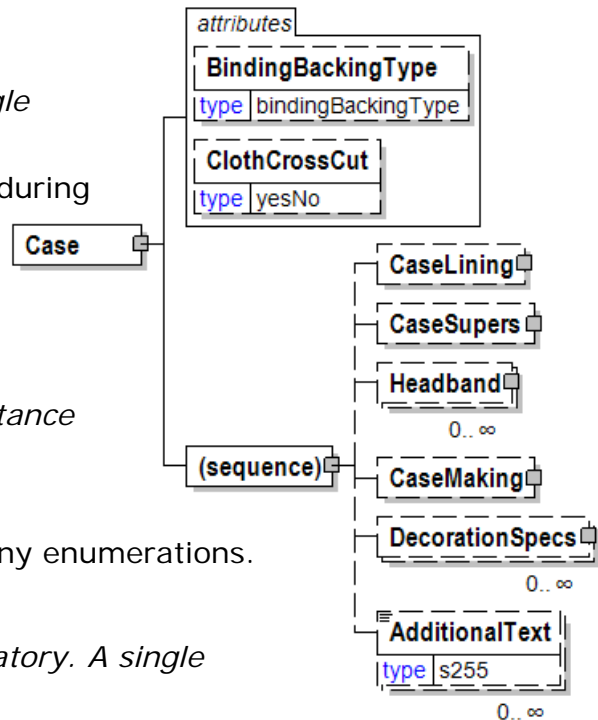

CaseBoardMaterials

Case board materials

CaseLocationType [attribute]

CaseLocationType is optional. A single instance might exist.

Case location type

Refer to CaseLocationType definition for any enumerations.

CaseBoardType [attribute]

CaseBoardType is optional. A single instance might exist.

The type of case board material.

Refer to CaseBoardType definition for any enumerations.

(sequence)

The sequence of items below is mandatory. A single instance is required.

Caliper

Caliper is optional. A single instance might exist.

The thickness of a sheet of paper under standard test conditions.

AdditionalText

AdditionalText is optional. Multiple instances might exist.

A text field that is used to communicate information not previously defined or for special instructions. To be used only for circumstances not covered by specific elements.

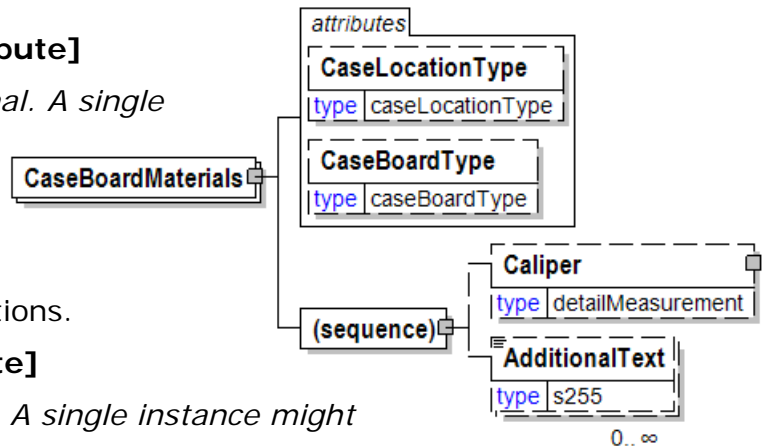

CaseBoardType [attribute]

The type of case board material.

This item is restricted to the following list.

Binders

Chipboard

Eskaboard

Fluted

Padded

PastedOak

Other

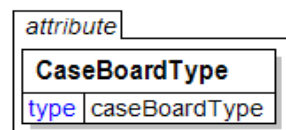

CaseFlushFoot [attribute]

Either "Yes" or "No".

This item is restricted to the following list.

Yes

No

attribute	
CaseFlushFoot	
type	yesNo

CaseLining

Case lining

(sequence)

The sequence of items below is mandatory. A single instance is required.

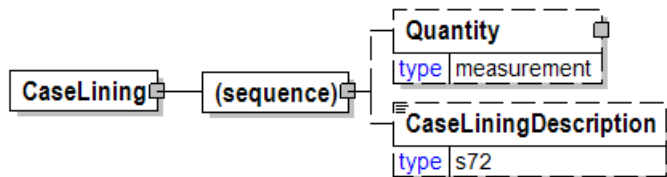

Quantity

Quantity is optional. A single instance might exist.

The Quantity element contains attributes that provide information about the type of quantity that is being communicated, the context in which the particular quantity is to be viewed, and (if the quantity represents an adjustment) an adjustment type.

The Quantity element contains three child elements that enable you to communicate a range of values for the quantity and a target or actual value. It is at this level (Value, RangeMin, and RangeMax) that the unit of measure is specified. This permits the range to be specified in a different unit of measure than the target.

CaseLiningDescription

CaseLiningDescription is optional. A single instance might exist.

Case lining description

CaseLiningDescription

Case lining description

CaseLiningDescription	
type	s72

CaseLocationType [attribute]

Case location type

This item is restricted to the following list.

Front

Back

Spine

FrontAndBack

FrontAndSpine

BackAndSpine

attribute	
CaseLocationType	
type	caseLocationType

FrontAndBackAndSpine

CaseMaking

Case making

CaseType [attribute]

CaseType is optional. A single instance might exist.

Case type

Refer to CaseType definition for any enumerations.

CaseFlushFoot [attribute]

CaseFlushFoot is optional. A single instance might exist.

Either "Yes" or "No".

Refer to CaseFlushFoot definition for any enumerations.

(sequence)

The sequence of items below is mandatory. A single instance is required.

CaseShow

CaseShow is optional. A single instance might exist.

Case show

CaseOversize

CaseOversize is optional. A single instance might exist.

Case oversize

CaseBoardMaterials

CaseBoardMaterials is optional. Multiple instances might exist.

Case board materials

CaseMaterial

CaseMaterial is optional. Multiple instances might exist.

Case material

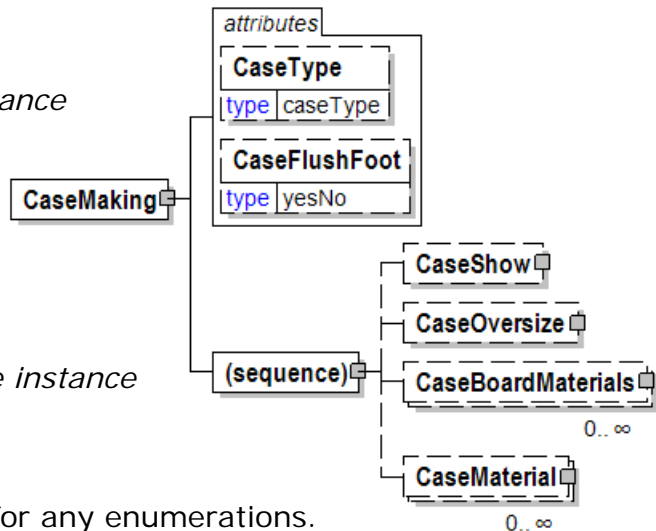

CaseMaterial

Case material

CaseLocationType [attribute]

CaseLocationType is optional. A single instance might exist.

Case location type

Refer to CaseLocationType

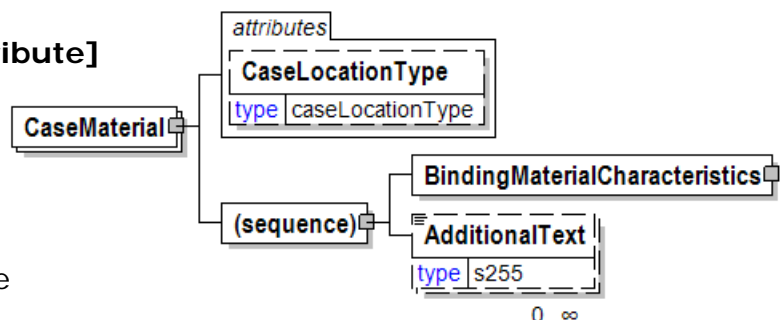

definition for any enumerations.

(sequence)

The sequence of items below is mandatory. A single instance is required.

BindingMaterialCharacteristics

BindingMaterialCharacteristics is mandatory. A single instance is required.

Binding Material Characteristics

AdditionalText

AdditionalText is optional. Multiple instances might exist.

A text field that is used to communicate information not previously defined or for special instructions. To be used only for circumstances not covered by specific elements.

CaseOversize

Case oversize

(sequence)

The sequence of items below is mandatory. A single instance is required.

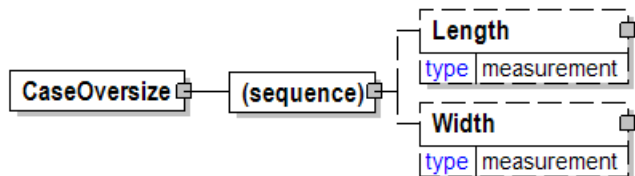

Length

Length is optional. A single instance might exist.

The length of the object.

Width

Width is optional. A single instance might exist.

The width of the object.

CaseShow

Case show

CaseShowType [attribute]

CaseShowType is optional. A single instance might exist.

Case show type

Refer to CaseShowType definition for any enumerations.

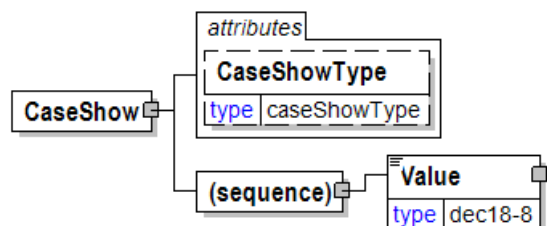

(sequence)

The sequence of items below is mandatory. A single instance is required.

Value

Value is mandatory. A single instance is required.

A numeric value expressed in the unit of measure (UOM).

CaseShowType [attribute]

Case show type

This item is restricted to the following list.

SpineOverSide

SideOverSpine

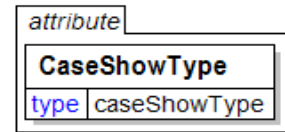

CaseSupers

Case supers

SupersType [attribute]

SupersType is optional. A single instance might exist.

Supers Type

Refer to SupersType definition for any enumerations.

(sequence)

The sequence of items below is mandatory. A single instance is required.

Quantity

Quantity is optional. A single instance might exist.

The Quantity element contains attributes that provide information about the type of quantity that is being communicated, the context in which the particular quantity is to be viewed, and (if the quantity represents an adjustment) an adjustment type.

The Quantity element contains three child elements that enable you to communicate a range of values for the quantity and a target or actual value. It is at this level (Value, RangeMin, and RangeMax) that the unit of measure is specified. This permits the range to be specified in a different unit of measure than the target.

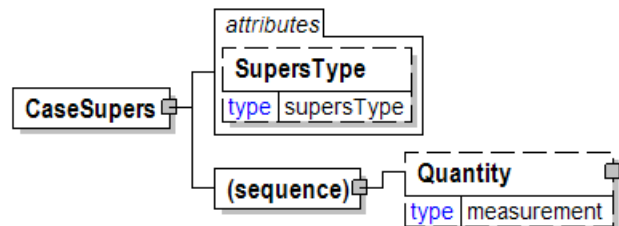

CaseType [attribute]

Case type

This item is restricted to the following list.

OnePiece

TwoPiece

ThreePiece

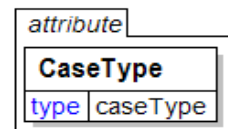

CassetteCardReference

Cassette card reference

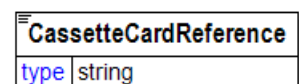

CassetteLabelCharacteristics

Cassette label characteristics

CassetteLabelSide [attribute]

CassetteLabelSide is optional. A single instance might exist.

Cassette label side

Refer to
CassetteLabelSide definition for any
enumerations.

CassetteLabelType [attribute]

CassetteLabelType is optional. A single instance might exist.

Cassette label type

Refer to CassetteLabelType definition for any enumerations.

(sequence)

The sequence of items below is mandatory. A single instance is required.

ColourSpecs

ColourSpecs is optional. A single instance might exist.

Colour specs

PressPrep

PressPrep is optional. Multiple instances might exist.

Press preparation information

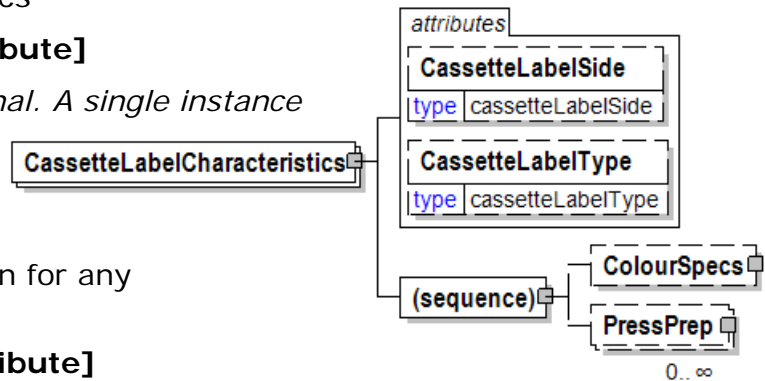

CassetteLabelSide [attribute]

Cassette label side

This item is restricted to the following list.

LabelOneSide

LabelTwoSide

SameLabelBothSide

Face

Spine

FaceAndSpine

None



CassetteLabelType [attribute]

Cassette label type

This item is restricted to the following list.

Braille



- DirectImprint
- PaperLabel
- None
- Other

CD

CD

CDFormatType [attribute]

CDFormatType is optional. A single instance might exist.

CD format type

Refer to CDFormatType definition for any enumerations.

CDManufacturingProcess [attribute]

CDManufacturingProcess is optional. A single instance might exist.

CD manufacturing process.

Any valid string.

CDRType [attribute]

CDRType is optional. A single instance might exist.

Describes the finish to be applied to the CD.

Refer to CDRType definition for any enumerations.

DiscPrinting [attribute]

DiscPrinting is optional. A single instance might exist.

Disc printing

Refer to DiscPrinting definition for any enumerations.

(sequence)

The sequence of items below is mandatory. A single instance is required.

SequenceNumber

SequenceNumber is optional. A single instance might exist.

NumberOfColours

NumberOfColours is optional. A single instance might exist.

The number of colours

ColourSpecs

ColourSpecs is optional. A single instance might exist.

Colour specs

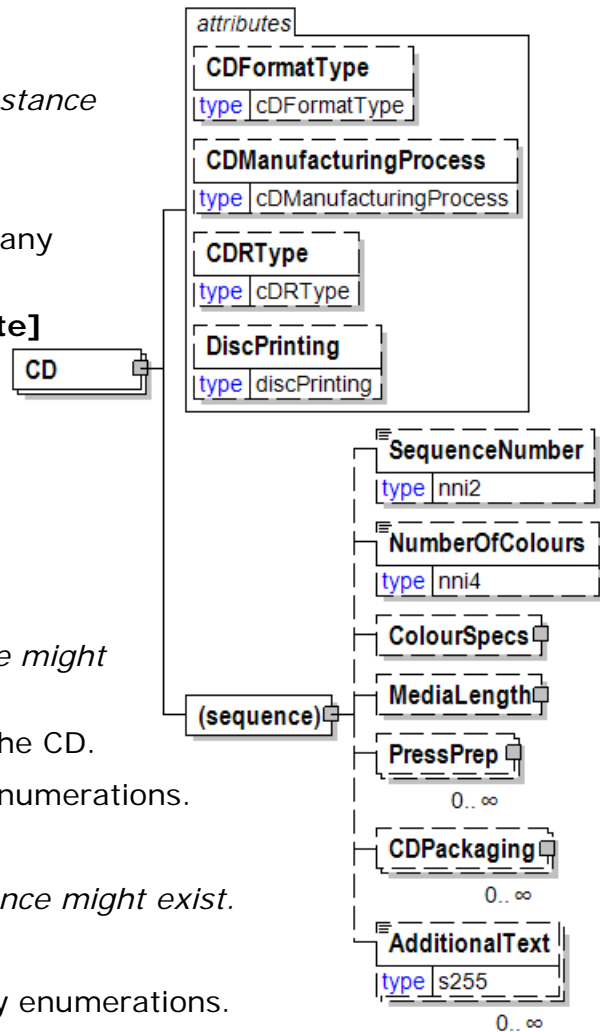

MediaLength

MediaLength is optional. A single instance might exist.

Media length

PressPrep

PressPrep is optional. Multiple instances might exist.

Press preparation information

CDPackaging

CDPackaging is optional. Multiple instances might exist.

CD Packaging

AdditionalText

AdditionalText is optional. Multiple instances might exist.

A text field that is used to communicate information not previously defined or for special instructions. To be used only for circumstances not covered by specific elements.

CDFormatType [attribute]

CD format type

This item is restricted to the following list.

Audio

CDPhoto

CDI

Enhanced

MixedMode

ROM

Video

Other

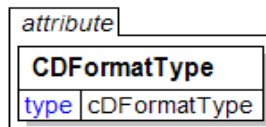

CDManufacturingProcess [attribute]

CD manufacturing process.

Any valid string.

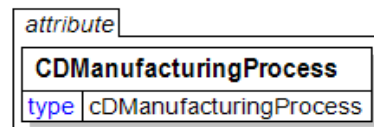

CDPackaging

CD Packaging

(choice)

[choice] is optional because of choice construct.

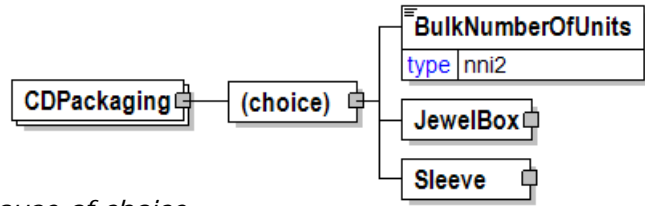

BulkNumberOfUnits

BulkNumberOfUnits is optional because of choice construct.

Bulk number of units

JewelBox

JewelBox is optional because of choice construct.

Jewel box.

Sleeve

Sleeve is optional because of choice construct.

Sleeve.

CDRType [attribute]

Describes the finish to be applied to the CD.

This item is restricted to the following list.

None

CD RCRDBL SLVR

PROMEDIA SLVR

RITEX/TDK SLVR

Other

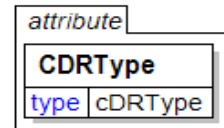

CertificationBody [attribute]

Any valid text string that specifies the entity responsible for certification.

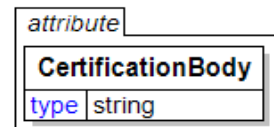

ChainOfCustody

The chain of custody.

CertificationBody [attribute]

CertificationBody is optional. A single instance might exist.

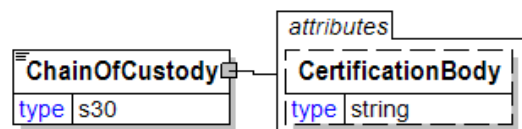

Any valid text string that specifies the entity responsible for certification.

ChangeDetailType [attribute]

Specifies how a package is changed.

This item is restricted to the following list.

Add

The package is added.

Change

The package is changed.

Remove

The package is removed.

ChangeDetailType	
type	changeType
default	Change

Charge

Charge is a group element that contains elements that describe a charge.

ChargeType [attribute]

ChargeType is mandatory. A single instance is required.

The type of charge

Refer to ChargeType definition for any enumerations.

ChargeContext [attribute]

ChargeContext is optional. A single instance might exist.

Describes the relationship of the charge to the associated to the Complaint, generally used for statistical purposes.

Refer to ChargeContext definition for any enumerations.

Agency [attribute]

Agency is optional. A single instance might exist.

Describes the agency maintaining the list of codes. To be included in this list the agency must be a recognized standards body or industry organisation.

For the element that owns this attribute.

For another attribute in the list of attributes associated with the parent element.

Refer to Agency definition for any enumerations.

(sequence)

The sequence of items below is mandatory. A single instance is required.

Quantity

Quantity is optional. A single instance might exist.

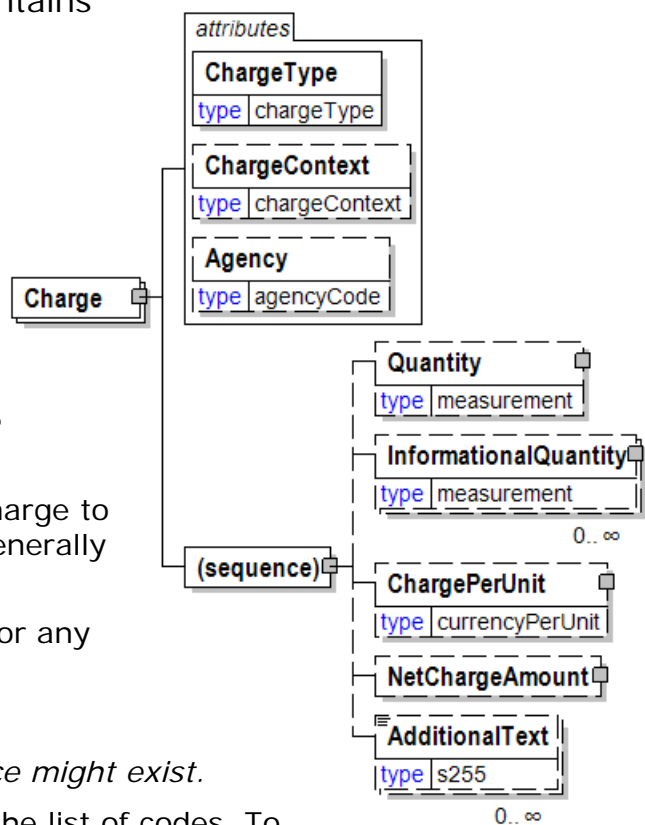

The Quantity element contains attributes that provide information about the type of quantity that is being communicated, the context in which the particular quantity is to be viewed, and (if the quantity represents an adjustment) an adjustment type.

The Quantity element contains three child elements that enable you to communicate a range of values for the quantity and a target or actual value. It is at this level (Value, RangeMin, and RangeMax) that the unit of measure is specified. This permits the range to be specified in a different unit of measure than the target.

InformationalQuantity

InformationalQuantity is optional. Multiple instances might exist.

A quantity given in a valid UOM used for information purposes only (not for calculation). For example, an ordered quantity was 100 reels as opposed to the invoice quantity of 20,000 pounds.

ChargePerUnit

ChargePerUnit is optional. A single instance might exist.

A group item containing a currency value and measurement to communicate a per unit charge.

NetChargeAmount

NetChargeAmount is optional. A single instance might exist.

A field containing the sum of all instances of the Complaint charges.

AdditionalText

AdditionalText is optional. Multiple instances might exist.

A text field that is used to communicate information not previously defined or for special instructions. To be used only for circumstances not covered by specific elements.

ChargeAmount

A field containing the total amount of every ChargeInformation including tax.

(sequence)

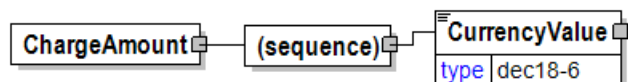

The sequence of items below is mandatory. A single instance is required.

CurrencyValue

CurrencyValue is mandatory. A single instance is required.

The amount in the referenced currency as defined by the CurrencyType attribute.

ChargeContext [attribute]

Describes the relationship of the charge to the associated to the Complaint, generally used for statistical purposes.

This item is restricted to the following list.

Administrative

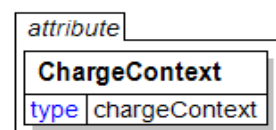

- Logistical
- Production
- Rework
- Storage
- Waste
- Other

ChargeInformation

A group element that contains elements that describe a charge.

(sequence)

The sequence of items below is mandatory. A single instance is required.

DocumentReferenceInformation

DocumentReferenceInformation is optional. A single instance might exist.

A group item containing reference information applicable to a document.



CostComponent

CostComponent is mandatory. A single instance is required.

A group item that contains information relevant to the freight cost codes.

PriceDetails

PriceDetails is mandatory. A single instance is required.

An element that groups together price information.

MonetaryAdjustment

MonetaryAdjustment is optional. Multiple instances might exist.

The element containing the information necessary for the understanding, calculation, and treatment of an adjustment to a currency amount. MonetaryAdjustment contains an attribute that indicates they type of adjustment being communicated.

QuantityInformation

QuantityInformation is mandatory. A single instance is required.

A group item containing information about quantity and informational quantity of similar items.

TransportUnitCharacteristics

TransportUnitCharacteristics is optional. Multiple instances might exist.

A group item defining and identifying the primary means of containing the goods. In some instances, the transport unit and vehicle are the same.

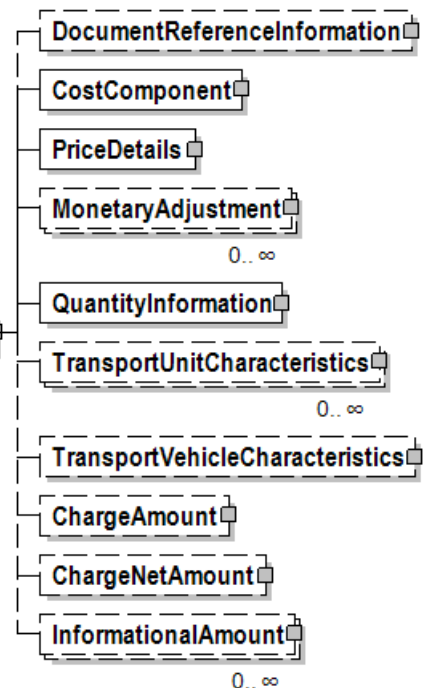

TransportVehicleCharacteristics

TransportVehicleCharacteristics is optional. A single instance might exist.

A group item defining the primary means of transporting the goods, such as a side port vessel. In some instances, the transport unit and vehicle are the same.

ChargeAmount

ChargeAmount is optional. A single instance might exist.

A field containing the total amount of every ChargeInformation including tax.

ChargeNetAmount

ChargeNetAmount is optional. A single instance might exist.

A field containing the total amount of every ChargeInformation excluding tax.

InformationalAmount

InformationalAmount is optional. Multiple instances might exist.

A monetary amount used for information purposes only (not for calculation). For example, the invoice price adjustment subtotal is expressed in sterling pounds, and the buyer wants this information expressed in U.S. dollars.

CreditDebitNote and Invoice - The TaxAmount is displayed in the currency that is applicable throughout the e-Document. When a TaxAmount needs to be displayed in a different national currency, this field is used.

ChargeNetAmount

A field containing the total amount of every ChargeInformation excluding tax.

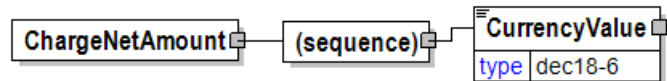

(sequence)

The sequence of items below is mandatory. A single instance is required.

CurrencyValue

CurrencyValue is mandatory. A single instance is required.

The amount in the referenced currency as defined by the CurrencyType attribute.

ChargeOrAllowance

The description of the charge or allowance; such as freight, special handling, and stop-off handling.

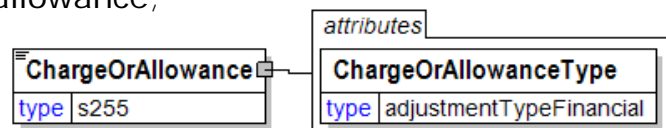

ChargeOrAllowanceType [attribute]

ChargeOrAllowanceType is mandatory. A single instance is required.

Defines what type of charge or allowance defines the invoice product.

Refer to ChargeOrAllowanceType definition for any enumerations.

ChargeOrAllowanceType [attribute]

Defines what type of charge or allowance defines the invoice product.

attribute
ChargeOrAllowanceType
type adjustmentTypeFinancial

This item is restricted to the following list.

BillOfLadingCharge

An extra charge for creating a Bill of Lading.

CancellationCharge

A charge applied because a cancellation was late (after the last date of change) and all or part of the ordered product has already been made.

CashDiscount

A reduction due to a discount applied.

CertificateCharge

An extra charge for creating a certificate. Some countries requires Certificates in which different characteristics of the delivery, transport unit, route, product, and others must be proved.

There are certificates for gasen pallets, for the place of production, for the age of the ship/vessel, for not departing from one country's harbour when delivering to another.

ChargesForward

A pending Invoice amount brought forward from a previous Invoice.

ClaimAdjustment

An adjustment related to a filed complaint.

Commission

Commission costs paid to the trading agency or trader.

CompetitiveAllowance

An allowance provided for competitive reasons.

CongestionCharge

An extra fee from ports for waiting time of ships in ports, railcars on a siding, trucks at a dock. (Synonym: Demurrage.)

ConsigneeUnloadCharge

An unloading charge that is the responsibility of the consignee.

ContractAllowance

An allowance for a volume discount, usually because the agreed amount has been exceeded.

CurrencyAdjustmentCharge

An extra fee to adjust for currency variations.

DecimalRounding

Adjustments for rounding of amounts to fit the business agreement or national monetary legislation. This adjustment is typically used for decimal rounding of amounts not including tax.

N.B. Use InformationalAmount with AmountType "DecimalRounding" for specification of decimal rounding of amounts including tax.

DefectiveAllowance

An allowance provided for defective material.

DeliveryCharge

The charge for delivering the product.

DeliveryNonConformanceAllowance

An allowance due to non-conformance with the purchase agreement regarding a delivery.

DeliveryTimeBonus

A bonus given for deliveries of products within a certain time period.

EarlyShipAllowance

An allowance due to a delivery that took place earlier than planned. The seller may be charged a penalty. If this is found before issuing the Invoice, it can be handled through this allowance. If found later, it will be handled through a credit note.

EnergySurcharge

A charge related to increases in the cost of energy.

Environmental

An allowance applied due to environmental regulations.

ExpeditedShipmentCharge

An extra cost charged due to unexpected or emergency requirements (for example, breaking off a run in the mill to reach the production date for a rush order).

ExportClearanceCharge

An extra fee for customs administration.

FlatRateCharge

A general flat charge.

FreightAllowance

The freight cost allowed by the mill. This amount is negative, and will be deducted from the Invoice (U.S. business practice, in the European Union (EU), use only Freight Charge).

FreightCharge

The actual cost incurred to deliver the product. This amount is positive, and will be added to the Invoice.

FuelAdjustmentCharge

An extra fee, usually from shipping companies, to adjust fuel prices.

HandlingCharge

A charge related to the handling of the product.

Inspection

The cost associated with performing an inspection of the product.

InterestCharge

A charge applied for interest on overdue payments.

LabourAllowance

An allowance due to additional labour required in the use or acceptance of the product.

LabourCharge

A charge due to additional labour required in the use or acceptance of the product.

LoggingDamage

An adjustment caused by logging damages on Forest Wood products. Logging damages normally cause a reduction of the product price.

LotCharge

A charge applied to the lot of material.

MetalDetection

A charge for additional metal detection applied to the goods.

ModelHomeDiscount

A discount associated with the building of the model home.

NewStoreCouponDiscount

A discount associated with entry into a new store.

OrderQuantity

A charge or allowance for small/big ordered quantities.

PalletCharge

A charge that represents the cost or rental of the pallet.

PickUpAllowance

An allowance provided to compensate for the cost of picking up the product.

PromotionalAllowance

An allowance provided for the promotion of the product.

PromotionalCharge

A charge associated with the promotion of the product.

PriceCorrection

An adjustment associated with a correction of the product's price.

ProductionSetUpCharge

A special charge applied due to specific buyer requests.

Provision

The act of making ready or equipping for use.

Rebate

A rebate accepted by the buyer and seller based on the agreed price and

volume.

ReelDiscount

An allowance for purchasing reels instead of sheets.

ReturnedLoadAllowance

An allowance applied due to the return of the load.

ReturnLoadCharge

A charge applied due to the return of the load.

RoadFeeCharge

A freight charge for a special tax applied to road transports in some countries, e.g. Germany

ScrapAndDunnageCharge

A charge that represents the scrapping of the material and its removal.

ServiceCharge

A charge associated with a miscellaneous service.

SpecialConversionCharge

Additional charge for a special conversion of the product.

SpecialDeliveryCharge

A special charge for delivering the product differently from the usual or agreed-to method.

SpecialHandlingCharge

A special charge for handling the product differently from the usual or agreed-to method.

SpecialPackagingCharge

A special charge for packaging the product differently from the usual or agreed-to method, or if packaging as requested is out of spec.

StopOffAllowance

An allowance for a delivery stop-off.

StopOffCharge

A charge for a delivery stop-off.

StorageAllowance

An allowance for storing the product.

StorageCharge

An extra cost charged for storing the product on location (in the plant).

Tax

An adjustment that reflects a tax item.

TestingCharge

A charge related to testing a paper grade.

TradeDiscount

A discount based on the terms of the trade given on the agreed price. Usually a percentage.

TrialDiscount

A discount applied for a trial run of a new or improved product.

TransferCharge

A freight charge incurred by the goods transfer from one location to another location not previously agreed upon.

UnloadingAllowance

An allowance to compensate for the unloading the product.

UnloadingCharge

A charge for the unloading the product.

VolumeDiscount

A rebate accepted by the buyer and the seller based on the agreed volume

WarRiskCharge

An extra fee from transport companies for transport units that cross war zones.

Other

Any other adjustment not covered by the attribute list.

ChargePerUnit

A group item containing a currency value and measurement to communicate a per unit charge.

(sequence)

The sequence of items below is mandatory. A single instance is required.

CurrencyValue

CurrencyValue is mandatory. A single instance is required.

The amount in the referenced currency as defined by the CurrencyType attribute.

Value

Value is mandatory. A single instance is required.

A numeric value expressed in the unit of measure (UOM).

RangeMin

RangeMin is optional. A single instance might exist.

The minimum value (lower boundary) allowed for the Measurement that is the parent of this element.

RangeMax

RangeMax is optional. A single instance might exist.

The maximum value (upper boundary) allowed for the Measurement that is the

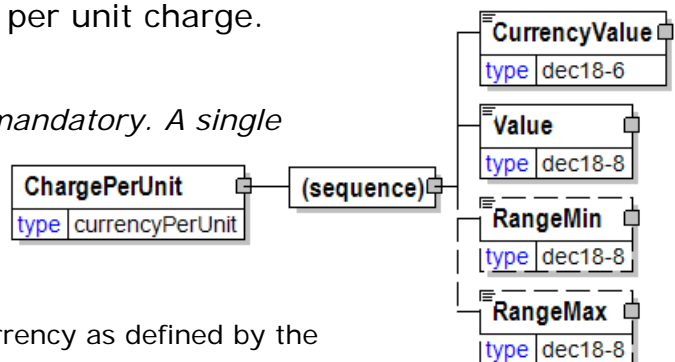

parent of this element. Some elements use the RangeMax element with an extended list of unit of measures. (Note: the red colour in the picture is an artifact of how the graphic was captured and should be disregarded.)

ChargeType [attribute]

The type of charge

This item is restricted to the following list.

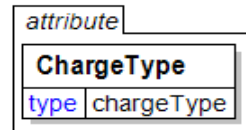

AdministrativeCosts

The administrative costs involved as a result of the complaint, for instance, to sell or scrap the waste.

AgreedWasteToScrap

The agreed to quantity or amount of paper the complainer declares to scrap.

AgreedWasteToSell

The agreed to quantity or amount of paper the complainer declares to sell.

ConversionCosts

Costs associated with product conversion (i.e. slitting, rewrapping, etc).

KnownProductionDowntime

Production down time associated with KnownBreaks.

LabourCosts

The labour costs involved as a result of the complaint, for instance reels that need to be cleaned because of edge cuttings.

MachineDamage

The damage suffered by the machine as a result of poor quality paper supplied.

PriceDifference

A difference in the price.

ProductionDowntime

Production downtime associated with the result of poor quality paper or a service problem.

RejectedReel

The reel(s) rejected because not workable by the converter/printer.

UnknownProductionDowntime

Production downtime associated with Breaks.

WasteToScrap

The proposed quantity or amount of paper the complainer declares to scrap.

WasteToSell

The proposed quantity or amount of paper the complainer declares to sell.

WrongQuantity

The wrong quantity was reported.

Other

Used to communicate a ChargeType that is not available in the enumerated list.

ChildrensTitle [attribute]

Specifies if the book product is designated for use by children 12 and under or not.

This item is restricted to the following list.

attribute	
ChildrensTitle	
type	childrensTitleType

NotChildrensTitle

Not a children's product; no testing required for lead or phthalates.

ChildrensWithPlayValue

Designated as a children's product and has "play value" outside of reading and writing; requires testing for lead and phthalates. (Examples of "play value" include paper doll books, sticker books, board books and bathtub books).

ChildrensWithoutPlayValue

Designated as a children's product but does not have any "play value" outside of reading and writing; requires testing for lead but not phthalates.

Chip

Chip information.

(sequence)

The sequence of items below is mandatory. A single instance is required.

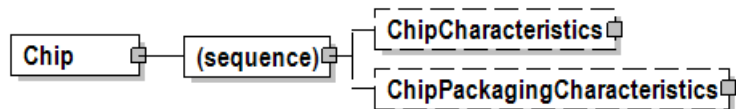

ChipCharacteristics

ChipCharacteristics is optional. A single instance might exist.

Chip characteristics

ChipPackagingCharacteristics

ChipPackagingCharacteristics is optional. A single instance might exist.

ChipPackagingCharacteristics provides information about the containerisation of the wood chips.

ChipCharacteristics

Chip characteristics

Screened [attribute]

Screened is optional. A single instance might exist.

Either "Yes" or "No".

Refer to Screened definition for any enumerations.

Debarked [attribute]

Debarked is optional. A single instance might exist.

Either "Yes" or "No".

Refer to Debarked definition for any enumerations.

(sequence)

The sequence of items below is mandatory. A single instance is required.

Thickness

Thickness is optional. A single instance might exist.

Physical dimension of a product.

Moisture

Moisture is optional. A single instance might exist.

Desired percentage, or other indicator, of water in the product at the time of shipment.

Dirt

Dirt is optional. A single instance might exist.

A group item used to communicate dirt content target or test value according to a particular TestMethod.

Bark

Bark is optional. A single instance might exist.

Used to report bark content in chips as a detail measurement.

Sawdust

Sawdust is optional. A single instance might exist.

Used to report sawdust content in chips as a detail measurement.

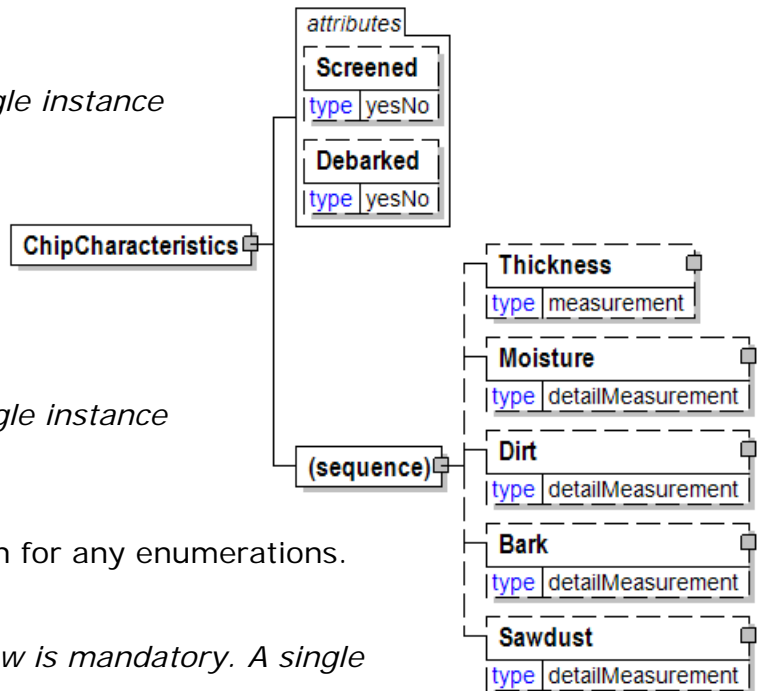

ChipFraction

A grouping element that contains information about one fraction from an analysis of chip fractions.

ChipFractionPropertyType [attribute]

ChipFractionPropertyType is mandatory. A single instance is required.

Defines the type of property for analysis of chip fractions.

Refer to ChipFractionPropertyType definition for any enumerations.

(sequence)

The sequence of items below is mandatory. A single instance is required.

ChipFractionNumber

ChipFractionNumber is mandatory. A single instance is required.

The date when the analysis of chip fractions was done.

ChipFractionDescription

ChipFractionDescription is optional. Multiple instances might exist.

The date when the analysis of chip fractions was done.

ChipFractionClass

ChipFractionClass is optional. A single instance might exist.

The date when the analysis of chip fractions was done.

ChipFractionValue

ChipFractionValue is mandatory. A single instance is required.

A grouping element for a chip fraction value and its statistical measures.

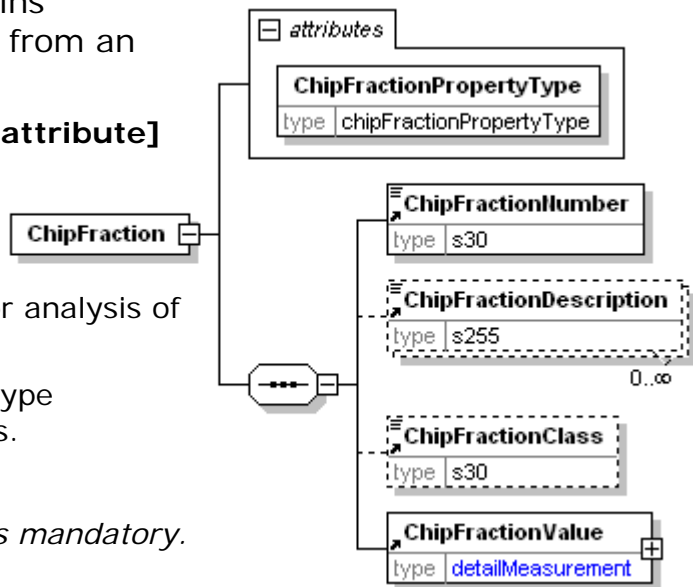

ChipFractionAnalysisDate

The date when the analysis of chip fractions was done.

(sequence)

The sequence of items below is mandatory. A single instance is required.

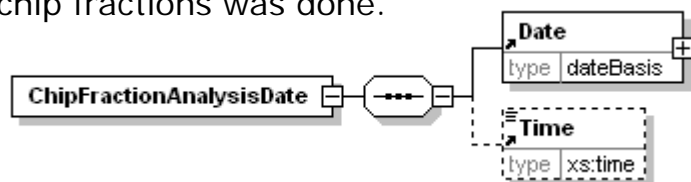

Date

Date is mandatory. A single instance is required.

A group element that contains the specification of Year, Month, and Day.

Time

Time is optional. A single instance might exist.

Times are treated in a standard XML fashion with a special case used to indicate a generalized "local" time. The standard XML approach to time is hh:mm:ss,

papiNet V2R31

hh:mm:ssZ, or hh:mm:ss±hh:mm.

- hh:mm:ss±hh:mm is used to represent a time with a time zone. The time zone is communicated as the number of hours offset from the Universal Time Coordinate (UTC), a.k.a. Greenwich Mean Time.
- hh:mm:ssZ indicates the time at Zulu (another name for UTC). Based on the convention described in the next bullet it will be important for users within UTC to use "Z" when communicating a time in their time zone to other users.
- hh:mm:ss or hh:mm indicates in the XML standard the time at UTC however, within papiNet it is used to represent the applicable local time. Caution should be used when processing times of this nature as the papiNet approach may be in discord with other users of XML.

ChipFractionClass

Specifies the class of the chip fraction.

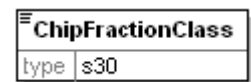

ChipFractionDescription

A free form description of the chip fraction.

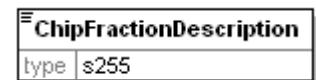

ChipFractionInfo

Grouping element that contains information about analysis of chip fractions.

TestMethod [attribute]

TestMethod is optional. A single instance might exist.

The method used to determine the results of the test under consideration.

TestAgency [attribute]

TestAgency is optional. A single instance might exist.

The agency that has set the parameters for the testing

Refer to TestAgency definition for any enumerations.

SampleType [attribute]

SampleType is optional. A single instance might exist.

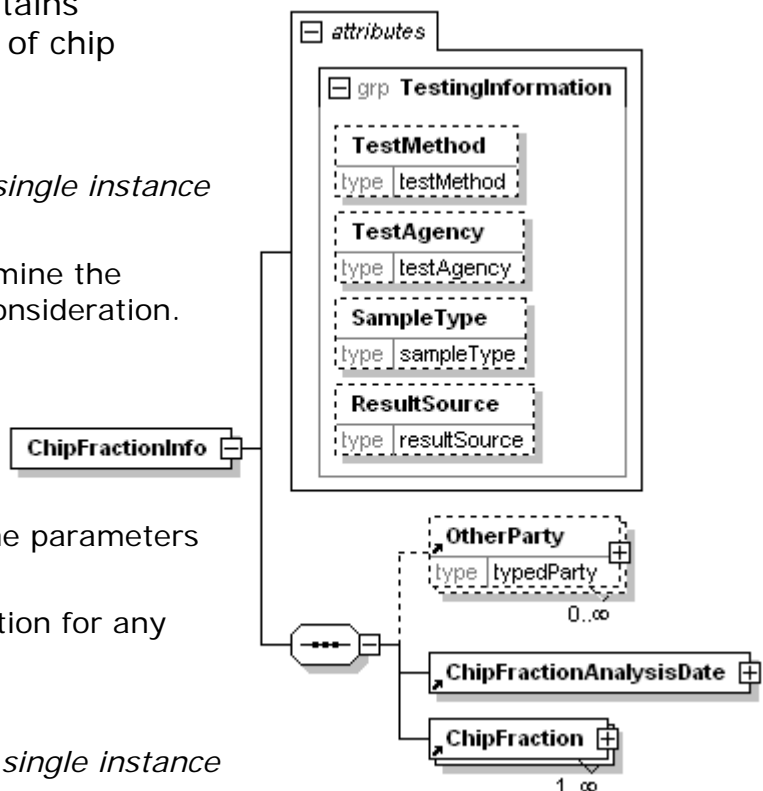

Communicates how sampling was done to measure the product characteristics.

Refer to SampleType definition for any enumerations.

ResultSource [attribute]

ResultSource is optional. A single instance might exist.

Used to define the data source of the specified test

Refer to ResultSource definition for any enumerations.

(sequence)

The sequence of items below is mandatory. A single instance is required.

OtherParty

OtherParty is optional. Multiple instances might exist.

An organisation or business entity other than those specifically detailed within a e-Document

ChipFractionAnalysisDate

ChipFractionAnalysisDate is mandatory. A single instance is required.

The date when the analysis of chip fractions was done.

ChipFraction

ChipFraction is mandatory. Multiple instances might exist.

The date when the analysis of chip fractions was done.

ChipFractionNumber

The identifier of a chip fraction.

ChipFractionNumber	
type	s30

ChipFractionPropertyType [attribute]

Defines the type of property for analysis of chip fractions.

This item is restricted to the following list.

ChipFractionPropertyType	
type	chipFractionPropertyType

Length

Length of the chip fraction.

Size

Size of the chip fraction.

Thickness

Thickness of the chip fraction.

Width

Width of the chip fraction.

ChipFractionValue

A grouping element for a chip fraction value and its statistical measures.

(sequence)

The sequence of items below is mandatory. A single instance is required.

DetailValue

DetailValue is mandatory. A single instance is required.

A numeric value expressed in the unit of measure (UOM).

DetailRangeMin

DetailRangeMin is optional. A single instance might exist.

The minimum value (lower boundary) allowed for the DetailValue that is the parent of this element.

DetailRangeMax

DetailRangeMax is optional. A single instance might exist.

The maximum value (upper boundary) allowed for the DetailValue that is the parent of this element.

StandardDeviation

StandardDeviation is optional. A single instance might exist.

A statistic used as a measure of dispersion in a distribution.

SampleSize

SampleSize is optional. A single instance might exist.

The number of samples used to determine the product characteristic in question.

TwoSigmaLower

TwoSigmaLower is optional. A single instance might exist.

Two sigma (a measure of dispersion associated with standard deviation) on the lower side of the standard deviation.

TwoSigmaUpper

TwoSigmaUpper is optional. A single instance might exist.

Two sigma (a measure of dispersion associated with standard deviation) on the upper side of the standard deviation.

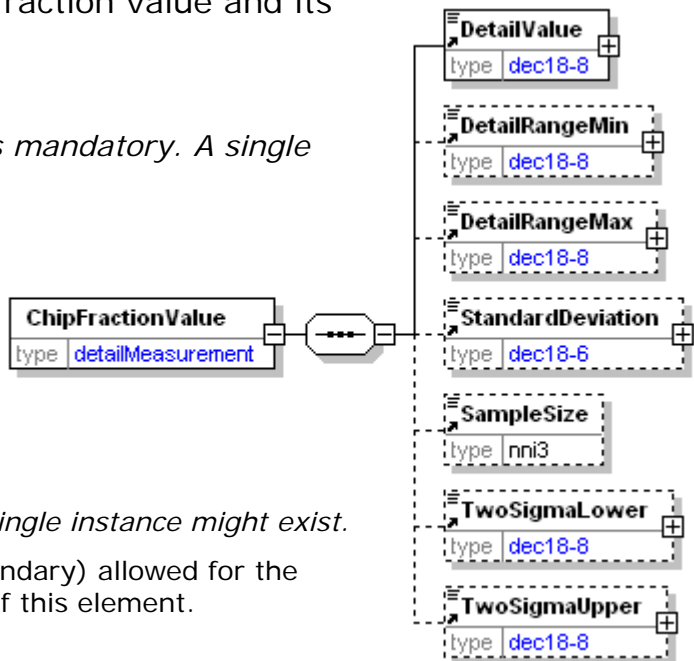

ChipPackagingCharacteristics

ChipPackagingCharacteristics provides information about the containerisation of the wood chips.

(sequence)

The sequence of items below is mandatory. A single instance is required.

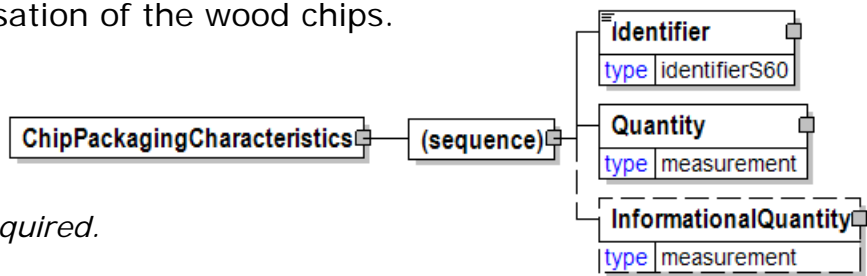

Identifier

Identifier is mandatory. A single instance is required.

An Identifier is required for packages and items (pallets, reel packages, boxes, ream items, reel items, etc). The Identifier element contains the actual item identifier code. Identifier is repeatable so more than one identifier can be communicated. For example, the printed identifier on a label may be different from the barcode printed on the label.

Quantity

Quantity is mandatory. A single instance is required.

The Quantity element contains attributes that provide information about the type of quantity that is being communicated, the context in which the particular quantity is to be viewed, and (if the quantity represents an adjustment) an adjustment type.

The Quantity element contains three child elements that enable you to communicate a range of values for the quantity and a target or actual value. It is at this level (Value, RangeMin, and RangeMax) that the unit of measure is specified. This permits the range to be specified in a different unit of measure than the target.

InformationalQuantity

InformationalQuantity is optional. A single instance might exist.

A quantity given in a valid UOM used for information purposes only (not for calculation). For example, an ordered quantity was 100 reels as opposed to the invoice quantity of 20,000 pounds.

City

Name of the city associated with the address elements.

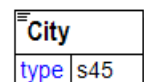

Class Identifier

Standard used for product identification.

IdentifierCodeType [attribute]

IdentifierCodeType is mandatory. A single instance is required.

Defines the type of product identifier used (for example, reel number, ream number, bar code). This code type specifies how to decode the identifier value.

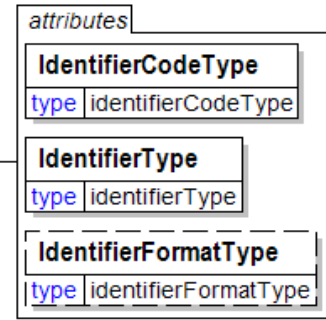
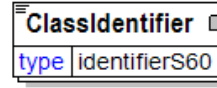

Refer to IdentifierCodeType definition for any enumerations.

IdentifierType [attribute]

IdentifierType is mandatory. A single instance is required.

This attribute specifies whether the Identifier is the primary way to identify the product or a secondary way. Only one of the given identifiers can be primary. In addition, this attribute also specifies the physical support used to code the identifier (for example, a Radio Frequency (RF) Tag).

Refer to IdentifierType definition for any enumerations.

IdentifierFormatType [attribute]

IdentifierFormatType is optional. A single instance might exist.

IdentifierFormatType defines the technical format used to make an IdentifierCodeType readable by technical devices or humans. The IdentifierCodeType specifies how to decode the identifier value

Refer to IdentifierFormatType definition for any enumerations.

Classification

A group item that details the product classification according to a particular organization's scheme.

An item across multiple classifications would still be recognized as the same item. Examples of some product classifications are: Containerboard, Pulp-Dissolving, or Newsprint.

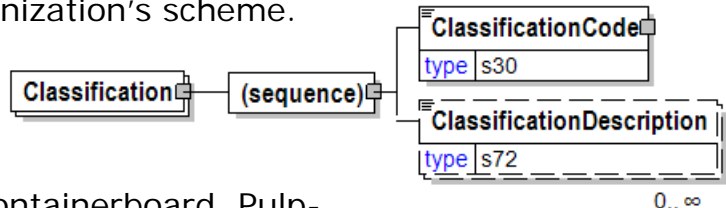

(sequence)

The sequence of items below is mandatory. A single instance is required.

ClassificationCode

ClassificationCode is mandatory. A single instance is required.

A code assigned by the indicated Agency for this particular class of product.

ClassificationDescription

ClassificationDescription is optional. Multiple instances might exist.

A free form description of the classification.

ClassificationCode

A code assigned by the indicated Agency for this particular class of product.

Agency [attribute]

Agency is mandatory. A single instance is required.

Describes the agency maintaining the list of codes. To be included in this list the agency must be a recognized standards body or industry organisation.

For the element that owns this attribute.

For another attribute in the list of attributes associated with the parent element.

Refer to Agency definition for any enumerations.

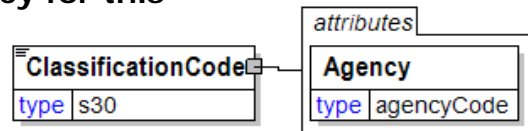

ClassificationDescription

A free form description of the classification.

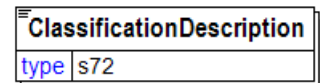

ClothCrossCut [attribute]

Either "Yes" or "No".

This item is restricted to the following list.

Yes

No

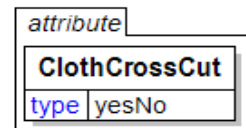

CMYK

A definition of colour using the CMYK protocol.

TestMethod [attribute]

TestMethod is optional. A single instance might exist.

The method used to determine the results of the test under consideration.

TestAgency [attribute]

TestAgency is optional. A single instance might exist.

The agency that has set the parameters for the testing

Refer to TestAgency definition for any enumerations.

SampleType [attribute]

SampleType is optional. A single instance might exist.

Communicates how sampling was done to measure the product characteristics.

Refer to SampleType definition for any enumerations.

ResultSource [attribute]

ResultSource is optional. A single instance might exist.

Used to define the data source of the specified test

Refer to ResultSource definition for any enumerations.

(sequence)

The sequence of items below is mandatory. A single instance is required.

Cyan

Cyan is mandatory. A single instance is required.

The Cyan component of a colour in the CMYK approach to colour definition.

Magenta

Magenta is mandatory. A single instance is required.

The Magenta component of a colour.

Magenta is a locally defined element used in the CMYK element.

Yellow

Yellow is mandatory. A single instance is required.

The Yellow component of a colour.

Black

Black is mandatory. A single instance is required.

The Black component of a colour.

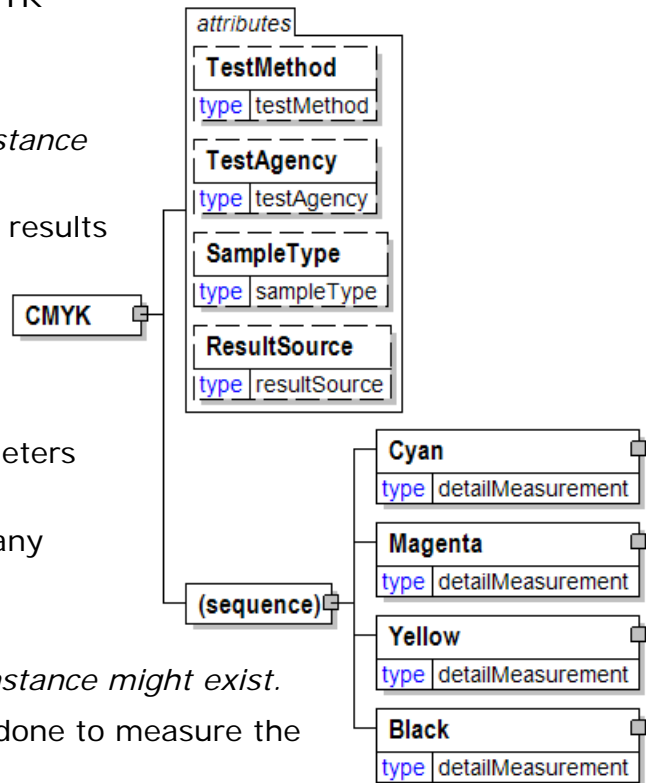

Coating

Coating

This item is restricted to the following list.

AnimalGlueableStampableFilm

Aqueous

Aqueous coating is a water-based sealant.

Diamond

Hard carbon coating.

DiamondUV

Film

A thin sheet of material, usually plastic and transparent.

GlossUltracure

GlossUV

Gritty

GrittyMatteUV

Lacquer

Clear or coloured varnish that dries by solvent evaporation and often a curing process as well that produces a hard, durable finish, in any sheen level from ultra matte to high gloss and that can be further polished as required.

Laminate

MatteUV

MylarFilm

A thin polyester film.

MylarFilmGloss

MylarFilmMatte

MylarFilmSilver

NoFinish

Non-Standard

PHOENIXPremier

PolyesterFilm

Made of synthetic resins which are light and strong and weather resistant.

PolyesterGloss

PolyesterMatte

PolypropyleneFilm

PolypropyleneFilmGloss

PolypropyleneFilmMatte

Press

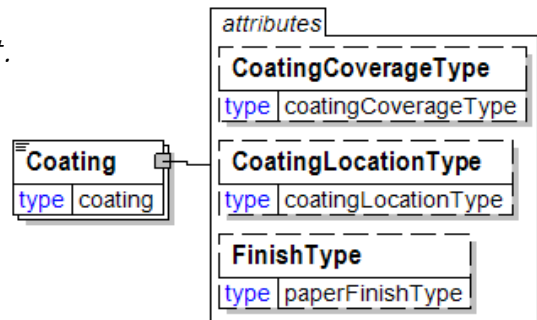

Applied by a unit of the press.

PressVarnish

PressVarnishDull

PressUV

SatinFilm

Silkscreen

A print made by forcing ink through a fine (silk) mesh.

SilkscreenGloss

SilkscreenUV

StayFlat

Contains materials to prohibit the sheet from curling.

StayFlatFilmGloss

StayFlatFilmMatte

Tint

Screening or adding white to a solid color for results of lightening that specific color.

TintVarnish

Ultracure

Ultraviolet

Ultra-violet coating is a highly reactive, cross-linking system in which the vehicle is dried by exposure to UV radiation.

Varnish

Petroleum-based sealant applied by a standard inking unit in the press.

CoatingCoverageType [attribute]

CoatingCoverageType is optional. A single instance might exist.

Communicates the degree of coating coverage.

Refer to CoatingCoverageType definition for any enumerations.

CoatingLocationType [attribute]

CoatingLocationType is optional. A single instance might exist.

Specifies which side of the product the coating should be applied.

Refer to CoatingLocationType definition for any enumerations.

FinishType [attribute]

FinishType is optional. A single instance might exist.

Defines the finish of a sheet of paper, which means the condition of its surface (refer to Embossing for more information).

Finishes may be produced on or off machine. Finishes that are created off-machine are called embossed. (Embossing is a child element of ReelConversionCharacteristics and SheetConversionCharacteristics.)

Note:

Embossed" as a finish type is just a generalized choice for one of the more specific choices listed.

Unsupercalendered" as a finish type would be indicated by not communicating a finish type.

Refer to FinishType definition for any enumerations.

CoatingBottom [attribute]

Used to specify the type of coating applied to the top or bottom of the paper sheet

This item is restricted to the following list.

Acrylic

Flexolyn

FoilCoated

GreaseBarrier

Metallic

MetalizedPolyester

MoistureBarrier

MoldInhibitor

None

OilBarrier

OxygenBarrier

Plastic

PolyCoating

Polyethylene

Pyroxylin

Silicone

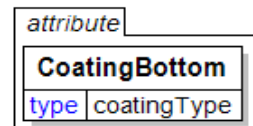

CoatingCoverageType [attribute]

Communicates the degree of coating coverage.

This item is restricted to the following list.

FullCoverage

The entire item is coated.

SpotCoverage

The item is partially coated.



CoatingLocation [attribute]

Coating location

This item is restricted to the following list.

attribute
CoatingLocation
type coatingLocation

Back

Top ply of a multi-part business form. Its upper surface is not coated. Its lower surface has a coating of microscopic capsules containing colourless dye. When pressure or impact fractures the capsules, the dye is released to react with the sheet of carbonless paper below it having a coated front top surface. The image is formed on the coated front surface.

Front

The coated front sheet is used as the bottom ply of a multi-part form. The coated front sheet can receive the image from the coated back surface of the sheet above it, but it does not transmit the image nor is there a sheet below it in the form.

FrontAndBack

The coated front and back sheet is used for all plies of a carbonless form between the top and bottom plies. The under-surface of each coated front and back sheet is coated with dye capsules (coated back coating). The upper surface (coated front) reacts with the colourless dye released from fractured capsules to produce the image.

SelfContained

Carbonless paper containing both the coated back dye capsules and the coated front receptor coating on the upper surface of the same sheet, Self-contained carbonless paper can be used to create a carbonless copy when used as a second ply below almost any kind of paper.

CoatingLocationType [attribute]

Specifies which side of the product the coating should be applied.

This item is restricted to the following list.

attribute
CoatingLocationType
type coatingLocationType

Top

Top side of a printed component

Bottom

Bottom side of a printed component

TopAndBottom

Front

Front side of a book

Back

Back of a book

FrontAndBack

Spine

papiNet V2R31

Spine of a book which is where the pages are glued or sewn together

FrontAndSpine

BackAndSpine

FrontAndBackAndSpine

CoatingTop [attribute]

Used to specify the type of coating applied to the top or bottom of the paper sheet

This item is restricted to the following list.

attribute	
CoatingTop	
type	coatingType

Acrylic

Flexolyn

FoilCoated

GreaseBarrier

Metallic

MetalizedPolyester

MoistureBarrier

MoldInhibitor

None

OilBarrier

OxygenBarrier

Plastic

PolyCoating

Polyethylene

Pyroxylin

Silicone

CoatWeight

A group item used to communicate the coating thickness target or test value according to a particular TestMethod.

TestMethod [attribute]

TestMethod is optional. A single instance might exist.

The method used to determine the results of the test under consideration.

TestAgency [attribute]

TestAgency is optional. A single instance might exist.

The agency that has set the parameters for the testing

Refer to TestAgency definition for any enumerations.

SampleType [attribute]

SampleType is optional. A single instance might exist.

Communicates how sampling was done to measure the product characteristics.

Refer to SampleType definition for any enumerations.

ResultSource [attribute]

ResultSource is optional. A single instance might exist.

Used to define the data source of the specified test

Refer to ResultSource definition for any enumerations.

(sequence)

The sequence of items below is mandatory. A single instance is required.

DetailValue

DetailValue is mandatory. A single instance is required.

A numeric value expressed in the unit of measure (UOM).

DetailRangeMin

DetailRangeMin is optional. A single instance might exist.

The minimum value (lower boundary) allowed for the DetailValue that is the parent of this element.

DetailRangeMax

DetailRangeMax is optional. A single instance might exist.

The maximum value (upper boundary) allowed for the DetailValue that is the parent of this element.

StandardDeviation

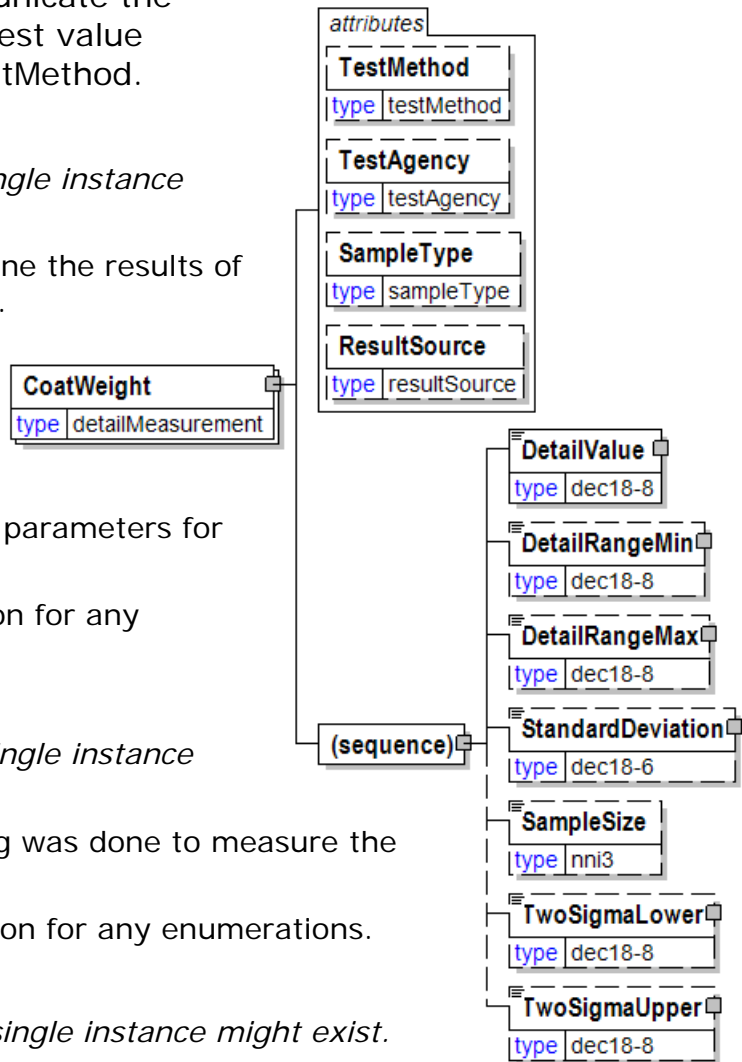

papiNet V2R31

StandardDeviation is optional. A single instance might exist.

A statistic used as a measure of dispersion in a distribution.

SampleSize

SampleSize is optional. A single instance might exist.

The number of samples used to determine the product characteristic in question.

TwoSigmaLower

TwoSigmaLower is optional. A single instance might exist.

Two sigma (a measure of dispersion associated with standard deviation) on the lower side of the standard deviation.

TwoSigmaUpper

TwoSigmaUpper is optional. A single instance might exist.

Two sigma (a measure of dispersion associated with standard deviation) on the upper side of the standard deviation.

Collated [attribute]

Either "Yes" or "No".

This item is restricted to the following list.

Yes

No

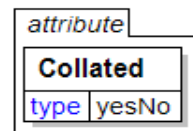

CoLoading

A group item specifying information about items to be loaded or loaded on the same transport unit.

Used to identify:

Delivery together to the drop point

Transport Orders stuffed together in a container

Transport Orders not splittable

CoLoadingType [attribute]

CoLoadingType is mandatory. A single instance is required.

Provides the Co-Loading type which can control and confirm co-loading.

Refer to CoLoadingType definition for any enumerations.

(sequence)

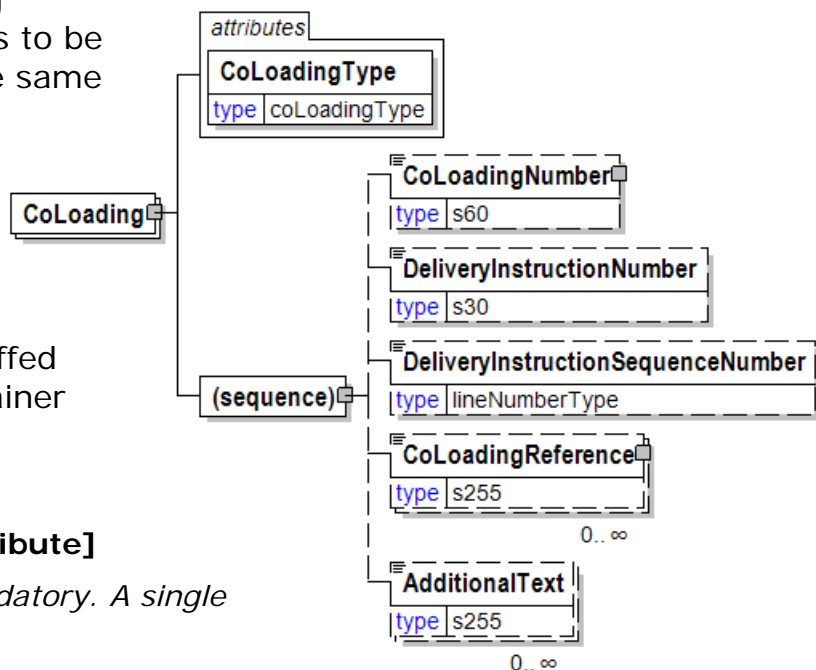

papiNet V2R31

The sequence of items below is mandatory. A single instance is required.

CoLoadingNumber

CoLoadingNumber is optional. A single instance might exist.

The identifier for the CoLoading communication.

DeliveryInstructionNumber

DeliveryInstructionNumber is optional. A single instance might exist.

The unique identifier for the DeliveryInstruction.

DeliveryInstructionSequenceNumber

DeliveryInstructionSequenceNumber is optional. A single instance might exist.

A sequential number that uniquely identifies the Sequence of a DeliveryInstruction.

CoLoadingReference

CoLoadingReference is optional. Multiple instances might exist.

An element item detailing relevant references pertaining to the coloading process.

AdditionalText

AdditionalText is optional. Multiple instances might exist.

A text field that is used to communicate information not previously defined or for special instructions. To be used only for circumstances not covered by specific elements.

CoLoadingNumber

The identifier for the CoLoading communication.

AssignedBy [attribute]

AssignedBy is mandatory. A single instance is required.

Identifies the type of party that has assigned the associated item, e.g. a reference of type OrderNumber.

Refer to AssignedBy definition for any enumerations.

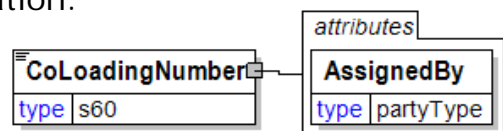

CoLoadingReference

An element item detailing relevant references pertaining to the coloading process.

CoLoadingReferenceType [attribute]

CoLoadingReferenceType is mandatory. A single instance is required.

CoLoadingReferenceType provides a contextual explanation of the specific reference identifier. Many items are currently prefixed by "Buyer", "Customer", "Seller", and/or "Supplier". Check for an existing non-prefixed version and use the non-prefixed version instead. In the (yet to be announced release date) version 3.0 the prefixed versions will be removed. Instead the attribute

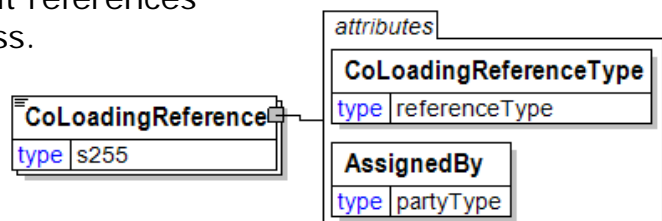

@AssignedBy will communicate the information previously communicated in the prefix.

Refer to CoLoadingReferenceType definition for any enumerations.

AssignedBy [attribute]

AssignedBy is optional. A single instance might exist.

Identifies the type of party that has assigned the associated item, e.g. a reference of type OrderNumber.

Refer to AssignedBy for any enumerations

CoLoadingReferenceType [attribute]

CoLoadingReferenceType provides a contextual explanation of the specific reference identifier. Many items are currently prefixed by "Buyer", "Customer", "Seller", and/or "Supplier". Check for an existing non-prefixed version and use the non-prefixed version instead. In the (yet to be announced release date) version 3.0 the prefixed versions will be removed. Instead the attribute @AssignedBy will communicate the information previously communicated in the prefix.

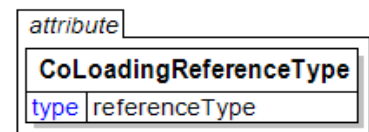

Refer to the [referenceType](#) entry for the list of enumerations and their definitions.

CoLoadingType [attribute]

Provides the Co-Loading type which can control and confirm co-loading.

This item is restricted to the following list.

CoLoaded

The delivery is co-loaded with other goods on the same transport unit.

Requested

CoLoading is requested and should be executed if possible.

Required

CoLoading is required and should always be executed.

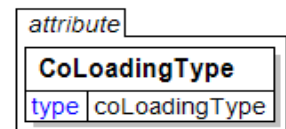

ColourCode

A code indicating the colour.

Agency [attribute]

Agency is optional. A single instance might exist.

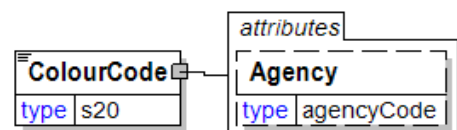

Describes the agency maintaining the list of codes. To be included in this list

the agency must be a recognized standards body or industry organisation.

For the element that owns this attribute.

For another attribute in the list of attributes associated with the parent element.

Refer to Agency definition for any enumerations.

ColourDescription

A free form description of the colour.

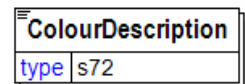

ColourDetail

A group item used to communicate details of colour according to the selected colour definition scheme.

(sequence)

The sequence of items below is mandatory. A single instance is required.

(choice)

[choice] is optional because of choice construct.

CMYK

CMYK is optional because of choice construct.

A definition of colour using the CMYK protocol.

ColourShade

ColourShade is optional because of choice construct.

The colour shade as defined by the indicated Agency.

HSB

HSB is optional because of choice construct.

A definition of colour using the HSB protocol.

All the components of the definition are required. The structure of Hue, Saturation, and Brilliance follows DetailMeasurement.

Lab

Lab is optional because of choice construct.

A definition of colour using the L*a*b protocol.

L*a*b colour consists of a luminance or lightness component (L) and two chromatic components: a component (from green to red) and the b component (from blue to yellow). All the components of the definition are required. The structure of Luminance, "a", and "b" follows DetailMeasurement.

RGB

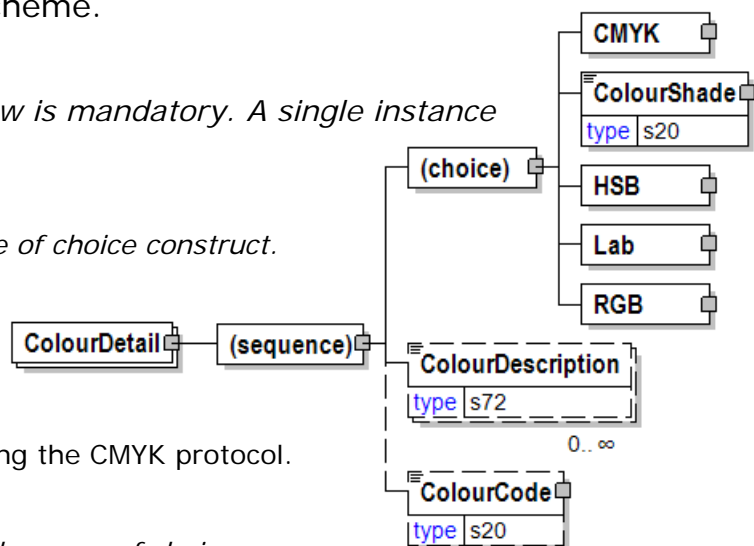

RGB is optional because of choice construct.

A definition of colour using the RGB protocol.

ColourDescription

ColourDescription is optional. Multiple instances might exist.

A free form description of the colour.

ColourCode

ColourCode is optional. A single instance might exist.

A code indicating the colour.

ColourLocation [attribute]

This item is restricted to the following list.

Front

Back

Page1

Page1 is defined to be the front-outside of a 4 page component such as a cover or a endsheet.

Page2

Page2 is defined to be the front--i Inside of a 4 page component such as a cover or a endsheet.

Page3

Page3 is defined to be the back-inside of a 4 page component such as a cover or a endsheet.

Page4

Page4 is defined to be the back-outside of a 4 page component such as a cover or a endsheet.



ColourMatchDescription

Colour match description

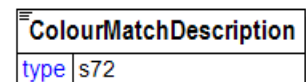

ColourShade

The colour shade as defined by the indicated Agency.

Agency [attribute]

Agency is mandatory. A single instance is required.

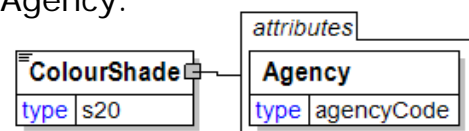

Describes the agency maintaining the list of codes. To be included in this list the agency must be a recognized standards body or industry organisation.

For the element that owns this attribute.

For another attribute in the list of attributes associated with the parent element.

Refer to Agency definition for any enumerations.

ColourSpecs

Colour specs

ColourLocation [attribute]

ColourLocation is optional. A single instance might exist.

Refer to ColourLocation definition for any enumerations.

(sequence)

The sequence of items below is optional. Multiple instances might exist.

ColourCode

ColourCode is optional. A single instance might exist.

A code indicating the colour.

ColourDescription

ColourDescription is mandatory. A single instance is required.

A free form description of the colour.

NumberOfColours

NumberOfColours is optional. A single instance might exist.

The number of colours.

InkTypeDescription

InkTypeDescription is optional. A single instance might exist.

Ink type description

ColourMatchDescription

ColourMatchDescription is optional. A single instance might exist.

Colour match description

ColourShade

ColourShade is optional. A single instance might exist.

The colour shade as defined by the indicated Agency.

InkCoverage

InkCoverage is optional. A single instance might exist.

Ink coverage

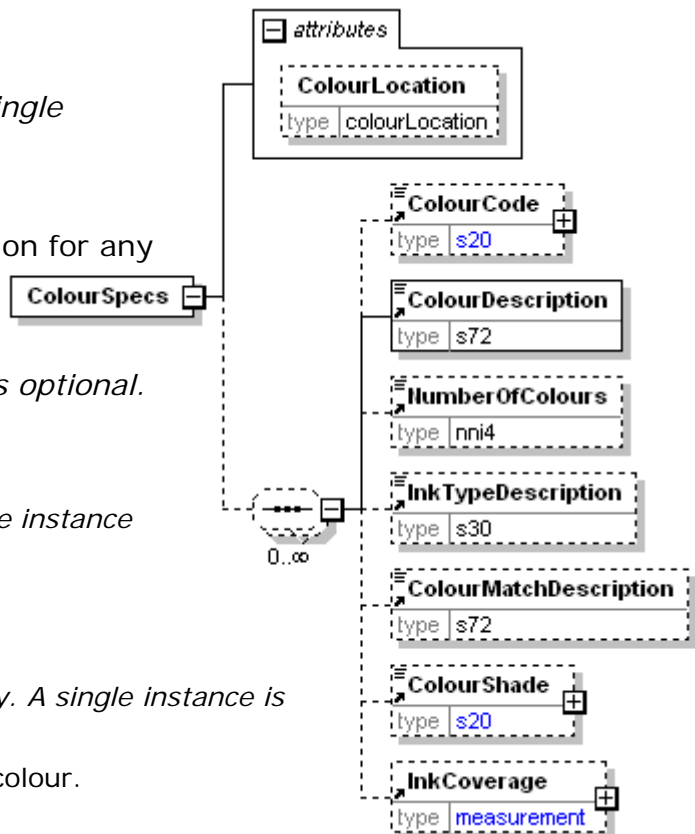

CommodityGoodsCode

A code defining the type of goods handled or traded.

The Harmonized Commodity Description and Coding System (HS) of the Customs Cooperation Council (CCC) is used worldwide as a reference for classifications of external trade statistics and for customs tariffs.

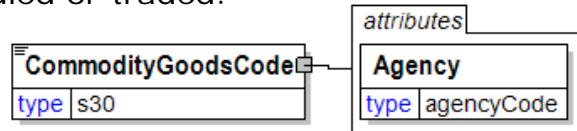

Agency [attribute]

Agency is mandatory. A single instance is required.

Describes the agency maintaining the list of codes. To be included in this list the agency must be a recognized standards body or industry organisation.

For the element that owns this attribute.

For another attribute in the list of attributes associated with the parent element.

Refer to Agency definition for any enumerations.

CommonContact

Identifies a specific individual associated with the party.

ContactType [attribute]

ContactType is mandatory. A single instance is required.

Identifies the role of the contact within the party.

Refer to ContactType definition for any enumerations.

(sequence)

The sequence of items below is mandatory. A single instance is required.

ContactName

ContactName is mandatory. A single instance is required.

The name of the individual associated with the ContactType.

ContactIdentifier

ContactIdentifier is optional. A single instance might exist.

The identifier for the contact.

Telephone

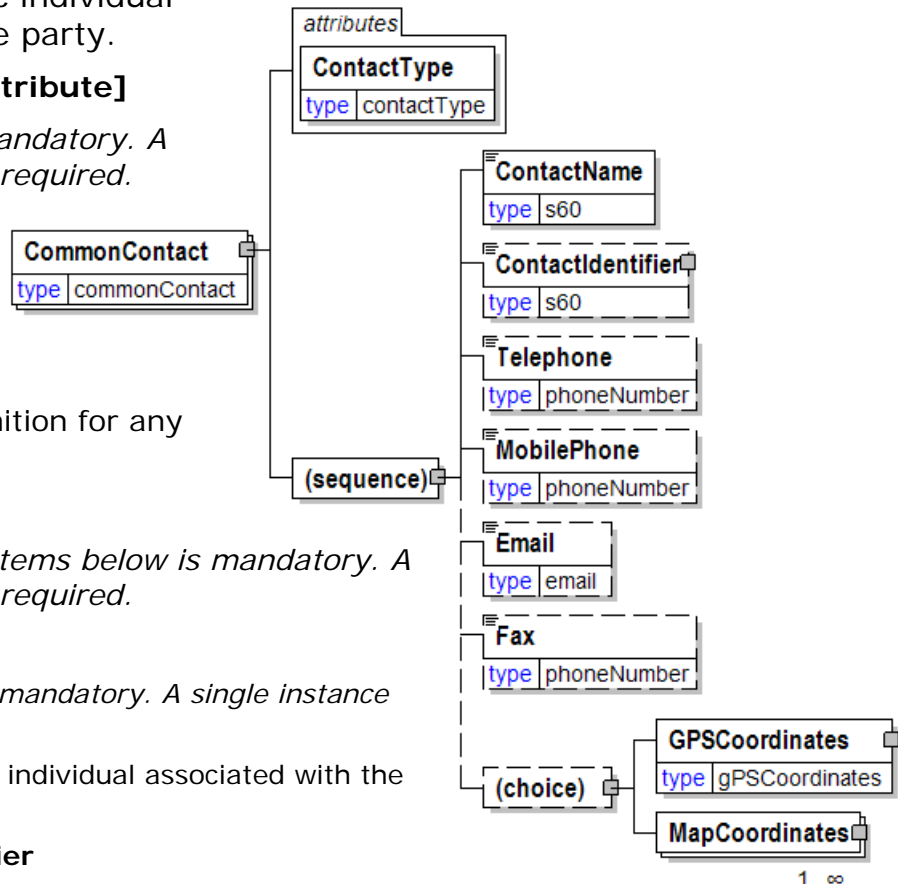

papiNet V2R31

Telephone is optional. A single instance might exist.

The business phone number of the individual associated with the ContactName.

MobilePhone

MobilePhone is optional. A single instance might exist.

The mobile phone number of the individual associated with the ContactName.

Email

Email is optional. A single instance might exist.

The primary business email address of the individual associated with the ContactName.

Fax

Fax is optional. A single instance might exist.

The primary business fax number of the individual associated with the ContactName.

(choice)

[choice] is optional because of choice construct.

GPSCoordinates

GPSCoordinates is optional because of choice construct.

The location of the party as specified using a Global Positioning System.

MapCoordinates

MapCoordinates is optional because of choice construct.

A group item defining and containing position co-ordinates of a location.

CommunicationRole [attribute]

Provides information about the sender, receiver, and participants to the document communication.

This item is restricted to the following list.

From

The document originates from this party.

To

The document is destined to this party.

CC

This party is copied on the document



Complaint

The Complaint element is the root element for the Complaint e-Document.

Typically, a Complaint e-Document is sent from the customer or end user to the supplier to communicate information regarding products or services. A response from the supplier is desired and corrective actions, if required. This e-Document must specify the necessary details to enable the supplier to trigger an internal process to verify whether the complaint reason corresponds to the supplier-assessed reason.

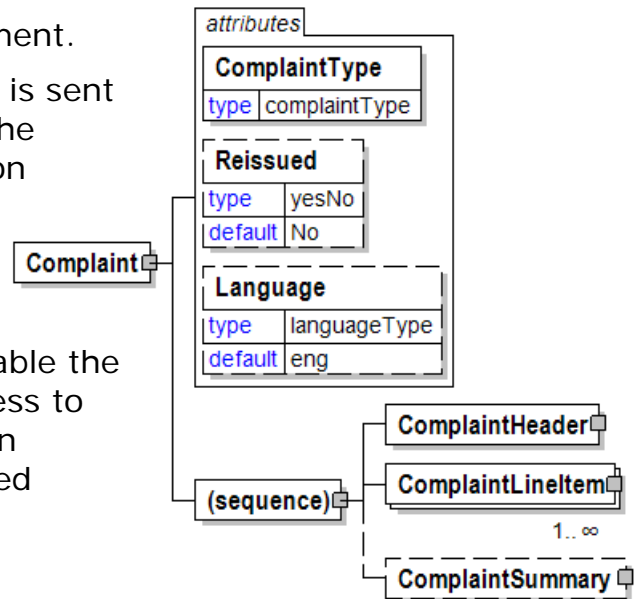

ComplaintType [attribute]

ComplaintType is mandatory. A single instance is required.

Indicates if the e-Document represents a Complaint by the sender or Feedback from the sender.

Refer to ComplaintType definition for any enumerations.

Reissued [attribute]

Reissued is optional. A single instance might exist.

Either "Yes" or "No".

Refer to Reissued definition for any enumerations.

Language [attribute]

Language is optional. A single instance might exist.

XML has embraced 2 and 3 digit language codes through the application of an addendum to the standard.

Refer to Language definition for any enumerations.

(sequence)

The sequence of items below is mandatory. A single instance is required.

ComplaintHeader

ComplaintHeader is mandatory. A single instance is required.

The ComplaintHeader is required and contains information common to the Complaint.

ComplaintLineItem

ComplaintLineItem is mandatory. One instance is required, multiple instances might exist.

The detail information of one of the items on the Complaint.

ComplaintSummary

ComplaintSummary is optional. A single instance might exist.

Summary information that applies to the entire Complaint e-Document.

ComplaintHeader

The ComplaintHeader is required and contains information common to the Complaint.

(sequence)

The sequence of items below is mandatory. A single instance is required.

ComplaintNumber

ComplaintNumber is mandatory. A single instance is required.

A unique identification number of the Complaint, generated by the complainer.

ComplaintIssueDate

ComplaintIssueDate is mandatory. A single instance is required.

The date on which the Complaint was issued by the complainer

ComplaintReference

ComplaintReference is optional. Multiple instances might exist.

A group item detailing relevant references pertaining to the Complaint. ComplaintReference contains the attribute ComplaintReferenceType.

RequestedAction

RequestedAction is optional. A single instance might exist.

The element that enables the party making the complaint (i.e. SenderParty) to specify what they want done regarding the Complaint (send a credit, send disposition instructions, etc.)

SenderParty

SenderParty is mandatory. A single instance is required.

The business entity issuing the e-Document, the source of the document.

The entity responsible for the content. If the sender party has out sourced the message service to a third party the SenderParty is the issuer of the e-Document and not the party performing the transmission service of the electronic message.

ReceiverParty

ReceiverParty is optional. Multiple instances might exist.

The business entity for whom the e-Document is intended, the destination of the document.

The entity interested in the content. If the receiver party has outsourced the

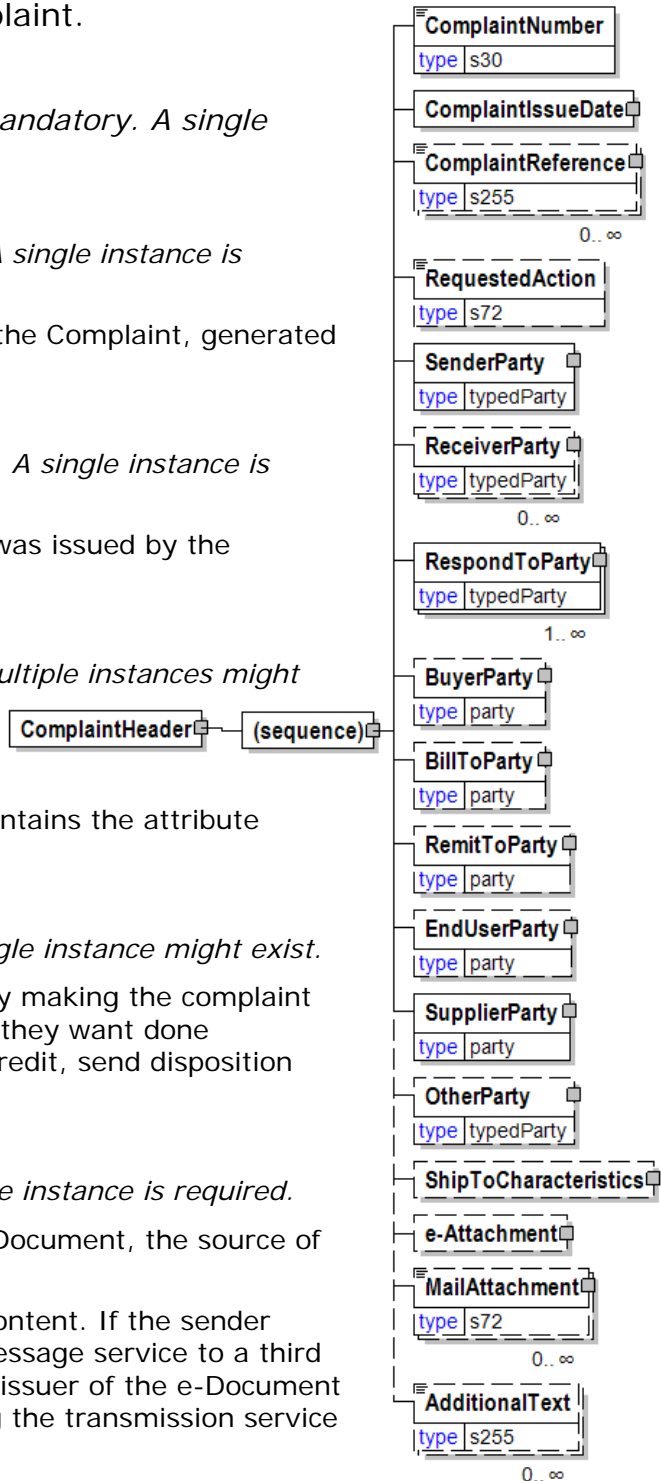

message service to a third party the ReceiverParty is the intended party for the e-Document and not the party performing the receiving service of the electronic message.

RespondToParty

RespondToParty is mandatory. One instance is required, multiple instances might exist.

The party the document should be responded to.

BuyerParty

BuyerParty is optional. A single instance might exist.

The legal entity to which the product is sold. Also commonly referred to as the sold-to party or customer. If no OtherParty is defined as the Payer, the Buyer is the Payer.

BillToParty

BillToParty is optional. A single instance might exist.

The address where the Invoice is to be sent.

RemitToParty

RemitToParty is optional. A single instance might exist.

A group item containing details of the party to whom payment will be made. The RemitToParty contains all information related to remittance.

EndUserParty

EndUserParty is optional. A single instance might exist.

The party using, consuming, or converting the product. For example, a printer using paper reels for a print job for a publisher. The final ShipTo destination for a product is normally to the end user's facilities.

SupplierParty

SupplierParty is mandatory. A single instance is required.

The organisation or business entity responsible for providing the product. SupplierParty is also the seller of the product, if Seller is not specified as OtherParty = Seller.

OtherParty

OtherParty is optional. A single instance might exist.

An organisation or business entity other than those specifically detailed within a e-Document.

ShipToCharacteristics

ShipToCharacteristics is optional. A single instance might exist.

A group item that provides information important for the Ship-To Party.

A group item that provides information important for the Ship-To Party. ShipToCharacteristics may be referenced at both the header and line item level. The reference at the header is required and acts as a default for the value at the line level, unless overridden at the line level.

e-Attachment

e-Attachment is optional. A single instance might exist.

e-Attachment enables the sender to provide information about attachments to the document.

papiNet V2R31

Note: BizTalk users may have problems in processing this element. See the papiNet FAQs (papiNet.org) for more information.

MailAttachment

MailAttachment is optional. Multiple instances might exist.

MailAttachment enables the complainer to indicate that they are providing by mail (express courier, snail mail etc.) proof of the Complaint.

AdditionalText

AdditionalText is optional. Multiple instances might exist.

A text field that is used to communicate information not previously defined or for special instructions. To be used only for circumstances not covered by specific elements.

ComplaintInformation

ComplaintInformation is a grouping element that contains general information about the Complaint.

(sequence)

The sequence of items below is mandatory. A single instance is required.

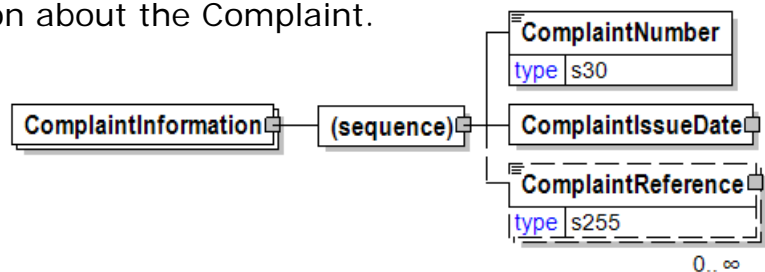

ComplaintNumber

ComplaintNumber is mandatory. A single instance is required.

A unique identification number of the Complaint, generated by the complainer.

ComplaintIssueDate

ComplaintIssueDate is mandatory. A single instance is required.

The date on which the Complaint was issued by the complainer

ComplaintReference

ComplaintReference is optional. Multiple instances might exist.

A group item detailing relevant references pertaining to the Complaint. ComplaintReference contains the attribute ComplaintReferenceType.

ComplaintIssueDate

The date on which the Complaint was issued by the complainer

(sequence)

The sequence of items below is mandatory. A single instance is required.

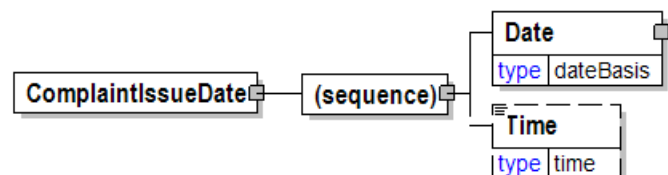

Date

Date is mandatory. A single instance is required.

A group element that contains the specification of Year, Month, and Day.

Time

Time is optional. A single instance might exist.

Times are treated in a standard XML fashion with a special case used to indicate a generalized "local" time. The standard XML approach to time is hh:mm:ss, hh:mm:ssZ, or hh:mm:ss±hh:mm.

hh:mm:ss±hh:mm is used to represent a time with a time zone. The time zone is communicated as the number of hours offset from the Universal Time Coordinate (UTC), a.k.a. Greenwich Mean Time.

hh:mm:ssZ indicates the time at Zulu (another name for UTC). Based on the convention described in the next bullet it will be important for users within UTC to use "Z" when communicating a time in their time zone to other users.

hh:mm:ss or hh:mm indicates in the XML standard the time at UTC however, within papiNet it is used to represent the applicable local time. Caution should be used when processing times of this nature as the papiNet approach may be in discord with other users of XML.

ComplaintLineItem

The detail information of one of the items on the Complaint.

(sequence)

The sequence of items below is mandatory. A single instance is required.

ComplaintLineItemNumber

ComplaintLineItemNumber is mandatory. A single instance is required.

The number used to identify the Complaint line item

ComplaintReason

ComplaintReason is mandatory. A single instance is required.

A group item containing the reason for the Complaint.

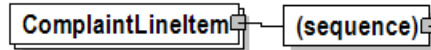

RequestedAction

RequestedAction is optional. A single instance might exist.

The element that enables the party making the complaint (i.e. SenderParty) to specify what they want done regarding the Complaint (send a credit, send disposition instructions, etc.)

ConsumptionProcess

ConsumptionProcess is optional. A single instance might exist.

Identifies the process relevant to the situation being described.

Refer to ConsumptionProcess definition for any enumerations.

TransportInformation

TransportInformation is optional. A single instance might exist.

A grouping element for transport information.

NumberOfComplaintLineItemDetail

NumberOfComplaintLineItemDetail is optional. A single instance might exist.

The number of ComplaintLineItemDetail elements for a given ComplaintLineItem (Example: the number of reels in a ComplaintLineItem)

(choice)

[choice] is optional because of choice construct.

ComplaintSpecification

ComplaintSpecification is optional because of choice construct.

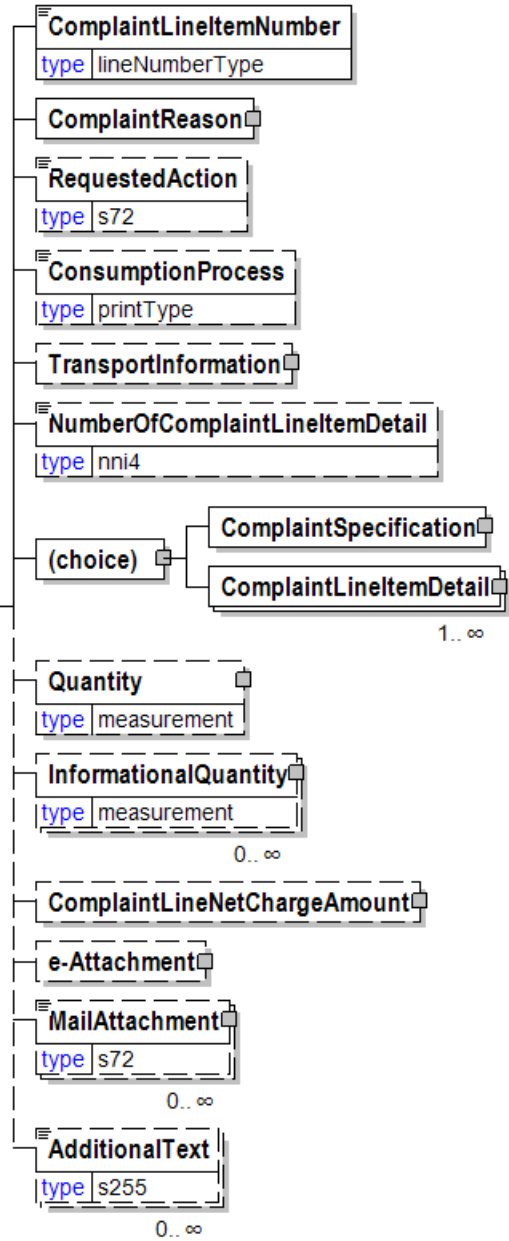

A group item containing information necessary to identify the physical item

ComplaintLineItemDetail

ComplaintLineItemDetail is optional because of choice construct.

A group item containing information necessary to identify the type of article being complained (example: pallet, reel etc.)

Quantity

Quantity is optional. A single instance might exist.

The Quantity element contains attributes that provide information about the type of quantity that is being communicated, the context in which the particular quantity is to be viewed, and (if the quantity represents an adjustment) an adjustment type.

The Quantity element contains three child elements that enable you to communicate a range of values for the quantity and a target or actual value. It is at this level (Value, RangeMin, and RangeMax) that the unit of measure is specified. This permits the range to be specified in a different unit of measure than the target.

InformationalQuantity

InformationalQuantity is optional. Multiple instances might exist.

A quantity given in a valid UOM used for information purposes only (not for calculation). For example, an ordered quantity was 100 reels as opposed to the invoice quantity of 20,000 pounds.

ComplaintLineNetChargeAmount

ComplaintLineNetChargeAmount is optional. A single instance might exist.

The total complained amount per line.

e-Attachment

e-Attachment is optional. A single instance might exist.

e-Attachment enables the sender to provide information about attachments to the document.

Note: BizTalk users may have problems in processing this element. See the papiNet FAQs (papiNet.org) for more information.

MailAttachment

MailAttachment is optional. Multiple instances might exist.

MailAttachment enables the complainer to indicate that they are providing by mail (express courier, snail mail etc.) proof of the Complaint.

AdditionalText

AdditionalText is optional. Multiple instances might exist.

A text field that is used to communicate information not previously defined or for special instructions. To be used only for circumstances not covered by specific elements.

ComplaintLineItemDetail

A group item containing information necessary to identify the type of article being complained (example: pallet, reel etc.)

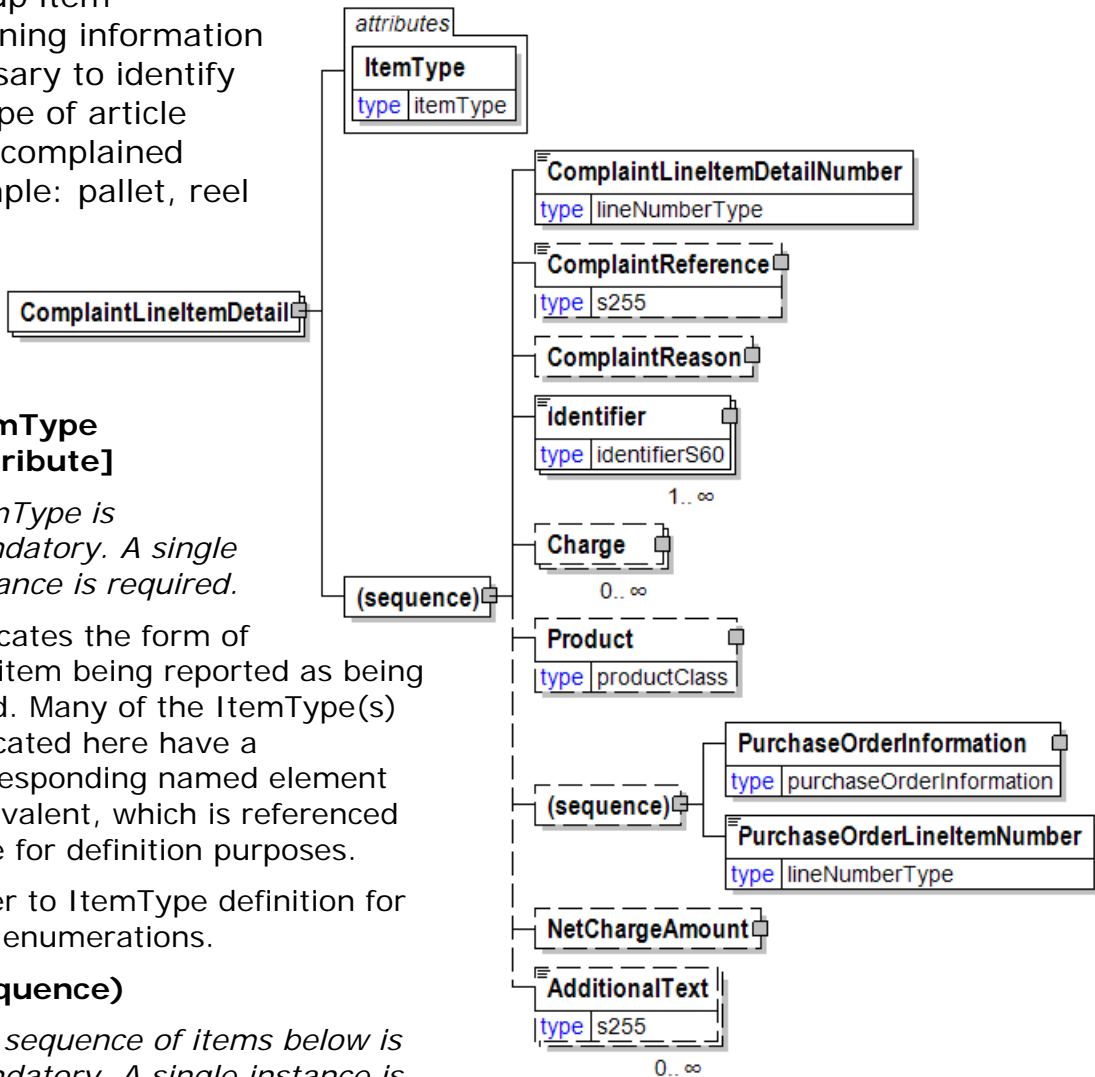

ItemType [attribute]

ItemType is mandatory. A single instance is required.

Indicates the form of the item being reported as being used. Many of the ItemType(s) indicated here have a corresponding named element equivalent, which is referenced here for definition purposes.

Refer to ItemType definition for any enumerations.

(sequence)

The sequence of items below is mandatory. A single instance is required.

ComplaintLineItemDetailNumber

ComplaintLineItemDetailNumber is mandatory. A single instance is required.

The sequential number of an item assigned by the party making the Complaint within ComplaintLineItemDetail

ComplaintReference

ComplaintReference is optional. A single instance might exist.

A group item detailing relevant references pertaining to the Complaint. ComplaintReference contains the attribute ComplaintReferenceType.

ComplaintReason

ComplaintReason is optional. A single instance might exist.

A group item containing the reason for the Complaint.

Identifier

Identifier is mandatory. One instance is required, multiple instances might exist.

An Identifier is required for packages and items (pallets, reel packages, boxes, ream items, reel items, etc). The Identifier element contains the actual item

identifier code. Identifier is repeatable so more than one identifier can be communicated. For example, the printed identifier on a label may be different from the barcode printed on the label.

Charge

Charge is optional. Multiple instances might exist.

Charge is a group element that contains elements that describe a charge.

Product

Product is optional. A single instance might exist.

Product is a group item defining the article and its characteristics. Product is used to specify product characteristics organized by ProductIdentifier, ProductDescription, and Classification. Book Manufacturing, Label Stock, Paper, Pulp, Recovered Paper, Wood Products, and Virgin Fibre market segments have defined their product characteristics and conversion features for implementation in papiNet.

(sequence)

The sequence of items below is optional. A single instance might exist.

PurchaseOrderInformation

PurchaseOrderInformation is mandatory. A single instance is required.

A group item containing information unique to this PurchaseOrder, which is provided by the buyer. PurchaseOrderInformation can be optional in the supply chain. Invoices are created without having a PurchaseOrder in Vendor Managed Inventory. Freight invoices also will not have a PurchaseOrder number.

PurchaseOrderLineItemNumber

PurchaseOrderLineItemNumber is mandatory. A single instance is required.

The sequential number that uniquely identifies the PurchaseOrder line item.

NetChargeAmount

NetChargeAmount is optional. A single instance might exist.

A field containing the sum of all instances of the Complaint charges.

AdditionalText

AdditionalText is optional. Multiple instances might exist.

A text field that is used to communicate information not previously defined or for special instructions. To be used only for circumstances not covered by specific elements.

ComplaintLineItemDetailNumber

The sequential number of an item assigned by the party making the Complaint within ComplaintLineItemDetail

ComplaintLineItemDetailNumber
type lineNumberType

ComplaintLineItemNumber

The number used to identify the Complaint line item

ComplaintLineItemNumber
type lineNumberType

ComplaintLineNetChargeAmount

The total complained amount per line.

(sequence)

The sequence of items below is mandatory. A single instance is required.

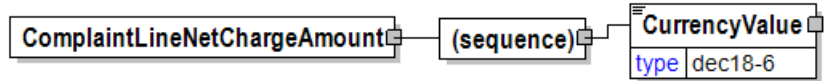

CurrencyValue

CurrencyValue is mandatory. A single instance is required.

The amount in the referenced currency as defined by the CurrencyType attribute.

ComplaintNumber

A unique identification number of the Complaint, generated by the complainer.

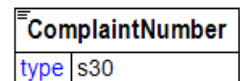

ComplaintReason

A group item containing the reason for the Complaint.

ComplaintReasonType
[attribute]

ComplaintReasonType is optional. A single instance might exist.

The type of complaint reason.

Refer to ComplaintReasonType definition for any enumerations.

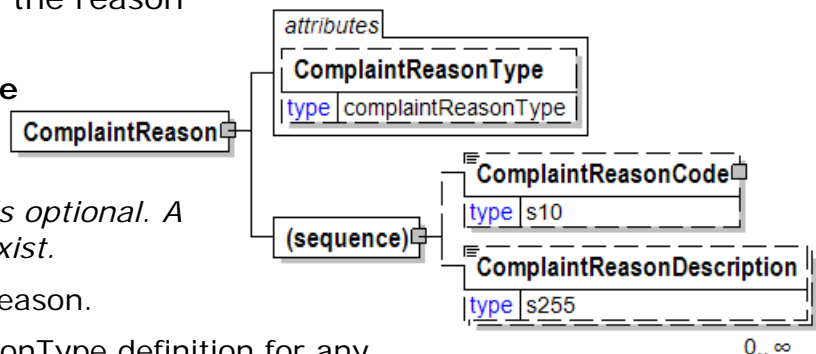

(sequence)

The sequence of items below is mandatory. A single instance is required.

ComplaintReasonCode

ComplaintReasonCode is optional. A single instance might exist.

A code for quickly communicating the type of ComplaintReason. The Agency responsible for the code can be associated with the element.

ComplaintReasonDescription

ComplaintReasonDescription is optional. Multiple instances might exist.

A text field element describing the reason for the Complaint

ComplaintReasonCode

A code for quickly communicating the type of ComplaintReason. The Agency responsible for the code can be associated with the element.

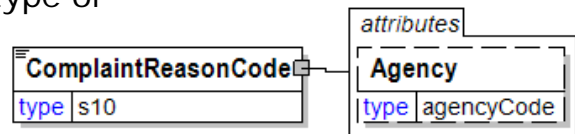

Agency [attribute]

Agency is optional. A single instance might exist.

Describes the agency maintaining the list of codes. To be included in this list the agency must be a recognized standards body or industry organisation.

For the element that owns this attribute.

For another attribute in the list of attributes associated with the parent element.

Refer to Agency definition for any enumerations.

ComplaintReasonDescription

A text field element describing the reason for the Complaint

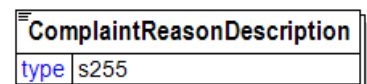

ComplaintReasonType [attribute]

The type of complaint reason.

This item is restricted to the following list.

Commercial

Logistical

Technical



ComplaintReference

A group item detailing relevant references pertaining to the Complaint. ComplaintReference contains the attribute ComplaintReferenceType.

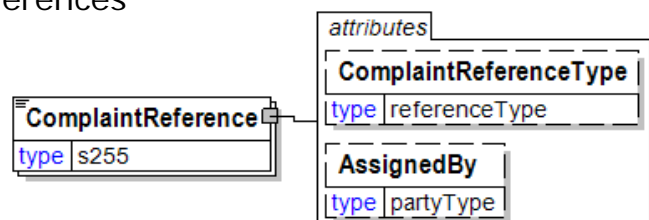

ComplaintReferenceType [attribute]

ComplaintReferenceType is optional. A single instance might exist.

Provides a contextual explanation of the specific reference identifier. Many items are currently prefixed by "Buyer", "Forwarder", "Manufacturer", "Mill", "Seller", "Supplier", "Warehouse", or "Vendor". Check for an existing non-prefixed version and use the non-prefixed version instead. In the (yet to be announced release date) version 3.0 the prefixed versions will be removed.

Instead the attribute @AssignedBy will communicate the information previously communicated in the prefix.

Refer to ComplaintReferenceType definition for any enumerations.

AssignedBy [attribute]

AssignedBy is optional. A single instance might exist.

Identifies the type of party that has assigned the associated item, e.g. a reference of type OrderNumber.

Refer to AssignedBy for any enumerations.

ComplaintReferenceType [attribute]

Provides a contextual explanation of the specific reference identifier. Many items are currently prefixed by "Buyer", "Forwarder", "Manufacturer", "Mill", "Seller", "Supplier", "Warehouse", or "Vendor". Check for an existing non-prefixed version and use the non-prefixed version instead. In the (yet to be announced release date) version 3.0 the prefixed versions will be removed. Instead the attribute @AssignedBy will communicate the information previously communicated in the prefix.

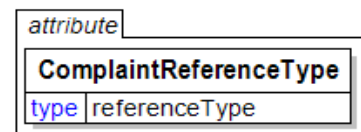

Refer to the [referenceType](#) entry for the list of enumerations and their definitions.

ComplaintResponse

The ComplaintResponse element is the root element for the ComplaintResponse e-Document.

Typically, a ComplaintResponse e-Document is sent from the supplier or sender parties to the party who has originated the Complaint, or possibly to the RespondToParty. The e-Document is sent to communicate the acceptance, partial acceptance, or rejection, of the preceding complaint(s) with supporting information. Whatever the decision, this e-Document must specify how the complaint will be processed.

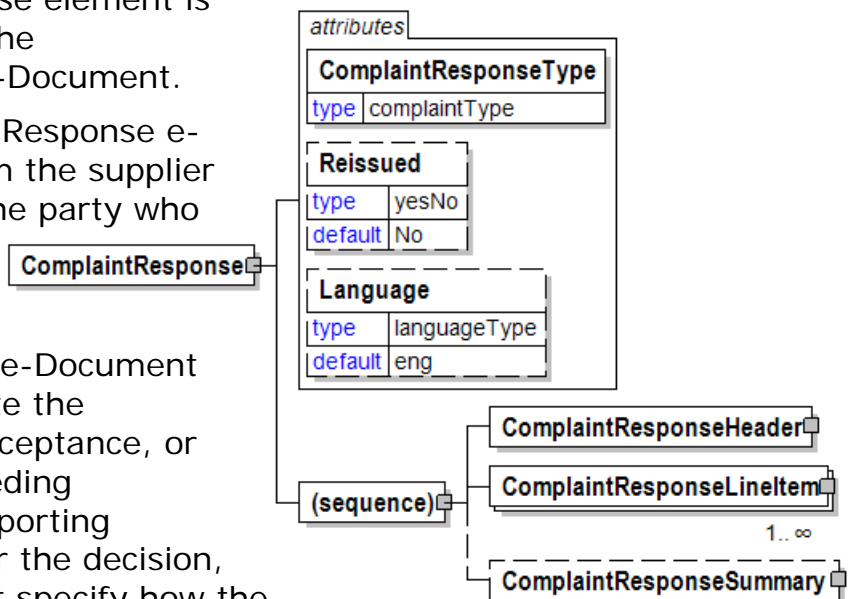

ComplaintResponseType [attribute]

ComplaintResponseType is mandatory. A single instance is required.

Indicates if the e-Document represents a Complaint by the sender or Feedback

from the sender.

Refer to ComplaintResponseType definition for any enumerations.

Reissued [attribute]

Reissued is optional. A single instance might exist.

Either "Yes" or "No".

Refer to Reissued definition for any enumerations.

Language [attribute]

Language is optional. A single instance might exist.

XML has embraced 2 and 3 digit language codes through the application of an addendum to the standard.

Refer to Language definition for any enumerations.

(sequence)

The sequence of items below is mandatory. A single instance is required.

ComplaintResponseHeader

ComplaintResponseHeader is mandatory. A single instance is required.

The ComplaintResponseHeader is required and contains information common to the ComplaintResponse.

ComplaintResponseLineItem

ComplaintResponseLineItem is mandatory. One instance is required, multiple instances might exist.

The detail information about the response for a particular complaint.

Note: In version V2R30 the multiplicity of e-Attachment was changed from optional, repeatable to optional, single. It is recognized that this is not backwardly compatible. We apologize for any issues this causes.

ComplaintResponseSummary

ComplaintResponseSummary is optional. A single instance might exist.

Summary information that applies to the entire ComplaintResponse e-Document.

ComplaintResponseHeader

The ComplaintResponseHeader is required and contains information common to the ComplaintResponse.

ComplaintResponseHeaderStatusType [attribute]

ComplaintResponseHeaderStatusType is mandatory. A single instance is required.

The status of the ComplaintResponse header.

Refer to



ComplaintResponseHeaderStatusType definition for any enumerations.

(sequence)

The sequence of items below is mandatory. A single instance is required.

ComplaintResponseNumber

ComplaintResponseNumber is mandatory. A single instance is required.

A unique identification number of the ComplaintResponse, generated by the issuer of the ComplaintResponse.

ComplaintResponseIssueDate

ComplaintResponseIssueDate is mandatory. A single instance is required.

The date on which the ComplaintResponse was issued within the sender's system.

ComplaintInformation

ComplaintInformation is mandatory. One instance is required, multiple instances might exist.

ComplaintInformation is a grouping element that contains general information about the Complaint.

RequestedAction

RequestedAction is optional. A single instance might exist.

The element that enables the party making the complaint (i.e. SenderParty) to specify what they want done regarding the Complaint (send a credit, send disposition instructions, etc.)

CorrectiveAction

CorrectiveAction is mandatory. A single instance is required.

This element enables the party issuing the ComplaintResponse (i.e. SupplierParty) to specify what is the corrective action they will take in order to close the Complaint (send a credit, send disposition instructions, etc.)

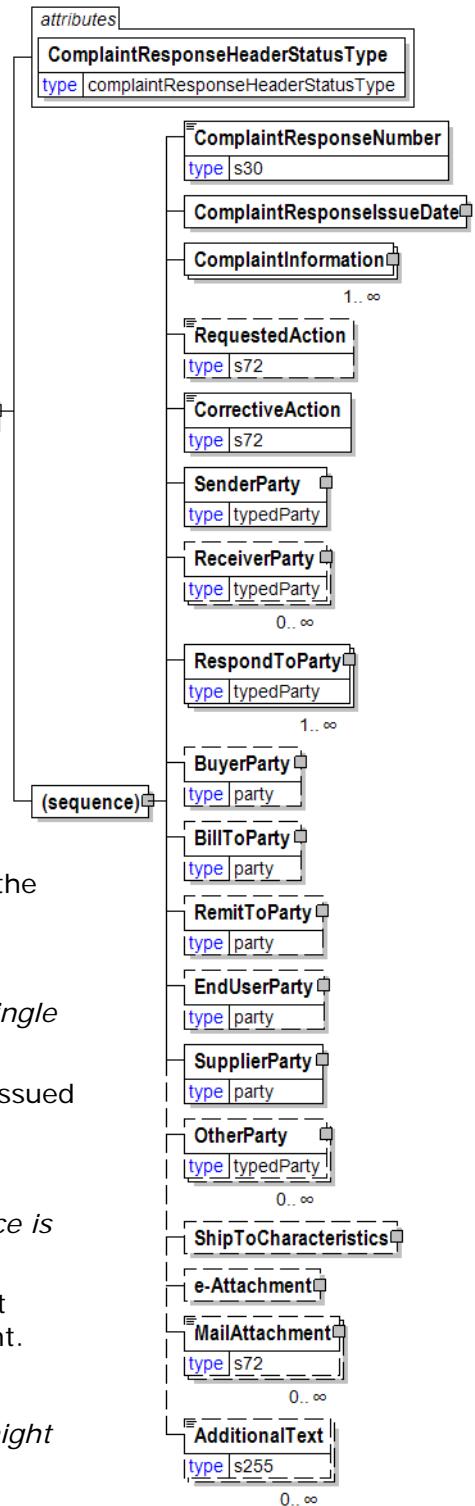

SenderParty

SenderParty is mandatory. A single instance is required.

The business entity issuing the e-Document, the source of the document.

The entity responsible for the content. If the sender party has out sourced the message service to a third party the SenderParty is the issuer of the e-Document and not the party performing the transmission service of the electronic message.

ReceiverParty

ReceiverParty is optional. Multiple instances might exist.

The business entity for whom the e-Document is intended, the destination of the document.

The entity interested in the content. If the receiver party has outsourced the message service to a third party the ReceiverParty is the intended party for the e-Document and not the party performing the receiving service of the electronic message.

RespondToParty

RespondToParty is mandatory. One instance is required, multiple instances might exist.

The party the document should be responded to.

BuyerParty

BuyerParty is optional. A single instance might exist.

The legal entity to which the product is sold. Also commonly referred to as the sold-to party or customer. If no OtherParty is defined as the Payer, the Buyer is the Payer.

BillToParty

BillToParty is optional. A single instance might exist.

The address where the Invoice is to be sent.

RemitToParty

RemitToParty is optional. A single instance might exist.

A group item containing details of the party to whom payment will be made. The RemitToParty contains all information related to remittance.

EndUserParty

EndUserParty is optional. A single instance might exist.

The party using, consuming, or converting the product. For example, a printer using paper reels for a print job for a publisher. The final ShipTo destination for a product is normally to the end user's facilities.

SupplierParty

SupplierParty is mandatory. A single instance is required.

The organisation or business entity responsible for providing the product. SupplierParty is also the seller of the product, if Seller is not specified as OtherParty = Seller.

OtherParty

OtherParty is optional. Multiple instances might exist.

An organisation or business entity other than those specifically detailed within a e-

Document.

ShipToCharacteristics

ShipToCharacteristics is optional. A single instance might exist.

A group item that provides information important for the Ship-To Party.

A group item that provides information important for the Ship-To Party. ShipToCharacteristics may be referenced at both the header and line item level. The reference at the header is required and acts as a default for the value at the line level, unless overridden at the line level.

e-Attachment

e-Attachment is optional. A single instance might exist.

e-Attachment enables the sender to provide information about attachments to the document.

Note: BizTalk users may have problems in processing this element. See the papiNet FAQs (papiNet.org) for more information.

MailAttachment

MailAttachment is optional. Multiple instances might exist.

MailAttachment enables the complainer to indicate that they are providing by mail (express courier, snail mail etc.) proof of the Complaint.

AdditionalText

AdditionalText is optional. Multiple instances might exist.

A text field that is used to communicate information not previously defined or for special instructions. To be used only for circumstances not covered by specific elements.

ComplaintResponseHeaderStatusType [attribute]

The status of the ComplaintResponse header.

This item is restricted to the following list.

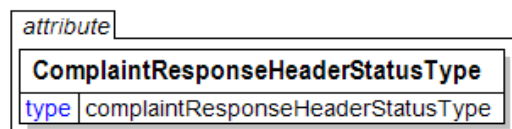

Accepted

The supplied information is accepted.

PartiallyAccepted

The supplied information is not completely accepted.

Rejected

The supplied information is rejected.

ComplaintResponseIssueDate

The date on which the ComplaintResponse was issued within the sender's system.

(sequence)

The sequence of items below is mandatory. A single instance is required.

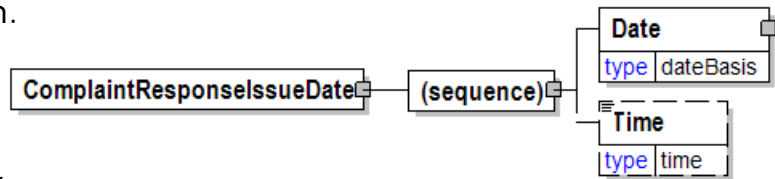

Date

Date is mandatory. A single instance is required.

A group element that contains the specification of Year, Month, and Day.

Time

Time is optional. A single instance might exist.

Times are treated in a standard XML fashion with a special case used to indicate a generalized "local" time. The standard XML approach to time is hh:mm:ss, hh:mm:ssZ, or hh:mm:ss±hh:mm.

hh:mm:ss±hh:mm is used to represent a time with a time zone. The time zone is communicated as the number of hours offset from the Universal Time Coordinate (UTC), a.k.a. Greenwich Mean Time.

hh:mm:ssZ indicates the time at Zulu (another name for UTC). Based on the convention described in the next bullet it will be important for users within UTC to use "Z" when communicating a time in their time zone to other users.

hh:mm:ss or hh:mm indicates in the XML standard the time at UTC however, within papiNet it is used to represent the applicable local time. Caution should be used when processing times of this nature as the papiNet approach may be in discord with other users of XML.

ComplaintResponseLineItem

The detail information about the response for a particular complaint.

Note: In version V2R30 the multiplicity of e-Attachment was changed from optional, repeatable to optional, single. It is recognized that this

ComplaintResponseLineItem

is not backwardly compatible. We apologize for any issues this causes.

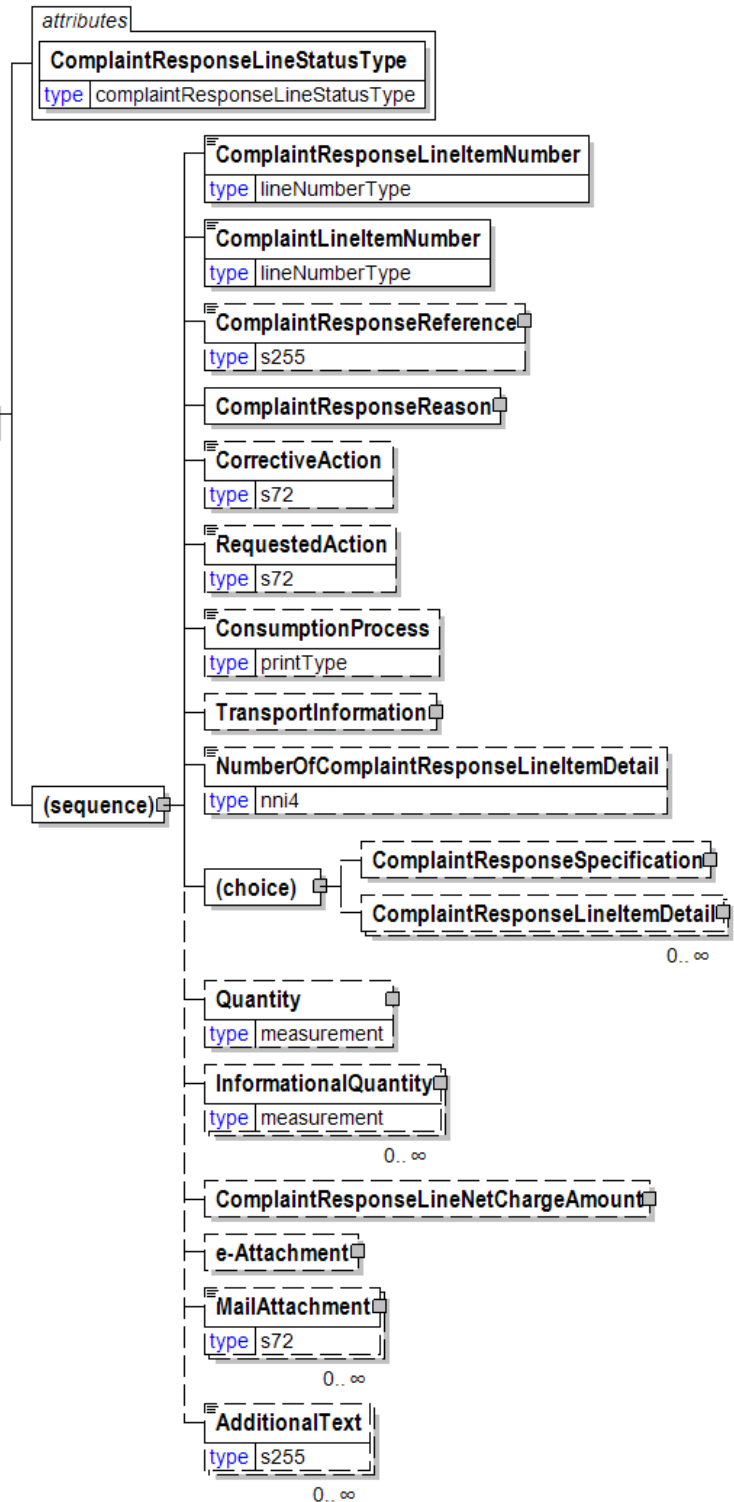

ComplaintResponseLineStatusType [attribute]

ComplaintResponseLineStatusType is mandatory. A single instance is required.

The status of the ComplaintResponse line.

Refer to ComplaintResponseLineStatusType definition for any enumerations.

(sequence)

The sequence of items below is mandatory. A single instance is required.

ComplaintResponseLineItemNumber

ComplaintResponseLineItemNumber is mandatory. A single instance is required.

The number used to identify the ComplaintResponse line item

ComplaintLineItemNumber

ComplaintLineItemNumber is mandatory. A single instance is required.

The number used to identify the Complaint line item

ComplaintResponseReference

ComplaintResponseReference is optional. A single instance might exist.

A group item detailing relevant references pertaining to the ComplaintResponse

ComplaintResponseReason

ComplaintResponseReason is mandatory. A single instance is required.

A group item containing the reason assessed by the supplier or sender parties for the ComplaintResponse

CorrectiveAction

CorrectiveAction is optional. A single instance might exist.

This element enables the party issuing the ComplaintResponse (i.e. SupplierParty) to specify what is the corrective action they will take in order to close the Complaint (send a credit, send disposition instructions, etc.)

RequestedAction

RequestedAction is optional. A single instance might exist.

The element that enables the party making the complaint (i.e. SenderParty) to specify what they want done regarding the Complaint (send a credit, send disposition instructions, etc.)

ConsumptionProcess

ConsumptionProcess is optional. A single instance might exist.

Identifies the process relevant to the situation being described.

Refer to ConsumptionProcess definition for any enumerations.

TransportInformation

TransportInformation is optional. A single instance might exist.

A grouping element for transport information.

NumberOfComplaintResponseLineItemDetail

NumberOfComplaintResponseLineItemDetail is optional. A single instance might exist.

The number of ComplaintResponseLineItemDetail elements for a given ComplaintResponseLineItem

(choice)

[choice] is optional because of choice construct.

ComplaintResponseSpecification

ComplaintResponseSpecification is optional because of choice construct.

A group item containing information necessary to identify the physical item.

ComplaintResponseLineItemDetail

ComplaintResponseLineItemDetail is optional because of choice construct.

A group item containing information necessary to identify the type of article being complained.

Quantity

Quantity is optional. A single instance might exist.

The Quantity element contains attributes that provide information about the type of quantity that is being communicated, the context in which the particular quantity is to be viewed, and (if the quantity represents an adjustment) an adjustment type.

The Quantity element contains three child elements that enable you to communicate a range of values for the quantity and a target or actual value. It is at this level (Value, RangeMin, and RangeMax) that the unit of measure is specified. This permits the range to be specified in a different unit of measure than the target.

InformationalQuantity

InformationalQuantity is optional. Multiple instances might exist.

A quantity given in a valid UOM used for information purposes only (not for calculation). For example, an ordered quantity was 100 reels as opposed to the invoice quantity of 20,000 pounds.

ComplaintResponseLineNetChargeAmount

ComplaintResponseLineNetChargeAmount is optional. A single instance might exist.

The net ComplaintResponse amount per line (excludes adjustments and tax).

e-Attachment

e-Attachment is optional. A single instance might exist.

e-Attachment enables the sender to provide information about attachments to the document.

Note: BizTalk users may have problems in processing this element. See the papiNet FAQs (papiNet.org) for more information.

MailAttachment

MailAttachment is optional. Multiple instances might exist.

MailAttachment enables the complainer to indicate that they are providing by mail (express courier, snail mail etc.) proof of the Complaint.

AdditionalText

AdditionalText is optional. Multiple instances might exist.

A text field that is used to communicate information not previously defined or for special instructions. To be used only for circumstances not covered by specific elements.

ComplaintResponseLineItemDetail

A group item containing information necessary to identify the type of article being complained.

ItemType [attribute]

ComplaintResponseLineItemDetail

ItemType is mandatory. A single instance is required.

Indicates the form of the item being reported as being used. Many of the ItemType(s) indicated here have a corresponding named element equivalent, which is referenced here for definition purposes.

Refer to ItemType definition for any enumerations.

(sequence)

The sequence of items below is mandatory. A single instance is required.

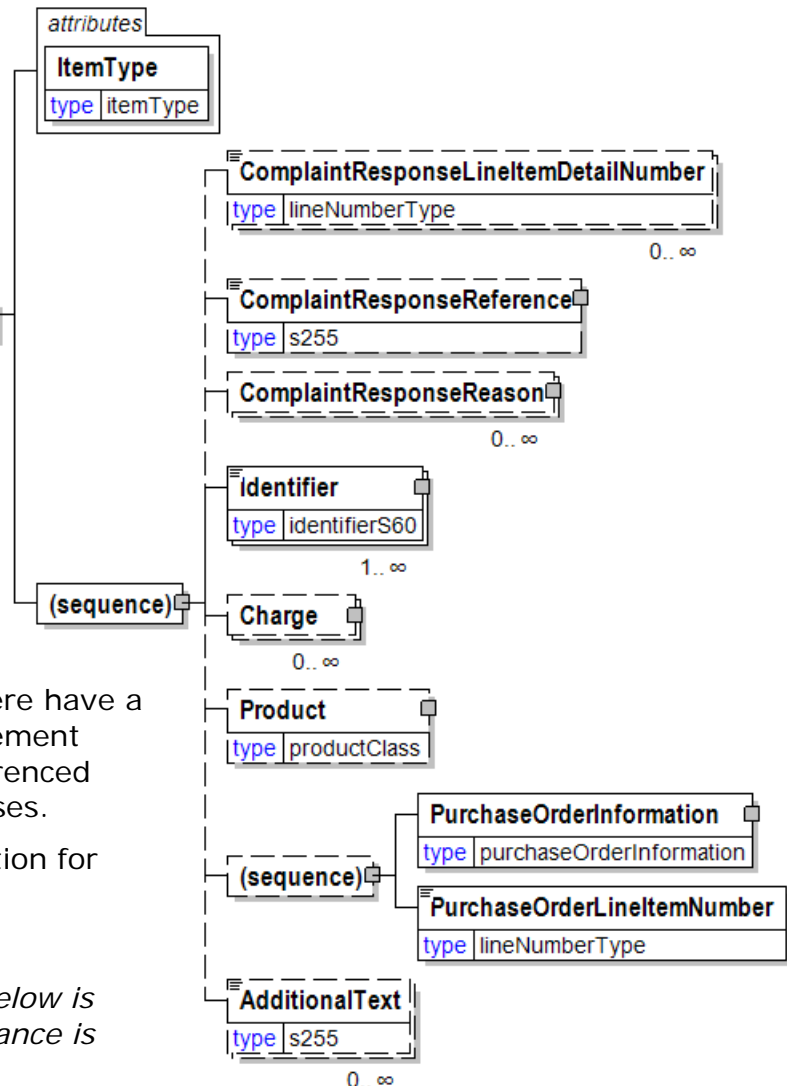

ComplaintResponseLineItemDetailNumber

ComplaintResponseLineItemDetailNumber is optional. Multiple instances might exist.

The sequential number of an item assigned by the party making the ComplaintResponse within line item detail.

ComplaintResponseReference

ComplaintResponseReference is optional. A single instance might exist.

A group item detailing relevant references pertaining to the ComplaintResponse

ComplaintResponseReason

ComplaintResponseReason is optional. Multiple instances might exist.

A group item containing the reason assessed by the supplier or sender parties for the ComplaintResponse

Identifier

Identifier is mandatory. One instance is required, multiple instances might exist.

An Identifier is required for packages and items (pallets, reel packages, boxes, ream items, reel items, etc). The Identifier element contains the actual item

papiNet V2R31

identifier code. Identifier is repeatable so more than one identifier can be communicated. For example, the printed identifier on a label may be different from the barcode printed on the label.

Charge

Charge is optional. Multiple instances might exist.

Charge is a group element that contains elements that describe a charge.

Product

Product is optional. A single instance might exist.

Product is a group item defining the article and its characteristics. Product is used to specify product characteristics organized by ProductIdentifier, ProductDescription, and Classification. Book Manufacturing, Label Stock, Paper, Pulp, Recovered Paper, Wood Products, and Virgin Fibre market segments have defined their product characteristics and conversion features for implementation in papiNet.

(sequence)

The sequence of items below is optional. A single instance might exist.

PurchaseOrderInformation

PurchaseOrderInformation is mandatory. A single instance is required.

A group item containing information unique to this PurchaseOrder, which is provided by the buyer. PurchaseOrderInformation can be optional in the supply chain. Invoices are created without having a PurchaseOrder in Vendor Managed Inventory. Freight invoices also will not have a PurchaseOrder number.

PurchaseOrderLineItemNumber

PurchaseOrderLineItemNumber is mandatory. A single instance is required.

The sequential number that uniquely identifies the PurchaseOrder line item.

AdditionalText

AdditionalText is optional. Multiple instances might exist.

A text field that is used to communicate information not previously defined or for special instructions. To be used only for circumstances not covered by specific elements.

ComplaintResponseLineItemDetailNumber

The sequential number of an item assigned by the party making the ComplaintResponse within line item detail.

ComplaintResponseLineItemDetailNumber
type lineNumberType

ComplaintResponseLineItemNumber

The number used to identify the ComplaintResponse line item

ComplaintResponseLineItemNumber
type lineNumberType

ComplaintResponseLineNetChargeAmount

The net ComplaintResponse amount per line (excludes adjustments and tax).

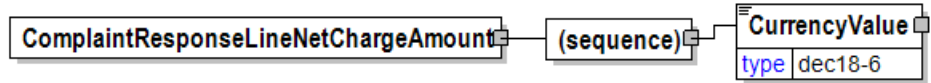

(sequence)

The sequence of items below is mandatory. A single instance is required.

CurrencyValue

CurrencyValue is mandatory. A single instance is required.

The amount in the referenced currency as defined by the CurrencyType attribute.

ComplaintResponseLineStatusType [attribute]

The status of the ComplaintResponse line.

This item is restricted to the following list.



Accepted

The supplied information is accepted.

PartiallyAccepted

The supplied information is not completely accepted.

Rejected

The supplied information is rejected.

ComplaintResponseNumber

A unique identification number of the ComplaintResponse, generated by the issuer of the ComplaintResponse.

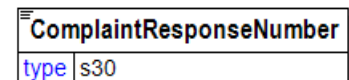

ComplaintResponseReason

A group item containing the reason assessed by the supplier or sender parties for the

ComplaintResponse

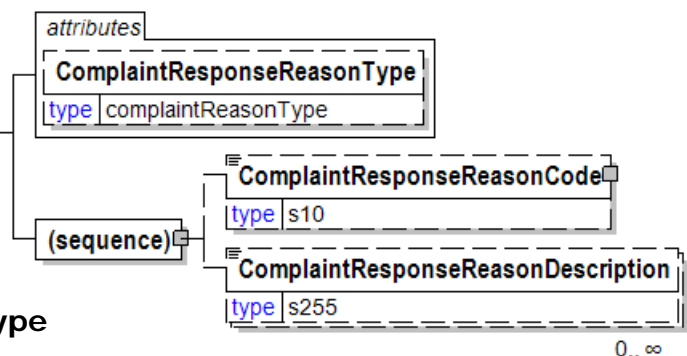

ComplaintResponseReasonType [attribute]

ComplaintResponseReasonType is optional. A single instance might exist.

The type of complaint reason.

Refer to ComplaintResponseReasonType definition for any enumerations.

(sequence)

The sequence of items below is mandatory. A single instance is required.

ComplaintResponseReasonCode

ComplaintResponseReasonCode is optional. A single instance might exist.

The reason for the complaint in code form. Agency provides the context.

ComplaintResponseReasonDescription

ComplaintResponseReasonDescription is optional. Multiple instances might exist.

A text field element describing the reason for the ComplaintResponse

ComplaintResponseReasonCode

The reason for the complaint in code form. Agency provides the context.

Agency [attribute]

Agency is optional. A single instance might exist.

Describes the agency maintaining the list of codes. To be included in this list the agency must be a recognized standards body or industry organisation.

For the element that owns this attribute.

For another attribute in the list of attributes associated with the parent element.

Refer to Agency definition for any enumerations.



ComplaintResponseReasonDescription

A text field element describing the reason for the ComplaintResponse

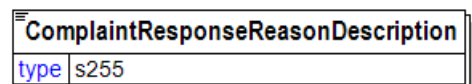

ComplaintResponseReasonType [attribute]

The type of complaint reason.

This item is restricted to the following list.

Commercial

Logistical

Technical



ComplaintResponseReference

A group item detailing relevant references pertaining to the

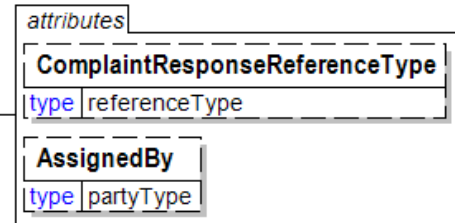
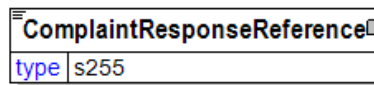

ComplaintResponse

ComplaintResponseReferenceType [attribute]

ComplaintResponseReferenceType is optional. A single instance might exist.

Provides a contextual explanation of the specific reference identifier. Many items are currently prefixed by "Buyer", "Forwarder", "Manufacturer", "Mill", "Seller", "Supplier", "Warehouse", or "Vendor". Check for an existing non-prefixed version and use the non-prefixed version instead. In the (yet to be announced release date) version 3.0 the prefixed versions will be removed. Instead the attribute @AssignedBy will communicate the information previously communicated in the prefix.

Refer to ComplaintResponseReferenceType definition for any enumerations.

AssignedBy [attribute]

AssignedBy is optional. A single instance might exist.

Identifies the type of party that has assigned the associated item, e.g. a reference of type OrderNumber.

Refer to AssignedBy for any enumerations

ComplaintResponseReferenceType [attribute]

Provides a contextual explanation of the specific reference identifier. Many items are currently prefixed by "Buyer", "Forwarder", "Manufacturer", "Mill", "Seller", "Supplier", "Warehouse", or "Vendor". Check for an

existing non-prefixed version and use the non-prefixed version instead. In the (yet to be announced release date) version 3.0 the prefixed versions will be removed. Instead the attribute @AssignedBy will communicate the information previously communicated in the prefix.

Refer to the [referenceType](#) entry for the list of enumerations and their definitions.

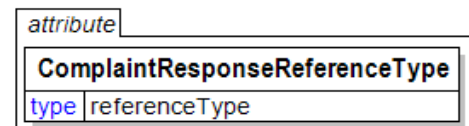

ComplaintResponseSpecification

A group item containing information necessary to identify the physical item.

(sequence)

The sequence of items below is mandatory. A single instance is required.

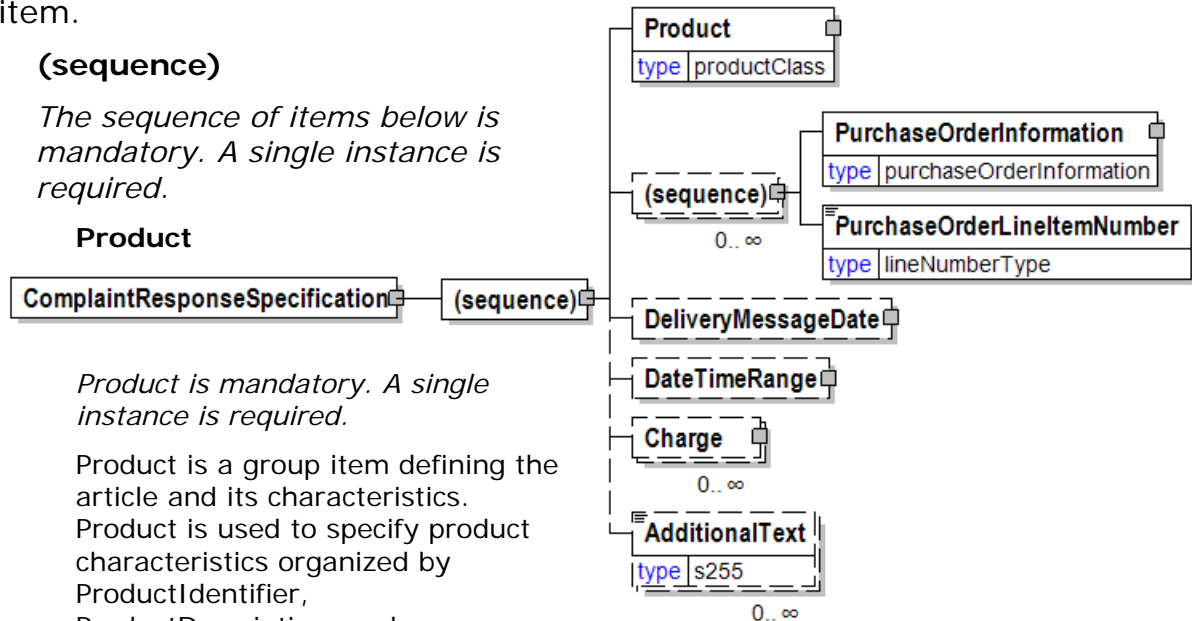

Product

Product is mandatory. A single instance is required.

Product is a group item defining the article and its characteristics. Product is used to specify product characteristics organized by ProductIdentifier, ProductDescription, and Classification. Book Manufacturing, Label Stock, Paper, Pulp, Recovered Paper, Wood Products, and Virgin Fibre market segments have defined their product characteristics and conversion features for implementation in papiNet.

(sequence)

The sequence of items below is optional. Multiple instances might exist.

PurchaseOrderInformation

PurchaseOrderInformation is mandatory. A single instance is required.

A group item containing information unique to this PurchaseOrder, which is provided by the buyer. PurchaseOrderInformation can be optional in the supply chain. Invoices are created without having a PurchaseOrder in Vendor Managed Inventory. Freight invoices also will not have a PurchaseOrder number.

PurchaseOrderLineItemNumber

PurchaseOrderLineItemNumber is mandatory. A single instance is required.

The sequential number that uniquely identifies the PurchaseOrder line item.

DeliveryMessageDate

DeliveryMessageDate is optional. A single instance might exist.

The Date and Time when the DeliveryMessage was issued.

DateTimeRange

DateTimeRange is optional. A single instance might exist.

Specifies a date and/or time range.

Charge

Charge is optional. Multiple instances might exist.

Charge is a group element that contains elements that describe a charge.

AdditionalText

AdditionalText is optional. Multiple instances might exist.

A text field that is used to communicate information not previously defined or for special instructions. To be used only for circumstances not covered by specific elements.

ComplaintResponseSummary

Summary information that applies to the entire ComplaintResponse e-Document.

(sequence)

The sequence of items below is mandatory. A single instance is required.

TotalNumberOfLineItems

TotalNumberOfLineItems is optional. A single instance might exist.

The total number of individual line items in the document, regardless of the status or type.

TotalQuantity

TotalQuantity is optional. A single instance might exist.

The total quantity of similar items in the e-Document. TotalQuantity is primarily used in the summary section of documents where it is repeatable to permit totaling for different units of measure.

TotalInformationalQuantity

TotalInformationalQuantity is optional. Multiple instances might exist.

A quantity that is used to communicate related information about the parent element. This element represents a total that is derived from individual line items.

TotalNetAmount

TotalNetAmount is optional. A single instance might exist.

A field containing total amount excluding tax. For example, in the Invoice TotalNetAmount is equal to the sum of LineItemSubTotal plus TotalAdjustments. TotalNetAmount encapsulates CurrencyValue.

TotalInformationalAmount

TotalInformationalAmount is optional. Multiple instances might exist.

A monetary amount used for information purposes only (not for calculation). For example, the invoice price adjustment subtotal is expressed in sterling pounds, and the buyer wants this information expressed in U.S. dollars.

AdditionalText

AdditionalText is optional. Multiple instances might exist.

A text field that is used to communicate information not previously defined or for special instructions. To be used only for circumstances not covered by specific elements.

TermsAndDisclaimers

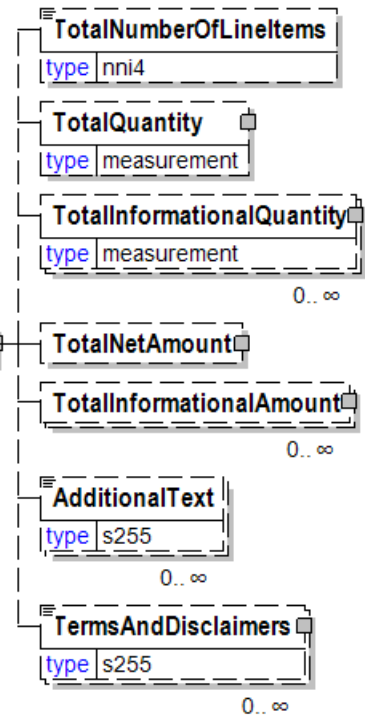

TermsAndDisclaimers is optional. Multiple instances might exist.

An element that contains legal information with an indication of what the Language is.

ComplaintResponseType [attribute]

Indicates if the e-Document represents a Complaint by the sender or Feedback from the sender.

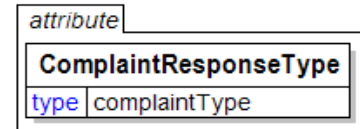

This item is restricted to the following list.

Claim

Feedback

ComplaintSpecification

A group item containing information necessary to identify the physical item

(sequence)

The sequence of items below is mandatory. A single instance is required.

Product

Product is optional. A single instance might exist.

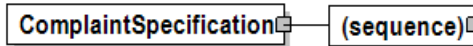

Product is a group item defining the article and its characteristics. Product is used to specify product characteristics organized by ProductIdentifier, ProductDescription, and Classification. Book Manufacturing, Label Stock, Paper, Pulp, Recovered Paper, Wood Products, and Virgin Fibre market segments have defined their product characteristics and conversion features for implementation in papiNet.

(sequence)

The sequence of items below is optional. Multiple instances might exist.

PurchaseOrderInformation

PurchaseOrderInformation is mandatory. A single instance is required.

A group item containing information unique to this PurchaseOrder, which is provided by the buyer. PurchaseOrderInformation can be optional in the supply chain. Invoices are created without having a PurchaseOrder in Vendor Managed Inventory. Freight invoices also will not have a PurchaseOrder number.

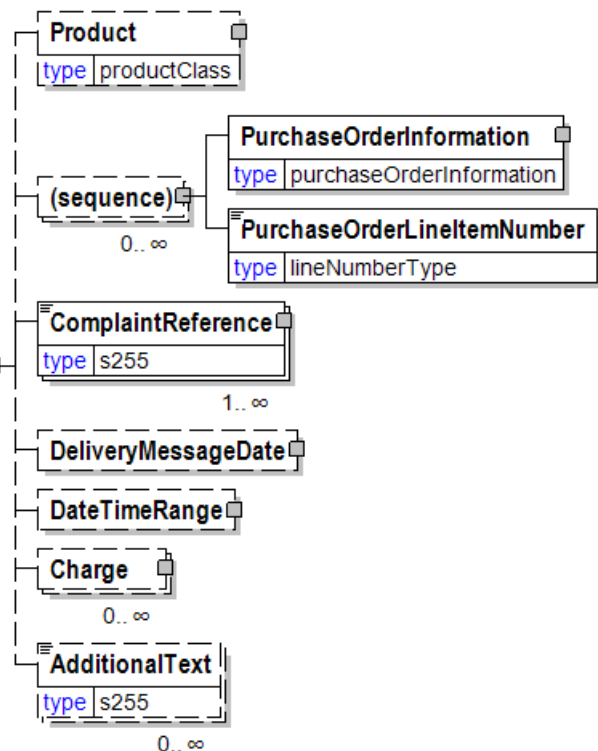

PurchaseOrderLineItemNumber

PurchaseOrderLineItemNumber is mandatory. A single instance is required.

The sequential number that uniquely identifies the PurchaseOrder line item.

ComplaintReference

ComplaintReference is mandatory. One instance is required, multiple instances might exist.

A group item detailing relevant references pertaining to the Complaint. ComplaintReference contains the attribute ComplaintReferenceType.

DeliveryMessageDate

DeliveryMessageDate is optional. A single instance might exist.

The Date and Time when the DeliveryMessage was issued.

DateTimeRange

DateTimeRange is optional. A single instance might exist.

Specifies a date and/or time range.

Charge

Charge is optional. Multiple instances might exist.

Charge is a group element that contains elements that describe a charge.

AdditionalText

AdditionalText is optional. Multiple instances might exist.

A text field that is used to communicate information not previously defined or for special instructions. To be used only for circumstances not covered by specific elements.

ComplaintSummary

Summary information that applies to the entire complaint e-Document.

(sequence)

The sequence of items below is mandatory. A single instance is required.

TotalNumberOfLineItems

TotalNumberOfLineItems is optional. A single instance might exist.

The total number of individual line items in the document, regardless of the status or type.

TotalQuantity

TotalQuantity is optional. A single instance might exist.

The total quantity of similar items in the e-Document. TotalQuantity is primarily used in the summary section of documents where it is repeatable to permit totaling for different units of measure.

ComplaintSummary

(sequence)

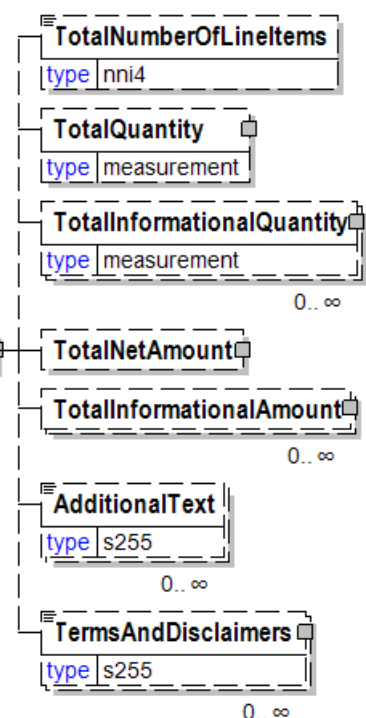

TotalInformationalQuantity

TotalInformationalQuantity is optional. Multiple instances might exist.

A quantity that is used to communicate related information about the parent element. This element represents a total that is derived from individual line items.

TotalNetAmount

TotalNetAmount is optional. A single instance might exist.

A field containing total amount excluding tax. For example, in the Invoice TotalNetAmount is equal to the sum of LineItemSubTotal plus TotalAdjustments. TotalNetAmount encapsulates CurrencyValue.

TotalInformationalAmount

TotalInformationalAmount is optional. Multiple instances might exist.

A monetary amount used for information purposes only (not for calculation). For example, the invoice price adjustment subtotal is expressed in sterling pounds, and the buyer wants this information expressed in U.S. dollars.

AdditionalText

AdditionalText is optional. Multiple instances might exist.

A text field that is used to communicate information not previously defined or for special instructions. To be used only for circumstances not covered by specific elements.

TermsAndDisclaimers

TermsAndDisclaimers is optional. Multiple instances might exist.

An element that contains legal information with an indication of what the Language is.

ComplaintType [attribute]

Indicates if the e-Document represents a Complaint by the sender or Feedback from the sender.

This item is restricted to the following list.

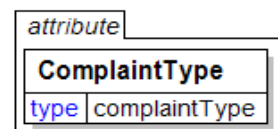

Claim

A "Claim" type is used when there is a customer reaction that includes a financial compensation.

Feedback

A "Feedback" type is used when there is a customer reaction that doesn't include any financial compensation.

ComponentDueDate

Date supplied component is expected to arrive

(sequence)

The sequence of items below is mandatory. A single instance is required.

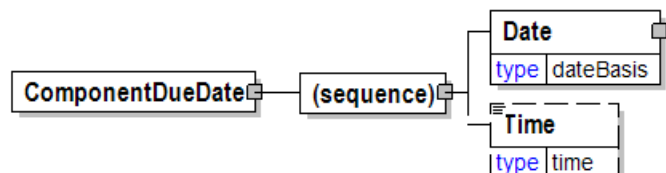

papiNet V2R31

Date

Date is mandatory. A single instance is required.

A group element that contains the specification of Year, Month, and Day.

Time

Time is optional. A single instance might exist.

Times are treated in a standard XML fashion with a special case used to indicate a generalized "local" time. The standard XML approach to time is hh:mm:ss, hh:mm:ssZ, or hh:mm:ss±hh:mm.

hh:mm:ss±hh:mm is used to represent a time with a time zone. The time zone is communicated as the number of hours offset from the Universal Time Coordinate (UTC), a.k.a. Greenwich Mean Time.

hh:mm:ssZ indicates the time at Zulu (another name for UTC). Based on the convention described in the next bullet it will be important for users within UTC to use "Z" when communicating a time in their time zone to other users.

hh:mm:ss or hh:mm indicates in the XML standard the time at UTC however, within papiNet it is used to represent the applicable local time. Caution should be used when processing times of this nature as the papiNet approach may be in discord with other users of XML.

ComponentNeededDate

Date the supplied component is needed by the vendor in order to make the due date of the ordered product.

(sequence)

The sequence of items below is mandatory. A single instance is required.

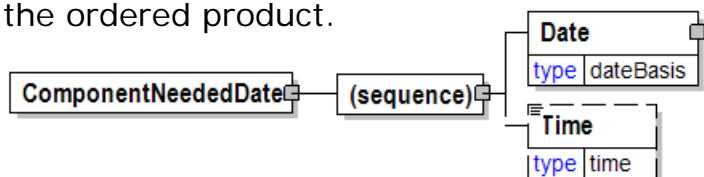

Date

Date is mandatory. A single instance is required.

A group element that contains the specification of Year, Month, and Day.

Time

Time is optional. A single instance might exist.

Times are treated in a standard XML fashion with a special case used to indicate a generalized "local" time. The standard XML approach to time is hh:mm:ss, hh:mm:ssZ, or hh:mm:ss±hh:mm.

hh:mm:ss±hh:mm is used to represent a time with a time zone. The time zone is communicated as the number of hours offset from the Universal Time Coordinate (UTC), a.k.a. Greenwich Mean Time.

hh:mm:ssZ indicates the time at Zulu (another name for UTC). Based on the convention described in the next bullet it will be important for users within UTC to use "Z" when communicating a time in their time zone to other users.

hh:mm:ss or hh:mm indicates in the XML standard the time at UTC however, within papiNet it is used to represent the applicable local time. Caution should be used when processing times of this nature as the papiNet approach may be in discord with other users of XML.

ComponentShipDate

Date supplied component is expected to ship

(sequence)

The sequence of items below is mandatory. A single instance is required.

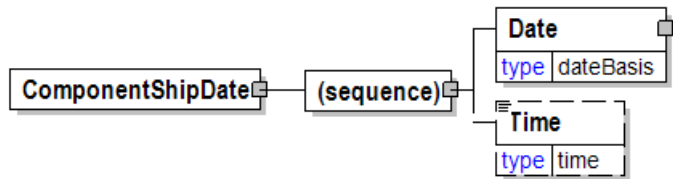

Date

Date is mandatory. A single instance is required.

A group element that contains the specification of Year, Month, and Day.

Time

Time is optional. A single instance might exist.

Times are treated in a standard XML fashion with a special case used to indicate a generalized "local" time. The standard XML approach to time is hh:mm:ss, hh:mm:ssZ, or hh:mm:ss±hh:mm.

hh:mm:ss±hh:mm is used to represent a time with a time zone. The time zone is communicated as the number of hours offset from the Universal Time Coordinate (UTC), a.k.a. Greenwich Mean Time.

hh:mm:ssZ indicates the time at Zulu (another name for UTC). Based on the convention described in the next bullet it will be important for users within UTC to use "Z" when communicating a time in their time zone to other users.

hh:mm:ss or hh:mm indicates in the XML standard the time at UTC however, within papiNet it is used to represent the applicable local time. Caution should be used when processing times of this nature as the papiNet approach may be in discord with other users of XML.

CompositeAndVeneerWoodPanels

A grouping element that contains the timbler/lumber products that comprise composite and veneer wood panels.

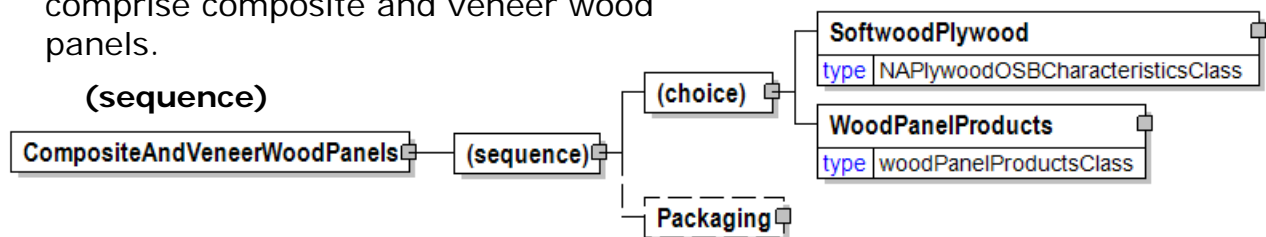

The sequence of items below is mandatory. A single instance is required.

(choice)

[choice] is optional because of choice construct.

SoftwoodPlywood

SoftwoodPlywood is optional because of choice construct.

Characteristics of wood panelling products.

WoodPanelProducts

WoodPanelProducts is optional because of choice construct.

Characteristics of wood panelling products.

Packaging

Packaging is optional. A single instance might exist.

Type of a package that includes individual products.

CompoundAgency [attribute]

The agency responsible for the compound coding.
Defines the trade name of the treatment.

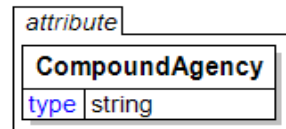

CompoundType [attribute]

Defines the type of chemical treatment used.

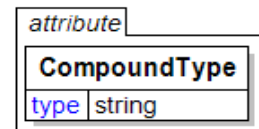

ConcernIndicatorType [attribute]

Either "Yes" or "No".

This item is restricted to the following list.

Yes

No

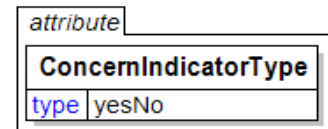

ConstructionPackagesAndPreFabPanels

A grouping element that contains the timber/lumber products that comprise construction packages and pre-fabricated panels.

(sequence)

The

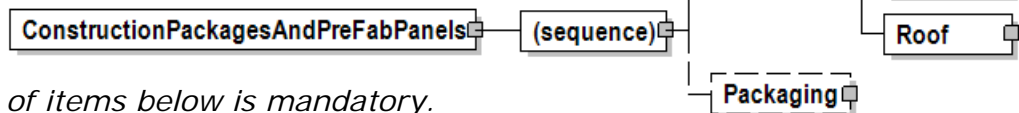

*sequence of items below is mandatory.
A single instance is required.*

(choice)

[choice] is optional because of choice construct.

Floor

Floor is optional because of choice construct.

Defines parts and complete flooring systems.

Wall

Wall is optional because of choice construct.

Defines parts and complete wall systems.

Roof

Roof is optional because of choice construct.

Defines parts and complete roofing systems.

Packaging

Packaging is optional. A single instance might exist.

Type of a package that includes individual products.

ConsumptionProcess

Identifies the process relevant to the situation being described.

ConsumptionProcess	
type	printType

This item is restricted to the following list.

ColdsetOffset

An offset printing method suitable for newspapers, in other words, ink dries by penetration into the paper.

ContinuousForms

An offset printing method, generally without a hot drying section and suitable for reels.

Digital

An electrostatic printing method, typically a large black-and-white or multicolour printer/copier.

Flexography

A special printing method, which is a follow-up of letter print with advanced print cylinder surface. Suitable for sheets.

FoilPrint

A special printing/finishing method suitable for foils through embossed print plate/cylinder; flat/flat, or circle/flat (form to sheet).

Forms

An offset printing method, generally without a hot drying section and suitable for sheets.

Gravure

A standard printing method with embossed print cylinders. Suitable for sheets.

HeatsetOffset

An offset printing method.

InkJet

An inkjet printing method, typically a large black-and-white or multicolour printer.

InstantOffset

A standard flat printing method (for example, wet offset, or waterless offset) suitable for small print orders and small sheet sizes (for example, max. DIN A3).

Laser

A laser-based printing method, typically a large black-and-white or multicolour printer/copier.

Letterpress

A special printing method suitable for books or newspapers (old style) with advanced letters. Suitable for sheets.

LightPrint

- A printing method similar to a facsimile print, a photo-like print with a specific prepared cylinder surface on photo basis or an artificial print.

MiniWeb

A digital printing method suitable for reels less than 20 inch wide.

RotoFlexography

RotoGravure

RotoLetterpress

RotoSilkScreen

SheetfedOffset

SilkScreen

WebOffset

ContactIdentifier

The identifier for the contact.

ContactIdentifierType [attribute]

*ContactIdentifierType is mandatory.
A single instance is required.*

Indicates which particular identifier is being communicated.

Refer to ContactIdentifierType definition for any enumerations.

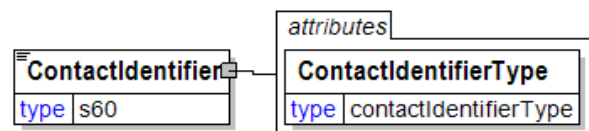

ContactIdentifierType [attribute]

Indicates which particular identifier is being communicated.

This item is restricted to the following list.

DriverLicenseID

PassportID

PersonalID

Other

PasportID

To be deprecated. Use PassportID. This enumeration had a spelling error.



ContactName

The name of the individual associated with the ContactType.

ContactName
type s60

ContactType [attribute]

Identifies the role of the contact within the party.

This item is restricted to the following list.

attribute
ContactType
type contactType

AccountManager

The person who manages the account for the seller or service provider.

Carrier

This contact person identified in the transaction works for a carrier.

CrossDock

This contact person identified in the transaction works at a cross-docking terminal/warehouse.

CustomerService

This contact person identified in the transaction works for the customer service department of the supplying company.

ForestForwarder

The contact responsible for transporting forest wood products from logging areas to roadside landings.

ForestHarvester

The contact responsible for harvesting of forest wood products.

Forwarder

The contact for freight forwarding.

HelpDesk

The contact within the trading partner arrangement who services information related requests.

Measurer

The contact that is doing the measurements.

Merchant

This contact person identified in the transaction works for a merchant.

Mill

The paper or pulp mill involved in the transaction.

OriginalSupplier

The contact for the first supplier in a supply chain.

Plant

This contact person identified in the transaction works at the plant.

Purchaser

This contact person identified in the transaction works for the entity that is requesting the product.

RemitTo

This contact person identified in the transaction works for the entity to which payment is to be made.

SalesOffice

This contact person identified in the transaction works for a sales office.

Supervisor

A contact that direct or oversee performance or operation.

Supplier

The contact for the organisation or business entity responsible for providing the product.

TransportPlanner

The person responsible for planning the transports.

TransportVehicle

Contact information for the transport vehicle involved in the transaction.

Warehouse

This contact person identified in the transaction works at a warehouse.

Other

This contact person identified in the transaction works for someone other than the entity types defined in the attribute list.

ConversionCode

A code, as assigned by an Agency, used to identify a group of conversion characteristics.

Agency [attribute]

Agency is mandatory. A single instance is required.

Describes the agency maintaining the list of codes. To be included in this list the agency must be a recognized standards body or industry organisation.

For the element that owns this attribute.

For another attribute in the list of attributes associated with the parent element.

Refer to Agency definition for any enumerations.

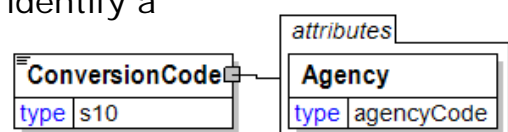

CoordinateFormatType [attribute]

CoordinateFormatType defines the format of the string containing the co-ordinates.

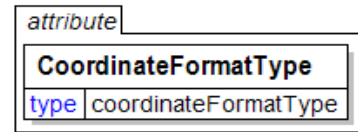

This item is restricted to the following list.

Degrees

Latitude and Longitude given in decimal degrees according to ISO Standard 6709. Format: $\pm DD.DDDD\pm DDD.DDDD$

More info at http://www.iso.org/iso/iso_catalogue.htm

DegreesMinutes

Latitude and Longitude given in degrees and decimal minutes according to ISO Standard 6709. Format: $\pm DDMM.MMM\pm DDDMM.MMM$

More info at http://www.iso.org/iso/iso_catalogue.htm

DegreesMinutesSeconds

Latitude and Longitude given in degrees, minutes and decimal seconds according to ISO Standard 6709. Format: $\pm DDMMSS.SS\pm DDDMMSS.SS$

More info at http://www.iso.org/iso/iso_catalogue.htm

XY

X- and Y- co-ordinate separated by the space-character.

ZoneXY

Zone, X- and Y- co-ordinate separated by space-characters.

Coordinates

Contains the position co-ordinates of a location.

CoordinateFormatType [attribute]

*CoordinateFormatType is mandatory.
A single instance is required.*

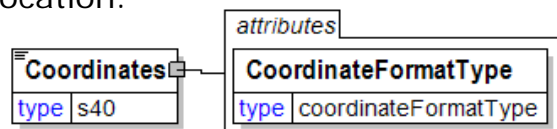

CoordinateFormatType defines the format of the string containing the co-ordinates.

Refer to CoordinateFormatType definition for any enumerations.

CoreCharacteristics

A group item that details information used to fully define a core.

CoreEndType [attribute]

CoreEndType is optional. A single instance might exist.

Describes how the core ends are made.

Refer to CoreEndType definition for any enumerations.

CoreMaterialType [attribute]

CoreMaterialType is optional. A single instance might exist.

Specifies the material out of which the core is made.

Refer to CoreMaterialType definition for any enumerations.

(sequence)

The sequence of items below is mandatory. A single instance is required.

CoreCode

CoreCode is optional. A single instance might exist.

A code defining details for a core

CoreDiameterInside

CoreDiameterInside is optional. A single instance might exist.

The diameter of the core's inner circle.

CoreDiameterOutside

CoreDiameterOutside is optional. A single instance might exist.

The diameter of the core's outer circle.

CoreStrengthCode

CoreStrengthCode is optional. A single instance might exist.

CoreStrengthCode is a composite of critical speed, flexural and crush strength of a fibre core, as defined by the indicated Agency.

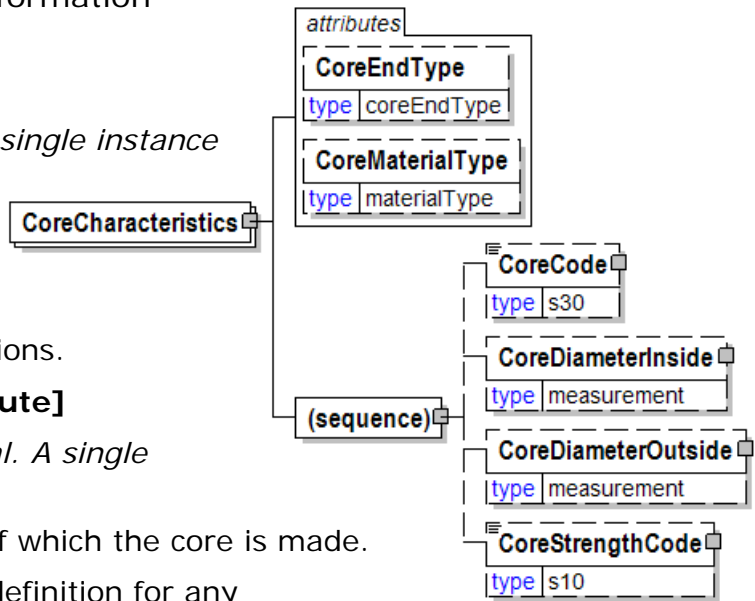

CoreCode

A code defining details for a core

Agency [attribute]

Agency is mandatory. A single instance is required.

Describes the agency maintaining the list of codes. To be included in this list the agency must be a recognized standards body or industry organisation.

For the element that owns this attribute.

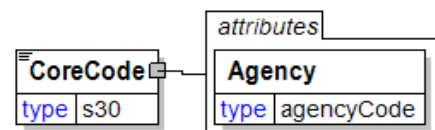

For another attribute in the list of attributes associated with the parent element.

Refer to Agency definition for any enumerations.

CoreDiameterInside

The diameter of the core's inner circle.

(sequence)

The sequence of items below is mandatory. A single instance is required.

Value

Value is mandatory. A single instance is required.

A numeric value expressed in the unit of measure (UOM).

RangeMin

RangeMin is optional. A single instance might exist.

The minimum value (lower boundary) allowed for the Measurement that is the parent of this element.

RangeMax

RangeMax is optional. A single instance might exist.

The maximum value (upper boundary) allowed for the Measurement that is the parent of this element. Some elements use the RangeMax element with an extended list of unit of measures. (Note: the red colour in the picture is an artifact of how the graphic was captured and should be disregarded.)

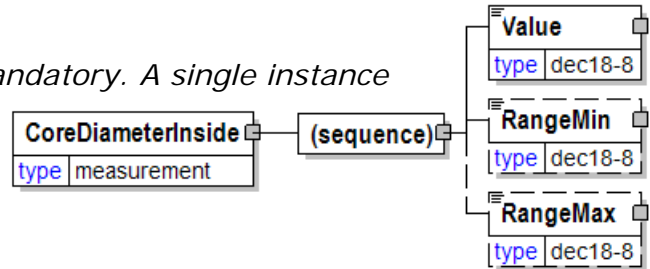

CoreDiameterOutside

The diameter of the core's outer circle.

(sequence)

The sequence of items below is mandatory. A single instance is required.

Value

Value is mandatory. A single instance is required.

A numeric value expressed in the unit of measure (UOM).

RangeMin

RangeMin is optional. A single instance might exist.

The minimum value (lower boundary) allowed for the Measurement that is the parent of this element.

RangeMax

RangeMax is optional. A single instance might exist.

The maximum value (upper boundary) allowed for the Measurement that is the parent of this element. Some elements use the RangeMax element with an extended list of unit of measures. (Note: the red colour in the picture is an artifact

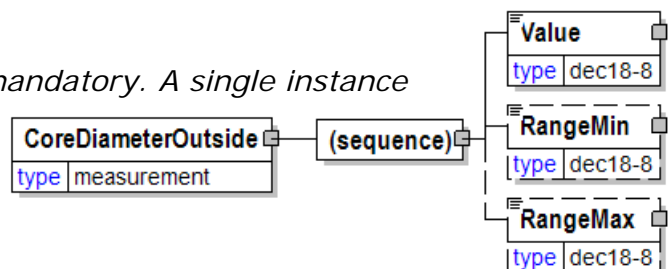

of how the graphic was captured and should be disregarded.)

CoreEndType [attribute]

Describes how the core ends are made.

This item is restricted to the following list.

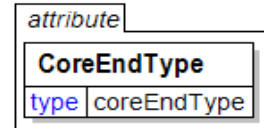

Adaptor

The Adaptor type is where the end type is adaptable to a 6 inch or 3 inch core diameter. (Spelling validated with core manufacturers.)

Bevelled

The core end is beveled. A grinding wheel has been used to grind down the inside of the core right at the end to enable an easier mounting of the core onto the shaft or the chucks. This is also called a beveled end cut. (Improper spelling noted but will be retained as enumeration choice for backward compatibility.)

Bridge

The core end has a notch that is cut on the inside of the core that is tapered and does not go through the core to edge; this is done so the core can be grasped by a particular type of core chuck on a reel arm on a press. Similar to a tapered core.

HalfMetal

The core is half metal.

Notched

The core end has a notch. Notch can be used to drive the core by the press operator or by manufacturing.

NotchedFullMetal

The core end has a notch. Core end is reinforced with metal cap.

Plain

The core end is smooth, not notched.

PlainFullMetal

The core end has no notch; end is reinforced with a metal tip.

Tapered

The core end is tapered.

CoreMaterialType [attribute]

Specifies the material out of which the core is made.

This item is restricted to the following list.

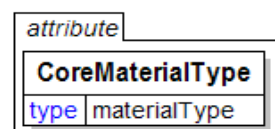

Aluminium

The reel core is made of aluminium.

Composite

The reel core is made up of a composite of materials, not entirely of fibre content.

Fibre

The reel core is made of fibre.

Iron

The reel core is made of iron.

Paper

The reel core is made of paper.

Plastic

The reel core is made of plastic.

Steel

The reel core is made of steel.

CorePlugs

An element that indicates if plugs are to be inserted into the ends of the core. Core plugs can be made of various materials and are used to protect the core ends.

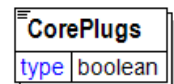

Note: A conversion error took place between Version 1.0 of papiNet and Version 2.0 of papiNet and this item was inadvertently converted from true/false (1.0) to nni1 (2.0). This item has been reinstated to a boolean value. However, please note that for reasons of backward compatibility it is highly recommended that you use the 1/0 approach to communicating true or false where 1 = true and 0 = false. Our apologies for any issues.

CoreStrengthCode

CoreStrengthCode is a composite of critical speed, flexural and crush strength of a fibre core, as defined by the indicated Agency.

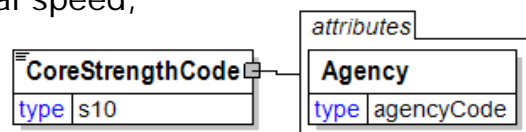

Agency [attribute]

Agency is mandatory. A single instance is required.

Describes the agency maintaining the list of codes. To be included in this list the agency must be a recognized standards body or industry organisation.

For the element that owns this attribute.

For another attribute in the list of attributes associated with the parent element.

Refer to Agency definition for any enumerations.

CorrectiveAction

This element enables the party issuing the ComplaintResponse (i.e. SupplierParty) to specify what is the corrective action they will take in order to close the Complaint (send a credit, send disposition instructions, etc.)

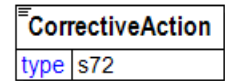

CostComponent

A group item that contains information relevant to the freight cost codes.

(sequence)

The sequence of items below is mandatory. A single instance is required.

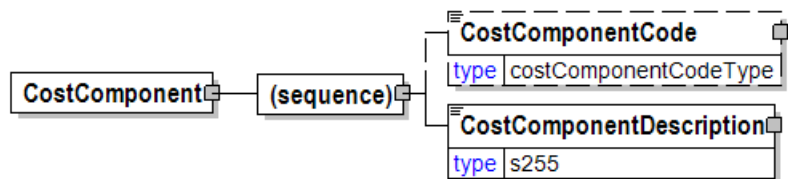

CostComponentCode

CostComponentCode is optional. A single instance might exist.

An element that communicates a code for the cost component.

For specification of logistics services it is recommended to use UN/ECE as the agency for the cost component code. Currently UN/ECE codes are freight cost codes established according to the UN Freight Cost Code Recommendation N°. 23, which can be found at www.unece.org/cefact/recommendations/rec_index.htm. The current version (at the time of this publication) can be found at www.unece.org/cefact/recommendations/rec23fcc_rev1_030623.pdf.

It is anticipated that additional UN/ECE cost component codes will be added as they become available.

CostComponentDescription

CostComponentDescription is mandatory. A single instance is required.

The description of the cost component.

CostComponentCode

An element that communicates a code for the cost component.

For specification of logistics services it is recommended to use UN/ECE as the agency for

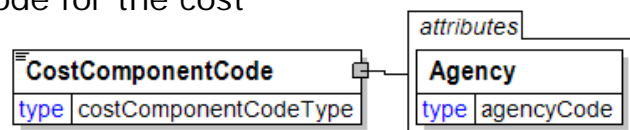

the cost component code. Currently UN/ECE codes are freight cost codes established according to the UN Freight Cost Code Recommendation N°. 23, which can be found at www.unece.org/cefact/recommendations/rec_index.htm. The current version (at the time of this publication) can be found at www.unece.org/cefact/recommendations/rec23fcc_rev1_030623.pdf.

It is anticipated that additional UN/ECE cost component codes will be added as they become available.

Agency [attribute]

Agency is mandatory. A single instance is required.

Describes the agency maintaining the list of codes. To be included in this list the agency must be a recognized standards body or industry organisation.

For the element that owns this attribute.

For another attribute in the list of attributes associated with the parent element.

Refer to Agency definition for any enumerations.

CostComponentDescription

The description of the cost component.

Language [attribute]

Language is optional. A single instance might exist.

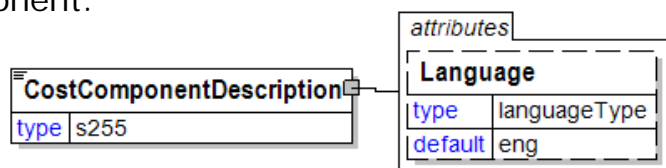

XML has embraced 2 and 3

digit language codes through the application of an addendum to the standard.

Refer to Language definition for any enumerations.

Country

The name of the country associated with the address elements. To ensure reliable matching of addresses, it is suggested to use the attribute ISOCountryCode as well.

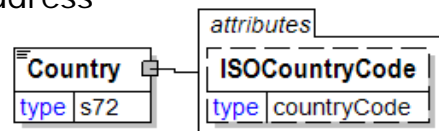

ISOCountryCode [attribute]

ISOCountryCode is optional. A single instance might exist.

The valid list of ISO Country Codes.

Refer to ISOCountryCode definition for any enumerations.

CountryOfConsumption

The country of consumption for the material.

(sequence)

The sequence of items below is mandatory. A single instance is required.

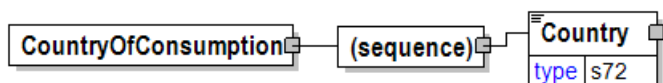

Country

Country is mandatory. A single instance is required.

The name of the country associated with the address elements. To ensure reliable matching of addresses, it is suggested to use the attribute ISOCountryCode as well.

CountryOfDestination

The country where the goods will be, or were, shipped to.

(sequence)

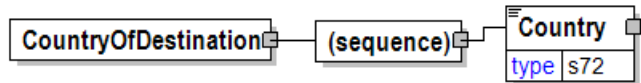

The sequence of items below is mandatory. A single instance is required.

Country

Country is mandatory. A single instance is required.

The name of the country associated with the address elements. To ensure reliable matching of addresses, it is suggested to use the attribute ISOCountryCode as well.

CountryOfOrigin

The country of origin for the material.

(sequence)

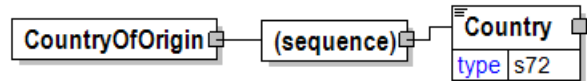

The sequence of items below is mandatory. A single instance is required.

Country

Country is mandatory. A single instance is required.

The name of the country associated with the address elements. To ensure reliable matching of addresses, it is suggested to use the attribute ISOCountryCode as well.

County

The name of the county that the address is in.

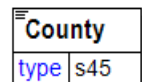

CreditDebitNote

The CreditDebitNote element is the root element for the CreditDebitNote e-Document.

The CreditDebitNote e-Document is generally used by the SupplierParty to compensate or charge the trading parties (ShipToParty, BuyerParty, OtherParty, etc.) for matters outside the scope of the Invoice.

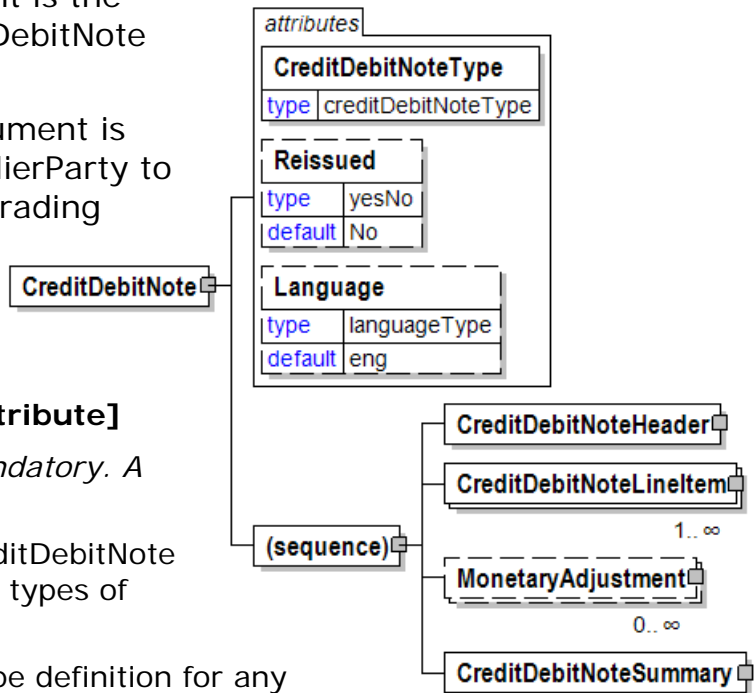

CreditDebitNoteType [attribute]

CreditDebitNoteType is mandatory. A single instance is required.

Defines the type of the CreditDebitNote e-Document. There are two types of CreditDebitNote Messages:

Refer to CreditDebitNoteType definition for any enumerations.

Reissued [attribute]

Reissued is optional. A single instance might exist.

Either "Yes" or "No".

Refer to Reissued definition for any enumerations.

Language [attribute]

Language is optional. A single instance might exist.

XML has embraced 2 and 3 digit language codes through the application of an addendum to the standard.

Refer to Language definition for any enumerations.

(sequence)

The sequence of items below is mandatory. A single instance is required.

CreditDebitNoteHeader

CreditDebitNoteHeader is mandatory. A single instance is required.

The CreditDebitNoteHeader contains information common to the CreditDebitNote

CreditDebitNoteLineItem

CreditDebitNoteLineItem is mandatory. One instance is required, multiple instances might exist.

CreditDebitLineItem contains the information about the Credit or Debit being issued.

MonetaryAdjustment

MonetaryAdjustment is optional. Multiple instances might exist.

The element containing the information necessary for the understanding, calculation, and treatment of an adjustment to a currency amount.

papiNet V2R31

MonetaryAdjustment contains an attribute that indicates the type of adjustment being communicated.

CreditDebitNoteSummary

CreditDebitNoteSummary is mandatory. A single instance is required.

Contains summary information that applies to the entire e-Document.

CreditDebitNoteAmountSubtotal

A field that contains the result of the calculation Quantity at the

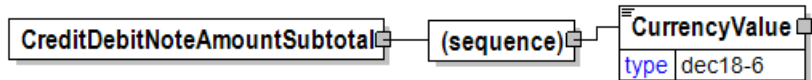

CreditDebitNoteLineItem level times the PricePerUnit.

(sequence)

The sequence of items below is mandatory. A single instance is required.

CurrencyValue

CurrencyValue is mandatory. A single instance is required.

The amount in the referenced currency as defined by the CurrencyType attribute.

CreditDebitNoteBaseAmountInformation

A group item containing the price per unit and the CreditDebitNote amount subtotal.

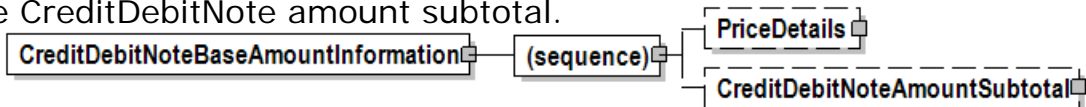

(sequence)

The sequence of items below is mandatory. A single instance is required.

PriceDetails

PriceDetails is optional. A single instance might exist.

An element that groups together price information.

CreditDebitNoteAmountSubtotal

CreditDebitNoteAmountSubtotal is optional. A single instance might exist.

A field that contains the result of the calculation Quantity at the CreditDebitNoteLineItem level times the PricePerUnit.

CreditDebitNoteDate

The issue date of the CreditDebitNote. This date often drives payment terms. Note that this date is not necessarily the same as the creation date of the CreditDebitNote.

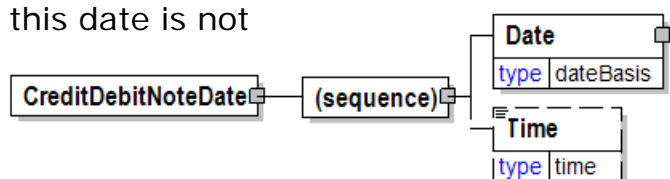

(sequence)

papiNet V2R31

The sequence of items below is mandatory. A single instance is required.

Date

Date is mandatory. A single instance is required.

A group element that contains the specification of Year, Month, and Day.

Time

Time is optional. A single instance might exist.

Times are treated in a standard XML fashion with a special case used to indicate a generalized "local" time. The standard XML approach to time is hh:mm:ss, hh:mm:ssZ, or hh:mm:ss±hh:mm.

hh:mm:ss±hh:mm is used to represent a time with a time zone. The time zone is communicated as the number of hours offset from the Universal Time Coordinate (UTC), a.k.a. Greenwich Mean Time.

hh:mm:ssZ indicates the time at Zulu (another name for UTC). Based on the convention described in the next bullet it will be important for users within UTC to use "Z" when communicating a time in their time zone to other users.

hh:mm:ss or hh:mm indicates in the XML standard the time at UTC however, within papiNet it is used to represent the applicable local time. Caution should be used when processing times of this nature as the papiNet approach may be in discord with other users of XML.

CreditDebitNoteHeader

The CreditDebitNoteHeader contains information common to the CreditDebitNote

(sequence)

The sequence of items below is mandatory. A single instance is required.

CreditDebitNoteNumber

CreditDebitNoteNumber is mandatory. A single instance is required.

The unique CreditDebitNote identifier as agreed to by the trading partners.

CreditDebitNoteDate

CreditDebitNoteDate is mandatory. A single instance is required.

The issue date of the CreditDebitNote. This date often drives payment terms. Note that this date is not necessarily the same as the creation date of the CreditDebitNote.

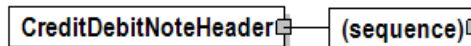

CreditDebitNoteReference

CreditDebitNoteReference is optional. Multiple instances might exist.

An element detailing relevant references pertaining to the CreditDebitNote. CreditDebitNoteReference uses the CreditDebitNoteReferenceType attribute.

CreditDebitNoteReason

CreditDebitNoteReason is mandatory. A single instance is required.

A group item containing the reason for the entire CreditDebitNote.

BillToParty

BillToParty is mandatory. A single instance is required.

The address where the Invoice is to be sent.

SupplierParty

SupplierParty is mandatory. A single instance is required.

The organisation or business entity responsible for providing the product. SupplierParty is also the seller of the product, if Seller is not specified as OtherParty = Seller.

BuyerParty

BuyerParty is optional. A single instance might exist.

The legal entity to which the product is sold. Also commonly referred to as the sold-to party or customer. If no OtherParty is defined as the Payer, the Buyer is the Payer.

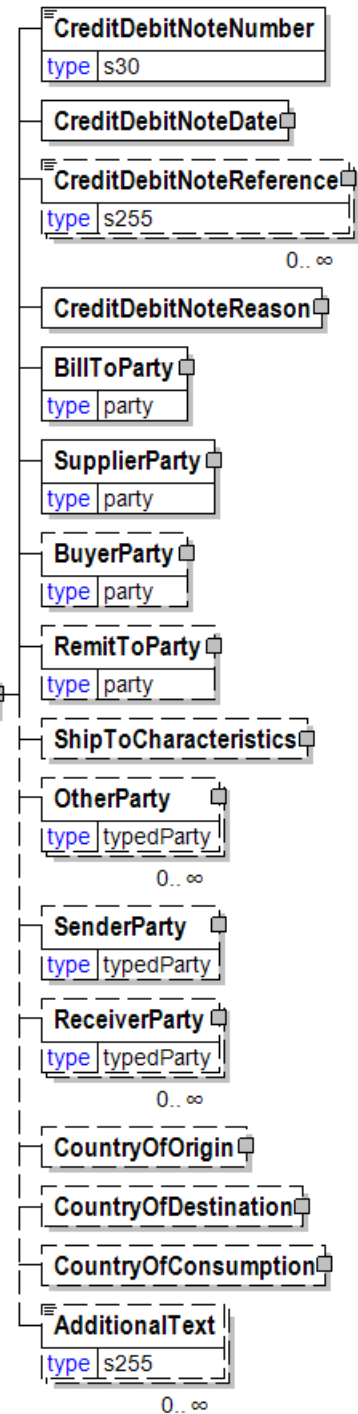

RemitToParty

RemitToParty is optional. A single instance might exist.

A group item containing details of the party to whom payment will be made. The RemitToParty contains all information related to remittance.

ShipToCharacteristics

ShipToCharacteristics is optional. A single instance might exist.

A group item that provides information important for the Ship-To Party.

A group item that provides information important for the Ship-To Party. ShipToCharacteristics may be referenced at both the header and line item level. The reference at the header is required and acts as a default for the value at the line level, unless overridden at the line level.

OtherParty

OtherParty is optional. Multiple instances might exist.

An organisation or business entity other than those specifically detailed within a e-Document.

SenderParty

SenderParty is optional. A single instance might exist.

The business entity issuing the e-Document, the source of the document.

The entity responsible for the content. If the sender party has out sourced the message service to a third party the SenderParty is the issuer of the e-Document and not the party performing the transmission service of the electronic message.

ReceiverParty

ReceiverParty is optional. Multiple instances might exist.

The business entity for whom the e-Document is intended, the destination of the document.

The entity interested in the content. If the receiver party has outsourced the message service to a third party the ReceiverParty is the intended party for the e-Document and not the party performing the receiving service of the electronic message.

CountryOfOrigin

CountryOfOrigin is optional. A single instance might exist.

The country of origin for the material.

CountryOfDestination

CountryOfDestination is optional. A single instance might exist.

The country where the goods will be, or were, shipped to.

CountryOfConsumption

CountryOfConsumption is optional. A single instance might exist.

The country of consumption for the material.

AdditionalText

AdditionalText is optional. Multiple instances might exist.

A text field that is used to communicate information not previously defined or for special instructions. To be used only for circumstances not covered by specific elements.

CreditDebitNoteLineAmount

The total CreditDebitNote amount per line (includes adjustments and tax)

(sequence)



The sequence of items below is mandatory. A single instance is required.

CurrencyValue

CurrencyValue is mandatory. A single instance is required.

The amount in the referenced currency as defined by the CurrencyType attribute.

CreditDebitNoteLineItem

CreditDebitLineItem contains the information about the Credit or Debit being issued.

(sequence)

The sequence of items below is mandatory. A single instance is required.

CreditDebitNoteLineItemNumber

CreditDebitNoteLineItemNumber is mandatory. A single instance is required.

A sequential number that uniquely identifies the CreditDebitNote line item.

(sequence)

The sequence of items below is optional. Multiple instances might exist.

PurchaseOrderInformation

PurchaseOrderInformation is mandatory. A single instance is required.

A group item containing information unique to this PurchaseOrder, which is provided by the buyer.

PurchaseOrderInformation can be optional in the supply chain. Invoices are created without having a PurchaseOrder in Vendor Managed Inventory. Freight invoices also will not have a PurchaseOrder number.

PurchaseOrderLineItemNumber

PurchaseOrderLineItemNumber is optional. Multiple instances might exist.

The sequential number that uniquely identifies the PurchaseOrder line item.

ChargeOrAllowance

ChargeOrAllowance is optional. A single instance might exist.

The description of the charge or allowance; such as freight, special handling, and stop-off handling.

Product

Product is optional. A single instance might exist.

Product is a group item defining the article and its characteristics. Product is used to specify product characteristics organized by ProductIdentifier, ProductDescription, and Classification. Book Manufacturing, Label Stock, Paper, Pulp, Recovered Paper, Wood Products, and Virgin Fibre market segments have defined their product characteristics and conversion features for implementation in papiNet.

Quantity

Quantity is optional. A single instance might exist.

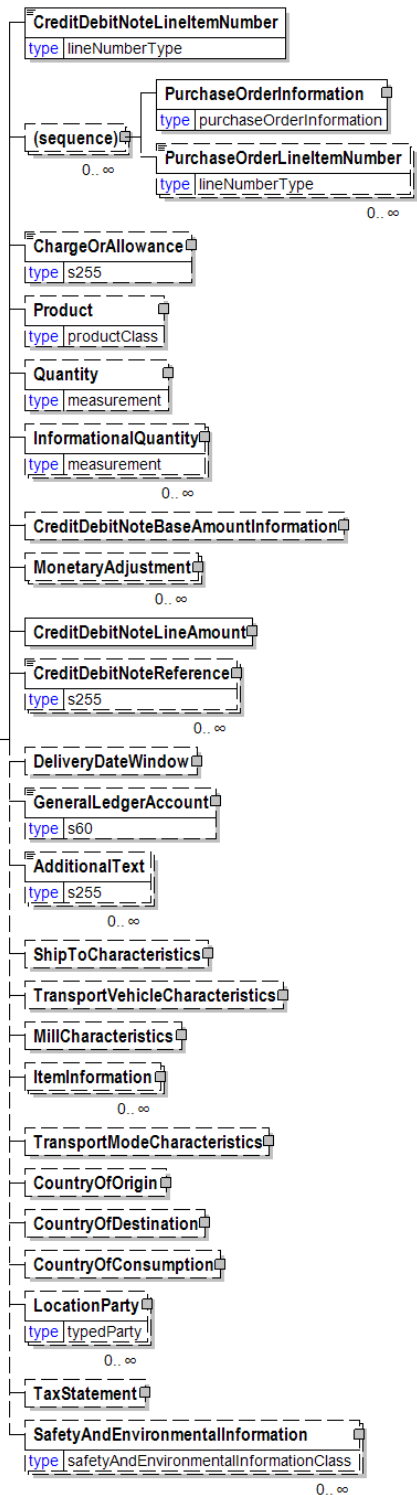

The Quantity element contains attributes that provide information about the type of quantity that is being communicated, the context in which the particular quantity is to be viewed, and (if the quantity represents an adjustment) an adjustment type.

The Quantity element contains three child elements that enable you to communicate a range of values for the quantity and a target or actual value. It is at this level (Value, RangeMin, and RangeMax) that the unit of measure is specified. This permits the range to be specified in a different unit of measure than the target.

InformationalQuantity

InformationalQuantity is optional. Multiple instances might exist.

A quantity given in a valid UOM used for information purposes only (not for calculation). For example, an ordered quantity was 100 reels as opposed to the invoice quantity of 20,000 pounds.

CreditDebitNoteBaseAmountInformation

CreditDebitNoteBaseAmountInformation is optional. A single instance might exist.

A group item containing the price per unit and the CreditDebitNote amount subtotal.

MonetaryAdjustment

MonetaryAdjustment is optional. Multiple instances might exist.

The element containing the information necessary for the understanding, calculation, and treatment of an adjustment to a currency amount. MonetaryAdjustment contains an attribute that indicates they type of adjustment being communicated.

CreditDebitNoteLineAmount

CreditDebitNoteLineAmount is mandatory. A single instance is required.

The total CreditDebitNote amount per line (includes adjustments and tax)

CreditDebitNoteReference

CreditDebitNoteReference is optional. Multiple instances might exist.

An element detailing relevant references pertaining to the CreditDebitNote. CreditDebitNoteReference uses the CreditDebitNoteReferenceType attribute.

DeliveryDateWindow

DeliveryDateWindow is optional. A single instance might exist.

A group item defining the date/time interval for delivery to take place. An element which may contain the estimated date for which delivery is expected. This date is not absolute.

GeneralLedgerAccount

GeneralLedgerAccount is optional. A single instance might exist.

The general ledger account to be referenced for the item.

AdditionalText

AdditionalText is optional. Multiple instances might exist.

A text field that is used to communicate information not previously defined or for special instructions. To be used only for circumstances not covered by specific elements.

ShipToCharacteristics

ShipToCharacteristics is optional. A single instance might exist.

A group item that provides information important for the Ship-To Party.

A group item that provides information important for the Ship-To Party. ShipToCharacteristics may be referenced at both the header and line item level. The reference at the header is required and acts as a default for the value at the line level, unless overridden at the line level.

TransportVehicleCharacteristics

TransportVehicleCharacteristics is optional. A single instance might exist.

A group item defining the primary means of transporting the goods, such as a side port vessel. In some instances, the transport unit and vehicle are the same.

MillCharacteristics

MillCharacteristics is optional. A single instance might exist.

A group item defining the mill party and machine identifier where a product is or was produced.

ItemInformation

ItemInformation is optional. Multiple instances might exist.

The purpose of the ItemInformation structure is to clearly identify physical items. The attribute ItemType defines the type of physical item. Physical items can be handling units like packages as well as items contained in packages.

TransportModeCharacteristics

TransportModeCharacteristics is optional. A single instance might exist.

A group item defining the primary mode of transport.

CountryOfOrigin

CountryOfOrigin is optional. A single instance might exist.

The country of origin for the material.

CountryOfDestination

CountryOfDestination is optional. A single instance might exist.

The country where the goods will be, or were, shipped to.

CountryOfConsumption

CountryOfConsumption is optional. A single instance might exist.

The country of consumption for the material.

LocationParty

LocationParty is optional. Multiple instances might exist.

The organization or business entity where the business event took place or will take place.

TaxStatement

TaxStatement is optional. A single instance might exist.

A group element for declaration of exception from normal charges of tax and the reason for tax exemption.

SafetyAndEnvironmentalInformation

SafetyAndEnvironmentalInformation is optional. Multiple instances might exist.

Name of certification type, if any, on the goods (For example, FSC, PEFC). SafetyAndEnvironmental needs a value or measurement to communicate the percentage of the product is certified (for example, 75% is certified by the

indicated agency).

CreditDebitNoteLineItemNumber

A sequential number that uniquely identifies the CreditDebitNote line item.

CreditDebitNoteLineItemNumber	
type	lineNumberType

CreditDebitNoteNumber

The unique CreditDebitNote identifier as agreed to by the trading partners.

CreditDebitNoteNumber	
type	s30

CreditDebitNoteReason

A group item containing the reason for the entire CreditDebitNote.

(sequence)

The sequence of items below is mandatory. A single instance is required.

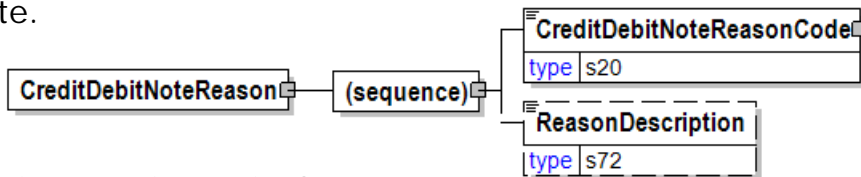

CreditDebitNoteReasonCode

CreditDebitNoteReasonCode is mandatory. A single instance is required.

A selection of one of the valid reasons for creating a CreditDebitNote.

ReasonDescription

ReasonDescription is optional. A single instance might exist.

Text associated with a particular ReasonIdentifier

CreditDebitNoteReasonCode

A selection of one of the valid reasons for creating a CreditDebitNote.

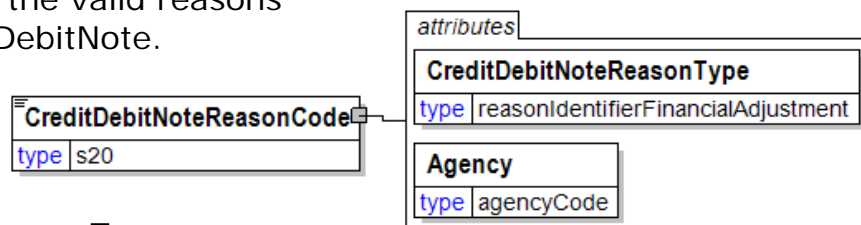

CreditDebitNoteReasonType [attribute]

CreditDebitNoteReasonType is mandatory. A single instance is required.

Describes the type of reasons associated with the CreditDebitNote.

Refer to CreditDebitNoteReasonType definition for any enumerations.

Agency [attribute]

Agency is mandatory. A single instance is required.

Describes the agency maintaining the list of codes. To be included in this list the agency must be a recognized standards body or industry organisation.

For the element that owns this attribute.

For another attribute in the list of attributes associated with the parent element.

Refer to Agency definition for any enumerations.

CreditDebitNoteReasonType [attribute]

Describes the type of reasons associated with the CreditDebitNote.

This item is restricted to the following list.

Claim

Commission

InvoiceError

Rebate

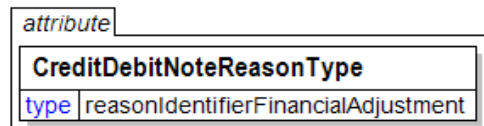

CreditDebitNoteReference

An element detailing relevant references pertaining to the CreditDebitNote.

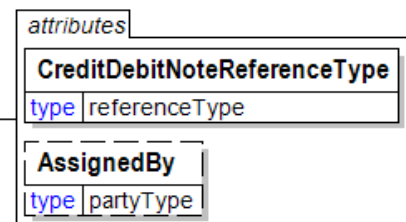
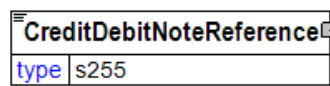

CreditDebitNoteReference uses the CreditDebitNoteReferenceType attribute.

CreditDebitNoteReferenceType [attribute]

CreditDebitNoteReferenceType is mandatory. A single instance is required.

Provides a contextual explanation of the specific reference identifier. Many items are currently prefixed by "Buyer", "Forwarder", "Manufacturer", "Mill", "Seller", "Supplier", "Warehouse", or "Vendor". Check for an existing non-prefixed version and use the non-prefixed version instead. In the (yet to be announced release date) version 3.0 the prefixed versions will be removed. Instead the attribute @AssignedBy will communicate the information previously communicated in the prefix.

Refer to CreditDebitNoteReferenceType definition for any enumerations.

AssignedBy [attribute]

AssignedBy is optional. A single instance might exist.

Identifies the type of party that has assigned the associated item, e.g. a reference of type OrderNumber.

Refer to AssignedBy for any enumerations.

CreditDebitNoteReferenceType [attribute]

Provides a contextual explanation of the specific reference identifier. Many items are currently prefixed by "Buyer", "Forwarder", "Manufacturer", "Mill", "Seller", "Supplier", "Warehouse", or "Vendor". Check for an

existing non-prefixed version and use the non-prefixed version instead. In the (yet to be announced release date) version 3.0 the prefixed versions will be removed. Instead the attribute @AssignedBy will communicate the information previously communicated in the prefix.

Refer to the [referenceType](#) entry for the list of enumerations and their definitions.

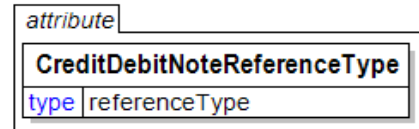

CreditDebitNoteSummary

Contains summary information that applies to the entire e-Document.

(sequence)

The sequence of items below is mandatory. A single instance is required.

TotalNumberOfLineItems

TotalNumberOfLineItems is optional. A single instance might exist.

The total number of individual line items in the document, regardless of the status or type.

(sequence)

The sequence of items below is optional. Multiple instances might exist.

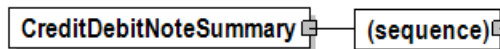

TotalQuantity

TotalQuantity is mandatory. A single instance is required.

The total quantity of similar items in the e-Document. TotalQuantity is primarily used in the summary section of documents where it is repeatable to permit totaling for different units of measure.

TotalInformationalQuantity

TotalInformationalQuantity is optional. Multiple instances might exist.

A quantity that is used to

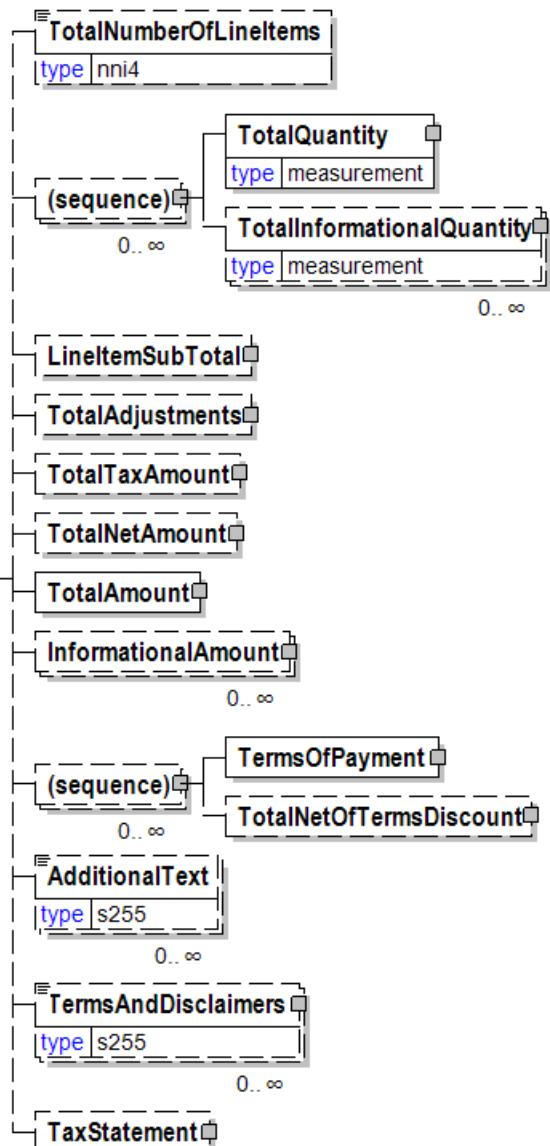

communicate related information about the parent element. This element represents a total that is derived from individual line items.

LineItemSubTotal

LineItemSubTotal is optional. A single instance might exist.

The total amount of all e-Document LineBaseAmount(s) line items without any monetary adjustments that may occur after the e-Document line items.

TotalAdjustments

TotalAdjustments is optional. A single instance might exist.

The CurrencyValue of TotalAdjustments contains the total of all MonetaryAdjustmentAmount for all instances of PriceAdjustment and FlatAmountAdjustment in the document (it excludes TaxAdjustments).

TotalTaxAmount

TotalTaxAmount is optional. A single instance might exist.

The CurrencyValue of TotalTaxAmount contains the sum of all instances of TaxAdjustment in the document. TotalTaxAmount contains the sum of all instances of the MonetaryAdjustmentAmount for tax adjustments.

TotalNetAmount

TotalNetAmount is optional. A single instance might exist.

A field containing total amount excluding tax. For example, in the Invoice TotalNetAmount is equal to the sum of LineItemSubTotal plus TotalAdjustments. TotalNetAmount encapsulates CurrencyValue.

TotalAmount

TotalAmount is mandatory. A single instance is required.

The total amount including tax.

In e-Documents claiming payment this is the amount due for payment based on the terms of payment. Decimal rounding might be applied to this amount.

InformationalAmount

InformationalAmount is optional. Multiple instances might exist.

A monetary amount used for information purposes only (not for calculation). For example, the invoice price adjustment subtotal is expressed in sterling pounds, and the buyer wants this information expressed in U.S. dollars.

CreditDebitNote and Invoice - The TaxAmount is displayed in the currency that is applicable throughout the e-Document. When a TaxAmount needs to be displayed in a different national currency, this field is used.

(sequence)

The sequence of items below is optional. Multiple instances might exist.

TermsOfPayment

TermsOfPayment is mandatory. A single instance is required.

A group item that contains agreed-to terms defining when, how, and under what conditions the payment is to be made.

When TermsOfPayment is optional; if omitted, TermsOfPayment is controlled through previous negotiation.

TotalNetOfTermsDiscount

TotalNetOfTermsDiscount is optional. A single instance might exist.

papiNet V2R31

The components of the amount to be paid if prompt payment discount terms are met, including the amount that is subject to the payment terms discount, the discount amount, and the amount due after prompt payment discount.

AdditionalText

AdditionalText is optional. Multiple instances might exist.

A text field that is used to communicate information not previously defined or for special instructions. To be used only for circumstances not covered by specific elements.

TermsAndDisclaimers

TermsAndDisclaimers is optional. Multiple instances might exist.

An element that contains legal information with an indication of what the Language is.

TaxStatement

TaxStatement is optional. A single instance might exist.

A group element for declaration of exception from normal charges of tax and the reason for tax exemption.

CreditDebitNoteType [attribute]

Defines the type of the CreditDebitNote e-Document. There are two types of CreditDebitNote Messages:

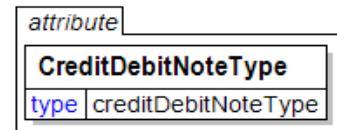

This item is restricted to the following list.

CreditNote

Credits that are provided for amount reductions and complaints. A CreditNode will normally have a reference to an earlier issued Invoice.

DebitNote

A DebitNote claims payment for additional charges. A DebitNote normally has a reference to an earlier issued Invoice.

CurrencyFromType [attribute]

The from currency in an exchange.

A three-character ISO 4217 currency code in capital letters. The ISO standard classification for currencies.



CurrencyType [attribute]

A three-character ISO 4217 currency code in capital letters. The ISO standard classification for currencies.

A three-character ISO 4217 currency code in capital letters. The ISO standard classification for currencies. Refer to the ISO standard for information about the choices for the attribute's enumerations.



CurrencyValue

The amount in the referenced currency as defined by the CurrencyType attribute.

CurrencyType [attribute]

CurrencyType is mandatory. A single instance is required.

A three-character ISO 4217 currency code in capital letters. The ISO standard classification for currencies.

Refer to CurrencyType definition for any enumerations.

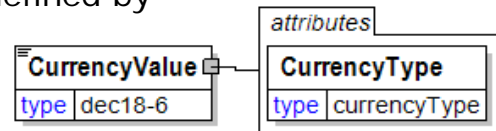

CustomerMarks

The text that the buyer wants the seller to print on the package label or elsewhere.

CustomerMarksType [attribute]

CustomerMarksType is optional.

Specifies the content type of customer marks

Refer to CustomerMarksType definition for any enumerations.

AssignedBy [attribute]

AssignedBy is optional.

Identifies the type of party that has assigned the associated item, e.g. a reference of type OrderNumber.

Refer to AssignedBy definition for any enumerations.

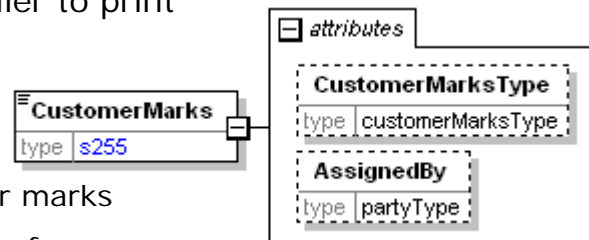

CustomerMarksType [attribute]

Specifies the content type of customer marks.

This item is restricted to the following list.

Author

Name of the author of the product or book

BasisWeight

The weight of the paper expressed as a mass for a given surface area.

BoxWeight

Weight of the filled box.

BrandName

A specific product brand name for which the owner or source is specified in the "@AssignedBy" attribute

Copyright



The year of publication copyright.

Edition

Identifies the version of the product for which copies were printed and published at one time; For example in book manufacturing values might be 1st, 2nd, etc

ExportShipMark

An export shipment mark for identification.

GradeCode

A specific product code for which the owner or source is specified in the "@AssignedBy" attribute

GradeName

A specific product name for which the owner or source is specified in the "@AssignedBy" attribute (for example, ImprovedNewsprint-45-1479)

Identifier

Identifier of the individual item.

ISBN10

10 digit ISBN code without dashes.

ISBN10Dash

10 digit ISBN code with dashes.

ISBN13

13 digit ISBN code.

ISBN13Dash

A 13 character ISBN with dashes.

LotIdentifier

A unique code used to identify a grouping of product with one set of quality statistics common to all members of that group. Synonym: Lot Number.

PartNumber

An equivalent to the Stock Keeping Unit (SKU) for which the owner or source is specified in the "@AssignedBy" attribute. In other words, this code fully defines the product.

PrintingNumber

A reference to the sequential print run number.

ProfitCenter

Profit Center identifier.

PubName

The publication name.

PurchaseOrderNumber

The unique order identifier as designated by the customer.

ReferenceNumber

An informational reference (either textual or numeric) for which the owner or

source is specified in the "@AssignedBy" attribute.

RetailPrice

Cover price of the finished product.

TambourID

The unique identifier of the jumbo reel (also called mother reel or Tambour).

Title

Proper title of a book product.

TitleAlias

Alternate title description for book products, usually for security purposes.

UnitsPerCarton

Number of units per box.

UniversalProductIdentifier

Unique identifier for the book, component of a book product, and many other products.

CustomsParty

The party responsible for customs arrangements.

LogisticsRole [attribute]

LogisticsRole is optional. A single instance might exist.

Communicates the nature of the logistics role, if any, the party plays in the transaction.

Refer to LogisticsRole definition for any enumerations.

(sequence)

The sequence of items below is mandatory. A single instance is required.

PartyIdentifier

PartyIdentifier is optional. Multiple instances might exist.

A unique identifier of a specific party. This element contains an attribute PartyIdentifierType that indicates the type of party.

NameAddress

NameAddress is mandatory. A single instance is required.

A group item containing name and address of an organisation or business entity.

URL

URL is optional. A single instance might exist.

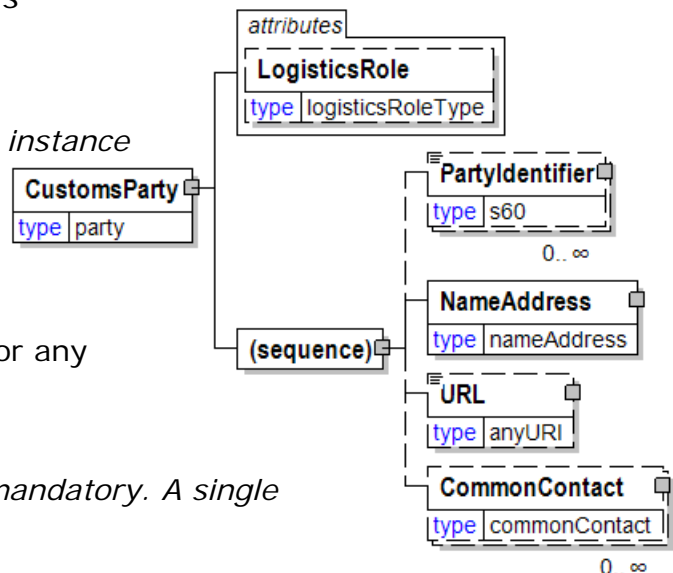

Universal Resource Locator. While typically a web address you could use this field to hold an email address.

CommonContact

CommonContact is optional. Multiple instances might exist.

Identifies a specific individual associated with the party.

CustomsReferenceNumber

A reference that applies to customs arrangements.

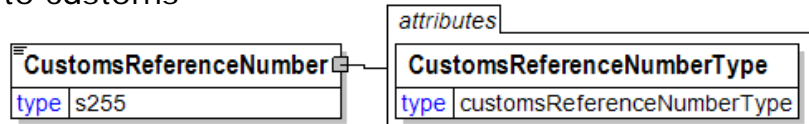

CustomsReferenceNumberType [attribute]

CustomsReferenceNumberType is mandatory. A single instance is required.

The type of customs reference number.

Refer to CustomsReferenceNumberType definition for any enumerations.

CustomsReferenceNumberType [attribute]

The type of customs reference number.

This item is restricted to the following list.

T2L

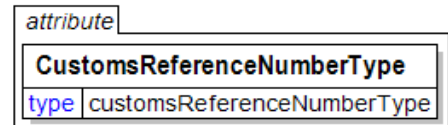

SimplifiedCustomsClearanceLicenseNumber

CustomsStampDate

The date of the customs stamp.

(sequence)

The sequence of items below is mandatory. A single instance is required.

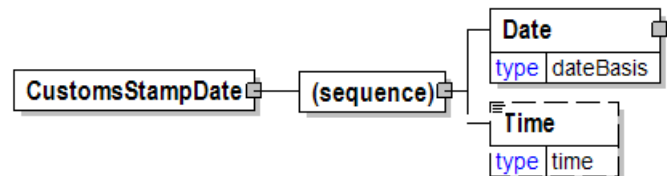

Date

Date is mandatory. A single instance is required.

A group element that contains the specification of Year, Month, and Day.

Time

Time is optional. A single instance might exist.

Times are treated in a standard XML fashion with a special case used to indicate a generalized "local" time. The standard XML approach to time is hh:mm:ss, hh:mm:ssZ, or hh:mm:ss±hh:mm.

hh:mm:ss±hh:mm is used to represent a time with a time zone. The time zone is communicated as the number of hours offset from the Universal Time Coordinate (UTC), a.k.a. Greenwich Mean Time.

papiNet V2R31

hh:mm:ssZ indicates the time at Zulu (another name for UTC). Based on the convention described in the next bullet it will be important for users within UTC to use "Z" when communicating a time in their time zone to other users.

hh:mm:ss or hh:mm indicates in the XML standard the time at UTC however, within papiNet it is used to represent the applicable local time. Caution should be used when processing times of this nature as the papiNet approach may be in discord with other users of XML.

CustomsStampHeaderText

Text to be applied prior to the customs stamp.

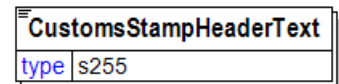

CustomsStampInformation

A grouping element that organises the information for customs.

(sequence)

The sequence of items below is mandatory. A single instance is required.

CustomsStampHeaderText

CustomsStampHeaderText is optional. Multiple instances might exist.

Text to be applied prior to the customs stamp.

CustomsParty

CustomsParty is optional. A single instance might exist.

The party responsible for customs arrangements.

CustomsStampDate

CustomsStampDate is optional. A single instance might exist.

The date of the customs stamp.

CustomsReferenceNumber

CustomsReferenceNumber is optional. A single instance might exist.

A reference that applies to customs arrangements.

SupplierCustomsReference

SupplierCustomsReference is optional. A single instance might exist.

Supplier Customs Reference

MillParty

MillParty is optional. A single instance might exist.

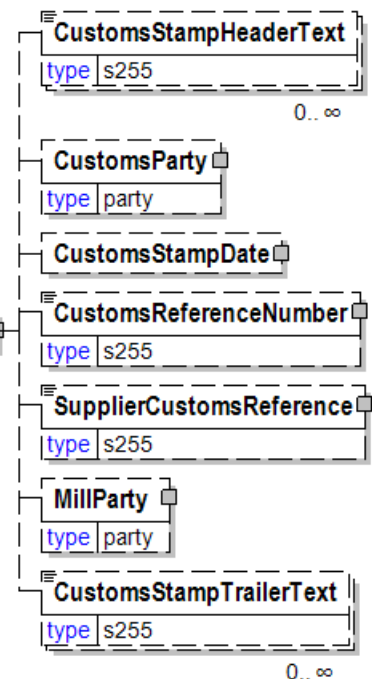

The organisation or business entity that actually produces the product.

CustomsStampTrailerText

CustomsStampTrailerText is optional. Multiple instances might exist.

Text to be applied after the customs stamp.

CustomsStampTrailerText

Text to be applied after the customs stamp.

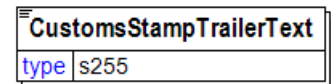

CustomsTariffCode

The tariff code for customs purposes.

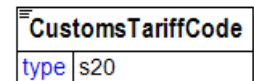

CustomsTotals

A grouping element for customs total information.

(sequence)

The sequence of items below is mandatory. A single instance is required.

CustomsTariffCode

CustomsTariffCode is mandatory. A single instance is required.

The tariff code for customs purposes.

TotalQuantity

TotalQuantity is mandatory. A single instance is required.

The total quantity of similar items in the e-Document. TotalQuantity is primarily used in the summary section of documents where it is repeatable to permit totaling for different units of measure.

InformationalQuantity

InformationalQuantity is optional. Multiple instances might exist.

A quantity given in a valid UOM used for information purposes only (not for calculation). For example, an ordered quantity was 100 reels as opposed to the invoice quantity of 20,000 pounds.

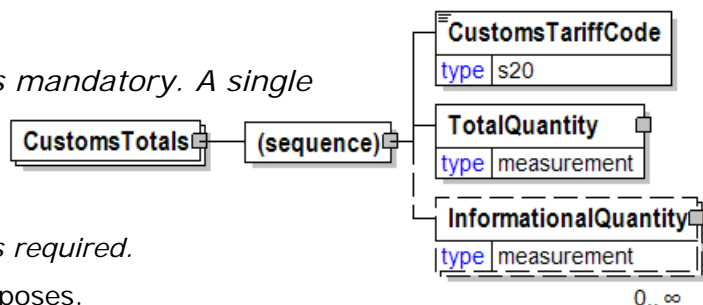

CuttingDetails

Cutting Details provides information on how to cut the sheet.

(sequence)

The sequence of items below is mandatory. A single instance is required.

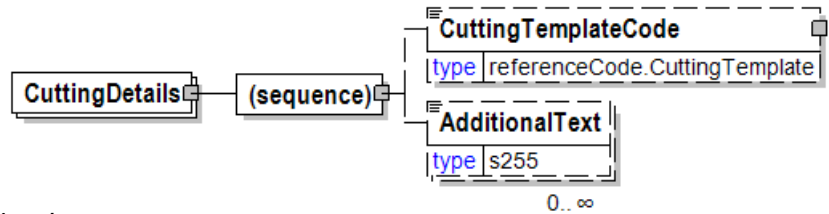

CuttingTemplateCode

CuttingTemplateCode is optional. A single instance might exist.

Cutting Template Code contains the reference to previously defined instructions on how to cut the sheet.

AdditionalText

AdditionalText is optional. Multiple instances might exist.

A text field that is used to communicate information not previously defined or for special instructions. To be used only for circumstances not covered by specific elements.

CuttingTemplateCode

Cutting Template Code contains the reference to previously defined instructions on how to cut the sheet.

AssignedBy [attribute]

AssignedBy is optional. A single instance might exist.

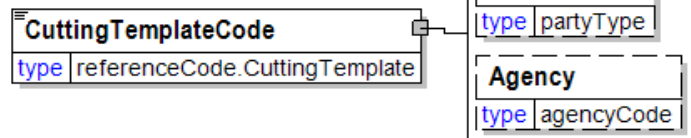

Identifies the type of party that has assigned the associated item, e.g. a reference of type OrderNumber. Refer to AssignedBy definition for any enumerations.

Refer to AssignedBy definition for any enumerations.

Agency [attribute]

Agency is optional. A single instance might exist.

Describes the agency maintaining the list of codes. To be included in this list the agency must be a recognized standards body or industry organisation.

For the element that owns this attribute.

For another attribute in the list of attributes associated with the parent element.

Refer to Agency definition for any enumerations.

Cyan

The Cyan component of a colour in the CMYK approach to colour definition.

(sequence)

The sequence of items below is mandatory. A single instance is required.

DetailValue

DetailValue is mandatory. A single instance is required.

A numeric value expressed in the unit of measure (UOM).

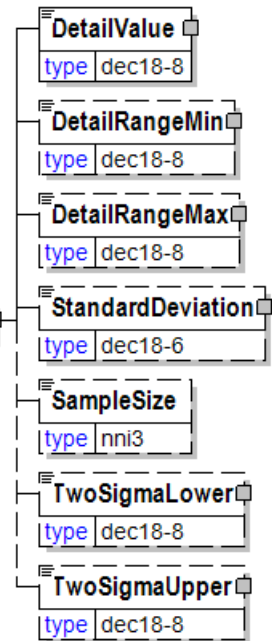
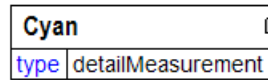

DetailRangeMin

DetailRangeMin is optional. A single instance might exist.

The minimum value (lower boundary) allowed for the DetailValue that is the parent of this element.

DetailRangeMax

DetailRangeMax is optional. A single instance might exist.

The maximum value (upper boundary) allowed for the DetailValue that is the parent of this element.

StandardDeviation

StandardDeviation is optional. A single instance might exist.

A statistic used as a measure of dispersion in a distribution.

SampleSize

SampleSize is optional. A single instance might exist.

The number of samples used to determine the product characteristic in question.

TwoSigmaLower

TwoSigmaLower is optional. A single instance might exist.

Two sigma (a measure of dispersion associated with standard deviation) on the lower side of the standard deviation.

TwoSigmaUpper

TwoSigmaUpper is optional. A single instance might exist.

Two sigma (a measure of dispersion associated with standard deviation) on the upper side of the standard deviation.

Date

A group element that contains the specification of Year, Month, and Day.

(sequence)

The sequence of items below is mandatory. A single instance is required.

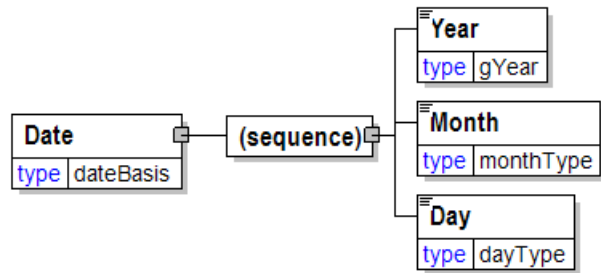

Year

Year is mandatory. A single instance is required.

Identifies the year number when communicating a Calendar date.

Month

Month is mandatory. A single instance is required.

Identifies the month number when communicating a Calendar date.

Day

Day is mandatory. A single instance is required.

Identifies the day of the month when communicating a Calendar date. Day is an integer between 1 and 31.

DateFinished

The Date and optionally the Time that an item was finished. For example, this could be the wrapping date for a reel or ream or the date the sheet(s) were packaged in preparation for shipment

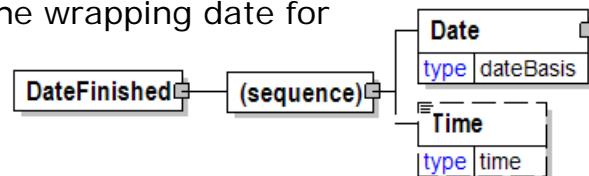

(sequence)

The sequence of items below is mandatory. A single instance is required.

Date

Date is mandatory. A single instance is required.

A group element that contains the specification of Year, Month, and Day.

Time

Time is optional. A single instance might exist.

Times are treated in a standard XML fashion with a special case used to indicate a generalized "local" time. The standard XML approach to time is hh:mm:ss, hh:mm:ssZ, or hh:mm:ss±hh:mm.

hh:mm:ss±hh:mm is used to represent a time with a time zone. The time zone is communicated as the number of hours offset from the Universal Time Coordinate (UTC), a.k.a. Greenwich Mean Time.

hh:mm:ssZ indicates the time at Zulu (another name for UTC). Based on the convention described in the next bullet it will be important for users within UTC to use "Z" when communicating a time in their time zone to other users.

hh:mm:ss or hh:mm indicates in the XML standard the time at UTC however, within papiNet it is used to represent the applicable local time. Caution should be used when processing times of this nature as the papiNet approach may be

papiNet V2R31

in discord with other users of XML.

DateMade

The Date and optionally the Time when an item was produced. DateMade is normally a date before the wrapping and labelling date of the item.

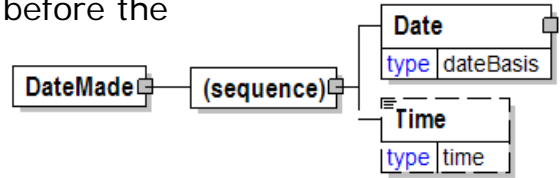

(sequence)

The sequence of items below is mandatory. A single instance is required.

Date

Date is mandatory. A single instance is required.

A group element that contains the specification of Year, Month, and Day.

Time

Time is optional. A single instance might exist.

Times are treated in a standard XML fashion with a special case used to indicate a generalized "local" time. The standard XML approach to time is hh:mm:ss, hh:mm:ssZ, or hh:mm:ss±hh:mm.

hh:mm:ss±hh:mm is used to represent a time with a time zone. The time zone is communicated as the number of hours offset from the Universal Time Coordinate (UTC), a.k.a. Greenwich Mean Time.

hh:mm:ssZ indicates the time at Zulu (another name for UTC). Based on the convention described in the next bullet it will be important for users within UTC to use "Z" when communicating a time in their time zone to other users.

hh:mm:ss or hh:mm indicates in the XML standard the time at UTC however, within papiNet it is used to represent the applicable local time. Caution should be used when processing times of this nature as the papiNet approach may be in discord with other users of XML.

DateSheeted

The Date and optionally the Time that the paper was sheeted.

(sequence)

The sequence of items below is mandatory. A single instance is required.

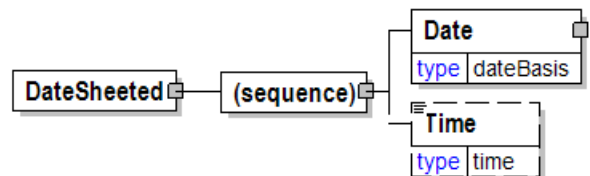

Date

Date is mandatory. A single instance is required.

A group element that contains the specification of Year, Month, and Day.

Time

Time is optional. A single instance might exist.

Times are treated in a standard XML fashion with a special case used to indicate a generalized "local" time. The standard XML approach to time is hh:mm:ss,

hh:mm:ssZ, or hh:mm:ss±hh:mm.

hh:mm:ss±hh:mm is used to represent a time with a time zone. The time zone is communicated as the number of hours offset from the Universal Time Coordinate (UTC), a.k.a. Greenwich Mean Time.

hh:mm:ssZ indicates the time at Zulu (another name for UTC). Based on the convention described in the next bullet it will be important for users within UTC to use "Z" when communicating a time in their time zone to other users.

hh:mm:ss or hh:mm indicates in the XML standard the time at UTC however, within papiNet it is used to represent the applicable local time. Caution should be used when processing times of this nature as the papiNet approach may be in discord with other users of XML.

DateTimeFrom

The start or beginning Date and Time of a date range.

(sequence)

The sequence of items below is mandatory. A single instance is required.

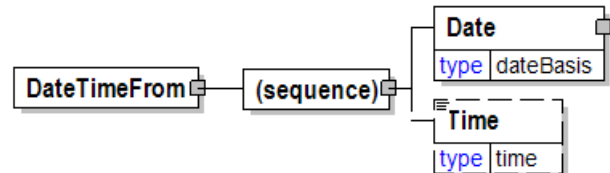

Date

Date is mandatory. A single instance is required.

A group element that contains the specification of Year, Month, and Day.

Time

Time is optional. A single instance might exist.

Times are treated in a standard XML fashion with a special case used to indicate a generalized "local" time. The standard XML approach to time is hh:mm:ss, hh:mm:ssZ, or hh:mm:ss±hh:mm.

hh:mm:ss±hh:mm is used to represent a time with a time zone. The time zone is communicated as the number of hours offset from the Universal Time Coordinate (UTC), a.k.a. Greenwich Mean Time.

hh:mm:ssZ indicates the time at Zulu (another name for UTC). Based on the convention described in the next bullet it will be important for users within UTC to use "Z" when communicating a time in their time zone to other users.

hh:mm:ss or hh:mm indicates in the XML standard the time at UTC however, within papiNet it is used to represent the applicable local time. Caution should be used when processing times of this nature as the papiNet approach may be in discord with other users of XML.

DateTimeRange

The delivery date and/or time range.

(sequence)

The sequence of items below is mandatory. A single instance is required.

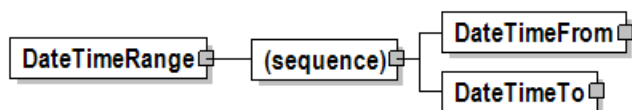

DateTimeFrom

papiNet V2R31

DateTimeFrom is mandatory. A single instance is required.

The start or beginning Date and Time of a date range.

DateTimeTo

DateTimeTo is mandatory. A single instance is required.

The ending Date and Time of a date/time range.

DateTimeTo

The ending Date and Time of a date/time range.

(sequence)

The sequence of items below is mandatory. A single instance is required.

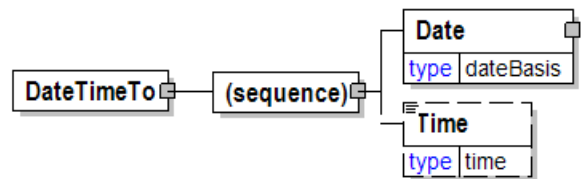

Date

Date is mandatory. A single instance is required.

A group element that contains the specification of Year, Month, and Day.

Time

Time is optional. A single instance might exist.

Times are treated in a standard XML fashion with a special case used to indicate a generalized "local" time. The standard XML approach to time is hh:mm:ss, hh:mm:ssZ, or hh:mm:ss±hh:mm.

hh:mm:ss±hh:mm is used to represent a time with a time zone. The time zone is communicated as the number of hours offset from the Universal Time Coordinate (UTC), a.k.a. Greenwich Mean Time.

hh:mm:ssZ indicates the time at Zulu (another name for UTC). Based on the convention described in the next bullet it will be important for users within UTC to use "Z" when communicating a time in their time zone to other users.

hh:mm:ss or hh:mm indicates in the XML standard the time at UTC however, within papiNet it is used to represent the applicable local time. Caution should be used when processing times of this nature as the papiNet approach may be in discord with other users of XML.

DateTimeValue

A Date and Time value in the standard W3C xs:dateTime format.

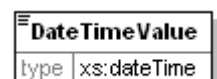

DateType [attribute]

Provides a context for the other date used in the document.

This item is restricted to the following list.

ActualArrivalDate

The date the product arrived at the delivery destination.

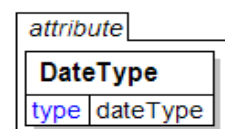

ActualDepartureDate

The date the product departed the delivery origin.

AvailableToShipDate

The date the product needs to be available to ship.

BoundBookDate

Date the book is to be bound

CancelAfterDate

An action defined by the context is to be cancelled after the specified date.

ComponentDueDate

The date the component is due at the manufacturing or assembly location.

ComponentShipDate

The date the component has shipped or should ship.

ConsumptionDate

The date the item was or should be consumed.

DateOfLastChange

The last date that changes are permitted.

DateOfTrading

A date or date range when the supply of goods or services were made or completed. Normally this is the date of delivery but it can be other dates depending on terms of delivery; for example, despatch date.

DeliveryDate

The date the product is to be delivered.

DeliveryPriorToDate

The delivery must take place prior to this date.

DeliveryRequestedDate

The date on which the buyer requests goods to be delivered. Delivery will happen at this date on a "best endeavours" basis.

DespatchDate

The date the product is to be despatched.

DoNotDeliverAfterDate

The delivery must not take place after the date specified.

DoNotShipAfterDate

The shipment must not take place after the date specified.

DrawDate

The date removed from stock.

EarliestDate**EndCallOffDate**

The date that call offs should end.

EndOfDeliveryMonth

The end of the month that delivery has taken place.

EndOfDespatchMonth

The end of the month that despatch has taken place.

EndOfInvoiceMonth

The end of the month that Invoice has taken place.

EstimatedTimeOfArrival

The date and time that the shipment is expected to arrive.

EstimatedTimeOfDeparture

The date and time that the shipment is expected to leave.

ExMillDate

Goods are ready at the mill.

ForestForwardingDate

The date when transporting of forest wood products take place from logging areas to roadside landings.

InvoiceDate

A date that is qualifying the invoicing period. This date often drives payment terms. Note that this date is not necessarily the same as the issue date of the Invoice.

LastChangeDate

The most recent date the document was changed.

LoadingDate

The date when the goods are loaded on a transport unit.

MeasuringDate

The date when measuring is performed.

OnPressDate

Date printing will commence.

OnSalesDate

Publicised sales date

OrderConfirmationDate

The date that OrderConfirmation took place.

OrderFirmedDate

The date that the order will be consider firm unless additional information is received.

PickUpDate

Use to notify the collector when to retrieve the load.

PlannedShipDate

The anticipated date of shipment.

PrepDate

Specifies the date applied to the preparation process.

PrintDate

The date on which a job is planned to go on the press to be printed. The ordered product needs to be available before this date.

ProductionDate

The date the product is produced.

ProofDueBackDate

Date the return of the proof is due back or the review process is to be completed.

ProofOutDate

Date the proof is mailed or made available to the buyer for review.

PublicationDate

Date the book will be published.

PurchaseOrderDate

The date when the PurchaseOrder was issued.

ReferencePeriod

A period of time covered by the object, e.g. an e-Document.

RequiredByDate

The date by which the activity must be completed. In the context of a PurchaseOrder this date refers to the date by which the material must be at the buyer's location of use.

ShipEvenlyThroughout

Distribute shipment of product in relatively even shipments throughout the date range indicated

ShipmentPriorToDate

The shipment (despatch) must take place prior to this date—in other words, the goods have to leave the terminal.

ShipmentRequestedDate

The date shipment is requested.

SpecificationVersionDate

Date of version of a specification

StartCallOffDate

The date on which the first CallOff can be placed.

TheWeekBeginning

The delivery is to be made at the beginning of the week that is mentioned in the Date construct.

TheWeekEnding

The delivery is to be made at the end of the week that is mentioned in the

Date construct.

WarehouseDate

Depending on the e-Document context this can communicate the date that items are due in the warehouse or have been placed in the warehouse. For example:

Date books are due in the publisher's warehouse

Date reels were unloaded and put into the warehouse

Other

Any other type of date that is not contained in the attribute list.

DateWound

The Date and optionally the Time that a reel was wound or produced from its parent. RewoundIndicator indicates if the reel has been rewound.

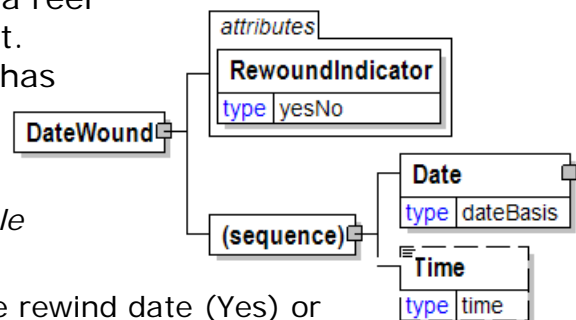

RewoundIndicator [attribute]

RewoundIndicator is mandatory. A single instance is required.

Is the date being communicated the the rewind date (Yes) or the date of original winding (No)?

Refer to RewoundIndicator definition for any enumerations.

(sequence)

The sequence of items below is mandatory. A single instance is required.

Date

Date is mandatory. A single instance is required.

A group element that contains the specification of Year, Month, and Day.

Time

Time is optional. A single instance might exist.

Times are treated in a standard XML fashion with a special case used to indicate a generalized "local" time. The standard XML approach to time is hh:mm:ss, hh:mm:ssZ, or hh:mm:ss±hh:mm.

hh:mm:ss±hh:mm is used to represent a time with a time zone. The time zone is communicated as the number of hours offset from the Universal Time Coordinate (UTC), a.k.a. Greenwich Mean Time.

hh:mm:ssZ indicates the time at Zulu (another name for UTC). Based on the convention described in the next bullet it will be important for users within UTC to use "Z" when communicating a time in their time zone to other users.

hh:mm:ss or hh:mm indicates in the XML standard the time at UTC however, within papiNet it is used to represent the applicable local time. Caution should be used when processing times of this nature as the papiNet approach may be in discord with other users of XML.

Day

Identifies the day of the month when communicating a Calendar date. Day is an integer between 1 and 31.

Day
type dayType

Days

The qualifier of DeliveryTransitTime. More generally used to communicate duration in days.

Days
type nni3

Debarked [attribute]

Either "Yes" or "No".

This item is restricted to the following list.

Yes

No

attribute
Debarked
type yesNo

DeckAndPorchFlooringMaterials-NaturalWood

Deck and porch flooring materials that are used in natural wood

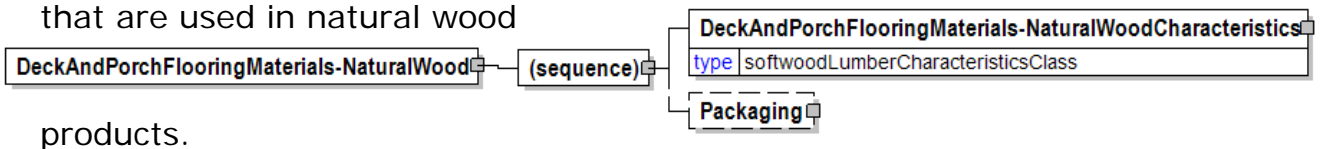

products.

(sequence)

The sequence of items below is mandatory. A single instance is required.

DeckAndPorchFlooringMaterials-NaturalWoodCharacteristics

DeckAndPorchFlooringMaterials-NaturalWoodCharacteristics is mandatory. A single instance is required.

Natural wood characteristics of deck and porch flooring materials.

Packaging

Packaging is optional. A single instance might exist.

Type of a package that includes individual products.

DeckAndPorchFlooringMaterials-NaturalWoodCharacteristics

Natural wood characteristics of deck and porch flooring materials.

(sequence)

The sequence of items below is mandatory. A single instance is required.

LumberSpecies

LumberSpecies is mandatory. One instance is required, multiple instances might exist.

Specifies the raw material species.

LumberGrade

LumberGrade is mandatory. A single instance is required.

Defines quality characteristics achieved by selecting pieces based on a grading rule.

Length

Length is optional.

The length of the object.

Width

Width is optional.

The width of the object.

Thickness

Thickness is optional.

Physical dimension of a product.

Seasoning

Seasoning is optional. A single instance might exist.

Describes drying/ moisture control method.

MoistureContent

MoistureContent is optional. A single instance might exist.

Defines the moisture content percentage of the product.

HeatTreatment

HeatTreatment is optional. A single instance might exist.

Defines the heat treatment method.

ManufacturingProcess

ManufacturingProcess is optional. Multiple instances might exist.

Defines the different machining and processes made for the product.

PatternProfile

PatternProfile is optional. A single instance might exist.

Defines the pattern used in machining the product.

Trim

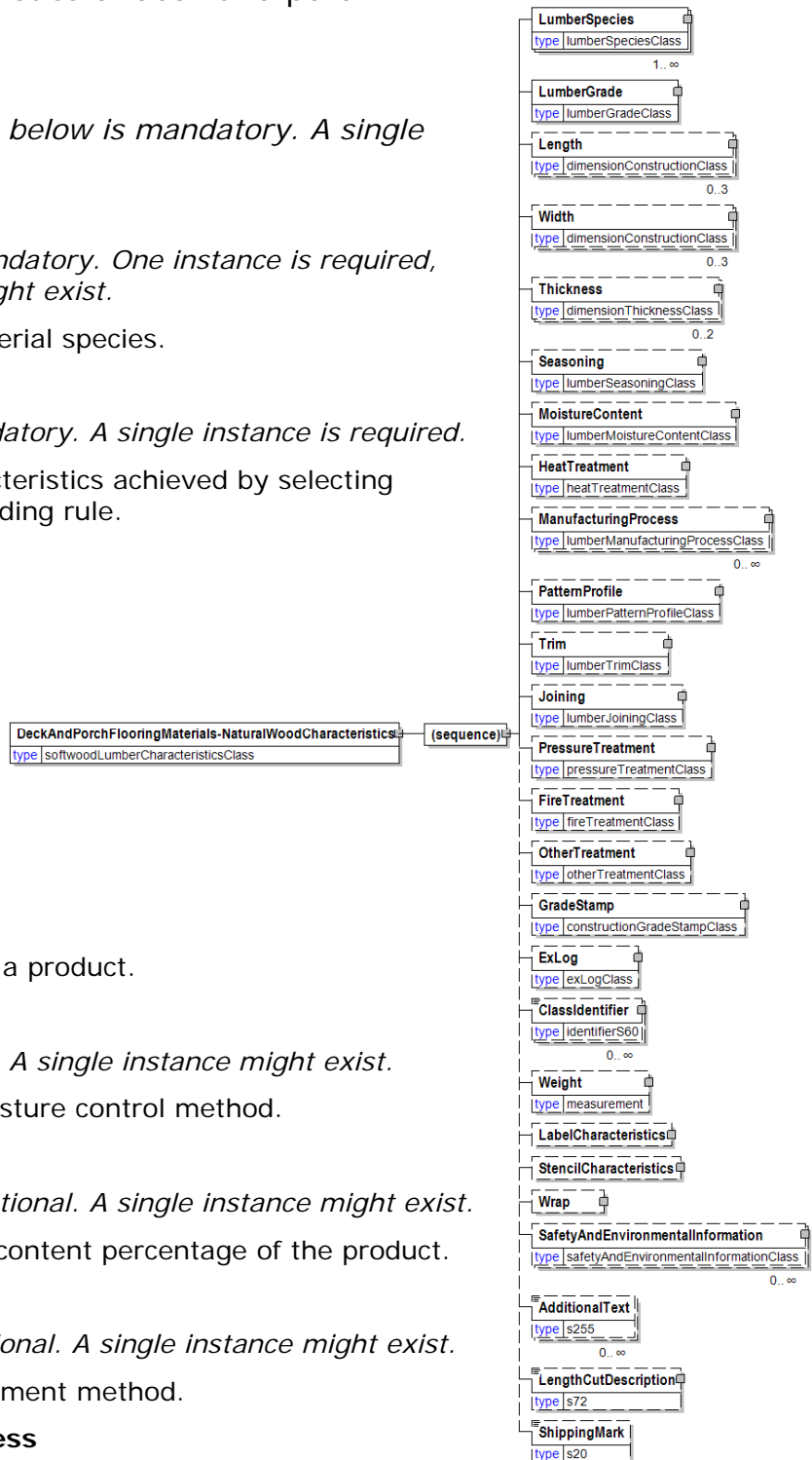

Trim is optional. A single instance might exist.

Trim

Joining

Joining is optional. A single instance might exist.

Defines the method used to join pieces of wood.

PressureTreatment

PressureTreatment is optional. A single instance might exist.

Method and parameter values of pressure treatment.

FireTreatment

FireTreatment is optional. A single instance might exist.

Fire treatment

OtherTreatment

OtherTreatment is optional. A single instance might exist.

Other treatment

GradeStamp

GradeStamp is optional. A single instance might exist.

Grade stamp information

ExLog

ExLog is optional. A single instance might exist.

Describes the cutting pattern of the log.

ClassIdentifier

ClassIdentifier is optional. Multiple instances might exist.

Standard used for product identification.

Weight

Weight is optional. A single instance might exist.

The weight of the item.

LabelCharacteristics

LabelCharacteristics is optional. A single instance might exist.

A group item that organises the labeling information.

StencilCharacteristics

StencilCharacteristics is optional. A single instance might exist.

A group element specifying attributes of a stencil to be applied to an item, and optional text.

Wrap

Wrap is optional. A single instance might exist.

A group item that organises wrapping detail information.

SafetyAndEnvironmentalInformation

SafetyAndEnvironmentalInformation is optional. Multiple instances might exist.

Name of certification type, if any, on the goods (For example, FSC, PEFC).
SafetyAndEnvironmental needs a value or measurement to communicate the

percentage of the product is certified (for example, 75% is certified by the indicated agency).

AdditionalText

AdditionalText is optional. Multiple instances might exist.

A text field that is used to communicate information not previously defined or for special instructions. To be used only for circumstances not covered by specific elements.

LengthCutDescription

LengthCutDescription is optional. A single instance might exist.

Length Cut Description

ShippingMark

ShippingMark is optional. A single instance might exist.

A shipping mark identifies the producer and quality on the end side of the product. Not to be mixed with company code/logo or other product marking.

DecorationCoverage

Decoration coverage.

(sequence)

The sequence of items below is mandatory. A single instance is required.

Value

Value is mandatory. A single instance is required.

A numeric value expressed in the unit of measure (UOM).

RangeMin

RangeMin is optional. A single instance might exist.

The minimum value (lower boundary) allowed for the Measurement that is the parent of this element.

RangeMax

RangeMax is optional. A single instance might exist.

The maximum value (upper boundary) allowed for the Measurement that is the parent of this element. Some elements use the RangeMax element with an extended list of unit of measures. (Note: the red colour in the picture is an artifact of how the graphic was captured and should be disregarded.)

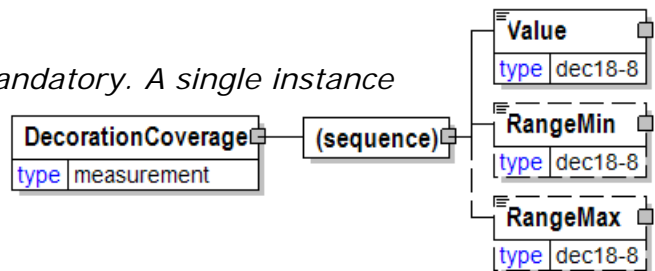

DecorationLocationType [attribute]

Decoration location type

This item is restricted to the following list.

Front

Back

Spine



- FrontAndBack
- FrontAndSpine
- BackAndSpine
- FrontAndBackAndSpine

DecorationSpecs

Decoration specifications

DecorationType [attribute]

DecorationType is optional. A single instance might exist.

Describes the finishing process.

Refer to DecorationType definition for any enumerations.

DecorationLocationType [attribute]

DecorationLocationType is optional. A single instance might exist.

Decoration location type

Refer to DecorationLocationType definition for any enumerations.

(sequence)

The sequence of items below is mandatory. A single instance is required.

ColourCode

ColourCode is optional. A single instance might exist.

A code indicating the colour.

ColourDescription

ColourDescription is optional. A single instance might exist.

A free form description of the colour.

NumberOfHits

NumberOfHits is optional. A single instance might exist.

The number of hits

DecorationCoverage

DecorationCoverage is optional. A single instance might exist.

Decoration coverage.

ProductIdentification

ProductIdentification is optional. Multiple instances might exist.

A grouping element designed to communicate product identification related to the parent element that contains this item.

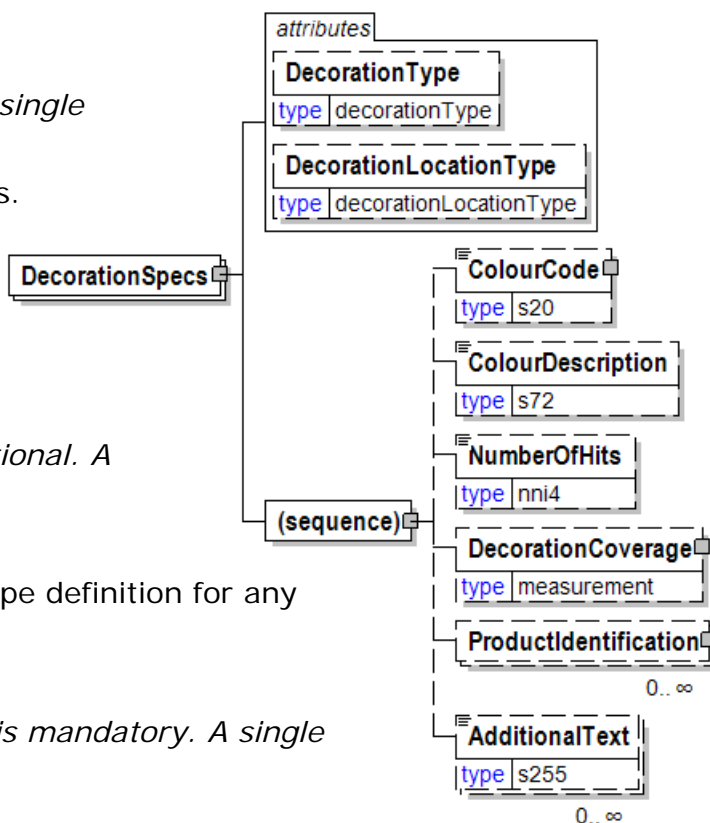

AdditionalText

AdditionalText is optional. Multiple instances might exist.

A text field that is used to communicate information not previously defined or for special instructions. To be used only for circumstances not covered by specific elements.

DecorationType [attribute]

Describes the finishing process.

This item is restricted to the following list.

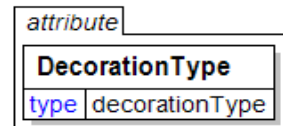

Debossing

DieCuts

Emboss

FoilStamping

Pressing a design onto a book cover using metallic or pigment foil.

Hubbing

InkStamping

Pressing a design onto a book cover using ink

RaisedBands

RaisedUV

Raised bumps obtained via an ultra-violet process.

Stamping

DeliveryDate

The Date and optionally the Time that the partners agree is the date upon which deliveries will be recognised.

Possible choices for this date are either the date despatched or the date received.

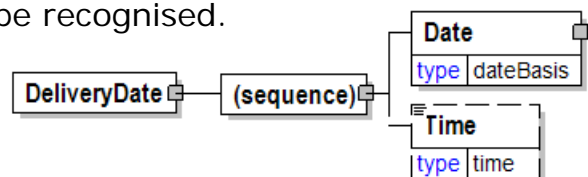

(sequence)

The sequence of items below is mandatory. A single instance is required.

Date

Date is mandatory. A single instance is required.

A group element that contains the specification of Year, Month, and Day.

Time

Time is optional. A single instance might exist.

Times are treated in a standard XML fashion with a special case used to indicate a generalized "local" time. The standard XML approach to time is hh:mm:ss, hh:mm:ssZ, or hh:mm:ss±hh:mm.

hh:mm:ss±hh:mm is used to represent a time with a time zone. The time zone is communicated as the number of hours offset from the Universal Time

Coordinate (UTC), a.k.a. Greenwich Mean Time.

hh:mm:ssZ indicates the time at Zulu (another name for UTC). Based on the convention described in the next bullet it will be important for users within UTC to use "Z" when communicating a time in their time zone to other users.

hh:mm:ss or hh:mm indicates in the XML standard the time at UTC however, within papiNet it is used to represent the applicable local time. Caution should be used when processing times of this nature as the papiNet approach may be in discord with other users of XML.

DeliveryDateType [attribute]

Provides a context for the delivery date window.

This item is restricted to the following list.

attribute
DeliveryDateType
type deliveryDateType

ActualArrivalDate

The date the product arrived at the delivery destination.

ActualDepartureDate

The date the product departed the delivery origin.

AvailableToShipDate

The date that the material is available for shipment. That is, the material can be picked up on this date.

CancelAfterDate

The delivery is to be cancelled if not delivered by this date.

DateOfLastChange

The latest date at which an amendment versus cancellation is allowed to take place. The seller in the e-Document confirmation communicates this date.

DateOfTrading

A date or date range when the supply of goods or services were made or completed. Normally this is the date of delivery but it can be other dates depending on terms of delivery (for example the despatch date).

DeliveryRequestedDate

The date on which a buyer requests goods to be delivered. Delivery will happen at this date on a "best endeavours" basis.

DoNotDeliverAfterDate

The delivery must not take place after the date specified.

DoNotShipAfterDate

The shipment must not take place after the date specified.

EndCallOffDate

The date on which the last CallOff can be placed.

EstimatedTimeOfArrival

The expected time that the goods will arrive. Receiving facilities should be available.

EstimatedTimeOfDeparture

The date and time that the shipment is expected to leave.

LastChangeDate

The most recent date the document was changed.

LoadingDate

The date on which loading should or is planned to take place.

PickUpDate

The date the material will be, or is available to be, picked-up from the shipping location.

PlannedShipDate

The date on which shipment is planned to take place.

ReferencePeriod

A period of time covered by the object, e.g. an e-Document.

ShipmentPriorToDate

The shipment (despatch) must take place prior to this date—in other words; the goods have to leave the terminal.

ShipmentRequestedDate

The date on which shipment is requested to take place.

StartCallOffDate

The date on which the first CallOff can be placed.

DeliveryDateWindow

A group item defining the date/time interval for delivery to take place. An element which may contain the estimated date for which delivery is expected. This date is not absolute.

DeliveryDateType [attribute]

DeliveryDateType is mandatory. A single instance is required.

Provides a context for the delivery date window.

Refer to DeliveryDateType definition for any enumerations.

(choice)

[choice] is optional because of choice construct.

DateTimeRange

DateTimeRange is optional because of choice construct.

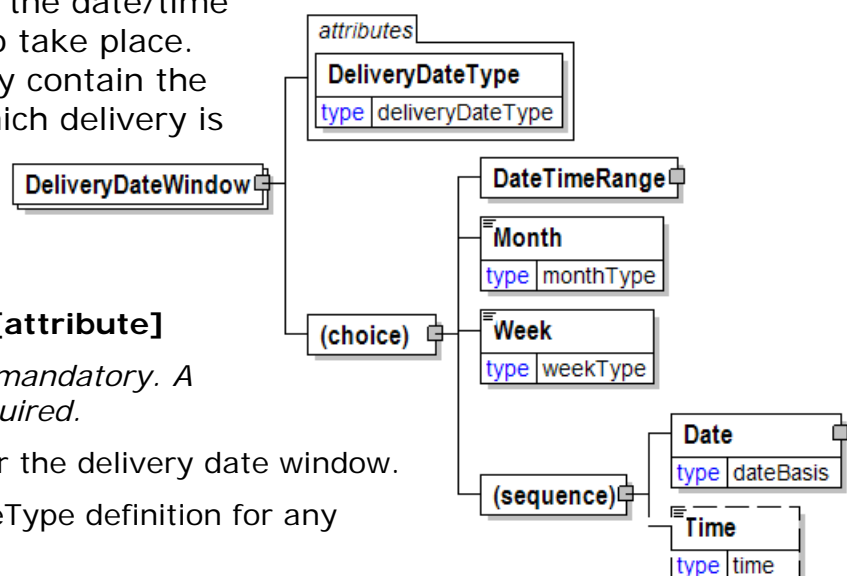

Specifies a date and/or time range.

Month

Month is optional because of choice construct.

Identifies the month number when communicating a Calendar date.

Week

Week is optional because of choice construct.

A field defining the week number of the calendar year. ISO 8601 is used as the basis for this element, "Week 01 of a year is the first week that has the Thursday in this year, which is equivalent to the week that contains the fourth day of January."

(sequence)

The sequence of items below is mandatory. A single instance is required.

Date

Date is mandatory. A single instance is required.

A group element that contains the specification of Year, Month, and Day.

Time

Time is optional. A single instance might exist.

Times are treated in a standard XML fashion with a special case used to indicate a generalized "local" time. The standard XML approach to time is hh:mm:ss, hh:mm:ssZ, or hh:mm:ss±hh:mm.

hh:mm:ss±hh:mm is used to represent a time with a time zone. The time zone is communicated as the number of hours offset from the Universal Time Coordinate (UTC), a.k.a. Greenwich Mean Time.

hh:mm:ssZ indicates the time at Zulu (another name for UTC). Based on the convention described in the next bullet it will be important for users within UTC to use "Z" when communicating a time in their time zone to other users.

hh:mm:ss or hh:mm indicates in the XML standard the time at UTC however, within papiNet it is used to represent the applicable local time. Caution should be used when processing times of this nature as the papiNet approach may be in discord with other users of XML.

DeliveryDestination

The DeliveryDestination specifies the end of one leg of the delivery. In order to comply with the US Trade Act of 2002 you would use this element with a LocationParty/@PartyType of Port.

IsOptionalDestination [attribute]

IsOptionalDestination is optional. A single instance might exist.

Specifies if the Destination is optional or not. The default value is "No".

Refer to IsOptionalDestination definition for any enumerations.

PriorityOrder [attribute]

PriorityOrder is optional. A single instance might exist.

Specifies the priority order of the item as a two digit positive integer. Value 1 is the highest priority.

(sequence)

The sequence of items below is mandatory. A single instance is required.

Date

Date is optional. A single instance might exist.

A group element that contains the specification of Year, Month, and Day.

Time

Time is optional. A single instance might exist.

Times are treated in a standard XML fashion with a special case used to indicate a generalized "local" time. The standard XML approach to time is hh:mm:ss, hh:mm:ssZ, or hh:mm:ss±hh:mm.

hh:mm:ss±hh:mm is used to represent a time with a time zone. The time zone is communicated as the number of hours offset from the Universal Time Coordinate (UTC), a.k.a. Greenwich Mean Time.

hh:mm:ssZ indicates the time at Zulu (another name for UTC). Based on the convention described in the next bullet it will be important for users within UTC to use "Z" when communicating a time in their time zone to other users.

hh:mm:ss or hh:mm indicates in the XML standard the time at UTC however, within papiNet it is used to represent the applicable local time. Caution should be used when processing times of this nature as the papiNet approach may be in discord with other users of XML.

LocationParty

LocationParty is mandatory. A single instance is required.

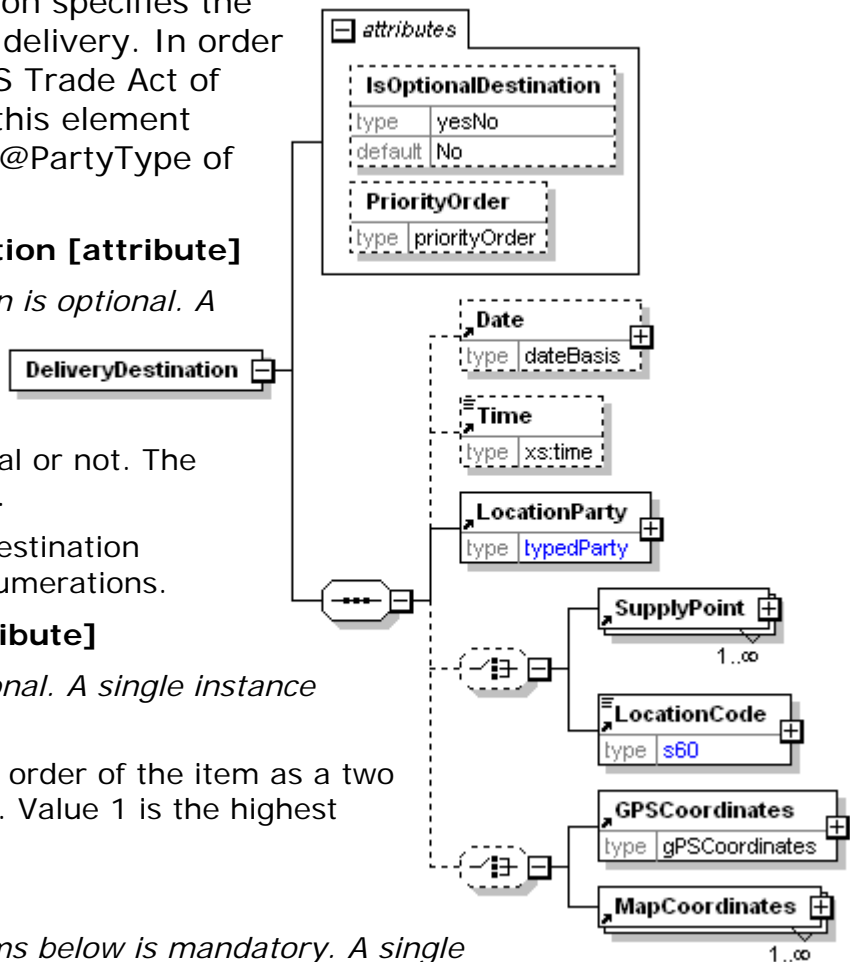

The organization or business entity where the business event took place or will take place.

(choice)

[choice] is optional because of choice construct.

SupplyPoint

SupplyPoint is optional because of the choice construct.

Grouping element that contains items describing a supply point. A SupplyPoint belongs to a LocationParty, e.g. in a DeliveryOrigin or DeliveryDestination, and describes where goods are stored and can be loaded or unloaded. A SupplyPoint can for example be a loading or unloading gate at a warehouse or a road side landing at a logging area in the forest.

LocationCode

LocationCode is optional because of the choice construct.

A code used to identify a specific physical location within a site identified by a party, e.g. a loading station in a warehouse or an unloading station at a printer site.

LocationCode will be deprecated in a future version. Use SupplyPoint instead of LocationCode.

(choice)

[choice] is optional because of choice construct.

GPSCoordinates

GPSCoordinates is optional because of choice construct.

The location of the party as specified using a Global Positioning System.

MapCoordinates

MapCoordinates is optional because of choice construct.

A group item defining and containing position co-ordinates of a location.

DeliveryIndicator

Indicates if delivery should take place or not.

This item is restricted to the following list.

Deliver

DoNotDeliver

DeliveryIndicator
type deliveryIndicator

DeliveryInfo

Information about the delivery.

(sequence)

The sequence of items below is mandatory. A single instance is required.

TermsOfDelivery

TermsOfDelivery is optional. A single instance might exist.

A group item defining the terms under which the delivery of goods will take place. These terms determine when and under what conditions the transfer of ownership will occur. Generally speaking, the Incoterms are primarily used in Europe, whereas the ShipmentMethodOfPayment is primarily used in North America.

CarrierParty

CarrierParty is optional. A single instance might exist.

The party performing the transport of the product from the pickup location to the ship-to location; could be a hauler.

TransportVehicleCharacteristics

TransportVehicleCharacteristics is optional. A single instance might exist.

A group item defining the primary means of transporting the goods, such as a side port vessel. In some instances, the transport unit and vehicle are the same.

TransportModeCharacteristics

TransportModeCharacteristics is optional. A single instance might exist.

A group item defining the primary mode of transport.

TransportUnitCharacteristics

TransportUnitCharacteristics is optional. Multiple instances might exist.

A group item defining and identifying the primary means of containing the goods. In some instances, the transport unit and vehicle are the same.

DeliveryOrigin

DeliveryOrigin is mandatory. A single instance is required.

A group item that represents the start of one leg in a route. Compare to DeliveryDestination.

The DeliveryOrigin specifies the start of one leg of the delivery.

In order to comply with the US Trade Act of 2002 you would use this element with a LocationParty/@PartyType of Port.

DeliveryDestination

DeliveryDestination is optional. A single instance might exist.

The DeliveryDestination specifies the end of one leg of the delivery. In order to comply with the US Trade Act of 2002 you would use this element with a LocationParty/@PartyType of Port.

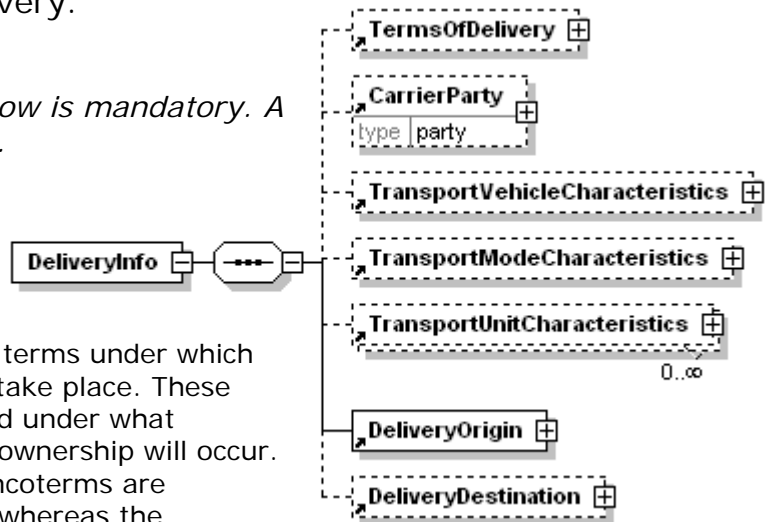

DeliveryInstruction

A DeliveryInstruction element is the root element for the DeliveryInstruction e-Document.

A DeliveryInstruction can be used to instruct movement of goods to warehouses and movement of goods to virtual locations within warehouses as well as deliveries to customers. The DeliveryInstruction e-Document is designed to fulfil supply chain requirements regarding instruction for goods deliveries to Mills, Suppliers, Forwarders, Warehouse Operators, Customers, and End-Users. The DeliveryInstruction is load oriented which is very efficient when mills and suppliers move goods in large quantities between warehouses.

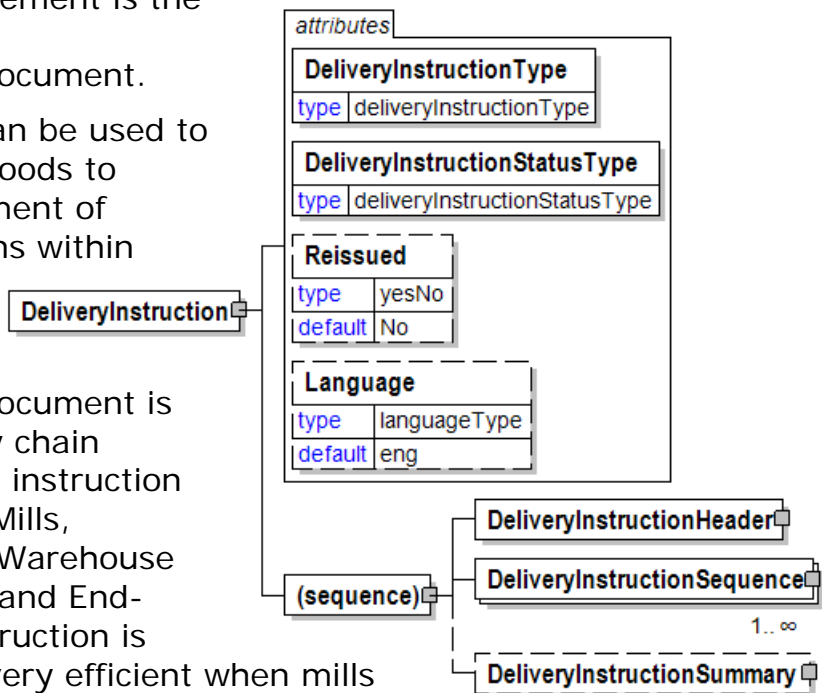

DeliveryInstructionType [attribute]

DeliveryInstructionType is mandatory. A single instance is required.

DeliveryInstructionType defines the type of DeliveryInstruction.

Refer to DeliveryInstructionType definition for any enumerations.

DeliveryInstructionStatusType [attribute]

DeliveryInstructionStatusType is mandatory. A single instance is required.

Identifies the status of the entire DeliveryInstruction (in other words, at the root level).

Refer to DeliveryInstructionStatusType definition for any enumerations.

Reissued [attribute]

Reissued is optional. A single instance might exist.

Either "Yes" or "No".

Refer to Reissued definition for any enumerations.

Language [attribute]

Language is optional. A single instance might exist.

XML has embraced 2 and 3 digit language codes through the application of an addendum to the standard.

Refer to Language definition for any enumerations.

(sequence)

The sequence of items below is mandatory. A single instance is required.

DeliveryInstructionHeader

DeliveryInstructionHeader is mandatory. A single instance is required.

The DeliveryInstruction Header provides information that applies to the entire DeliveryInstruction.

DeliveryInstructionSequence

DeliveryInstructionSequence is mandatory. One instance is required, multiple instances might exist.

The DeliveryInstruction Sequence contains information about a loading or delivery event, depending on the type of DeliveryInstruction being communicated.

DeliveryInstructionSummary

DeliveryInstructionSummary is optional. A single instance might exist.

The DeliveryInstruction Summary provides summary information used to verify the contents of the e-Document.

DeliveryInstructionDate

The Date and Time when the DeliveryInstruction was issued.

(sequence)

The sequence of items below is mandatory. A single instance is required.

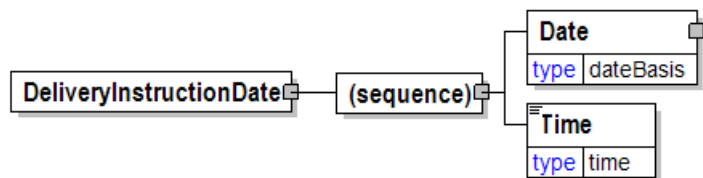

Date

Date is mandatory. A single instance is required.

A group element that contains the specification of Year, Month, and Day.

Time

Time is mandatory. A single instance is required.

Times are treated in a standard XML fashion with a special case used to indicate a generalized "local" time. The standard XML approach to time is hh:mm:ss, hh:mm:ssZ, or hh:mm:ss±hh:mm.

hh:mm:ss±hh:mm is used to represent a time with a time zone. The time zone is communicated as the number of hours offset from the Universal Time Coordinate (UTC), a.k.a. Greenwich Mean Time.

hh:mm:ssZ indicates the time at Zulu (another name for UTC). Based on the convention described in the next bullet it will be important for users within UTC to use "Z" when communicating a time in their time zone to other users.

hh:mm:ss or hh:mm indicates in the XML standard the time at UTC however, within papiNet it is used to represent the applicable local time. Caution should be used when processing times of this nature as the papiNet approach may be in discord with other users of XML.

DeliveryInstructionHeader

The DeliveryInstruction Header provides information that applies to the entire DeliveryInstruction.

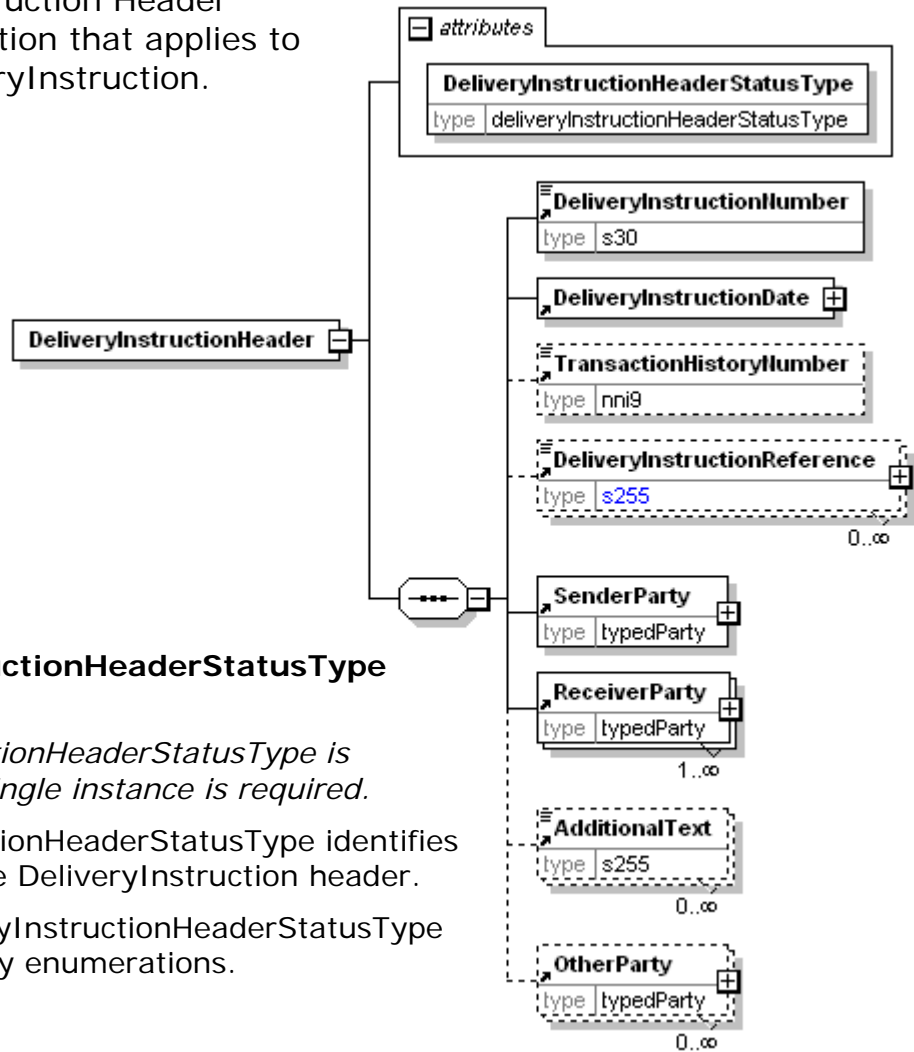

DeliveryInstructionHeaderStatusType [attribute]

DeliveryInstructionHeaderStatusType is mandatory. A single instance is required.

DeliveryInstructionHeaderStatusType identifies the status of the DeliveryInstruction header.

Refer to DeliveryInstructionHeaderStatusType definition for any enumerations.

(sequence)

The sequence of items below is mandatory. A single instance is required.

DeliveryInstructionNumber

DeliveryInstructionNumber is mandatory. A single instance is required.

The unique identifier for the DeliveryInstruction.

DeliveryInstructionDate

DeliveryInstructionDate is mandatory. A single instance is required.

The Date and Time when the DeliveryInstruction was issued.

TransactionHistoryNumber

TransactionHistoryNumber is optional. A single instance might exist.

A sequential number that keeps track of the version of a document being sent by the document originator except in the case where TransactionHistoryConfirmation is used, in which case the TransactionHistoryNumber refers to the trigger transaction for which the confirmation is being sent.

DeliveryInstructionReference

DeliveryInstructionReference is optional. Multiple instances might exist.

An element detailing relevant references pertaining to the DeliveryInstruction, as indicated by the DeliveryInstructionReferenceType and AssignedBy.

SenderParty

SenderParty is mandatory. A single instance is required.

The business entity issuing the e-Document, the source of the document.

The entity responsible for the content. If the sender party has out sourced the message service to a third party the SenderParty is the issuer of the e-Document and not the party performing the transmission service of the electronic message.

ReceiverParty

ReceiverParty is mandatory. One instance is required, multiple instances might exist.

The business entity for whom the e-Document is intended, the destination of the document.

The entity interested in the content. If the receiver party has outsourced the message service to a third party the ReceiverParty is the intended party for the e-Document and not the party performing the receiving service of the electronic message.

AdditionalText

AdditionalText is optional. Multiple instances might exist.

A text field that is used to communicate information not previously defined or for special instructions. To be used only for circumstances not covered by specific elements.

OtherParty

OtherParty is optional. Multiple instances might exist.

An organisation or business entity other than those specifically detailed within a e-Document.

DeliveryInstructionHeaderStatusType [attribute]

DeliveryInstructionHeaderStatusType identifies the status of the DeliveryInstruction header.

This item is restricted to the following list.

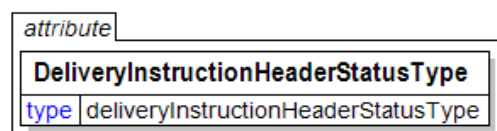

Amended

The supplied information is changed.

Cancelled

The supplied information has been cancelled. Items that have been cancelled are not included in totals on the summary levels of the e-Document.

New

The supplied information is new and supplied for the first time.

NoAction

The supplied information has not been amended and thereby requires no action.

DeliveryInstructionNumber

The unique identifier for the DeliveryInstruction.

DeliveryInstructionNumber	
type	s30

DeliveryInstructionReference

An element detailing relevant references pertaining to the DeliveryInstruction, as indicated by the

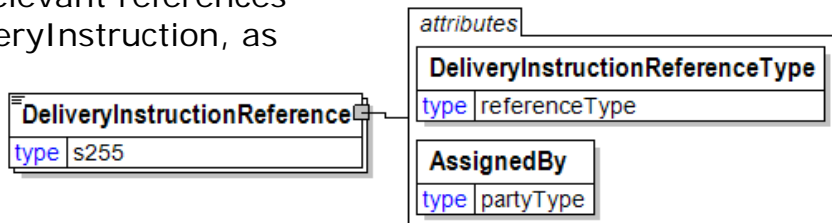

DeliveryInstructionReferenceType and AssignedBy.

DeliveryInstructionReferenceType [attribute]

DeliveryInstructionReferenceType is mandatory. A single instance is required.

Provides a contextual explanation of the specific reference identifier. Many items are currently prefixed by "Buyer", "Forwarder", "Manufacturer", "Mill", "Seller", "Supplier", "Warehouse", or "Vendor". Check for an existing non-prefixed version and use the non-prefixed version instead. In the (yet to be announced release date) version 3.0 the prefixed versions will be removed. Instead the attribute @AssignedBy will communicate the information previously communicated in the prefix.

Refer to DeliveryInstructionReferenceType definition for any enumerations.

AssignedBy [attribute]

AssignedBy is optional. A single instance might exist.

Identifies the type of party that has assigned the associated item, e.g. a reference of type OrderNumber.

Refer to AssignedBy for any enumerations.

DeliveryInstructionReferenceType [attribute]

Provides a contextual explanation of the specific reference identifier. Many items are currently prefixed by "Buyer", "Forwarder", "Manufacturer", "Mill", "Seller", "Supplier", "Warehouse", or "Vendor". Check for an

existing non-prefixed version and use the non-prefixed version instead. In the (yet to be announced release date) version 3.0 the prefixed versions will be removed. Instead the attribute @AssignedBy will communicate the information previously communicated in the prefix.

Refer to the [referenceType](#) entry for the list of enumerations and their definitions.

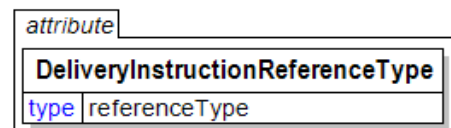

DeliveryInstructionSequence

The DeliveryInstructionSequence contains information about a loading or delivery event, depending on the type of DeliveryInstruction being communicated.

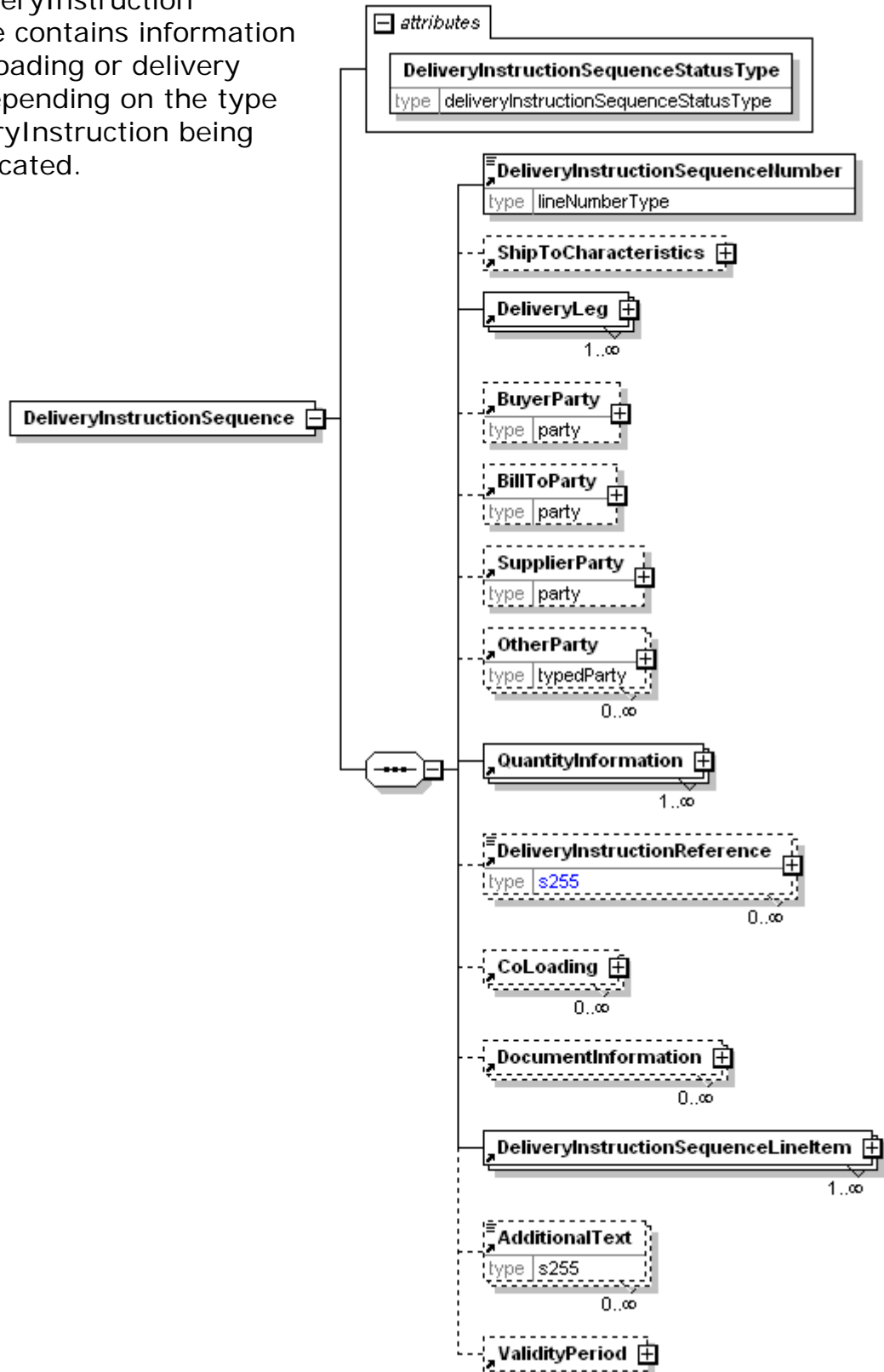

DeliveryInstructionSequenceStatusType [attribute]

DeliveryInstructionSequenceStatusType is mandatory. A single instance is required.

DeliveryInstruction sequence status type identifies the status of the DeliveryInstruction sequence

Refer to DeliveryInstructionSequenceStatusType definition for any enumerations.

(sequence)

The sequence of items below is mandatory. A single instance is required.

DeliveryInstructionSequenceNumber

DeliveryInstructionSequenceNumber is mandatory. A single instance is required.

A sequential number that uniquely identifies the Sequence of a DeliveryInstruction.

ShipToCharacteristics

ShipToCharacteristics is optional. A single instance might exist.

A group item that provides information important for the Ship-To Party.

A group item that provides information important for the Ship-To Party. ShipToCharacteristics may be referenced at both the header and line item level. The reference at the header is required and acts as a default for the value at the line level, unless overridden at the line level.

DeliveryLeg

DeliveryLeg is mandatory. One instance is required, multiple instances might exist.

A DeliveryLeg details the sequence, origin, transportation, and destination of each part of the delivery. More than one leg may be required if there is a change of mode, vehicle, or carrier.

Although transportation information is optional, it is strongly recommended that any transportation information available be sent.

BuyerParty

BuyerParty is optional. A single instance might exist.

The legal entity to which the product is sold. Also commonly referred to as the sold-to party or customer. If no OtherParty is defined as the Payer, the Buyer is the Payer.

BillToParty

BillToParty is optional. A single instance might exist.

The address where the Invoice is to be sent.

SupplierParty

SupplierParty is optional. A single instance might exist.

The organisation or business entity responsible for providing the product. SupplierParty is also the seller of the product, if Seller is not specified as OtherParty = Seller.

OtherParty

OtherParty is optional. Multiple instances might exist.

An organisation or business entity other than those specifically detailed within a e-Document.

QuantityInformation

QuantityInformation is mandatory. One instance is required, multiple instances might exist.

A group item containing information about quantity and informational quantity of similar items.

DeliveryInstructionReference

DeliveryInstructionReference is optional. Multiple instances might exist.

An element detailing relevant references pertaining to the DeliveryInstruction, as indicated by the DeliveryInstructionReferenceType and AssignedBy.

CoLoading

CoLoading is optional. Multiple instances might exist.

A group item specifying information about items to be loaded or loaded on the same transport unit.

Used to identify:

- Delivery together to the drop point
- Transport Orders stuffed together in a container
- Transport Orders not splittable

DocumentInformation

DocumentInformation is optional. Multiple instances might exist.

A group element containing a specification of required documents in the business process. Additional free text to be printed on documents can also be specified.

DeliveryInstructionSequenceLineItem

DeliveryInstructionSequenceLineItem is mandatory. One instance is required, multiple instances might exist.

The group item DeliveryInstructionSequenceLineItem contains information for a line item of a DeliveryInstruction sequence. The line item specifies detail information about product quantities, loading and unloading characteristics, order numbers and other references.

AdditionalText

AdditionalText is optional. Multiple instances might exist.

A text field that is used to communicate information not previously defined or for special instructions. To be used only for circumstances not covered by specific elements.

ValidityPeriod

ValidityPeriod is optional. A single instance might exist.

The validity period for a specific item, e.g. the validity period for an e-Document.

DeliveryInstructionSequenceLineItem

The group item DeliveryInstructionSequenceLineItem contains information for a line item of a DeliveryInstruction sequence. The line item specifies detail information about product quantities, loading and unloading characteristics, order numbers and other references.

InstructionByType [attribute]

InstructionByType is mandatory. A single instance is required.

Provides the type for how goods are identified on group level when instructed for loading or delivery.

Refer to InstructionByType definition for any enumerations.

(sequence)

The sequence of items below is mandatory. A single instance is required.

DeliveryInstructionSequenceLineItemNumber

DeliveryInstructionSequenceLineItemNumber is mandatory. A single instance is required.

A sequential number that uniquely identifies the line item of a DeliveryInstruction Sequence.

PurchaseOrderInformation

PurchaseOrderInformation is optional. A single instance might exist.

A group item containing information unique to this PurchaseOrder, which is provided by the buyer. PurchaseOrderInformation can be optional in the supply chain. Invoices are created without having a PurchaseOrder in Vendor Managed Inventory. Freight invoices also will not have a PurchaseOrder number.

PurchaseOrderLineItemNumber

PurchaseOrderLineItemNumber is optional. A single instance might exist.

The sequential number that uniquely identifies the PurchaseOrder line item.

MillOrderNumber

MillOrderNumber is optional. A single instance might exist.

The manufacturing order number the mill uses.

MillOrderLineItemNumber

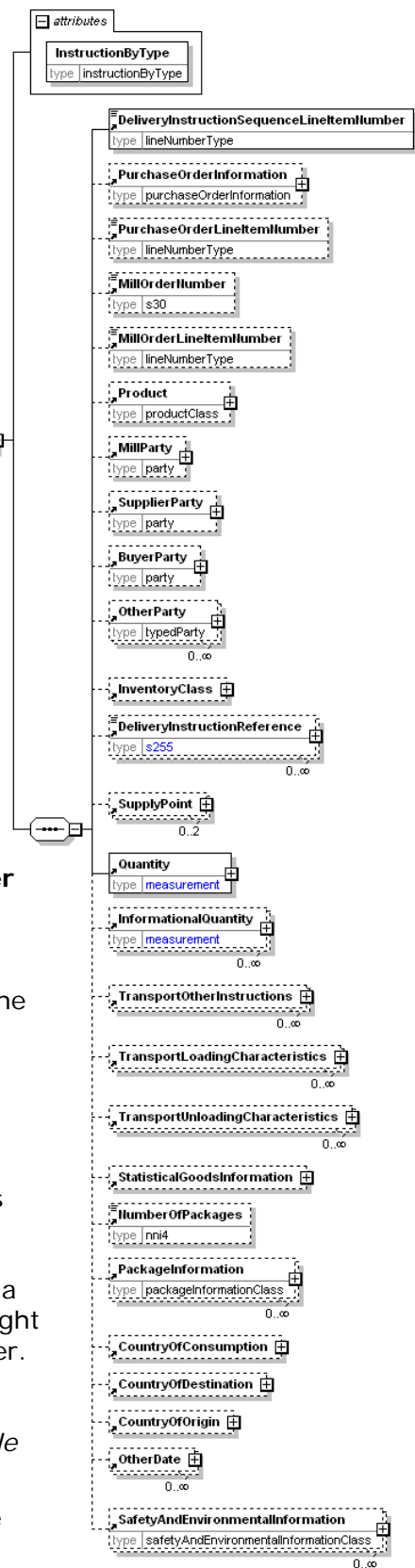

MillOrderLineItemNumber is optional. A single instance might exist.

A number that uniquely identifies the line items of the Mill Order.

Product

Product is optional. A single instance might exist.

Product is a group item defining the article and its characteristics. Product is used to specify product characteristics organized by ProductIdentifier, ProductDescription, and Classification. Book Manufacturing, Label Stock, Paper, Pulp, Recovered Paper, Wood Products, and Virgin Fibre market segments have defined their product characteristics and conversion features for implementation in papiNet.

MillParty

MillParty is optional. A single instance might exist.

The organisation or business entity that actually produces the product.

SupplierParty

SupplierParty is optional. A single instance might exist.

The organisation or business entity responsible for providing the product. SupplierParty is also the seller of the product, if Seller is not specified as OtherParty = Seller.

BuyerParty

BuyerParty is optional. A single instance might exist.

The legal entity to which the product is sold. Also commonly referred to as the sold-to party or customer. If no OtherParty is defined as the Payer, the Buyer is the Payer.

OtherParty

OtherParty is optional. Multiple instances might exist.

An organisation or business entity other than those specifically detailed within a e-Document.

InventoryClass

InventoryClass is optional. A single instance might exist.

A group item containing information about status of inventory and goods items.

DeliveryInstructionReference

DeliveryInstructionReference is optional. Multiple instances might exist.

An element detailing relevant references pertaining to the DeliveryInstruction, as indicated by the DeliveryInstructionReferenceType and AssignedBy.

SupplyPoint

SupplyPoint is optional. Two instances might exist.

Grouping element that contains items describing a supply point. A SupplyPoint belongs to a LocationParty, e.g. in a DeliveryOrigin or DeliveryDestination, and describes where goods are stored and can be loaded or unloaded. A SupplyPoint can for example be a loading or unloading gate at a warehouse or a road side landing at a logging area in the forest.

Quantity

Quantity is mandatory. A single instance is required.

The Quantity element contains attributes that provide information about the type of

quantity that is being communicated, the context in which the particular quantity is to be viewed, and (if the quantity represents an adjustment) an adjustment type.

The Quantity element contains three child elements that enable you to communicate a range of values for the quantity and a target or actual value. It is at this level (Value, RangeMin, and RangeMax) that the unit of measure is specified. This permits the range to be specified in a different unit of measure than the target.

InformationalQuantity

InformationalQuantity is optional. Multiple instances might exist.

A quantity given in a valid UOM used for information purposes only (not for calculation). For example, an ordered quantity was 100 reels as opposed to the invoice quantity of 20,000 pounds.

TransportOtherInstructions

TransportOtherInstructions is optional. Multiple instances might exist.

A group item defining any other instructions for the transport not covered in the description of transport mode, vehicle, unit, and loading characteristics or defining an alternative description for the categories mentioned above.

TransportLoadingCharacteristics

TransportLoadingCharacteristics is optional. Multiple instances might exist.

A group item defining how the transported items are to be loaded.

TransportUnloadingCharacteristics

TransportUnloadingCharacteristics is optional. Multiple instances might exist.

A group item defining how the transported items are to be unloaded.

StatisticalGoodsInformation

StatisticalGoodsInformation is optional. A single instance might exist.

A group item containing statistical information about handled or traded goods.

NumberOfPackages

NumberOfPackages is optional. A single instance might exist.

The number of packages in the delivery.

PackageInformation

PackageInformation is optional. Multiple instances might exist.

The purpose of the PackageInformation structure is to clearly identify physical handling items that constitute the delivery.

PackageInformation is the highest level of product packaging it describes the shipping or warehousing unit.

If you are communicating a package, usually for logistics or transport purposes, you should include the PackageType, Identifier, ItemCount, and Quantity. (Note: you still have the ability to describe the item with one of the "named" items.)

If you are communicating one of the named Items there is no need to include PackageType, Identifier, ItemCount, and Quantity.

Since either of these two approaches can be used the entire contents of this element are optional even though the parent may be required. It is expected that you will fill in the appropriate details.

CountryOfConsumption

papiNet V2R31

CountryOfConsumption is optional. A single instance might exist.

The country of consumption for the material.

CountryOfDestination

CountryOfDestination is optional. A single instance might exist.

The country where the goods will be, or were, shipped to.

CountryOfOrigin

CountryOfOrigin is optional. A single instance might exist.

The country of origin for the material.

OtherDate

OtherDate is optional. Multiple instances might exist.

A date that may not be specifically detailed within a document (example: print date at the PurchaseOrderLineItem).

SafetyAndEnvironmentalInformation

SafetyAndEnvironmentalInformation is optional. Multiple instances might exist.

Name of certification type, if any, on the goods (For example, FSC, PEFC). SafetyAndEnvironmental needs a value or measurement to communicate the percentage of the product is certified (for example, 75% is certified by the indicated agency).

DeliveryInstructionSequenceLineItemNumber

A sequential number that uniquely identifies the line item of a DeliveryInstruction Sequence.

DeliveryInstructionSequenceLineItemNumber
type lineNumberType

DeliveryInstructionSequenceNumber

A sequential number that uniquely identifies the Sequence of a DeliveryInstruction.

DeliveryInstructionSequenceNumber
type lineNumberType

DeliveryInstructionSequenceStatusType [attribute]

DeliveryInstruction sequence status type identifies the status of the DeliveryInstruction sequence

This item is restricted to the following list.

attribute
DeliveryInstructionSequenceStatusType
type deliveryInstructionSequenceStatusType

Cancelled

The supplied information has been cancelled. Items that have been cancelled are not included in totals on the summary levels of the e-Document.

New

The supplied information is new and supplied for the first time.

NoAction

The supplied information has not been amended and thereby requires no action.

Replaced

The supplied information is replacing earlier supplied information. The receiver should revalidate the information in their system based upon the entire information received.

DeliveryInstructionStatusType [attribute]

Identifies the status of the entire DeliveryInstruction (in other words, at the root level).



This item is restricted to the following list.

Amended

The supplied information is changed

Cancelled

The supplied information has been cancelled. Items that have been cancelled are not included in totals on the summary levels of the e-Document.

Original

The supplied information is the first version of that information.

DeliveryInstructionSummary

The DeliveryInstruction Summary provides summary information used to verify the contents of the e-Document.

(sequence)

The sequence of items below

is mandatory. A single instance is required.

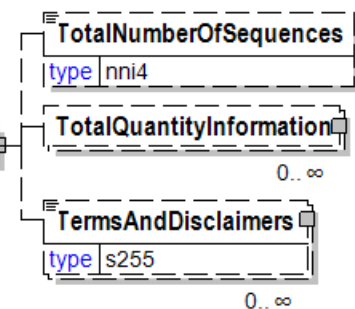
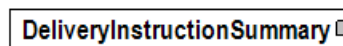

TotalNumberOfSequences

TotalNumberOfSequences is optional. A single instance might exist.

The total number of sequences in the document.

TotalQuantityInformation

TotalQuantityInformation is optional. Multiple instances might exist.

A group item containing information about the total quantity and total informational quantity of similar items in the document. TotalQuantityInformation is primarily used in the summary section of e-Documents where it is repeatable to permit totalling for different units of measure.

TermsAndDisclaimers

TermsAndDisclaimers is optional. Multiple instances might exist.

An element that contains legal information with an indication of what the Language is.

DeliveryInstructionType [attribute]

DeliveryInstructionType defines the type of DeliveryInstruction.

This item is restricted to the following list.

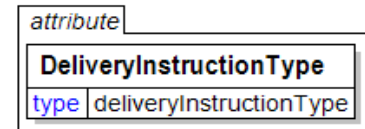

DeliveryInstruction

A DeliveryInstruction can specify many delivery events. Each event can contain quantity for one or many loads. A sequence in a DeliveryInstruction specifies all details for one event. The receiver of a DeliveryInstruction can generate many Loading Instructions from one DeliveryInstruction.

LoadingInstruction

A Loading Instruction specifies loading of transport units. A Forwarder receiving a DeliveryInstruction from a supplier can convert it into many Loading Instructions, which are sent to a Warehouse Operator. A sequence in a Loading Instruction specifies all details how to load one transport unit. A Loading Instruction can include goods from many delivery instructions and also goods belonging to many suppliers.

DeliveryLastDateOfChange

The final Date and optionally Time that a line item or delivery line may be amended or cancelled by the buyer.

The final Date and optionally Time that a line item or delivery line

may be amended or cancelled by the buyer. For example, the buyer can cancel each a delivery line before the DeliveryLastDateOfChange received from the seller on the OrderConfirmation.

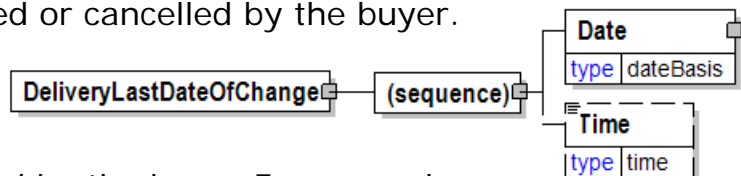

(sequence)

The sequence of items below is mandatory. A single instance is required.

Date

Date is mandatory. A single instance is required.

A group element that contains the specification of Year, Month, and Day.

Time

Time is optional. A single instance might exist.

Times are treated in a standard XML fashion with a special case used to indicate a generalized "local" time. The standard XML approach to time is hh:mm:ss, hh:mm:ssZ, or hh:mm:ss±hh:mm.

hh:mm:ss±hh:mm is used to represent a time with a time zone. The time zone is communicated as the number of hours offset from the Universal Time Coordinate (UTC), a.k.a. Greenwich Mean Time.

papiNet V2R31

hh:mm:ssZ indicates the time at Zulu (another name for UTC). Based on the convention described in the next bullet it will be important for users within UTC to use "Z" when communicating a time in their time zone to other users.

hh:mm:ss or hh:mm indicates in the XML standard the time at UTC however, within papiNet it is used to represent the applicable local time. Caution should be used when processing times of this nature as the papiNet approach may be in discord with other users of XML.

DeliveryLeg

A DeliveryLeg details the sequence, origin, transportation, and destination of each part of the delivery. More than one leg may be required if there is a change of mode, vehicle, or carrier.

Although transportation information is optional, it is strongly recommended that any transportation information available be sent.

DeliveryModeType [attribute]

DeliveryModeType is optional. A single instance might exist.

Provides delivery mode type that specifies if transport arrangement is needed or not.

Refer to DeliveryModeType definition for any enumerations.

DeliveryLegType [attribute]

DeliveryLegType is optional. A single instance might exist.

Provides the delivery leg type that specifies if delivery schedule is supplied or not.

Refer to DeliveryLegType definition for any enumerations.

EventType [attribute]

EventType is optional. A single instance might exist.

The type of transportation event that the DeliveryLeg represents.

Refer to EventType definition for any enumerations.

LegStageType [attribute]

LegStageType is optional. A single instance might exist.

LegStageType is used to identify whether this is the primary transportation process or a transportation process that comes before or after the main transportation process.

Refer to LegStageType definition for any enumerations.

TransportContextType [attribute]

TransportContextType is optional. A single

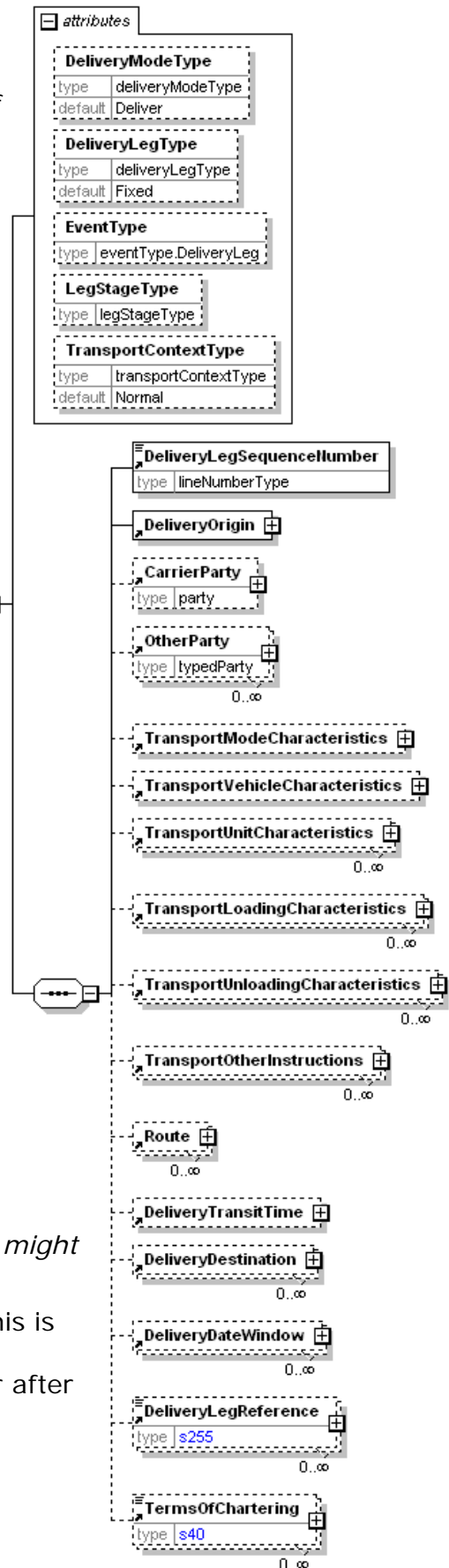

instance might exist.

Provides information about the reason for the transport.

Refer to TransportContextType definition for any enumerations.

(sequence)

The sequence of items below is mandatory. A single instance is required.

DeliveryLegSequenceNumber

DeliveryLegSequenceNumber is mandatory. A single instance is required.

The sequential number of the delivery leg. Applicable to multiple delivery segments.

DeliveryOrigin

DeliveryOrigin is mandatory. A single instance is required.

A group item that represents the start of one leg in a route. Compare to DeliveryDestination.

The DeliveryOrigin specifies the start of one leg of the delivery.

In order to comply with the US Trade Act of 2002 you would use this element with a LocationParty/@PartyType of Port.

CarrierParty

CarrierParty is optional. A single instance might exist.

The party performing the transport of the product from the pickup location to the ship-to location; could be a hauler.

OtherParty

OtherParty is optional. Multiple instances might exist.

An organisation or business entity other than those specifically detailed within a e-Document.

TransportModeCharacteristics

TransportModeCharacteristics is optional. A single instance might exist.

A group item defining the primary mode of transport.

TransportVehicleCharacteristics

TransportVehicleCharacteristics is optional. A single instance might exist.

A group item defining the primary means of transporting the goods, such as a side port vessel. In some instances, the transport unit and vehicle are the same.

TransportUnitCharacteristics

TransportUnitCharacteristics is optional. Multiple instances might exist.

A group item defining and identifying the primary means of containing the goods. In some instances, the transport unit and vehicle are the same.

TransportLoadingCharacteristics

TransportLoadingCharacteristics is optional. Multiple instances might exist.

A group item defining how the transported items are to be loaded.

TransportUnloadingCharacteristics

TransportUnloadingCharacteristics is optional. Multiple instances might exist.

A group item defining how the transported items are to be unloaded.

TransportOtherInstructions

TransportOtherInstructions is optional. Multiple instances might exist.

A group item defining any other instructions for the transport not covered in the description of transport mode, vehicle, unit, and loading characteristics or defining an alternative description for the categories mentioned above.

Route

Route is optional. Multiple instances might exist.

Route defines directions and characteristics for how to transport goods between two locations. A route starts at delivery origin or at the supplypoint belonging to the delivery origin.

DeliveryTransitTime

DeliveryTransitTime is optional. A single instance might exist.

A group item representing the number of Days and optionally Hours and Minutes between origin and destination for a DeliveryLeg.

DeliveryDestination

DeliveryDestination is optional. A Multiple instances might exist.

The DeliveryDestination specifies the end of one leg of the delivery. In order to comply with the US Trade Act of 2002 you would use this element with a LocationParty/@PartyType of Port.

DeliveryDateWindow

DeliveryDateWindow is optional. Multiple instances might exist.

A group item defining the date/time interval for delivery to take place. An element which may contain the estimated date for which delivery is expected. This date is not absolute.

DeliveryLegReference

DeliveryLegReference is optional. Multiple instances might exist.

A reference that applies to the delivery leg.

TermsOfChartering

TermsOfChartering is optional. Multiple instances might exist.

The terms of the vessel chartering. There are multiple types of TermsOfChartering that need to be specified. E.g.: Loading Terms and Unloading Terms

DeliveryLegReference

A reference that applies to the delivery leg.

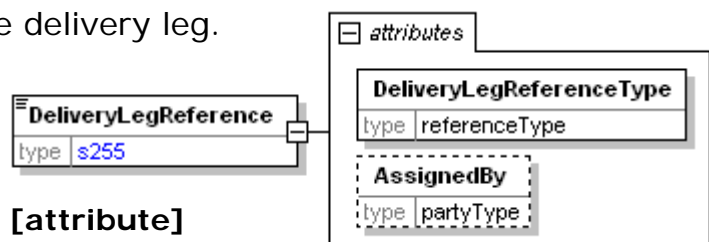

DeliveryLegReferenceType [attribute]

DeliveryLegReferenceType is mandatory. A single instance is required.

Provides a contextual explanation of the specific reference identifier. Many items are currently prefixed by "Buyer", "Forwarder", "Manufacturer", "Mill",

"Seller", "Supplier", "Warehouse", or "Vendor". Check for an existing non-prefixed version and use the non-prefixed version instead. In the (yet to be announced release date) version 3.0 the prefixed versions will be removed. Instead the attribute @AssignedBy will communicate the information previously communicated in the prefix.

Refer to DeliveryLegReferenceType definition for any enumerations.

AssignedBy [attribute]

AssignedBy is optional. A single instance might exist.

Identifies the type of party that has assigned the associated item, e.g. a reference of type OrderNumber.

Refer to AssignedBy for any enumerations.

DeliveryLegReferenceType [attribute]

Provides a contextual explanation of the specific reference identifier. Many items are currently prefixed by "Buyer", "Forwarder", "Manufacturer", "Mill", "Seller", "Supplier", "Warehouse", or "Vendor". Check for an existing non-prefixed version and use the non-prefixed version instead. In the (yet to be announced release date) version 3.0 the prefixed versions will be removed. Instead the attribute @AssignedBy will communicate the information previously communicated in the prefix.

attribute	
DeliveryLegReferenceType	
type	referenceType

Refer to the [referenceType](#) entry for the list of enumerations and their definitions.

DeliveryLegSequenceNumber

The sequential number of the delivery leg.
Applicable to multiple delivery segments.

DeliveryLegSequenceNumber	
type	lineNumberType

DeliveryLegType [attribute]

Provides the delivery leg type that specifies if delivery schedule is supplied or not.

This item is restricted to the following list.

Fixed

The delivery schedule is supplied and defined.

Open

The delivery schedule is open and will be given later by other party. This type is often used when goods are picked-up at the warehouse by customer.

attribute	
DeliveryLegType	
type	deliveryLegType
default	Fixed

DeliveryLineNumber

A sequential number that uniquely identifies a delivery line of the DeliverySchedule; a delivery line consists of a quantity and a date range for the delivery to take place.

DeliveryLineNumber	
type	lineNumberType

DeliveryMessage

The DeliveryMessage element is the root element for the DeliveryMessage e-Document.

The DeliveryMessage e-Document enables the sender to describe the contents and configuration of a shipment at various levels of detail.

DeliveryMessageType [attribute]

DeliveryMessageType is mandatory. A single instance is required.

DeliveryMessageType defines the type of DeliveryMessage.

Refer to DeliveryMessageType definition for any enumerations.

DeliveryMessageStatusType [attribute]

DeliveryMessageStatusType is mandatory. A single instance is required.

Identifies the status of the entire DeliveryMessage (in other words, at the root level).

Refer to DeliveryMessageStatusType definition for any enumerations.

DeliveryMessageContextType [attribute]

DeliveryMessageContextType is optional. A single instance might exist.

Communicates the reason for this delivery. If not present then this is a standard, typical delivery.

Refer to DeliveryMessageContextType definition for any enumerations.

Reissued [attribute]

Reissued is optional. A single instance might exist.

Either "Yes" or "No".

Refer to Reissued definition for any enumerations.

Language [attribute]

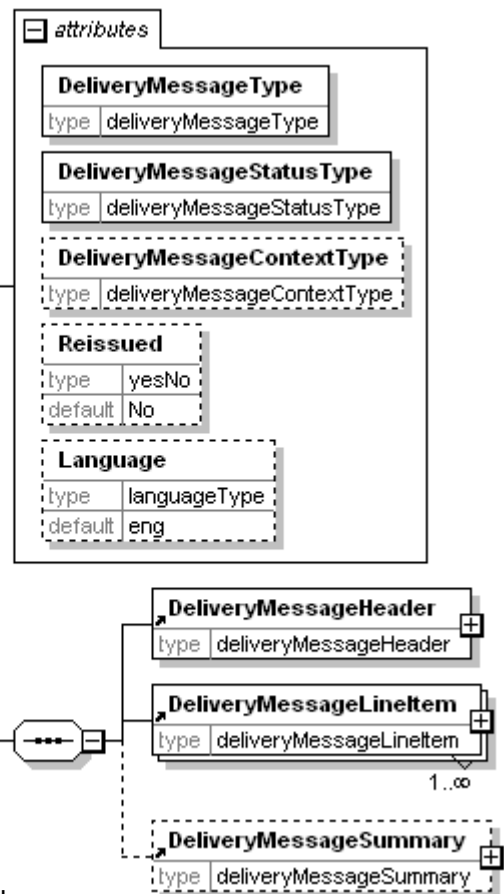

Language is optional. A single instance might exist.

XML has embraced 2 and 3 digit language codes through the application of an addendum to the standard.

Refer to Language definition for any enumerations.

(sequence)

The sequence of items below is mandatory. A single instance is required.

DeliveryMessageHeader

DeliveryMessageHeader is mandatory. A single instance is required.

The DeliveryMessageHeader contains information common to the entire delivery.

DeliveryMessageLineItem

DeliveryMessageLineItem is mandatory. One instance is required, multiple instances might exist.

The DeliveryMessageLineItem specifies details for an individual delivery line.

DeliveryMessageSummary

DeliveryMessageSummary is optional. A single instance might exist.

Summary information that applies to the entire DeliveryMessage.

DeliveryMessageBook

The DeliveryMessageBook element is the root element for the DeliveryMessageBook e-Document.

The DeliveryMessageBook e-Document enables the sender to describe the contents and configuration of a shipment at various levels of detail.

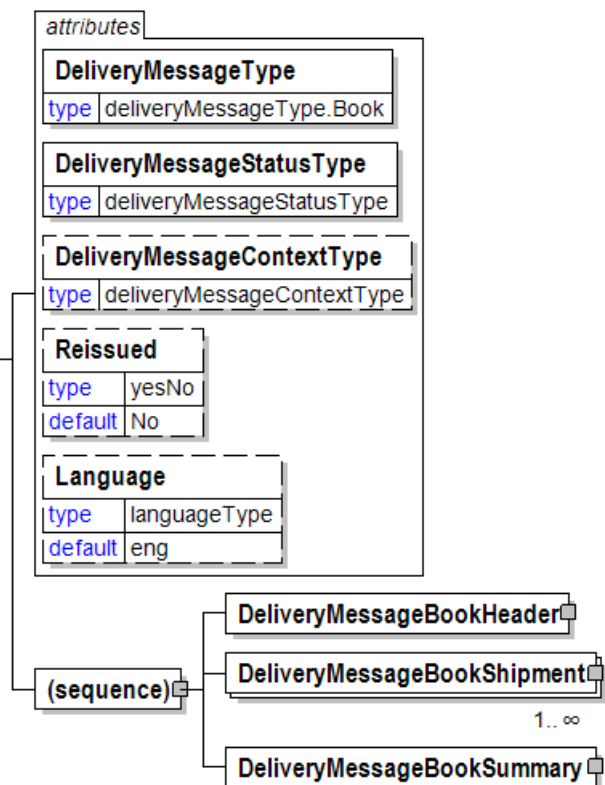
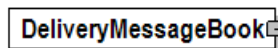

DeliveryMessageType [attribute]

DeliveryMessageType is mandatory. A single instance is required.

DeliveryMessageType defines the type of DeliveryMessage.

Refer to DeliveryMessageType definition for any enumerations.

DeliveryMessageStatusType [attribute]

DeliveryMessageStatusType is mandatory. A single instance is required.

Identifies the status of the entire DeliveryMessage (in other words, at the root level).

Refer to DeliveryMessageType definition for any enumerations.

DeliveryMessageContextType [attribute]

DeliveryMessageContextType is optional. A single instance might exist.

Communicates the reason for this delivery. If not present then this is a standard, typical delivery.

Refer to DeliveryMessageContextType definition for any enumerations.

Reissued [attribute]

Reissued is optional. A single instance might exist.

Either "Yes" or "No".

Refer to Reissued definition for any enumerations.

Language [attribute]

Language is optional. A single instance might exist.

XML has embraced 2 and 3 digit language codes through the application of an addendum to the standard.

Refer to Language definition for any enumerations.

(sequence)

The sequence of items below is mandatory. A single instance is required.

DeliveryMessageBookHeader

DeliveryMessageBookHeader is mandatory. A single instance is required.

The DeliveryMessageBookHeader is required and contains information common to the entire delivery.

DeliveryMessageBookShipment

DeliveryMessageBookShipment is mandatory. One instance is required, multiple instances might exist.

DeliveryMessageBookShipment is required. The DeliveryMessageBookShipment specifies an individual shipment. It may contain many shipment line items.

DeliveryMessageBookSummary

DeliveryMessageBookSummary is mandatory. A single instance is required.

DeliveryMessageBookSummary is a required element.

DeliveryMessageBookHeader

The DeliveryMessageBookHeader is required and contains information common to the entire delivery.

(sequence)

The sequence of items below is mandatory. A single instance is required.

DeliveryMessageNumber

DeliveryMessageNumber is mandatory. A single instance is required.

A unique delivery identifier assigned to each DeliveryMessage as agreed between the trading partners.

TransactionHistoryNumber

TransactionHistoryNumber is optional. A single instance might exist.

A sequential number that keeps track of the version of a document being sent by the document originator except in the case where TransactionHistoryConfirmation is used, in which case the TransactionHistoryNumber refers to the trigger transaction for which the confirmation is being sent.

DeliveryMessageDate

DeliveryMessageDate is mandatory. A single instance is required.

The Date and Time when the DeliveryMessage was issued.

DeliveryMessageReference

DeliveryMessageReference is optional. Multiple instances might exist.

An element that identifies the relevant references pertaining to the DeliveryMessage, identified by DeliveryMessageReferenceType.

BuyerParty

BuyerParty is mandatory. A single instance is required.

The legal entity to which the product is sold. Also commonly referred to as the sold-to party or customer. If no OtherParty is defined as the Payer, the Buyer is the Payer.

BillToParty

BillToParty is optional. A single instance might exist.

The address where the Invoice is to be sent.

SupplierParty

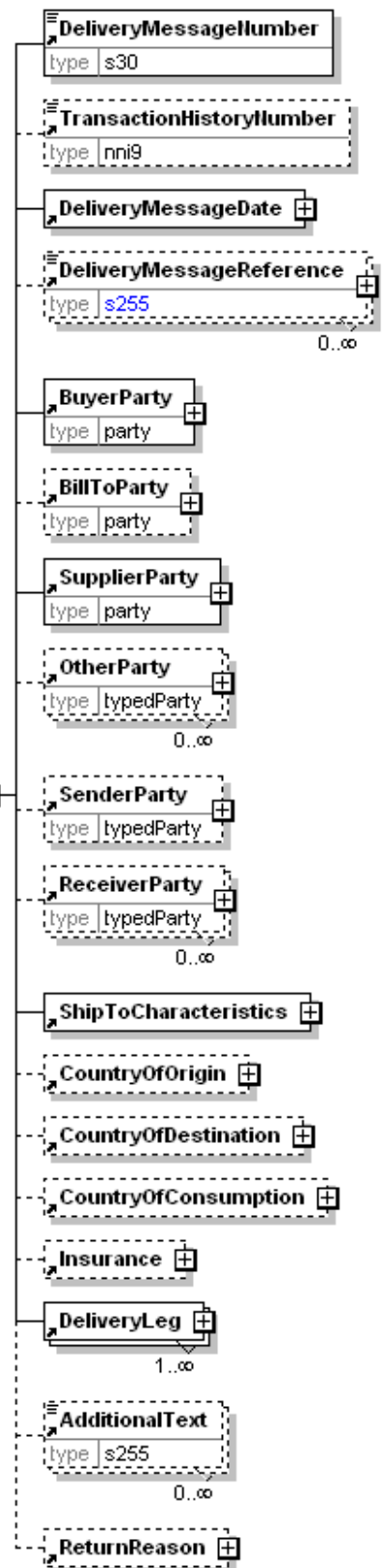

SupplierParty is mandatory. A single instance is required.

The organisation or business entity responsible for providing the product. SupplierParty is also the seller of the product, if Seller is not specified as OtherParty = Seller.

OtherParty

OtherParty is optional. Multiple instances might exist.

An organisation or business entity other than those specifically detailed within a e-Document.

SenderParty

SenderParty is optional. A single instance might exist.

The business entity issuing the e-Document, the source of the document.

The entity responsible for the content. If the sender party has out sourced the message service to a third party the SenderParty is the issuer of the e-Document and not the party performing the transmission service of the electronic message.

ReceiverParty

ReceiverParty is optional. Multiple instances might exist.

The business entity for whom the e-Document is intended, the destination of the document.

The entity interested in the content. If the receiver party has outsourced the message service to a third party the ReceiverParty is the intended party for the e-Document and not the party performing the receiving service of the electronic message.

ShipToCharacteristics

ShipToCharacteristics is mandatory. A single instance is required.

A group item that provides information important for the Ship-To Party.

A group item that provides information important for the Ship-To Party. ShipToCharacteristics may be referenced at both the header and line item level. The reference at the header is required and acts as a default for the value at the line level, unless overridden at the line level.

CountryOfOrigin

CountryOfOrigin is optional. A single instance might exist.

The country of origin for the material.

CountryOfDestination

CountryOfDestination is optional. A single instance might exist.

The country where the goods will be, or were, shipped to.

CountryOfConsumption

CountryOfConsumption is optional. A single instance might exist.

The country of consumption for the material.

Insurance

Insurance is optional. A single instance might exist.

Group element containing information about insurance

DeliveryLeg

DeliveryLeg is mandatory. One instance is required, multiple instances might exist.

A DeliveryLeg details the sequence, origin, transportation, and destination of each part of the delivery. More than one leg may be required if there is a change of mode, vehicle, or carrier.

Although transportation information is optional, it is strongly recommended that any transportation information available be sent.

AdditionalText

AdditionalText is optional. Multiple instances might exist.

A text field that is used to communicate information not previously defined or for special instructions. To be used only for circumstances not covered by specific elements.

ReturnReason

ReturnReason is optional. A single instance might exist.

A group item containing the reason for the Return

DeliveryMessageBookShipment

DeliveryMessageBookShipment is required.
The DeliveryMessageBookShipment specifies an individual shipment. It may contain many shipment line items.

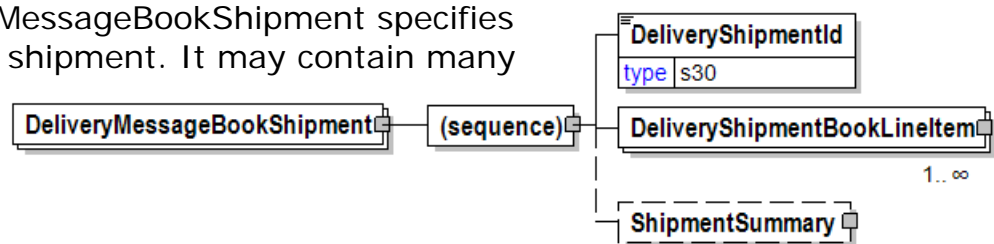

(sequence)

The sequence of items below is mandatory. A single instance is required.

DeliveryShipmentId

DeliveryShipmentId is mandatory. A single instance is required.

Unique identifier for the shipment

DeliveryShipmentBookLineItem

DeliveryShipmentBookLineItem is mandatory. One instance is required, multiple instances might exist.

DeliveryShipmentBookLineItem is required. The DeliveryShipmentBookLineItem specifies an individual shipment delivery line for one PurchaseOrder and PurchaseOrder line item.

ShipmentSummary

ShipmentSummary is optional. A single instance might exist.

Summary information for an entire shipment

DeliveryMessageBookSummary

DeliveryMessageBookSummary is a required element.

(sequence)

The sequence of items below is mandatory. A single instance is required.

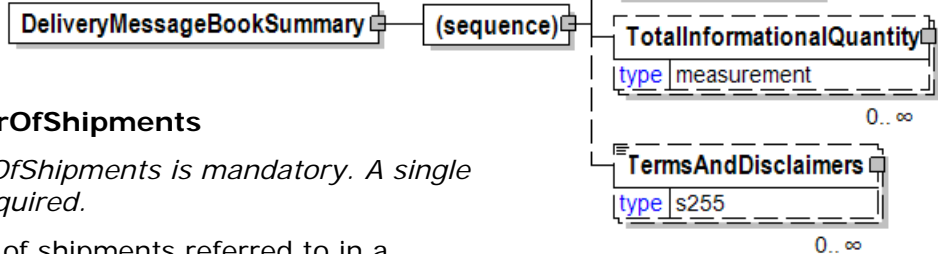

TotalNumberOfShipments

TotalNumberOfShipments is mandatory. A single instance is required.

Total number of shipments referred to in a DeliveryMessage.

TotalQuantity

TotalQuantity is optional. A single instance might exist.

The total quantity of similar items in the e-Document. TotalQuantity is primarily used in the summary section of documents where it is repeatable to permit totaling for different units of measure.

TotalInformationalQuantity

TotalInformationalQuantity is optional. Multiple instances might exist.

A quantity that is used to communicate related information about the parent element. This element represents a total that is derived from individual line items.

TermsAndDisclaimers

TermsAndDisclaimers is optional. Multiple instances might exist.

An element that contains legal information with an indication of what the Language is.

DeliveryMessageContextType [attribute]

Communicates the reason for this delivery. If not present then this is a standard, typical delivery.

This item is restricted to the following list.

Return

The delivery supports the goods return process.



DeliveryMessageDate

The Date and Time when the DeliveryMessage was issued.

(sequence)

The sequence of items below is mandatory. A single instance is required.

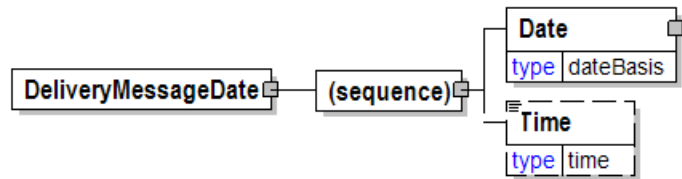

Date

Date is mandatory. A single instance is required.

A group element that contains the specification of Year, Month, and Day.

Time

Time is optional. A single instance might exist.

Times are treated in a standard XML fashion with a special case used to indicate a generalized "local" time. The standard XML approach to time is hh:mm:ss, hh:mm:ssZ, or hh:mm:ss±hh:mm.

hh:mm:ss±hh:mm is used to represent a time with a time zone. The time zone is communicated as the number of hours offset from the Universal Time Coordinate (UTC), a.k.a. Greenwich Mean Time.

hh:mm:ssZ indicates the time at Zulu (another name for UTC). Based on the convention described in the next bullet it will be important for users within UTC to use "Z" when communicating a time in their time zone to other users.

hh:mm:ss or hh:mm indicates in the XML standard the time at UTC however, within papiNet it is used to represent the applicable local time. Caution should be used when processing times of this nature as the papiNet approach may be in discord with other users of XML.

DeliveryMessageHeader

The DeliveryMessageHeader contains information common to the entire delivery.

(sequence)

The sequence of items below is mandatory. A single instance is required.

DeliveryMessageNumber

DeliveryMessageNumber is mandatory. A single instance is required.

A unique delivery identifier assigned to each DeliveryMessage as agreed between the trading partners.

TransactionHistoryNumber

TransactionHistoryNumber is optional. A single instance might exist.

A sequential number that keeps track of the version of a document being sent by the document originator except in the case where TransactionHistoryConfirmation is used, in which case the

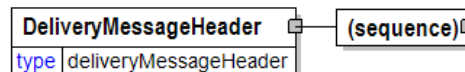

TransactionHistoryNumber refers to the trigger transaction for which the confirmation is being sent.

DeliveryMessageDate

DeliveryMessageDate is mandatory. A single instance is required.

The Date and Time when the DeliveryMessage was issued.

DeliveryMessageReference

DeliveryMessageReference is optional. Multiple instances might exist.

An element that identifies the relevant references pertaining to the DeliveryMessage, identified by DeliveryMessageReferenceType.

BuyerParty

BuyerParty is optional. A single instance might exist.

The legal entity to which the product is sold. Also commonly referred to as the sold-to party or customer. If no OtherParty is defined as the Payer, the Buyer is the Payer.

BillToParty

BillToParty is optional. A single instance might exist.

The address where the Invoice is to be sent.

SupplierParty

SupplierParty is optional. A single instance might exist.

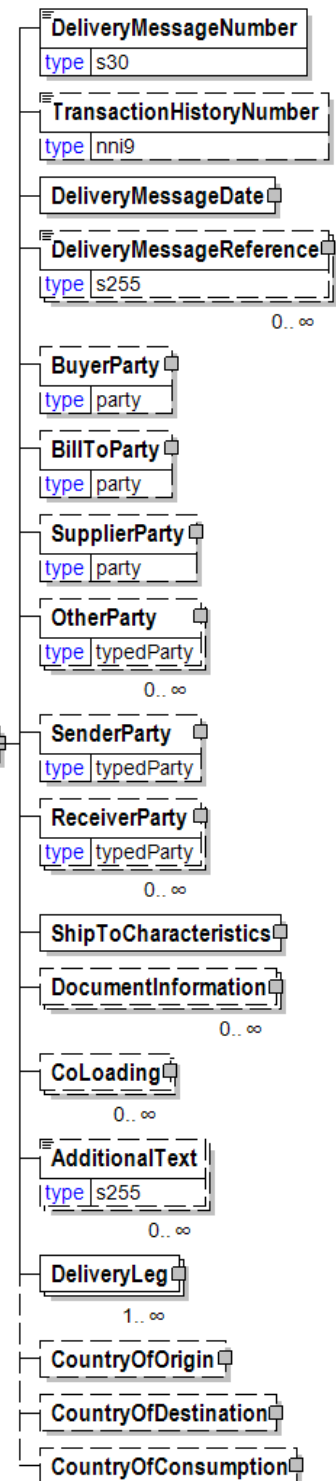

The organisation or business entity responsible for providing the product. SupplierParty is also the seller of the product, if Seller is not specified as OtherParty = Seller.

OtherParty

OtherParty is optional. Multiple instances might exist.

An organisation or business entity other than those specifically detailed within a e-Document.

SenderParty

SenderParty is optional. A single instance might exist.

The business entity issuing the e-Document, the source of the document.

The entity responsible for the content. If the sender party has out sourced the message service to a third party the SenderParty is the issuer of the e-Document and not the party performing the transmission service of the electronic message.

ReceiverParty

ReceiverParty is optional. Multiple instances might exist.

The business entity for whom the e-Document is intended, the destination of the document.

The entity interested in the content. If the receiver party has outsourced the message service to a third party the ReceiverParty is the intended party for the e-Document and not the party performing the receiving service of the electronic message.

ShipToCharacteristics

ShipToCharacteristics is mandatory. A single instance is required.

A group item that provides information important for the Ship-To Party.

A group item that provides information important for the Ship-To Party. ShipToCharacteristics may be referenced at both the header and line item level. The reference at the header is required and acts as a default for the value at the line level, unless overridden at the line level.

DocumentInformation

DocumentInformation is optional. Multiple instances might exist.

A group element containing a specification of required documents in the business process. Additional free text to be printed on documents can also be specified.

CoLoading

CoLoading is optional. Multiple instances might exist.

A group item specifying information about items to be loaded or loaded on the same transport unit.

Used to identify:

- Delivery together to the drop point
- Transport Orders stuffed together in a container
- Transport Orders not splittable

AdditionalText

AdditionalText is optional. Multiple instances might exist.

A text field that is used to communicate information not previously defined or for

special instructions. To be used only for circumstances not covered by specific elements.

DeliveryLeg

DeliveryLeg is mandatory. One instance is required, multiple instances might exist.

A DeliveryLeg details the sequence, origin, transportation, and destination of each part of the delivery. More than one leg may be required if there is a change of mode, vehicle, or carrier.

Although transportation information is optional, it is strongly recommended that any transportation information available be sent.

CountryOfOrigin

CountryOfOrigin is optional. A single instance might exist.

The country of origin for the material.

CountryOfDestination

CountryOfDestination is optional. A single instance might exist.

The country where the goods will be, or were, shipped to.

CountryOfConsumption

CountryOfConsumption is optional. A single instance might exist.

The country of consumption for the material.

DeliveryMessageLineItem

The DeliveryMessageLineItem specifies details for an individual delivery line.

ShipmentComplete [attribute]

ShipmentComplete is optional. A single instance might exist.

Indicates that all shipments for the particular delivery item are complete

Refer to ShipmentComplete definition for any enumerations.

InstructionByType [attribute]

InstructionByType is optional. A single instance might exist.

Provides the type for how goods are identified on group level when instructed for loading or delivery.

Refer to InstructionByType definition for any enumerations.

(sequence)

The sequence of items below is mandatory. A single instance is required.

DeliveryMessageLineItem Number

DeliveryMessageLineItemNumber is mandatory. A single instance is required.

The sequential number that uniquely identifies the delivery line item.

PurchaseOrderInformation

PurchaseOrderInformation is optional. A single instance might exist.

A group item containing information unique to this PurchaseOrder, which is provided by the buyer. PurchaseOrderInformation can be optional in the supply chain. Invoices are created without having a PurchaseOrder in Vendor Managed Inventory. Freight invoices also will not have a PurchaseOrder number.

PurchaseOrderLineItemNumber

PurchaseOrderLineItemNumber is optional. A single instance might exist.

The sequential number that uniquely identifies the PurchaseOrder line item.

DeliveryMessageReference

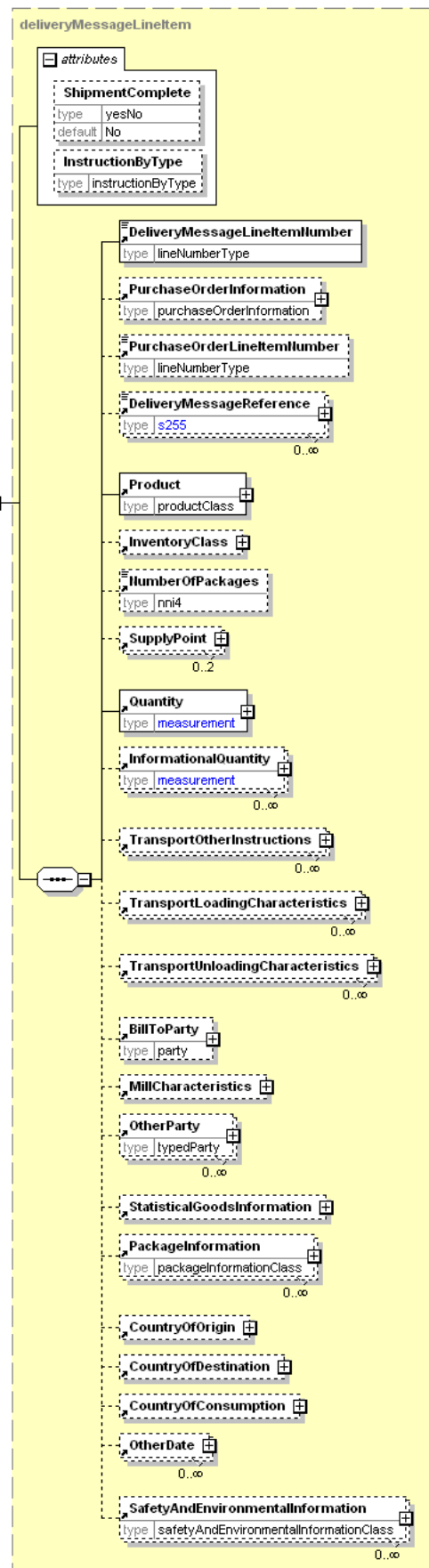

DeliveryMessageReference is optional. Multiple instances might exist.

An element that identifies the relevant references pertaining to the DeliveryMessage, identified by DeliveryMessageReferenceType.

Product

Product is mandatory. A single instance is required.

Product is a group item defining the article and its characteristics. Product is used to specify product characteristics organized by ProductIdentifier, ProductDescription, and Classification. Book Manufacturing, Label Stock, Paper, Pulp, Recovered Paper, Wood Products, and Virgin Fibre market segments have defined their product characteristics and conversion features for implementation in papiNet.

InventoryClass

InventoryClass is optional. A single instance might exist.

A group item containing information about status of inventory and goods items.

NumberOfPackages

NumberOfPackages is optional. A single instance might exist.

The number of packages in the delivery.

SupplyPoint

SupplyPoint is optional. Two instances might exist.

Grouping element that contains items describing a supply point. A SupplyPoint belongs to a LocationParty, e.g. in a DeliveryOrigin or DeliveryDestination, and describes where goods are stored and can be loaded or unloaded. A SupplyPoint can for example be a loading or unloading gate at a warehouse or a road side landing at a logging area in the forest.

Quantity

Quantity is mandatory. A single instance is required.

The Quantity element contains attributes that provide information about the type of quantity that is being communicated, the context in which the particular quantity is to be viewed, and (if the quantity represents an adjustment) an adjustment type.

The Quantity element contains three child elements that enable you to communicate a range of values for the quantity and a target or actual value. It is at this level (Value, RangeMin, and RangeMax) that the unit of measure is specified. This permits the range to be specified in a different unit of measure than the target.

InformationalQuantity

InformationalQuantity is optional. Multiple instances might exist.

A quantity given in a valid UOM used for information purposes only (not for calculation). For example, an ordered quantity was 100 reels as opposed to the invoice quantity of 20,000 pounds.

TransportOtherInstructions

TransportOtherInstructions is optional. Multiple instances might exist.

A group item defining any other instructions for the transport not covered in the description of transport mode, vehicle, unit, and loading characteristics or defining an alternative description for the categories mentioned above.

TransportLoadingCharacteristics

TransportLoadingCharacteristics is optional. Multiple instances might exist.

A group item defining how the transported items are to be loaded.

TransportUnloadingCharacteristics

*TransportUnloadingCharacteristics is optional. Multiple instances might exist
A group item defining how the transported items are to be unloaded.*

BillToParty

BillToParty is optional. A single instance might exist.

The address where the Invoice is to be sent.

MillCharacteristics

MillCharacteristics is optional. A single instance might exist.

A group item defining the mill party and machine identifier where a product is or was produced.

OtherParty

OtherParty is optional. Multiple instances might exist.

An organisation or business entity other than those specifically detailed within a e-Document.

StatisticalGoodsInformation

StatisticalGoodsInformation is optional. A single instance might exist.

A group item containing statistical information about handled or traded goods.

PackageInformation

PackageInformation is optional. Multiple instances might exist.

The purpose of the PackageInformation structure is to clearly identify physical handling items that constitute the delivery.

PackageInformation is the highest level of product packaging it describes the shipping or warehousing unit.

If you are communicating a package, usually for logistics or transport purposes, you should include the PackageType, Identifier, ItemCount, and Quantity. (Note: you still have the ability to describe the item with one of the "named" items.)

If you are communicating one of the named Items there is no need to include PackageType, Identifier, ItemCount, and Quantity.

Since either of these two approaches can be used the entire contents of this element are optional even though the parent may be required. It is expected that you will fill in the appropriate details.

CountryOfOrigin

CountryOfOrigin is optional. A single instance might exist.

The country of origin for the material.

CountryOfDestination

CountryOfDestination is optional. A single instance might exist.

The country where the goods will be, or were, shipped to.

CountryOfConsumption

CountryOfConsumption is optional. A single instance might exist.

The country of consumption for the material.

OtherDate

OtherDate is optional. Multiple instances might exist.

A date that may not be specifically detailed within a document (example: print date at the PurchaseOrderLineItem).

SafetyAndEnvironmentalInformation

SafetyAndEnvironmentalInformation is optional. Multiple instances might exist.

Name of certification type, if any, on the goods (For example, FSC, PEFC). SafetyAndEnvironmental needs a value or measurement to communicate the percentage of the product is certified (for example, 75% is certified by the indicated agency).

DeliveryMessageLineItemNumber

The sequential number that uniquely identifies the delivery line item.

DeliveryMessageLineItemNumber
type lineNumberType

DeliveryMessageNumber

A unique delivery identifier assigned to each DeliveryMessage as agreed between the trading partners.

DeliveryMessageNumber
type s30

DeliveryMessageProductGroup

The DeliveryMessageProductGroup permits the organization of a shipment by a product grouping.

(sequence)

The sequence of items below is mandatory. A single instance is required.

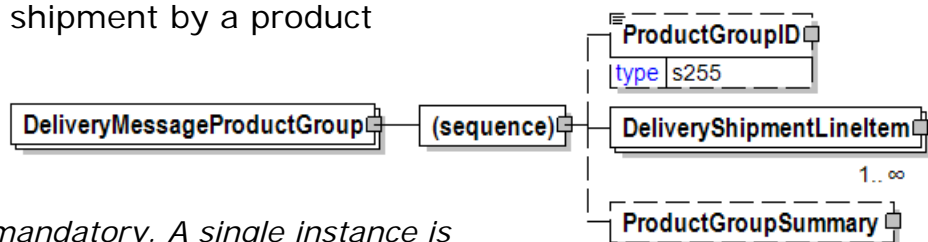

ProductGroupID

ProductGroupID is optional. A single instance might exist.

Possibility to group packages or Shipments. Example: Creating temporary group ID's for logistic reasons or lot number.

DeliveryShipmentLineItem

DeliveryShipmentLineItem is mandatory. One instance is required, multiple instances might exist.

The DeliveryShipmentLineItem specifies an individual delivery line for one order and order line item.

PackageInformation will be deprecated in the version following V2R30, it has been replaced with TransportPackageInformation.

You are encouraged to use TransportPackageInformation.

ProductGroupSummary

ProductGroupSummary is optional. A single instance might exist.

Group of elements to provide summary information on product level.

DeliveryMessageReelCharacteristics

A group item for actual measurement and manufacturing characteristics.

DeliveryMessageReelCharacteristics is intended to indicate the actual measurements that apply to a reel.

(sequence)

The sequence of items below is mandatory. A single instance is required.

ReelWidth

ReelWidth is optional. A single instance might exist.

The width of reel from edge to edge excluding packaging.

ReelDiameter

ReelDiameter is optional. A single instance might exist.

The diameter measurement of reel excluding packaging.

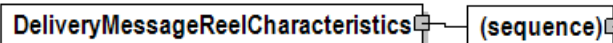

ReelLength

ReelLength is optional. A single instance might exist.

The total length of the paper on the reel.

MachineID

MachineID is optional. A single instance might exist.

An identifier assigned to the particular machine being referenced. For example, a machine could be a paper machine, an off-line coater, a sheeter, or a printing press. The particular machine being referenced will be determined by the business event being supported.

TambourID

TambourID is optional. A single instance might exist.

The unique identifier of the jumbo reel (also called mother reel or Tambour).

SetNumber

SetNumber is optional. A single instance might exist.

The part of the radius of the Tambour that constitutes the reel.

SetPosition

SetPosition is optional. A single instance might exist.

The position of the reel in relation to the reels cut across the Tambour.

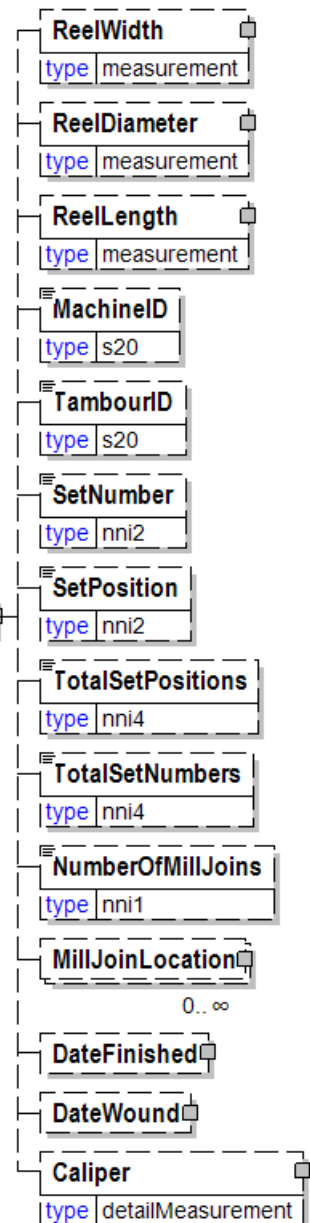

TotalSetPositions

TotalSetPositions is optional. A single instance might exist.

The total number of reels cut across the Tambour (in the width direction). Tambour is also called jumbo reel or mother reel.

TotalSetNumbers

TotalSetNumbers is optional. A single instance might exist.

The total number of sets wound from the Tambour (in the radial direction). Tambour is also called jumbo reel or mother reel.

NumberOfMillJoins

NumberOfMillJoins is optional. A single instance might exist.

The number of joins in the reel.

MillJoinLocation

MillJoinLocation is optional. Multiple instances might exist.

A group element detailing the location of each mill join in a reel. The element DeliveryMessageReelCharacteristics/NumberOfMillJoins gives the total number of joins in a reel. DeliveryMessageReelCharacteristics/MillJoinLocation would be repeated the NumberOfMillJoin times.

DateFinished

DateFinished is optional. A single instance might exist.

The Date and optionally the Time that an item was finished. For example, this could be the wrapping date for a reel or ream or the date the sheet(s) were packaged in preparation for shipment

DateWound

DateWound is optional. A single instance might exist.

The Date and optionally the Time that a reel was wound or produced from its parent. RewoundIndicator indicates if the reel has been rewound.

Caliper

Caliper is optional. A single instance might exist.

The thickness of a sheet of paper under standard test conditions.

DeliveryMessageReference

An element that identifies the relevant references pertaining to the DeliveryMessage, identified by

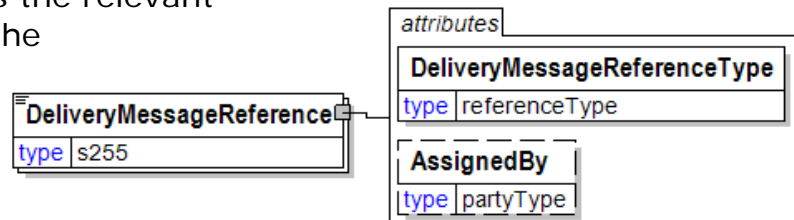

DeliveryMessageReferenceType.

DeliveryMessageReferenceType [attribute]

DeliveryMessageReferenceType is mandatory. A single instance is required.

Provides a contextual explanation of the specific reference identifier. Many items are currently prefixed by "Buyer", "Forwarder", "Manufacturer", "Mill",

"Seller", "Supplier", "Warehouse", or "Vendor". Check for an existing non-prefixed version and use the non-prefixed version instead. In the (yet to be announced release date) version 3.0 the prefixed versions will be removed. Instead the attribute @AssignedBy will communicate the information previously communicated in the prefix.

Refer to DeliveryMessageReferenceType definition for any enumerations.

AssignedBy [attribute]

AssignedBy is optional. A single instance might exist.

Identifies the type of party that has assigned the associated item, e.g. a reference of type OrderNumber.

Refer to AssignedBy for any enumerations.

DeliveryMessageReferenceType [attribute]

Provides a contextual explanation of the specific reference identifier. Many items are currently prefixed by "Buyer", "Forwarder", "Manufacturer", "Mill", "Seller", "Supplier", "Warehouse", or "Vendor". Check for an existing non-prefixed version and use the non-prefixed version instead. In the (yet to be announced release date) version 3.0 the prefixed versions will be removed. Instead the attribute @AssignedBy will communicate the information previously communicated in the prefix.

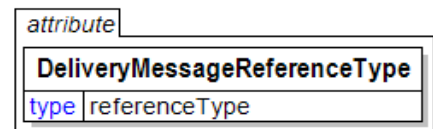

Refer to the [referenceType](#) entry for the list of enumerations and their definitions.

DeliveryMessageShipment

The DeliveryMessageShipment specifies an individual delivery shipment. It may contain product grouping within the shipment.

(sequence)

The sequence of items below is mandatory. A single instance is required.

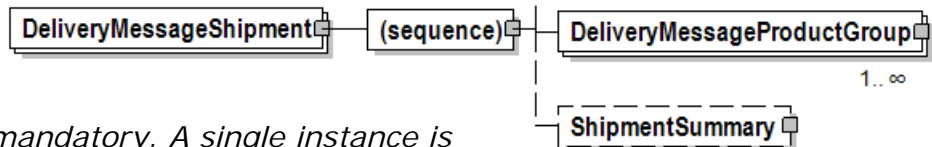

ShipmentID

ShipmentID is optional. A single instance might exist.

The ShipmentID may be a Bill of Lading Marking, which is customer's reference mark on each package used for logistic purposes. Should not be mixed up with Bill of Lading number. Another example of ShipmentID is grouping by a ContainerID.

DeliveryMessageProductGroup

DeliveryMessageProductGroup is mandatory. One instance is required, multiple instances might exist.

The DeliveryMessageProductGroup permits the organization of a shipment by a

product grouping.

ShipmentSummary

ShipmentSummary is optional. A single instance might exist.

Summary information for an entire shipment

DeliveryMessageStatusType [attribute]

Identifies the status of the entire DeliveryMessage (in other words, at the root level).



This item is restricted to the following list.

Cancelled

The supplied information has been cancelled. Items that have been cancelled are not included in totals on the summary levels of the e-Document.

Original

The supplied information is the first version of that information.

Replaced

The supplied information is replacing earlier supplied information. The receiver should revalidate the information in their system based upon the entire information received.

DeliveryMessageSummary

Summary information that applies to the entire DeliveryMessage.

(sequence)

The sequence of items below is mandatory. A single instance is required.

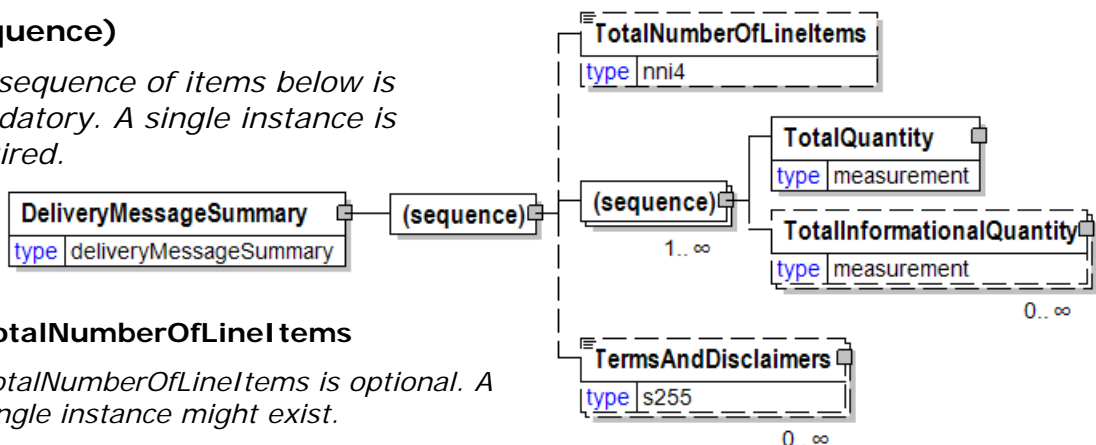

TotalNumberOfLineItems

TotalNumberOfLineItems is optional. A single instance might exist.

The total number of individual line items in the document, regardless of the status or type.

(sequence)

The sequence of items below is mandatory. One instance is required, multiple instances might exist.

TotalQuantity

TotalQuantity is mandatory. A single instance is required.

The total quantity of similar items in the e-Document. TotalQuantity is primarily used in the summary section of documents where it is repeatable to permit

totaling for different units of measure.

TotalInformationalQuantity

TotalInformationalQuantity is optional. Multiple instances might exist.

A quantity that is used to communicate related information about the parent element. This element represents a total that is derived from individual line items.

TermsAndDisclaimers

TermsAndDisclaimers is optional. Multiple instances might exist.

An element that contains legal information with an indication of what the Language is.

DeliveryMessageType (Book) [attribute]

DeliveryMessageType defines the type of DeliveryMessageBook.

This item is restricted to the following list.

attribute
DeliveryMessageType
type deliveryMessageType.Book

DeliveryMessage

A DeliveryMessage type that contains optional routing information, quantities at the DeliveryMessageLineItem level, and details at the DeliveryMessageLineItemDetail level. The seller uses a DeliveryMessage to provide delivery details to the ship-to party and tracking information.

InitialShipmentAdvice

A DeliveryMessage type that contains detailed routing information, quantities at the DeliveryMessageLineItem level and optionally details at the DeliveryMessageLineItemDetail level. The seller uses the InitialShipmentAdvice to provide preliminary notification of shipment routing and quantities (can be used as an advanced notice of delivery). The quantities indicated may not necessarily be delivered—for example, if there is damage in transit or the delivery is rerouted to another destination.

LoadedSpecification

A DeliveryMessage type that contains a specification of loaded goods on a transport unit (e.g. container, rail wagon). A loading specification (LoadedSpecification) can contain goods belonging to many suppliers and buyers and is normally referring to a Loading Instruction.

ShipmentAdvice

A DeliveryMessage type that contains a specification of goods, that are dispatched and will be delivered to a warehouse. A ShipmentAdvice can refer to a DeliveryInstruction Sequence or a CallOff, but is normally also used for notifying a receiving warehouse operator of shipments to the warehouse.

ThirdPartyShipmentAdvice

Notification of a shipment from a warehouse to a party other than the party that ordered the product from the supplier

Waybill

The forwarding agreement or carrying agreement that is used as a receipt for

cargo and as a contract of carriage.

DeliveryMessageType [attribute]

DeliveryMessageType defines the type of DeliveryMessage.

This item is restricted to the following list.



DeliveryMessage

A DeliveryMessage type that contains optional routing information, quantities at the DeliveryMessageLineItem level, and details at the DeliveryMessageLineItemDetail level. The seller uses a DeliveryMessage to provide delivery details to the ship-to party and tracking information.

InitialShipmentAdvice

A DeliveryMessage type that contains detailed routing information, quantities at the DeliveryMessageLineItem level and optionally details at the DeliveryMessageLineItemDetail level. The seller uses the InitialShipmentAdvice to provide preliminary notification of shipment routing and quantities (can be used as an advanced notice of delivery). The quantities indicated may not necessarily be delivered—for example, if there is damage in transit or the delivery is rerouted to another destination.

LoadedSpecification

A DeliveryMessage type that contains a specification of loaded goods on a transport unit (e.g. container, rail wagon). A loading specification (LoadedSpecification) can contain goods belonging to many suppliers and buyers and is normally referring to a Loading Instruction.

ShipmentAdvice

A DeliveryMessage type that contains a specification of goods, that are dispatched and will be delivered to a warehouse. A ShipmentAdvice can refer to a DeliveryInstruction Sequence or a CallOff, but is normally also used for notifying a receiving warehouse operator of shipments to the warehouse.

Waybill

The forwarding agreement or carrying agreement that is used as a receipt for cargo and as a contract of carriage.

DeliveryMessageType (Wood) [attribute]

DeliveryMessageType defines the type of DeliveryMessageWood.

This item is restricted to the following list.

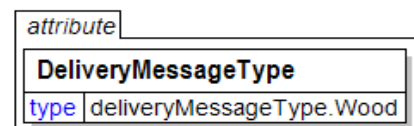

DeliveryMessage

A DeliveryMessage type that contains optional routing information, quantities at the DeliveryMessageLineItem level, and details at the DeliveryMessageLineItemDetail level. The seller uses a DeliveryMessage to provide delivery details to the ship-to party and tracking information.

InitialShipmentAdvice

A DeliveryMessage type that contains detailed routing information, quantities at the DeliveryMessageLineItem level and optionally details at the DeliveryMessageLineItemDetail level. The seller uses the InitialShipmentAdvice to provide preliminary notification of shipment routing and quantities (can be used as an advanced notice of delivery). The quantities indicated may not necessarily be delivered—for example, if there is damage in transit or the delivery is rerouted to another destination.

LoadingOrder

Specifies delivery schedule, the transport booking requirements and shipping instructions, as well as the internal work order for the shipment

PackingSpecification

A Packing Specification is a business transaction specifying the complete consignment being shipped from a consignor to a consignee. The specification describes in detail what is being shipped and how it is packed and marked.

ShipmentAdvice

A DeliveryMessage type that contains a specification of goods, that are dispatched and will be delivered to a warehouse. A ShipmentAdvice can refer to a DeliveryInstruction Sequence or a CallOff, but is normally also used for notifying a receiving warehouse operator of shipments to the warehouse.

DeliveryMessageWood

The DeliveryMessageWood element is the root element for the DeliveryMessageWood e-Document.

The DeliveryMessageWood e-Document enables the sender to describe the contents and configuration of a shipment at various levels of detail.

DeliveryMessageType [attribute]

DeliveryMessageType is mandatory. A single instance is required.

DeliveryMessageType defines the type of DeliveryMessage.

Refer to DeliveryMessageType definition for any enumerations.

DeliveryMessageStatusType [attribute]

DeliveryMessageStatusType is mandatory. A single instance is required.

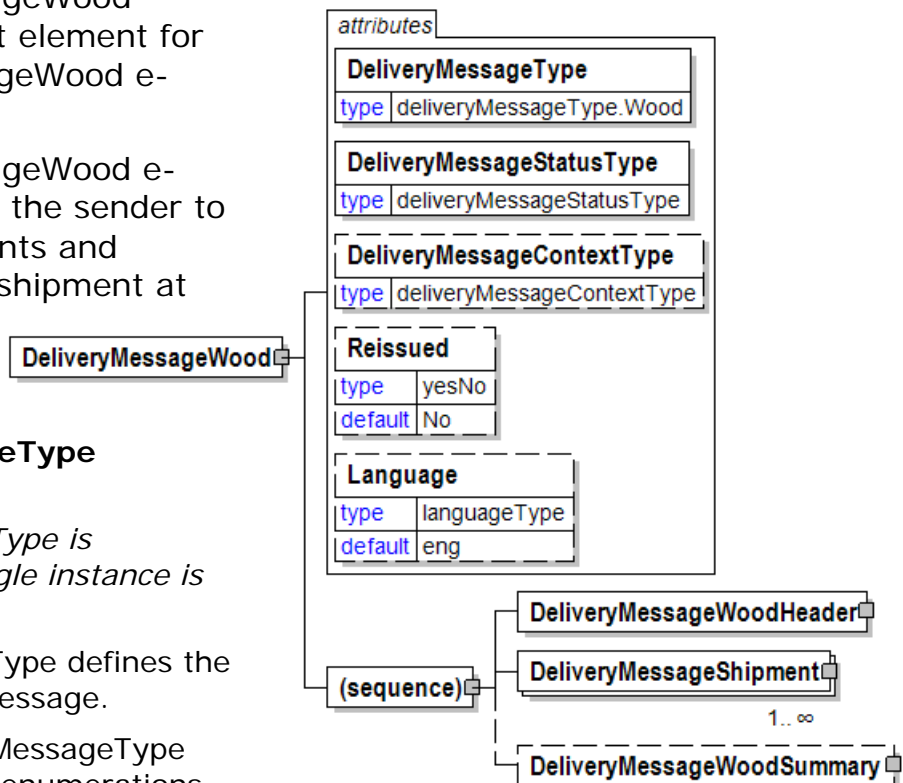

Identifies the status of the entire DeliveryMessage (in other words, at the root level).

Refer to DeliveryMessageStatusType definition for any enumerations.

DeliveryMessageContextType [attribute]

DeliveryMessageContextType is optional. A single instance might exist.

Communicates the reason for this delivery. If not present then this is a standard, typical delivery.

Refer to DeliveryMessageContextType definition for any enumerations.

Reissued [attribute]

Reissued is optional. A single instance might exist.

Either "Yes" or "No".

Refer to Reissued definition for any enumerations.

Language [attribute]

Language is optional. A single instance might exist.

XML has embraced 2 and 3 digit language codes through the application of an addendum to the standard.

Refer to Language definition for any enumerations.

(sequence)

The sequence of items below is mandatory. A single instance is required.

DeliveryMessageWoodHeader

DeliveryMessageWoodHeader is mandatory. A single instance is required.

This element contains the information that is consistent for the entire DeliveryMessageWood document.

Note: DocumentReferenceInformation will be removed from this element in the next version of papiNet. Use the DocumentInformation element instead.

DeliveryMessageShipment

DeliveryMessageShipment is mandatory. One instance is required, multiple instances might exist.

The DeliveryMessageShipment specifies an individual delivery shipment. It may contain product grouping within the shipment.

DeliveryMessageWoodSummary

DeliveryMessageWoodSummary is optional. A single instance might exist.

The DeliveryMessageWoodSummary contains summary information based on the line items contained in the DeliveryMessageWood document.

DeliveryMessageWoodHeader

This element contains the information that is consistent for the entire DeliveryMessageWood document.

Note: DocumentReferenceInformation will be removed from this element in the next version of papiNet. Use the DocumentInformation element instead.

(sequence)

The sequence of items below is mandatory. A single instance is required.

DeliveryMessageNumber

DeliveryMessageNumber is mandatory. A single instance is required.

A unique delivery identifier assigned to each DeliveryMessage as agreed between the trading partners.

TransactionHistoryNumber

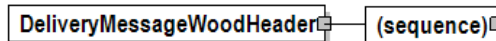

TransactionHistoryNumber is optional. A single instance might exist.

A sequential number that keeps track of the version of a document being sent by the document originator except in the case where TransactionHistoryConfirmation is used, in which case the TransactionHistoryNumber refers to the trigger transaction for which the confirmation is being sent.

DeliveryMessageDate

DeliveryMessageDate is mandatory. A single instance is required.

The Date and Time when the DeliveryMessage was issued.

DeliveryMessageReference

DeliveryMessageReference is optional. Multiple instances might exist.

An element that identifies the relevant references pertaining to the DeliveryMessage, identified by DeliveryMessageReferenceType.

DocumentReferenceInformation

DocumentReferenceInformation is optional. Multiple instances might exist.

A group item containing reference information applicable to a document.

BuyerParty

BuyerParty is mandatory. A single instance is required.

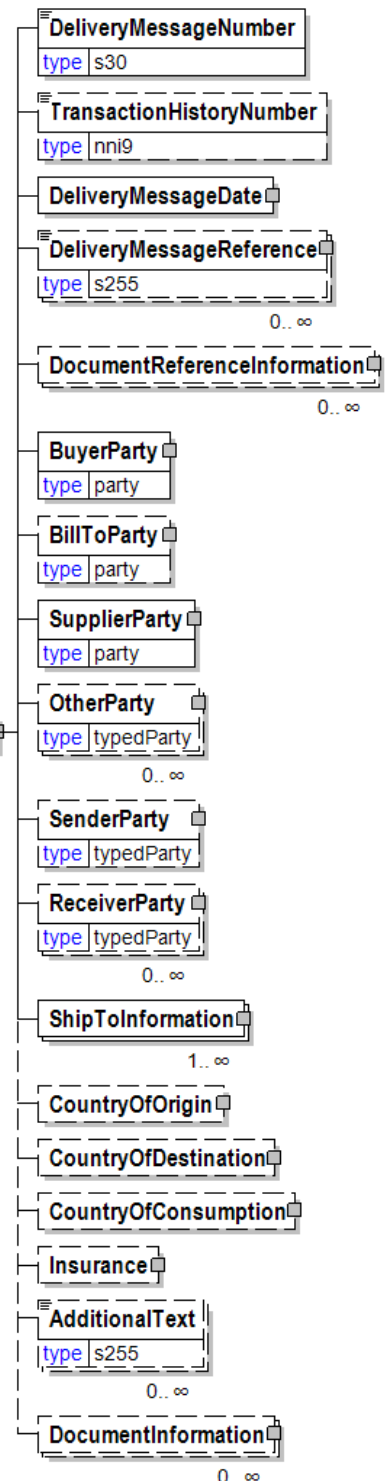

The legal entity to which the product is sold. Also commonly referred to as the sold-to party or customer. If no OtherParty is defined as the Payer, the Buyer is the Payer.

BillToParty

BillToParty is optional. A single instance might exist.

The address where the Invoice is to be sent.

SupplierParty

SupplierParty is mandatory. A single instance is required.

The organisation or business entity responsible for providing the product. SupplierParty is also the seller of the product, if Seller is not specified as OtherParty = Seller.

OtherParty

OtherParty is optional. Multiple instances might exist.

An organisation or business entity other than those specifically detailed within a e-Document.

SenderParty

SenderParty is optional. A single instance might exist.

The business entity issuing the e-Document, the source of the document.

The entity responsible for the content. If the sender party has out sourced the message service to a third party the SenderParty is the issuer of the e-Document and not the party performing the transmission service of the electronic message.

ReceiverParty

ReceiverParty is optional. Multiple instances might exist.

The business entity for whom the e-Document is intended, the destination of the document.

The entity interested in the content. If the receiver party has outsourced the message service to a third party the ReceiverParty is the intended party for the e-Document and not the party performing the receiving service of the electronic message.

ShipToInformation

ShipToInformation is mandatory. One instance is required, multiple instances might exist.

Group element containing information about the ship to and delivery of a product.

CountryOfOrigin

CountryOfOrigin is optional. A single instance might exist.

The country of origin for the material.

CountryOfDestination

CountryOfDestination is optional. A single instance might exist.

The country where the goods will be, or were, shipped to.

CountryOfConsumption

CountryOfConsumption is optional. A single instance might exist.

The country of consumption for the material.

Insurance

Insurance is optional. A single instance might exist.

Group element containing information about insurance

AdditionalText

AdditionalText is optional. Multiple instances might exist.

A text field that is used to communicate information not previously defined or for special instructions. To be used only for circumstances not covered by specific elements.

DocumentInformation

DocumentInformation is optional. Multiple instances might exist.

A group element containing a specification of required documents in the business process. Additional free text to be printed on documents can also be specified.

DeliveryMessageWoodSummary

The DeliveryMessageWoodSummary contains summary information based on the line items contained in the DeliveryMessageWood document.

(sequence)

The sequence of items below is mandatory. A single instance is required.

TotalNumberOfShipments

TotalNumberOfShipments is mandatory. A single instance is

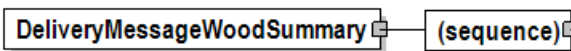

required.

Total number of shipments referred to in a DeliveryMessage.

(sequence)

The sequence of items below is optional. Multiple instances might exist.

TotalQuantity

TotalQuantity is mandatory. A single instance is required.

The total quantity of similar items in the e-Document. TotalQuantity is primarily used in the summary section of documents where it is repeatable to permit totaling for different units of measure.

TotalInformationalQuantity

TotalInformationalQuantity is optional. Multiple instances might exist.

A quantity that is used to communicate related information about the parent element. This element represents a total that is derived from individual line

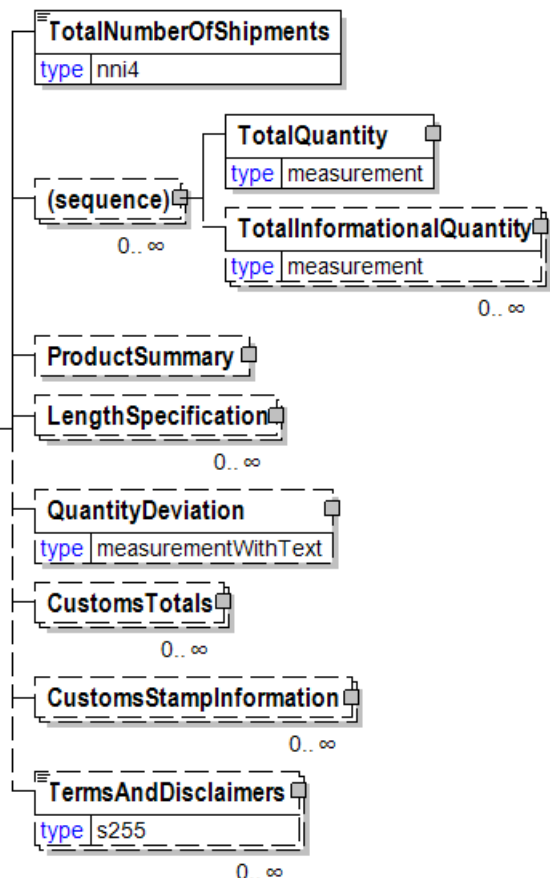

items.

ProductSummary

ProductSummary is optional. A single instance might exist.

Group of elements to provide summary information on product level.

LengthSpecification

LengthSpecification is optional. Multiple instances might exist.

Length specification of the wood product.

QuantityDeviation

QuantityDeviation is optional. A single instance might exist.

To be deprecated in a future version. Use the Quantity element with a QuantityContext of "Deviation".

CustomsTotals

CustomsTotals is optional. Multiple instances might exist.

A grouping element for customs total information.

CustomsStampInformation

CustomsStampInformation is optional. Multiple instances might exist.

A grouping element that organises the information for customs.

TermsAndDisclaimers

TermsAndDisclaimers is optional. Multiple instances might exist.

An element that contains legal information with an indication of what the Language is.

DeliveryModeType [attribute]

Provides delivery mode type that specifies if transport arrangement is needed or not.

This item is restricted to the following list.

Deliver

Transport arrangement to be done and goods to be delivered.

PickUp

Goods to be picked up; no transport arrangements are needed.

attribute	
DeliveryModeType	
type	deliveryModeType
default	Deliver

DeliveryOrigin

A group item that represents the start of one leg in a route. Compare to DeliveryDestination.

The DeliveryOrigin specifies the start of one leg of the delivery.

In order to comply with the US Trade Act of 2002 you would use this element with a LocationParty/@PartyType of Port.



(sequence)

The sequence of items below is mandatory. A single instance is required.

Date

Date is optional. A single instance might exist.

A group element that contains the specification of Year, Month, and Day.

Time

Time is optional. A single instance might exist.

Times are treated in a standard XML fashion with a special case used to indicate a generalized "local" time. The standard XML approach to time is hh:mm:ss, hh:mm:ssZ, or hh:mm:ss±hh:mm.

hh:mm:ss±hh:mm is used to represent a time with a time zone. The time zone is communicated as the number of hours offset from the Universal Time Coordinate (UTC), a.k.a. Greenwich Mean Time.

hh:mm:ssZ indicates the time at Zulu (another name for UTC). Based on the convention described in the next bullet it will be important for users within UTC to use "Z" when communicating a time in their time zone to other users.

hh:mm:ss or hh:mm indicates in the XML standard the time at UTC however, within papiNet it is used to represent the applicable local time. Caution should be used when processing times of this nature as the papiNet approach may be in discord with other users of XML.

LocationParty

LocationParty is mandatory. A single instance is required.

The organization or business entity where the business event took place or will take place.

(choice)

[choice] is optional because of choice construct.

SupplyPoint

SupplyPoint is optional because of choice construct.

Grouping element that contains items describing a supply point. A SupplyPoint belongs to a LocationParty, e.g. in a DeliveryOrigin or DeliveryDestination, and describes where goods are stored and can be loaded or unloaded. A SupplyPoint can for example be a loading or unloading gate at a warehouse or a road side landing at a logging area in the forest.

LocationCode

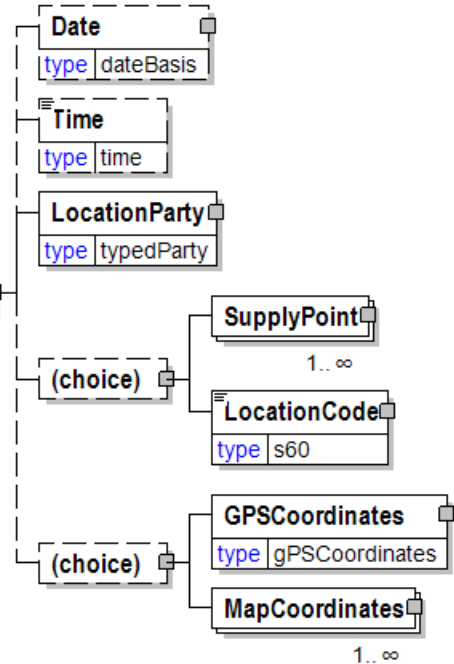

LocationCode is optional because of choice construct.

A code used to identify a specific physical location within a site identified by a party, e.g. a loading station in a warehouse or an unloading station at a printer site.

LocationCode will be deprecated in a future version. Use SupplyPoint instead of LocationCode.

(choice)

[choice] is optional because of choice construct.

GPSCoordinates

GPSCoordinates is optional because of choice construct.

The location of the party as specified using a Global Positioning System.

MapCoordinates

MapCoordinates is optional because of choice construct.

A group item defining and containing position co-ordinates of a location.

DeliveryRouteCode

A code representing the delivery route as indicated by the Agency.

Agency [attribute]

Agency is mandatory. A single instance is required.

Describes the agency maintaining the list of codes. To be included in this list the agency must be a recognized standards body or industry organisation.

For the element that owns this attribute.

For another attribute in the list of attributes associated with the parent element.

Refer to Agency definition for any enumerations.

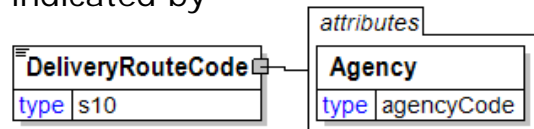

DeliverySchedule

A group item defining a series of DeliveryDateWindow(s) in which specified quantities must be delivered.

(sequence)

The sequence of items below is mandatory. A single instance is required.

DeliveryLineNumber

DeliveryLineNumber is mandatory. A single instance is required.

A sequential number that uniquely identifies a delivery line of the DeliverySchedule; a delivery line consists of a quantity and a date range for the delivery to take place.

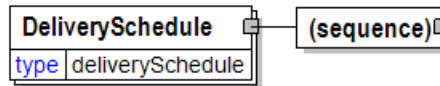

ProductionStatus

ProductionStatus is optional. A single instance might exist.

A group item used to communicate the release of a delivery line number.

DeliveryStatus

DeliveryStatus is optional. A single instance might exist.

Used to communicate whether the delivery date indicated is a final date or subject to change. If subject to change the last date of change may be communicated.

DeliveryDateWindow

DeliveryDateWindow is optional. Multiple instances might exist.

A group item defining the date/time interval for delivery to take place. An element which may contain the estimated date for which delivery is expected. This date is not absolute.

Quantity

Quantity is mandatory. A single instance is required.

The Quantity element contains attributes that provide information about the type of quantity that is being communicated, the context in which the particular quantity is to be viewed, and (if the quantity represents an adjustment) an adjustment type.

The Quantity element contains three child elements that enable you to communicate a range of values for the quantity and a target or actual value. It is at this level (Value, RangeMin, and RangeMax) that the unit of measure is specified. This permits the range to be specified in a different unit of measure than the target.

InformationalQuantity

InformationalQuantity is optional. Multiple instances might exist.

A quantity given in a valid UOM used for information purposes only (not for calculation). For example, an ordered quantity was 100 reels as opposed to the

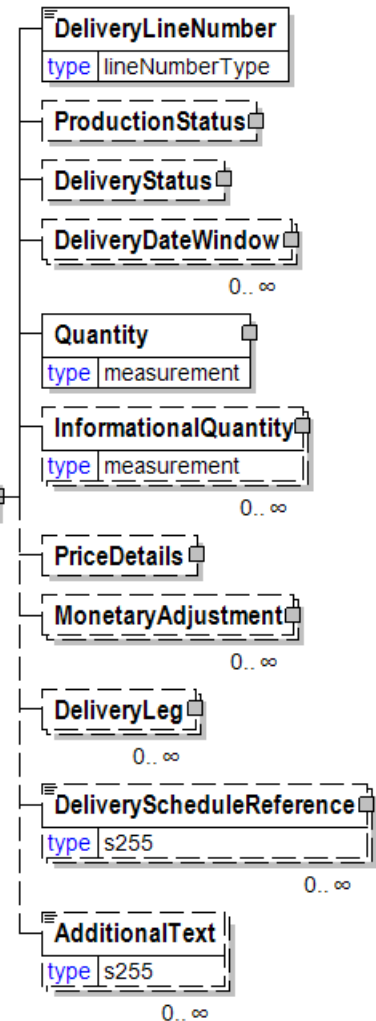

invoice quantity of 20,000 pounds.

PriceDetails

PriceDetails is optional. A single instance might exist.

An element that groups together price information.

MonetaryAdjustment

MonetaryAdjustment is optional. Multiple instances might exist.

The element containing the information necessary for the understanding, calculation, and treatment of an adjustment to a currency amount. MonetaryAdjustment contains an attribute that indicates they type of adjustment being communicated.

DeliveryLeg

DeliveryLeg is optional. Multiple instances might exist.

A DeliveryLeg details the sequence, origin, transportation, and destination of each part of the delivery. More than one leg may be required if there is a change of mode, vehicle, or carrier.

Although transportation information is optional, it is strongly recommended that any transportation information available be sent.

DeliveryScheduleReference

DeliveryScheduleReference is optional. Multiple instances might exist.

An element detailing relevant references pertaining to the delivery schedule as indicated by DeliveryScheduleReferenceType.

AdditionalText

AdditionalText is optional. Multiple instances might exist.

A text field that is used to communicate information not previously defined or for special instructions. To be used only for circumstances not covered by specific elements.

DeliveryScheduleReference

An element detailing relevant references pertaining to the delivery schedule as indicated by

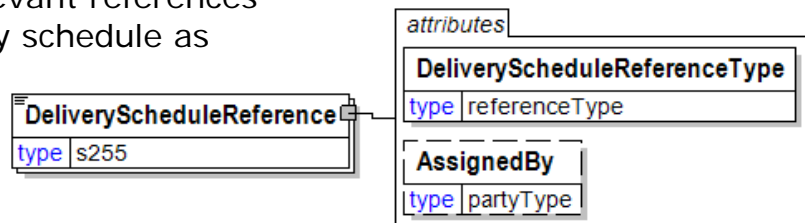

DeliveryScheduleReferenceType.

DeliveryScheduleReferenceType [attribute]

DeliveryScheduleReferenceType is mandatory. A single instance is required.

Provides a contextual explanation of the specific reference identifier. Many items are currently prefixed by "Buyer", "Forwarder", "Manufacturer", "Mill", "Seller", "Supplier", "Warehouse", or "Vendor". Check for an existing non-prefixed version and use the non-prefixed version instead. In the (yet to be announced release date) version 3.0 the prefixed versions will be removed. Instead the attribute @AssignedBy will communicate the information

previously communicated in the prefix.

Refer to DeliveryScheduleReferenceType definition for any enumerations.

AssignedBy [attribute]

AssignedBy is optional. A single instance might exist.

Identifies the type of party that has assigned the associated item, e.g. a reference of type OrderNumber.

Refer to AssignedBy for any enumerations.

DeliveryScheduleReferenceType [attribute]

Provides a contextual explanation of the specific reference identifier. Many items are currently prefixed by "Buyer", "Forwarder", "Manufacturer", "Mill", "Seller", "Supplier", "Warehouse", or "Vendor". Check for an

existing non-prefixed version and use the non-prefixed version instead. In the (yet to be announced release date) version 3.0 the prefixed versions will be removed. Instead the attribute @AssignedBy will communicate the information previously communicated in the prefix.

Refer to the [referenceType](#) entry for the list of enumerations and their definitions.

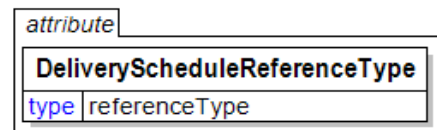

DeliveryShipmentBookLineItem

DeliveryShipmentBookLineItem is required. The DeliveryShipmentBookLineItem specifies an individual shipment delivery line for one PurchaseOrder and PurchaseOrder line item.

ShipmentComplete [attribute]

ShipmentComplete is optional. A single instance might exist.

Either "Yes" or "No".

Refer to ShipmentComplete definition for any enumerations.



InstructionByType [attribute]

InstructionByType is optional. A single instance might exist.

Provides the type for how goods are identified on group level when instructed for loading or delivery.

Refer to InstructionByType definition for any enumerations.

(sequence)

The sequence of items below is mandatory. A single instance is required.

DeliveryShipmentLineItemNumber

DeliveryShipmentLineItemNumber is mandatory. A single instance is required.

Sequential number to identify individual line items within a shipment

PurchaseOrderInformation

PurchaseOrderInformation is optional. A single instance might exist.

A group item containing information unique to this PurchaseOrder, which is provided by the buyer. PurchaseOrderInformation can be optional in the supply chain. Invoices are created without having a PurchaseOrder in Vendor Managed Inventory. Freight invoices also will not have a PurchaseOrder number.

PurchaseOrderLineItemNumber

PurchaseOrderLineItemNumber is optional. A single instance might exist.

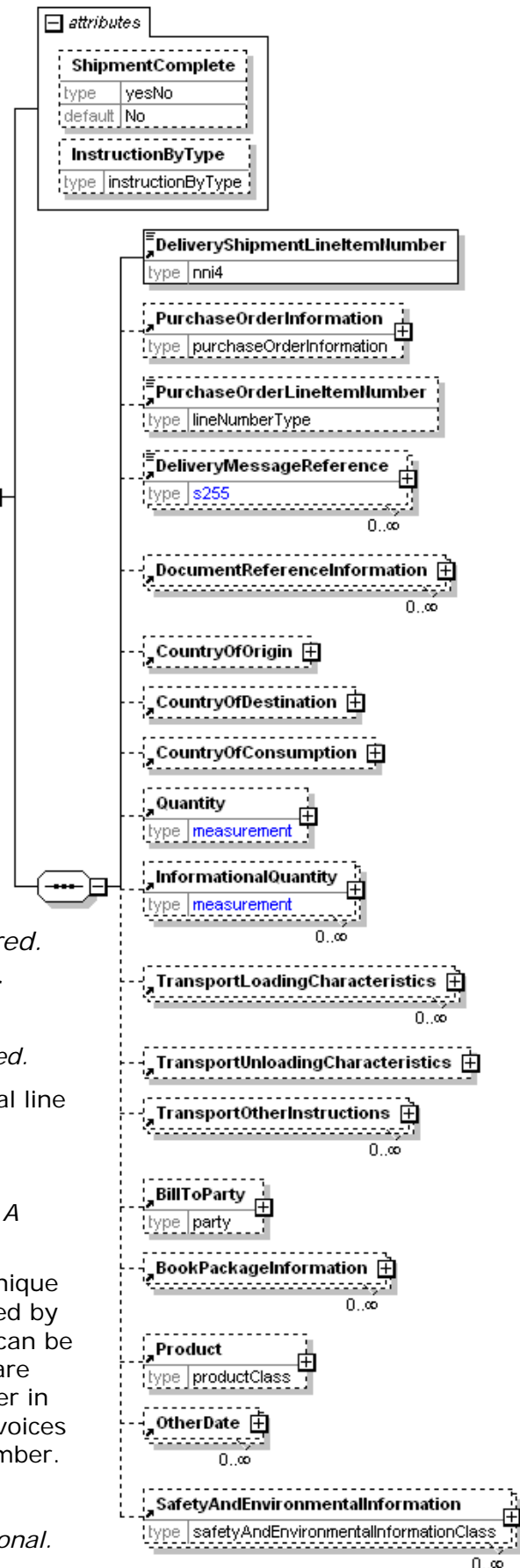

The sequential number that uniquely identifies the PurchaseOrder line item.

DeliveryMessageReference

DeliveryMessageReference is optional. Multiple instances might exist.

An element that identifies the relevant references pertaining to the DeliveryMessage, identified by DeliveryMessageReferenceType.

DocumentReferenceInformation

DocumentReferenceInformation is optional. Multiple instances might exist.

A group item containing reference information applicable to a document.

CountryOfOrigin

CountryOfOrigin is optional. A single instance might exist.

The country of origin for the material.

CountryOfDestination

CountryOfDestination is optional. A single instance might exist.

The country where the goods will be, or were, shipped to.

CountryOfConsumption

CountryOfConsumption is optional. A single instance might exist.

The country of consumption for the material.

Quantity

Quantity is optional. A single instance might exist.

The Quantity element contains attributes that provide information about the type of quantity that is being communicated, the context in which the particular quantity is to be viewed, and (if the quantity represents an adjustment) an adjustment type.

The Quantity element contains three child elements that enable you to communicate a range of values for the quantity and a target or actual value. It is at this level (Value, RangeMin, and RangeMax) that the unit of measure is specified. This permits the range to be specified in a different unit of measure than the target.

InformationalQuantity

InformationalQuantity is optional. Multiple instances might exist.

A quantity given in a valid UOM used for information purposes only (not for calculation). For example, an ordered quantity was 100 reels as opposed to the invoice quantity of 20,000 pounds.

TransportLoadingCharacteristics

TransportLoadingCharacteristics is optional. Multiple instances might exist.

A group item defining how the transported items are to be loaded.

TransportUnloadingCharacteristics

TransportUnloadingCharacteristics is optional. A single instance might exist.

A group item defining how the transported items are to be unloaded.

TransportOtherInstructions

TransportOtherInstructions is optional. Multiple instances might exist.

A group item defining any other instructions for the transport not covered in the description of transport mode, vehicle, unit, and loading characteristics or defining an alternative description for the categories mentioned above.

BillToParty

BillToParty is optional. A single instance might exist.

The address where the Invoice is to be sent.

BookPackageInformation

BookPackageInformation is optional. Multiple instances might exist.

The purpose of the BookPackageInformation structure is to clearly identify physical handling items that constitute the delivery.

BookPackageInformation is the highest level of product packaging and describes the shipping or warehousing unit.

Product

Product is optional. A single instance might exist.

Product is a group item defining the article and its characteristics. Product is used to specify product characteristics organized by ProductIdentifier, ProductDescription, and Classification. Book Manufacturing, Label Stock, Paper, Pulp, Recovered Paper, Wood Products, and Virgin Fibre market segments have defined their product characteristics and conversion features for implementation in papiNet.

OtherDate

OtherDate is optional. Multiple instances might exist.

A date that may not be specifically detailed within a document (example: print date at the PurchaseOrderLineItem).

SafetyAndEnvironmentalInformation

SafetyAndEnvironmentalInformation is optional. Multiple instances might exist.

Name of certification type, if any, on the goods (For example, FSC, PEFC). SafetyAndEnvironmental needs a value or measurement to communicate the percentage of the product is certified (for example, 75% is certified by the indicated agency).

DeliveryShipmentId

Unique identifier for the shipment

DeliveryShipmentId	
type	s30

DeliveryShipmentLineItem

The DeliveryShipmentLineItem specifies an individual delivery line for one order and order line item.

PackageInformation will be deprecated in the version following V2R30, it has been replaced with TransportPackageInformation.

You are encouraged to use TransportPackageInformation.

(sequence)

The sequence of items below is mandatory. A single instance is required.

DeliveryShipmentLineItemNumber

DeliveryShipmentLineItemNumber is mandatory. A single instance is required.

Sequential number to identify individual line items within a shipment

PurchaseOrderInformation

PurchaseOrderInformation is optional. A single instance might exist.

A group item containing information unique to this PurchaseOrder, which is provided by the buyer. PurchaseOrderInformation can be optional in the supply chain. Invoices are created without having a PurchaseOrder in Vendor Managed Inventory. Freight invoices also will not have a PurchaseOrder number.

PurchaseOrderLineItemNumber

PurchaseOrderLineItemNumber is optional. A single instance might exist.

The sequential number that uniquely identifies the PurchaseOrder line item.

DeliveryMessageReference

DeliveryMessageReference is optional. Multiple instances might exist.

An element that identifies the relevant references pertaining to the DeliveryMessage, identified by DeliveryMessageReferenceType.

DocumentReferenceInformation

DocumentReferenceInformation is optional. Multiple instances might exist.

A group item containing reference information applicable to a document.

CountryOfOrigin

CountryOfOrigin is optional. A single instance might exist.

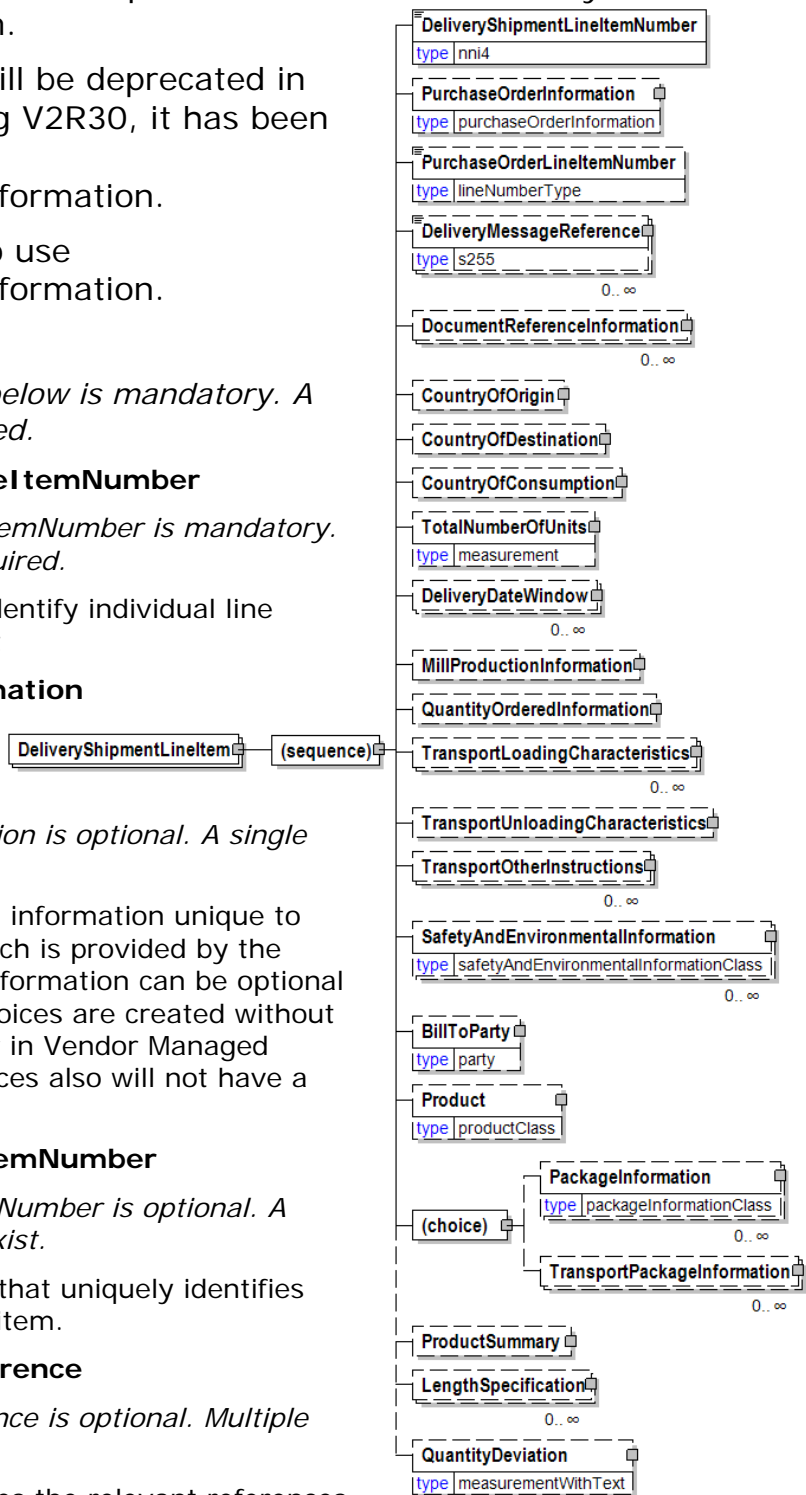

The country of origin for the material.

CountryOfDestination

CountryOfDestination is optional. A single instance might exist.

The country where the goods will be, or were, shipped to.

CountryOfConsumption

CountryOfConsumption is optional. A single instance might exist.

The country of consumption for the material.

TotalNumberOfUnits

TotalNumberOfUnits is optional. A single instance might exist.

The total number of units.

DeliveryDateWindow

DeliveryDateWindow is optional. Multiple instances might exist.

A group item defining the date/time interval for delivery to take place. An element which may contain the estimated date for which delivery is expected. This date is not absolute.

MillProductionInformation

MillProductionInformation is optional. A single instance might exist.

A grouping element that contains information about production at the mill.

QuantityOrderedInformation

QuantityOrderedInformation is optional. A single instance might exist.

Used to identify quantity. The construct provides via InformationalQuantity the ability to provide the Quantity in another UOM. Length is also provided to further specify the quantity.

TransportLoadingCharacteristics

TransportLoadingCharacteristics is optional. Multiple instances might exist.

A group item defining how the transported items are to be loaded.

TransportUnloadingCharacteristics

TransportUnloadingCharacteristics is optional. A single instance might exist.

A group item defining how the transported items are to be unloaded.

TransportOtherInstructions

TransportOtherInstructions is optional. Multiple instances might exist.

A group item defining any other instructions for the transport not covered in the description of transport mode, vehicle, unit, and loading characteristics or defining an alternative description for the categories mentioned above.

SafetyAndEnvironmentalInformation

SafetyAndEnvironmentalInformation is optional. Multiple instances might exist.

Name of certification type, if any, on the goods (For example, FSC, PEFC). SafetyAndEnvironmental needs a value or measurement to communicate the percentage of the product is certified (for example, 75% is certified by the indicated agency).

BillToParty

BillToParty is optional. A single instance might exist.

The address where the Invoice is to be sent.

Product

Product is optional. A single instance might exist.

Product is a group item defining the article and its characteristics. Product is used to specify product characteristics organized by ProductIdentifier, ProductDescription, and Classification. Book Manufacturing, Label Stock, Paper, Pulp, Recovered Paper, Wood Products, and Virgin Fibre market segments have defined their product characteristics and conversion features for implementation in papiNet.

(choice)

[choice] is optional because of choice construct.

PackageInformation

PackageInformation is optional because of choice construct.

The purpose of the PackageInformation structure is to clearly identify physical handling items that constitute the delivery.

PackageInformation is the highest level of product packaging it describes the shipping or warehousing unit.

If you are communicating a package, usually for logistics or transport purposes, you should include the PackageType, Identifier, ItemCount, and Quantity. (Note: you still have the ability to describe the item with one of the "named" items.)

If you are communicating one of the named Items there is no need to include PackageType, Identifier, ItemCount, and Quantity.

Since either of these two approaches can be used the entire contents of this element are optional even though the parent may be required. It is expected that you will fill in the appropriate details.

TransportPackageInformation

TransportPackageInformation is optional because of choice construct.

Information of a package used in transportation, can include several normal packages.

ProductSummary

ProductSummary is optional. A single instance might exist.

Group of elements to provide summary information on product level.

LengthSpecification

LengthSpecification is optional. Multiple instances might exist.

Length specification of the wood product.

QuantityDeviation

QuantityDeviation is optional. A single instance might exist.

To be deprecated in a future version. Use the Quantity element with a QuantityContext of "Deviation".

DeliveryShipmentLineItemNumber

Sequential number to identify individual line items within a shipment

DeliveryShipmentLineItemNumber
type nni4

DeliveryStatus

Used to communicate whether the delivery date indicated is a final date or subject to change. If subject to change the last date of change may be communicated.

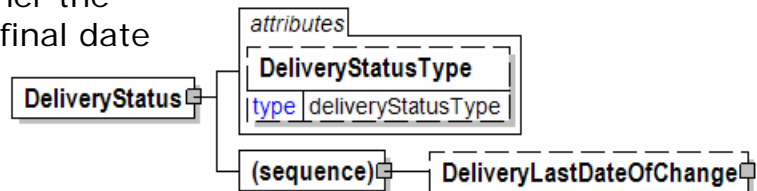

DeliveryStatusType [attribute]

DeliveryStatusType is optional. A single instance might exist.

Indicates whether or not you are allowed to take action on the delivery or if more information is required

Refer to DeliveryStatusType definition for any enumerations.

(sequence)

The sequence of items below is mandatory. A single instance is required.

DeliveryLastDateOfChange

DeliveryLastDateOfChange is optional. A single instance might exist.

The final Date and optionally Time that a line item or delivery line may be amended or cancelled by the buyer.

The final Date and optionally Time that a line item or delivery line may be amended or cancelled by the buyer. For example, the buyer can cancel each a delivery line before the DeliveryLastDateOfChange received from the seller on the OrderConfirmation.

DeliveryStatusType [attribute]

Indicates whether or not you are allowed to take action on the delivery or if more information is required

attribute
DeliveryStatusType
type deliveryStatusType

This item is restricted to the following list.

Cancelled

The delivery has been cancelled. You are not allowed to deliver this product.

Free

You are allowed to deliver this product

NotFree

You are not allowed to deliver this product. More information is required from the receiver.

DeliveryTransitTime

A group item representing the number of Days and optionally Hours and Minutes between origin and destination for a DeliveryLeg.

(sequence)

The sequence of items below is mandatory. A single instance is required.

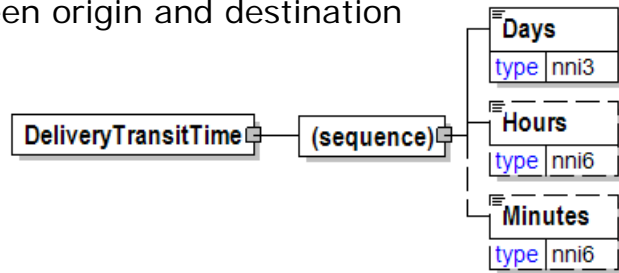

Days

Days is mandatory. A single instance is required.

The qualifier of DeliveryTransitTime. More generally used to communicate duration in days.

Hours

Hours is optional. A single instance might exist.

A qualifier of DeliveryTransitTime.

Minutes

Minutes is optional. A single instance might exist.

A qualifier for the DeliveryTransitTime.

Density

A group item used to communicate density target or test value according to a particular TestMethod.

TestMethod [attribute]

TestMethod is optional. A single instance might exist.

The method used to determine the results of the test under consideration.

TestAgency [attribute]

TestAgency is optional. A single instance might exist.

The agency that has set the parameters for the testing

Refer to TestAgency definition for any enumerations.

SampleType [attribute]

SampleType is optional. A single instance might exist.

Communicates how sampling was done to measure the product characteristics.

Refer to SampleType definition for any enumerations.

ResultSource [attribute]

ResultSource is optional. A single instance might exist.

Used to define the data source of the specified test

Refer to ResultSource definition for any enumerations.

(sequence)

The sequence of items below is mandatory. A single instance is required.

DetailValue

DetailValue is mandatory. A single instance is required.

A numeric value expressed in the unit of measure (UOM).

DetailRangeMin

DetailRangeMin is optional. A single instance might exist.

The minimum value (lower boundary) allowed for the DetailValue that is the parent of this element.

DetailRangeMax

DetailRangeMax is optional. A single instance might exist.

The maximum value (upper boundary) allowed for the DetailValue that is the parent of this element.

StandardDeviation

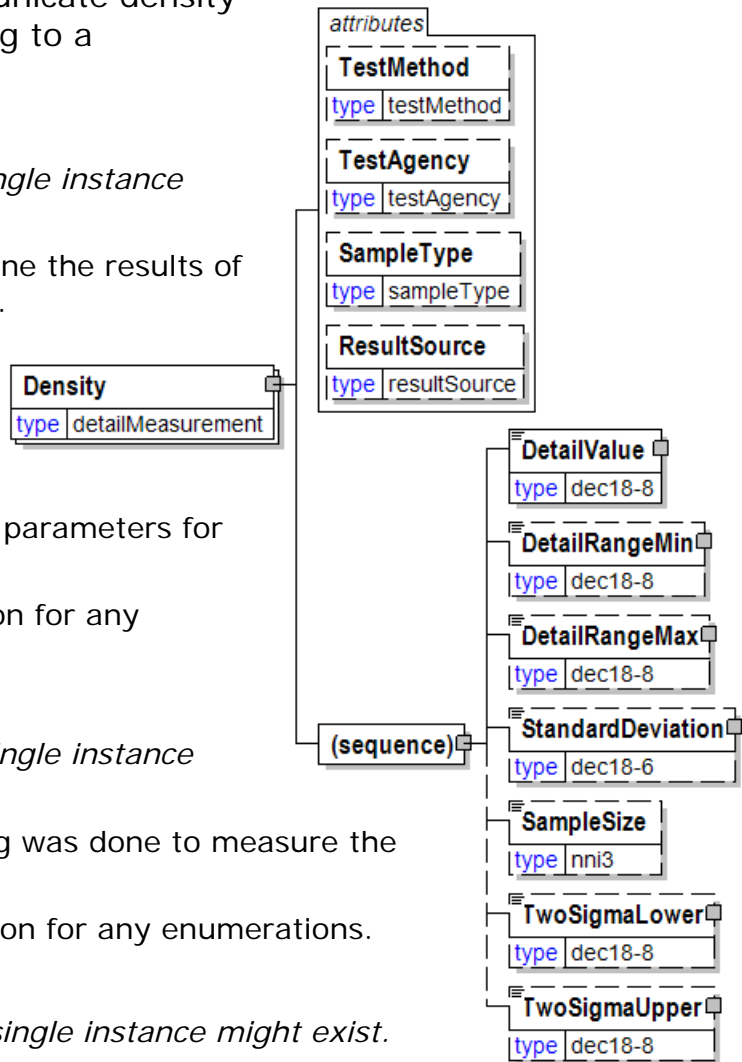

papiNet V2R31

StandardDeviation is optional. A single instance might exist.

A statistic used as a measure of dispersion in a distribution.

SampleSize

SampleSize is optional. A single instance might exist.

The number of samples used to determine the product characteristic in question.

TwoSigmaLower

TwoSigmaLower is optional. A single instance might exist.

Two sigma (a measure of dispersion associated with standard deviation) on the lower side of the standard deviation.

TwoSigmaUpper

TwoSigmaUpper is optional. A single instance might exist.

Two sigma (a measure of dispersion associated with standard deviation) on the upper side of the standard deviation.

DepartureDate

The required or actual date of departure.

(sequence)

The sequence of items below is mandatory. A single instance is required.

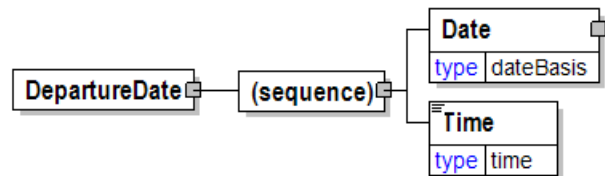

Date

Date is mandatory. A single instance is required.

A group element that contains the specification of Year, Month, and Day.

Time

Time is mandatory. A single instance is required.

Times are treated in a standard XML fashion with a special case used to indicate a generalized "local" time. The standard XML approach to time is hh:mm:ss, hh:mm:ssZ, or hh:mm:ss±hh:mm.

hh:mm:ss±hh:mm is used to represent a time with a time zone. The time zone is communicated as the number of hours offset from the Universal Time Coordinate (UTC), a.k.a. Greenwich Mean Time.

hh:mm:ssZ indicates the time at Zulu (another name for UTC). Based on the convention described in the next bullet it will be important for users within UTC to use "Z" when communicating a time in their time zone to other users.

hh:mm:ss or hh:mm indicates in the XML standard the time at UTC however, within papiNet it is used to represent the applicable local time. Caution should be used when processing times of this nature as the papiNet approach may be in discord with other users of XML.

DetailRangeMax

The maximum value (upper boundary) allowed for the DetailValue that is the parent of this element.

UOM [attribute]

UOM is mandatory. A single instance is required.

Defines the unit of measure for the value.

Refer to UOM definition for any enumerations.

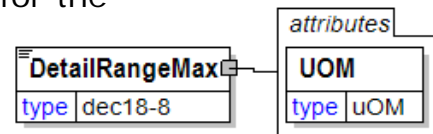

DetailRangeMin

The minimum value (lower boundary) allowed for the DetailValue that is the parent of this element.

UOM [attribute]

UOM is mandatory. A single instance is required.

Defines the unit of measure for the value.

Refer to UOM definition for any enumerations.

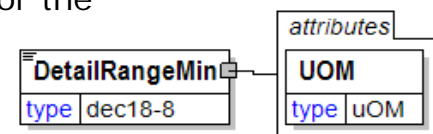

DetailValue

A numeric value expressed in the unit of measure (UOM).

UOM [attribute]

UOM is mandatory. A single instance is required.

Defines the unit of measure for the value.

Refer to UOM definition for any enumerations.

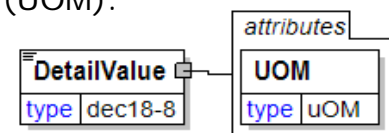

DiameterBreastHeight

Used to report the log diameter 4.5 feet from the butt end as a measurement. Used with the LogConversionRule attribute to determine log's volume conversion to board-feet or other measure.

(sequence)

The sequence of items below is mandatory. A single instance is required.

Value

Value is mandatory. A single instance is required.

A numeric value expressed in the unit of measure (UOM).

RangeMin

RangeMin is optional. A single instance might exist.

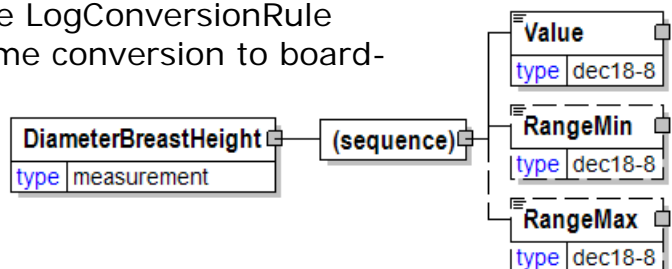

papiNet V2R31

The minimum value (lower boundary) allowed for the Measurement that is the parent of this element.

RangeMax

RangeMax is optional. A single instance might exist.

The maximum value (upper boundary) allowed for the Measurement that is the parent of this element. Some elements use the RangeMax element with an extended list of unit of measures. (Note: the red colour in the picture is an artifact of how the graphic was captured and should be disregarded.)

DieCut [attribute]

Either "Yes" or "No".

This item is restricted to the following list.

Yes

No

attribute	
DieCut	
type	yesNo

DieCutDescription

Die cut description

DieCutDescription	
type	s255

DirectLoading [attribute]

Specifies if the transport unit should be loaded directly with goods received on another transport unit.

This item is restricted to the following list.

Yes

No

attribute	
DirectLoading	
type	yesNo
default	No

DirectUnloading [attribute]

Specifies if the transport unit should be unloaded directly on to a new transport unit. Certain transport units, e.g. cassettes, can be stored in warehouses a short period waiting for direct unloading.

This item is restricted to the following list.

Yes

No

attribute	
DirectUnloading	
type	yesNo
default	No

Dirt

A group item used to communicate dirt content target or test value according to a particular TestMethod.

TestMethod [attribute]

TestMethod is optional. A single instance might exist.

The method used to determine the results of the test under consideration.

TestAgency [attribute]

TestAgency is optional. A single instance might exist.

The agency that has set the parameters for the testing

Refer to TestAgency definition for any enumerations.

SampleType [attribute]

SampleType is optional. A single instance might exist.

Communicates how sampling was done to measure the product characteristics.

Refer to SampleType definition for any enumerations.

ResultSource [attribute]

ResultSource is optional. A single instance might exist.

Used to define the data source of the specified test

Refer to ResultSource definition for any enumerations.

(sequence)

The sequence of items below is mandatory. A single instance is required.

DetailValue

DetailValue is mandatory. A single instance is required.

A numeric value expressed in the unit of measure (UOM).

DetailRangeMin

DetailRangeMin is optional. A single instance might exist.

The minimum value (lower boundary) allowed for the DetailValue that is the parent of this element.

DetailRangeMax

DetailRangeMax is optional. A single instance might exist.

The maximum value (upper boundary) allowed for the DetailValue that is the parent of this element.

StandardDeviation

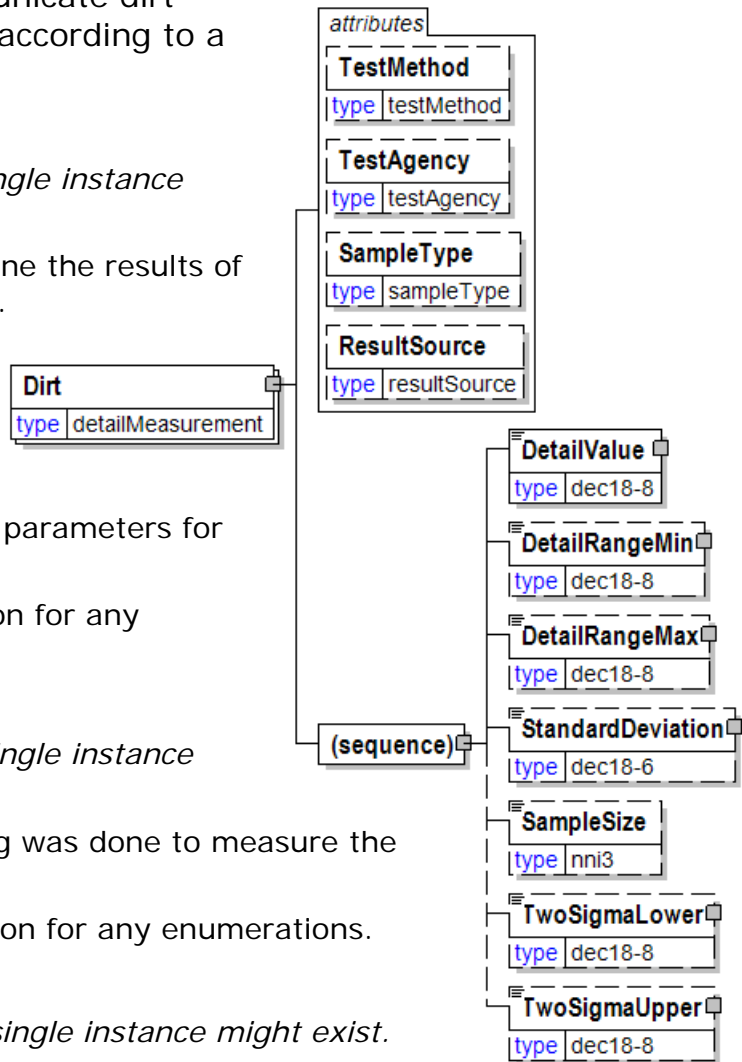

StandardDeviation is optional. A single instance might exist.

A statistic used as a measure of dispersion in a distribution.

SampleSize

SampleSize is optional. A single instance might exist.

The number of samples used to determine the product characteristic in question.

TwoSigmaLower

TwoSigmaLower is optional. A single instance might exist.

Two sigma (a measure of dispersion associated with standard deviation) on the lower side of the standard deviation.

TwoSigmaUpper

TwoSigmaUpper is optional. A single instance might exist.

Two sigma (a measure of dispersion associated with standard deviation) on the upper side of the standard deviation.

DiscPrinting [attribute]

Disc printing

This item is restricted to the following list.

Screen

Thermal



DistanceFromCore

The distance from the radius of the core. This element can be used to communicate where a mill join is located.

Compare to LengthFromCore.

(sequence)

The sequence of items below is mandatory. A single instance is required.

Value

Value is mandatory. A single instance is required.

A numeric value expressed in the unit of measure (UOM).

RangeMin

RangeMin is optional. A single instance might exist.

The minimum value (lower boundary) allowed for the Measurement that is the parent of this element.

RangeMax

RangeMax is optional. A single instance might exist.

The maximum value (upper boundary) allowed for the Measurement that is the parent of this element. Some elements use the RangeMax element with an extended list of unit of measures. (Note: the red colour in the picture is an artifact of how the graphic was captured and should be disregarded.)

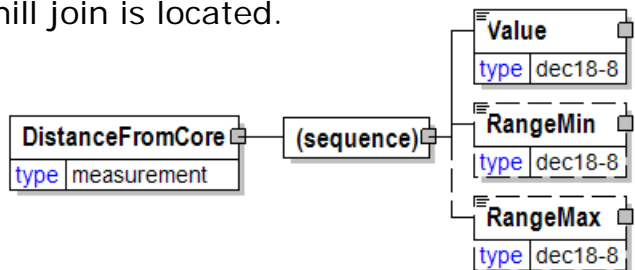

DistanceFromEdge

The distance from the edge of the paper. This element is used to communicate where the hole is.

EdgeType [attribute]

EdgeType is optional. A single instance might exist.

Edge type (paper)

Refer to EdgeType definition for any enumerations.

DisanceMeasuredTo [attribute]

DistanceMeasuredTo is optional.

Defines how the distance is measured from the edge of the paper to the hole.

This item is restricted to the following list.

Edge

Distance is measured to the edge of the hole.

Middle

Distance is measured to the middle of the hole.

(sequence)

The sequence of items below is mandatory. A single instance is required.

Value

Value is mandatory. A single instance is required.

A numeric value expressed in the unit of measure (UOM).

RangeMin

RangeMin is optional. A single instance might exist.

The minimum value (lower boundary) allowed for the Measurement that is the parent of this element.

RangeMax

RangeMax is optional. A single instance might exist.

The maximum value (upper boundary) allowed for the Measurement that is the parent of this element. Some elements use the RangeMax element with an extended list of unit of measures. (Note: the red colour in the picture is an artifact of how the graphic was captured and should be disregarded.)

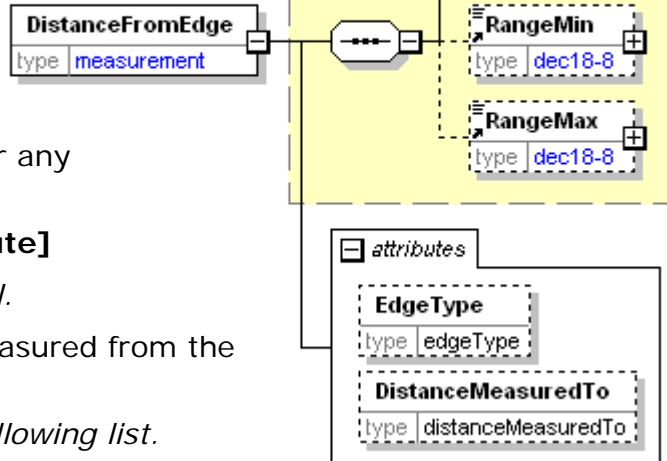

DistanceMeasuredTo [attribute]

Defines how the distance is measured from the edge of the paper to the hole.

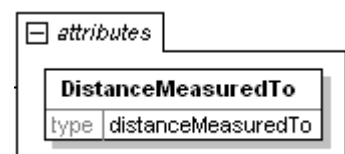

This item is restricted to the following list:

Edge

Distance is measured to the edge of the hole.

Middle

Distance is measured to the middle of the hole.

DistanceToNextStop

The distance to the next transportation node.

(sequence)

The sequence of items below is mandatory. A single instance is required.

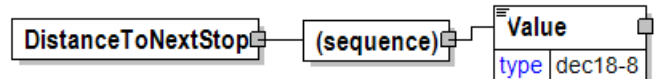

Value

Value is mandatory. A single instance is required.

A numeric value expressed in the unit of measure (UOM).

Document

A group item containing information applicable to the original document.

DocumentName [attribute]

DocumentName is mandatory. A single instance is required.

Defines the name of e-Documents defined by papiNet.

Refer to DocumentName definition for any enumerations.

DocumentType [attribute]

DocumentType is optional. A single instance might exist.

The type of e-Document being communicated.

Refer to DocumentType definition for any enumerations.

(sequence)

The sequence of items below is mandatory. A single instance is required.

DocumentNumber

DocumentNumber is mandatory. A single instance is required.

The unique identifier of the original document.

DocumentVersionNumber

DocumentVersionNumber is optional. A single instance might exist.

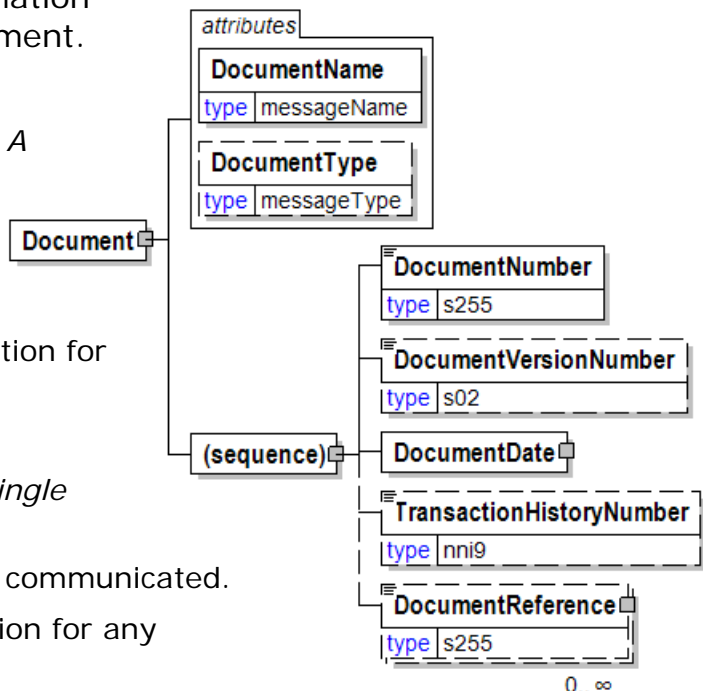

papiNet V2R31

The document version number, currently BookSpecification is the only e-Document that has a Version Number.

DocumentDate

DocumentDate is mandatory. A single instance is required.

The Date and optionally Time when the document that is referred to was issued.

TransactionHistoryNumber

TransactionHistoryNumber is optional. A single instance might exist.

A sequential number that keeps track of the version of a document being sent by the document originator except in the case where TransactionHistoryConfirmation is used, in which case the TransactionHistoryNumber refers to the trigger transaction for which the confirmation is being sent.

DocumentReference

DocumentReference is optional. Multiple instances might exist.

An element detailing relevant references pertaining to the papiNet e-Document as indicated by the DocumentReferenceType and AssignedBy.

DocumentContent

A grouping element specifying information contained in a document.

DocumentContentType [attribute]

DocumentContentType is mandatory. A single instance is required.

Specifies the type of information contained in a document.

Refer to DocumentContentType definition for any enumerations.

AssignedBy [attribute]

AssignedBy is mandatory. A single instance is required.

Identifies the type of party that has assigned the associated item, e.g. a reference of type OrderNumber.

Refer to AssignedBy for any enumerations.

(sequence)

The sequence of items below is mandatory. A single instance is required.

DocumentContentText

DocumentContentTextt is optional. Multiple instances might exist.

Text that is printed on a document.

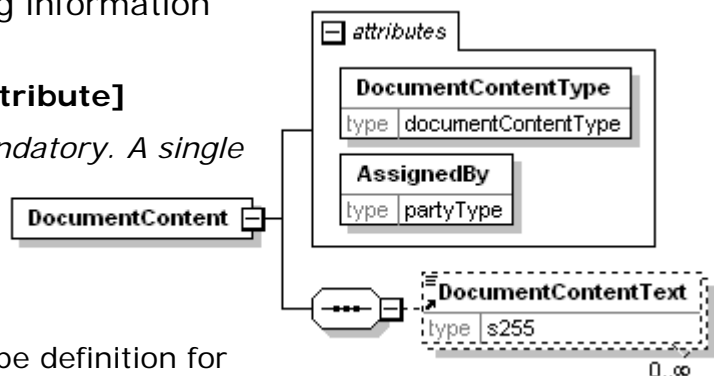

DocumentContentText

Text that is printed on a document.



A diagram showing a rectangular box with a header section containing the text "DocumentContentText" and a data section below it containing the text "type s255".

DocumentContentText	
type	s255

DocumentContentType [attribute]

Specifies the type of information contained in a document.

This item is restricted to the following list.



A diagram showing a rectangular box with a header section containing the text "DocumentContentType" and a data section below it containing the text "type documentContentType". The box is labeled "attributes" in the top left corner.

DocumentContentType	
type	documentContentType

Author

Name of the author of the product or book

BasisWeight

The weight of the paper expressed as a mass for a given surface area.

BoxWeight

Weight of the filled box.

BrandName

A specific product brand name for which the owner or source is specified in the "@AssignedBy" attribute.

Copyright

The year of publication copyright.

Edition

Identifies the version of the product for which copies were printed and published at one time; For example in book manufacturing values might be 1st, 2nd, etc

ExportShipMark

An export shipment mark for identification.

GradeCode

A specific product code for which the owner or source is specified in the "@AssignedBy" attribute.

GradeName

A specific product name for which the owner or source is specified in the "@AssignedBy" attribute (for example, ImprovedNewsprint-45-1479).

Identifier

Identifier of the individual item.

ISBN10

10 digit ISBN code without dashes.

ISBN10Dash

10 digit ISBN code with dashes.

ISBN13

13 digit ISBN code.

ISBN13Dash

A 13 character ISBN with dashes.

LotIdentifier

A unique code used to identify a grouping of product with one set of quality statistics common to all members of that group. Synonym: Lot Number.

PartNumber

An equivalent to the Stock Keeping Unit (SKU) for which the owner or source is specified in the "@AssignedBy" attribute. In other words, this code fully defines the product.

PlainText

To be removed in a future version. Use instead "ReferenceNumber".

PrintingNumber

A reference to the sequential print run number.

ProductIdentifier

To be removed in a future version. Use instead specific product identifier types such as BrandName, GradeCode, GradeName and PartNumber.

ProfitCenter

Profit Center identifier.

PubName

The publication name.

PurchaseOrderNumber

The unique order identifier as designated by the customer.

PurchaseOrderReference

To be removed in a future version. Use instead "ReferenceNumber".

ReferenceNumber

An informational reference (either textual or numeric) for which the owner or source is specified in the "@AssignedBy" attribute

RetailPrice

Cover price of the finished product.

TambourID

The unique identifier of the jumbo reel (also called mother reel or Tambour).

Title

Proper title of a book product.

TitleAlias

Alternate title description for book products, usually for security purposes.

UnitsPerCarton

Number of units per box.

UniversalProductIdentifier

Unique identifier for the book, component of a book product, and many other products.

VendorBrandName

To be removed in a future version. Use instead "BrandName" and specify owner or source is in the "@AssignedBy" attribute with enumeration "Seller".

VendorGradeCode

To be removed in a future version. Use instead "GradeCode" and specify owner or source is in the "@AssignedBy" attribute with enumeration "Seller".

VendorGradeName

To be removed in a future version. Use instead "GradeName" and specify owner or source is in the "@AssignedBy" attribute with enumeration "Seller".

DocumentDate

The Date and optionally Time when the document that is referred to was issued.

(sequence)

The sequence of items below is mandatory. A single instance is required.

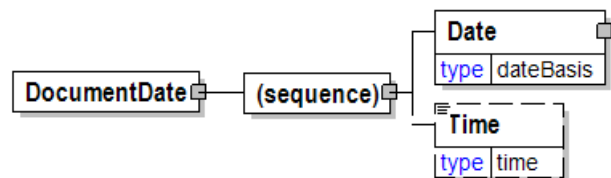

Date

Date is mandatory. A single instance is required.

A group element that contains the specification of Year, Month, and Day.

Time

Time is optional. A single instance might exist.

Times are treated in a standard XML fashion with a special case used to indicate a generalized "local" time. The standard XML approach to time is hh:mm:ss, hh:mm:ssZ, or hh:mm:ss±hh:mm.

hh:mm:ss±hh:mm is used to represent a time with a time zone. The time zone is communicated as the number of hours offset from the Universal Time Coordinate (UTC), a.k.a. Greenwich Mean Time.

hh:mm:ssZ indicates the time at Zulu (another name for UTC). Based on the convention described in the next bullet it will be important for users within UTC to use "Z" when communicating a time in their time zone to other users.

hh:mm:ss or hh:mm indicates in the XML standard the time at UTC however, within papiNet it is used to represent the applicable local time. Caution should be used when processing times of this nature as the papiNet approach may be in discord with other users of XML.

DocumentInformation

A group element containing a specification of required documents in the business process. Additional free text to be printed on documents can also be specified.

DocumentType [attribute]

DocumentType is mandatory. A single instance is required.

Identifies the type of a document

Refer to DocumentType definition for any enumerations.

(sequence)

The sequence of items below is mandatory. A single instance is required.

NumberOfDocuments

NumberOfDocuments is optional. Multiple instances might exist.

Specifies the number of documents needed.

AdditionalText

AdditionalText is optional. Multiple instances might exist.

A text field that is used to communicate information not previously defined or for special instructions. To be used only for circumstances not covered by specific elements.

DocumentInstruction

DocumentInstruction is optional. A single instance might exist.

A grouping element that specifies instructions and contents related to the creation and use of a document.

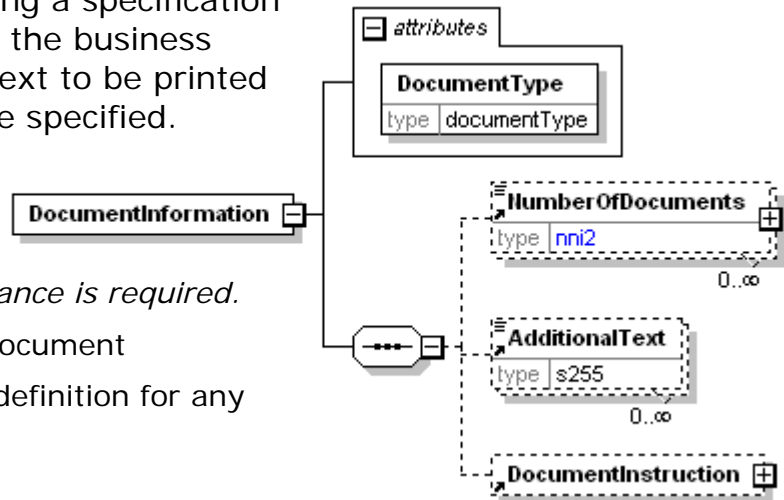

DocumentInstruction

A grouping element that specifies instructions and contents related to the creation and use of a document.

(sequence)

The sequence of items below is mandatory. A single instance is required.

DocumentInstructionText

DocumentInstructionText is optional. Multiple instances might exist.

Text that is describing instructions related to the creation and use of a document.

DocumentContent

DocumentContent is optional. Multiple instances might exist.

A grouping element specifying information contained in a document.

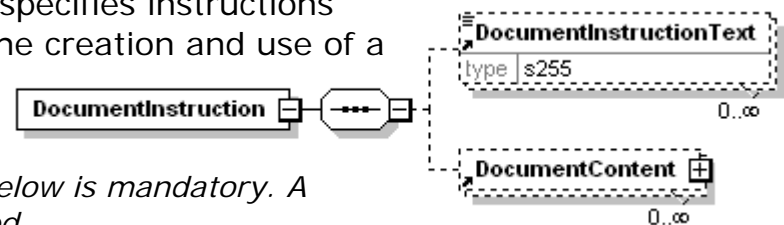

DocumentName [attribute]

Defines the name of e-Documents defined by papiNet.

This item is restricted to the following list.

Availability

The purpose of the Availability e-Document is to provide a means to ask about the availability of the specified product. The amount of the product immediately available (on-hand) is anticipated to be returned. Optionally, the anticipated availability of the product at a point in future can be communicated.

BookSpecification

The BookSpecification e-Document represents established product specifications that can be referenced by multiple transactions in the manufacturing life cycle of a product from RFQ through Invoice and subsequent reprints and/or reorders. It captures unique book manufacturing industry data elements as established by the buyer that are needed by the supplier for manufacturing.

BusinessAcceptance

The receiver of a document uses the BusinessAcceptance to confirm to the sender that the document is accepted or rejected. The BusinessAcceptance can be used as a confirmation of acceptance when there is not a papiNet-designed confirmation e-Document available. Although the BusinessAcceptance is optional between two trading partners, its use is strongly recommended when it is important to get a BusinessAcceptance.

BusinessAcknowledgement

An e-Document receiver uses the BusinessAcknowledgement to notify the sender that a document has been successfully presented to the receiver's ERP system. The BusinessAcknowledgement can be used to acknowledge any papiNet e-Document. Although the BusinessAcknowledgement is optional between two trading partners, its use is strongly recommended since it provides positive verification of the beginning of the transaction by the receiver.

Calendar

The Calendar e-Document is intended to communicate opening times or other details for a location or locations

CallOff

A CallOff is a delivery schedule for product(s). Products to be delivered can be specified by product specifications or by purchase orders. Any party as agreed in a Trading Partner Agreement can send a CallOff. Each line item in a CallOff refers either to a product included in a PurchaseOrder or to the product specifications contained in the line item. The CallOff specifies delivery schedule(s) and quantities for product(s) to be delivered. The schedule may define a specific date and/or time for delivery or include a time range. All products covered by a CallOff must be delivered to a single location.

CallOffWood

A CallOffWood is a business transaction instructing the consignor (normally the seller) to despatch goods belonging to one or several orders. A CallOffWood

contains information about how the goods are to be loaded, quantities, marking instructions etc. It may also contain information about where borders are to be crossed and information concerning transport, such as name of ship and shipping agent. In cases where the CallOffWood is not used, delivery information is included in the order.

Complaint

Typically, a Complaint e-Document is sent from the customer or end user to the supplier to communicate information regarding products or services. A response from the supplier is desired and corrective actions, if required. This e-Document must specify the necessary details to enable the supplier to trigger an internal process to verify whether the complaint reason corresponds to the supplier-assessed reason.

ComplaintResponse

Typically, a ComplaintResponse e-Document is sent from the supplier or sender parties to the party who has originated the Complaint, or possibly to the RespondToParty. The e-Document is sent to communicate the acceptance, partial acceptance, or rejection, of the preceding complaint(s) with supporting information. Whatever the decision, this e-Document must specify how the complaint will be processed.

CreditDebitNote

The CreditDebitNote e-Document is generally used by the SupplierParty to compensate or charge the trading parties (ShipToParty, BuyerParty, OtherParty, etc.) for matters outside the scope of the Invoice.

DeliveryInstruction

A DeliveryInstruction can be used to instruct movement of goods to warehouses and movement of goods to virtual locations within warehouses as well as deliveries to customers. The DeliveryInstruction e-Document is designed to fulfil supply chain requirements regarding instruction for goods deliveries to Mills, Suppliers, Forwarders, Warehouse Operators, Customers, and End-Users. The DeliveryInstruction is load oriented which is very efficient when mills and suppliers move goods in large quantities between warehouses.

DeliveryMessage

The DeliveryMessage e-Document enables the sender to describe the contents and configuration of a shipment at various levels of detail.

DeliveryMessageBook

The DeliveryMessageBook e-Document enables the sender to describe the contents and configuration of a shipment at various levels of detail.

DeliveryMessageWood

The DeliveryMessageWood e-Document enables the sender to describe the contents and configuration of a shipment at various levels of detail.

GoodsReceipt

The ShipTo party, or authorised agent, sends a GoodsReceipt e-Document to the Supplier and/or to the Buyer acknowledging that a specific delivery or a number of deliveries in a given time period have been received and their status.

InfoRequest

The purpose of InfoRequest e-Document is to allow the requesting party to request from the receiver party an update. The e-Documents that may be returned in response to an InfoRequest are the Availability, Calendar, InventoryStatus , OrderStatus, Planning, ProductQuality, ShipmenStatus, ShippingInstructions or Statement.

InventoryChange

The purpose of the InventoryChange e-Document is to inform involved parties about changes in the inventory at a specific location. The e-Document provides information allowing the receiving party to update their systems for cost tracking, performance, and financial reporting.

InventoryDispositionInstructions

The InventoryDispositionInstructions e-Document permits the owner of inventory stored at a third party location to request the inventory be destroyed, shipped to another location, held in inventory, or physically changed. The receiving party makes the requested changes to the inventory and sends an InventoryChange and ShippingInstructions, if required, to the requestor so their systems can be updated.

InventoryStatus

The InventoryStatus e-Document informs involved parties about physical inventory levels at specific stock locations (warehouse, terminal, printer etc.) at a certain time (snapshot).

Invoice

An Invoice e-Document can handle both debits and credits. Typically a seller sends an Invoice to a buyer after delivering the products or services specified in a PurchaseOrder or as part of an automatic replenishment agreement. Alternatively, an Invoice can be prepared by the buyer as part of a self-billing process. The Invoice is a list of the goods shipped and their quantities, or services rendered, indicating the price, terms of sale, supplemental charges, allowances, and communicates the payment required for the indicated items.

InvoiceWood

An InvoiceWood e-Document can handle both debits and credits. Typically a seller sends an InvoiceWood to a buyer after delivering the products or services specified in a PurchaseOrder or as part of an automatic replenishment agreement. Alternatively, an InvoiceWood can be prepared by the buyer as part of a self-billing process. The InvoiceWood is a list of the goods shipped and their quantities, or services rendered, indicating the price, terms of sale, supplemental charges, allowances, and communicates the payment required for the indicated items.

LoadAvailable

The Supplier party or authorized agent sends a LoadAvailable e-Document to the BuyerParty (consuming mill) indicating that load(s) for specific product is (are) ready on a specific date for acceptance and pickup. The LoadAvailable e-Document from the supplier may include a Shipper Load Number. This number may be used as the consuming mill's release number The Shipper Load Number is used for authorization for pick-up of load at supplier point.

LoadTender

The LoadTender e-Document supports the transport booking process. Transport booking includes the following steps:

- LoadTender – more than one carrier has been informed about the upcoming transport.
- Booking – identifies a transport booking that is part of a detail transport plan, the load has been booked with a single carrier.

LoadTenderResponse

The LoadTenderResponse e-Document supports the transport booking process and is used as a response e-Document to LoadTender e-Document. Transport booking includes the following steps:

- LoadTenderResponse – more than one carrier has been informed about the upcoming transport.
- BookingConfirmation – identifies a transport booking that is part of a detail transport plan, the load has been booked with a single carrier.

MeasuringTicket

The MeasuringTicket e-Document specifies the details from measuring of items. Packages and loads can be measured as well as individual items in packages and loads. Products, Quantities and various measured properties can be reported. These measurements can be used as a base for calculation of billable products.

OrderConfirmation

A seller sends an OrderConfirmation e-Document to a buyer after receiving a PurchaseOrder from that buyer. The e-Document contains a response to the conditions specified in the PurchaseOrder. A supplier may also send an OrderConfirmation e-Document to convey changes that the supplier has made in the order or to convey new information such as a Supplier Reference Number or Job Number.

OrderConfirmationWood

A seller sends an OrderConfirmationWood e-Document to a buyer after receiving a PurchaseOrder from that buyer. The e-Document contains a response to the conditions specified in the PurchaseOrder. A supplier may also send an OrderConfirmationWood e-Document to convey changes that the supplier has made in the order or to convey new information such as a Supplier Reference Number or Job Number.

OrderStatus

The OrderStatus e-Document permits the sender to report the current status of an order, specific order line items, or to report status of multiple orders based upon some specified criteria. The e-Document enables the sender to indicate a primary status as well as an additional secondary status at the order level as well as for each line and component.

PackingList

The PackingList e-Document specifies the details of a shipment that is being despatched. The seller should send the PackingList e-Document in sufficient time so that the recipient can process the information before the goods arrive.

The recipient can then prepare efficiently for the receipt of the goods.

Planning

The Planning e-Document provides a tool for trading partners to exchange forecasted or planned information for a specific product or event within a specified timeframe. The e-Document is designed to support a variety of business processes, which may include securing needed supplies or simply the exchange of information.

ProductAttributes

The ProductAttributes e-Document provides the means to communicate information about products between business partners.

ProductPerformance

The ProductPerformance e-Document is created by the product consumer in order to communicate back to the manufacturer the performance of the product. This e-Document will enable the manufacturer to focus on improvements related to product defects that create inefficiency during performance. The aggregation of performance factors by product will provide the mechanism for achieving the value aspect of the e-Document. The goal is to keep the products of the Pulp & Paper Industry attractive versus competing alternatives.

ProductQuality

The ProductQuality e-Document supports the exchange of quality data for individual items. The agreed properties of the product that are exchanged can include statistical values such as minimum and maximum, standard deviation, sample size, two sigma (lower-limit, upper-limit).

PurchaseOrder

A buyer sends a PurchaseOrder e-Document to a supplier to initiate a trade transaction. This e-Document, which is a request for product, usually represents a firm commitment to buy. (For one type of PurchaseOrder, called a reservation order, the PurchaseOrder is not a firm commitment to buy).

PurchaseOrderWood

A PurchaseOrderWood e-Document is set up between a buyer and a seller. In some cases an agent acts on behalf of the seller or the buyer when setting up the contract. However, the contract is not valid until signed by the buyer and the seller. A PurchaseOrderWood may cover one delivery of merchandise on one occasion or cover a time period with several deliveries. This PurchaseOrderWood refers to a standardised contract form containing all legal details.

RFQ

A buyer sends an RFQ e-Document to a supplier to initiate a request for quotation. This e-Document, which is a request for product information, represents a request for the supplier to provide a quotation for product availability, shipping, and price.

RFQResponse

A supplier sends an RFQResponse e-Document to a buyer as a response to an RFQ e-Document from the buyer. The e-Document specifies a quotation for

product availability, shipping, and price.

ScaleTicket

The ScaleTicket e-Document provides wood or fibre suppliers with a means to electronically incorporate scale system receiving data into their accounting systems from buying entities' back office systems.

ShipmentStatus

The ShipmentStatus e-Document is sent to communicate the status of a shipment or consignment with references to other documents. Typically, a ShipmentStatus e-Document is sent from the forwarder or carrier to the consignor / forwarder.

ShippingInstructions

The ShippingInstructions e-Document communicates delivery information for product(s) supported by a PurchaseOrder.

Statement

The Statement e-Document permits the manufacturer or supplier to report the current status of an invoice, or a list of invoices based upon specified criteria. The e-Document enables the sender to indicate payment status for the invoice.

Usage

The Usage e-Document is used to notify a supplier or buyer that material has been consumed within the end user's manufacturing process.

Other

Other e-documents not specified by papiNet.

DocumentNumber

The unique identifier of the original document.

DocumentNumber
type s255

DocumentReference

An element detailing relevant references pertaining to the papiNet e-Document as indicated by the DocumentReferenceType and AssignedBy.

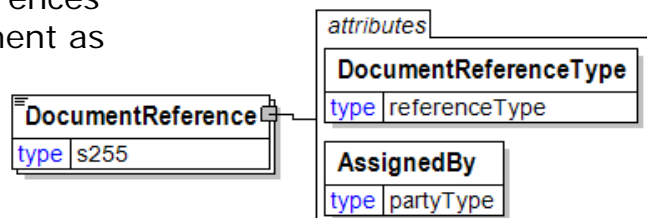

DocumentReferenceType [attribute]

DocumentReferenceType is mandatory. A single instance is required.

DocumentReferenceType provides a contextual explanation of the specific reference identifier. Many items are currently prefixed by "Buyer", "Customer", "Seller", and/or "Supplier". Check for an existing non-prefixed version and use the non-prefixed version instead. In the (yet to be announced release date)

papiNet V2R31

version 3.0 the prefixed versions will be removed. Instead the attribute @AssignedBy will communicate the information previously communicated in the prefix.

Refer to DocumentReferenceType definition for any enumerations.

AssignedBy [attribute]

AssignedBy is optional. A single instance might exist.

Identifies the type of party that has assigned the associated item, e.g. a reference of type OrderNumber.

Refer to AssignedBy definition for any enumerations.

DocumentReferenceID

Identification for the document being referenced

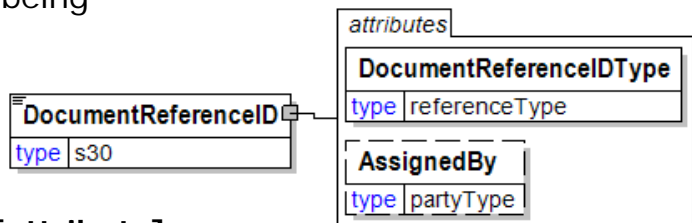

DocumentReferenceIDType [attribute]

DocumentReferenceIDType is mandatory. A single instance is required.

Provides a contextual explanation of the specific reference identifier. Many items are currently prefixed by "Buyer", "Forwarder", "Manufacturer", "Mill", "Seller", "Supplier", "Warehouse", or "Vendor". Check for an existing non-prefixed version and use the non-prefixed version instead. In the (yet to be announced release date) version 3.0 the prefixed versions will be removed. Instead the attribute @AssignedBy will communicate the information previously communicated in the prefix.

Refer to DocumentReferenceIDType definition for any enumerations.

AssignedBy [attribute]

AssignedBy is optional. A single instance might exist.

Identifies the type of party that has assigned the associated item, e.g. a reference of type OrderNumber.

Refer to AssignedBy definition for any enumerations.

DocumentReferenceIDLineItemNumber

Line item number for a specific line of the document being referenced

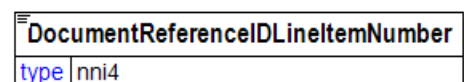

DocumentReferenceIDType [attribute]

Provides a contextual explanation of the specific reference identifier. Many items are currently prefixed by "Buyer", "Forwarder", "Manufacturer", "Mill", "Seller", "Supplier", "Warehouse", or "Vendor". Check for an existing non-prefixed version and use the non-prefixed version instead. In the (yet to be announced release date) version 3.0 the prefixed versions will be removed. Instead the attribute @AssignedBy will communicate the information previously communicated in the prefix.

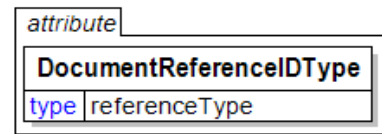

Refer to the [referenceType](#) entry for the list of enumerations and their definitions.

DocumentReferenceInformation

A group item containing reference information applicable to a document.

(sequence)

The sequence of items below is mandatory. A single instance is required.

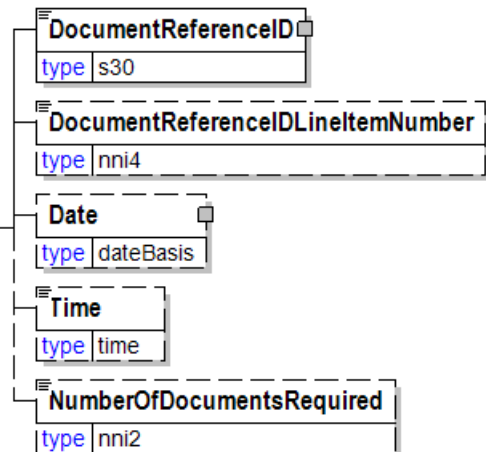

DocumentReferenceID

DocumentReferenceID is mandatory. A single instance is required.

Identification for the document being referenced

DocumentReferenceIDLineItemNumber

DocumentReferenceIDLineItemNumber is optional. A single instance might exist.

Line item number for a specific line of the document being referenced

Date

Date is optional. A single instance might exist.

A group element that contains the specification of Year, Month, and Day.

Time

Time is optional. A single instance might exist.

Times are treated in a standard XML fashion with a special case used to indicate a generalized "local" time. The standard XML approach to time is hh:mm:ss, hh:mm:ssZ, or hh:mm:ss±hh:mm.

hh:mm:ss±hh:mm is used to represent a time with a time zone. The time zone is communicated as the number of hours offset from the Universal Time Coordinate (UTC), a.k.a. Greenwich Mean Time.

hh:mm:ssZ indicates the time at Zulu (another name for UTC). Based on the convention described in the next bullet it will be important for users within

UTC to use "Z" when communicating a time in their time zone to other users.

hh:mm:ss or hh:mm indicates in the XML standard the time at UTC however, within papiNet it is used to represent the applicable local time. Caution should be used when processing times of this nature as the papiNet approach may be in discord with other users of XML.

NumberOfDocumentsRequired

NumberOfDocumentsRequired is optional. A single instance might exist.

The number of copies of the document required.

DocumentReferenceType [attribute]

DocumentReferenceType provides a contextual explanation of the specific reference identifier. Many items are currently prefixed by "Buyer", "Customer", "Seller", and/or "Supplier". Check for an existing non-prefixed version and use the non-prefixed version instead. In the (yet to be announced release date) version 3.0 the prefixed versions will be removed. Instead the attribute @AssignedBy will communicate the information previously communicated in the prefix.

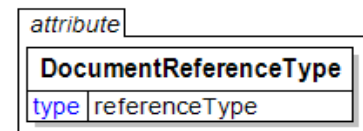

Refer to the [referenceType](#) entry for the list of enumerations and their definitions.

DocumentRequired

An element that permits the listing of the documents required.

DocumentRequiredType [attribute]

DocumentRequiredType is mandatory. A single instance is required.

Indicates which documents are required.

Refer to DocumentRequiredType definition for any enumerations.

AssignedBy [attribute]

AssignedBy is optional. A single instance might exist.

Identifies the type of party that has assigned the associated item, e.g. a reference of type OrderNumber.

Refer to AssignedBy definition for any enumerations.

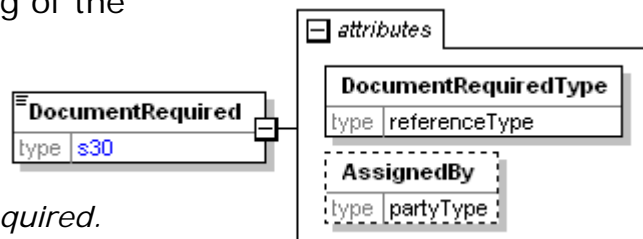

DocumentRequiredType [attribute]

Indicates which documents are required.

Many items are currently prefixed by "Buyer", "Customer", "Seller", and/or "Supplier". Check for an existing non-prefixed version and use the non-prefixed version instead. In the (yet to be announced release date) version 3.0 the prefixed versions will be removed. Instead the attribute @AssignedBy will communicate the information previously communicated in the prefix.

Refer to the [referenceType](#) entry for the list of enumerations and their definitions.

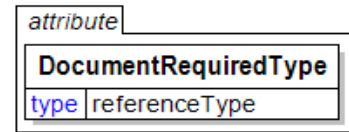

DocumentType [attribute]

Identifies the type of a document.

Used by DocumentInformation element

This item is restricted to the following list.

ATR

BillOfLading

CertificateForPackaging

CIM

CMR

DeliveryNote

EUR1

Invoice

PackingList

The PackingList e-Document specifies the details of a shipment that is being despatched. The seller should send the PackingList e-Document in sufficient time so that the recipient can process the information before the goods arrive. The recipient can then prepare efficiently for the receipt of the goods.

PowerOfAttorney

TORG12

T2

T2L

UnitPaper

WayBill

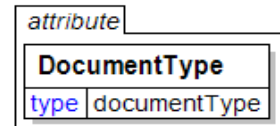

DocumentType [attribute]

The type of e-Document being communicated.
Used by Document element

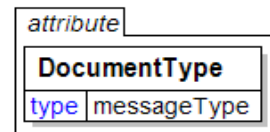

This item is restricted to the following list.

Agreement

A legally binding exchange of promises between parties that the law will enforce.

Approximate

An Invoice that is created to record ownership transfer without the material physically being moved. Typically what occurs is that the buyer has agreed to take ownership of the item at a certain point in time but has not arranged for transportation. Approximate invoices are invoices that are claiming payment.

AvailabilityStatus

BlanketOrder

An order that communicates the same information as a StandardOrder but also indicates that the order may be completed over a period of time or, until a certain volume is achieved or, until a certain currency amount is spent.

Booking

An indication that time for a service is required. For example a booking that is part of a detail transport plan.

BookingConfirmation

A communication affirming the placement of the booking with a particular party.

CalibrationCheckLog

A MeasuringTicketType that contains a check log with information about calibration of measuring equipment.

CallOff

Defines a CallOff sent by the buyer to the seller.

CallOffConfirmation

Defines a CallOff confirmation sent in response to a CallOff.

Claim

A "Claim" type is used when there is a customer reaction that includes a financial compensation.

Complaint

ConfirmingOrder

A confirming order is used to electronically confirm an order that has not been placed electronically by the customer that is, it was placed using another mean such as fax, phone or email.

ConsumptionOrder

A PurchaseOrder that is based upon consumption for a particular period of time or instance.

CreditNote

Credits that are provided for amount reductions and complaints. A CreditNode will normally have a reference to an earlier issued Invoice.

DebitNote

A DebitNote claims payment for additional charges. A DebitNote normally has a reference to an earlier issued Invoice.

DeliveryInstruction

A DeliveryInstruction can specify many delivery events. Each event can contain quantity for one or many loads. A sequence in a DeliveryInstruction specifies all details for one event. The receiver of a DeliveryInstruction can generate many Loading Instructions from one DeliveryInstruction.

DeliveryMessage

A DeliveryMessage type that contains optional routing information, quantities at the DeliveryMessageLineItem level, and details at the DeliveryMessageLineItemDetail level. The seller uses a DeliveryMessage to provide delivery details to the ship-to party and tracking information.

Duplicate

To be removed in a future version. When an Invoice is reissued as a duplicate the Invoice type should be the same as on the original Invoice. Use attribute Reissued = Yes to indicate a duplicate.

Feedback

A "Feedback" type is used when there is a customer reaction that doesn't include any financial compensation.

InitialShipmentAdvice

A DeliveryMessage type that contains detailed routing information, quantities at the DeliveryMessageLineItem level and optionally details at the DeliveryMessageLineItemDetail level. The seller uses the InitialShipmentAdvice to provide preliminary notification of shipment routing and quantities (can be used as an advanced notice of delivery). The quantities indicated may not necessarily be delivered—for example, if there is damage in transit or the delivery is rerouted to another destination.

InventoryChange

InventoryStatus

Invoice

A regular Invoice (referred to as an Invoice) is claims payment for products, services, and charges supplied under conditions agreed to between seller and buyer. The Invoice communicates, among other things, payment terms, payment method, and the payment amount required for one or more deliveries.

InvoiceSpecification

A MeasuringTicketType that contains information about measured products including prices and amounts. This MeasuringTicketType is normally used as a detailed specification of billable or invoiced products.

LoadAvailable

LoadAvailableConfirmation

LoadedSpecification

A DeliveryMessage type that contains a specification of loaded goods on a transport unit (e.g. container, rail wagon). A loading specification (LoadedSpecification) can contain goods belonging to many suppliers and buyers and is normally referring to a Loading Instruction.

LoadingInstruction

A Loading Instruction specifies loading of transport units. A Forwarder receiving a DeliveryInstruction from a supplier can convert it into many Loading Instructions, which are sent to a Warehouse Operator. A sequence in a Loading Instruction specifies all details how to load one transport unit. A Loading Instruction can include goods from many delivery instructions and also goods belonging to many suppliers.

LoadingOrder

Specifies delivery schedule, the transport booking requirements and shipping instructions, as well as the internal work order for the shipment

LoadingSchedule

The schedule for transport vehicle loading.

LoadTender

More than one carrier has been informed about the upcoming transport requirement (the load).

LoadTenderResponse

Indicates the ability of the respondent to fulfill the load tender request.

MeasuringTicket

A MeasuringTicketType that contains detailed information about measured products and items. This information can be used as a base for calculation of billable products.

OfficeSchedule

The schedule for office personnel.

OrderStatus

PackingSpecification

A Packing Specification is a business transaction specifying the complete consignment being shipped from a consignor to a consignee. The specification describes in detail what is being shipped and how it is packed and marked.

PreBooking

A requirement for a transport vehicle or unit reservation that has risen from a rough transport plan.

PreBookingConfirmation

A communication of the requirement for a transport vehicle or unit reservation that has risen from a rough transport plan.

PrePayment

A prepayment Invoice is used as a notification of amounts to be paid in

advance. It is not a legal Invoice claiming payment for provided products or services.

PriceList

Used when sending a pricelist

ProductCrossReference

Used in the exchange of ProductIdentifier cross-references for the product codes used by two trading partners

ProductionTicket

A MeasuringTicketType that contains information about produced products and items. A ProductionTicket can also contain measuring information for produced items.

ProductProperties

Used when sending a list of ProductAttributes

ProForma

A pro-forma Invoice is not a legal Invoice claiming payment. A pro-forma Invoice is an e-Document serving as a preliminary Invoice, containing on the whole the same information as the final Invoice, but not actually claiming payment. Pro-forma invoices are typically used in a cross-border shipment for customs purposes. Can travel with the product or be sent to a broker.

ReleaseOrder

A release order is used to release a product to be made. This type of order refers to a previous order or agreement, such as a reservation order, a contract, or a blanket order. A release number version which is an incremented number, is used in this type.

ReservationOrder

A reservation order is used to book a paper supplier's capacity for specific quantities of specific products, but it is not yet a firm commitment to buy. Consequently, all line items of a reservation order have a ProductionStatusType of NotFree. To release one or more PurchaseOrder line items of a reservation order, a buyer can use a standard order or a release order.

SampleMeasuringTicket

A MeasuringTicketType that contains detailed information about measured samples taken from e.g. a delivery.

SelfBillingStatement

A SelfBillingStatement is an Invoice that is prepared by the buyer of the product (or the consumer of the service) for the provider of the product or service. The preparer will pay the Invoice.

Typically, logistics cost-charges are the services that are communicated. They are incurred during a certain period of time between the party who provides the logistics services (typically the party with a LogisticsRole of "LogisticsProvider") and the requestor of such services (typically the party with a LogisticsRole of "Consignor").

Raw materials, maintenance, repair, and operating supplies are examples of

products that can be entered on a self billing statement for products. This type of Invoice is also referred to as an invoice for “evaluated receipts” because it developed from the receiving department’s evaluation of their receipts and from that creating the Invoice.

The SelfBillingStatement process exists when there is a great deal of trust between the trading partners that permits this cost savings business process.

ShipmentAdvice

A DeliveryMessage type that contains a specification of goods, that are dispatched and will be delivered to a warehouse. A ShipmentAdvice can refer to a DeliveryInstruction Sequence or a CallOff, but is normally also used for notifying a receiving warehouse operator of shipments to the warehouse.

ShippingInstructionsConfirmation

Confirmation of the Shipping Instruction.

ShippingInstructionsDistribution

Shipping Instruction serves as a billable order for shipping product that was produced under a previous manufacturing order.

ShippingInstructionsPackaging

To be deprecated in a future version. Guidance will be given to trading partners not to use this enumeration.

ShippingInstructionsRouting

Shipping instructions issued in conjunction with a PurchaseOrder for shipping the product.

SpecOrder

Used when the BookSpecification e-Document is intended for use with the PurchaseOrder transaction.

StandardOrder

A standard order is a regular one-time order. It defines quantities for one or more products to be purchased and may also define a delivery location and date. A standard order may reference a previous agreement (for example, a quotation, a contract, or a reservation order) for information.

SpecRFQ

Used when the BookSpecification e-Document is intended for use with the Request for Quote (Estimate) transaction.

StandardRFQ

SupplierSpec

Will be removed in a future version. Recommended not to be used.
(Old definition: Used when the BookSpecification e-Document is intended for use by the Supplier only and is not generated by, or transmitted to the Buyer).

SupportSchedule

The support schedule for transport operations.

ThirdPartyShipmentAdvice

Notification of a shipment from a warehouse to a party other than the party

that ordered the product from the supplier.

TrialOrder

A trial order is used whenever a seller has agreed to have a buyer sample a product. The seller needs to process this order differently from other orders, because a trial order may include a product sold at a discounted rate or even provided for free. A trial order typically is for small quantities.

UnloadingSchedule

The schedule for transport vehicle unloading.

Waybill

The forwarding agreement or carrying agreement that is used as a receipt for cargo and as a contract of carriage.

DocumentVersionNumber

The document version number, currently BookSpecification is the only e-Document that has a Version Number.

DocumentVersionNumber	
type	s02

DominantWavelength

Dominant wavelength

TestMethod [attribute]

TestMethod is optional. A single instance might exist.

The method used to determine the results of the test under consideration.

TestAgency [attribute]

TestAgency is optional. A single instance might exist.

The agency that has set the parameters for the testing

Refer to TestAgency definition for any enumerations.

SampleType [attribute]

SampleType is optional. A single instance might exist.

Communicates how sampling was done to measure the product characteristics.

Refer to SampleType definition for any enumerations.

ResultSource [attribute]

ResultSource is optional. A single instance might exist.

Used to define the data source of the specified test

Refer to ResultSource definition for any enumerations.

(sequence)

The sequence of items below is mandatory. A single instance is required.

DetailValue

DetailValue is mandatory. A single instance is required.

A numeric value expressed in the unit of measure (UOM).

DetailRangeMin

DetailRangeMin is optional. A single instance might exist.

The minimum value (lower boundary) allowed for the DetailValue that is the parent of this element.

DetailRangeMax

DetailRangeMax is optional. A single instance might exist.

The maximum value (upper boundary) allowed for the DetailValue that is the parent of this element.

StandardDeviation

StandardDeviation is optional. A single instance might exist.

A statistic used as a measure of dispersion in a distribution.

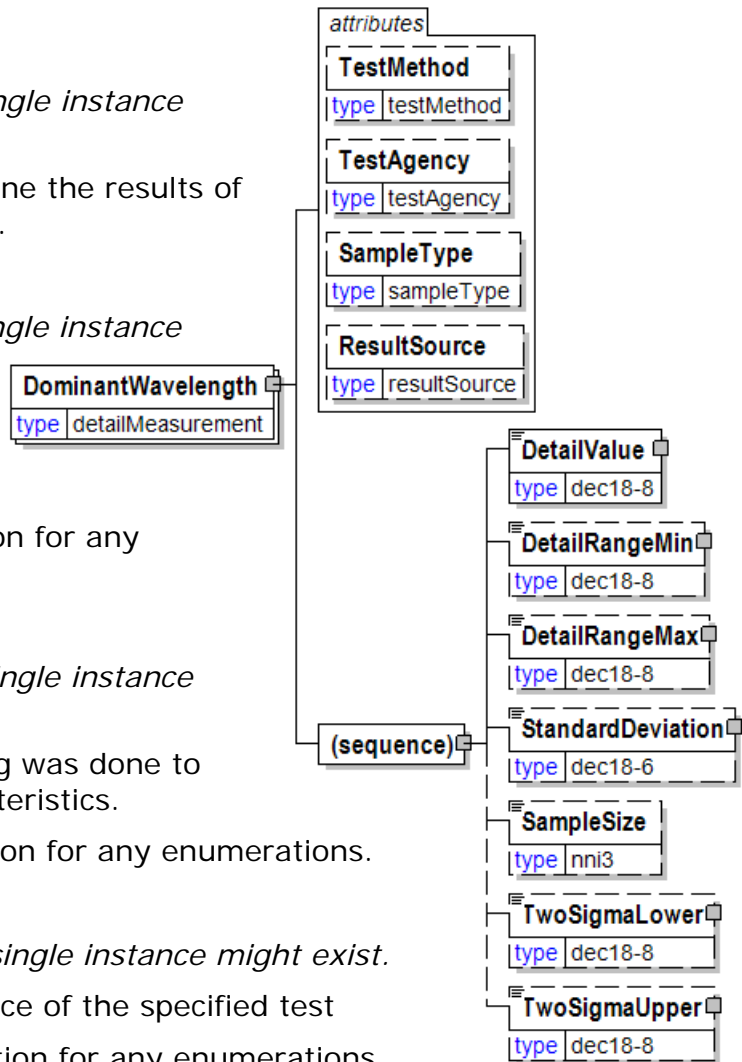

SampleSize

SampleSize is optional. A single instance might exist.

The number of samples used to determine the product characteristic in question.

TwoSigmaLower

TwoSigmaLower is optional. A single instance might exist.

Two sigma (a measure of dispersion associated with standard deviation) on the lower side of the standard deviation.

TwoSigmaUpper

TwoSigmaUpper is optional. A single instance might exist.

Two sigma (a measure of dispersion associated with standard deviation) on the upper side of the standard deviation.

DoubleBunked [attribute]

Either "Yes" or "No".

This item is restricted to the following list.

Yes

No

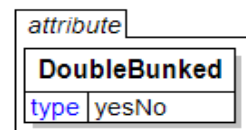

DownGradingInfo

A grouping element that contains information about downgrading of products.

(sequence)

The sequence of items below is mandatory. A single instance is required.

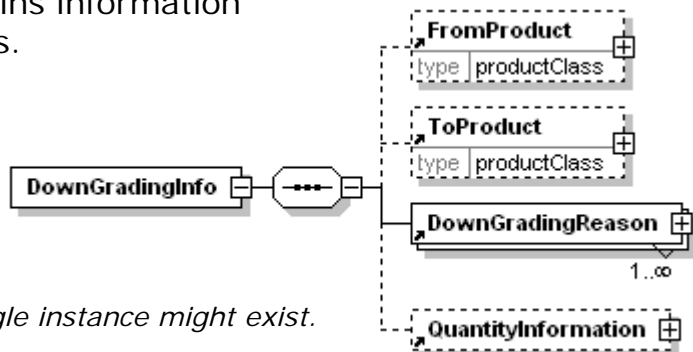

FromProduct

FromProduct is optional. A single instance might exist.

Defines from which product the item is downgraded.

ToProduct

ToProduct is optional. A single instance might exist.

Defines to which product the item is downgraded.

DownGradingReason

DownGradingReason is mandatory. Multiple instances might exist.

A free form description of the reason for downgrading.

QuantityInformation

QuantityInformation is optional. A single instance might exist.

A group item containing information about quantity and informational quantity of similar items.

DownGradingReason

A grouping element that contains the reason for downgrading.

(sequence)

The sequence of items below is mandatory. A single instance is required.

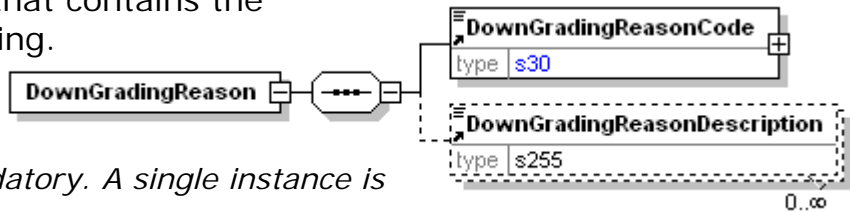

DownGradingReasonCode

DownGradingReasonCode is mandatory. A single instance is required.

A code that specifies the reason for downgrading. The Agency responsible for the code is associated with the element.

DownGradingReasonDescription

DownGradingReasonDescription is optional. Multiple instances might exist.

A free form description of the reason for downgrading.

DownGradingReasonCode

A code that specifies the reason for downgrading. The Agency responsible for the code is associated with the element.

Agency [attribute]

Agency is mandatory. A single instance is required.

Describes the agency maintaining the list of codes. To be included in this list the agency must be a recognized standards body or industry organisation.

For the element that owns this attribute.

- For another attribute in the list of attributes associated with the parent element.

Refer to Agency definition for any enumerations.

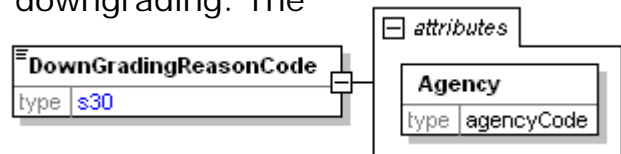

DownGradingReasonDescription

A free form description of the reason for downgrading.

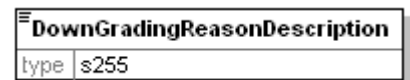

Downtime

An element used to communicate when equipment is not available for manufacturing purposes.

(sequence)

The sequence of items below is mandatory. A single instance is required.

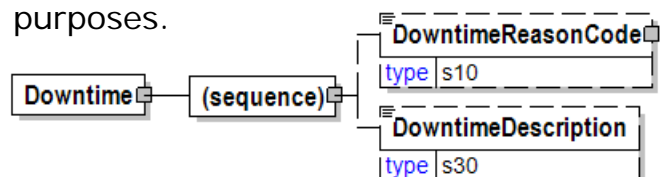

DowntimeReasonCode

DowntimeReasonCode is optional. A single instance might exist.

A reason code created by the indicated agency for downtime.

DowntimeDescription

DowntimeDescription is optional. A single instance might exist.

The description of the downtime.

DowntimeDescription

The description of the downtime.

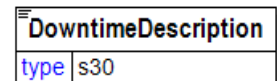

DowntimeReasonCode

A reason code created by the indicated agency for downtime.

Agency [attribute]

Agency is mandatory. A single instance is required.

Describes the agency maintaining the list of codes. To be included in this list the agency must be a recognized standards body or industry organisation.

For the element that owns this attribute.

For another attribute in the list of attributes associated with the parent element.

Refer to Agency definition for any enumerations.

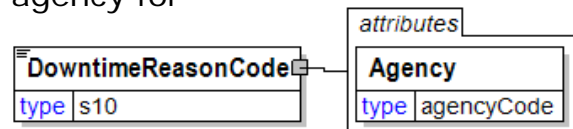

DrainageResistance

A group item used to communicate drainage resistance target or test value.

TestMethod [attribute]

TestMethod is optional. A single instance might exist.

The method used to determine the results of the test under consideration.

TestAgency [attribute]

TestAgency is optional. A single instance might exist.

The agency that has set the parameters for the testing

Refer to TestAgency definition for any enumerations.

SampleType [attribute]

SampleType is optional. A single instance might exist.

Communicates how sampling was done to measure the product characteristics.

Refer to SampleType definition for any enumerations.

ResultSource [attribute]

ResultSource is optional. A single instance might exist.

Used to define the data source of the specified test

Refer to ResultSource definition for any enumerations.

(sequence)

The sequence of items below is mandatory. A single instance is required.

DetailValue

DetailValue is mandatory. A single instance is required.

A numeric value expressed in the unit of measure (UOM).

DetailRangeMin

DetailRangeMin is optional. A single instance might exist.

The minimum value (lower boundary) allowed for the DetailValue that is the parent of this element.

DetailRangeMax

DetailRangeMax is optional. A single instance might exist.

The maximum value (upper boundary) allowed for the DetailValue that is the parent of this element.

StandardDeviation

StandardDeviation is optional. A single instance might exist.

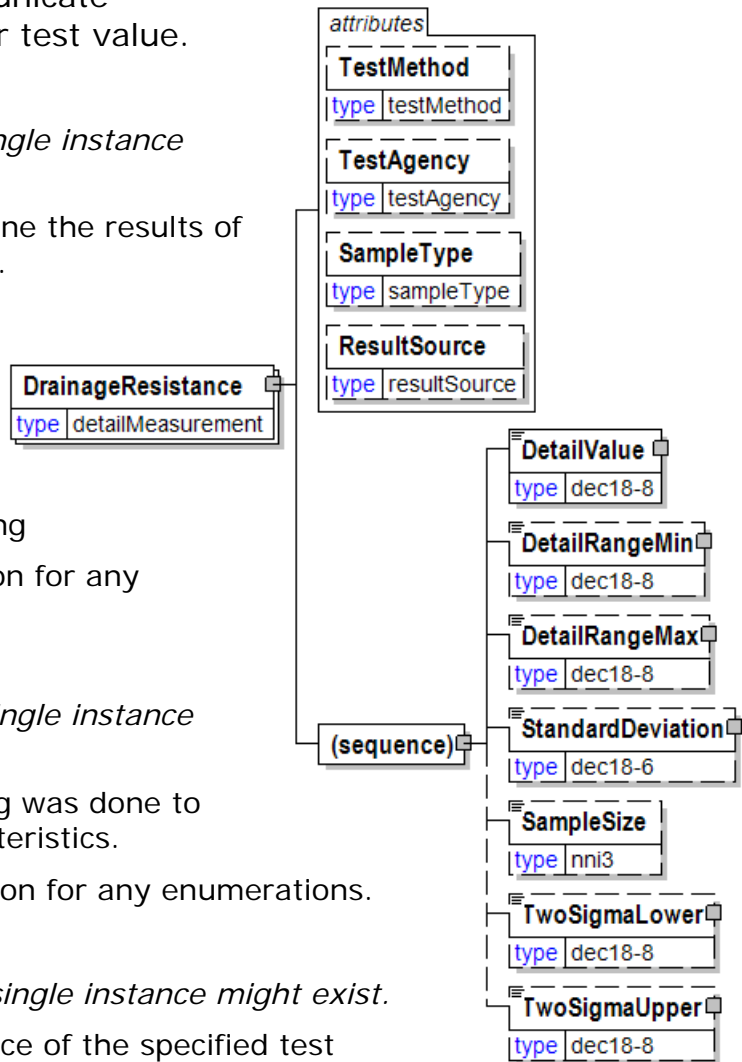

papiNet V2R31

A statistic used as a measure of dispersion in a distribution.

SampleSize

SampleSize is optional. A single instance might exist.

The number of samples used to determine the product characteristic in question.

TwoSigmaLower

TwoSigmaLower is optional. A single instance might exist.

Two sigma (a measure of dispersion associated with standard deviation) on the lower side of the standard deviation.

TwoSigmaUpper

TwoSigmaUpper is optional. A single instance might exist.

Two sigma (a measure of dispersion associated with standard deviation) on the upper side of the standard deviation.

Drilled [attribute]

Either "Yes" or "No".

This item is restricted to the following list.

Yes

No

The diagram shows a box labeled 'attribute' containing a sub-box labeled 'Drilled'. Below 'Drilled' is a box labeled 'type' with the value 'yesNo' next to it.

DuplicationRatio [attribute]

Duplication ratio

Any valid string

The diagram shows a box labeled 'attribute' containing a sub-box labeled 'DuplicationRatio'. Below 'DuplicationRatio' is a box labeled 'type' with the value 'duplicationRatio' next to it.

DVD

DVD

DVDFormatType [attribute]

DVDFormatType is optional. A single instance might exist.

DVD format type

Refer to DVDFormatType definition for any enumerations.

DiscPrinting [attribute]

DiscPrinting is optional. A single instance might exist.

Disc printing

Refer to DiscPrinting definition for any enumerations.

(sequence)

The sequence of items below is mandatory. A single instance is required.

SequenceNumber

SequenceNumber is optional. A single instance might exist.

NumberOfColours

NumberOfColours is optional. A single instance might exist.

The number of colours

ColourSpecs

ColourSpecs is optional. A single instance might exist.

Colour specs

MediaLength

MediaLength is optional. A single instance might exist.

Media length

PressPrep

PressPrep is optional. Multiple instances might exist.

Press preparation information

CDPackaging

CDPackaging is mandatory. One instance is required, multiple instances might exist.

CD Packaging

AdditionalText

AdditionalText is optional. Multiple instances might exist.

A text field that is used to communicate information not previously defined or for special instructions. To be used only for circumstances not covered by specific elements.

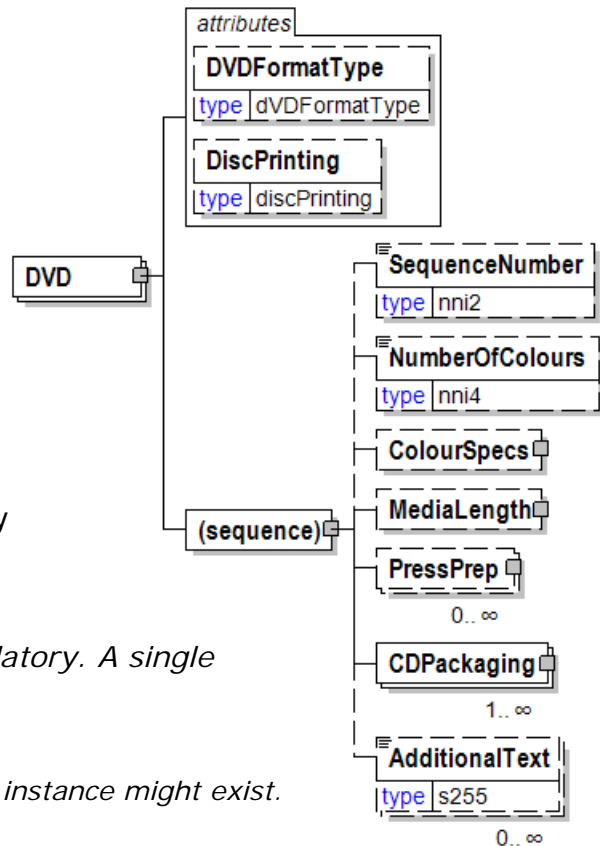

DVDFormatType [attribute]

DVD format type

This item is restricted to the following list.

- 1
- 2
- 3
- 4
- 5
- 6
- 7
- 8

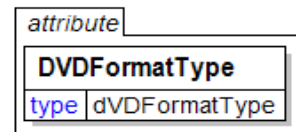

eAttachment

eAttachment enables the sender to provide information about attachments to the document.

Note: An element "e-Attachment" also exists. papiNet will no longer use hyphens in our element and attribute names as this causes issues with BizTalk.

(sequence)

The sequence of items below is mandatory. A single instance is required.

AttachmentFileName

AttachmentFileName is optional. Multiple instances might exist.

The name of the attached file.

NumberOfAttachments

NumberOfAttachments is optional. A single instance might exist.

NumberOfAttachments indicates the number of attachments enclosed in the e-Document

URL

URL is optional. Multiple instances might exist.

Universal Resource Locator. While typically a web address you could use this field to hold an email address.

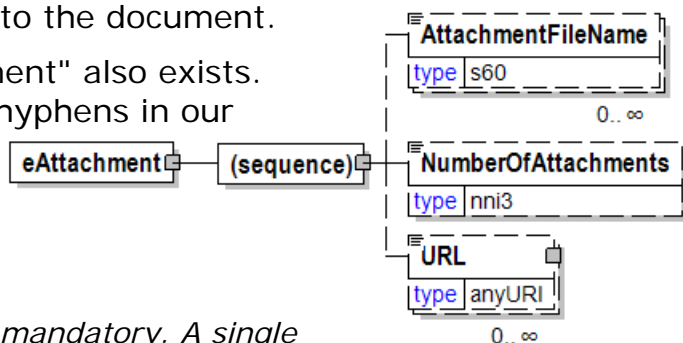

e-Attachment

e-Attachment enables the sender to provide information about attachments to the document.

Note: BizTalk users may have problems in processing this element. See the papiNet FAQs (papiNet.org) for more information.

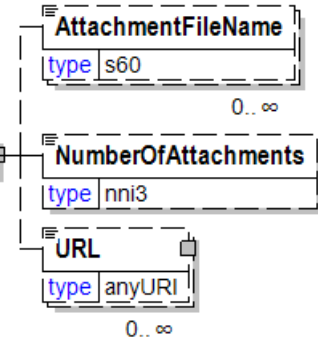

(sequence)

The sequence of items below is mandatory. A single instance is required.

AttachmentFileName

AttachmentFileName is optional. Multiple instances might exist.

The name of the attached file.

NumberOfAttachments

NumberOfAttachments is optional. A single instance might exist.

NumberOfAttachments indicates the number of attachments enclosed in the e-Document

URL

URL is optional. Multiple instances might exist.

Universal Resource Locator. While typically a web address you could use this field to hold an email address.

Edge

Describes the finishing of the edge of the board.

EdgeType [attribute]

EdgeType is optional. A single instance might exist.

Edge type (plywood)

Refer to EdgeType definition for any enumerations.

EdgeLocation [attribute]

EdgeLocation is optional. A single instance might exist.

Location of edge of a sheet or board, (e.g. top/bottom/left/right).

Refer to EdgeLocation definition for any enumerations.

(sequence)

The sequence of items below is mandatory. A single instance is required.

EdgeMachiningProfile

EdgeMachiningProfile is optional. A single instance might exist.

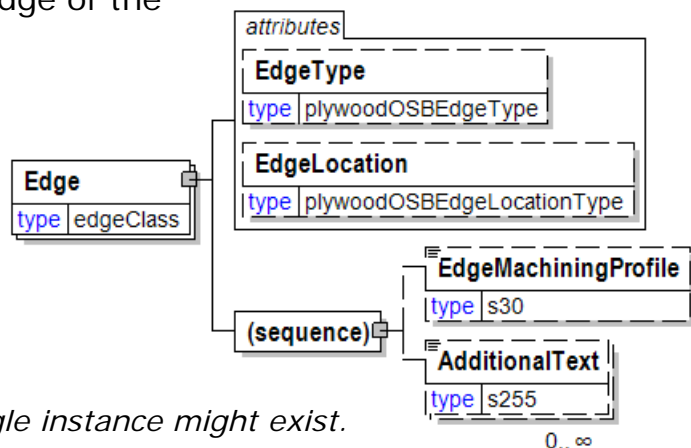

The edge machining profile.

AdditionalText

AdditionalText is optional. Multiple instances might exist.

A text field that is used to communicate information not previously defined or for special instructions. To be used only for circumstances not covered by specific elements.

Edge

Describes the finishing of the edge of the board.

EdgeType [attribute]

EdgeType is optional. A single instance might exist.

Edge type (plywood)

Refer to EdgeType definition for any enumerations.

EdgeLocation [attribute]

EdgeLocation is optional. A single instance might exist.

Location of edge of a sheet or board, (e.g. top/bottom/left/right).

Refer to EdgeLocation definition for any enumerations.

(sequence)

The sequence of items below is mandatory. A single instance is required.

EdgeMachiningProfile

EdgeMachiningProfile is optional. A single instance might exist.

The edge machining profile.

AdditionalText

AdditionalText is optional. Multiple instances might exist.

A text field that is used to communicate information not previously defined or for special instructions. To be used only for circumstances not covered by specific elements.

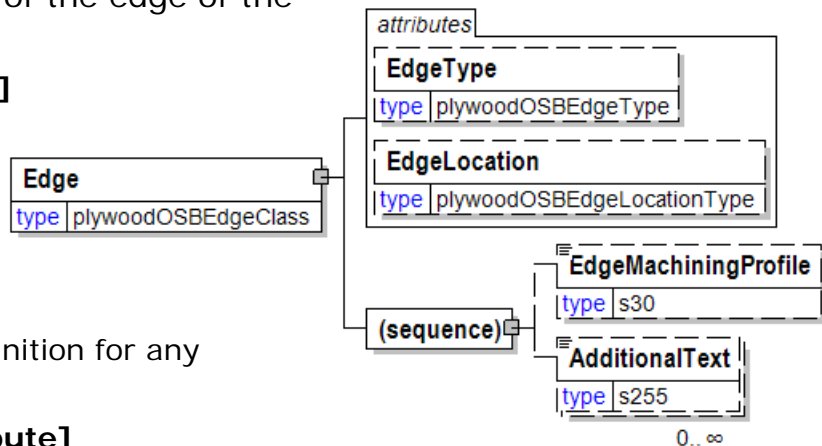

EdgeFinish

The finish applied to the edge.

This item is restricted to the following list.

Trimmed

Rough

Deco

Stained



Guided

EdgeLocation [attribute]

Location of edge of a sheet or board, (e.g. top/bottom/left/right).

This item is restricted to the following list.

North

Top

South

Bottom

East

Right

West

Left

attribute
EdgeLocation
type plywoodOSBEdgeLocationType

EdgeLocationType [attribute]

Edge location type.

This item is restricted to the following list.

Foot

Lowest part of the book.

Head

Top part of the book.

Margin

The blank space bordering the written part of a book.

Spine

Hinged back of the book.

Thumb

Front edge of the book.

attribute
EdgeLocationType
type edgeLocationType

EdgeMachiningProfile

The edge machining profile.

EdgeMachiningProfile
type s30

EdgePaddable [attribute]

Refers to the process of applying edge padding glue or adhesive (Yes) or not (No). A liquid adhesive mixture which when brushed or sprayed onto the side of a pile of paper binds the sheets together along one edge, thus forming a pad.

attribute	
EdgePaddable	
type	yesNo

This item is restricted to the following list.

Yes

No

EdgeType [attribute]

Edge type (paper)

This item is restricted to the following list.

Bottom

Foot

Head

Left

Margin

Right

Spine

Thumb

Top

attribute	
EdgeType	
type	edgeType

EdgeType [attribute]

Edge type (plywood)

This item is restricted to the following list.

ShipLap

SquareEdge

TongueAndGroove-FullFace

TongueAndGroove-ScantFace

attribute	
EdgeType	
type	plywoodOSBEdgeType

Email

The primary business email address of the individual associated with the ContactName.

Email	
type	email

Embossing

Embossing requirements for sheets and reels.
Embossing involves a physical deformation of the paper surface as part of the conversion process.
Embossing is applied either in-line (directly after the paper machine) or off-line. Refer to the attribute FinishType for additional information.

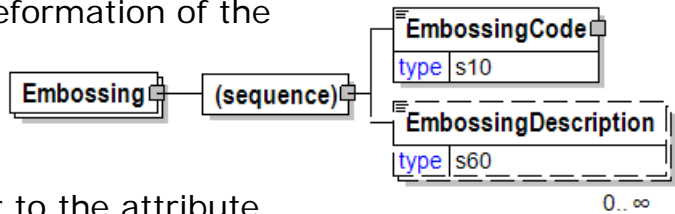

(sequence)

The sequence of items below is mandatory. A single instance is required.

EmbossingCode

EmbossingCode is mandatory. A single instance is required.

A code to identify the type of Embossing.

EmbossingDescription

EmbossingDescription is optional. Multiple instances might exist.

A description of the embossing.

EmbossingCode

A code to identify the type of Embossing.

Agency [attribute]

Agency is mandatory. A single instance is required.

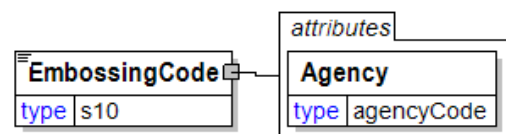

Describes the agency maintaining the list of codes. To be included in this list the agency must be a recognized standards body or industry organisation.

For the element that owns this attribute.

For another attribute in the list of attributes associated with the parent element.

Refer to Agency definition for any enumerations.

EmbossingDescription

A description of the embossing.

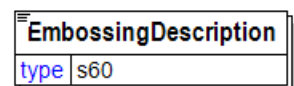

EndCaps

A cover to protect the ends of the reel, usually circle shaped and made from Kraft paper or plywood.

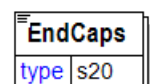

EndIdentifierRange

A group element that identifies the ending item identifier in the range of items that contributed to the aggregated measurements for the range.

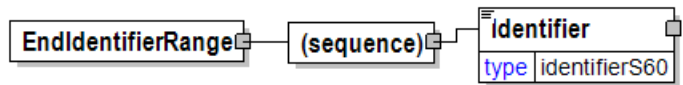

(sequence)

The sequence of items below is mandatory. A single instance is required.

Identifier

Identifier is mandatory. A single instance is required.

An Identifier is required for packages and items (pallets, reel packages, boxes, ream items, reel items, etc). The Identifier element contains the actual item identifier code. Identifier is repeatable so more than one identifier can be communicated. For example, the printed identifier on a label may be different from the barcode printed on the label.

EndsDiscountInformation

Rule for calculating the ends discount, expressed by a code.

EndsDiscountRule [attribute]

EndsDiscountRule is optional. A single instance might exist.

The rule applied for price reduction for product ends

Refer to EndsDiscountRule definition for any enumerations.

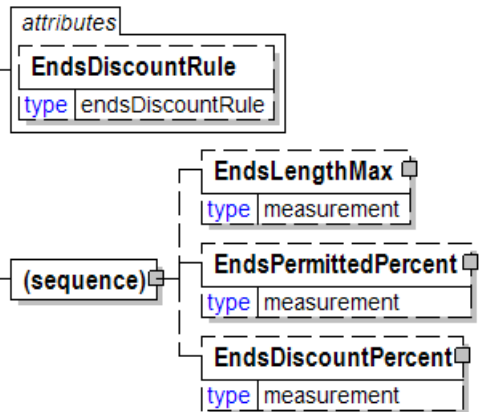
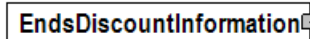

(sequence)

The sequence of items below is mandatory. A single instance is required.

EndsLengthMax

EndsLengthMax is optional. A single instance might exist.

Maximum length to be considered as ends.

EndsPermittedPercent

EndsPermittedPercent is optional. A single instance might exist.

The amount of the goods in percentage to be considered as ends.

EndsDiscountPercent

EndsDiscountPercent is optional. A single instance might exist.

The discount percentage agreed between the seller and the buyer.

EndsDiscountPercent

The discount percentage agreed between the seller and the buyer.

(sequence)

The sequence of items below is mandatory. A single instance is required.

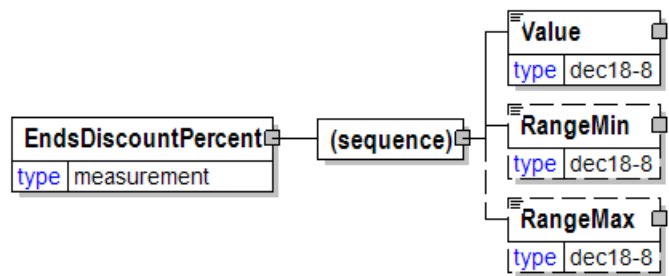

Value

Value is mandatory. A single instance is required.

A numeric value expressed in the unit of measure (UOM).

RangeMin

RangeMin is optional. A single instance might exist.

The minimum value (lower boundary) allowed for the Measurement that is the parent of this element.

RangeMax

RangeMax is optional. A single instance might exist.

The maximum value (upper boundary) allowed for the Measurement that is the parent of this element. Some elements use the RangeMax element with an extended list of unit of measures. (Note: the red colour in the picture is an artifact of how the graphic was captured and should be disregarded.)

EndsDiscountRule [attribute]

The rule applied for price reduction for product ends

This item is restricted to the following list.

NoDiscount

No Discount

TotalVolume

Discount based on total volume of product

TotalVolumeOverPermittedPercent

Discount based on total volume of product in excess of a permitted percent

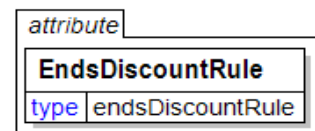

EndsheetCopyDescription

End sheet copy description

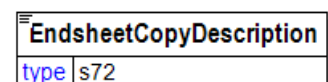

EndsheetInformation

End sheet information.

EndsheetType [attribute]

EndsheetType is optional. A single instance might exist.

End sheet type

Refer to
EndsheetType
definition for any enumerations.

EndsheetLocationType [attribute]

EndsheetLocationType is optional. A single instance might exist.

End sheet location type

Refer to EndsheetLocationType definition for any enumerations.

(sequence)

The sequence of items below is mandatory. A single instance is required.

EndsheetCopyDescription

EndsheetCopyDescription is optional. A single instance might exist.

End sheet copy description

EndsheetMaterials

EndsheetMaterials is optional. A single instance might exist.

End sheet materials.

EndsheetReinforcementMaterials

EndsheetReinforcementMaterials is optional. A single instance might exist.

End sheet reinforcement materials

AdditionalText

AdditionalText is optional. Multiple instances might exist.

A text field that is used to communicate information not previously defined or for special instructions. To be used only for circumstances not covered by specific elements.

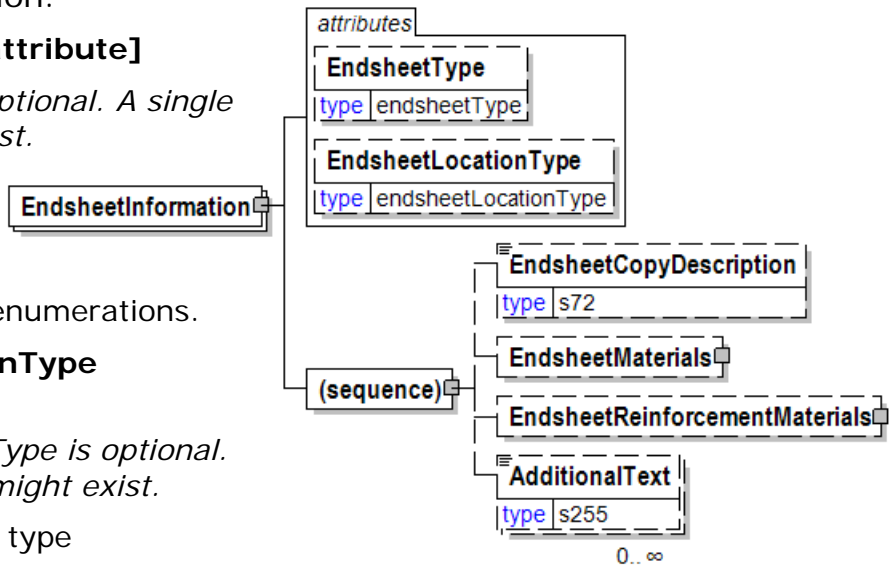

EndsheetLocationType [attribute]

End sheet location type

This item is restricted to the following list.

Front

End sheet is located only in the front of the ream

Back

End sheet is located only in the back of the ream



FrontAndBack

End sheet is located at both the front and the back of the ream

EndsheetMaterials

End sheet materials.

(sequence)

The sequence of items below is mandatory. A single instance is required.

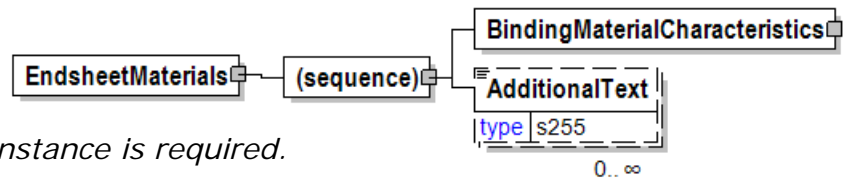

BindingMaterialCharacteristics

BindingMaterialCharacteristics is mandatory. A single instance is required.

Binding Material Characteristics

AdditionalText

AdditionalText is optional. Multiple instances might exist.

A text field that is used to communicate information not previously defined or for special instructions. To be used only for circumstances not covered by specific elements.

EndsheetReinforcementMaterials

End sheet reinforcement materials

EndsheetReinforcementType

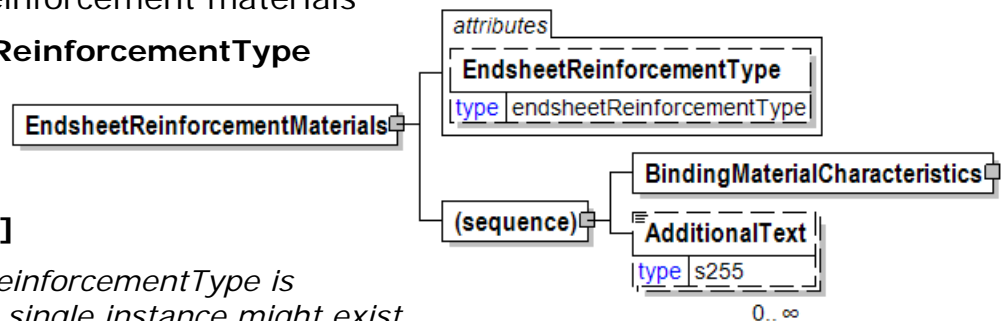

[attribute]

EndsheetReinforcementType is optional. A single instance might exist.

End sheet reinforcement type

Refer to EndsheetReinforcementType definition for any enumerations.

(sequence)

The sequence of items below is mandatory. A single instance is required.

BindingMaterialCharacteristics

BindingMaterialCharacteristics is mandatory. A single instance is required.

Binding Material Characteristics

AdditionalText

AdditionalText is optional. Multiple instances might exist.

A text field that is used to communicate information not previously defined or for special instructions. To be used only for circumstances not covered by specific elements.

EndsheetReinforcementType [attribute]

End sheet reinforcement type

This item is restricted to the following list.

Concealed

End sheet reinforcement is hidden

Exposed

End sheet reinforcement is visible



EndsheetType [attribute]

End sheet type

This item is restricted to the following list.

Blank

Printed

SelfEnding

UniformStateLabel

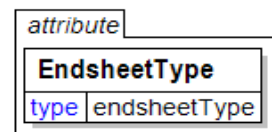

EndsLengthMax

Maximum length to be considered as ends.

(sequence)

The sequence of items below is mandatory. A single instance is required.

Value

Value is mandatory. A single instance is required.

A numeric value expressed in the unit of measure (UOM).

RangeMin

RangeMin is optional. A single instance might exist.

The minimum value (lower boundary) allowed for the Measurement that is the parent of this element.

RangeMax

RangeMax is optional. A single instance might exist.

The maximum value (upper boundary) allowed for the Measurement that is the parent of this element. Some elements use the RangeMax element with an extended list of unit of measures. (Note: the red colour in the picture is an artifact of how the graphic was captured and should be disregarded.)

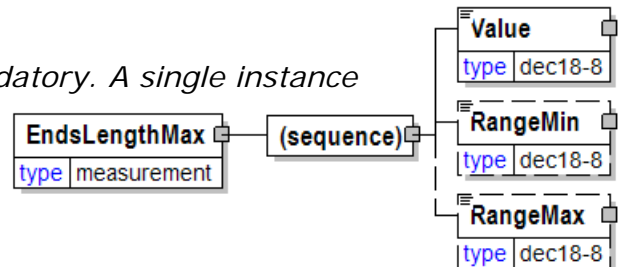

EndsPermittedPercent

The amount of the goods in percentage to be considered as ends.

(sequence)

The sequence of items below is mandatory. A single instance is required.

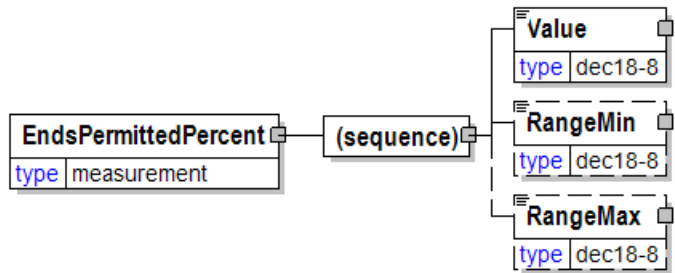

Value

Value is mandatory. A single instance is required.

A numeric value expressed in the unit of measure (UOM).

RangeMin

RangeMin is optional. A single instance might exist.

The minimum value (lower boundary) allowed for the Measurement that is the parent of this element.

RangeMax

RangeMax is optional. A single instance might exist.

The maximum value (upper boundary) allowed for the Measurement that is the parent of this element. Some elements use the RangeMax element with an extended list of unit of measures. (Note: the red colour in the picture is an artifact of how the graphic was captured and should be disregarded.)

EndUserParty

The party using, consuming, or converting the product. For example, a printer using paper reels for a print job for a publisher. The final ShipTo destination for a product is normally to the end user's facilities.

LogisticsRole [attribute]

LogisticsRole is optional. A single instance might exist.

Communicates the nature of the logistics role, if any, the party plays in the transaction.

Refer to LogisticsRole definition for any enumerations.

(sequence)

The sequence of items below is mandatory. A single instance is required.

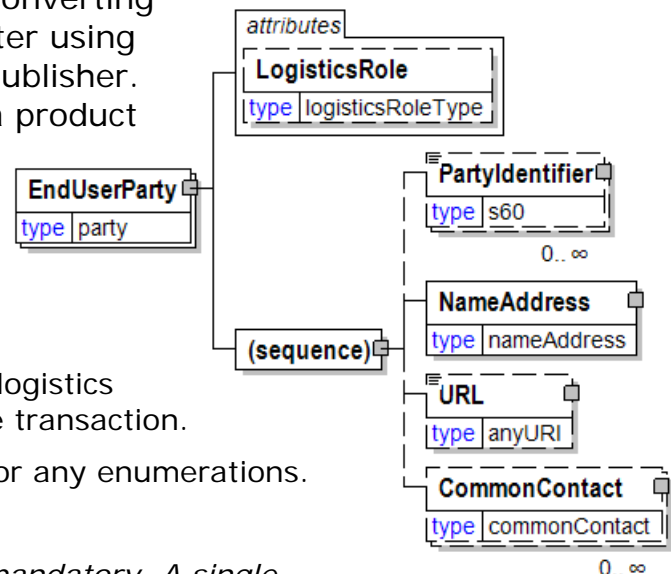

PartyIdentifier

PartyIdentifier is optional. Multiple instances might exist.

A unique identifier of a specific party. This element contains an attribute PartyIdentifierType that indicates the type of party.

NameAddress

papiNet V2R31

NameAddress is mandatory. A single instance is required.

A group item containing name and address of an organisation or business entity.

URL

URL is optional. A single instance might exist.

Universal Resource Locator. While typically a web address you could use this field to hold an email address.

CommonContact

CommonContact is optional. Multiple instances might exist.

Identifies a specific individual associated with the party.

EndUses

A text element used to express in human readable form a list of applicable end uses for a product.

Examples of end uses are:

Magazine

Book

Commercial print

etc

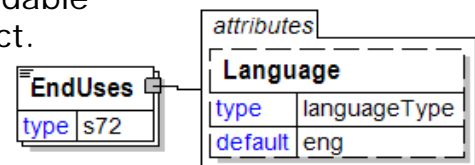

Language [attribute]

Language is optional. A single instance might exist.

XML has embraced 2 and 3 digit language codes through the application of an addendum to the standard.

Refer to Language definition for any enumerations.

Error

A group item that details the errors that are delaying processing on an original document.

(sequence)

The sequence of items below is mandatory. A single instance is required.

ErrorCode

ErrorCode is optional. A single instance might exist.

An optional code used to describe why an original document could not be processed

ErrorSeverity

ErrorSeverity is optional. A single instance might exist.

An optional indicator as to whether an error is business content related or whether it is technical in nature. Use of this item is governed by a Trading Partner agreement.

ErrorDescription

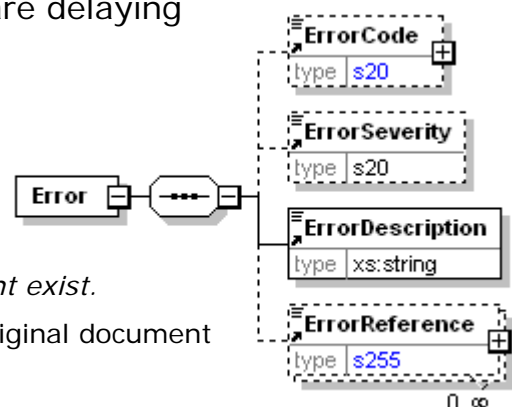

ErrorDescription is mandatory. A single instance is required.

A textual description of why an original document could not be processed

ErrorReference

ErrorReference is optional. Multiple instances might exist.

An item detailing relevant references (such as a PurchaseOrder Line Item) pertaining to the error. The type of reference is identified by the ErrorReferenceType attribute.

ErrorCode

An optional code used to describe why an original document could not be processed

Agency [attribute]

Agency is optional. A single instance might exist.

Describes the agency maintaining the list of codes. To be included in this list the agency must be a recognized standards body or industry organisation.

For the element that owns this attribute.

For another attribute in the list of attributes associated with the parent element.

Refer to Agency definition for any enumerations.

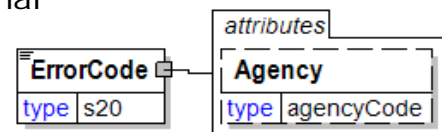

ErrorDescription

A textual description of why an original document could not be processed

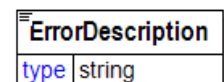

ErrorReference

An item detailing relevant references (such as a PurchaseOrder Line Item) pertaining to the error. The type of reference is identified by the ErrorReferenceType attribute.

ErrorReferenceType [attribute]

ErrorReferenceType is mandatory. A single instance is required.

Provides a contextual explanation of the specific reference identifier.

Refer to ErrorReferenceType for any enumerations.

AssignedBy [attribute]

AssignedBy is optional. A single instance might exist.

Identifies the type of party that has assigned the associated item, e.g. a reference of type OrderNumber.

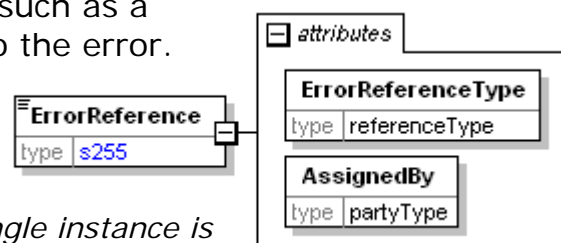

Refer to AssignedBy for any enumerations.

ErrorReferenceType [attribute]

Provides a contextual explanation of the specific reference identifier. Many items are currently prefixed by "Buyer", "Forwarder", "Manufacturer", "Mill", "Seller", "Supplier", "Warehouse", or "Vendor". Check for an existing non-prefixed version and use the non-prefixed version instead. In the (yet to be announced release date) version 3.0 the prefixed versions will be removed. Instead the attribute @AssignedBy will communicate the information previously communicated in the prefix.

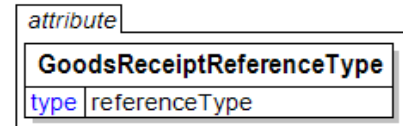

Refer to the [referenceType](#) entry for the list of enumerations and their definitions.

ErrorSeverity

An optional indicator as to whether an error is business content related or whether it is technical in nature. Use of this item is governed by a Trading Partner agreement.

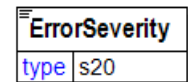

EstimatedArrivalDate

An estimation of the arrival date.

(sequence)

The sequence of items below is mandatory. A single instance is required.

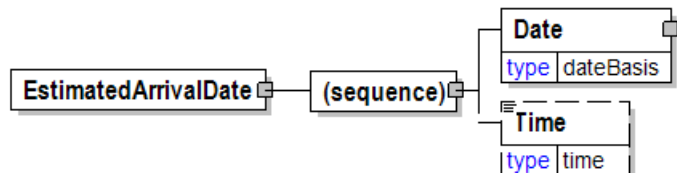

Date

Date is mandatory. A single instance is required.

A group element that contains the specification of Year, Month, and Day.

Time

Time is optional. A single instance might exist.

Times are treated in a standard XML fashion with a special case used to indicate a generalized "local" time. The standard XML approach to time is hh:mm:ss, hh:mm:ssZ, or hh:mm:ss±hh:mm.

hh:mm:ss±hh:mm is used to represent a time with a time zone. The time zone is communicated as the number of hours offset from the Universal Time Coordinate (UTC), a.k.a. Greenwich Mean Time.

hh:mm:ssZ indicates the time at Zulu (another name for UTC). Based on the convention described in the next bullet it will be important for users within UTC to use "Z" when communicating a time in their time zone to other users.

hh:mm:ss or hh:mm indicates in the XML standard the time at UTC however, within papiNet it is used to represent the applicable local time. Caution should be used when processing times of this nature as the papiNet approach may be

in discord with other users of XML.

EvenSpacing

The EvenSpacing element is used to communicate the hole-spacing that is equivalent between the holes. The initial spacing between the paper edge and the first hole is handled using the DistanceFromEdge element.

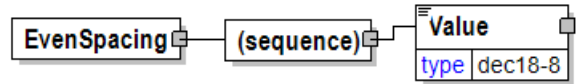

(sequence)

The sequence of items below is mandatory. A single instance is required.

Value

Value is mandatory. A single instance is required.

A numeric value expressed in the unit of measure (UOM).

EventDate

The date the incident or delay on press was recorded.

(sequence)

The sequence of items below is mandatory. A single instance is required.

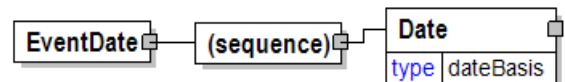

Date

Date is mandatory. A single instance is required.

A group element that contains the specification of Year, Month, and Day.

EventType [attribute]

The type of transportation event that the DeliveryLeg represents.

This item is restricted to the following list.

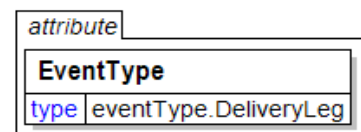

Historical

A historical transport.

Current

A current transport.

Future

A future transport.

Return

To be removed in a future version. Use instead attribute TransportContextType for Return transports.

ExchangeRate

The exchange rate as of the date included in the element.

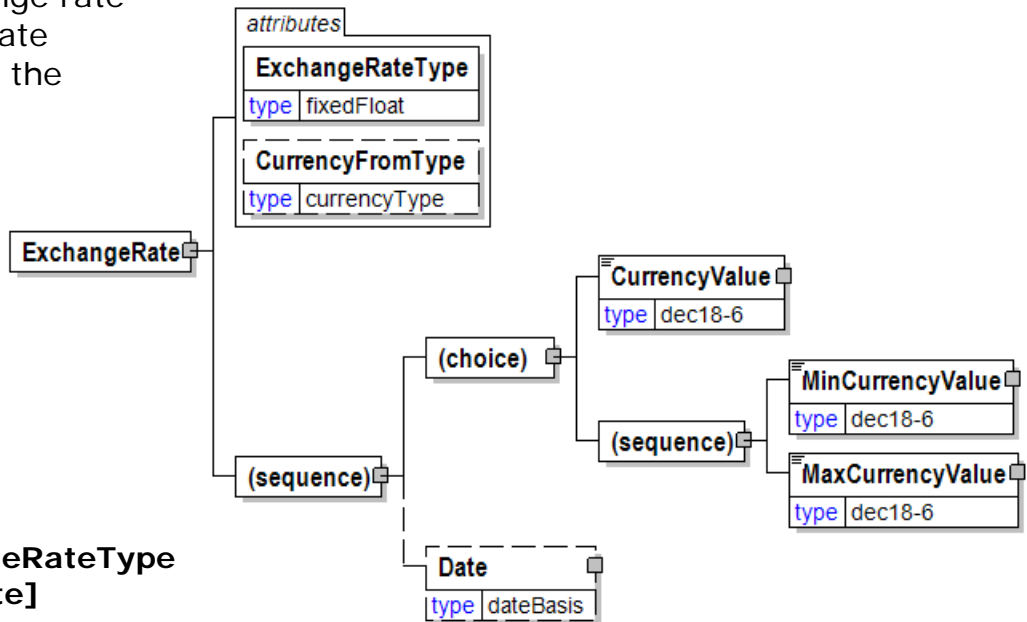

ExchangeRateType [attribute]

ExchangeRateType is mandatory. A single instance is required.

Defines the nature of the exchange rate

Refer to ExchangeRateType definition for any enumerations.

CurrencyFromType [attribute]

CurrencyFromType is optional. A single instance might exist.

The from currency in an exchange.

Refer to CurrencyFromType definition for any enumerations.

(sequence)

The sequence of items below is mandatory. A single instance is required.

(choice)

[choice] is optional because of choice construct.

CurrencyValue

CurrencyValue is optional because of choice construct.

The amount in the referenced currency as defined by the CurrencyType attribute.

(sequence)

The sequence of items below is mandatory. A single instance is required.

MinCurrencyValue

MinCurrencyValue is mandatory. A single instance is required.

The lower range of the allowed currency amount.

MaxCurrencyValue

MaxCurrencyValue is mandatory. A single instance is required.

The upper range of the allowed currency amount..

Date

papiNet V2R31

Date is optional. A single instance might exist.

A group element that contains the specification of Year, Month, and Day.

ExchangeRateType [attribute]

Defines the nature of the exchange rate

This item is restricted to the following list.

Fixed

A fixed exchange rate

Float

an exchange rate that floats and is locked in at a particular point in time.

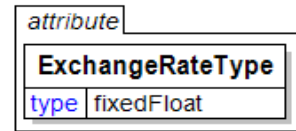

ExcitationPurity

Excitation purity

TestMethod [attribute]

TestMethod is optional. A single instance might exist.

The method used to determine the results of the test under consideration.

TestAgency [attribute]

TestAgency is optional. A single instance might exist.

The agency that has set the parameters for the testing

Refer to TestAgency definition for any enumerations.

SampleType [attribute]

SampleType is optional. A single instance might exist.

Communicates how sampling was done to measure the product characteristics.

Refer to SampleType definition for any enumerations.

ResultSource [attribute]

ResultSource is optional. A single instance might exist.

Used to define the data source of the specified test

Refer to ResultSource definition for any enumerations.

(sequence)

The sequence of items below is mandatory. A single instance is required.

DetailValue

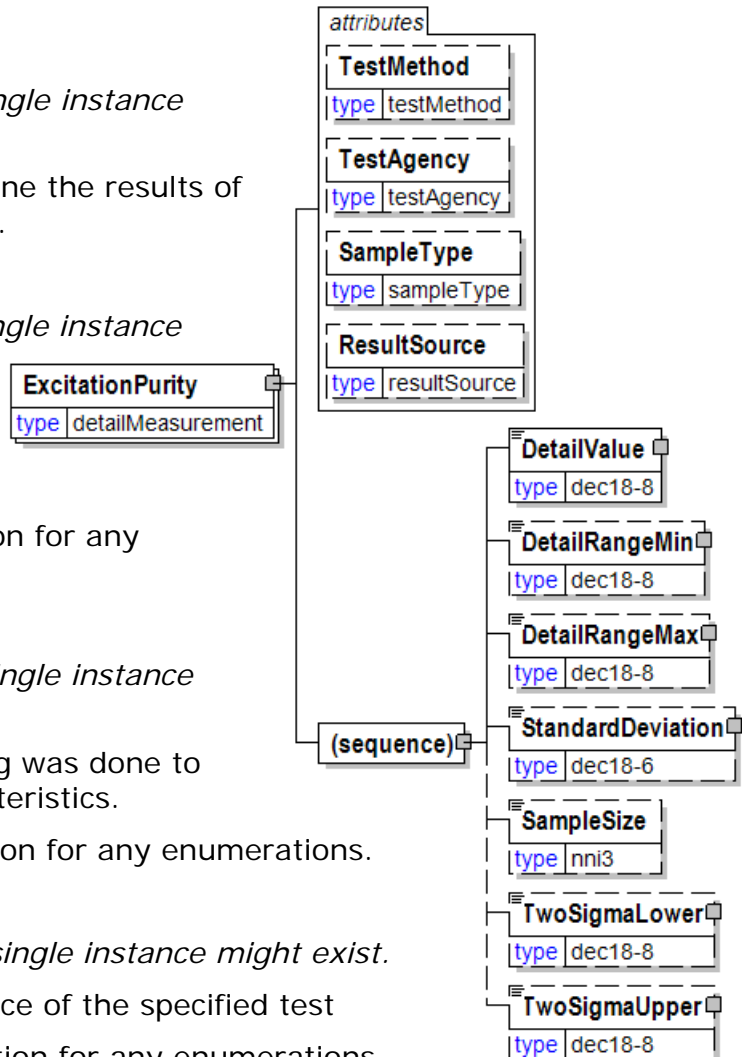

papiNet V2R31

DetailValue is mandatory. A single instance is required.

A numeric value expressed in the unit of measure (UOM).

DetailRangeMin

DetailRangeMin is optional. A single instance might exist.

The minimum value (lower boundary) allowed for the DetailValue that is the parent of this element.

DetailRangeMax

DetailRangeMax is optional. A single instance might exist.

The maximum value (upper boundary) allowed for the DetailValue that is the parent of this element.

StandardDeviation

StandardDeviation is optional. A single instance might exist.

A statistic used as a measure of dispersion in a distribution.

SampleSize

SampleSize is optional. A single instance might exist.

The number of samples used to determine the product characteristic in question.

TwoSigmaLower

TwoSigmaLower is optional. A single instance might exist.

Two sigma (a measure of dispersion associated with standard deviation) on the lower side of the standard deviation.

TwoSigmaUpper

TwoSigmaUpper is optional. A single instance might exist.

Two sigma (a measure of dispersion associated with standard deviation) on the upper side of the standard deviation.

ExLog

Describes the cutting pattern of the log.

(sequence)

The sequence of items below is mandatory. A single instance is required.

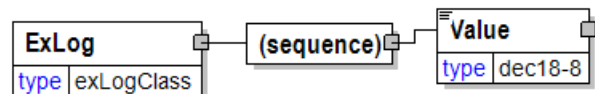

Value

Value is mandatory. A single instance is required.

A numeric value expressed in the unit of measure (UOM).

ExtraFeature

A special or extra feature that the label has or needs.

(sequence)

The sequence of items below is mandatory. A single instance is required.

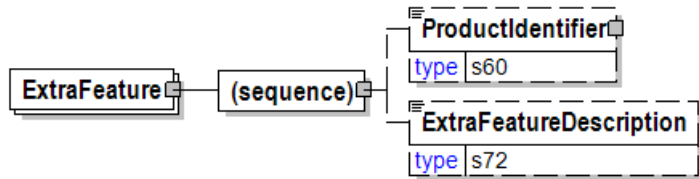

ProductIdentifier

ProductIdentifier is optional. A single instance might exist.

Used to communicate the code of the article, in a variety of formats designated by the type.

ExtraFeatureDescription

ExtraFeatureDescription is optional. A single instance might exist.

The definition of the extra feature.

ExtraFeatureDescription

The definition of the extra feature.

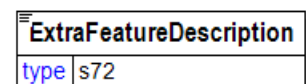

Face [attribute]

Used to describe which side (or face) of the product that the grade is applicable to.

This item is restricted to the following list.

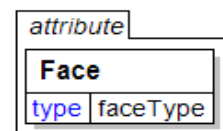

Face1

The grade is applicable to the top side of the product.

Face2

The grade is applicable to the bottom side of the product.

Both

The grade is applicable to both the top and the bottom side of the product.

Fax

The primary business fax number of the individual associated with the ContactName.

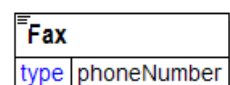

FibreClassification

A group item used to communicate fibre classification according to the specified classification scheme.

TestMethod [attribute]

TestMethod is optional. A single instance might exist.

The method used to determine the results of the test under consideration.

TestAgency [attribute]

TestAgency is optional. A single instance might exist.

The agency that has set the parameters for the testing

Refer to TestAgency definition for any enumerations.

SampleType [attribute]

SampleType is optional. A single instance might exist.

Communicates how sampling was done to measure the product characteristics.

Refer to SampleType definition for any enumerations.

ResultSource [attribute]

ResultSource is optional. A single instance might exist.

Used to define the data source of the specified test

Refer to ResultSource definition for any enumerations.

(sequence)

The sequence of items below is mandatory. A single instance is required.

DetailValue

DetailValue is mandatory. A single instance is required.

A numeric value expressed in the unit of measure (UOM).

DetailRangeMin

DetailRangeMin is optional. A single instance might exist.

The minimum value (lower boundary) allowed for the DetailValue that is the parent of this element.

DetailRangeMax

DetailRangeMax is optional. A single instance might exist.

The maximum value (upper boundary) allowed for the DetailValue that is the parent of this element.

StandardDeviation

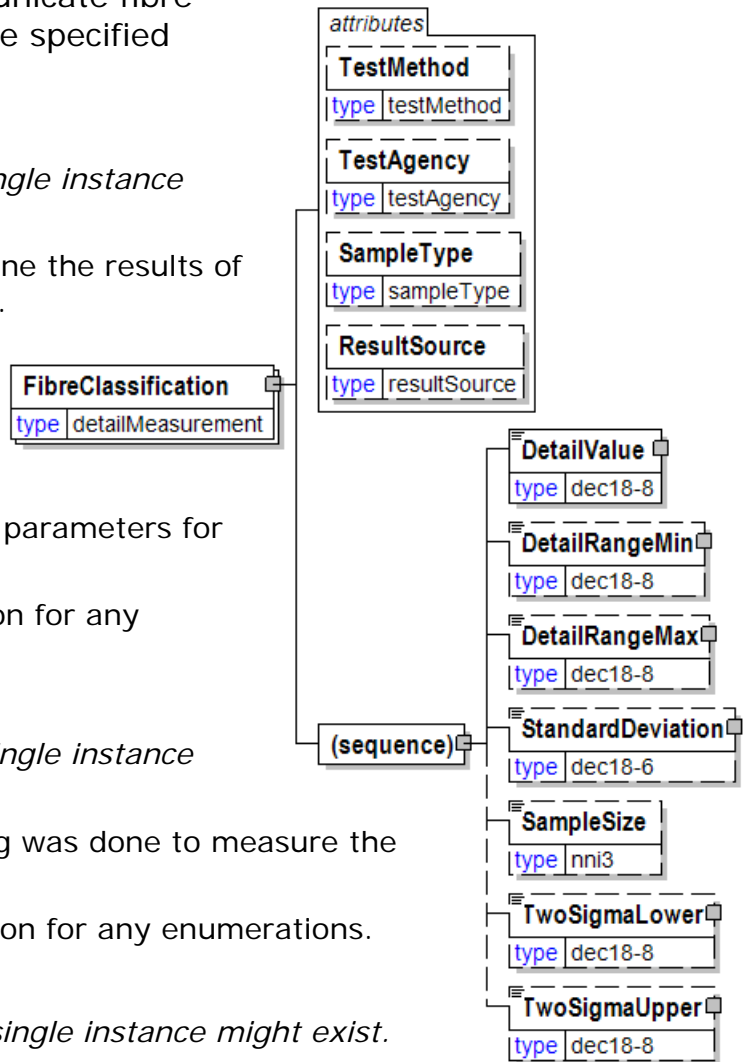

papiNet V2R31

StandardDeviation is optional. A single instance might exist.

A statistic used as a measure of dispersion in a distribution.

SampleSize

SampleSize is optional. A single instance might exist.

The number of samples used to determine the product characteristic in question.

TwoSigmaLower

TwoSigmaLower is optional. A single instance might exist.

Two sigma (a measure of dispersion associated with standard deviation) on the lower side of the standard deviation.

TwoSigmaUpper

TwoSigmaUpper is optional. A single instance might exist.

Two sigma (a measure of dispersion associated with standard deviation) on the upper side of the standard deviation.

FibreLength

A group item used to communicate fibre length target or test value according to a particular TestMethod.

TestMethod [attribute]

TestMethod is optional. A single instance might exist.

The method used to determine the results of the test under consideration.

TestAgency [attribute]

TestAgency is optional. A single instance might exist.

The agency that has set the parameters for the testing

Refer to TestAgency definition for any enumerations.

SampleType [attribute]

SampleType is optional. A single instance might exist.

Communicates how sampling was done to measure the product characteristics.

Refer to SampleType definition for any enumerations.

ResultSource [attribute]

ResultSource is optional. A single instance might exist.

Used to define the data source of the specified test

Refer to ResultSource definition for any enumerations.

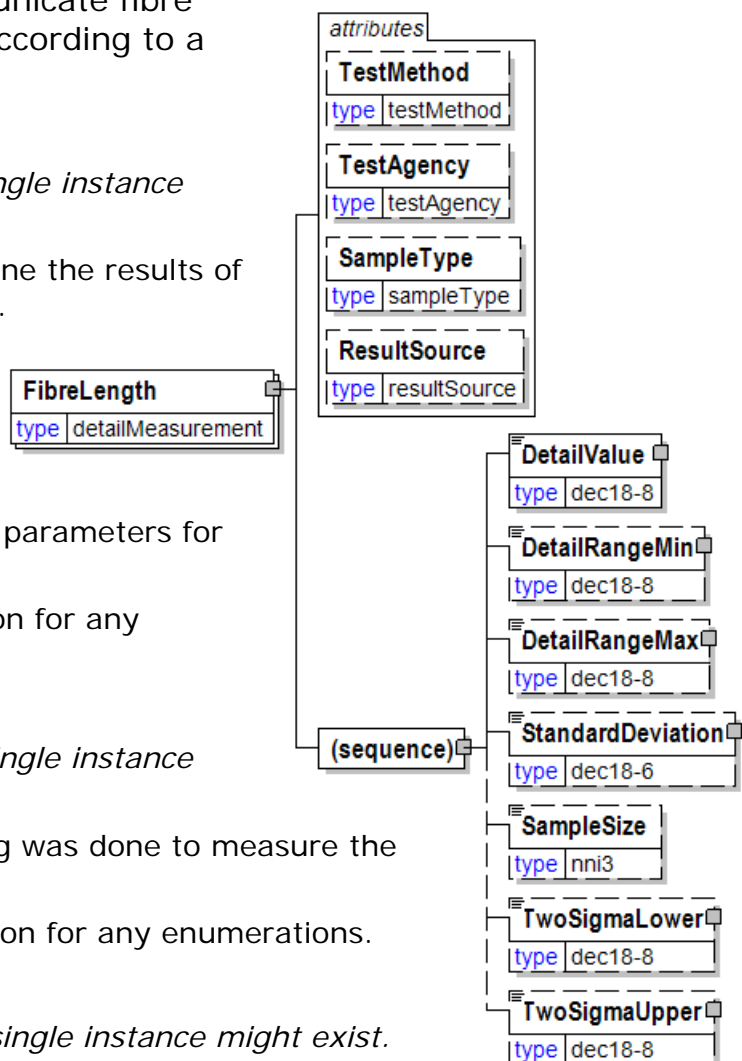

(sequence)

The sequence of items below is mandatory. A single instance is required.

DetailValue

DetailValue is mandatory. A single instance is required.

A numeric value expressed in the unit of measure (UOM).

DetailRangeMin

DetailRangeMin is optional. A single instance might exist.

The minimum value (lower boundary) allowed for the DetailValue that is the parent of this element.

DetailRangeMax

DetailRangeMax is optional. A single instance might exist.

The maximum value (upper boundary) allowed for the DetailValue that is the parent of this element.

StandardDeviation

StandardDeviation is optional. A single instance might exist.

A statistic used as a measure of dispersion in a distribution.

SampleSize

SampleSize is optional. A single instance might exist.

The number of samples used to determine the product characteristic in question.

TwoSigmaLower

TwoSigmaLower is optional. A single instance might exist.

Two sigma (a measure of dispersion associated with standard deviation) on the lower side of the standard deviation.

TwoSigmaUpper

TwoSigmaUpper is optional. A single instance might exist.

Two sigma (a measure of dispersion associated with standard deviation) on the upper side of the standard deviation.

FibreSource [attribute]

Communicates the source of the pulp fibre

This item is restricted to the following list.

Acacia

Ash

Aspen

Bagasse

Bamboo

Basswood

Beech

Birch

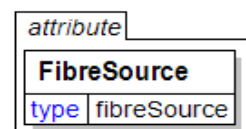

Blackgum
Buckeye
Butternut
Cedar
Cherry
Cottonwood
Cypress
DouglasFir
Elm
Esparto
Eucalyptus
Fir
Flax
Hemlock
Hemp
Hickory
Jute
Larch
Locust
Magnolia
Manilkara
Maple
MixedTropicalHardwood
NorthernMixedHardwood
Paulonia
Persea
Pine
Poplar
Radiata
Rag
RedOak
Redwood
Rope
SouthernMixedHardwood
SouthernSoftwood
Spruce
Sycamore

- Straw
- Tanoak
- Walnut
- WhiteOak
- Other

FinishedSize

Finished size

(sequence)

The sequence of items below is mandatory. A single instance is required.

Length

Length is optional. A single instance might exist.

The length of the object.

Width

Width is optional. A single instance might exist.

The width of the object.

Height

Height is optional. A single instance might exist.

The height of the object.

FlapWidth

FlapWidth is optional.

The width of a flap.

AdditionalText

AdditionalText is optional. Multiple instances might exist.

A text field that is used to communicate information not previously defined or for special instructions. To be used only for circumstances not covered by specific elements.

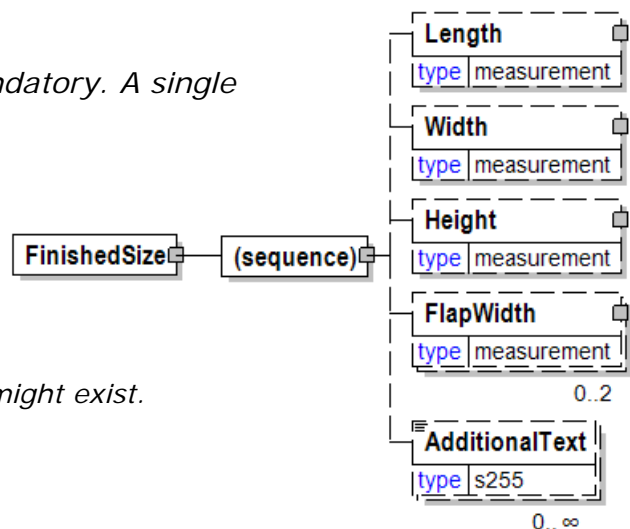

FinishPrep

Finish prep

FinishPrepOutputType [attribute]

FinishPrepOutputType is optional. A single instance might exist.

Finish Prep Output Type

Refer to FinishPrepOutputType definition for any enumerations.

(sequence)

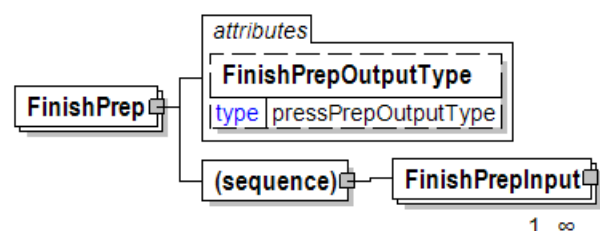

The sequence of items below is mandatory. A single instance is required.

FinishPrepInput

FinishPrepInput is mandatory. One instance is required, multiple instances might exist.

Finish prep input

FinishPrepInput

Finish prep input

MediaType [attribute]

MediaType is optional. A single instance might exist.

The type of media

Refer to MediaType definition for any enumerations.

(sequence)

The sequence of items below is mandatory. A single instance is required.

FinishPrepInputType

FinishPrepInputType is mandatory. A single instance is required.

Finish Prep Input Type

Refer to FinishPrepInputType definition for any enumerations.

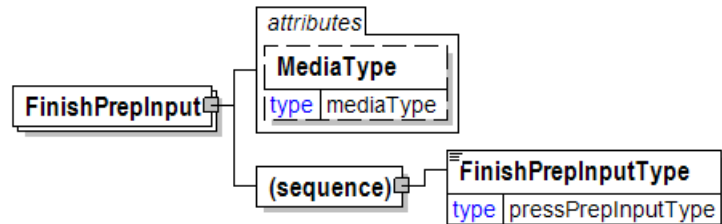

FinishPrepInputType

Finish Prep Input Type

This item is restricted to the following list.

4PageImposedFilm

8PageImposedFilm

ApplicationFiles

Bookmap

CameraCopy

CopyBook

DuplicateStrip

ElectronicFiles

ElectronicGraphic

Film

FilmPageNegatives

FilmPagePositives

IllustrationFilm

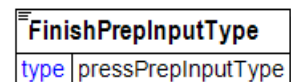

NegativeImposedPlateMakingFilm

Originals

OriginalArt

Other

Overtakes

PageProof

PDF

PositiveImposedPlateMakingFilm

RachwalFilm

ReflectiveArtBoard

ReproProof

RestripSuppliedFlats

TearSheet

Transparencies

FinishPrepOutputType [attribute]

Finish Prep Output Type

This item is restricted to the following list.

DirectToFilm

DirectToPlate

DirectToPress

Film

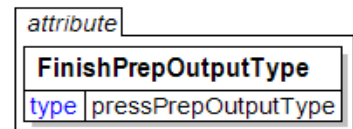

FinishSpecs

Finish specifications

(sequence)

The sequence of items below is mandatory. A single instance is required.

Coating

Coating is optional. Multiple instances might exist.

Coating

Refer to Coating definition for any enumerations.

DecorationSpecs

DecorationSpecs is optional. Multiple instances might exist.

Decoration specifications

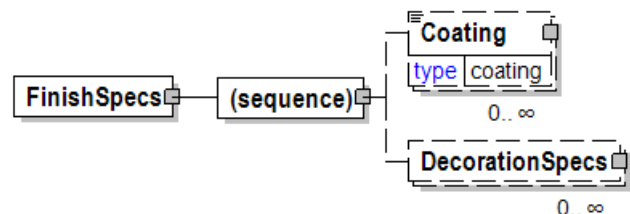

FinishType [attribute]

Defines the finish of a sheet of paper, which means the condition of its surface (refer to Embossing for more information).

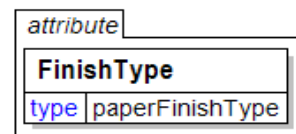

Finishes may be produced on or off machine. Finishes that are created off-machine are called embossed. (Embossing is a child element of ReelConversionCharacteristics and SheetConversionCharacteristics.)

Note:

Embossed" as a finish type is just a generalized choice for one of the more specific choices listed.

Unsupercalendered" as a finish type would be indicated by not communicating a finish type.

This item is restricted to the following list.

Bond

Grade of writing or printing paper where strength, durability, and permanence are essential requirements.

Clear

Finish process results in a clear coating.

CustomTint

Requires the manufacturer to add a color to the coating process in order to create a custom colored coating.

Dull

A paper surface finish lacking gloss and/or lustre; generally refers to an intermediate gloss of coated papers or to printed ink films.

English

A surface finish for book papers with a smoother, more uniform surface than machine finish.

Gloss

A paper surface finish that is highly reflective.

Hazy

Finish process results in a hazy coating.

HighGloss

Sheen on dry finish that is full gloss.

Laid

A paper surface finish that has a watermark pattern resulting in parallel lines in both the machine and cross machine directions of the web of paper.

Linen

An embossed finish to simulate the pattern originally obtained by pressing paper between sheets of linen cloths.

Machine

A paper surface that has no special finish—in other words, the paper is as it comes off the machine.

Matte

A non-glossy paper surface finish found on an uncoated sheet of paper or attained by coating without super calendering; this is the least glossy paper surface available.

Metalized

Finish process uses a custom metallic coating.

Satin

Paper surfaces finish lacking gloss, generally intermediate to a matte finish and a dull finish.

SCA

A super-calendered (SC) Grade A finish is the highest level of print gloss and smoothness of the super-calendered types.

SCB

A super-calendered (SC) Grade B finish with a mid level of print gloss and smoothness of the super-calendered types.

SCC

A super-calendered (SC) Grade C finish is the lowest level of print gloss and smoothness of the super-calendered types.

ScuffResistant

Wear-resistant finish to prevent scratching and marring.

Silk

A smooth, delicately embossed finished paper with sheen. Also called Satin.

Silver

Finish process uses a silver-color metallic coating.

Smooth

A paper surface finish mostly free of roughness.

SoftGloss

A paper surface finish similar to a matte but with a higher printed gloss; smoother than a matte finish.

TransparentBlue

Finish process adds the color blue to the clear coating material.

Vellum

A full toothy, relatively rough finish surface for uncoated text or book papers; generally intermediate in smoothness to an antique (very rough) finish and a regular or smooth finish.

Velvet

A smooth, delicately embossed finished paper with sheen. Similar to silk.

FireTreatment

Fire treatment

FireTreatmentType [attribute]

FireTreatmentType is optional. A single instance might exist.

Fire treatment type. Define the class (surface spread of flame) of fire treatment.

Refer to FireTreatmentType definition for any enumerations.

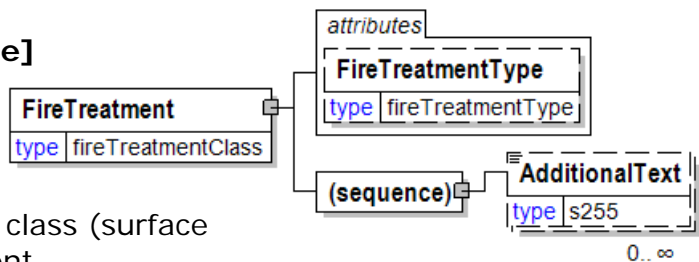

(sequence)

The sequence of items below is mandatory. A single instance is required.

AdditionalText

AdditionalText is optional. Multiple instances might exist.

A text field that is used to communicate information not previously defined or for special instructions. To be used only for circumstances not covered by specific elements.

FireTreatmentType [attribute]

Fire treatment type. Define the class (surface spread of flame) of fire treatment.

This item is restricted to the following list.

FireTreated

Other



FlapLocation [attribute]

Flap location

This item is restricted to the following list.

Back

Flap is located at the back

Front

Flap is located at the front

FrontAndBack

Flap is located at the back and at the front

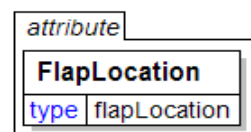

FlapWidth

The width of a flap.

FlapLocation [attribute]

FlapLocation is mandatory. A single instance is required.

Flap location

Refer to FlapLocation definition for any enumerations.

(sequence)

The sequence of items below is mandatory. A single instance is required.

Value

Value is mandatory. A single instance is required.

A numeric value expressed in the unit of measure (UOM).

RangeMin

RangeMin is optional. A single instance might exist.

The minimum value (lower boundary) allowed for the Measurement that is the parent of this element.

RangeMax

RangeMax is optional. A single instance might exist.

The maximum value (upper boundary) allowed for the Measurement that is the parent of this element. Some elements use the RangeMax element with an extended list of unit of measures. (Note: the red colour in the picture is an artifact of how the graphic was captured and should be disregarded.)

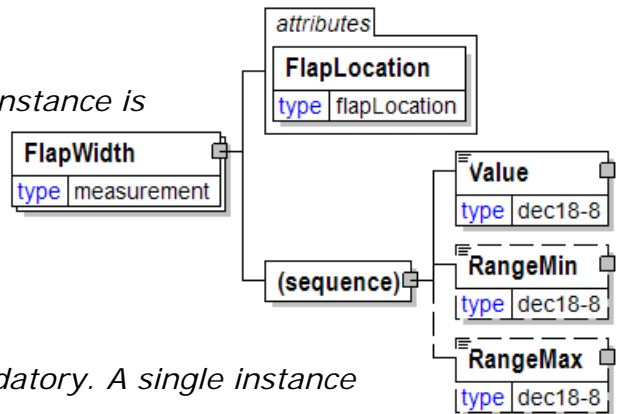

FlatAmountAdjustment

A group item that contains flat adjustment amount information.

(sequence)

The sequence of items below is mandatory. A single instance is required.

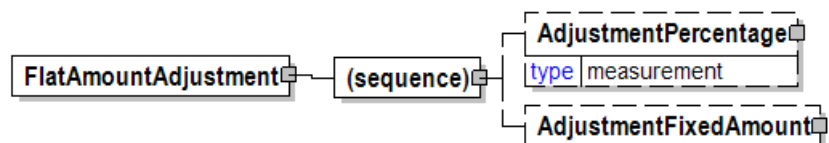

AdjustmentPercentage

AdjustmentPercentage is optional. A single instance might exist.

A percentage, either negative or positive, that is applied to either the price, or a starting amount to determine the value of the particular MonetaryAdjustment.

AdjustmentFixedAmount

AdjustmentFixedAmount is optional. A single instance might exist.

A fixed monetary amount, either negative or positive, that is the value of the adjustment being applied in an instance of the MonetaryAdjustment structure.

FlatSize

Flat size

(sequence)

The sequence of items below is mandatory. A single instance is required.

Length

Length is optional. A single instance might exist.

The length of the object.

Width

Width is optional. A single instance might exist.

The width of the object.

AdditionalText

AdditionalText is optional. Multiple instances might exist.

A text field that is used to communicate information not previously defined or for special instructions. To be used only for circumstances not covered by specific elements.

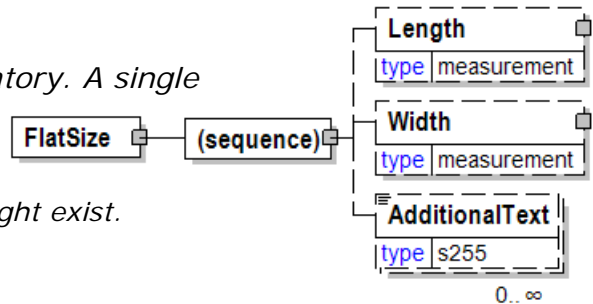

Floor

Defines parts and complete flooring systems.

(choice)

[choice] is optional because of choice construct.

FloorPanel

FloorPanel is optional because of choice construct.

Describes the flooring surface.

FloorPackage

FloorPackage is optional because of choice construct.

Describes the combination of flooring surface and supporting structures.

FloorTruss

FloorTruss is optional because of choice construct.

Describes the supporting material under flooring surface.

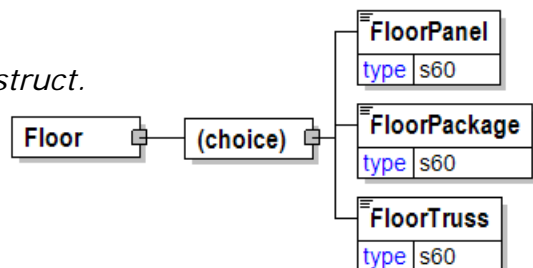

FloorLocationType [attribute]

Floor Location Type

This item is restricted to the following list.

Above

The floor is located above the product

Below

The floor is located below the product

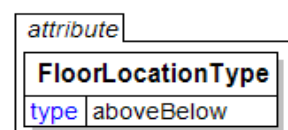

FloorPackage

Describes the combination of flooring surface and supporting structures.

FloorPackage	
type	s60

FloorPanel

Describes the flooring surface.

FloorPanel	
type	s60

FloorTruss

Describes the supporting material under flooring surface.

FloorTruss	
type	s60

Folded [attribute]

Either "Yes" or "No".

This item is restricted to the following list.

- Yes**
- No**

attribute	
Folded	
type	yesNo

Folding

A group item used to communicate folding endurance target or test value according to a particular TestMethod.

TestMethod [attribute]

TestMethod is optional. A single instance might exist.

The method used to determine the results of the test under consideration.

TestAgency [attribute]

TestAgency is optional. A single instance might exist.

The agency that has set the parameters for the testing

Refer to TestAgency definition for any enumerations.

SampleType [attribute]

SampleType is optional. A single instance might exist.

Communicates how sampling was done to measure the product characteristics.

Refer to SampleType definition for any enumerations.

ResultSource [attribute]

ResultSource is optional. A single instance might exist.

Used to define the data source of the specified test

Refer to ResultSource definition for any enumerations.

(sequence)

The sequence of items below is mandatory. A single instance is required.

DetailValue

DetailValue is mandatory. A single instance is required.

A numeric value expressed in the unit of measure (UOM).

DetailRangeMin

DetailRangeMin is optional. A single instance might exist.

The minimum value (lower boundary) allowed for the DetailValue that is the parent of this element.

DetailRangeMax

DetailRangeMax is optional. A single instance might exist.

The maximum value (upper boundary) allowed for the DetailValue that is the parent of this element.

StandardDeviation

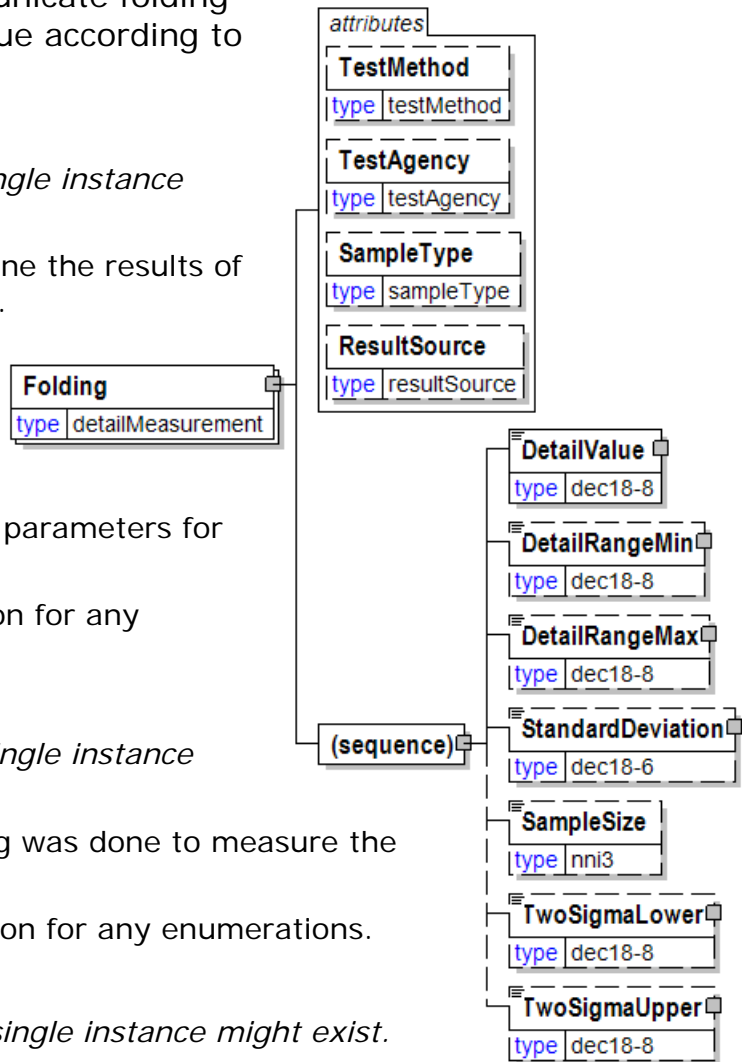

StandardDeviation is optional. A single instance might exist.

A statistic used as a measure of dispersion in a distribution.

SampleSize

SampleSize is optional. A single instance might exist.

The number of samples used to determine the product characteristic in question.

TwoSigmaLower

TwoSigmaLower is optional. A single instance might exist.

Two sigma (a measure of dispersion associated with standard deviation) on the lower side of the standard deviation.

TwoSigmaUpper

TwoSigmaUpper is optional. A single instance might exist.

Two sigma (a measure of dispersion associated with standard deviation) on the upper side of the standard deviation.

Foot

Foot

Bleed [attribute]

Bleed is optional. A single instance might exist.

Specifies if the printing of an illustration, design, or text to the edge of the page.

Refer to Bleed definition for any enumerations.

(sequence)

The sequence of items below is mandatory. A single instance is required.

Value

Value is mandatory. A single instance is required.

A numeric value expressed in the unit of measure (UOM).

RangeMin

RangeMin is optional. A single instance might exist.

The minimum value (lower boundary) allowed for the Measurement that is the parent of this element.

RangeMax

RangeMax is optional. A single instance might exist.

The maximum value (upper boundary) allowed for the Measurement that is the parent of this element. Some elements use the RangeMax element with an extended list of unit of measures. (Note: the red colour in the picture is an artifact of how the graphic was captured and should be disregarded.)

AdditionalText

AdditionalText is optional. A single instance might exist.

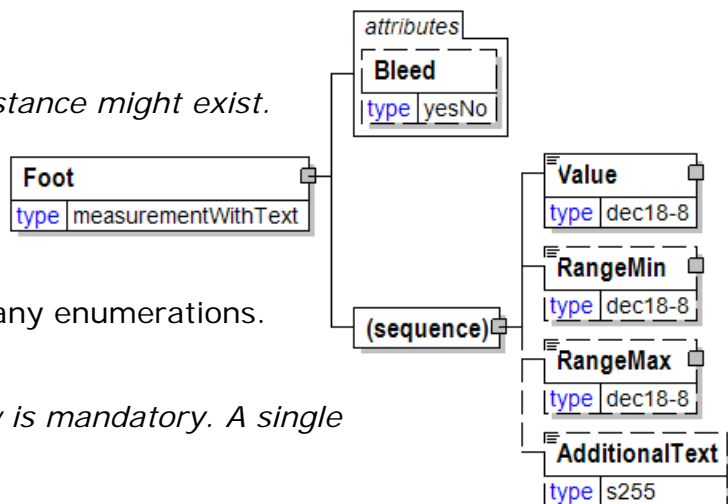

A text field that is used to communicate information not previously defined or for special instructions. To be used only for circumstances not covered by specific elements.

ForestWood

A grouping element with information about characteristics for Forest Wood products.

ForestWoodType [attribute]

ForestWoodType is mandatory. A single instance is required.

Defines the type of product for Forest Wood.

Refer to ForestWoodType definition for any enumerations.

ForestWoodItemType [attribute]

ForestWoodItemType is mandatory. A single instance is required.

Defines detail type of items for Forest Wood product types.

Refer to ForestWoodItemType definition for any enumerations.

(sequence)

The sequence of items below is mandatory. A single instance is required.

TreeSpeciesGroup

TreeSpeciesGroup is optional. A single instance might exist.

A grouping element that details information used for describing tree species.

ForestWoodClass

ForestWoodClass is optional. Three instances might exist.

A grouping element that details information used for describing classes of Forest Wood based on some product properties.

ForestWoodCharacteristics

ForestWoodCharacteristics is optional. A single instance might exist.

A grouping element that contains characteristics of the Forest Wood product.

ForestWoodPackagingCharacteristics

ForestWoodPackagingCharacteristics is optional. A single instance might exist.

A grouping element that contains information about packaging of the Forest Wood product.

ForestWoodProcessingCharacteristics

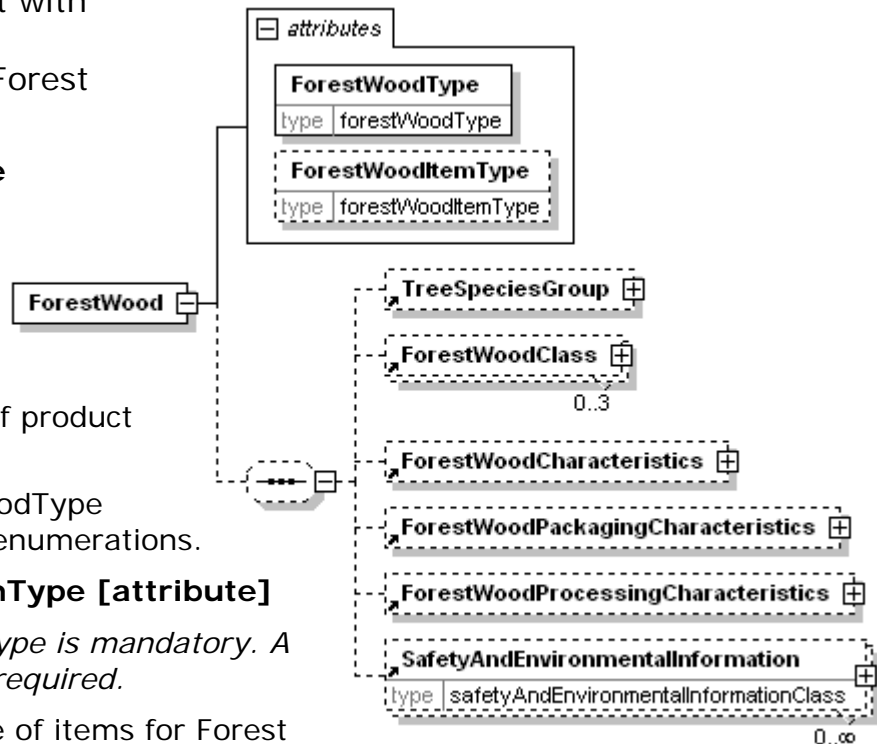

ForestWoodProcessingCharacteristics is optional. A single instance might exist.

A grouping element that contains information about processing of the Forest Wood product.

SafetyAndEnvironmentalInformation

SafetyAndEnvironmentalInformation is optional. Multiple instances might exist.

Name of certification type, if any, on the goods (For example, FSC, PEFC). SafetyAndEnvironmental needs a value or measurement to communicate the percentage of the product is certified (for example, 75% is certified by the indicated agency).

ForestWoodCharacteristics

A grouping element that contains characteristics of the Forest Wood product.

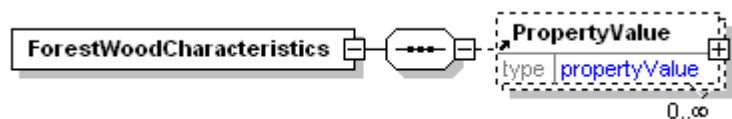

(sequence)

The sequence of items below is mandatory. A single instance is required.

PropertyValue

PropertyValue is optional. Multiple instances might exist.

Specifies a value for a property of an item. The property is defined by the attribute PropertyType. The attribute MeasuringMethod and AssignedBy can be used to clarified details for a how a property is measured or calculated, e.g. Diameter for a saw log can be measured "Under Bark" or "Over Bark". The attribute MeasuringMethodType defines how the value is created, e.g. measured automatically, calculated etc. The attribute IsAverageValue Indicates if the value is an average value or not.

ForestWoodClass

A grouping element that details information used for describing classes of Forest Wood based on some product properties.

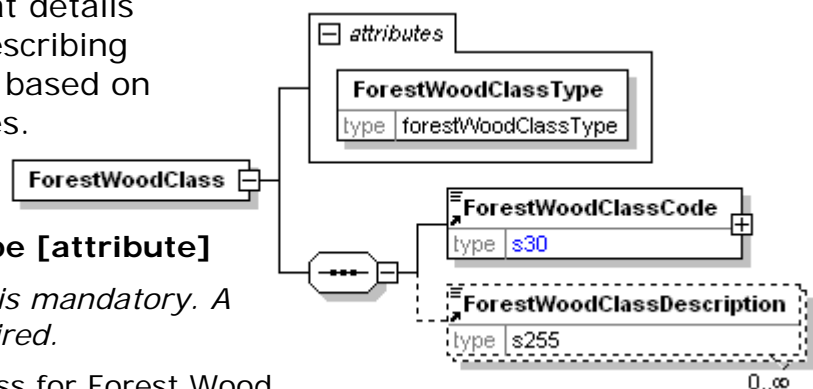

ForestWoodClassType [attribute]

ForestWoodClassType is mandatory. A single instance is required.

Defines the type of class for Forest Wood.

Refer to ForestWoodClassType definition for any enumerations.

(sequence)

The sequence of items below is mandatory. A single instance is required.

ForestWoodClassCode

ForestWoodClassCode is mandatory. A single instance is required.

A code defining the class of Forest Wood.

ForestWoodClassDescription

ForestWoodClassDescription is optional. Multiple instances might exist.

A text description of the class for Forest Wood.

ForestWoodClassCode

A code defining the class of Forest Wood.

Agency [attribute]

Agency is mandatory. A single instance is required.

Describes the agency maintaining the list of codes. To be included in this list the agency must be a recognized standards body or industry organisation.

For the element that owns this attribute.

For another attribute in the list of attributes associated with the parent element.

Refer to Agency definition for any enumerations.

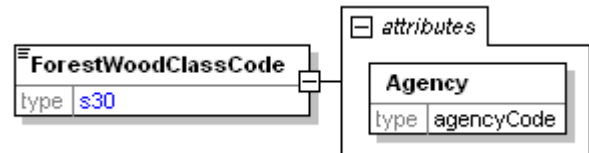

ForestWoodClassDescription

A text description of the class for Forest Wood.

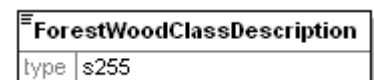

ForestWoodClassType [attribute]

Defines the type of class for Forest Wood.

This item is restricted to the following list.

DiameterClass

The class is based on the diameter of items.

LengthClass

The class is based on the length of items.

QualityClass

The class is based on the quality of items.

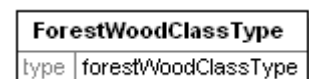

ForestWoodItemType [attribute]

Defines detail type of items for Forest Wood product types.

This item is restricted to the following list.

LongLog

A cut portion of a stem that is classified as being long.



ShortLog

A cut portion of a stem that is classified as being short.

Stem

A felled tree crosscut at the top with all branches removed.

ForestWoodPackagingCharacteristics

A grouping element that

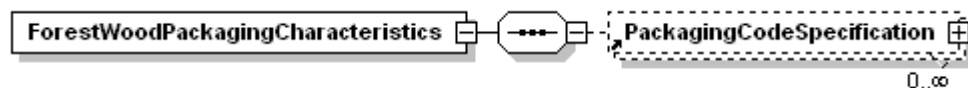

contains information about packaging of the Forest Wood product.

(sequence)

The sequence of items below is mandatory. A single instance is required.

PackagingCodeSpecification

PackagingCodeSpecification is optional. Multiple instances might exist.

A grouping element specifying code and description for packaging details.

ForestWoodProcessingCharacteristics

A grouping element that

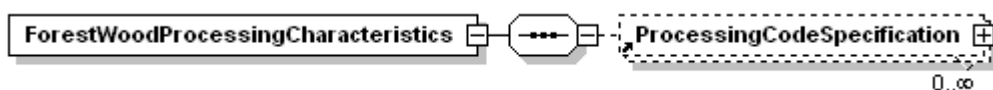

contains information about processing of the Forest Wood product.

(sequence)

The sequence of items below is mandatory. A single instance is required.

ProcessingCodeSpecification

ProcessingCodeSpecification is optional. Multiple instances might exist.

A grouping element specifying code and description for processing details.

ForestWoodType [attribute]

Defines the type of product for Forest Wood..

This item is restricted to the following list.



Bark

Outer covering of the stem and branches of trees (tree bark). Bark from industrially processed logs or trees.

BioEnergyChips

Wood-based chips for bioenergy.

BioEnergySmallTree

Small-sized trees which have not been processed, usually used for energy purposes.

BoardWood

Boards and side cuts used for industrial processes or bioenergy.

Firewood

Firewood produced for heating.

IndustrialChips

Chips coming as by-product from industrial manufacturing processes, usually used for pulp or paper making.

IndustrialReject

Wood rejects from manufacturing processes. It is used as raw material in other industrial processes or for bioenergy.

LoggingResidue

Woody biomass residues which are created during timber harvesting. They include tree tops and branches. More information can be found in standard CEN/TS 14588:2003.

OtherWoodEnergy

Other wood based energy products.

Pellets

Pellets produced for heating.

RecycledWood

Recycled or waste wood, usually used for energy purposes.

Roundwood

Felled trees crosscut at the top, with all branches removed, that may or may not have been further crosscut.

Examples of Roundwood products are saw logs, pulpwood logs, tree length logs, stems, poles and other similar products that have been harvested in the forest but not processed industrially.

Sawdust

Sawdust from industrial manufacturing processes.

Stump

Portion of the tree that remains above and below ground after felling of the tree.

Tree

Tree that has not been delimbed and not cut into logs.

Formation

A group item used to communicate sheet formation target or test value according to a particular TestMethod.

TestMethod [attribute]

TestMethod is optional. A single instance might exist.

The method used to determine the results of the test under consideration.

TestAgency [attribute]

TestAgency is optional. A single instance might exist.

The agency that has set the parameters for the testing

Refer to TestAgency definition for any enumerations.

SampleType [attribute]

SampleType is optional. A single instance might exist.

Communicates how sampling was done to measure the product characteristics.

Refer to SampleType definition for any enumerations.

ResultSource [attribute]

ResultSource is optional. A single instance might exist.

Used to define the data source of the specified test

Refer to ResultSource definition for any enumerations.

(sequence)

The sequence of items below is mandatory. A single instance is required.

DetailValue

DetailValue is mandatory. A single instance is required.

A numeric value expressed in the unit of measure (UOM).

DetailRangeMin

DetailRangeMin is optional. A single instance might exist.

The minimum value (lower boundary) allowed for the DetailValue that is the parent of this element.

DetailRangeMax

DetailRangeMax is optional. A single instance might exist.

The maximum value (upper boundary) allowed for the DetailValue that is the parent of this element.

StandardDeviation

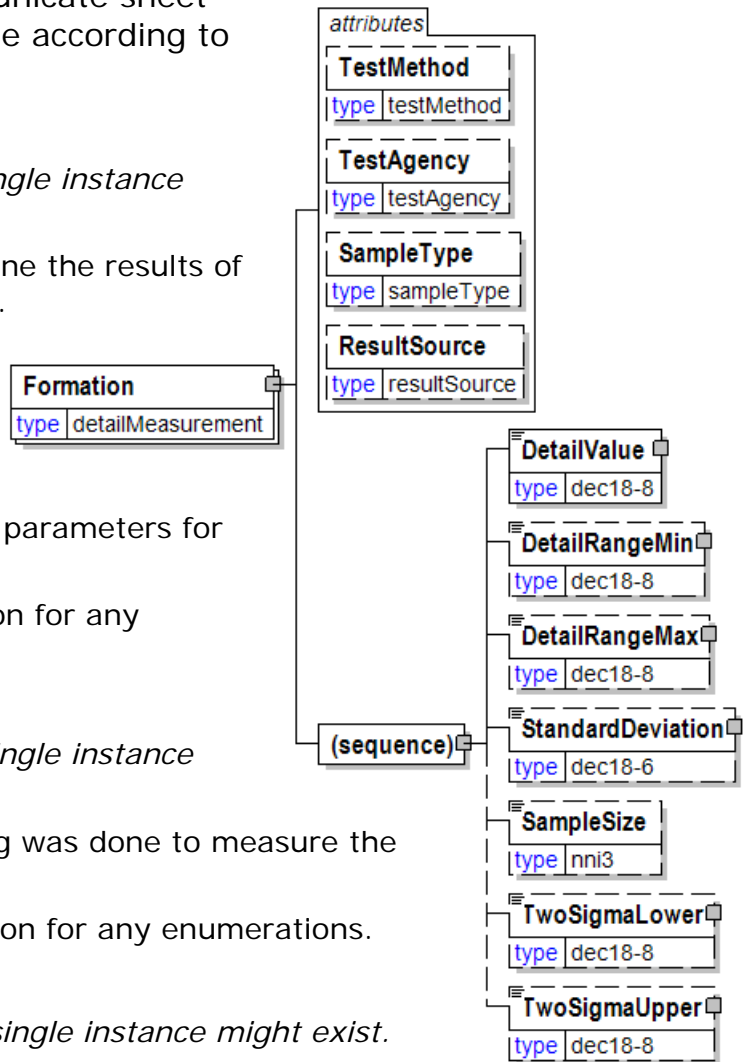

StandardDeviation is optional. A single instance might exist.

A statistic used as a measure of dispersion in a distribution.

SampleSize

SampleSize is optional. A single instance might exist.

The number of samples used to determine the product characteristic in question.

TwoSigmaLower

TwoSigmaLower is optional. A single instance might exist.

Two sigma (a measure of dispersion associated with standard deviation) on the lower side of the standard deviation.

TwoSigmaUpper

TwoSigmaUpper is optional. A single instance might exist.

Two sigma (a measure of dispersion associated with standard deviation) on the upper side of the standard deviation.

ForwarderParty

The trading partner involved in the forwarding of the shipment.

LogisticsRole [attribute]

LogisticsRole is optional. A single instance might exist.

Communicates the nature of the logistics role, if any, the party plays in the transaction.

Refer to LogisticsRole definition for any enumerations.

(sequence)

The sequence of items below is mandatory. A single instance is required.

PartyIdentifier

PartyIdentifier is optional. Multiple instances might exist.

A unique identifier of a specific party. This element contains an attribute PartyIdentifierType that indicates the type of party.

NameAddress

NameAddress is mandatory. A single instance is required.

A group item containing name and address of an organisation or business entity.

URL

URL is optional. A single instance might exist.

Universal Resource Locator. While typically a web address you could use this field to hold an email address.

CommonContact

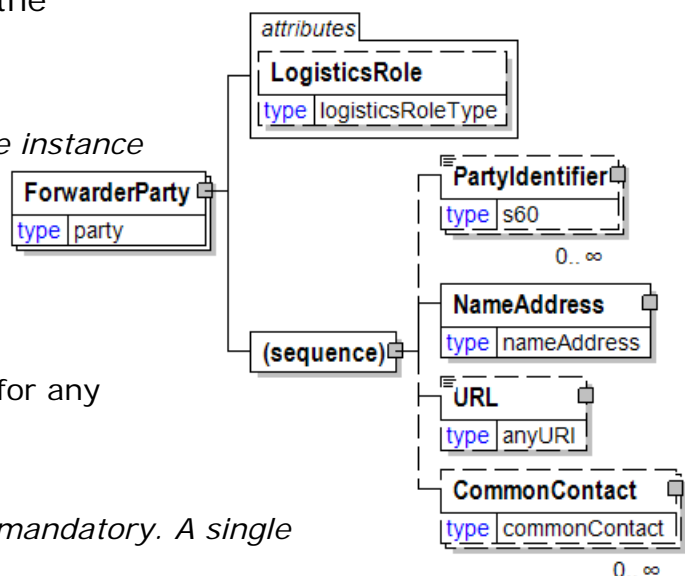

CommonContact is optional. Multiple instances might exist.

Identifies a specific individual associated with the party.

FountainSolutionConductivity

Electrical measure of fountain solution measured in micro – siemens.

(sequence)

The sequence of items below is mandatory. A single instance is required.

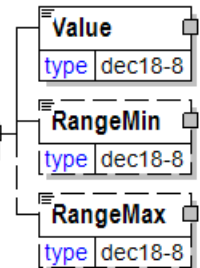
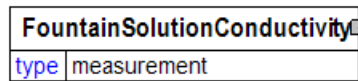

Value

Value is mandatory. A single instance is required.

A numeric value expressed in the unit of measure (UOM).

RangeMin

RangeMin is optional. A single instance might exist.

The minimum value (lower boundary) allowed for the Measurement that is the parent of this element.

RangeMax

RangeMax is optional. A single instance might exist.

The maximum value (upper boundary) allowed for the Measurement that is the parent of this element. Some elements use the RangeMax element with an extended list of unit of measures. (Note: the red colour in the picture is an artifact of how the graphic was captured and should be disregarded.)

FountainSolutionpH

Measurement of the acidic properties of the fountain solution.

(sequence)

The sequence of items below is mandatory. A single instance is required.

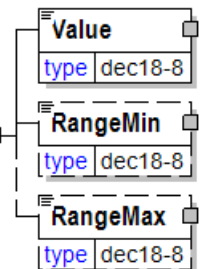
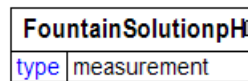

Value

Value is mandatory. A single instance is required.

A numeric value expressed in the unit of measure (UOM).

RangeMin

RangeMin is optional. A single instance might exist.

The minimum value (lower boundary) allowed for the Measurement that is the parent of this element.

RangeMax

RangeMax is optional. A single instance might exist.

The maximum value (upper boundary) allowed for the Measurement that is the parent of this element. Some elements use the RangeMax element with an extended list of unit of measures. (Note: the red colour in the picture is an artifact of how the graphic was captured and should be disregarded.)

Freeness

Freeness

TestMethod [attribute]

TestMethod is optional. A single instance might exist.

The method used to determine the results of the test under consideration.

TestAgency [attribute]

TestAgency is optional. A single instance might exist.

The agency that has set the parameters for the testing

Refer to TestAgency definition for any enumerations.

SampleType [attribute]

SampleType is optional. A single instance might exist.

Communicates how sampling was done to measure the product characteristics.

Refer to SampleType definition for any enumerations.

ResultSource [attribute]

ResultSource is optional. A single instance might exist.

Used to define the data source of the specified test

Refer to ResultSource definition for any enumerations.

(sequence)

The sequence of items below is mandatory. A single instance is required.

DetailValue

DetailValue is mandatory. A single instance is required.

A numeric value expressed in the unit of measure (UOM).

DetailRangeMin

DetailRangeMin is optional. A single instance might exist.

The minimum value (lower boundary) allowed for the DetailValue that is the parent of this element.

DetailRangeMax

DetailRangeMax is optional. A single instance might exist.

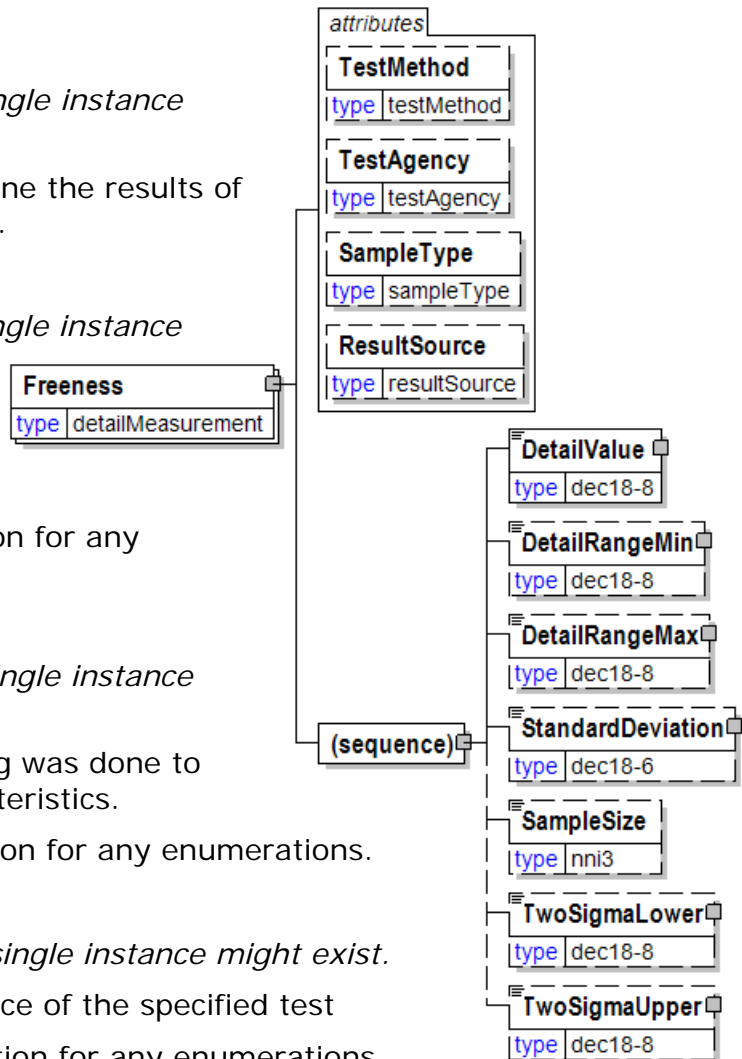

papiNet V2R31

The maximum value (upper boundary) allowed for the DetailValue that is the parent of this element.

StandardDeviation

StandardDeviation is optional. A single instance might exist.

A statistic used as a measure of dispersion in a distribution.

SampleSize

SampleSize is optional. A single instance might exist.

The number of samples used to determine the product characteristic in question.

TwoSigmaLower

TwoSigmaLower is optional. A single instance might exist.

Two sigma (a measure of dispersion associated with standard deviation) on the lower side of the standard deviation.

TwoSigmaUpper

TwoSigmaUpper is optional. A single instance might exist.

Two sigma (a measure of dispersion associated with standard deviation) on the upper side of the standard deviation.

FreightPayableAt

The location at which freight charges are calculated.

FreightPayableAt	
type	s40

Friction

A group item used to communicate static and kinetic friction target or test value according to a particular TestMethod.

TestMethod [attribute]

TestMethod is optional. A single instance might exist.

The method used to determine the results of the test under consideration.

TestAgency [attribute]

TestAgency is optional. A single instance might exist.

The agency that has set the parameters for the testing

Refer to TestAgency definition for any enumerations.

SampleType [attribute]

SampleType is optional. A single instance might exist.

Communicates how sampling was done to measure the product characteristics.

Refer to SampleType definition for any enumerations.

ResultSource [attribute]

ResultSource is optional. A single instance might exist.

Used to define the data source of the specified test

Refer to ResultSource definition for any enumerations.

(sequence)

The sequence of items below is mandatory. A single instance is required.

DetailValue

DetailValue is mandatory. A single instance is required.

A numeric value expressed in the unit of measure (UOM).

DetailRangeMin

DetailRangeMin is optional. A single instance might exist.

The minimum value (lower boundary) allowed for the DetailValue that is the parent of this element.

DetailRangeMax

DetailRangeMax is optional. A single instance might exist.

The maximum value (upper boundary) allowed for the DetailValue that is the parent of this element.

StandardDeviation

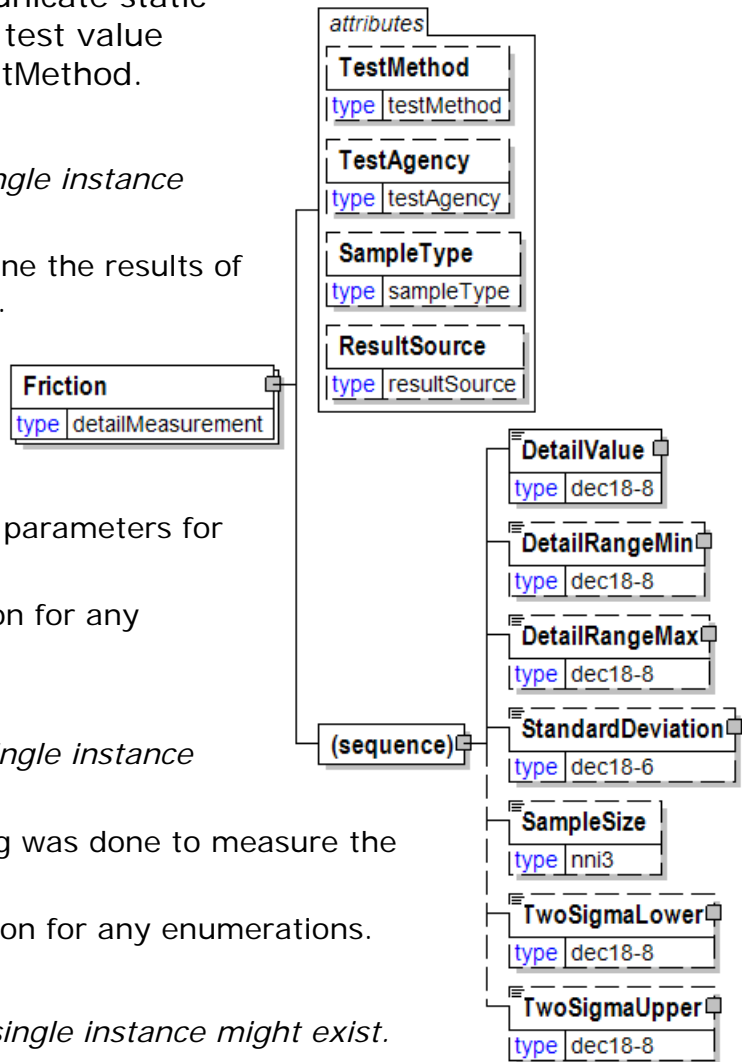

papiNet V2R31

StandardDeviation is optional. A single instance might exist.

A statistic used as a measure of dispersion in a distribution.

SampleSize

SampleSize is optional. A single instance might exist.

The number of samples used to determine the product characteristic in question.

TwoSigmaLower

TwoSigmaLower is optional. A single instance might exist.

Two sigma (a measure of dispersion associated with standard deviation) on the lower side of the standard deviation.

TwoSigmaUpper

TwoSigmaUpper is optional. A single instance might exist.

Two sigma (a measure of dispersion associated with standard deviation) on the upper side of the standard deviation.

From

The beginning point of a timeperiod.

From
type time

FromProduct

Defines from which product the item is downgraded.

(sequence)

The sequence of items below is mandatory. A single instance is required.

(sequence)

The sequence of items below is mandatory. One instance is required, multiple instances might exist.



ProductIdentifier

ProductIdentifier is mandatory. A single instance is required.

Used to communicate the code of the article, in a variety of formats designated by the type.

ProductDescription

ProductDescription is optional. Multiple instances might exist.

An element used to communicate a human readable description of the product in the language specified by the Language attribute.

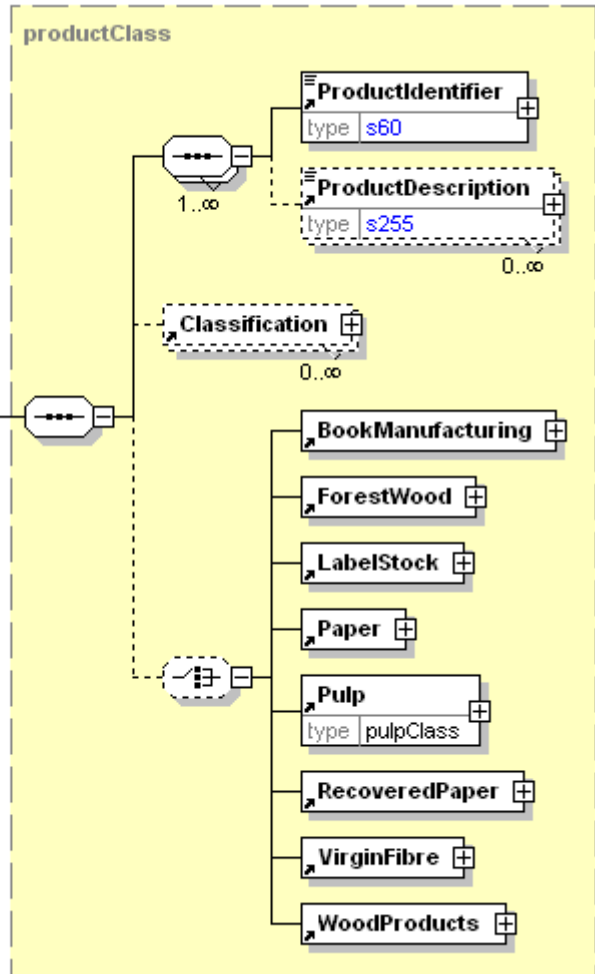

Classification

Classification is optional. Multiple instances might exist.

A group item that details the product classification according to a particular organization's scheme. An item across multiple classifications would still be recognized as the same item. Examples of some product classifications are: Containerboard, Pulp-Dissolving, or Newsprint.

(choice)

[choice] is optional because of choice construct.

BookManufacturing

BookManufacturing is optional because of choice construct.

BookManufacturing is a group element that contains the elements that describe the book manufacturing process.

ForestWood

ForestWood is optional because of choice construct.

A grouping element with information about characteristics for Forest Wood products.

LabelStock

LabelStock is optional because of choice construct.

papiNet V2R31

LabelStock contains the attributes and characteristics that define the label stock product.

Paper

Paper is optional because of choice construct.

A group item defining the characteristics of the paper product.

Pulp

Pulp is optional because of choice construct.

A group item defining the characteristics of pulp that are not dependent on a particular conversion process.

RecoveredPaper

RecoveredPaper is optional because of choice construct.

A group item defining the characteristics of recycled fibre that are not dependent on a particular conversion process.

VirginFibre

VirginFibre is optional because of choice construct.

Virgin Fibre

WoodProducts

WoodProducts is optional because of choice construct.

A grouping element for all wood products.

GeneralLedgerAccount

The general ledger account to be referenced for the item.

Agency [attribute]

Agency is optional. A single instance might exist.

Describes the agency maintaining the list of codes. To be included in this list the agency must be a recognized standards body or industry organisation.

For the element that owns this attribute.

For another attribute in the list of attributes associated with the parent element.

Refer to Agency definition for any enumerations.

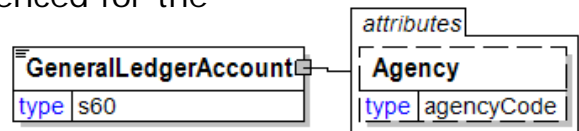

Gimmick

Gimmick

(sequence)

The sequence of items below is mandatory. A single instance is required.

AdditionalText

AdditionalText is optional. Multiple instances might exist.

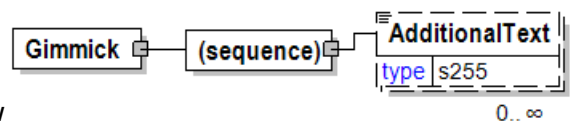

A text field that is used to communicate information not previously defined or for special instructions. To be used only for circumstances not covered by specific elements.

Gloss

A group item used to communicate specular gloss target or test value according to a particular TestMethod.

TestMethod [attribute]

TestMethod is optional. A single instance might exist.

The method used to determine the results of the test under consideration.

TestAgency [attribute]

TestAgency is optional. A single instance might exist.

The agency that has set the parameters for the testing

Refer to TestAgency definition for any enumerations.

SampleType [attribute]

SampleType is optional. A single instance might exist.

Communicates how sampling was done to measure the product characteristics.

Refer to SampleType definition for any enumerations.

ResultSource [attribute]

ResultSource is optional. A single instance might exist.

Used to define the data source of the specified test

Refer to ResultSource definition for any enumerations.

(sequence)

The sequence of items below is mandatory. A single instance is required.

DetailValue

DetailValue is mandatory. A single instance is required.

A numeric value expressed in the unit of measure (UOM).

DetailRangeMin

DetailRangeMin is optional. A single instance might exist.

The minimum value (lower boundary) allowed for the DetailValue that is the parent of this element.

DetailRangeMax

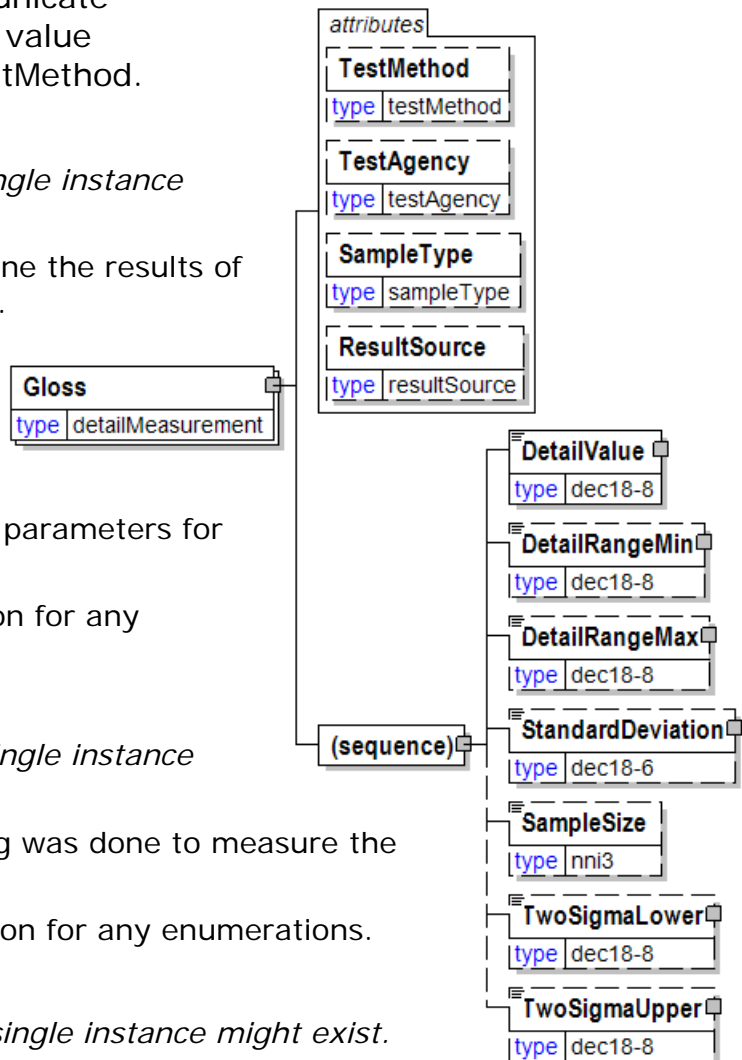

DetailRangeMax is optional. A single instance might exist.

The maximum value (upper boundary) allowed for the DetailValue that is the parent of this element.

StandardDeviation

StandardDeviation is optional. A single instance might exist.

A statistic used as a measure of dispersion in a distribution.

SampleSize

SampleSize is optional. A single instance might exist.

The number of samples used to determine the product characteristic in question.

TwoSigmaLower

TwoSigmaLower is optional. A single instance might exist.

Two sigma (a measure of dispersion associated with standard deviation) on the lower side of the standard deviation.

TwoSigmaUpper

TwoSigmaUpper is optional. A single instance might exist.

Two sigma (a measure of dispersion associated with standard deviation) on the upper side of the standard deviation.

GlueExposure

Exposure class as defined by NIST standards and indicated in the grade stamp.

This item is restricted to the following list.

Exterior

Interior

Exposure1

Exposure2

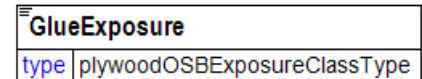

GlueExposure

A grouping element that is used to specify the standard concerning glueing and other details about gluing.

Agency [attribute]

Agency is mandatory.

A single instance is required.

Describes the agency maintaining the list of codes. To be included in this list the agency must be a recognized standards body or industry organisation.

For the element that owns this attribute.

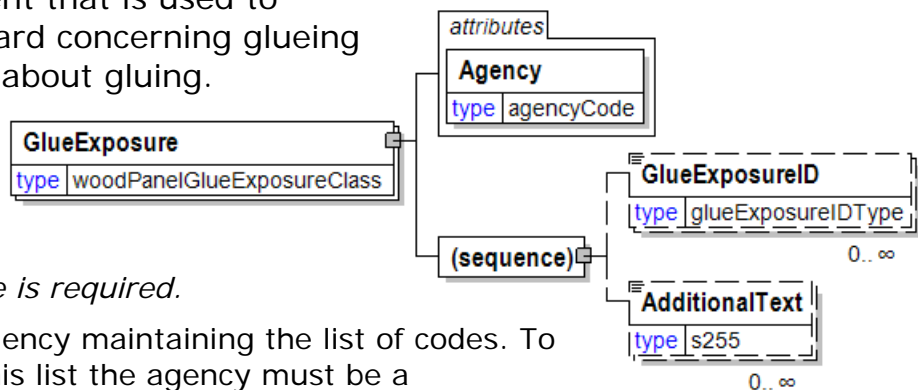

For another attribute in the list of attributes associated with the parent element.

Refer to Agency definition for any enumerations.

(sequence)

The sequence of items below is mandatory. A single instance is required.

GlueExposureID

GlueExposureID is optional. Multiple instances might exist.

Exposure class as defined by NIST standards and indicated in grade stamp.

Refer to GlueExposureID definition for any enumerations.

AdditionalText

AdditionalText is optional. Multiple instances might exist.

A text field that is used to communicate information not previously defined or for special instructions. To be used only for circumstances not covered by specific elements.

GlueExposureID

Exposure class as defined by NIST standards and indicated in grade stamp.

This item is restricted to the following list.

Exterior

Interior

Exposure1

Exposure2

Other

GlueExposureID
type glueExposureIDType

GoodsLoadingPrinciple [attribute]

Defines principles for how goods are picked from warehouse and loaded

This item is restricted to the following list.

FirstInFirstOut

Goods to be picked and loaded on a first in and first out basis. The oldest goods stored into warehouse to be picked first.

LastInFirstOut

Goods to be picked and loaded on a last in and first out basis. The latest goods stored into warehouse to be picked first

Random

Goods to be picked and loaded in any order

attribute
GoodsLoadingPrinciple
type inventoryRotationType
default FirstInFirstOut

GoodsReceipt

The GoodsReceipt element is the root element for the GoodsReceipt e-Document.

The ShipTo party, or authorised agent, sends a GoodsReceipt e-Document to the Supplier and/or to the Buyer acknowledging that a specific delivery or a number of deliveries in a given time period have been received and their status.

GoodsReceipt

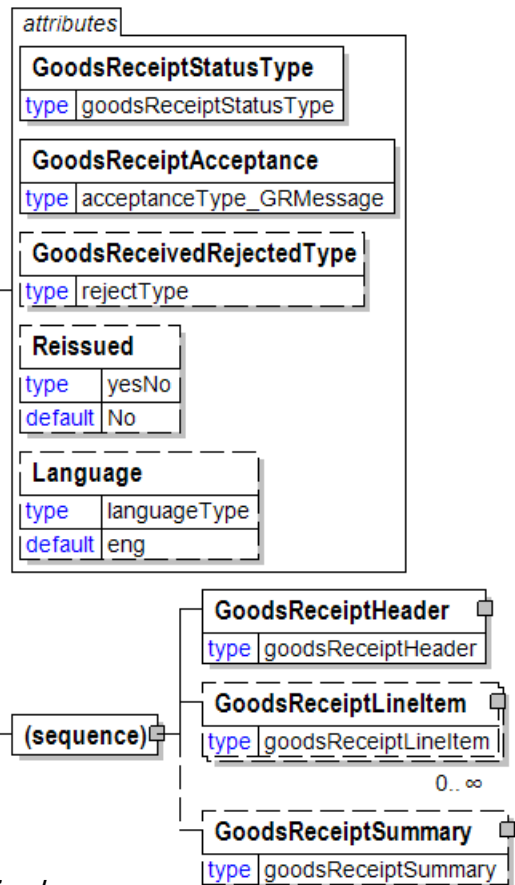

GoodsReceiptStatusType [attribute]

GoodsReceiptStatusType is mandatory. A single instance is required.

Defines the status of the entire GoodsReceipt e-Document at root level

Refer to GoodsReceiptStatusType definition for any enumerations.

GoodsReceiptAcceptance [attribute]

GoodsReceiptAcceptance is mandatory. A single instance is required.

Defines the state of the goods received as compared to the DeliveryMessage specifications. The enumeration list is the list of choices that apply to the GoodsReceipt e-Document root.

Refer to GoodsReceiptAcceptance definition for any enumerations.

GoodsReceivedRejectedType [attribute]

GoodsReceivedRejectedType is optional. A single instance might exist.

Defines the reason the goods were rejected

Refer to GoodsReceivedRejectedType definition for any enumerations.

Reissued [attribute]

Reissued is optional. A single instance might exist.

Either "Yes" or "No".

Refer to Reissued definition for any enumerations.

Language [attribute]

Language is optional. A single instance might exist.

XML has embraced 2 and 3 digit language codes through the application of an addendum to the standard.

Refer to Language definition for any enumerations.

(sequence)

The sequence of items below is mandatory. A single instance is required.

GoodsReceiptHeader

GoodsReceiptHeader is mandatory. A single instance is required.

The GoodsReceiptHeader is required and contains information common to the GoodsReceipt e-Document.

GoodsReceiptLineItem

GoodsReceiptLineItem is optional. Multiple instances might exist.

The Optional GoodsReceiptLineItem specifies how a shipment was received for an individual delivery line for one PurchaseOrder and PurchaseOrder line item.

GoodsReceiptSummary

GoodsReceiptSummary is optional. A single instance might exist.

Summary information that applies to the entire GoodsReceipt e-Document.

GoodsReceiptAcceptance [attribute]

Defines the state of the goods received as compared to the DeliveryMessage specifications. The enumeration list is the list of choices that apply to the GoodsReceipt header and line item.



This item is restricted to the following list.

GoodsReceivedAsIs

The delivered goods were received without inspection, or checking of the goods for damage, or accuracy against the DeliveryMessage.

GoodsReceivedAsSpecified

Received goods agree completely with all DeliveryMessage specifications for all lines including item identifiers and item weights. There is no transit damage.

GoodsReceivedCancelled

Received goods notification is being cancelled. This value is only used when the GoodsReceiptStatusType is "Cancelled".

GoodsReceivedRejected

Received goods agree completely with all DeliveryMessage specifications for all lines including item identifiers and item weights; but there has been transit damage resulting in rejection of all goods.

GoodsReceivedWithDamage

Received goods agree completely with all DeliveryMessage specifications for all lines including item identifiers and item weights; but there has been transit damage of some items. All transit damages must be specified.

GoodsReceivedWithVariance

Received goods do not agree completely with the DeliveryMessage specifications. For those items at variance, actual received item identifiers and item weights must be specified.

Additionally, used with the VarianceType of "NotReceived" to indicate items

that was on the DeliveryMessage but not in the Delivery as received.

GoodsReceivedWithVarianceAndDamage

Received goods do not agree completely with all DeliveryMessage specifications for all lines including item identifiers and item weights and there has been transit damage of some items. For those items at variance or with transit damage, actual received item identifiers, item weights, and transit damages must be specified.

GoodsReceiptAcceptance [attribute]

Defines the state of the goods received as compared to the DeliveryMessage specifications. The enumeration list is the list of choices that apply to the GoodsReceipt e-Document root.



This item is restricted to the following list.

GoodsReceivedAsIs

The delivered goods were received without inspection, or checking of the goods for damage, or accuracy against the DeliveryMessage.

GoodsReceivedAsSpecified

Received goods agree completely with all DeliveryMessage specifications for all lines including item identifiers and item weights. There is no transit damage.

GoodsReceivedCancelled

Received goods notification is being cancelled. This value is only used when the GoodsReceiptStatusType is "Cancelled."

GoodsReceivedRejected

Received goods agree completely with all DeliveryMessage specifications for all lines including item identifiers and item weights; but there has been transit damage resulting in rejection of all goods.

GoodsReceivedWithDamage

Received goods agree completely with all DeliveryMessage specifications for all lines including item identifiers and item weights; but there has been transit damage of some items. All transit damages must be specified.

GoodsReceivedWithoutDeliveryMessage

Goods were received but there was no prior DeliveryMessage. This acceptance status applies to the entire GoodsReceipt e-Document and is available only at the e-Document level.

GoodsReceivedWithVariance

Received goods do not agree completely with the DeliveryMessage specifications. For those items at variance, actual received item identifiers and item weights must be specified.

Additionally, used with the VarianceType of "NotReceived" to indicate items that was on the DeliveryMessage but not in the Delivery as received.

GoodsReceivedWithVarianceAndDamage

Received goods do not agree completely with all DeliveryMessage specifications for all lines including item identifiers and item weights and there has been transit damage of some items. For those items at variance or with transit damage, actual received item identifiers, item weights, and transit damages must be specified.

GoodsReceiptArrivalDate

The Date and optionally Time on which the received goods arrived.

(sequence)

The sequence of items below is mandatory. A single instance is required.

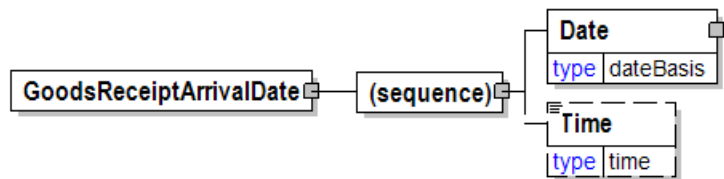

Date

Date is mandatory. A single instance is required.

A group element that contains the specification of Year, Month, and Day.

Time

Time is optional. A single instance might exist.

Times are treated in a standard XML fashion with a special case used to indicate a generalized "local" time. The standard XML approach to time is hh:mm:ss, hh:mm:ssZ, or hh:mm:ss±hh:mm.

hh:mm:ss±hh:mm is used to represent a time with a time zone. The time zone is communicated as the number of hours offset from the Universal Time Coordinate (UTC), a.k.a. Greenwich Mean Time.

hh:mm:ssZ indicates the time at Zulu (another name for UTC). Based on the convention described in the next bullet it will be important for users within UTC to use "Z" when communicating a time in their time zone to other users.

hh:mm:ss or hh:mm indicates in the XML standard the time at UTC however, within papiNet it is used to represent the applicable local time. Caution should be used when processing times of this nature as the papiNet approach may be in discord with other users of XML.

GoodsReceiptHeader

The GoodsReceiptHeader is required and contains information common to the GoodsReceipt e-Document.

GoodsReceiptHeaderAcceptance [attribute]

GoodsReceiptHeaderAcceptance is optional. A single instance might exist.

Defines the state of the goods received as compared to the DeliveryMessage specifications. The enumeration list is the list of choices that apply to the GoodsReceipt header and line item.

Refer to GoodsReceiptHeaderAcceptance definition for any enumerations.

(sequence)

The sequence of items below is mandatory. A single instance is required.

GoodsReceiptNumber

GoodsReceiptNumber is mandatory. A single instance is required.

The unique receipt identifier as agreed by the trading partners.

GoodsReceiptIssueDate

GoodsReceiptIssueDate is optional. A single instance might exist.

The date that the GoodsReceipt e-Document was created.

TransactionHistoryNumber

TransactionHistoryNumber is optional. A single instance might exist.

A sequential number that keeps track of the version of a document being sent by the document originator except in the case where TransactionHistoryConfirmation is used, in which case the TransactionHistoryNumber refers to the trigger transaction for which the confirmation is being sent.

GoodsReceiptArrivalDate

GoodsReceiptArrivalDate is optional. A single instance might exist.

The Date and optionally Time on which the received goods arrived.

TimePeriod

TimePeriod is optional. A single instance might exist.

The TimePeriod element is used to communicate a duration period of time as

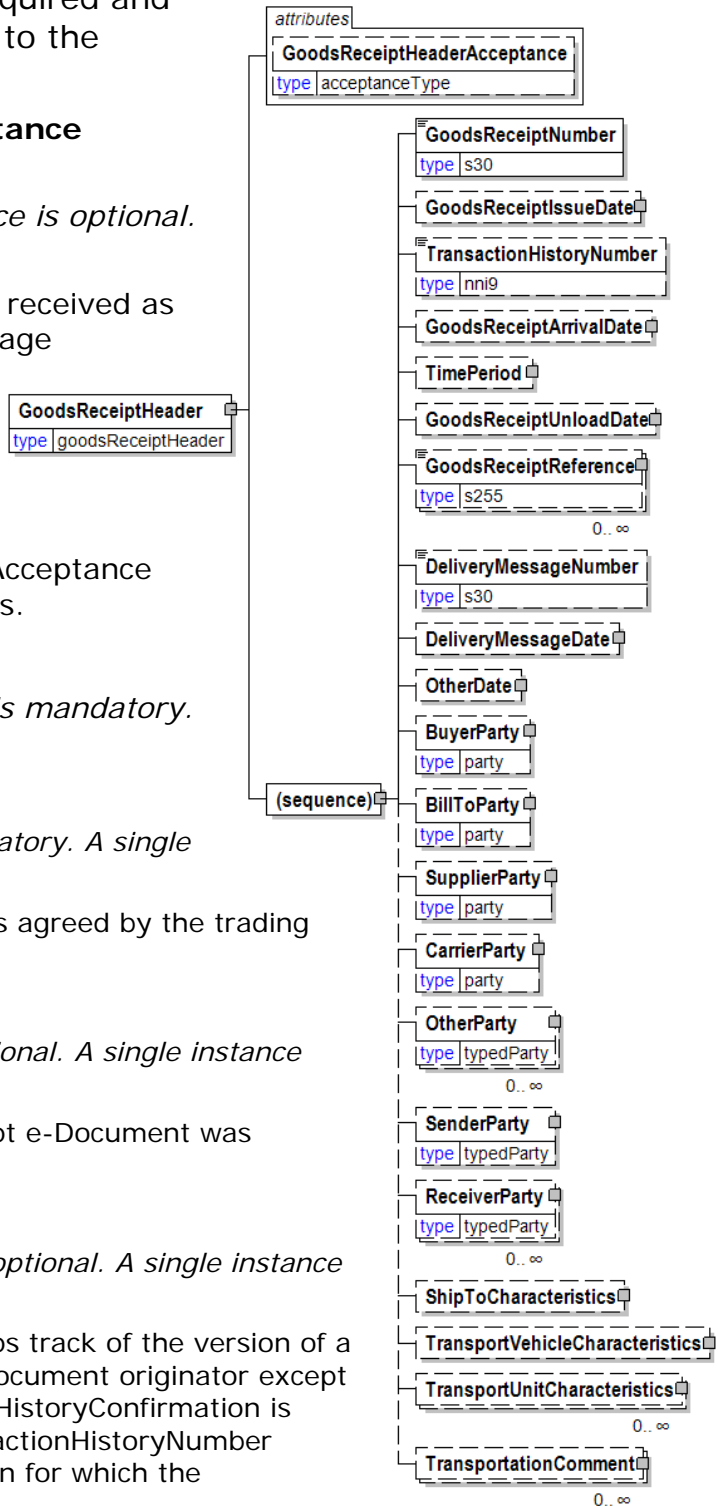

indicated in PeriodType.

GoodsReceiptUnloadDate

GoodsReceiptUnloadDate is optional. A single instance might exist.

The Date and optionally Time on which the received goods were unloaded.

GoodsReceiptReference

GoodsReceiptReference is optional. Multiple instances might exist.

A group item detailing relevant references (such as contract number) pertaining to the GoodsReceipt, as indicated by the GoodsReceiptReferenceType.

DeliveryMessageNumber

DeliveryMessageNumber is optional. A single instance might exist.

A unique delivery identifier assigned to each DeliveryMessage as agreed between the trading partners.

DeliveryMessageDate

DeliveryMessageDate is optional. A single instance might exist.

The Date and Time when the DeliveryMessage was issued.

OtherDate

OtherDate is optional. A single instance might exist.

A date that may not be specifically detailed within a document (example: print date at the PurchaseOrderLineItem).

BuyerParty

BuyerParty is optional. A single instance might exist.

The legal entity to which the product is sold. Also commonly referred to as the sold-to party or customer. If no OtherParty is defined as the Payer, the Buyer is the Payer.

BillToParty

BillToParty is optional. A single instance might exist.

The address where the Invoice is to be sent.

SupplierParty

SupplierParty is optional. A single instance might exist.

The organisation or business entity responsible for providing the product. SupplierParty is also the seller of the product, if Seller is not specified as OtherParty = Seller.

CarrierParty

CarrierParty is optional. A single instance might exist.

The party performing the transport of the product from the pickup location to the ship-to location; could be a hauler.

OtherParty

OtherParty is optional. Multiple instances might exist.

An organisation or business entity other than those specifically detailed within a e-Document.

SenderParty

SenderParty is optional. A single instance might exist.

The business entity issuing the e-Document, the source of the document.

The entity responsible for the content. If the sender party has out sourced the message service to a third party the SenderParty is the issuer of the e-Document and not the party performing the transmission service of the electronic message.

ReceiverParty

ReceiverParty is optional. Multiple instances might exist.

The business entity for whom the e-Document is intended, the destination of the document.

The entity interested in the content. If the receiver party has outsourced the message service to a third party the ReceiverParty is the intended party for the e-Document and not the party performing the receiving service of the electronic message.

ShipToCharacteristics

ShipToCharacteristics is optional. A single instance might exist.

A group item that provides information important for the Ship-To Party.

A group item that provides information important for the Ship-To Party. ShipToCharacteristics may be referenced at both the header and line item level. The reference at the header is required and acts as a default for the value at the line level, unless overridden at the line level.

TransportVehicleCharacteristics

TransportVehicleCharacteristics is optional. A single instance might exist.

A group item defining the primary means of transporting the goods, such as a side port vessel. In some instances, the transport unit and vehicle are the same.

TransportUnitCharacteristics

TransportUnitCharacteristics is optional. Multiple instances might exist.

A group item defining and identifying the primary means of containing the goods. In some instances, the transport unit and vehicle are the same.

TransportationComment

TransportationComment is optional. Multiple instances might exist.

Textual Commentary on Transportation for an entire GoodsReceipt.

GoodsReceiptHeaderAcceptance [attribute]

Defines the state of the goods received as compared to the DeliveryMessage specifications. The enumeration list is the list of choices that apply to the GoodsReceipt header and line item.

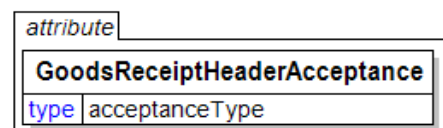

This item is restricted to the following list.

GoodsReceivedAsIs

The delivered goods were received without inspection, or checking of the goods for damage, or accuracy against the DeliveryMessage.

GoodsReceivedAsSpecified

Received goods agree completely with all DeliveryMessage specifications for all lines including item identifiers and item weights. There is no transit damage.

GoodsReceivedCancelled

Received goods notification is being cancelled. This value is only used when the GoodsReceiptStatusType is "Cancelled".

GoodsReceivedRejected

Received goods agree completely with all DeliveryMessage specifications for all lines including item identifiers and item weights; but there has been transit damage resulting in rejection of all goods.

GoodsReceivedWithDamage

Received goods agree completely with all DeliveryMessage specifications for all lines including item identifiers and item weights; but there has been transit damage of some items. All transit damages must be specified.

GoodsReceivedWithVariance

Received goods do not agree completely with the DeliveryMessage specifications. For those items at variance, actual received item identifiers and item weights must be specified.

Additionally, used with the VarianceType of "NotReceived" to indicate items that was on the DeliveryMessage but not in the Delivery as received.

GoodsReceivedWithVarianceAndDamage

Received goods do not agree completely with all DeliveryMessage specifications for all lines including item identifiers and item weights and there has been transit damage of some items. For those items at variance or with transit damage, actual received item identifiers, item weights, and transit damages must be specified.

GoodsReceiptIssueDate

The date that the GoodsReceipt e-Document was created.

(sequence)

The sequence of items below is mandatory. A single instance is required.

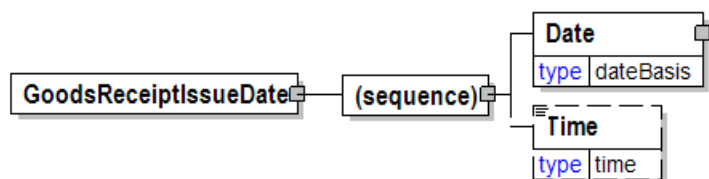

Date

Date is mandatory. A single instance is required.

A group element that contains the specification of Year, Month, and Day.

Time

Time is optional. A single instance might exist.

Times are treated in a standard XML fashion with a special case used to indicate a generalized "local" time. The standard XML approach to time is hh:mm:ss, hh:mm:ssZ, or hh:mm:ss±hh:mm.

hh:mm:ss±hh:mm is used to represent a time with a time zone. The time zone is communicated as the number of hours offset from the Universal Time Coordinate (UTC), a.k.a. Greenwich Mean Time.

papiNet V2R31

hh:mm:ssZ indicates the time at Zulu (another name for UTC). Based on the convention described in the next bullet it will be important for users within UTC to use "Z" when communicating a time in their time zone to other users.

hh:mm:ss or hh:mm indicates in the XML standard the time at UTC however, within papiNet it is used to represent the applicable local time. Caution should be used when processing times of this nature as the papiNet approach may be in discord with other users of XML.

GoodsReceiptLineItem

The Optional GoodsReceiptLineItem specifies how a shipment was received for an individual delivery line for one PurchaseOrder and PurchaseOrder line item.

GoodsReceiptAcceptance [attribute]

GoodsReceiptAcceptance is mandatory. A single instance is required.

Defines the state of the



goods received as compared to the DeliveryMessage specifications. The enumeration list is the list of choices that apply to the GoodsReceipt header and line item.

Refer to GoodsReceiptAcceptance definition for any enumerations.

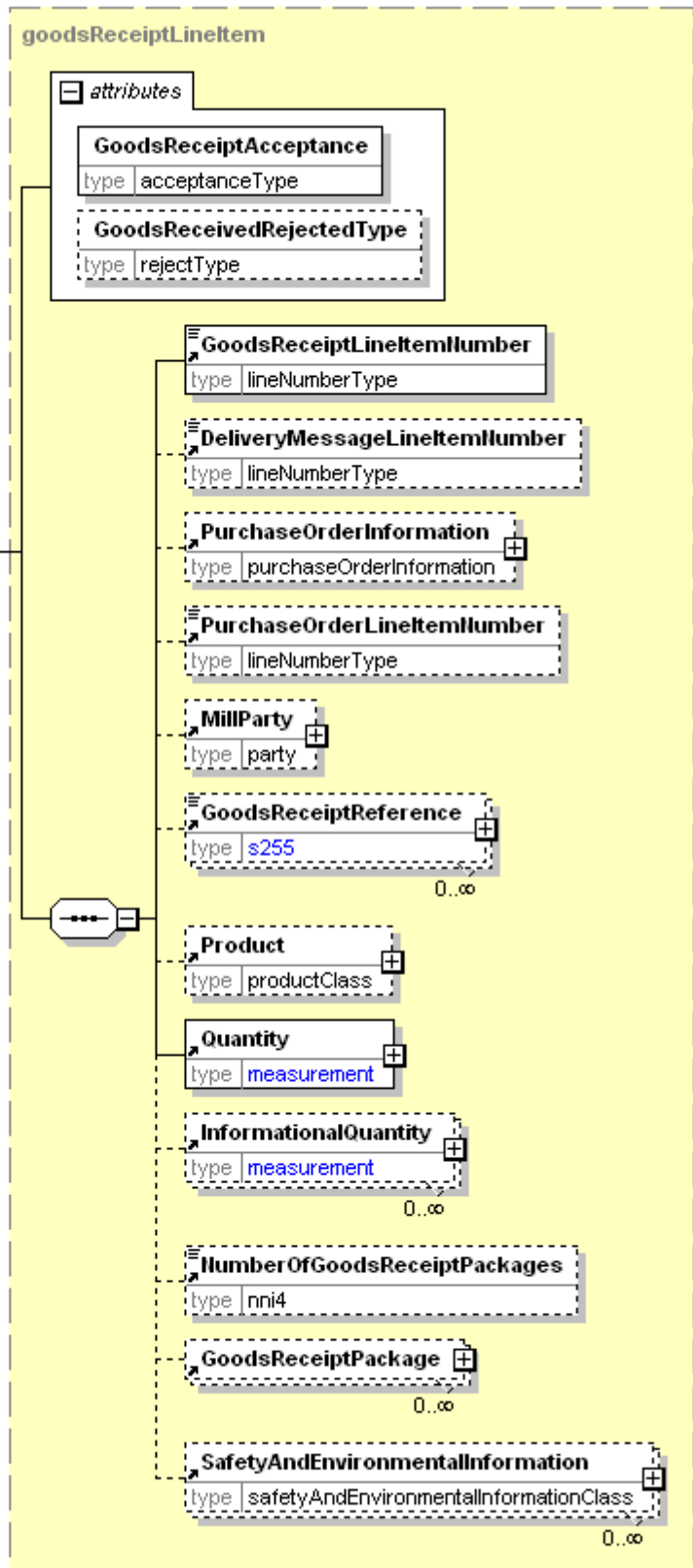

GoodsReceivedRejectedType [attribute]

GoodsReceivedRejectedType is optional. A single instance might exist.

Defines the reason the goods were rejected

Refer to GoodsReceivedRejectedType definition for any enumerations.

(sequence)

The sequence of items below is mandatory. A single instance is required.

GoodsReceiptLineItemNumber

GoodsReceiptLineItemNumber is mandatory. A single instance is required.

A sequential number that uniquely identifies the GoodsReceipt line item.

DeliveryMessageLineItemNumber

DeliveryMessageLineItemNumber is optional. A single instance might exist.

The sequential number that uniquely identifies the delivery line item.

PurchaseOrderInformation

PurchaseOrderInformation is optional. A single instance might exist.

A group item containing information unique to this PurchaseOrder, which is provided by the buyer. PurchaseOrderInformation can be optional in the supply chain. Invoices are created without having a PurchaseOrder in Vendor Managed Inventory. Freight invoices also will not have a PurchaseOrder number.

PurchaseOrderLineItemNumber

PurchaseOrderLineItemNumber is optional. A single instance might exist.

The sequential number that uniquely identifies the PurchaseOrder line item.

MillParty

MillParty is optional. A single instance might exist.

The organisation or business entity that actually produces the product.

GoodsReceiptReference

GoodsReceiptReference is optional. Multiple instances might exist.

A group item detailing relevant references (such as contract number) pertaining to the GoodsReceipt, as indicated by the GoodsReceiptReferenceType.

Product

Product is optional. A single instance might exist.

Product is a group item defining the article and its characteristics. Product is used to specify product characteristics organized by ProductIdentifier, ProductDescription, and Classification. Book Manufacturing, Label Stock, Paper, Pulp, Recovered Paper, Wood Products, and Virgin Fibre market segments have defined their product characteristics and conversion features for implementation in papiNet.

Quantity

Quantity is mandatory. A single instance is required.

The Quantity element contains attributes that provide information about the type of quantity that is being communicated, the context in which the particular quantity is to be viewed, and (if the quantity represents an adjustment) an adjustment type.

The Quantity element contains three child elements that enable you to communicate a range of values for the quantity and a target or actual value. It is at this level (Value, RangeMin, and RangeMax) that the unit of measure is specified. This permits the range to be specified in a different unit of measure than the target.

InformationalQuantity

papiNet V2R31

InformationalQuantity is optional. Multiple instances might exist.

A quantity given in a valid UOM used for information purposes only (not for calculation). For example, an ordered quantity was 100 reels as opposed to the invoice quantity of 20,000 pounds.

NumberOfGoodsReceiptPackages

NumberOfGoodsReceiptPackages is optional. A single instance might exist.

A count of the number of packages detailed in the GoodsReceiptLineItem.

GoodsReceiptPackage

GoodsReceiptPackage is optional. Multiple instances might exist.

This element represents the manner in which the GoodsReceipt is packaged.

SafetyAndEnvironmentalInformation

SafetyAndEnvironmentalInformation is optional. Multiple instances might exist.

Name of certification type, if any, on the goods (For example, FSC, PEFC). SafetyAndEnvironmental needs a value or measurement to communicate the percentage of the product is certified (for example, 75% is certified by the indicated agency).

GoodsReceiptLineItemNumber

A sequential number that uniquely identifies the GoodsReceipt line item.

GoodsReceiptLineItemNumber
type lineNumberType

GoodsReceiptNumber

The unique receipt identifier as agreed by the trading partners.

GoodsReceiptNumber
type s30

GoodsReceiptPackage

This element represents the manner in which the GoodsReceipt is packaged.

GoodsReceiptAcceptance [attribute]

GoodsReceiptPackage

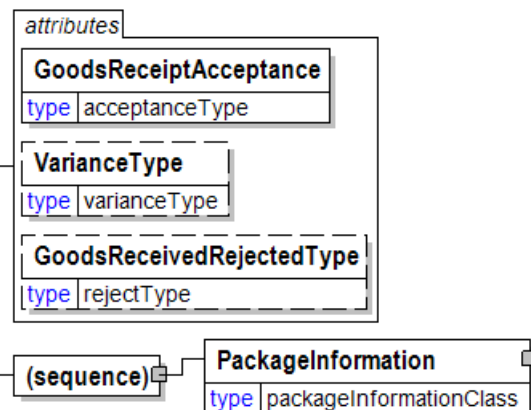

GoodsReceiptAcceptance is mandatory. A single instance is required.

Defines the state of the goods received as compared to the DeliveryMessage specifications. The enumeration list is the list of choices that apply to the GoodsReceipt e-Document root.

Refer to GoodsReceiptAcceptance definition for any enumerations.

VarianceType [attribute]

VarianceType is optional. A single instance might exist.

Defines the type of difference that the GoodsReceiptPackage has from the information on the DeliveryMessage

Refer to VarianceType definition for any enumerations.

GoodsReceivedRejectedType [attribute]

GoodsReceivedRejectedType is optional. A single instance might exist.

Defines the reason the goods were rejected

Refer to GoodsReceivedRejectedType definition for any enumerations.

(sequence)

The sequence of items below is mandatory. A single instance is required.

PackageInformation

PackageInformation is mandatory. A single instance is required.

The purpose of the PackageInformation structure is to clearly identify physical handling items that constitute the delivery.

PackageInformation is the highest level of product packaging it describes the shipping or warehousing unit.

If you are communicating a package, usually for logistics or transport purposes, you should include the PackageType, Identifier, ItemCount, and Quantity. (Note: you still have the ability to describe the item with one of the "named" items.)

If you are communicating one of the named Items there is no need to include PackageType, Identifier, ItemCount, and Quantity.

Since either of these two approaches can be used the entire contents of this element are optional even though the parent may be required. It is expected that you will fill in the appropriate details.

GoodsReceiptReference

A group item detailing relevant references (such as contract number) pertaining to the GoodsReceipt, as indicated by the

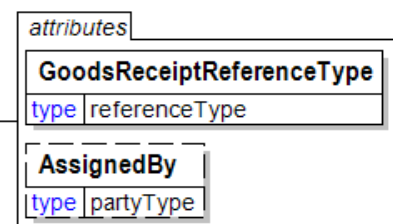
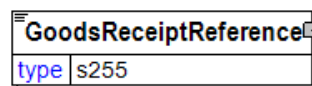

GoodsReceiptReferenceType.

GoodsReceiptReferenceType [attribute]

GoodsReceiptReferenceType is mandatory. A single instance is required.

Provides a contextual explanation of the specific reference identifier. Many items are currently prefixed by "Buyer", "Forwarder", "Manufacturer", "Mill", "Seller", "Supplier", "Warehouse", or "Vendor". Check for an existing non-prefixed version and use the non-prefixed version instead. In the (yet to be announced release date) version 3.0 the prefixed versions will be removed. Instead the attribute @AssignedBy will communicate the information

previously communicated in the prefix.

Refer to GoodsReceiptReferenceType definition for any enumerations.

AssignedBy [attribute]

AssignedBy is optional. A single instance might exist.

Identifies the type of party that has assigned the associated item, e.g. a reference of type OrderNumber.

Refer to AssignedBy for any enumerations.

GoodsReceiptReferenceType [attribute]

Provides a contextual explanation of the specific reference identifier. Many items are currently prefixed by "Buyer", "Forwarder", "Manufacturer", "Mill", "Seller", "Supplier", "Warehouse", or "Vendor". Check for an existing non-prefixed version and use the non-prefixed version instead. In the (yet to be announced release date) version 3.0 the prefixed versions will be removed. Instead the attribute @AssignedBy will communicate the information previously communicated in the prefix.

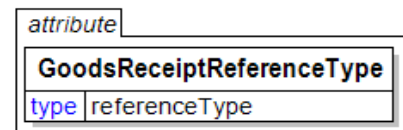

Refer to the [referenceType](#) entry for the list of enumerations and their definitions.

GoodsReceiptStatusType [attribute]

Defines the status of the entire GoodsReceipt e-Document at root level

This item is restricted to the following list.

Cancelled

The supplied information has been cancelled. Items that have been cancelled are not included in totals on the summary levels of the e-Document.

Original

The supplied information is the first version of that information.

Replaced

The supplied information is replacing earlier supplied information. The receiver should revalidate the information in their system based upon the entire information received.

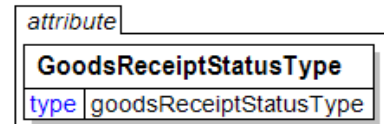

GoodsReceiptSummary

Summary information that applies to the entire GoodsReceipt e-Document.

(sequence)

The sequence of items below is mandatory. A single instance is



required.

TotalNumberOfLineItems

TotalNumberOfLineItems is optional. A single instance might exist.

The total number of individual line items in the document, regardless of the status or type.

(sequence)

The sequence of items below is mandatory. One instance is required, multiple instances might exist.

TotalQuantity

TotalQuantity is mandatory. A single instance is required.

The total quantity of similar items in the e-Document. TotalQuantity is primarily used in the summary section of documents where it is repeatable to permit totaling for different units of measure.

TotalInformationalQuantity

TotalInformationalQuantity is optional. Multiple instances might exist.

A quantity that is used to communicate related information about the parent element. This element represents a total that is derived from individual line items.

TermsAndDisclaimers

TermsAndDisclaimers is optional. Multiple instances might exist.

An element that contains legal information with an indication of what the Language is.

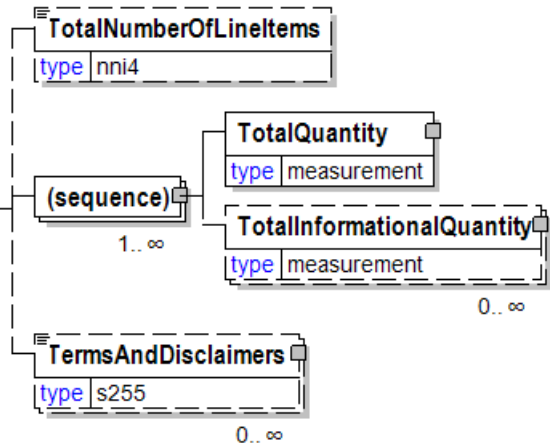

GoodsReceiptUnloadDate

The Date and optionally Time on which the received goods were unloaded.

(choice)

[choice] is optional because of choice construct.

(sequence)

The sequence of items below is mandatory. A single instance is required.

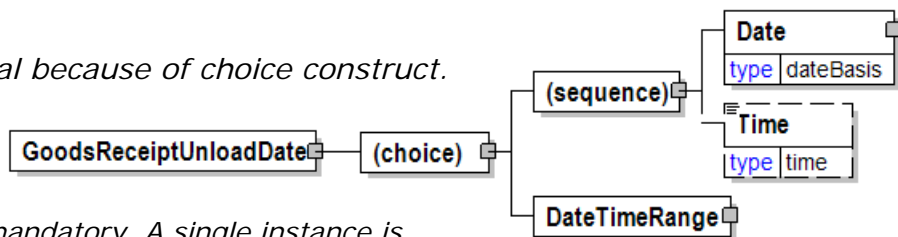

Date

papiNet V2R31

Date is mandatory. A single instance is required.

A group element that contains the specification of Year, Month, and Day.

Time

Time is optional. A single instance might exist.

Times are treated in a standard XML fashion with a special case used to indicate a generalized "local" time. The standard XML approach to time is hh:mm:ss, hh:mm:ssZ, or hh:mm:ss±hh:mm.

hh:mm:ss±hh:mm is used to represent a time with a time zone. The time zone is communicated as the number of hours offset from the Universal Time Coordinate (UTC), a.k.a. Greenwich Mean Time.

hh:mm:ssZ indicates the time at Zulu (another name for UTC). Based on the convention described in the next bullet it will be important for users within UTC to use "Z" when communicating a time in their time zone to other users.

hh:mm:ss or hh:mm indicates in the XML standard the time at UTC however, within papiNet it is used to represent the applicable local time. Caution should be used when processing times of this nature as the papiNet approach may be in discord with other users of XML.

DateTimeRange

DateTimeRange is optional because of choice construct.

Specifies a date and/or time range.

GoodsReceivedRejectedType [attribute]

Defines the reason the goods were rejected

This item is restricted to the following list.

ExcessiveTransitDamage

The item(s) is/are damaged beyond acceptable use during transit.

ProductQuality

The delivery did not match the quality of the product ordered or requested.

TooEarly

The delivery has occurred prior to the agreed delivery date/time. For example, there is insufficient storage at the delivered time.

TooLate

The delivery has occurred after the agreed delivery date/time. For example, delivered after press date.

UnableToUnload

The delivered items cannot be unloaded. For example, damaged vehicle doors, load has shifted during transportation, or ShipTo requires reels to be palletised but they are delivered on the vehicle floor.

WrongBarcode

The barcode used to identify the product is incorrect.

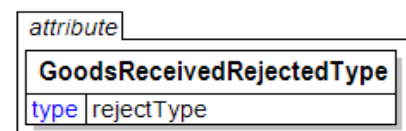

WrongBasisWeight

The basis weight of the product is not what was ordered.

WrongDeliveryLocation

The product was delivered to the wrong location.

WrongDiameter

The diameter delivered is unusable. For example, a physical limitation on a reel stand is exceeded.

WrongLabel

The delivered item has incorrect or missing information, or incorrect label stock that would prevent its use. For example, insufficient peel-off barcode labels.

WrongProduct

The delivered item was not the product ordered or requested.

WrongReelWidth

The width of the reel is incorrect.

WrongVehicleType

The items have been delivered in a vehicle that cannot be unloaded at the ShipTo facility. For example, the ShipTo requires side unloading vehicles, but the delivery vehicle can only be unloaded from the rear.

WrongWrap

The delivered item is wrapped in material that will prevent its use. For example, a hole is not present in the end cap for vacuum lifting.

GPSCoordinates

The location of the party as specified using a Global Positioning System.

GPSSystem [attribute]

GPSSystem is optional. A single instance might exist.

The type of GPS system.

Refer to GPSSystem definition for any enumerations.

(sequence)

The sequence of items below is mandatory. A single instance is required.

Latitude

Latitude is mandatory. A single instance is required.

A measurement of the position of the party or contact in degrees north or south of the equator

Longitude

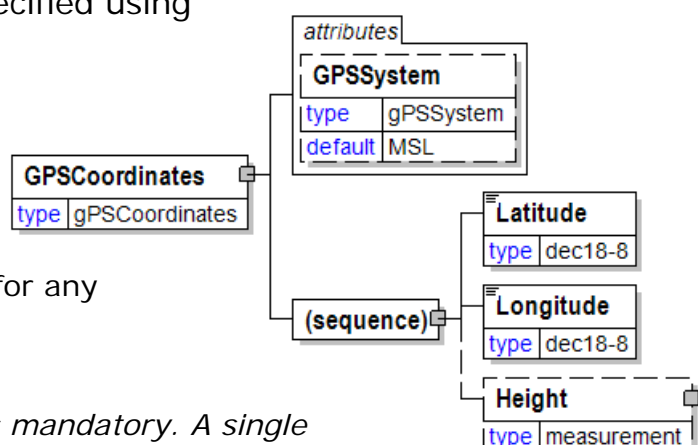

papiNet V2R31

Longitude is mandatory. A single instance is required.

A measurement of the position of the party or contact in degrees east or west of the prime meridian

Height

Height is optional. A single instance might exist.

The height of the object.

GPSSystem [attribute]

The type of GPS system.

This item is restricted to the following list.

ECEF

Earth Centered Earth Fixed

HAE

Height about Ellipse

MSL

Mean Sea Level (default)

attribute	
GPSSystem	
type	gPSSystem
default	MSL

Grade

Grade

Grade	
type	s60

GradeAgency [attribute]

LumberAgency identifies which agency is responsible for assigning the lumber attributes.

This item is restricted to the following list.

BS

BS-EN

British standard based on a European standard.

CEN

European Committee for Standardisation (<http://www.cenorm.be>)

DIN

EN338

EN1912

EN1611-1

EDISAW

Generic

attribute	
GradeAgency	
type	LumberAgencyType

GOST

Russian federal agency on technical regulating and metrology
(<http://www.gost.ru>)

ISO

JAS

Japanese Agricultural Standard

NELMA

NLGA

NS

NSLB

RIS

RT

SIS

SPIB

WCLIB

WRCLA

WWPA

Supplier

GradeAgency

North American structural panel grading agencies. Defines the governing organisation of the grading scheme employed.

GradeAgency
type plywoodOSBGradeAgencyType

Note: There is a GradeAgency attribute, as well.

This item is restricted to the following list.

APA

PITTSBURG

TECO

MillCertified

None

GradeCode

A specific product code for which the owner or source is specified.

GradeCode
type s30

GradeName

A specific product name for which the owner or source is specified (for example, ImprovedNewsprint-45-1479)

GradeName	
type	s30

GradeStamp

Grade stamp information

GradeStamped [attribute]

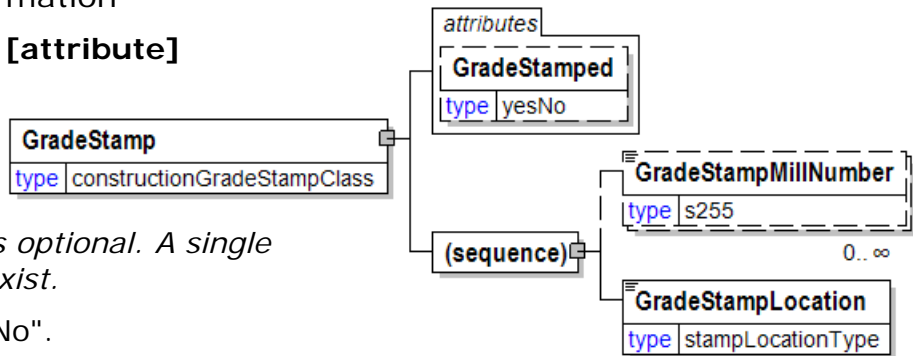

GradeStamped is optional. A single instance might exist.

Either "Yes" or "No".

Refer to GradeStamped definition for any enumerations.

(sequence)

The sequence of items below is mandatory. A single instance is required.

GradeStampMillNumber

GradeStampMillNumber is optional. Multiple instances might exist.

Identifies the mill where the special grading was carried out.

GradeStampLocation

GradeStampLocation is mandatory. A single instance is required.

Defines the location on the piece (of the stamp).

Refer to GradeStampLocation definition for any enumerations.

GradeStamped [attribute]

Either "Yes" or "No".

This item is restricted to the following list.

Yes

No

attribute	
GradeStamped	
type	yesNo

GradeStampLocation

Defines the location on the piece (of the stamp).

This item is restricted to the following list.

Face

Back

Good Side

GradeStampLocation	
type	stampLocationType

Bad Side

Edge

End

GradeStampMillNumber

Identifies the mill where the special grading was carried out.

GradeStampMillNumber
type s255

GradeType [attribute]

Grade Type

This item is restricted to the following list.

- #1
- #1 and #2
- #1 and #2 Clear
- #1 (SRB)
- #1 Box
- #1 Commons
- #1 Cuts
- #1 Cuttings
- #1 Dense
- #1 Dense Stadium Grade
- #1 Dense Structural
- #1 Door Cuttings
- #1 Fencing (Select)
- #1 Furniture
- #1 Lath
- #1 Mining
- #1 Non Dense
- #1 Pencil Stock
- #1 Prime
- #1 Sash Cuttings
- #1 Shop
- #1 Stadium Grade
- #1 Structural
- #1 and Btr

attribute
GradeType
type lumberGradeType

#2
#2 (SRB)
#2 Box
#2 Common
#2 Cuts
#2 Cuttings
#2 Dense
#2 Door Cuttings
#2 Fencing (Quality)
#2 Foundation
#2 Furniture
#2 Lath
#2 Mining
#2 Non Dense
#2 Pencil Stock
#2 Prime
#2 Sash Cuttings
#2 Shop
#2 Structural
#2 and Btr
#2 and Btr Common
#2 and Btr Fencing(Rustic)
#3
#3 (SRB)
#3 Clear
#3 Common
#3 Cuttings
#3 Fencing
#3 Fencing (Rustic)
#3 Lath
#3 Pencil Stock
#3 Shop
#3 Shop or Sash
#3 and Btr
#3 and Btr Common
#4
#4 Common

#5 Common

1.5E LAM

1.6E LAM

1.7E LAM

1.8E LAM

1.9E LAM

1200f

1350f

1400f

1450f

1500f

1600f

1650f

1800f

1950f

2.0E LAM

2.1E LAM

2.2E LAM

2.3E LAM

2.4E LAM

2.5E LAM

2.6E LAM

2000f

2100f

2200f Scaffold Plank

2250f

2400f

2400f Scaffold Plank

2550f

26002-83

GOST (agency) export Quality

2700f

2850f

3000f

302-20

302-22

302-24

3150f

3300f

8486

GOST (agency) domestic quality

900f

A

A and Btr

Appearance Knotty

Architect Clear

Architect Knotty

B

B and B

B Grade

B Laminating

B and Btr

B and Btr - 1 and 2 Clear

B.F.Laminating

Barge Framing

Barge Planking and Decking

Battens

C

C Laminating

C Select

C Ship Decking

C and Btr

C and Btr Dimension

C and Btr Select

C and Btr-VG Stepping

California Fencing

Choice

Choice and Btr

Clear

Clear All Heart

Clear Door

Clear Door Rip

Clear Finger Joint

Clear Gutter

Clear Heart
Clear VG Heart
Colonial
Commercial Decking
Commercial Dex
Commercial Patio
Construction
Construction (SRB)
Construction Common
Construction Heart
Crossarms
Custom Clear
Custom knotty
Cut Door Stock
D
D Dimension
D Laminating
D Select
D and Btr
D and Btr Select
Deck Common
Deck Heart
Dense Commercial Decking
Dense Industrial Scaffold plank 65
Dense Industrial Scaffold Plank 72
Dense Premium
Dense Select Decking
Dense Select Structural
Dense Standard Decking
Dunnage
DOVD Stepping
E
Economy
Economy Fencing
Economy Stud
Factory Flitches
Factory Select

FG or MG Ladder Rails
Fingerjoint Shop Common
Finish
Foundation
Gutter
Heart B
Heart Clear
Industrial
Industrial 26
Industrial 45
Industrial 55
Knotty
Knotty Finger Joint
L1 Dense Laminating
L1 Laminating
L1-c Laminating
L2 Laminating
L2-d Dense Laminating
L3 Laminating
Ladder and Pole Stock
Ladder Rail Stock
M-10
M-11
M-12
M-13
M-14
M-15
M-16
M-17
M-18
M-19
M-20
M-21
M-22
M-23
M-24
M-25

M-26

M-27

M-28

M-29

M-30

M-31

M-5

M-6

M-7

M-8

M-9

Margin Plank

Mast Spar and Boat Two and One-Fourth Inch and Thicker

Mast Spar and Boat One to Two Inch

Merchantable

Merchantable Heart

MillGrade

Moulding Stock (A)

Moulding Stock (B)

Moulding and Btr

Mouldings

NeLMA # 1A Furniture

NeLMA # 2A Furniture

None

NSLB #1

NSLB #2

Par99

Patio 1

Patio 2

Pipe Stave Stock

Plank Wall

Premium

Premium and Btr

Prime

Quality

Quality Fencing

Quality Knotty

RadiusEdgeDecking 1
RadiusEdgeDecking 2
Rustic
Rustic Fencing
Rustic Knotty
Sash
Sash Cuttings
Sawn Railroad Ties
Scaffold #1
Scaffold #2
Select
Select and Quality Knotty
Select Decking
Select Dex
Select Fencing
Select Heart
Select Knotty
Select Merchantable
Select Patio
Select Shop
Select Structural
Select Structural (SRB)
Select Structural Non Dense
Selected
Selected #2 Common
Selected #3 Common
Selected Decking
Selected Gutter
Ship Decking
Ship Plank
Shop Flitches
Short
Short Select
SPS 1 Certified Fingerjointed
SPS 3 Certified Fingerjointed
Stadium Plank Seats
Stadium Plank Walk boards

Stadium Planks
Stained Selects
Standard
Standard (SRB)
Standard Mouldings
Standard and Btr
Sterling
Stud
Stud (SRB)
Superior
Supreme
Tank Stock Inch and Thicker
Tank Stock Under Four Inch
Utility
Utility (#2 Mining)
Utility (SRB)
Utility and Btr
VG Ladder Rails

GradingRule [attribute]

Grading rule, the rules under which the product has been graded.

This item is restricted to the following list.

European 1611-1
GSSS
Nordic
SS EN 230120
Supplier
Other

attribute
GradingRule
type gradingRule

GrainDirection

Defines the primary orientation/alignment (Long or Short) of the cellulose fibres in a sheet or web of paper, which results from the flow of fibres in a water suspension during the papermaking process.

This item is restricted to the following list.

Any

GrainDirection
type grainDirection

Grain Direction does not matter.

Long

Orientation is aligned with the long fibres or with the grain.

Short

Orientation is aligned with the short fibres or against the grain.

Green

The "Green" portion of the method of representing colour termed RGB

(sequence)

The sequence of items below is mandatory. A single instance is required.

DetailValue

DetailValue is mandatory. A single instance is required.

A numeric value expressed in the unit of measure (UOM).

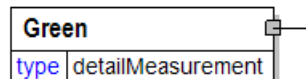

DetailRangeMin

DetailRangeMin is optional. A single instance might exist.

The minimum value (lower boundary) allowed for the DetailValue that is the parent of this element.

DetailRangeMax

DetailRangeMax is optional. A single instance might exist.

The maximum value (upper boundary) allowed for the DetailValue that is the parent of this element.

StandardDeviation

StandardDeviation is optional. A single instance might exist.

A statistic used as a measure of dispersion in a distribution.

SampleSize

SampleSize is optional. A single instance might exist.

The number of samples used to determine the product characteristic in question.

TwoSigmaLower

TwoSigmaLower is optional. A single instance might exist.

Two sigma (a measure of dispersion associated with standard deviation) on the lower side of the standard deviation.

TwoSigmaUpper

TwoSigmaUpper is optional. A single instance might exist.

Two sigma (a measure of dispersion associated with standard deviation) on the upper side of the standard deviation.

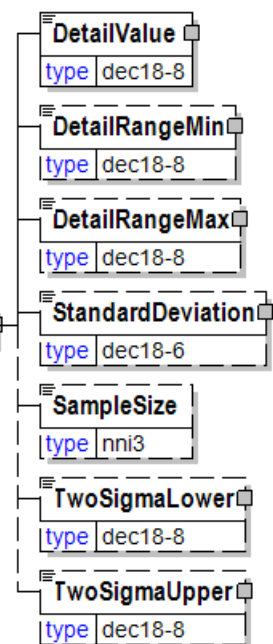

Gutter

Gutter

Bleed [attribute]

Bleed is optional. A single instance might exist.

Specifies if the printing of an illustration, design, or text to the edge of the page.

Refer to Bleed definition for any enumerations.

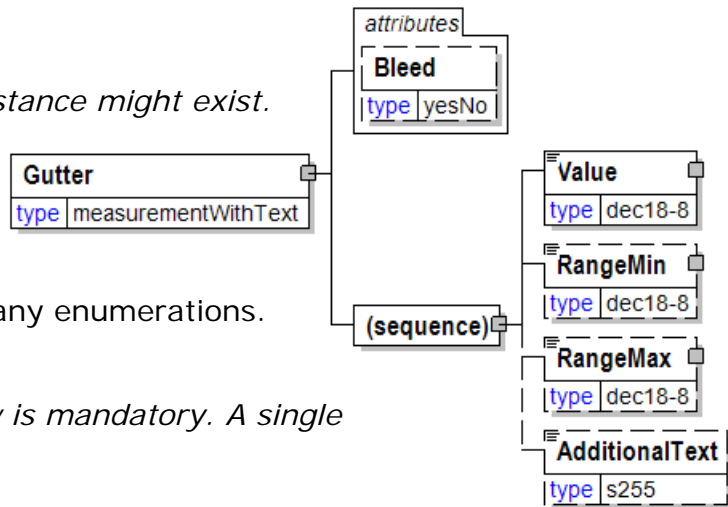

(sequence)

The sequence of items below is mandatory. A single instance is required.

Value

Value is mandatory. A single instance is required.

A numeric value expressed in the unit of measure (UOM).

RangeMin

RangeMin is optional. A single instance might exist.

The minimum value (lower boundary) allowed for the Measurement that is the parent of this element.

RangeMax

RangeMax is optional. A single instance might exist.

The maximum value (upper boundary) allowed for the Measurement that is the parent of this element. Some elements use the RangeMax element with an extended list of unit of measures. (Note: the red colour in the picture is an artifact of how the graphic was captured and should be disregarded.)

AdditionalText

AdditionalText is optional. A single instance might exist.

A text field that is used to communicate information not previously defined or for special instructions. To be used only for circumstances not covered by specific elements.

Gypsum

A placeholder for further definition of gypsum items.

(sequence)

The sequence of items below is mandatory. A single instance is required.

[Any Type]

Any type of content is permitted at this point.

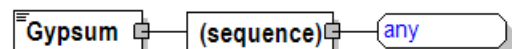

Halftones

Halftones are images made up of a series of dots in a specific pattern that simulates the look of a continuous tone image.

IsHalftones [attribute]

IsHalftones is mandatory. A single instance is required.

Indicates if the images are halftones or not.

(sequence)

The sequence of items below is mandatory. A single instance is required.

Value

Value is optional. Multiple instances might exist

A numeric value expressed in the unit of measure (UOM).

AdditionalText

AdditionalText is optional. Multiple instances might exist.

A text field that is used to communicate information not previously defined or for special instructions. To be used only for circumstances not covered by specific elements.

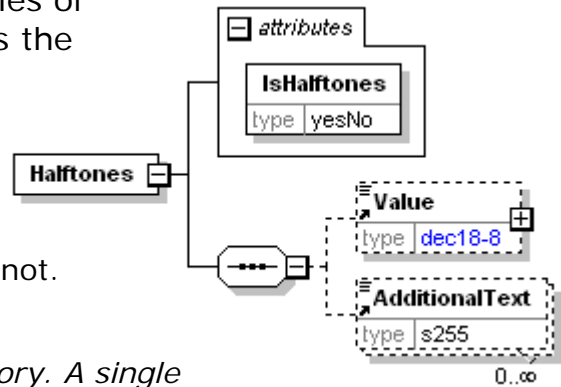

HardwoodLumber

Product structure for solid wood products made of hardwood.

(sequence)

The sequence of items below is mandatory. A single instance is required.

HardwoodLumberCharacteristics

HardwoodLumberCharacteristics is mandatory. A single instance is required.

A group item that organises the hardwood lumber –product information.

Packaging

Packaging is optional. A single instance might exist.

Type of a package that includes individual products.

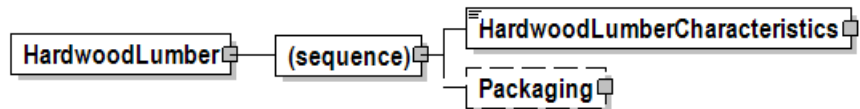

HardwoodLumberCharacteristics

A group item that organises the hardwood lumber –product information.

(sequence)

The sequence of items below is mandatory. A single instance is required.

[Any Type]

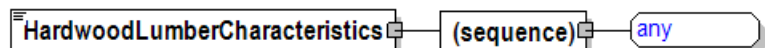

Any type of content is permitted at this point.

Head

Head.

Bleed [attribute]

Bleed is optional. A single instance might exist.

Specifies if the printing of an illustration, design, or text to the edge of the page.

Refer to Bleed definition for any enumerations.

(sequence)

The sequence of items below is mandatory. A single instance is required.

Value

Value is mandatory. A single instance is required.

A numeric value expressed in the unit of measure (UOM).

RangeMin

RangeMin is optional. A single instance might exist.

The minimum value (lower boundary) allowed for the Measurement that is the parent of this element.

RangeMax

RangeMax is optional. A single instance might exist.

The maximum value (upper boundary) allowed for the Measurement that is the parent of this element. Some elements use the RangeMax element with an extended list of unit of measures. (Note: the red colour in the picture is an artifact of how the graphic was captured and should be disregarded.)

AdditionalText

AdditionalText is optional. A single instance might exist.

A text field that is used to communicate information not previously defined or for special instructions. To be used only for circumstances not covered by specific elements.

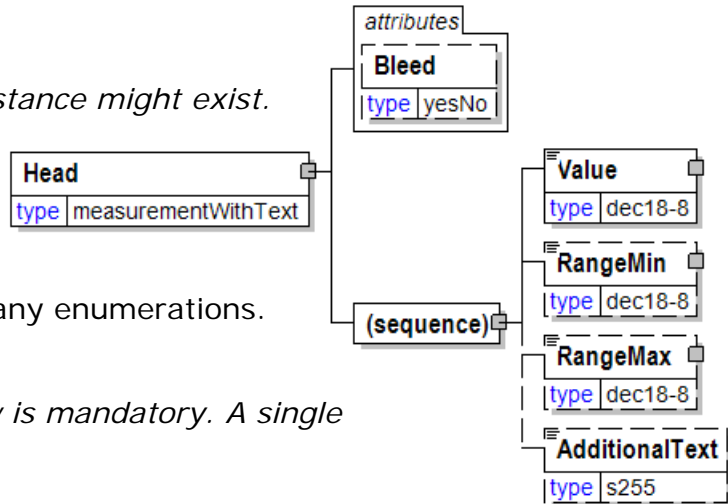

Headband

Headband.

BandLocationType [attribute]

BandLocationType is optional. A single instance might exist.

Band location type

Refer to BandLocationType definition for any enumerations.

(sequence)

The sequence of items below is mandatory. A single instance is required.

ColourCode

ColourCode is optional. A single instance might exist.

A code indicating the colour.

ColourDescription

ColourDescription is optional. A single instance might exist.

A free form description of the colour.

BandMaterial

BandMaterial is optional. A single instance might exist.

Band material

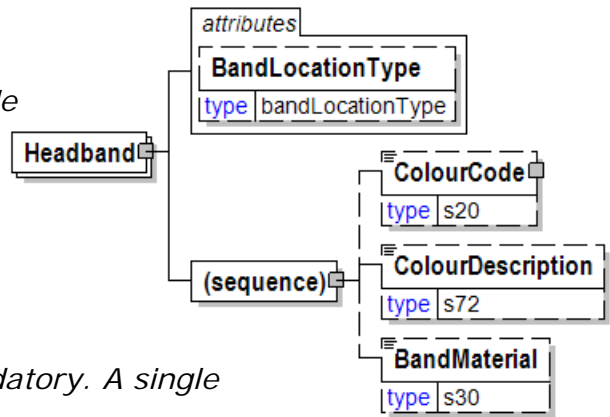

HeatTreatment

Defines the heat treatment method.

HeatTreatmentType [attribute]

HeatTreatmentType is optional. A single instance might exist.

Defines the standard to which to product has been heat treated.

Refer to HeatTreatmentType definition for any enumerations.

(sequence)

The sequence of items below is mandatory. A single instance is required.

AdditionalText

AdditionalText is optional. Multiple instances might exist.

A text field that is used to communicate information not previously defined or for special instructions. To be used only for circumstances not covered by specific elements.

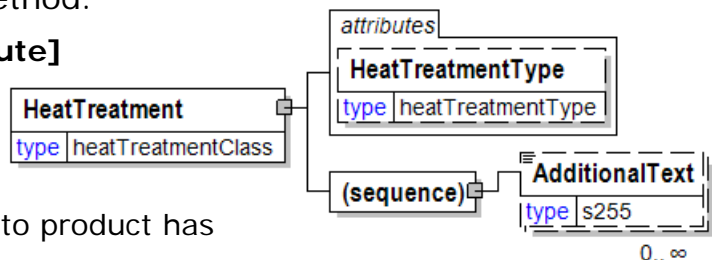

HeatTreatmentType [attribute]

Defines the standard to which to product has been heat treated.

This item is restricted to the following list.

- HT
- HTC/NHTNC
- KD56/30

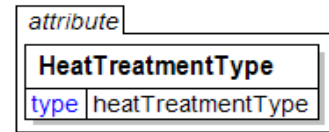

Height

The height of the object. (Used in wood/timber items.)

ActualNominal [attribute]

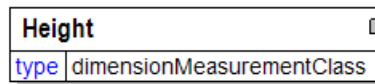

ActualNominal is optional. A single instance might exist.

Indicates the measurement approach used to communicate the dimensions of the individual pieces.

Refer to ActualNominal definition for any enumerations.

(choice)

[choice] is optional because of choice construct.

Value

Value is optional because of choice construct.

A numeric value expressed in the unit of measure (UOM).

(sequence)

The sequence of items below is mandatory. A single instance is required.

RangeMin

RangeMin is optional. A single instance might exist.

The minimum value (lower boundary) allowed for the Measurement that is the parent of this element.

RangeMax

RangeMax is optional. A single instance might exist.

The maximum value (upper boundary) allowed for the Measurement that is the parent of this element. Some elements use the RangeMax element with an extended list of unit of measures. (Note: the red colour in the picture is an artifact of how the graphic was captured and should be disregarded.)

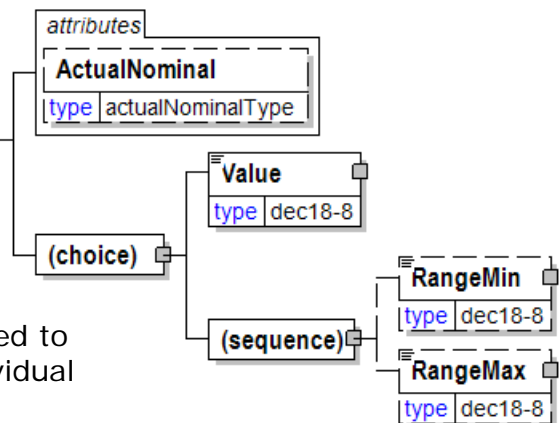

Height

The height of the object.

(sequence)

The sequence of items below is mandatory. A single instance is required.

Value

Value is mandatory. A single instance is required.

A numeric value expressed in the unit of measure (UOM).

RangeMin

RangeMin is optional. A single instance might exist.

The minimum value (lower boundary) allowed for the Measurement that is the parent of this element.

RangeMax

RangeMax is optional. A single instance might exist.

The maximum value (upper boundary) allowed for the Measurement that is the parent of this element. Some elements use the RangeMax element with an extended list of unit of measures. (Note: the red colour in the picture is an artifact of how the graphic was captured and should be disregarded.)

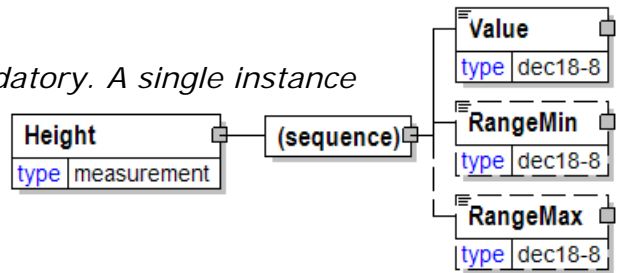

HighlightedPlanningBucket

Provides an indication and information that the planning bucket should be reviewed.

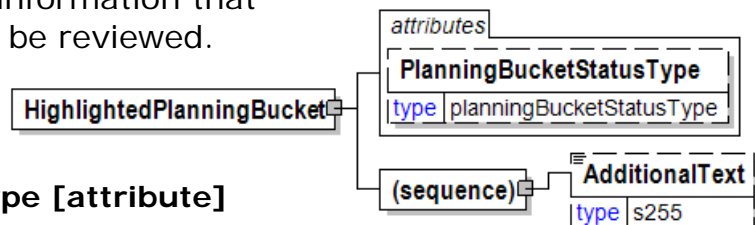

PlanningBucketStatusType [attribute]

PlanningBucketStatusType is optional. A single instance might exist.

Used to identify the Planning bucket's status. Typically used to highlight a change in status to the receiver of the e-Document.

Refer to PlanningBucketStatusType definition for any enumerations.

(sequence)

The sequence of items below is mandatory. A single instance is required.

AdditionalText

AdditionalText is optional. A single instance might exist.

A text field that is used to communicate information not previously defined or for special instructions. To be used only for circumstances not covered by specific elements.

HolePunchInformation

Hole Punch Information.

HolePunchThroughCover [attribute]

HolePunchThroughCover is optional. A single instance might exist.

Either "Yes" or "No".

Refer to HolePunchThroughCover definition for any enumerations.

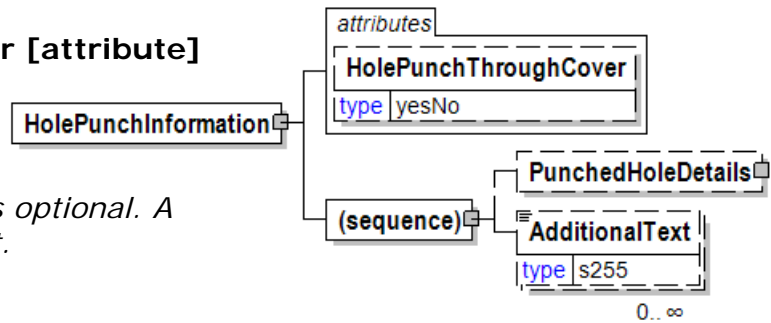

(sequence)

The sequence of items below is mandatory. A single instance is required.

PunchedHoleDetails

PunchedHoleDetails is optional. A single instance might exist.

A grouping element that will contain the configuration information for punched holes.

AdditionalText

AdditionalText is optional. Multiple instances might exist.

A text field that is used to communicate information not previously defined or for special instructions. To be used only for circumstances not covered by specific elements.

HolePunchTemplateReference

Hole punch template reference

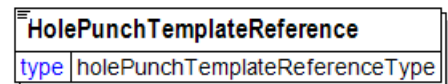

HolePunchThroughCover [attribute]

Either "Yes" or "No".

This item is restricted to the following list.

Yes

No

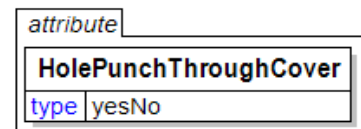

HolePunchType

Hole punch type.

This item is restricted to the following list.

DIN2

DIN4

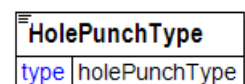

Finnish
Swedish
Any

HoleReinforcement

Hole reinforcement

This item is restricted to the following list.

Yes
No

HoleReinforcement
type yesNo

HoleSpacing

The HoleSpacing element is used to communicate the distance between holes.

(choice)

[choice] is optional because of choice construct.

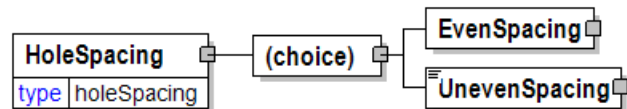

EvenSpacing

EvenSpacing is optional because of choice construct.

The EvenSpacing element is used to communicate the hole-spacing that is equivalent between the holes. The initial spacing between the paper edge and the first hole is handled using the DistanceFromEdge element.

UnevenSpacing

UnevenSpacing is optional because of choice construct.

Uneven Spacing

Hours

A qualifier of DeliveryTransitTime.

Hours
type nni6

HSB

A definition of colour using the HSB protocol.

All the components of the definition are required. The structure of Hue, Saturation, and Brilliance follows DetailMeasurement.

TestMethod [attribute]

TestMethod is optional. A single instance might exist.

The method used to determine the results of the test under consideration.

TestAgency [attribute]

TestAgency is optional. A single instance might exist.

The agency that has set the parameters for the testing

Refer to TestAgency definition for any enumerations.

SampleType [attribute]

SampleType is optional. A single instance might exist.

Communicates how sampling was done to measure the product characteristics.

Refer to SampleType definition for any enumerations.

ResultSource [attribute]

ResultSource is optional. A single instance might exist.

Used to define the data source of the specified test

Refer to ResultSource definition for any enumerations.

(sequence)

The sequence of items below is mandatory. A single instance is required.

Hue

Hue is mandatory. A single instance is required.

Measure of colour Hue in the HSB method of communicating colour.

Saturation

Saturation is mandatory. A single instance is required.

Measure of colour Saturation in the HSB method of communicating colour.

Brilliance

Brilliance is mandatory. A single instance is required.

Measure of brilliance in the HSB colour approach.

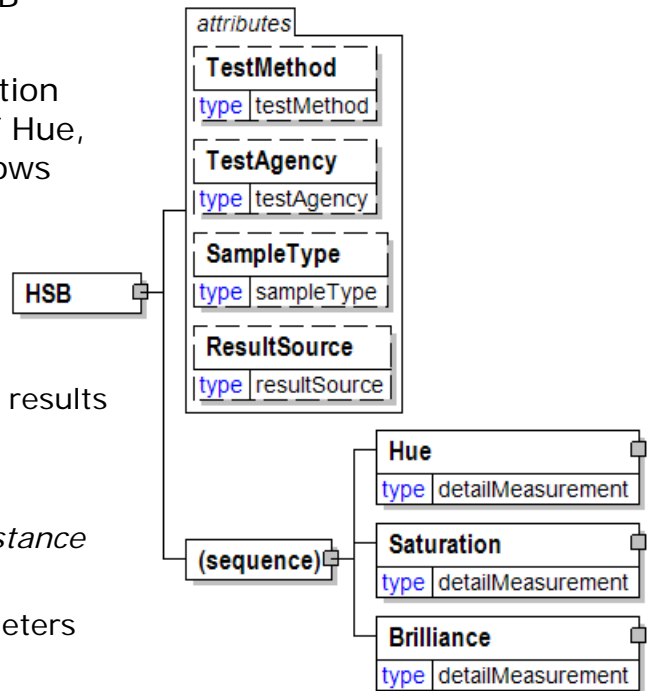

Hue

Measure of colour Hue in the HSB method of communicating colour.

(sequence)

The sequence of items below is mandatory. A single instance is required.

DetailValue

DetailValue is mandatory. A single instance is required.

A numeric value expressed in the unit of measure (UOM).

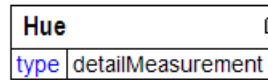

DetailRangeMin

DetailRangeMin is optional. A single instance might exist.

The minimum value (lower boundary) allowed for the DetailValue that is the parent of this element.

DetailRangeMax

DetailRangeMax is optional. A single instance might exist.

The maximum value (upper boundary) allowed for the DetailValue that is the parent of this element.

StandardDeviation

StandardDeviation is optional. A single instance might exist.

A statistic used as a measure of dispersion in a distribution.

SampleSize

SampleSize is optional. A single instance might exist.

The number of samples used to determine the product characteristic in question.

TwoSigmaLower

TwoSigmaLower is optional. A single instance might exist.

Two sigma (a measure of dispersion associated with standard deviation) on the lower side of the standard deviation.

TwoSigmaUpper

TwoSigmaUpper is optional. A single instance might exist.

Two sigma (a measure of dispersion associated with standard deviation) on the upper side of the standard deviation.

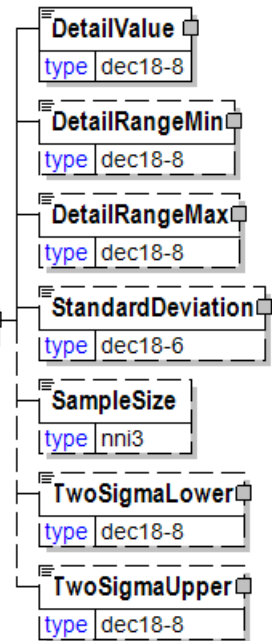

Humidity

Humidity

(sequence)

The sequence of items below is mandatory. A single instance is required.

Value

Value is mandatory. A single instance is required.

A numeric value expressed in the unit of measure (UOM).

RangeMin

RangeMin is optional. A single instance might exist.

The minimum value (lower boundary) allowed for the Measurement that is the parent of this element.

RangeMax

RangeMax is optional. A single instance might exist.

The maximum value (upper boundary) allowed for the Measurement that is the parent of this element. Some elements use the RangeMax element with an extended list of unit of measures. (Note: the red colour in the picture is an artifact of how the graphic was captured and should be disregarded.)

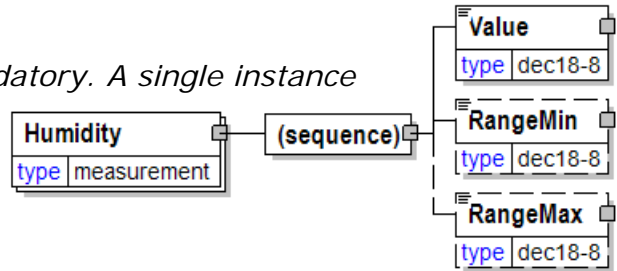

Identifier

An Identifier is required for packages and items (pallets, reel packages, boxes, ream items, reel items, etc). The Identifier element contains the actual item identifier code. Identifier is repeatable so more than one identifier can be communicated. For example, the printed identifier on a label may be different from the barcode printed on the label.

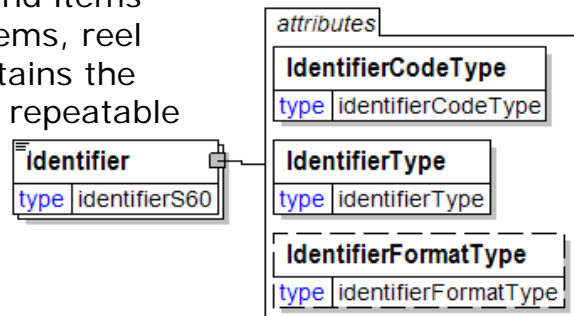

IdentifierCodeType [attribute]

IdentifierCodeType is mandatory. A single instance is required.

Defines the type of product identifier used (for example, reel number, ream number, bar code). This code type specifies how to decode the identifier value.

Refer to IdentifierCodeType definition for any enumerations.

IdentifierType [attribute]

IdentifierType is mandatory. A single instance is required.

This attribute specifies whether the Identifier is the primary way to identify the product or a secondary way. Only one of the given identifiers can be primary. In addition, this attribute also specifies the physical support used to code the identifier (for example, a Radio Frequency (RF) Tag).

Refer to IdentifierType definition for any enumerations.

IdentifierFormatType [attribute]

IdentifierFormatType is optional. A single instance might exist.

IdentifierFormatType defines the technical format used to make an IdentifierCodeType readable by technical devices or humans. The IdentifierCodeType specifies how to decode the identifier value

Refer to IdentifierFormatType definition for any enumerations.

IdentifierCodeType [attribute]

Defines the type of product identifier used (for example, reel number, ream number, bar code). This code type specifies how to decode the identifier value.



This item is restricted to the following list.

Carrier

Carrier's own identifier coding scheme.

EAN8

European Article Number coded on 8 digits.

EAN8Plus2

EAN8Plus5

EAN13

European Article Number coded on 13 digits.

EAN13Plus2

EAN13Plus8

EAN128

EPSMA

European Association for Pressure Sensitive LabelStock Manufacturers

EUGROPA

European Paper Merchants Association code.

GlobalReturnableAssetNumber

The EAN.UCC Global Returnable Asset Number

GlobalTradeItemNumber

The EAN.UCC Global Trade Item Number

IFRA

IFRA Bar Code using 16 digits and the Interleaved 2/5 symbols.

ISBN10

10 digit ISBN code without dashes

ISBN10Dash

10 digit ISBN code with dashes

ISBN13

13 digit ISBN code.

ISBN13Dash**Measurer**

Measurer's own identifier coding scheme.

NARI

North American Roll Identifier coded on 13 digits, and using the Code 39 symbols.

NPTA

National Paper Trade Association code.

RFTagSerialNumber**SerializedShippingContainerCode**

The EAN.UCC Serialized Shipping Container Code

Supplier

Supplier's own identifier coding scheme.

TAPPI 13

TAPPI 13-character identifier coding scheme.

TAPPI 9

TAPPI 9-character identifier coding scheme.

UCCEAN128SSCC**UCCEANMulti****UIC14**

The CEPI Unit identifier coded on 14 digits. When the CEPI Unit Identifier is used in bar code format, then the symbology must be Code 128C to European Standard EN 799. This is the official European identifier by CEPI. More info at www.cepi.org.

UIC16

To be deprecated in future version. Use instead UIC14. UIC16 was the CEPI Unit identifier coded on 16 digits. UIC16 is no longer supported by CEPI.

UPC

Universal Product Code administered by the Universal Code Council. Note: There are several formats used for this coding scheme.

UPC_A**UPC_A_Plus2****UPC_A_Plus5****UPC_E****UPC_E_Plus2****UPC_E_Plus5****UPC_ShippingContainer**

IdentifierFormatType [attribute]

IdentifierFormatType defines the technical format used to make an IdentifierCodeType readable by technical devices or humans. The IdentifierCodeType specifies how to decode the identifier value

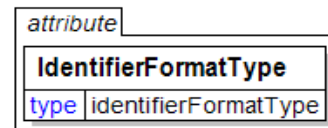

This item is restricted to the following list.

- Codabar**
- CodablockA**
- CodablockF**
- Code11**
- Code16K**
- Code2/5Beared**
- Code2/5Industrial**
- Code2/5Interleaved**
- Code2/5InterleavedMod10**
- Code2/5MatrixEurope**
- Code2/5MatrixJapan**
- Code2/5Standard**
- Code39**
- Code39F.ASCII**
- Code39Mod43**
- Code93**
- Code128Auto-Switching**
- Code128A**
- Code128B**
- Code128C**
- Code128C(F1Mod10)**
- Composite**
- Datamatrix**
- EAN8**
- EAN8Plus2**
- EAN8Plus5**
- EAN13**
- EAN13Plus2**
- EAN13Plus8**
- EAN128**

HumanReadable
IBM_BC412
ITF14
Logmars
MicroPDF14
PDF417
Plessey
Postnet
QR_Code
RSS
TLC39
UPC_A
UPC_A_Plus2
UPC_A_Plus5
UPC_E
UPC_E_Plus2
UPC_E_Plus5
UCCEAN128SSCC
UCCEAN128Multi
UPC_ShippingContainer
Other

IdentifierType [attribute]

This attribute specifies whether the Identifier is the primary way to identify the product or a secondary way. Only one of the given identifiers can be primary. In addition, this attribute also specifies the physical support used to code the identifier (for example, a Radio Frequency (RF) Tag).

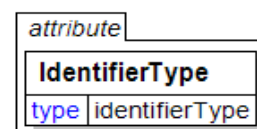

This item is restricted to the following list.

Barcode

The physical support used to code the identifier is a bar code.

CorrelationID

Correlation ID

Primary

This article Identifier is the primary identifier used.

RFTag

The physical support used to code the identifier is a Radio Frequency Tag.

Secondary

This article Identifier is the secondary identifier used.

Impressions

The work produced by one revolution of the printing cylinder or unit.

(sequence)

The sequence of items below is mandatory. A single instance is required.

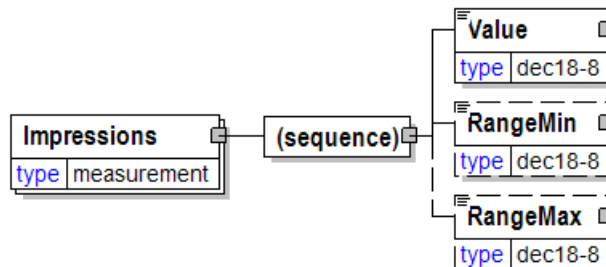

Value

Value is mandatory. A single instance is required.

A numeric value expressed in the unit of measure (UOM).

RangeMin

RangeMin is optional. A single instance might exist.

The minimum value (lower boundary) allowed for the Measurement that is the parent of this element.

RangeMax

RangeMax is optional. A single instance might exist.

The maximum value (upper boundary) allowed for the Measurement that is the parent of this element. Some elements use the RangeMax element with an extended list of unit of measures. (Note: the red colour in the picture is an artifact of how the graphic was captured and should be disregarded.)

Incoterms [attribute]

The Incoterms consist of a number official international trade terms defined by International Chamber of Commerce (ICC) plus an additional term called Other. Actual trade terms used are depending on the version of the Incoterms. The Incoterms define the responsibilities of buyers and sellers for delivery under a sales contract. They provide definitions for delivery points, loading and unloading obligations, and customs clearance. (<http://www.iccwbo.org/incoterms>)

This item is restricted to the following list.

CFR

COST AND FREIGHT (... named port of destination)

CIF

COST, INSURANCE AND FREIGHT (... named port of destination).

CIP

CARRIAGE AND INSURANCE PAID TO (... named place of destination).

CPT

CARRIAGE PAID TO (... named place of destination).

DAF

DELIVERED AT FRONTIER (... named place).

DAP

DELIVERED AT PLACE (... named place of destination).

DAT

DELIVERED AT TERMINAL (... named place of destination).

DDP

DELIVERED DUTY PAID (... named place of destination).

DDU

DELIVERED DUTY UNPAID (... named place of destination).

DEQ

DELIVERED EX QUAY (... named port of destination).

DES

DELIVERED EX SHIP (... named port of destination).

EXW

EX WORKS (... named place).

FAS

FREE ALONGSIDE SHIP (... named port of shipment).

FCA

FREE CARRIER (... named place).

FOB

FREE ON BOARD (... named port of shipment).

Other

Used when the situation is not covered by the 13 official Incoterms (for example, CIN used in Switzerland for CIP)

IncotermsLocation

Place linked to terms of delivery showing the place where goods are to be delivered.

Incoterms [attribute]

Incoterms is mandatory. A single instance is required.

The Incoterms consist of 13 official international trade terms plus an additional term called Other. The Incoterms define the responsibilities of buyers and sellers for delivery under a sales contract. They provide definitions for delivery points, loading and unloading obligations, and customs clearance.

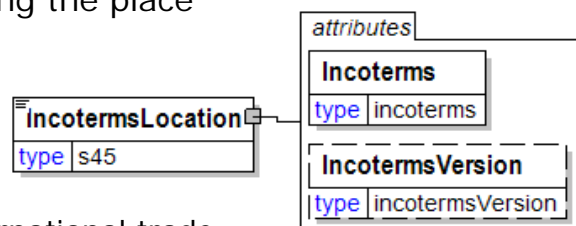

Refer to Incoterms definition for any enumerations.

IncotermsVersion [attribute]

IncotermsVersion is optional. A single instance might exist.

The version of the IncoTerms codes used.

Refer to IncotermsVersion definition for any enumerations.

IncotermsVersion [attribute]

The version of the IncoTerms codes used.

This item is restricted to the following list.

1980

The incoterms definitions provided in 1980.

1990

The incoterms definitions provided in 1990.

2000

The incoterms definitions provided in 2000.

2010

The incoterms definitions provided in 2010

20xx

The next group of incoterms definitions anticipated to be provided in 2020. When they are actually released this list will be updated and "20xx" will be used for the next scheduled release..

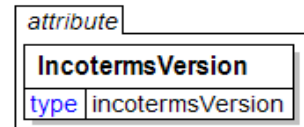

IncrementalOrderQuantity

An incremental quantity and units of measure that is added to MinimumOrderQuantity to arrive at an order quantity.

(sequence)

The sequence of items below is mandatory. A single instance is required.

Quantity

Quantity is mandatory. A single instance is required.

The Quantity element contains attributes that provide information about the type of quantity that is being communicated, the context in which the particular quantity is to be viewed, and (if the quantity represents an adjustment) an adjustment type.

The Quantity element contains three child elements that enable you to communicate a range of values for the quantity and a target or actual value. It is at this level (Value, RangeMin, and RangeMax) that the unit of measure is specified. This permits the range to be specified in a different unit of measure than the target.

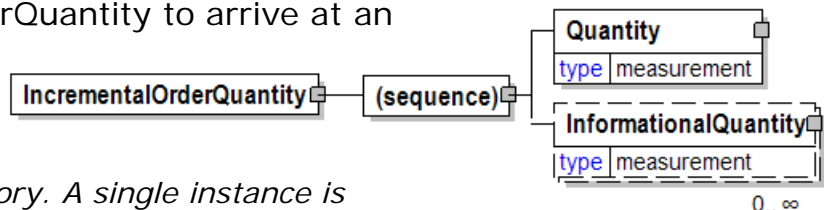

InformationalQuantity

InformationalQuantity is optional. Multiple instances might exist.

A quantity given in a valid UOM used for information purposes only (not for calculation). For example, an ordered quantity was 100 reels as opposed to the invoice quantity of 20,000 pounds.

IncrementalValue

Many times paper is produce in BasisWeights of discreet values. This element permits the expression of those increments.

UOM [attribute]

UOM is mandatory. A single instance is required.

Defines the unit of measure for the value.

Refer to UOM definition for any enumerations.

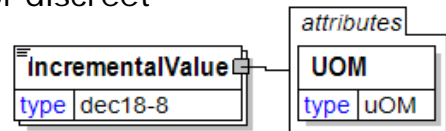

InfoRequest

The InfoRequest element is the root element for the InfoRequest e-Document.

The purpose of InfoRequest e-Document is to allow the

requesting party to request from the receiver party an update. The e-Documents that may be returned in response to an InfoRequest are the Availability, Calendar, InventoryStatus, OrderStatus, Planning, ProductQuality, ShipmenStatus, ShippingInstructions or Statement.

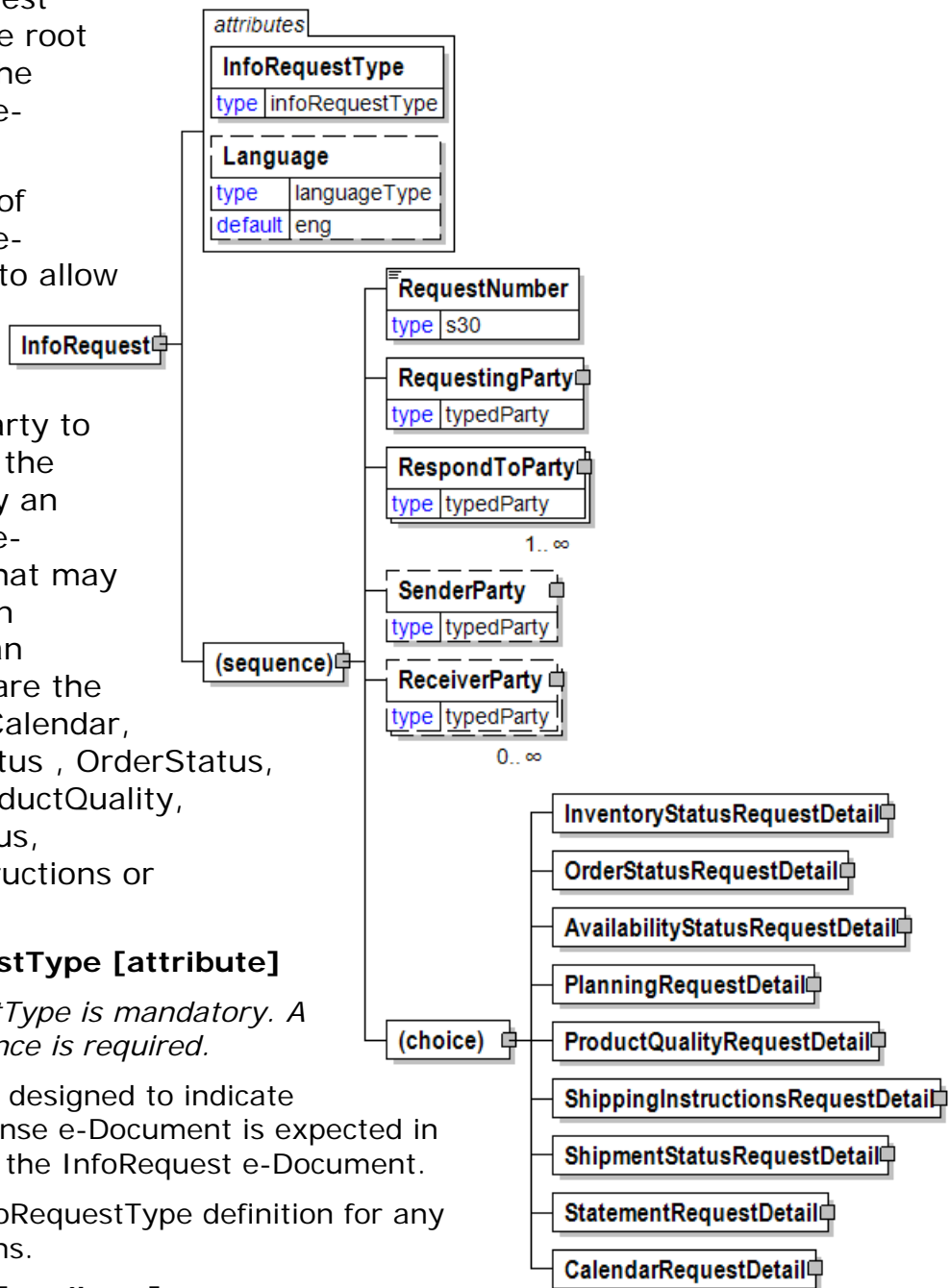

InfoRequestType [attribute]

InfoRequestType is mandatory. A single instance is required.

An attribute designed to indicate which response e-Document is expected in response to the InfoRequest e-Document.

Refer to InfoRequestType definition for any enumerations.

Language [attribute]

Language is optional. A single instance might exist.

XML has embraced 2 and 3 digit language codes through the application of an addendum to the standard.

Refer to Language definition for any enumerations.

(sequence)

The sequence of items below is mandatory. A single instance is required.

RequestNumber

RequestNumber is mandatory. A single instance is required.

A unique tracking number specifically identifying the InfoRequest e-Document to

the originator. The tracking number is returned with the "information", the answer, to help match the answer to the request.

RequestingParty

RequestingParty is mandatory. A single instance is required.

The party requesting the information.

RespondToParty

RespondToParty is mandatory. One instance is required, multiple instances might exist.

The party the document should be responded to.

SenderParty

SenderParty is optional. A single instance might exist.

The business entity issuing the e-Document, the source of the document.

The entity responsible for the content. If the sender party has out sourced the message service to a third party the SenderParty is the issuer of the e-Document and not the party performing the transmission service of the electronic message.

ReceiverParty

ReceiverParty is optional. Multiple instances might exist.

The business entity for whom the e-Document is intended, the destination of the document.

The entity interested in the content. If the receiver party has outsourced the message service to a third party the ReceiverParty is the intended party for the e-Document and not the party performing the receiving service of the electronic message.

(choice)

[choice] is optional because of choice construct.

InventoryStatusRequestDetail

InventoryStatusRequestDetail is optional because of choice construct.

A grouping element that provides the parameters to be used when responding with an InventoryStatus e-Document.

OrderStatusRequestDetail

OrderStatusRequestDetail is optional because of choice construct.

A grouping element that provides the parameters to be used when responding with an OrderStatus e-Document.

AvailabilityStatusRequestDetail

AvailabilityStatusRequestDetail is optional because of choice construct.

A grouping element that provides the parameters to be used when responding with an Availability e-Document.

PlanningRequestDetail

PlanningRequestDetail is optional because of choice construct.

A grouping element that provides the parameters to be used when responding with a Planning e-Document.

ProductQualityRequestDetail

ProductQualityRequestDetail is optional because of choice construct.

A grouping element that provides the parameters to be used when responding with a ProductQuality e-Document.

ShippingInstructionsRequestDetail

ShippingInstructionsRequestDetail is optional because of choice construct.

A grouping element that provides the parameters to be used when responding with a ShippingInstructions e-Document.

ShipmentStatusRequestDetail

ShipmentStatusRequestDetail is optional because of choice construct.

A grouping element that provides the parameters to be used when responding with a ShipmentStatus e-Document.

StatementRequestDetail

StatementRequestDetail is optional because of choice construct.

A grouping element that provides the parameters to be used when responding with a Statement e-Document.

CalendarRequestDetail

CalendarRequestDetail is optional because of choice construct.

A grouping element that provides the parameters to be used when responding with a Calendar e-Document.

InfoRequestType [attribute]

An attribute designed to indicate which response e-Document is expected in response to the InfoRequest e-Document.

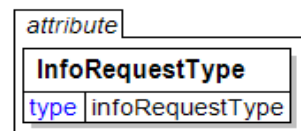

This item is restricted to the following list.

Availability

The sender is requesting Availability information.

Calendar

The sender is requesting Calendar information.

InventoryStatus

The sender is requesting InventoryStatus information.

OrderStatus

The sender is requesting OrderStatus information.

Planning

The sender is requesting Planning information.

ProductQuality

The sender is requesting ProductQuality information.

ShipmentStatus

The sender is requesting ShipmentStatus information.

ShippingInstructions

The sender is requesting ShippingInstructions information.

Statement

The sender is requesting a Statement.

InformationalAmount

A monetary amount used for information purposes only (not for calculation). For example, the invoice price adjustment subtotal is expressed in sterling pounds, and the buyer wants this information expressed in U.S. dollars.

CreditDebitNote and Invoice - The TaxAmount is displayed in the currency that is applicable throughout the e-Document. When a TaxAmount needs to be displayed in a different national currency, this field is used.

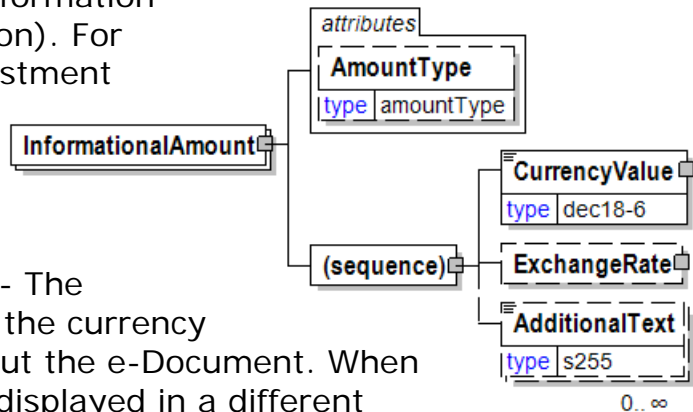

AmountType [attribute]

AmountType is optional. A single instance might exist.

Defines the type of amount.

Refer to AmountType definition for any enumerations.

(sequence)

The sequence of items below is mandatory. A single instance is required.

CurrencyValue

CurrencyValue is mandatory. A single instance is required.

The amount in the referenced currency as defined by the CurrencyType attribute.

ExchangeRate

ExchangeRate is optional. A single instance might exist.

The exchange rate as of the date included in the element.

AdditionalText

AdditionalText is optional. Multiple instances might exist.

A text field that is used to communicate information not previously defined or for special instructions. To be used only for circumstances not covered by specific elements.

InformationalPricePerUnit

A group item containing a currency value and a measurement value used convey a secondary PricePerUnit. For example, where PricePerUnit is dollars per ton. InformationalPricePerUnit could be dollars per kilogram.

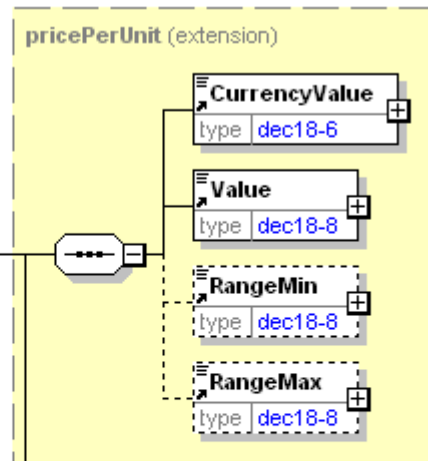
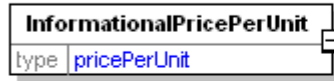

InformationalPricePerUnitType [attribute]

Defines what type of Price is being supplied.

Refer to InformationalPricePerUnit for any enumerations

(sequence)

The sequence of items below is mandatory. A single instance is required.

CurrencyValue

CurrencyValue is mandatory. A single instance is required.

The amount in the referenced currency as defined by the CurrencyType attribute.

Value

Value is mandatory. A single instance is required.

A numeric value expressed in the unit of measure (UOM).

RangeMin

RangeMin is optional. A single instance might exist.

The minimum value (lower boundary) allowed for the Measurement that is the parent of this element.

RangeMax

RangeMax is optional. A single instance might exist.

The maximum value (upper boundary) allowed for the Measurement that is the parent of this element. Some elements use the RangeMax element with an extended list of unit of measures. (Note: the red colour in the picture is an artifact of how the graphic was captured and should be disregarded.)

InformationalPricePerUnitType [attribute]

Defines what type of Price is being supplied.

This item is restricted to the following list.

AlternatePrice

Alternate price calculated by the Buyer.

CoverPrice



Price that appears on the cover of a book.

ProductPrice

Price for the product specified in the Product element in the e-Document.

ProductionPrice

Price calculated by the Buyer's Production department.

InformationalQuantity

A quantity given in a valid UOM used for information purposes only (not for calculation). For example, an ordered quantity was 100 reels as opposed to the invoice quantity of 20,000 pounds.

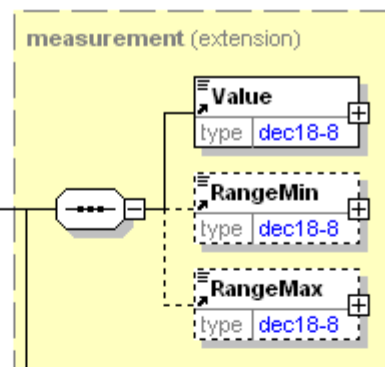

QuantityType [attribute]

QuantityType is mandatory. A single instance is required.

QuantityType communicates information about the type of quantity being communicated and how the receiver might use the information.

Refer to QuantityType definition for any enumerations.

QuantityTypeContext [attribute]

QuantityTypeContext is optional. A single instance might exist.

Provides the location in the value chain where the quantity is being reported.

Refer to QuantityTypeContext definition for any enumerations.

AdjustmentType [attribute]

AdjustmentType is optional. A single instance might exist.

Describes the type of adjustment associated with a quantity.

Refer to AdjustmentType definition for any enumerations.

MeasuringMethodType [attribute]

MeasuringMethodType is optional. A single instance might exist.

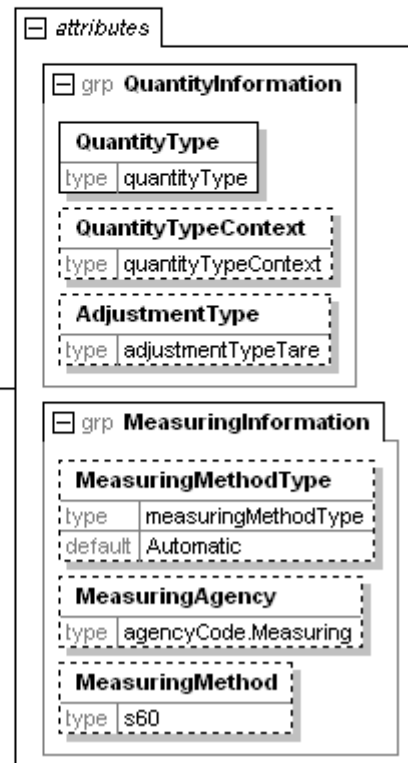

Specifies how a measurement value is created.

Refer to MeasuringMethodType definition for any enumerations.

MeasuringAgency [attribute]

MeasuringAgency is optional. A single instance might exist.

The agency defining measuring methods.

Refer to MeasuringAgency definition for any enumerations.

MeasuringMethod [attribute]

MeasuringMethod is optional. A single instance might exist.

The method used to determine how the item under consideration is measured. Measuring methods are defined by the measuring agency.

(sequence)

The sequence of items below is mandatory. A single instance is required.

Value

Value is mandatory. A single instance is required.

A numeric value expressed in the unit of measure (UOM).

RangeMin

RangeMin is optional. A single instance might exist.

The minimum value (lower boundary) allowed for the Measurement that is the parent of this element.

RangeMax

RangeMax is optional. A single instance might exist.

The maximum value (upper boundary) allowed for the Measurement that is the parent of this element. Some elements use the RangeMax element with an extended list of unit of measures. (Note: the red colour in the picture is an artifact of how the graphic was captured and should be disregarded.)

Ink

A grouping element that describes the ink used in the process.

(sequence)

The sequence of items below is mandatory. A single instance is required.

InkManufacturer

InkManufacturer is optional. A single instance might exist.

Company that produced the ink used in the job.

ColourCode

ColourCode is optional. A single instance might exist.

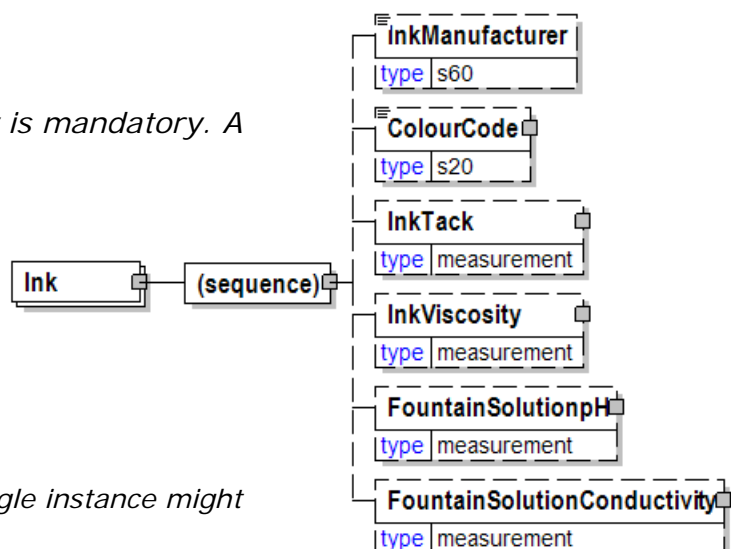

A code indicating the colour.

InkTack

InkTack is optional. A single instance might exist.

The stickiness of the ink.

InkViscosity

InkViscosity is optional. A single instance might exist.

The measured thickness of the ink.

FountainSolutionpH

FountainSolutionpH is optional. A single instance might exist.

Measurement of the acidic properties of the fountain solution.

FountainSolutionConductivity

FountainSolutionConductivity is optional. A single instance might exist.

Electrical measure of fountain solution measured in micro – siemens.

InkCharacteristics

The ink characteristics.

Note: The child element, InkCoverage, will be deprecated from InkCharacteristics in an upcoming version. Use the instance of InkCoverage found in ColourSpecs.

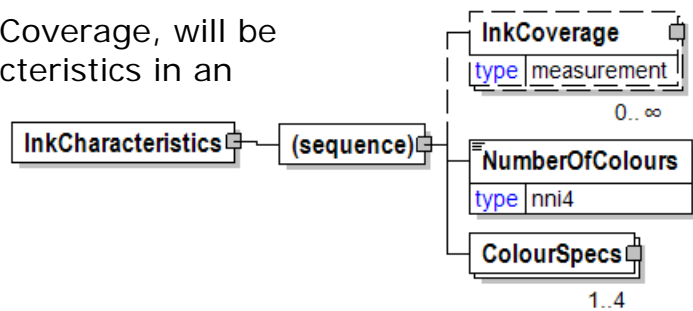

(sequence)

The sequence of items below is mandatory. A single instance is required.

InkCoverage

InkCoverage is optional. Multiple instances might exist.

Ink coverage

NumberOfColours

NumberOfColours is mandatory. A single instance is required.

The number of colours

ColourSpecs

ColourSpecs is mandatory.

Colour specs

InkCoverage

Ink coverage

InkCoverageType [attribute]

InkCoverageType is optional. A single instance might exist.

Ink coverage type

Refer to InkCoverageType definition for any enumerations.

(sequence)

The sequence of items below is mandatory. A single instance is required.

Value

Value is mandatory. A single instance is required.

A numeric value expressed in the unit of measure (UOM).

RangeMin

RangeMin is optional. A single instance might exist.

The minimum value (lower boundary) allowed for the Measurement that is the parent of this element.

RangeMax

RangeMax is optional. A single instance might exist.

The maximum value (upper boundary) allowed for the Measurement that is the parent of this element. Some elements use the RangeMax element with an extended list of unit of measures. (Note: the red colour in the picture is an artifact of how the graphic was captured and should be disregarded.)

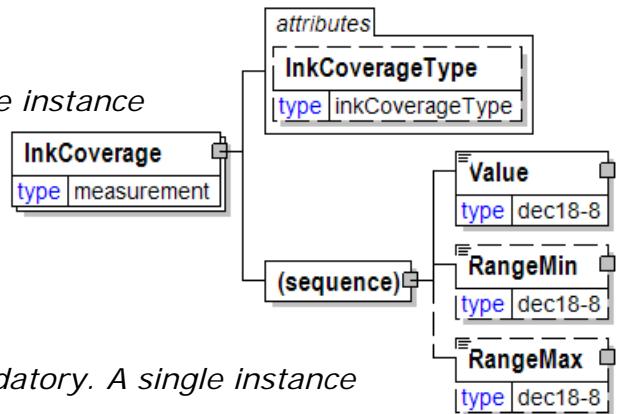

InkCoverageType [attribute]

Ink coverage type

This item is restricted to the following list.

AcrossFlap

FullBackground

Illustrations



InkDelivery

The delivery mechanism used in the printing process.

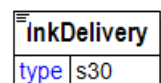

InkManufacturer

Company that produced the ink used in the job.

inkManufacturer
type s60

InkTack

The stickiness of the ink.

(sequence)

The sequence of items below is mandatory. A single instance is required.

Value

Value is mandatory. A single instance is required.

A numeric value expressed in the unit of measure (UOM).

RangeMin

RangeMin is optional. A single instance might exist.

The minimum value (lower boundary) allowed for the Measurement that is the parent of this element.

RangeMax

RangeMax is optional. A single instance might exist.

The maximum value (upper boundary) allowed for the Measurement that is the parent of this element. Some elements use the RangeMax element with an extended list of unit of measures. (Note: the red colour in the picture is an artifact of how the graphic was captured and should be disregarded.)

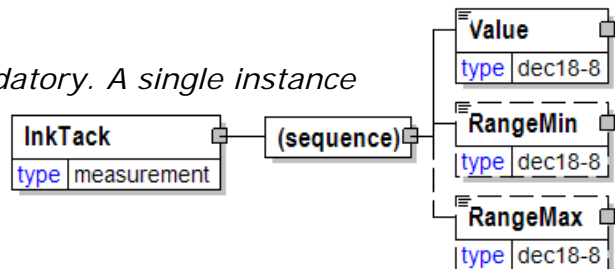

InkTypeDescription

Ink type description

inkTypeDescription
type s30

InkViscosity

The measured thickness of the ink.

(sequence)

The sequence of items below is mandatory. A single instance is required.

Value

Value is mandatory. A single instance is required.

A numeric value expressed in the unit of measure (UOM).

RangeMin

RangeMin is optional. A single instance might exist.

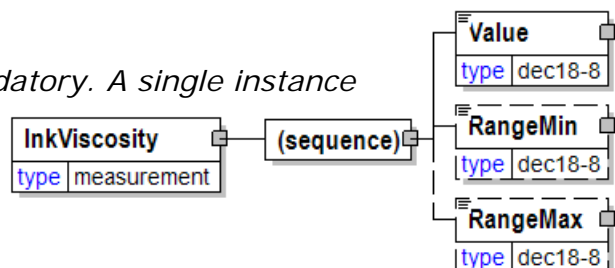

The minimum value (lower boundary) allowed for the Measurement that is the parent of this element.

RangeMax

RangeMax is optional. A single instance might exist.

The maximum value (upper boundary) allowed for the Measurement that is the parent of this element. Some elements use the RangeMax element with an extended list of unit of measures. (Note: the red colour in the picture is an artifact of how the graphic was captured and should be disregarded.)

InlayCardQuantity [attribute]

Inlay card quantity

This item is restricted to the following list.

0

There are zero inlay cards.

1

There is one inlay card.

2

There are two inlay cards.

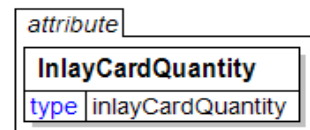

InsertReference

Insert reference

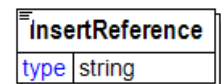

InstructionByType [attribute]

Provides the type for how goods are identified on group level when instructed for loading or delivery.

This item is restricted to the following list.

ByMillOrder

Goods are identified on group level by mill order and mill order line item.

ByProduct

Goods are identified on group level by a product specification with all required product details.

ByPurchaseOrder

Goods are identified on group level by PurchaseOrder and PurchaseOrder line item.

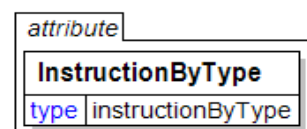

Insurance

Group element containing information about insurance

(sequence)

The sequence of items below is mandatory. A single instance is required.

Insurer

Insurer is optional. A single instance might exist.

Name of the insurer

InsuranceContractNo

InsuranceContractNo is optional. A single instance might exist.

Insurance contract number

InsuredValue

InsuredValue is optional. A single instance might exist.

The amount the goods are insured for.

InsuranceInfo

InsuranceInfo is optional. A single instance might exist.

Any addition information about the insurance

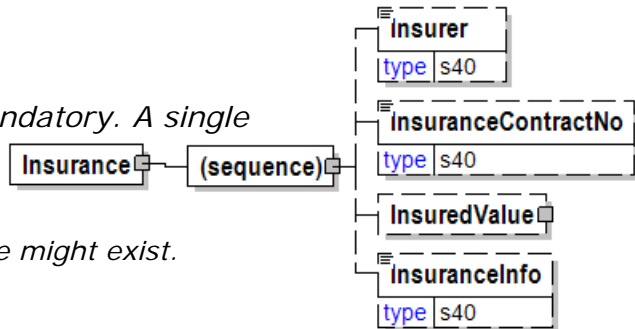

InsuranceContractNo

Insurance contract number

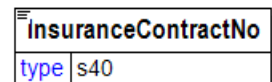

InsuranceInfo

Any addition information about the insurance

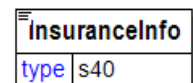

InsuredValue

The amount the goods are insured for.

(sequence)

The sequence of items below is mandatory. A single instance is required.

CurrencyValue

CurrencyValue is mandatory. A single instance is required.

The amount in the referenced currency as defined by the CurrencyType attribute.

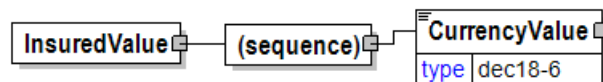

Insurer

Name of the insurer

insurer	
type	s40

InventoryChange

The InventoryChange element is the root element for the InventoryChange e-Document.

The purpose of the InventoryChange e-Document is to inform involved parties about changes in the inventory at a specific location. The e-Document provides information allowing the receiving party to update their systems for cost tracking, performance, and financial reporting.

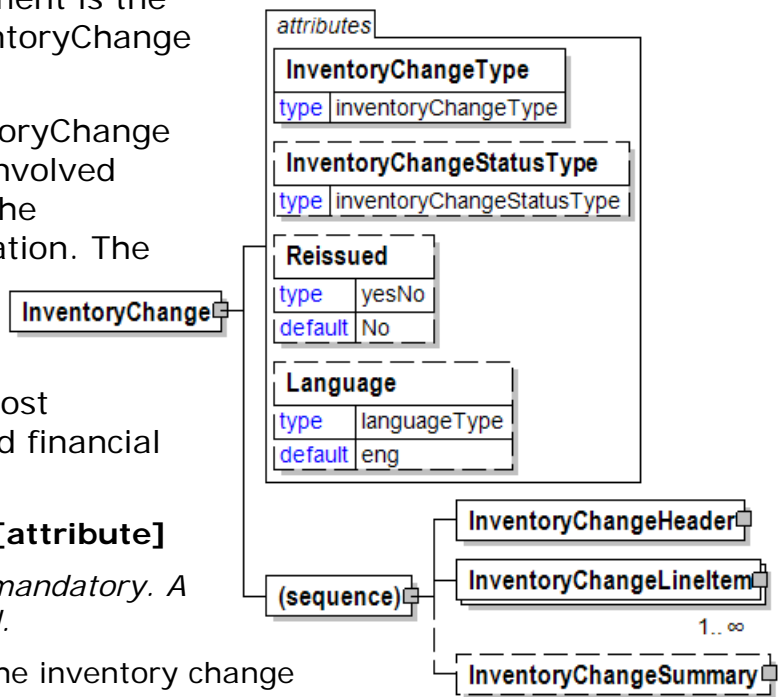

InventoryChangeType [attribute]

InventoryChangeType is mandatory. A single instance is required.

Identifies the reason for the inventory change

Refer to InventoryChangeType definition for any enumerations.

InventoryChangeStatusType [attribute]

InventoryChangeStatusType is optional. A single instance might exist.

Defines the status of the entire InventoryChange e-Document at root level

Refer to InventoryChangeStatusType definition for any enumerations.

Reissued [attribute]

Reissued is optional. A single instance might exist.

Either "Yes" or "No".

Refer to Reissued definition for any enumerations.

Language [attribute]

Language is optional. A single instance might exist.

XML has embraced 2 and 3 digit language codes through the application of an addendum to the standard.

Refer to Language definition for any enumerations.

(sequence)

The sequence of items below is mandatory. A single instance is required.

InventoryChangeHeader

InventoryChangeHeader is mandatory. A single instance is required.

Common information that applies to the entire InventoryChange e-Document.

InventoryChangeLineItem

InventoryChangeLineItem is mandatory. One instance is required, multiple instances might exist.

The detail information for a given InventoryChange item.

InventoryChangeSummary

InventoryChangeSummary is optional. A single instance might exist.

Summary information that applies to the entire InventoryChange e-Document.

InventoryChangeHeader

Common information that applies to the entire InventoryChange e-Document.

(sequence)

The sequence of items below is mandatory. A single instance is required.

InventoryChangeIssuedDate

InventoryChangeIssuedDate is mandatory. A single instance is required.

The Date and Time when the InventoryChange was issued.

TransactionHistoryNumber

TransactionHistoryNumber is optional. A single instance might exist.

A sequential number that keeps track of the version of a document being sent by the document originator except in the case where TransactionHistoryConfirmation is used, in which case the TransactionHistoryNumber refers to the trigger transaction for which the confirmation is being sent.

InventoryChangeNumber

InventoryChangeNumber is mandatory. A single instance is required.

An identifier allowing the InventoryChange to be uniquely identified.

InventoryChangeReason

InventoryChangeReason is optional. A single instance might exist.

The reason for the inventory change.

LocationParty

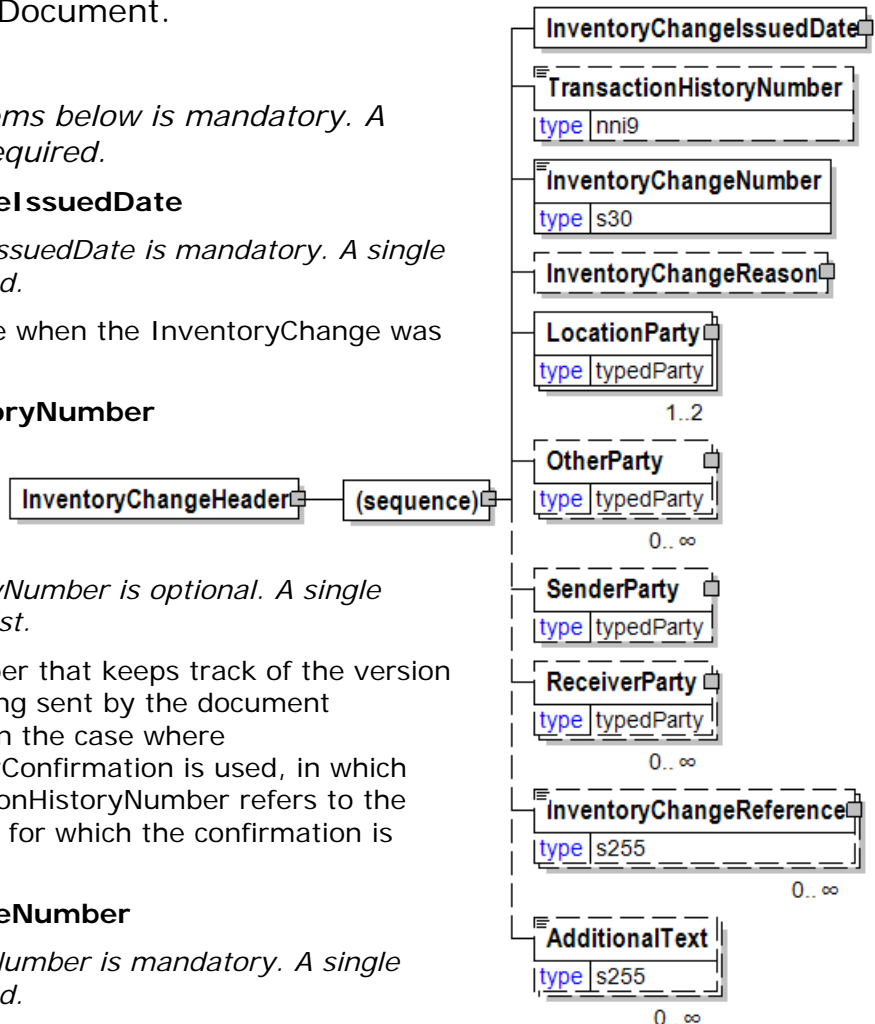

LocationParty is mandatory.

The organization or business entity where the business event took place or will take place.

OtherParty

OtherParty is optional. Multiple instances might exist.

An organisation or business entity other than those specifically detailed within a e-Document.

SenderParty

SenderParty is optional. A single instance might exist.

The business entity issuing the e-Document, the source of the document.

The entity responsible for the content. If the sender party has out sourced the message service to a third party the SenderParty is the issuer of the e-Document and not the party performing the transmission service of the electronic message.

ReceiverParty

ReceiverParty is optional. Multiple instances might exist.

The business entity for whom the e-Document is intended, the destination of the document.

The entity interested in the content. If the receiver party has outsourced the message service to a third party the ReceiverParty is the intended party for the e-Document and not the party performing the receiving service of the electronic message.

InventoryChangeReference

InventoryChangeReference is optional. Multiple instances might exist.

An element detailing relevant references (such as contract number) pertaining to the InventoryChange, identified by InventoryChangeReferenceType.

AdditionalText

AdditionalText is optional. Multiple instances might exist.

A text field that is used to communicate information not previously defined or for special instructions. To be used only for circumstances not covered by specific elements.

InventoryChangeIssuedDate

The Date and Time when the InventoryChange was issued.

(sequence)

The sequence of items below is mandatory. A single instance is required.

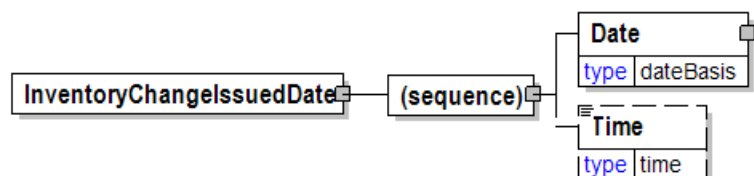

Date

Date is mandatory. A single instance is required.

A group element that contains the specification of Year, Month, and Day.

Time

papiNet V2R31

Time is optional. A single instance might exist.

Times are treated in a standard XML fashion with a special case used to indicate a generalized "local" time. The standard XML approach to time is hh:mm:ss, hh:mm:ssZ, or hh:mm:ss±hh:mm.

hh:mm:ss±hh:mm is used to represent a time with a time zone. The time zone is communicated as the number of hours offset from the Universal Time Coordinate (UTC), a.k.a. Greenwich Mean Time.

hh:mm:ssZ indicates the time at Zulu (another name for UTC). Based on the convention described in the next bullet it will be important for users within UTC to use "Z" when communicating a time in their time zone to other users.

hh:mm:ss or hh:mm indicates in the XML standard the time at UTC however, within papiNet it is used to represent the applicable local time. Caution should be used when processing times of this nature as the papiNet approach may be in discord with other users of XML.

InventoryChangeLineItem

The detail information for a given InventoryChange item.

(sequence)

The sequence of items below is mandatory. A single instance is required.

InventoryChangeLineItemNumber

InventoryChangeLineItemNumber is mandatory. A single instance is required.

An identifier for the InventoryChangeLineItem.

(sequence)

The sequence of items below is optional. A single instance might exist.

PurchaseOrderInformation

PurchaseOrderInformation is mandatory. A single instance is required.

A group item containing information unique to this

PurchaseOrder, which is provided by the buyer. PurchaseOrderInformation can be optional in the supply chain. Invoices are created without having a PurchaseOrder in Vendor Managed Inventory. Freight invoices also will not have a PurchaseOrder number.

PurchaseOrderLineItemNumber

PurchaseOrderLineItemNumber is optional. A single instance might exist.

The sequential number that uniquely identifies the PurchaseOrder line item.

Product

Product is optional. A single instance might exist.

Product is a group item defining the article and its characteristics. Product is used to specify product characteristics organized by ProductIdentifier, ProductDescription, and Classification. Book Manufacturing, Label Stock, Paper, Pulp, Recovered Paper, Wood Products, and Virgin Fibre market segments have defined their product characteristics and conversion features for implementation in papiNet.

MillParty

MillParty is optional. A single instance might exist.

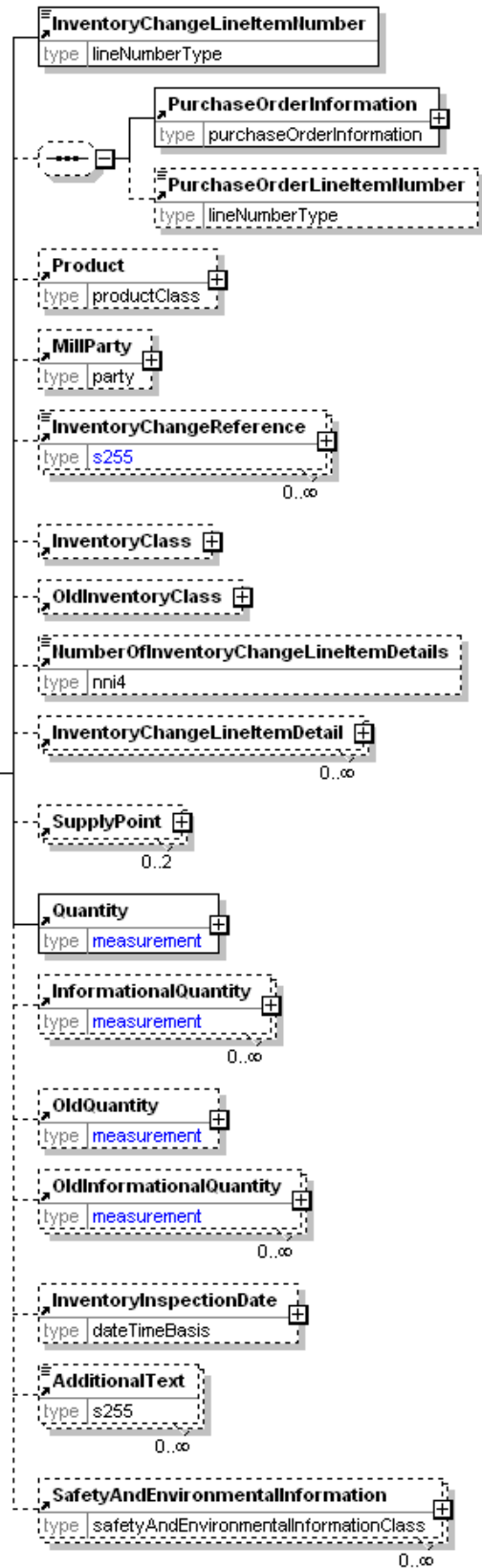

The organisation or business entity that actually produces the product.

InventoryChangeReference

InventoryChangeReference is optional. Multiple instances might exist.

An element detailing relevant references (such as contract number) pertaining to the InventoryChange, identified by InventoryChangeReferenceType.

InventoryClass

InventoryClass is optional. A single instance might exist.

A group item containing information about status of inventory and goods items.

OldInventoryClass

OldInventoryClass is optional. A single instance might exist.

A group item containing information about what the InventoryClass was prior to the event described taking place.

NumberOfInventory ChangeLineItemDetails

*NumberOfInventory
ChangeLineItemDetails is optional. A single instance might exist.*

The number of InventoryChangeLineItemDetail elements included in the InventoryChangeLineItem.

InventoryChangeLineItemDetail

InventoryChangeLineItemDetail is optional. Multiple instances might exist.

Unit level details associated with the InventoryChange.

SupplyPoint

SupplyPoint is optional. Two instances might exist.

Grouping element that contains items describing a supply point. A SupplyPoint belongs to a LocationParty, e.g. in a DeliveryOrigin or DeliveryDestination, and describes where goods are stored and can be loaded or unloaded. A SupplyPoint can for example be a loading or unloading gate at a warehouse or a road side landing at a logging area in the forest.

Quantity

Quantity is mandatory. A single instance is required.

The Quantity element contains attributes that provide information about the type of quantity that is being communicated, the context in which the particular quantity is to be viewed, and (if the quantity represents an adjustment) an adjustment type.

The Quantity element contains three child elements that enable you to communicate a range of values for the quantity and a target or actual value. It is at this level (Value, RangeMin, and RangeMax) that the unit of measure is specified. This permits the range to be specified in a different unit of measure than the target.

InformationalQuantity

InformationalQuantity is optional. Multiple instances might exist.

A quantity given in a valid UOM used for information purposes only (not for calculation). For example, an ordered quantity was 100 reels as opposed to the invoice quantity of 20,000 pounds.

OldQuantity

OldQuantity is optional. A single instance might exist.

What the Quantity was prior to the event described taking place

Old InformationalQuantity

OldInformationalQuantity is optional. Multiple instances might exist.

What the InformationalQuantity was prior to the event described taking place.

Inventory InspectionDate

InventoryInspectionDate is optional. A single instance might exist.

The physical inspection Date and Time of inventory.

AdditionalText

AdditionalText is optional. Multiple instances might exist.

A text field that is used to communicate information not previously defined or for special instructions. To be used only for circumstances not covered by specific elements.

SafetyAndEnvironmentalInformation

SafetyAndEnvironmentalInformation is optional. Multiple instances might exist.

Name of certification type, if any, on the goods (For example, FSC, PEFC). SafetyAndEnvironmental needs a value or measurement to communicate the percentage of the product is certified (for example, 75% is certified by the indicated agency).

InventoryChangeLineItemDetail

Unit level details associated with the InventoryChange.

ChangeDetailType [attribute]

ChangeDetailType is optional. A single instance might exist.



Specifies how a package is changed.

Refer to ChangeDetailType definition for any enumerations.

(sequence)

The sequence of items below is mandatory. A single instance is required.

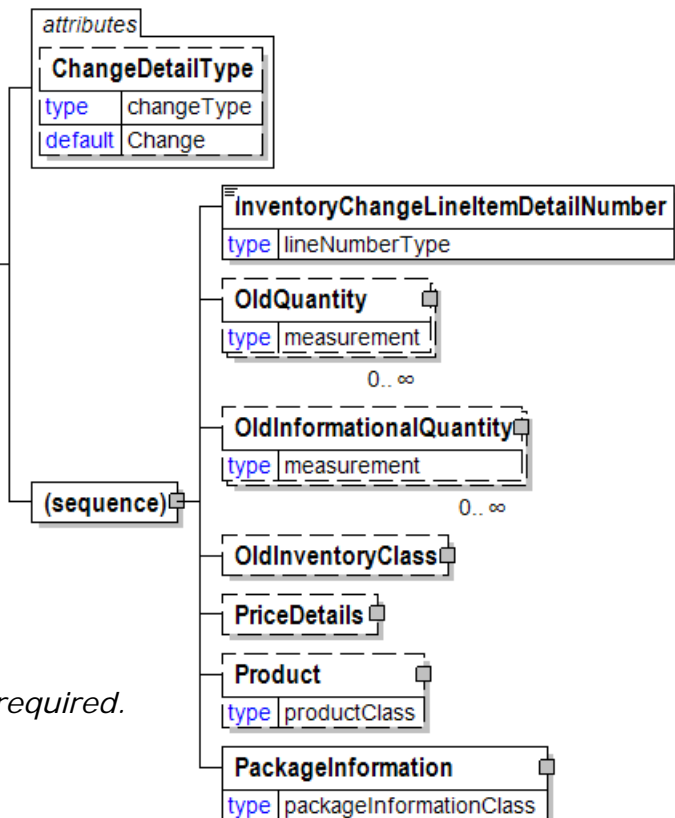

InventoryChangeLineItemDetailNumber

InventoryChangeLineItemDetailNumber is mandatory. A single instance is required.

An identifier allowing the line item to be uniquely identified.

OldQuantity

OldQuantity is optional. Multiple instances might exist.

What the Quantity was prior to the event described taking place

OldInformationalQuantity

OldInformationalQuantity is optional. Multiple instances might exist.

What the InformationalQuantity was prior to the event described taking place.

OldInventoryClass

OldInventoryClass is optional. A single instance might exist.

A group item containing information about what the InventoryClass was prior to the event described taking place.

PriceDetails

PriceDetails is optional. A single instance might exist.

An element that groups together price information.

Product

Product is optional. A single instance might exist.

Product is a group item defining the article and its characteristics. Product is used to specify product characteristics organized by ProductIdentifier, ProductDescription, and Classification. Book Manufacturing, Label Stock, Paper, Pulp, Recovered Paper, Wood Products, and Virgin Fibre market segments have defined their product characteristics and conversion features for implementation in papiNet.

PackageInformation

PackageInformation is mandatory. A single instance is required.

The purpose of the PackageInformation structure is to clearly identify physical handling items that constitute the delivery.

PackageInformation is the highest level of product packaging it describes the shipping or warehousing unit.

If you are communicating a package, usually for logistics or transport purposes, you should include the PackageType, Identifier, ItemCount, and Quantity. (Note: you still have the ability to describe the item with one of the "named" items.)

If you are communicating one of the named Items there is no need to include PackageType, Identifier, ItemCount, and Quantity.

Since either of these two approaches can be used the entire contents of this element are optional even though the parent may be required. It is expected that you will fill in the appropriate details.

InventoryChangeLineItemDetailNumber

An identifier allowing the line item to be uniquely identified.

InventoryChangeLineItemDetailNumber
type lineNumberType

InventoryChangeLineItemNumber

An identifier for the InventoryChangeLineItem.

InventoryChangeLineItemNumber	
type	lineNumberType

InventoryChangeNumber

An identifier allowing the InventoryChange to be uniquely identified.

InventoryChangeNumber	
type	s30

InventoryChangeReason

The reason for the inventory change.

(sequence)

The sequence of items below is mandatory.

A single instance is required.

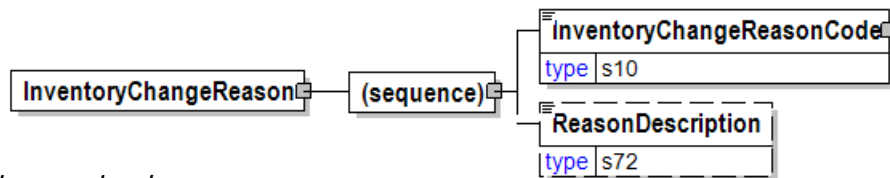

InventoryChangeReasonCode

InventoryChangeReasonCode is mandatory. A single instance is required.

A code representing the reason for the inventory change, identified by Agency.

ReasonDescription

ReasonDescription is optional. A single instance might exist.

Text associated with a particular ReasonIdentifier

InventoryChangeReasonCode

A code representing the reason for the inventory change, identified by Agency.

Agency [attribute]

Agency is mandatory. A single instance is required.



Describes the agency maintaining the list of codes. To be included in this list the agency must be a recognized standards body or industry organisation.

For the element that owns this attribute.

For another attribute in the list of attributes associated with the parent element.

Refer to Agency definition for any enumerations.

InventoryChangeReference

An element detailing relevant references (such as contract number) pertaining to the InventoryChange, identified by

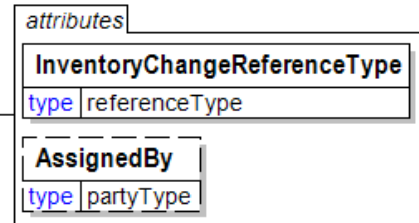
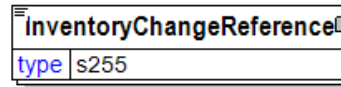

InventoryChangeReferenceType.

InventoryChangeReferenceType [attribute]

InventoryChangeReferenceType is mandatory. A single instance is required.

Provides a contextual explanation of the specific reference identifier. Many items are currently prefixed by "Buyer", "Forwarder", "Manufacturer", "Mill", "Seller", "Supplier", "Warehouse", or "Vendor". Check for an existing non-prefixed version and use the non-prefixed version instead. In the (yet to be announced release date) version 3.0 the prefixed versions will be removed. Instead the attribute @AssignedBy will communicate the information previously communicated in the prefix.

Refer to InventoryChangeReferenceType definition for any enumerations.

AssignedBy [attribute]

AssignedBy is optional. A single instance might exist.

Identifies the type of party that has assigned the associated item, e.g. a reference of type OrderNumber.

Refer to AssignedBy for any enumerations.

InventoryChangeReferenceType [attribute]

Provides a contextual explanation of the specific reference identifier. Many items are currently prefixed by "Buyer", "Forwarder", "Manufacturer", "Mill", "Seller", "Supplier", "Warehouse", or "Vendor". Check for an

existing non-prefixed version and use the non-prefixed version instead. In the (yet to be announced release date) version 3.0 the prefixed versions will be removed. Instead the attribute @AssignedBy will communicate the information previously communicated in the prefix.

Refer to the [referenceType](#) entry for the list of enumerations and their definitions.

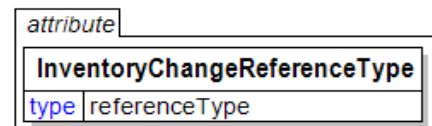

InventoryChangeStatusType [attribute]

Defines the status of the entire InventoryChange e-Document at root level

This item is restricted to the following list.

Cancelled

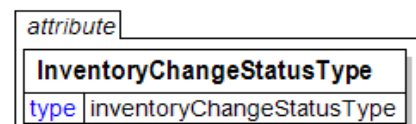

The supplied information has been cancelled. Items that have been cancelled are not included in totals on the summary levels of the e-Document.

Original

The supplied information is the first version of that information.

Replaced

The supplied information is replacing earlier supplied information. The receiver should revalidate the information in their system based upon the entire information received.

InventoryChangeSummary

Summary information that applies to the entire InventoryChange e-Document.

(sequence)

The sequence of items below is mandatory. A single instance is required.

TotalNumberOfLineItems

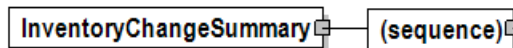

TotalNumberOfLineItems is optional. A single instance might exist.

The total number of individual line items in the document, regardless of the status or type.

(sequence)

The sequence of items below is mandatory. One instance is required, multiple instances might exist.

TotalQuantity

TotalQuantity is mandatory. A single instance is required.

The total quantity of similar items in the e-Document. TotalQuantity is primarily used in the summary section of documents where it is repeatable to permit totaling for different units of measure.

TotalInformationalQuantity

TotalInformationalQuantity is optional. Multiple instances might exist.

A quantity that is used to communicate related information about the parent element. This element represents a total that is derived from individual line items.

(sequence)

The sequence of items below is optional. Multiple instances might exist.

TotalOldQuantity

TotalOldQuantity is mandatory. A single instance is required.

A summary of the OldQuantity in the document. TotalOldQuantity uses the

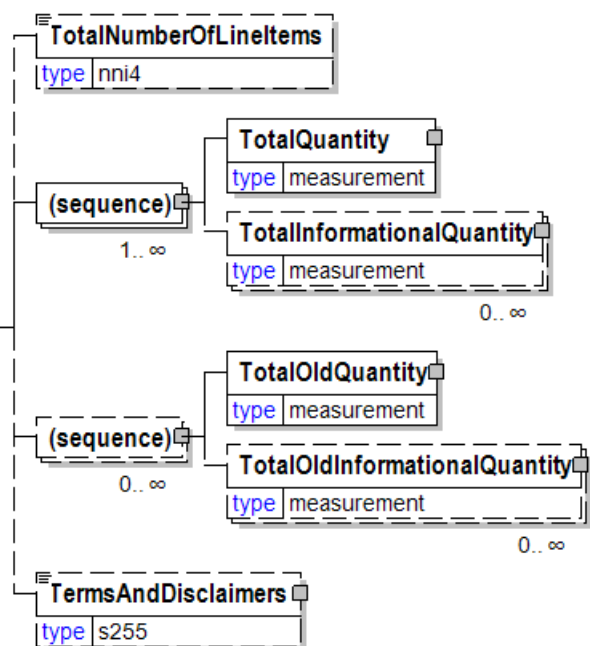

QuantityInformation attribute group and the Measurement group (element grouping).

TotalOldInformationalQuantity

TotalOldInformationalQuantity is optional. Multiple instances might exist.

A summary of the OldInformationQuantity in the document.

TotalOldInformationalQuantity uses the QuantityInformation attribute group and the Measurement group (element grouping).

TermsAndDisclaimers

TermsAndDisclaimers is optional. A single instance might exist.

An element that contains legal information with an indication of what the Language is.

InventoryChangeType [attribute]

Identifies the reason for the inventory change

This item is restricted to the following list.



Buy

The material has been purchased

Classification

The inventory change is due to a change in classification

Conversion

InventoryTransfer

The material has been transferred

LocationTransfer

The material has been moved

OwnershipTransfer

The party owning the material is being changed.

QualityReject

The change is due to rejection.

Rewrapping

The material has been rewrapped

Sell

The material has been sold

SiteDamage

Damage has taken place at the storage site.

StockCount

TransitDamage

Damage has taken place in transit.

Waste

The quantity is being changed due to spoilage or waste of material.

InventoryClass

A group item containing information about status of inventory and goods items.

InventoryStatusType [attribute]

InventoryStatusType is optional. A single instance might exist.

Provides the status type for inventory/goods belonging to a product and/or an order.

Refer to InventoryStatusType definition for any enumerations.

InventoryOwnedBy [attribute]

InventoryOwnedBy is optional. A single instance might exist.

Specifies who is the owner of the inventory/goods.

Refer to InventoryOwnedBy definition for any enumerations.

(sequence)

The sequence of items below is mandatory. A single instance is required.

(sequence)

The sequence of items below is optional. Multiple instances might exist.

InventoryClassCode

InventoryClassCode is mandatory. A single instance is required.

A code specifying the inventory and goods status. Classification of statuses can be done on multiple levels indicated by InventoryClassLevel.

InventoryClassDescription

InventoryClassDescription is optional. Multiple instances might exist.

A description of the inventory class.

AdditionalText

AdditionalText is optional. Multiple instances might exist.

A text field that is used to communicate information not previously defined or for special instructions. To be used only for circumstances not covered by specific elements.

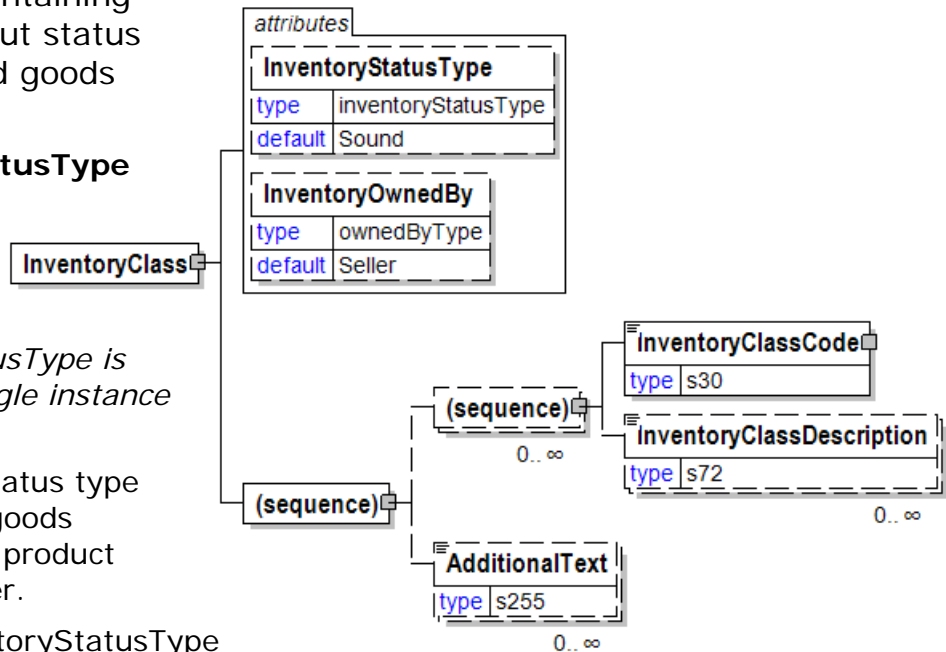

InventoryClassCode

A code specifying the inventory and goods status. Classification of statuses can be done on multiple levels indicated by InventoryClassLevel.

Agency [attribute]

Agency is mandatory. A single instance is required.

Describes the agency maintaining the list of codes. To be included in this list the agency must be a recognized standards body or industry organisation.

For the element that owns this attribute.

For another attribute in the list of attributes associated with the parent element.

Refer to Agency definition for any enumerations.

InventoryClassLevel [attribute]

InventoryClassLevel is optional. A single instance might exist.

The sequential number that uniquely identifies the level of stacked Inventory Class Codes. E.g. On level 1 "Damaged" can be given as an inventory class code while details on damages can be specified with inventory class codes on level 2.

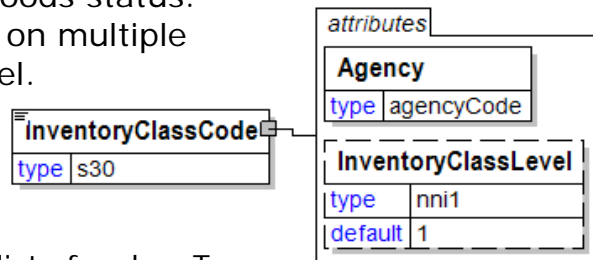

InventoryClassDescription

A description of the inventory class.

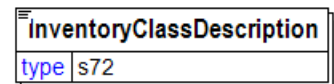

InventoryClassLevel [attribute]

The sequential number that uniquely identifies the level of stacked Inventory Class Codes. E.g. On level 1 "Damaged" can be given as an inventory class code while details on damages can be specified with inventory class codes on level 2.

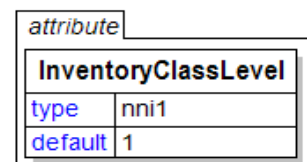

InventoryDispositionInstructions

The

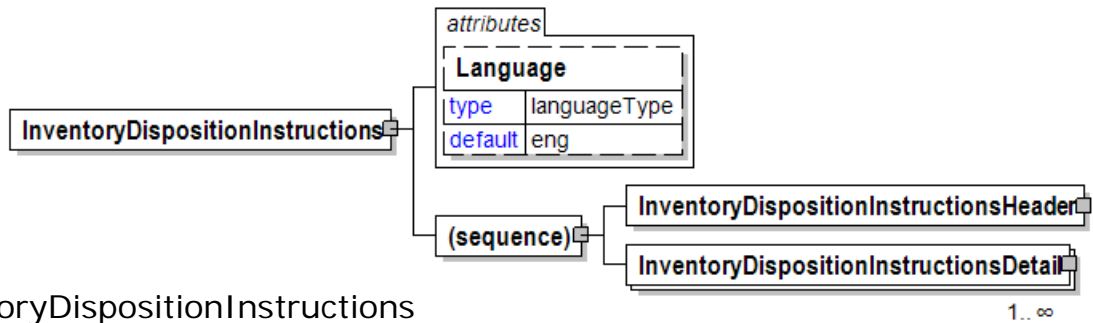

InventoryDispositionInstructions element is the root element for the InventoryDispositionInstructions e-Document.

The InventoryDispositionInstructions e-Document permits the owner of inventory stored at a third party location to request the inventory be destroyed, shipped to another location, held in inventory, or physically changed. The receiving party makes the requested changes to the inventory and sends an InventoryChange and ShippingInstructions, if required, to the requestor so their systems can be updated.

Language [attribute]

Language is optional. A single instance might exist.

XML has embraced 2 and 3 digit language codes through the application of an addendum to the standard.

Refer to Language definition for any enumerations.

(sequence)

The sequence of items below is mandatory. A single instance is required.

InventoryDispositionInstructionsHeader

InventoryDispositionInstructionsHeader is mandatory. A single instance is required.

Provides information that is common for the instructions on how to dispose of problematic inventory.

InventoryDispositionInstructionsDetail

InventoryDispositionInstructionsDetail is mandatory. One instance is required, multiple instances might exist.

InventoryDispositionInstructionsDetail provides information about the product to be disposed of and the method of disposal.

InventoryDispositionInstructionsDetail

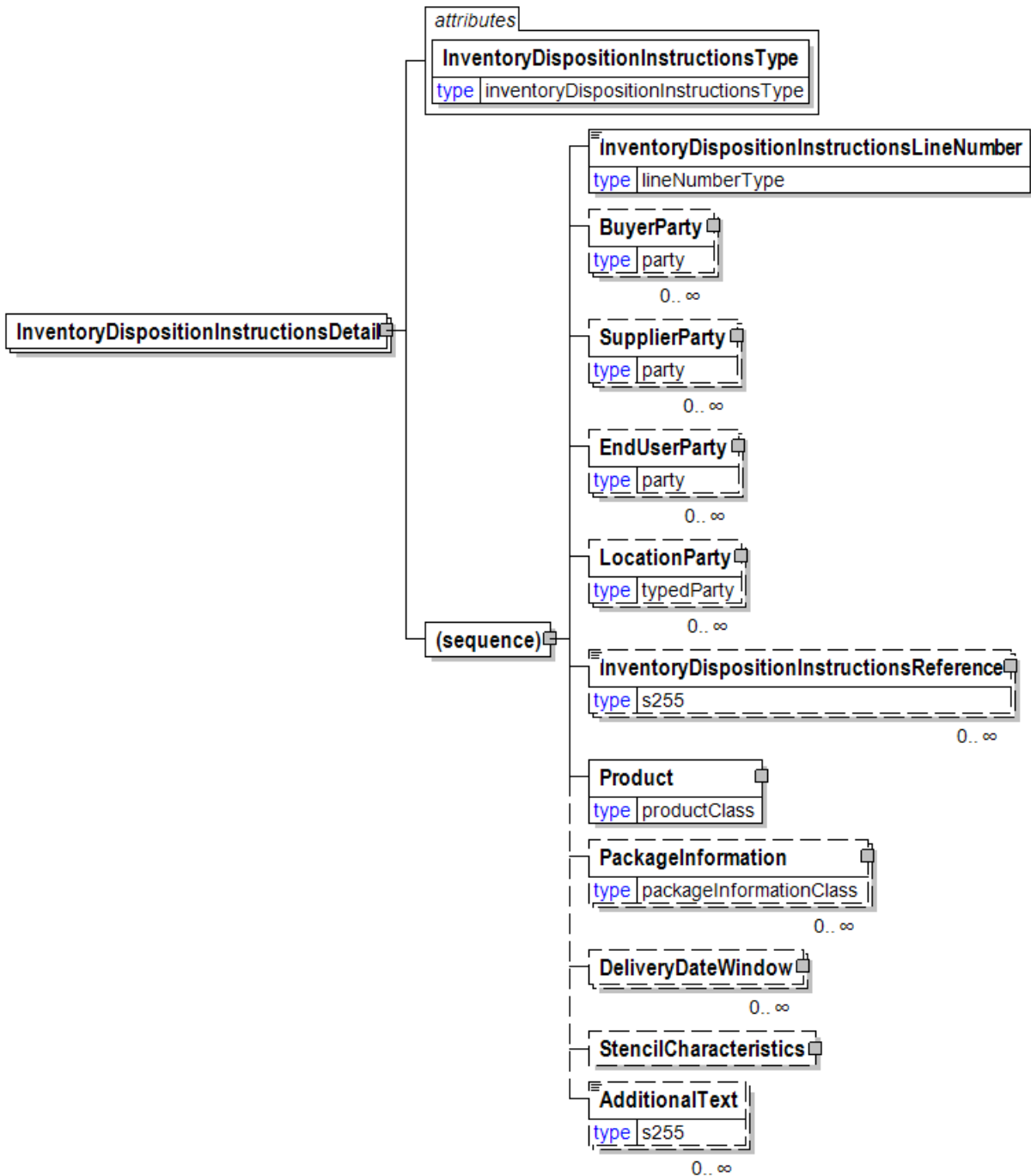

InventoryDispositionInstructionsDetail provides information about the product to be disposed of and the method of disposal.

InventoryDispositionInstructionsType [attribute]

InventoryDispositionInstructionsType is mandatory. A single instance is required.

Indicates the type of inventory disposition that is required. As this attribute is at the line level multiple dispositions can be communicated in a single e-Document.

Refer to InventoryDispositionInstructionsType definition for any enumerations.

(sequence)

The sequence of items below is mandatory. A single instance is required.

InventoryDispositionInstructionsLineNumber

InventoryDispositionInstructionsLineNumber is mandatory. A single instance is required.

The sequential number that uniquely identifies the InventoryDispositionInstructions line item.

BuyerParty

BuyerParty is optional. Multiple instances might exist.

The legal entity to which the product is sold. Also commonly referred to as the sold-to party or customer. If no OtherParty is defined as the Payer, the Buyer is the Payer.

SupplierParty

SupplierParty is optional. Multiple instances might exist.

The organisation or business entity responsible for providing the product. SupplierParty is also the seller of the product, if Seller is not specified as OtherParty = Seller.

EndUserParty

EndUserParty is optional. Multiple instances might exist.

The party using, consuming, or converting the product. For example, a printer using paper reels for a print job for a publisher. The final ShipTo destination for a product is normally to the end user's facilities.

LocationParty

LocationParty is optional. Multiple instances might exist.

The organization or business entity where the business event took place or will take place.

InventoryDispositionInstructionsReference

InventoryDispositionInstructionsReference is optional. Multiple instances might exist.

Contains references that pertain to the InventoryDispositionInstructions e-Document.

Product

Product is mandatory. A single instance is required.

Product is a group item defining the article and its characteristics. Product is used to specify product characteristics organized by ProductIdentifier, ProductDescription, and Classification. Book Manufacturing, Label Stock, Paper, Pulp, Recovered Paper, Wood Products, and Virgin Fibre market segments have defined their product characteristics and conversion features for implementation in papiNet.

PackageInformation

PackageInformation is optional. Multiple instances might exist.

The purpose of the PackageInformation structure is to clearly identify physical handling items that constitute the delivery.

PackageInformation is the highest level of product packaging it describes the shipping or warehousing unit.

If you are communicating a package, usually for logistics or transport purposes, you should include the PackageType, Identifier, ItemCount, and Quantity. (Note: you still have the ability to describe the item with one of the "named" items.)

If you are communicating one of the named Items there is no need to include PackageType, Identifier, ItemCount, and Quantity.

Since either of these two approaches can be used the entire contents of this element are optional even though the parent may be required. It is expected that you will fill in the appropriate details.

DeliveryDateWindow

DeliveryDateWindow is optional. Multiple instances might exist.

A group item defining the date/time interval for delivery to take place. An element which may contain the estimated date for which delivery is expected. This date is not absolute.

StencilCharacteristics

StencilCharacteristics is optional. A single instance might exist.

A group element specifying attributes of a stencil to be applied to an item, and optional text.

AdditionalText

AdditionalText is optional. Multiple instances might exist.

A text field that is used to communicate information not previously defined or for special instructions. To be used only for circumstances not covered by specific elements.

InventoryDispositionInstructionsHeader

Provides information that is common for the instructions on how to dispose of problematic inventory.

(sequence)

The sequence of items below is

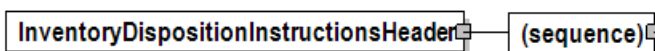

mandatory. A single instance is required.

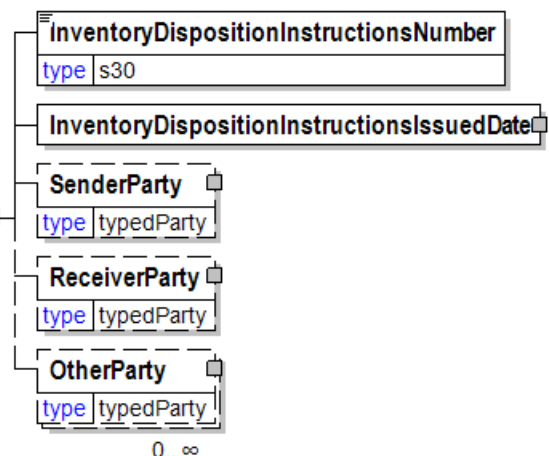

InventoryDispositionInstructionsNumber

InventoryDispositionInstructionsNumber is mandatory. A single instance is required.

The identifying number for the Inventory Disposition e-Document.

InventoryDispositionInstructionsIssuedDate

InventoryDispositionInstructionsIssuedDate is mandatory. A single instance is required.

papiNet V2R31

The date that the disposition instructions were issued.

SenderParty

SenderParty is optional. A single instance might exist.

The business entity issuing the e-Document, the source of the document.

The entity responsible for the content. If the sender party has out sourced the message service to a third party the SenderParty is the issuer of the e-Document and not the party performing the transmission service of the electronic message.

ReceiverParty

ReceiverParty is optional. A single instance might exist.

The business entity for whom the e-Document is intended, the destination of the document.

The entity interested in the content. If the receiver party has outsourced the message service to a third party the ReceiverParty is the intended party for the e-Document and not the party performing the receiving service of the electronic message.

OtherParty

OtherParty is optional. Multiple instances might exist.

An organisation or business entity other than those specifically detailed within a e-Document.

InventoryDispositionInstructionsIssuedDate

The date that the disposition instructions were issued.

(sequence)

The sequence of items below is mandatory. A single instance is required.

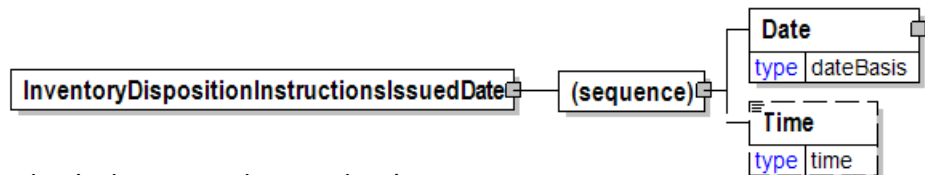

Date

Date is mandatory. A single instance is required.

A group element that contains the specification of Year, Month, and Day.

Time

Time is optional. A single instance might exist.

Times are treated in a standard XML fashion with a special case used to indicate a generalized "local" time. The standard XML approach to time is hh:mm:ss, hh:mm:ssZ, or hh:mm:ss±hh:mm.

hh:mm:ss±hh:mm is used to represent a time with a time zone. The time zone is communicated as the number of hours offset from the Universal Time Coordinate (UTC), a.k.a. Greenwich Mean Time.

hh:mm:ssZ indicates the time at Zulu (another name for UTC). Based on the convention described in the next bullet it will be important for users within UTC to use "Z" when communicating a time in their time zone to other users.

hh:mm:ss or hh:mm indicates in the XML standard the time at UTC however, within papiNet it is used to represent the applicable local time. Caution should be used when processing times of this nature as the papiNet approach may be

in discord with other users of XML.

InventoryDispositionInstructionsLineNumber

The sequential number that uniquely identifies the InventoryDispositionInstructions line item.

InventoryDispositionInstructionsLineNumber	
type	lineNumberType

InventoryDispositionInstructionsNumber

The identifying number for the InventoryDispositionInstructions e-Document.

InventoryDispositionInstructionsNumber	
type	s30

InventoryDispositionInstructionsReference

Contains references that pertain to the

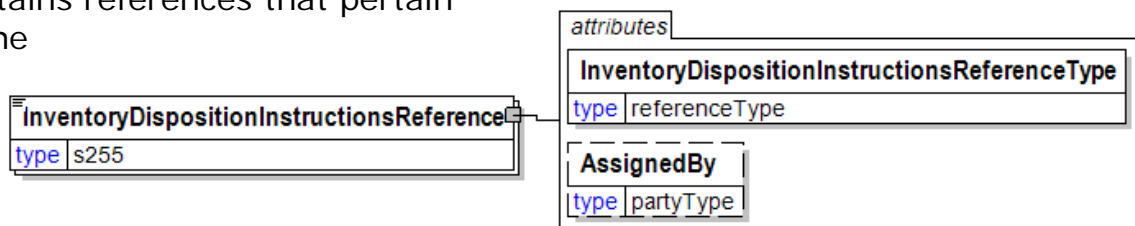

InventoryDispositionInstructions e-Document.

InventoryDispositionInstructionsReferenceType [attribute]

InventoryDispositionInstructionsReferenceType is mandatory. A single instance is required.

Provides a contextual explanation of the specific reference identifier. Many items are currently prefixed by "Buyer", "Forwarder", "Manufacturer", "Mill", "Seller", "Supplier", "Warehouse", or "Vendor". Check for an existing non-prefixed version and use the non-prefixed version instead. In the (yet to be announced release date) version 3.0 the prefixed versions will be removed. Instead the attribute `@AssignedBy` will communicate the information previously communicated in the prefix.

Refer to `InventoryDispositionInstructionsReferenceType` definition for any enumerations.

AssignedBy [attribute]

AssignedBy is optional. A single instance might exist.

Identifies the type of party that has assigned the associated item, e.g. a reference of type `OrderNumber`.

Refer to `AssignedBy` for any enumerations.

InventoryDispositionInstructionsReferenceType [attribute]

Provides a contextual explanation of the specific reference identifier. Many items are currently prefixed by "Buyer", "Forwarder", "Manufacturer", "Mill", "Seller",

"Supplier", "Warehouse", or "Vendor". Check for an existing non-prefixed version and use the non-prefixed version instead. In the (yet to be announced release date) version 3.0 the prefixed versions will be removed. Instead the attribute @AssignedBy will communicate the information previously communicated in the prefix.

Refer to the [referenceType](#) entry for the list of enumerations and their definitions.

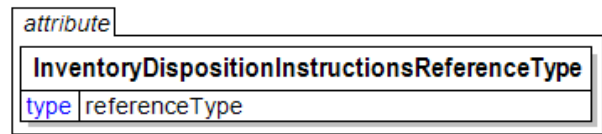

InventoryDispositionInstructionsType [attribute]

Indicates the type of inventory disposition that is required. As this attribute is at the line level multiple dispositions can be communicated in a single e-Document.

This item is restricted to the following list.

Scrap

Raw Material or Work in Process to be scrapped.

Destroy

Finished Goods or Work in Process containing copyrighted information that must be physically destroyed.

Hold

Excess raw materials, Work in Process, or Finished Goods that should be held for future production or until other Disposition Instructions are received at the current location.

Transfer

Raw materials or Work in Process that will be shipped to another location.



InventoryInspectionDate

The physical inspection Date and Time of inventory.

(sequence)

The sequence of items below is mandatory. A single instance is required.

Date

Date is mandatory. A single instance is required.

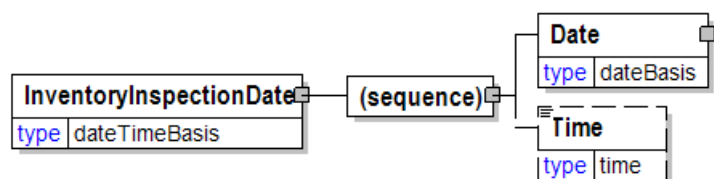

papiNet V2R31

A group element that contains the specification of Year, Month, and Day.

Time

Time is optional. A single instance might exist.

Times are treated in a standard XML fashion with a special case used to indicate a generalized "local" time. The standard XML approach to time is hh:mm:ss, hh:mm:ssZ, or hh:mm:ss±hh:mm.

hh:mm:ss±hh:mm is used to represent a time with a time zone. The time zone is communicated as the number of hours offset from the Universal Time Coordinate (UTC), a.k.a. Greenwich Mean Time.

hh:mm:ssZ indicates the time at Zulu (another name for UTC). Based on the convention described in the next bullet it will be important for users within UTC to use "Z" when communicating a time in their time zone to other users.

hh:mm:ss or hh:mm indicates in the XML standard the time at UTC however, within papiNet it is used to represent the applicable local time. Caution should be used when processing times of this nature as the papiNet approach may be in discord with other users of XML.

InventoryOwnedBy [attribute]

Specifies who is the owner of the inventory/goods.

This item is restricted to the following list.

Buyer

The owner of the inventory/goods is the buyer. The inventory/goods have already been invoiced.

Seller

The owner of the inventory/goods is the seller

attribute	
InventoryOwnedBy	
type	ownedByType
default	Seller

InventoryStatus

The InventoryStatus element is the root element for the InventoryStatus e-Document.

The InventoryStatus e-Document informs involved parties about physical inventory levels at specific stock locations (warehouse, terminal, printer etc.) at a certain time (snapshot).

Reissued [attribute]

Reissued is optional. A single instance might exist.

Either "Yes" or "No".

Refer to Reissued definition for any enumerations.

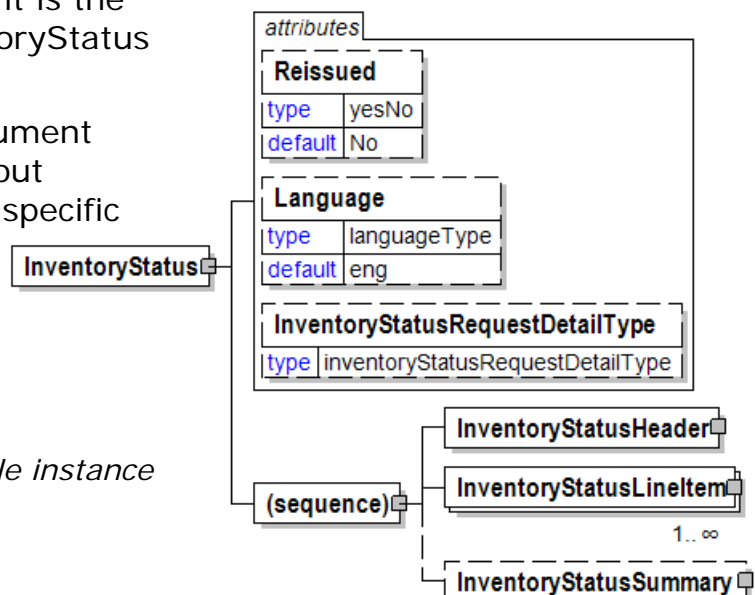

Language [attribute]

Language is optional. A single instance might exist.

XML has embraced 2 and 3 digit language codes through the application of an addendum to the standard.

Refer to Language definition for any enumerations.

InventoryStatusRequestDetailType [attribute]

InventoryStatusRequestDetailType is optional. A single instance might exist.

Communicates the method in which the InventoryStatus should be summarized.

Refer to InventoryStatusRequestDetailType definition for any enumerations.

(sequence)

The sequence of items below is mandatory. A single instance is required.

InventoryStatusHeader

InventoryStatusHeader is mandatory. A single instance is required.

Information that applies to all items on the InventoryStatus e-Document.

InventoryStatusLineItem

InventoryStatusLineItem is mandatory. One instance is required, multiple instances might exist.

Individual information about the item(s) on an InventoryStatus e-Document.

InventoryStatusSummary

InventoryStatusSummary is optional. A single instance might exist.

Summary information that applies to the entire InventoryStatus e-Document.

InventoryStatusHeader

Information that applies to all items on the InventoryStatus e-Document.

(sequence)

The sequence of items below is mandatory. A single instance is required.

InventoryStatusIssuedDate

InventoryStatusIssuedDate is mandatory. A single instance is required.

The effective date of the InventoryStatus e-Document.

RequestNumber

RequestNumber is optional. A single instance might exist.

A unique tracking number specifically identifying the InfoRequest e-Document to the originator. The tracking number is returned with the "information", the answer, to help match the answer to the request.

TransactionHistoryNumber

TransactionHistoryNumber is optional. A single instance might exist.

A sequential number that keeps track of the version of a document being sent by the document originator except in the case where TransactionHistoryConfirmation is used, in which case the TransactionHistoryNumber refers to the trigger transaction for which the confirmation is being sent.

InventoryStatusNumber

InventoryStatusNumber is mandatory. A single instance is required.

An identifier that allows for unique identification of the InventoryStatus.

LocationParty

LocationParty is optional. A single instance might exist.

The organization or business entity where the business event took place or will take place.

OtherParty

OtherParty is optional. Multiple instances might exist.

An organisation or business entity other than those specifically detailed within a e-Document.

SenderParty

SenderParty is optional. A single instance might exist.

The business entity issuing the e-Document, the source of the document.

The entity responsible for the content. If the sender party has out sourced the

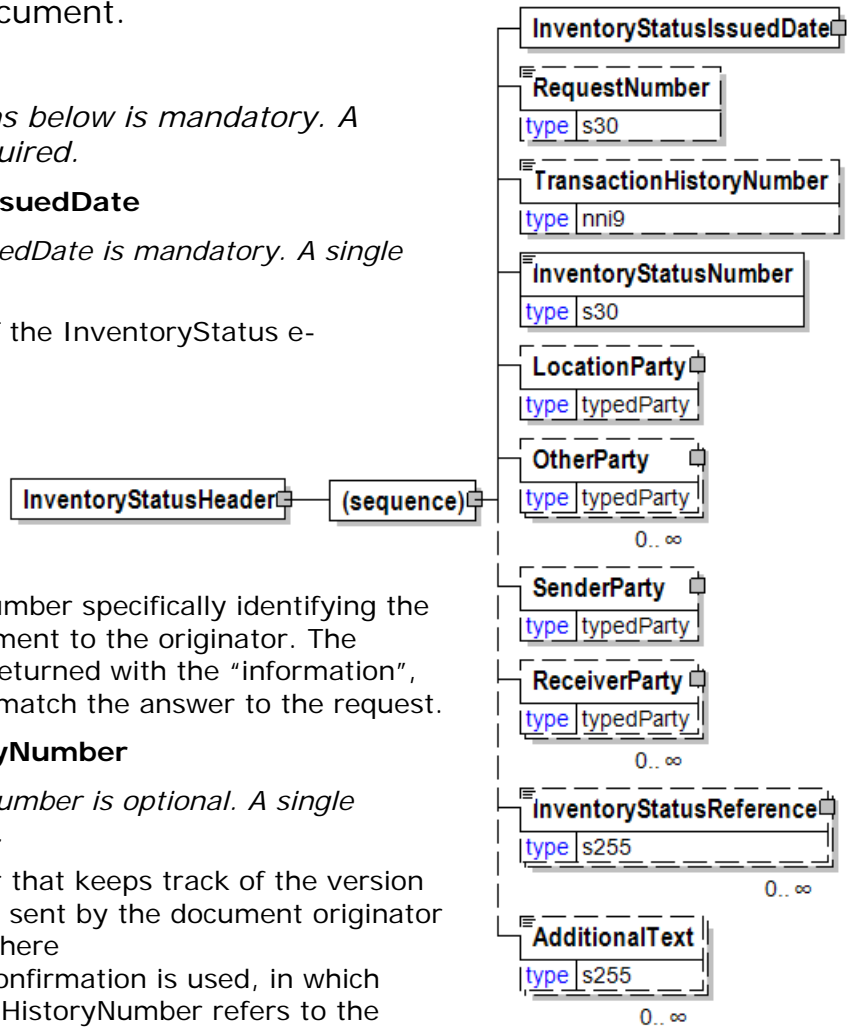

papiNet V2R31

message service to a third party the SenderParty is the issuer of the e-Document and not the party performing the transmission service of the electronic message.

ReceiverParty

ReceiverParty is optional. Multiple instances might exist.

The business entity for whom the e-Document is intended, the destination of the document.

The entity interested in the content. If the receiver party has outsourced the message service to a third party the ReceiverParty is the intended party for the e-Document and not the party performing the receiving service of the electronic message.

InventoryStatusReference

InventoryStatusReference is optional. Multiple instances might exist.

A group item detailing relevant references pertaining to the InventoryChange, identified by InventoryStatusReferenceType.

AdditionalText

AdditionalText is optional. Multiple instances might exist.

A text field that is used to communicate information not previously defined or for special instructions. To be used only for circumstances not covered by specific elements.

InventoryStatusIssuedDate

The effective date of the InventoryStatus e-Document.

(sequence)

The sequence of items below is mandatory. A single instance is required.

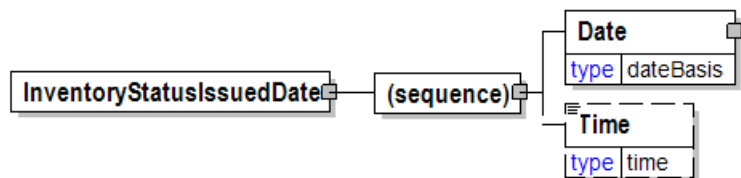

Date

Date is mandatory. A single instance is required.

A group element that contains the specification of Year, Month, and Day.

Time

Time is optional. A single instance might exist.

Times are treated in a standard XML fashion with a special case used to indicate a generalized "local" time. The standard XML approach to time is hh:mm:ss, hh:mm:ssZ, or hh:mm:ss±hh:mm.

hh:mm:ss±hh:mm is used to represent a time with a time zone. The time zone is communicated as the number of hours offset from the Universal Time Coordinate (UTC), a.k.a. Greenwich Mean Time.

hh:mm:ssZ indicates the time at Zulu (another name for UTC). Based on the convention described in the next bullet it will be important for users within UTC to use "Z" when communicating a time in their time zone to other users.

hh:mm:ss or hh:mm indicates in the XML standard the time at UTC however, within papiNet it is used to represent the applicable local time. Caution should be used when processing times of this nature as the papiNet approach may be

in discord with other users of XML.

InventoryStatusLineItem

Individual information about the item(s) on an InventoryStatus e-Document.

(sequence)

The sequence of items below is mandatory. A single instance is required.

InventoryStatusLineItemNumber

InventoryStatusLineItemNumber is mandatory. A single instance is required.

An identifier that allows for unique identification of the InventoryStatusLineItem.

PurchaseOrderInformation

PurchaseOrderInformation is optional. A single instance might exist.

A group item containing information unique to this PurchaseOrder, which is provided by the buyer. PurchaseOrderInformation can be optional in the supply chain. Invoices are created without having a PurchaseOrder in Vendor Managed Inventory. Freight invoices also will not have a PurchaseOrder number.



PurchaseOrderLineItemNumber

PurchaseOrderLineItemNumber is optional. A single instance might exist.

The sequential number that uniquely identifies the PurchaseOrder line item.

Product

Product is mandatory. A single instance is required.

Product is a group item defining the article and its characteristics. Product is used to specify product characteristics organized by ProductIdentifier, ProductDescription, and Classification. Book Manufacturing, Label Stock, Paper, Pulp, Recovered Paper, Wood Products, and Virgin Fibre market segments have defined their product characteristics and conversion features for implementation in papiNet.

MillParty

MillParty is optional. A single instance might exist.

The organisation or business entity that actually produces the product.

InventoryStatusReference

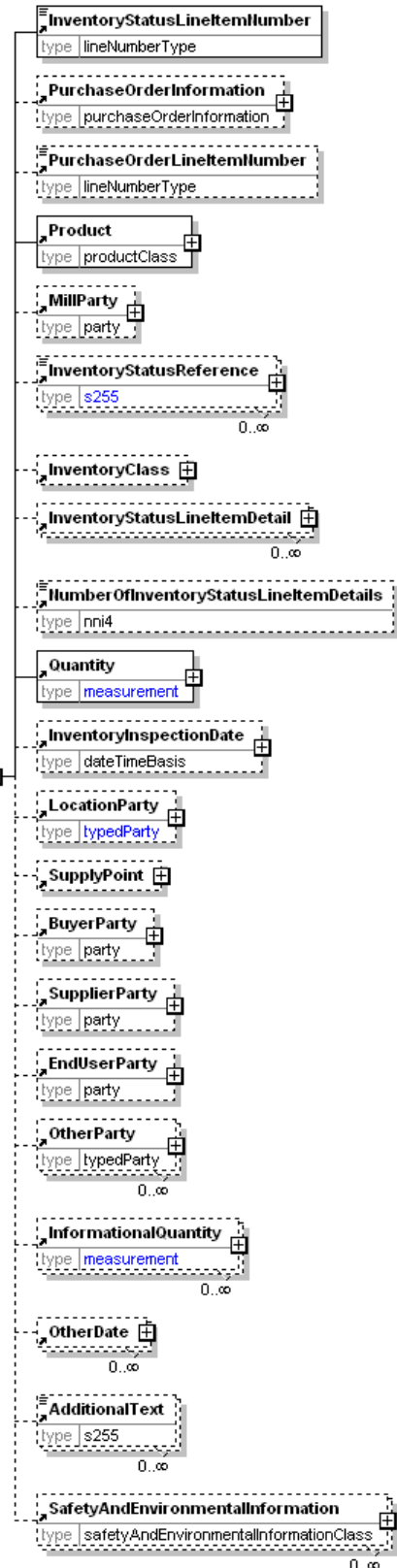

InventoryStatusReference is optional. Multiple instances might exist.

A group item detailing relevant references pertaining to the InventoryChange, identified by InventoryStatusReferenceType.

InventoryClass

InventoryClass is optional. A single instance might exist.

A group item containing information about status of inventory and goods items.

InventoryStatusLineItemDetail

InventoryStatusLineItemDetail is optional. Multiple instances might exist.

A group element that contains InventoryStatus details.

NumberOfInventoryStatusLineItemDetails

NumberOfInventoryStatusLineItemDetails is optional. A single instance might exist.

The number of InventoryStatusLineItemDetail elements included in the InventoryStatusLineItem.

Quantity

Quantity is mandatory. A single instance is required.

The Quantity element contains attributes that provide information about the type of quantity that is being communicated, the context in which the particular quantity is to be viewed, and (if the quantity represents an adjustment) an adjustment type.

The Quantity element contains three child elements that enable you to communicate a range of values for the quantity and a target or actual value. It is at this level (Value, RangeMin, and RangeMax) that the unit of measure is specified. This permits the range to be specified in a different unit of measure than the target.

InventoryInspectionDate

InventoryInspectionDate is optional. A single instance might exist.

The physical inspection Date and Time of inventory.

LocationParty

LocationParty is optional. A single instance might exist.

The organization or business entity where the business event took place or will take place.

SupplyPoint

SupplyPoint is optional. A single instance might exist.

Grouping element that contains items describing a supply point. A SupplyPoint belongs to a LocationParty, e.g. in a DeliveryOrigin or DeliveryDestination, and describes where goods are stored and can be loaded or unloaded. A SupplyPoint can for example be a loading or unloading gate at a warehouse or a road side landing at a logging area in the forest.

BuyerParty

BuyerParty is optional. A single instance might exist.

The legal entity to which the product is sold. Also commonly referred to as the sold-to party or customer. If no OtherParty is defined as the Payer, the Buyer is the Payer.

SupplierParty

SupplierParty is optional. A single instance might exist.

The organisation or business entity responsible for providing the product. SupplierParty is also the seller of the product, if Seller is not specified as OtherParty = Seller.

EndUserParty

EndUserParty is optional. A single instance might exist.

The party using, consuming, or converting the product. For example, a printer using paper reels for a print job for a publisher. The final ShipTo destination for a product is normally to the end user's facilities.

OtherParty

OtherParty is optional. Multiple instances might exist.

An organisation or business entity other than those specifically detailed within a e-Document.

InformationalQuantity

InformationalQuantity is optional. Multiple instances might exist.

A quantity given in a valid UOM used for information purposes only (not for calculation). For example, an ordered quantity was 100 reels as opposed to the invoice quantity of 20,000 pounds.

OtherDate

OtherDate is optional. Multiple instances might exist.

A date that may not be specifically detailed within a document (example: print date at the PurchaseOrderLineItem).

AdditionalText

AdditionalText is optional. Multiple instances might exist.

A text field that is used to communicate information not previously defined or for special instructions. To be used only for circumstances not covered by specific elements.

SafetyAndEnvironmentalInformation

SafetyAndEnvironmentalInformation is optional. Multiple instances might exist.

Name of certification type, if any, on the goods (For example, FSC, PEFC). SafetyAndEnvironmental needs a value or measurement to communicate the percentage of the product is certified (for example, 75% is certified by the indicated agency).

InventoryStatusLineItemDetail

A group element that contains InventoryStatus details.

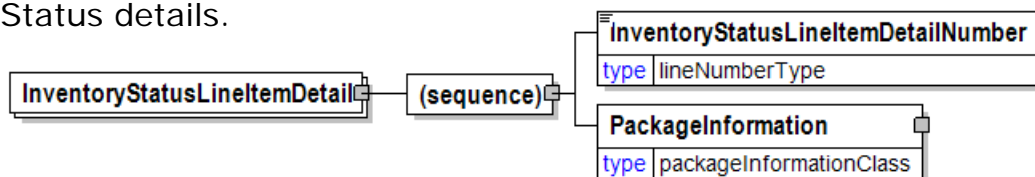

(sequence)

The sequence of items below is mandatory. A single instance is required.

InventoryStatusLineItemDetailNumber

InventoryStatusLineItemDetailNumber is mandatory. A single instance is required.

papiNet V2R31

An identifier that allows for unique identification of the InventoryStatusLineItemDetail.

PackageInformation

PackageInformation is mandatory. A single instance is required.

The purpose of the PackageInformation structure is to clearly identify physical handling items that constitute the delivery.

PackageInformation is the highest level of product packaging it describes the shipping or warehousing unit.

If you are communicating a package, usually for logistics or transport purposes, you should include the PackageType, Identifier, ItemCount, and Quantity. (Note: you still have the ability to describe the item with one of the "named" items.)

If you are communicating one of the named Items there is no need to include PackageType, Identifier, ItemCount, and Quantity.

Since either of these two approaches can be used the entire contents of this element are optional even though the parent may be required. It is expected that you will fill in the appropriate details.

InventoryStatusLineItemDetailNumber

An identifier that allows for unique identification of the InventoryStatusLineItemDetail.

InventoryStatusLineItemDetailNumber
type lineNumberType

InventoryStatusLineItemNumber

An identifier that allows for unique identification of the InventoryStatusLineItem.

InventoryStatusLineItemNumber
type lineNumberType

InventoryStatusNumber

An identifier that allows for unique identification of the InventoryStatus.

InventoryStatusNumber
type s30

InventoryStatusReference

A group item detailing relevant references pertaining to the InventoryChange, identified by

InventoryStatusReference
type s255

attributes
InventoryStatusReferenceType
type referenceType
AssignedBy
type partyType

InventoryStatusReferenceType.

InventoryStatusReferenceType [attribute]

InventoryStatusReferenceType is mandatory. A single instance is required.

Provides a contextual explanation of the specific reference identifier. Many items are currently prefixed by "Buyer", "Forwarder", "Manufacturer", "Mill", "Seller", "Supplier", "Warehouse", or "Vendor". Check for an existing non-prefixed version and use the non-prefixed version instead. In the (yet to be announced release date) version 3.0 the prefixed versions will be removed. Instead the attribute @AssignedBy will communicate the information previously communicated in the prefix.

Refer to InventoryStatusReferenceType definition for any enumerations.

AssignedBy [attribute]

AssignedBy is optional. A single instance might exist.

Identifies the type of party that has assigned the associated item, e.g. a reference of type OrderNumber.

Refer to AssignedBy for any enumerations.

InventoryStatusReferenceType [attribute]

Provides a contextual explanation of the specific reference identifier. Many items are currently prefixed by "Buyer", "Forwarder", "Manufacturer", "Mill", "Seller", "Supplier", "Warehouse", or "Vendor". Check for an existing non-prefixed version and use the non-prefixed version instead. In the (yet to be announced release date) version 3.0 the prefixed versions will be removed. Instead the attribute @AssignedBy will communicate the information previously communicated in the prefix.

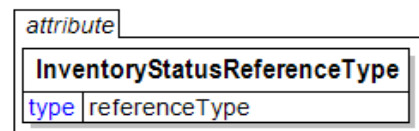

Refer to the [referenceType](#) entry for the list of enumerations and their definitions.

InventoryStatusReportingDetailType [attribute]

Communicates the level of detail in which inventory is to be reported.

This item is restricted to the following list.

AggregatedInventory

Inventory is to be reported in summary.

DetailedInventory

Inventory is reported in detail (using the InventoryStatusLineItemDetail element).

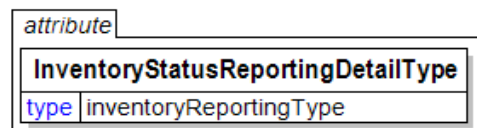

InventoryStatusRequestDetail

A grouping element that provides the parameters to be used when responding with an InventoryStatus e-Document.

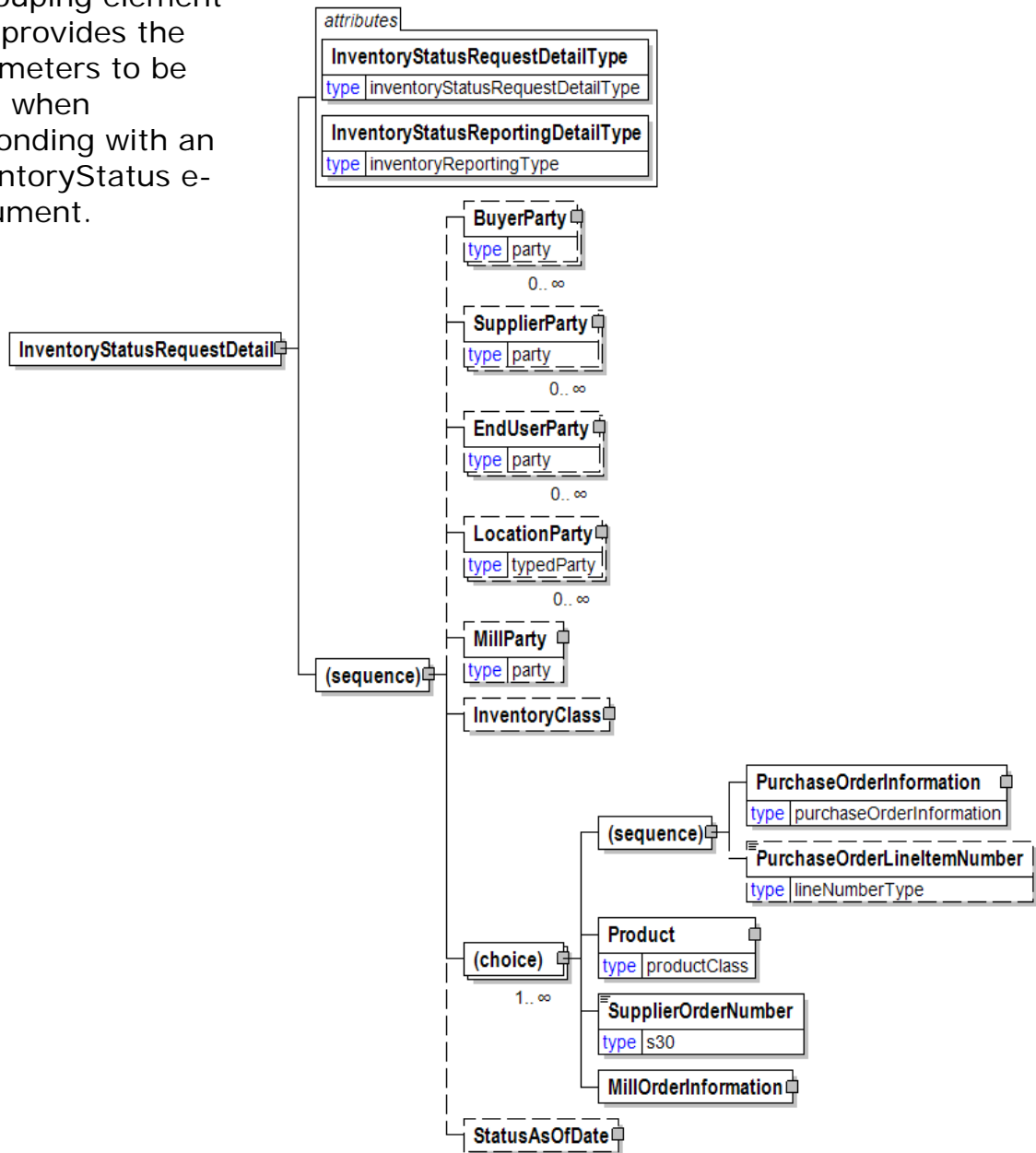

InventoryStatusRequestDetailType [attribute]

InventoryStatusRequestDetailType is mandatory. A single instance is required.

Communicates the method in which the InventoryStatus should be summarized.

Refer to InventoryStatusRequestDetailType definition for any enumerations.

InventoryStatusReportingDetailType [attribute]

InventoryStatusReportingDetailType is mandatory. A single instance is required.

Communicates the level of detail in which inventory is to be reported.

Refer to InventoryStatusReportingDetailType definition for any enumerations.

(sequence)

papiNet V2R31

The sequence of items below is mandatory. A single instance is required.

BuyerParty

BuyerParty is optional. Multiple instances might exist.

The legal entity to which the product is sold. Also commonly referred to as the sold-to party or customer. If no OtherParty is defined as the Payer, the Buyer is the Payer.

SupplierParty

SupplierParty is optional. Multiple instances might exist.

The organisation or business entity responsible for providing the product. SupplierParty is also the seller of the product, if Seller is not specified as OtherParty = Seller.

EndUserParty

EndUserParty is optional. Multiple instances might exist.

The party using, consuming, or converting the product. For example, a printer using paper reels for a print job for a publisher. The final ShipTo destination for a product is normally to the end user's facilities.

LocationParty

LocationParty is optional. Multiple instances might exist.

The organization or business entity where the business event took place or will take place.

MillParty

MillParty is optional. A single instance might exist.

The organisation or business entity that actually produces the product.

InventoryClass

InventoryClass is optional. A single instance might exist.

A group item containing information about status of inventory and goods items.

(choice)

[choice] is optional because of choice construct.

(sequence)

The sequence of items below is mandatory. A single instance is required.

PurchaseOrderInformation

PurchaseOrderInformation is mandatory. A single instance is required.

A group item containing information unique to this PurchaseOrder, which is provided by the buyer. PurchaseOrderInformation can be optional in the supply chain. Invoices are created without having a PurchaseOrder in Vendor Managed Inventory. Freight invoices also will not have a PurchaseOrder number.

PurchaseOrderLineNumber

PurchaseOrderLineNumber is optional. A single instance might exist.

The sequential number that uniquely identifies the PurchaseOrder line item.

Product

Product is optional because of choice construct.

Product is a group item defining the article and its characteristics. Product is used to specify product characteristics organized by ProductIdentifier, ProductDescription, and Classification. Book Manufacturing, Label Stock, Paper,

Pulp, Recovered Paper, Wood Products, and Virgin Fibre market segments have defined their product characteristics and conversion features for implementation in papiNet.

SupplierOrderNumber

SupplierOrderNumber is optional because of choice construct.

The number of the supplier order.

MillOrderInformation

MillOrderInformation is optional because of choice construct.

A group item containing information unique to a mill order.

StatusAsOfDate

StatusAsOfDate is optional. A single instance might exist.

The specific Date and Time for which status is requested. This implies that all open transactions have closed for the date before the status is reported.

InventoryStatusRequestDetailType [attribute]

Communicates the method in which the InventoryStatus should be summarized.

This item is restricted to the following list.

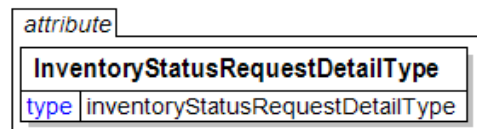

ByMillOrder

By the mill order number and mill order line item number the material was manufactured. MillParty has also to be specified in ByMillOrderInformation to defined the mill order origin.

ByProduct

By product

ByPurchaseOrder

By the PurchaseOrder the material was ordered

BySupplierOrderNumber

By the order the material was manufactured

InventoryStatusSummary

Summary information that applies to the entire InventoryStatus e-Document.

(sequence)

The sequence of items below is mandatory. A single instance is

required.

TotalNumberOfLineItems

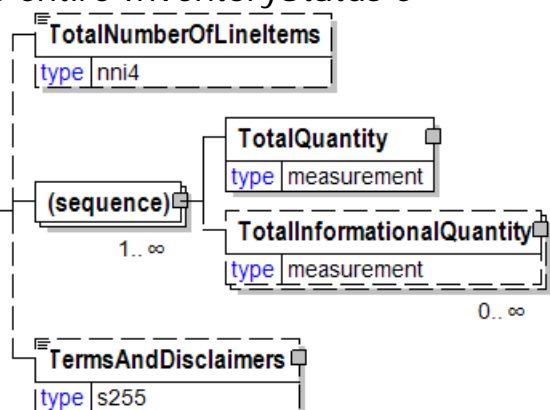

TotalNumberOfLineItems is optional. A single instance might exist.

The total number of individual line items in the document, regardless of the status or type.

(sequence)

The sequence of items below is mandatory. One instance is required, multiple instances might exist.

TotalQuantity

TotalQuantity is mandatory. A single instance is required.

The total quantity of similar items in the e-Document. TotalQuantity is primarily used in the summary section of documents where it is repeatable to permit totaling for different units of measure.

TotalInformationalQuantity

TotalInformationalQuantity is optional. Multiple instances might exist.

A quantity that is used to communicate related information about the parent element. This element represents a total that is derived from individual line items.

TermsAndDisclaimers

TermsAndDisclaimers is optional. A single instance might exist.

An element that contains legal information with an indication of what the Language is.

InventoryStatusType [attribute]

Provides the status type for inventory/goods belonging to a product and/or an order.

This item is restricted to the following list.

Sound

Sound inventory are prime inventory/goods without any damages or defects

Unsound

Unsound inventory/goods are inventory/goods with defects or inventory/goods put on hold for inspection.

attribute	
InventoryStatusType	
type	inventoryStatusType
default	Sound

Invoice

The Invoice element is the root element for the Invoice e-Document.

An Invoice e-Document can handle both debits and credits. Typically a seller sends an Invoice to a buyer after delivering the products or services specified in a PurchaseOrder or as part of an automatic replenishment agreement. Alternatively, an Invoice can be prepared by the buyer as part of a self-billing process. The Invoice is a list of the goods shipped and their quantities, or services rendered, indicating the price, terms of sale, supplemental charges, allowances, and communicates the payment required for the indicated items.

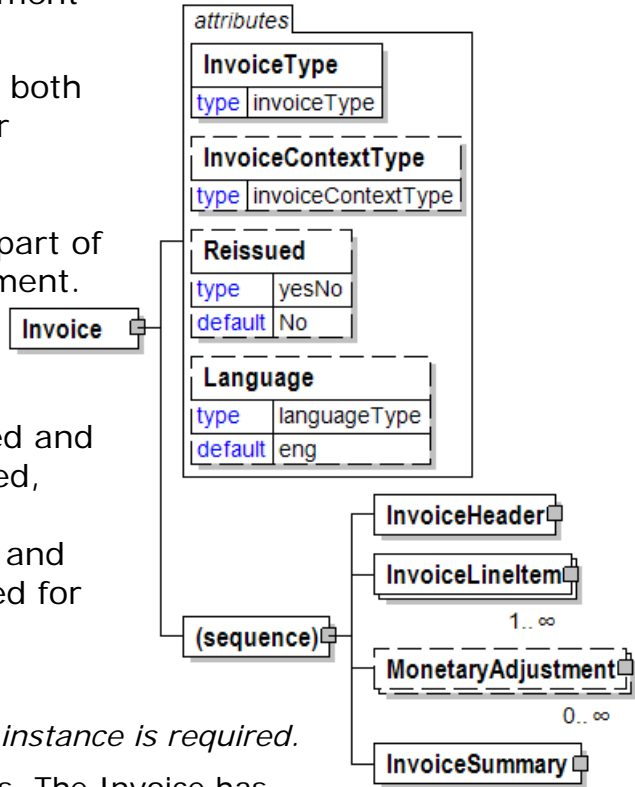

InvoiceType [attribute]

InvoiceType is mandatory. A single instance is required.

Defines the various types of invoices. The Invoice has been checked and found compliant with the EU Council Directive 2001/115/EC in force from 1 January 2004 in existing EU Member States and from 1 May 2004 in the Accession Countries. Directive 2001/115/EC harmonises, simplifies and modernises invoicing obligations on traders when they sell products or services that are subject to Value Added Tax (VAT). It also creates an EU legal framework for electronic transmission and storage of invoices. Refer to http://www.eic.ie/legislation/vat_invoicing.htm for additional information.

Types of invoices not covered in this standard include:

- Delcredere – An invoice sent to the party paying for a number of buyers
- Factored – An invoice assigned to a third party for collection

Refer to InvoiceType definition for any enumerations.

InvoiceContextType [attribute]

InvoiceContextType is optional. A single instance might exist.

Indicates the nature of what is included in the invoice.

Refer to InvoiceContextType definition for any enumerations.

Reissued [attribute]

Reissued is optional. A single instance might exist.

Either "Yes" or "No".

Refer to Reissued definition for any enumerations.

Language [attribute]

Language is optional. A single instance might exist.

XML has embraced 2 and 3 digit language codes through the application of an addendum to the standard.

Refer to Language definition for any enumerations.

(sequence)

The sequence of items below is mandatory. A single instance is required.

InvoiceHeader

InvoiceHeader is mandatory. A single instance is required.

Information that applies to all items on the Invoice.

InvoiceLineItem

InvoiceLineItem is mandatory. One instance is required, multiple instances might exist.

Information for each item on an Invoice.

MonetaryAdjustment

MonetaryAdjustment is optional. Multiple instances might exist.

The element containing the information necessary for the understanding, calculation, and treatment of an adjustment to a currency amount. MonetaryAdjustment contains an attribute that indicates they type of adjustment being communicated.

InvoiceSummary

InvoiceSummary is mandatory. A single instance is required.

Summary information for all items on an invoice.

InvoiceContextType [attribute]

Indicates the nature of what is included in the invoice.

This item is restricted to the following list.

LogisticsService

The invoice is exclusively for logistics services.

Product

The invoice includes product with optional logistics charges.



InvoiceDate

A date that is qualifying the invoicing period. This date often drives payment terms. Note that this date is not necessarily the same as the issue date of the invoice.

(sequence)

The sequence of items below is mandatory. A single instance is required.

Date

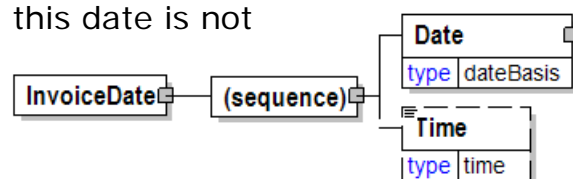

papiNet V2R31

Date is mandatory. A single instance is required.

A group element that contains the specification of Year, Month, and Day.

Time

Time is optional. A single instance might exist.

Times are treated in a standard XML fashion with a special case used to indicate a generalized "local" time. The standard XML approach to time is hh:mm:ss, hh:mm:ssZ, or hh:mm:ss±hh:mm.

hh:mm:ss±hh:mm is used to represent a time with a time zone. The time zone is communicated as the number of hours offset from the Universal Time Coordinate (UTC), a.k.a. Greenwich Mean Time.

hh:mm:ssZ indicates the time at Zulu (another name for UTC). Based on the convention described in the next bullet it will be important for users within UTC to use "Z" when communicating a time in their time zone to other users.

hh:mm:ss or hh:mm indicates in the XML standard the time at UTC however, within papiNet it is used to represent the applicable local time. Caution should be used when processing times of this nature as the papiNet approach may be in discord with other users of XML.

InvoiceDeliveryInformation

A group item that contains delivery information for invoice purposes. The delivery information that is contained will be similar to that on the DeliveryMessage.

(sequence)

The sequence of items below is mandatory. A single instance is required.

DeliveryMessageNumber

DeliveryMessageNumber is mandatory. A single instance is required.

A unique delivery identifier

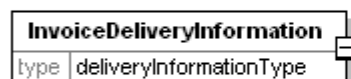

assigned to each DeliveryMessage as agreed between the trading partners.

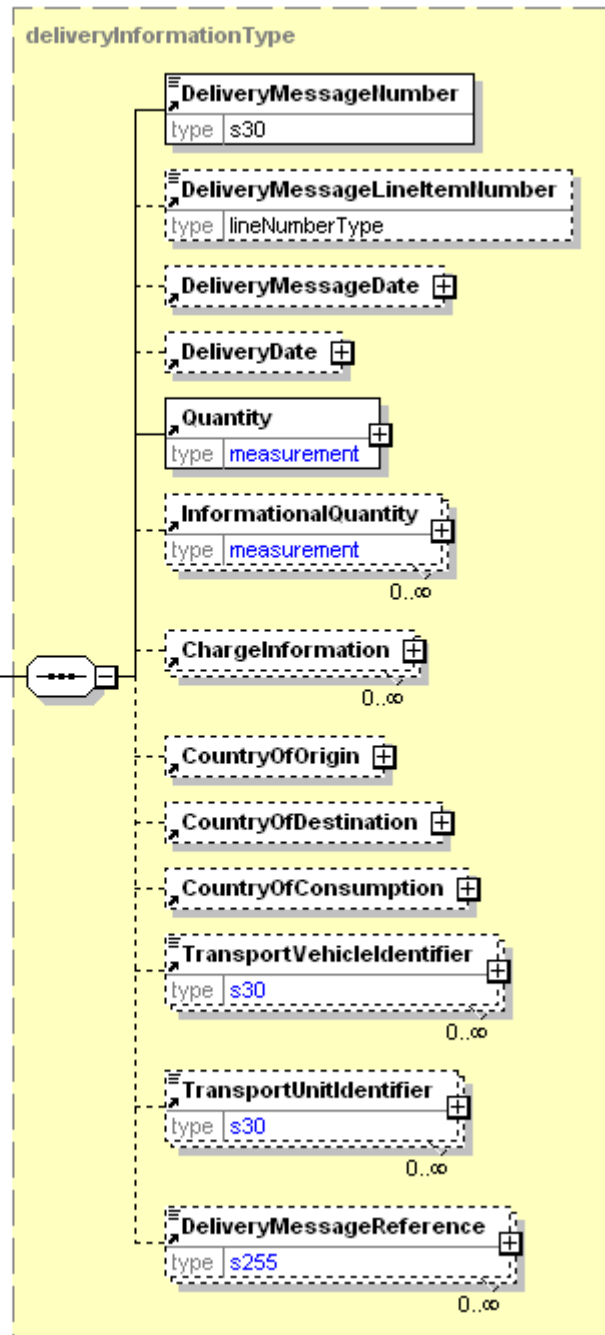

DeliveryMessageLineItemNumber

DeliveryMessageLineItemNumber is optional. A single instance might exist.

The sequential number that uniquely identifies the delivery line item.

DeliveryMessageDate

DeliveryMessageDate is optional. A single instance might exist.

The Date and Time when the DeliveryMessage was issued.

DeliveryDate

DeliveryDate is optional. A single instance might exist.

The Date and optionally the Time that the partners agree is the date upon which deliveries will be recognised. Possible choices for this date are either the date

despatched or the date received.

Quantity

Quantity is mandatory. A single instance is required.

The Quantity element contains attributes that provide information about the type of quantity that is being communicated, the context in which the particular quantity is to be viewed, and (if the quantity represents an adjustment) an adjustment type.

The Quantity element contains three child elements that enable you to communicate a range of values for the quantity and a target or actual value. It is at this level (Value, RangeMin, and RangeMax) that the unit of measure is specified. This permits the range to be specified in a different unit of measure than the target.

InformationalQuantity

InformationalQuantity is optional. Multiple instances might exist.

A quantity given in a valid UOM used for information purposes only (not for calculation). For example, an ordered quantity was 100 reels as opposed to the invoice quantity of 20,000 pounds.

ChargeInformation

ChargeInformation is optional. Multiple instances might exist.

A group element that contains elements that describe a charge.

CountryOfOrigin

CountryOfOrigin is optional. A single instance might exist.

The country of origin for the material.

CountryOfDestination

CountryOfDestination is optional. A single instance might exist.

The country where the goods will be, or were, shipped to.

CountryOfConsumption

CountryOfConsumption is optional. A single instance might exist.

The country of consumption for the material.

TransportVehicleIdentifier

TransportVehicleIdentifier is optional. Multiple instances might exist.

The identifier of the transport vehicle (license plate number, voyage number, or vessel name). TransportVehicleIdentifier contains the TransportVehicleIdentifierType attribute.

TransportUnitIdentifier

TransportUnitIdentifier is optional. Multiple instances might exist.

The identifier of the transport unit, such as a container ID. It could be a license plate number if the transport unit is the vehicle at the same time. The type of identifier is indicated by the TransportUnitIdentifierType.

DeliveryMessageReference

DeliveryMessageReference is optional. Multiple instances might exist.

An element that identifies the relevant references pertaining to the DeliveryMessage, identified by DeliveryMessageReferenceType.

InvoiceHeader

Information that applies to all items on the Invoice.

(sequence)

The sequence of items below is mandatory. A single instance is required.

InvoiceNumber

InvoiceNumber is mandatory. A single instance is required.

The identification number of the invoice, generated by the seller.

InvoiceDate

InvoiceDate is mandatory. A single instance is required.

A date that is qualifying the invoicing period. This date often drives payment terms. Note that this date is not necessarily the same as the issue date of the invoice.

OtherDate

OtherDate is optional. Multiple instances might exist.

A date that may not be specifically detailed within a document (example: print date at the PurchaseOrderLineItem).

InvoiceReference

InvoiceReference is optional. Multiple instances might exist.

A group item detailing relevant references pertaining to the invoice e-Document. InvoiceReferenceType describes the content.

DocumentReferenceInformation

DocumentReferenceInformation is optional. Multiple instances might exist.

A group item containing reference information applicable to a document.

BillToParty

BillToParty is mandatory. A single instance is required.

The address where the invoice is to be sent.

SupplierParty

SupplierParty is mandatory. A single instance is required.

The organisation or business entity responsible for providing the product. SupplierParty is also the seller of the product, if Seller is

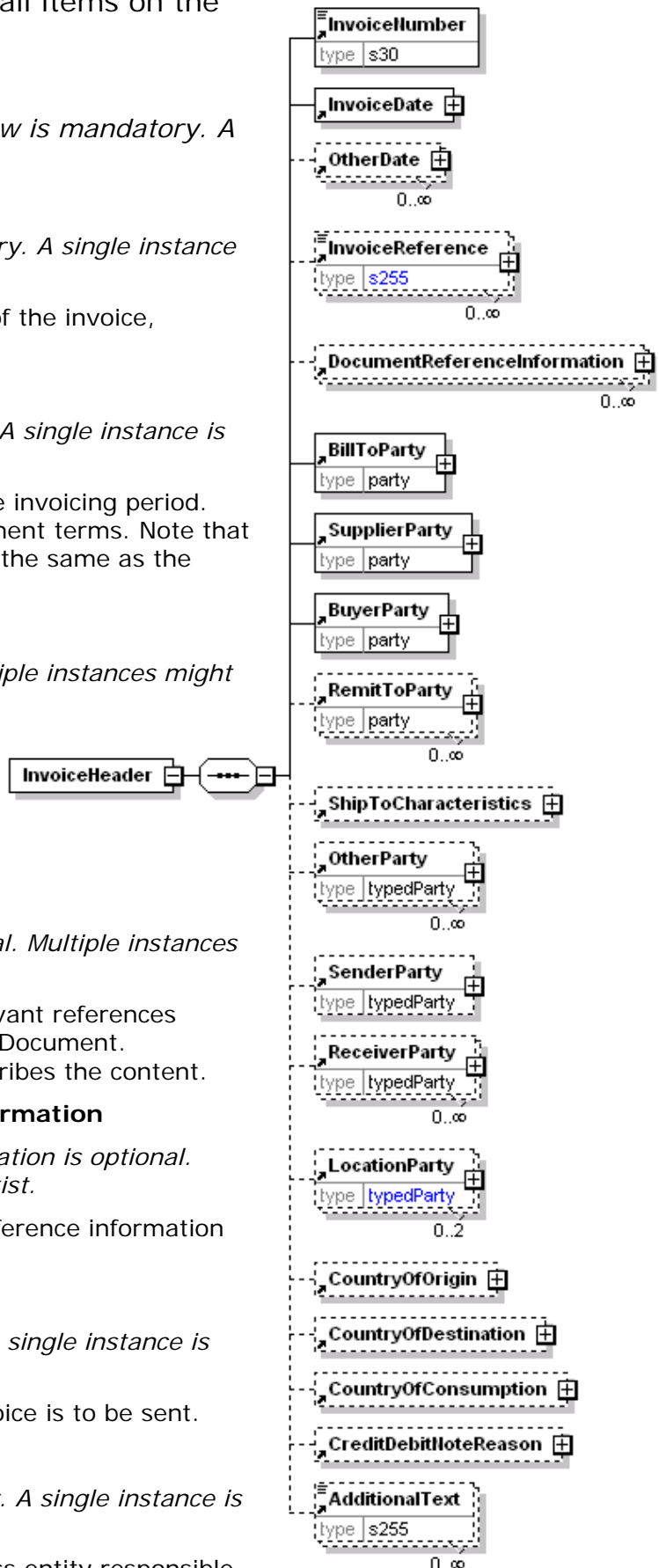

not specified as OtherParty = Seller.

BuyerParty

BuyerParty is mandatory. A single instance is required.

The legal entity to which the product is sold. Also commonly referred to as the sold-to party or customer. If no OtherParty is defined as the Payer, the Buyer is the Payer.

RemitToParty

RemitToParty is optional. Multiple instances might exist.

A group item containing details of the party to whom payment will be made. The RemitToParty contains all information related to remittance.

ShipToCharacteristics

ShipToCharacteristics is optional. A single instance might exist.

A group item that provides information important for the Ship-To Party.

A group item that provides information important for the Ship-To Party. ShipToCharacteristics may be referenced at both the header and line item level. The reference at the header is required and acts as a default for the value at the line level, unless overridden at the line level.

OtherParty

OtherParty is optional. Multiple instances might exist.

An organisation or business entity other than those specifically detailed within a e-Document.

SenderParty

SenderParty is optional. A single instance might exist.

The business entity issuing the e-Document, the source of the document.

The entity responsible for the content. If the sender party has out sourced the message service to a third party the SenderParty is the issuer of the e-Document and not the party performing the transmission service of the electronic message.

ReceiverParty

ReceiverParty is optional. Multiple instances might exist.

The business entity for whom the e-Document is intended, the destination of the document.

The entity interested in the content. If the receiver party has outsourced the message service to a third party the ReceiverParty is the intended party for the e-Document and not the party performing the receiving service of the electronic message.

LocationParty

LocationParty is optional.

The organization or business entity where the business event took place or will take place.

CountryOfOrigin

CountryOfOrigin is optional. A single instance might exist.

The country of origin for the material.

CountryOfDestination

CountryOfDestination is optional. A single instance might exist.

The country where the goods will be, or were, shipped to.

CountryOfConsumption

CountryOfConsumption is optional. A single instance might exist.

The country of consumption for the material.

CreditDebitNoteReason

CreditDebitNoteReason is optional. A single instance might exist.

A group item containing the reason for the entire CreditDebitNote.

AdditionalText

AdditionalText is optional. Multiple instances might exist.

A text field that is used to communicate information not previously defined or for special instructions. To be used only for circumstances not covered by specific elements.

InvoiceLineAmount

The total invoice amount per line (includes adjustments and tax).

InvoiceLineAmount is equal to the

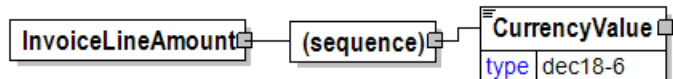

InvoiceLineBaseAmount plus the sum of the signed values of the MonetaryAdjustmentAmount for all instances of MonetaryAdjustment.

(sequence)

The sequence of items below is mandatory. A single instance is required.

CurrencyValue

CurrencyValue is mandatory. A single instance is required.

The amount in the referenced currency as defined by the CurrencyType attribute.

InvoiceLineBaseAmount

A field that contains the result of the calculation Quantity at the InvoiceLineItem level times the

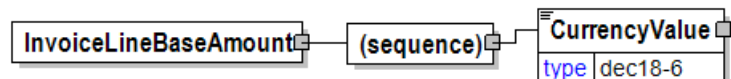

PricePerUnit. As such it

does not include any taxes. It appears at the invoice line

item level. InvoiceLineBaseAmount encapsulates CurrencyValue.

(sequence)

The sequence of items below is mandatory. A single instance is required.

CurrencyValue

CurrencyValue is mandatory. A single instance is required.

The amount in the referenced currency as defined by the CurrencyType attribute.

InvoiceLineBaseAmountInformation

A group item containing the price per unit and the invoice price amount subtotal.

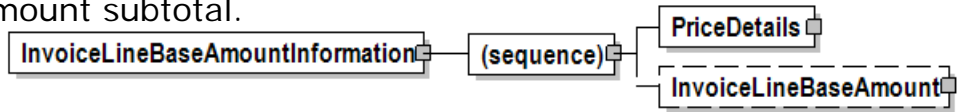

(sequence)

The sequence of items below is mandatory. A single instance is required.

PriceDetails

PriceDetails is mandatory. A single instance is required.

An element that groups together price information.

InvoiceLineBaseAmount

InvoiceLineBaseAmount is optional. A single instance might exist.

A field that contains the result of the calculation Quantity at the InvoiceLineItem level times the PricePerUnit. As such it does not include any taxes. It appears at the invoice line item level. InvoiceLineBaseAmount encapsulates CurrencyValue.

InvoiceLineItem

Information for each item on an Invoice.

IsFinalInvoice [attribute]

IsFinalInvoice is optional. A single instance might exist.

Communicates to the receiver that this is the last invoice so that the customer can “close out” the associated PO as completely invoiced.

Refer to IsFinalInvoice definition for any enumerations.

(sequence)

The sequence of items below is mandatory. A single instance is required.

InvoiceLineItem

InvoiceLineNumber

InvoiceLineNumber is mandatory. A single instance is required.

The sequential number that uniquely identifies the invoice line item. It may enable the invoice to be printed, viewed, or discussed in a common order.

PurchaseOrderInformation

PurchaseOrderInformation is optional. A single instance might exist.

A group item containing information unique to this PurchaseOrder, which is provided by the buyer. PurchaseOrderInformation can be optional in the supply chain. Invoices are created without having a PurchaseOrder in Vendor Managed Inventory. Freight invoices also will not have a PurchaseOrder number.

PurchaseOrderLineItemNumber

PurchaseOrderLineItemNumber is optional. A single instance might exist.

The sequential number that uniquely identifies the PurchaseOrder line item.

ChargeOrAllowance

ChargeOrAllowance is optional. A single instance might exist.

The description of the charge or allowance; such as freight, special handling, and stop-off handling.

Product

Product is optional. A single instance might exist.

Product is a group item defining the article and its characteristics. Product is used to specify product characteristics organized by ProductIdentifier, ProductDescription, and Classification. Book Manufacturing, Label Stock, Paper, Pulp, Recovered Paper, Wood Products, and Virgin Fibre market

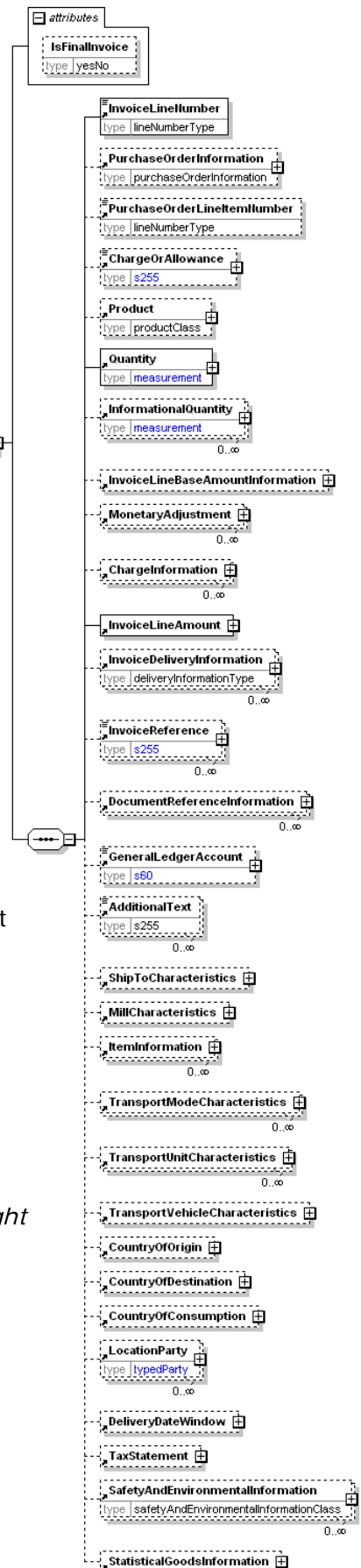

segments have defined their product characteristics and conversion features for implementation in papiNet.

Quantity

Quantity is mandatory. A single instance is required.

The Quantity element contains attributes that provide information about the type of quantity that is being communicated, the context in which the particular quantity is to be viewed, and (if the quantity represents an adjustment) an adjustment type.

The Quantity element contains three child elements that enable you to communicate a range of values for the quantity and a target or actual value. It is at this level (Value, RangeMin, and RangeMax) that the unit of measure is specified. This permits the range to be specified in a different unit of measure than the target.

InformationalQuantity

InformationalQuantity is optional. Multiple instances might exist.

A quantity given in a valid UOM used for information purposes only (not for calculation). For example, an ordered quantity was 100 reels as opposed to the invoice quantity of 20,000 pounds.

InvoiceLineBaseAmountInformation

InvoiceLineBaseAmountInformation is optional. A single instance might exist.

A group item containing the price per unit and the invoice price amount subtotal.

MonetaryAdjustment

MonetaryAdjustment is optional. Multiple instances might exist.

The element containing the information necessary for the understanding, calculation, and treatment of an adjustment to a currency amount. MonetaryAdjustment contains an attribute that indicates the type of adjustment being communicated.

ChargeInformation

ChargeInformation is optional. Multiple instances might exist.

A group element that contains elements that describe a charge.

InvoiceLineAmount

InvoiceLineAmount is mandatory. A single instance is required.

The total invoice amount per line (includes adjustments and tax).

InvoiceLineAmount is equal to the InvoiceLineBaseAmount plus the sum of the signed values of the MonetaryAdjustmentAmount for all instances of MonetaryAdjustment.

InvoiceDeliveryInformation

InvoiceDeliveryInformation is optional. Multiple instances might exist.

A group item that contains delivery information for invoice purposes. The delivery information that is contained will be similar to that on the DeliveryMessage.

InvoiceReference

InvoiceReference is optional. Multiple instances might exist.

A group item detailing relevant references pertaining to the invoice e-Document. InvoiceReferenceType describes the content.

DocumentReferenceInformation

papiNet V2R31

DocumentReferenceInformation is optional. Multiple instances might exist.

A group item containing reference information applicable to a document.

GeneralLedgerAccount

GeneralLedgerAccount is optional. A single instance might exist.

The general ledger account to be referenced for the item.

AdditionalText

AdditionalText is optional. Multiple instances might exist.

A text field that is used to communicate information not previously defined or for special instructions. To be used only for circumstances not covered by specific elements.

ShipToCharacteristics

ShipToCharacteristics is optional. A single instance might exist.

A group item that provides information important for the Ship-To Party.

A group item that provides information important for the Ship-To Party. ShipToCharacteristics may be referenced at both the header and line item level. The reference at the header is required and acts as a default for the value at the line level, unless overridden at the line level.

MillCharacteristics

MillCharacteristics is optional. A single instance might exist.

A group item defining the mill party and machine identifier where a product is or was produced.

ItemInformation

ItemInformation is optional. Multiple instances might exist.

The purpose of the ItemInformation structure is to clearly identify physical items. The attribute ItemType defines the type of physical item. Physical items can be handling units like packages as well as items contained in packages.

TransportModeCharacteristics

TransportModeCharacteristics is optional and repeatable. Multiple instances might exist.

A group item defining the primary mode of transport.

TransportUnitCharacteristics

TransportUnitCharacteristics is optional. Multiple instances might exist.

A group item defining and identifying the primary means of containing the goods. In some instances, the transport unit and vehicle are the same.

TransportVehicleCharacteristics

TransportVehicleCharacteristics is optional. A single instance might exist.

A group item defining the primary means of transporting the goods, such as a side port vessel. In some instances, the transport unit and vehicle are the same.

CountryOfOrigin

CountryOfOrigin is optional. A single instance might exist.

The country of origin for the material.

CountryOfDestination

CountryOfDestination is optional. A single instance might exist.

papiNet V2R31

The country where the goods will be, or were, shipped to.

CountryOfConsumption

CountryOfConsumption is optional. A single instance might exist.

The country of consumption for the material.

LocationParty

LocationParty is optional. Multiple instances might exist.

The organization or business entity where the business event took place or will take place.

DeliveryDateWindow

DeliveryDateWindow is optional. A single instance might exist.

A group item defining the date/time interval for delivery to take place. An element which may contain the estimated date for which delivery is expected. This date is not absolute.

TaxStatement

TaxStatement is optional. A single instance might exist.

A group element for declaration of exception from normal charges of tax and the reason for tax exemption.

SafetyAndEnvironmentalInformation

SafetyAndEnvironmentalInformation is optional. Multiple instances might exist.

Name of certification type, if any, on the goods (For example, FSC, PEFC). SafetyAndEnvironmental needs a value or measurement to communicate the percentage of the product is certified (for example, 75% is certified by the indicated agency).

StatisticalGoodsInformation

StatisticalGoodsInformation is optional. A single instance might exist.

A group item containing statistical information about handled or traded goods.

InvoiceLineNumber

The sequential number that uniquely identifies the invoice line item. It may enable the invoice to be printed, viewed, or discussed in a common order.

InvoiceLineNumber	
type	lineNumberType

InvoiceNumber

The identification number of the papiNet e-Document Invoice. This number uniquely identifies documents for all InvoiceType such as Invoice, DebitNote, CreditNote, Approximate, SelfBillingStatement etc

InvoiceNumber	
type	s30

InvoiceNumberMax

The upper range of invoices being communicated or requested.

InvoiceNumberMax
type s30

InvoiceNumberMin

The lower limit of a range of invoices being communicated or requested.

InvoiceNumberMin
type s30

InvoiceNumberRange

A range of invoices to be considered or reported on.

(sequence)

The sequence of items below is mandatory. A single instance is required.

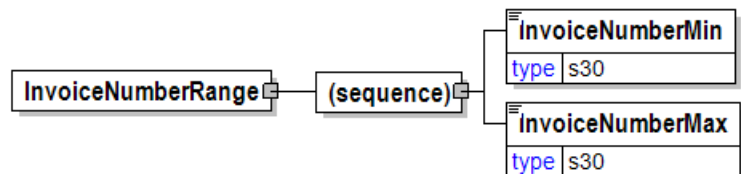

InvoiceNumberMin

InvoiceNumberMin is mandatory. A single instance is required.

The lower limit of a range of invoices being communicated or requested.

InvoiceNumberMax

InvoiceNumberMax is mandatory. A single instance is required.

The upper range of invoices being communicated or requested.

InvoicePrimaryStatus

The primary status of the invoice.

InvoiceStatusCode [attribute]

InvoiceStatusCode is mandatory. A single instance is required.

A code communicating the payment status of an invoice.

Refer to InvoiceStatusCode definition for any enumerations.

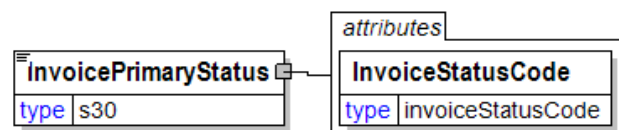

InvoiceProductGroup

Product grouping for invoiced items.

(sequence)

The sequence of items below is mandatory. A single instance is required.

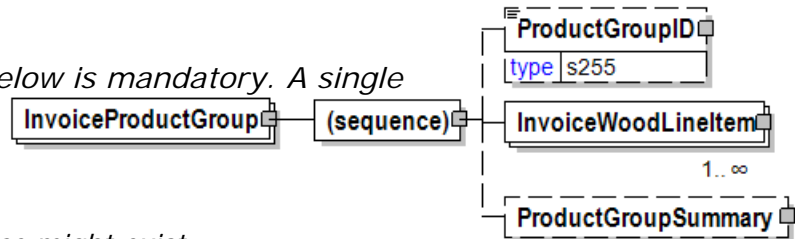

ProductGroupID

ProductGroupID is optional. A single instance might exist.

Possibility to group packages or Shipments. Example: Creating temporary group ID's for logistic reasons or lot number.

InvoiceWoodLineItem

InvoiceWoodLineItem is mandatory. One instance is required, multiple instances might exist.

Specific information for a given item on an Invoice.

Note Business Rule IVW017: At least one instance of either the Product or ChargeOrAllowance elements is required.

ProductGroupSummary

ProductGroupSummary is optional. A single instance might exist.

Group of elements to provide summary information on product level.

InvoiceReference

A group item detailing relevant references pertaining to the invoice e-Document.

InvoiceReferenceType describes the content.

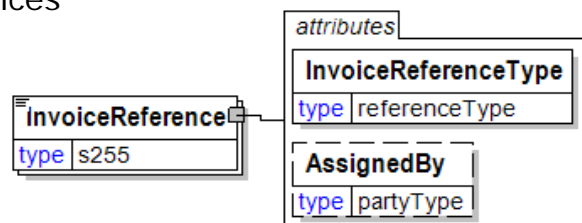

InvoiceReferenceType [attribute]

InvoiceReferenceType is mandatory. A single instance is required.

Provides a contextual explanation of the specific reference identifier. Many items are currently prefixed by "Buyer", "Forwarder", "Manufacturer", "Mill", "Seller", "Supplier", "Warehouse", or "Vendor". Check for an existing non-prefixed version and use the non-prefixed version instead. In the (yet to be announced release date) version 3.0 the prefixed versions will be removed. Instead the attribute @AssignedBy will communicate the information previously communicated in the prefix.

Refer to InvoiceReferenceType definition for any enumerations.

AssignedBy [attribute]

AssignedBy is optional. A single instance might exist.

Identifies the type of party that has assigned the associated item, e.g. a reference of type OrderNumber.

Refer to AssignedBy for any enumerations.

InvoiceReferenceType [attribute]

Provides a contextual explanation of the specific reference identifier. Many items are currently prefixed by "Buyer", "Forwarder", "Manufacturer", "Mill", "Seller", "Supplier", "Warehouse", or "Vendor". Check for an existing non-prefixed version and use the non-prefixed version instead. In the (yet to be announced release date) version 3.0 the prefixed versions will be removed. Instead the attribute @AssignedBy will communicate the information previously communicated in the prefix.

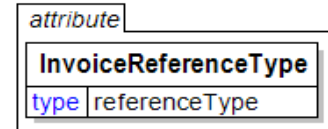

Refer to the [referenceType](#) entry for the list of enumerations and their definitions.

InvoiceSecondaryStatus

The secondary status of the invoice.

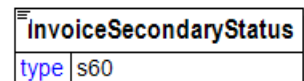

InvoiceShipment

Shipment grouping for invoiced items.

(sequence)

The sequence of items below is mandatory. A single instance is required.

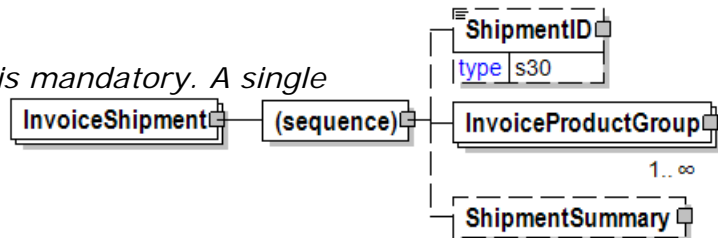

ShipmentID

ShipmentID is optional. A single instance might exist.

The ShipmentID may be a Bill of Lading Marking, which is customer's reference mark on each package used for logistic purposes. Should not be mixed up with Bill of Lading number. Another example of ShipmentID is grouping by a ContainerID.

InvoiceProductGroup

InvoiceProductGroup is mandatory. One instance is required, multiple instances might exist.

Product grouping for invoiced items.

ShipmentSummary

ShipmentSummary is optional. A single instance might exist.

Summery information for an entire shipment

InvoiceStatusCode [attribute]

A code communicating the payment status of an invoice.

This item is restricted to the following list.

attribute
InvoiceStatusCode
type invoiceStatusCode

Unpaid

No payments were booked against this invoice.

PartiallyPaid

Payments have been booked against this invoice, but the invoice is not completely paid and cleared.

Cleared

The invoice is paid to such an extent that no other money is expected or required.

InvoiceSummary

Summary information for all items on an invoice.

(sequence)

The sequence of items below is mandatory. A single instance is required.

TotalNumberOfLineItems

TotalNumberOfLineItems is optional. A single instance might exist.

The total number of individual line items in the document, regardless of the status or type.

(sequence)

The sequence of items below is optional. Multiple instances might exist.

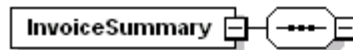

TotalQuantity

TotalQuantity is mandatory. A single instance is required.

The total quantity of similar items in the e-Document. TotalQuantity is primarily used in the summary section of documents where it is repeatable to permit totaling for different units of measure.

TotalInformationalQuantity

TotalInformationalQuantity is optional. Multiple instances might exist.

A quantity that is used to communicate related information about the parent element. This element represents a total that is derived from individual line items.

LineItemSubTotal

LineItemSubTotal is optional. A single instance might exist.

The total amount of all e-Document LineBaseAmount(s) line items without any monetary adjustments that may occur after the e-Document line items.

TotalAdjustments

TotalAdjustments is optional. A single instance might exist.

The CurrencyValue of TotalAdjustments contains the total of all MonetaryAdjustmentAmount for all instances of PriceAdjustment and FlatAmountAdjustment in the document (it excludes TaxAdjustments).

TotalTaxAmount

TotalTaxAmount is optional. A single instance might exist.

The CurrencyValue of TotalTaxAmount contains the sum of all instances of

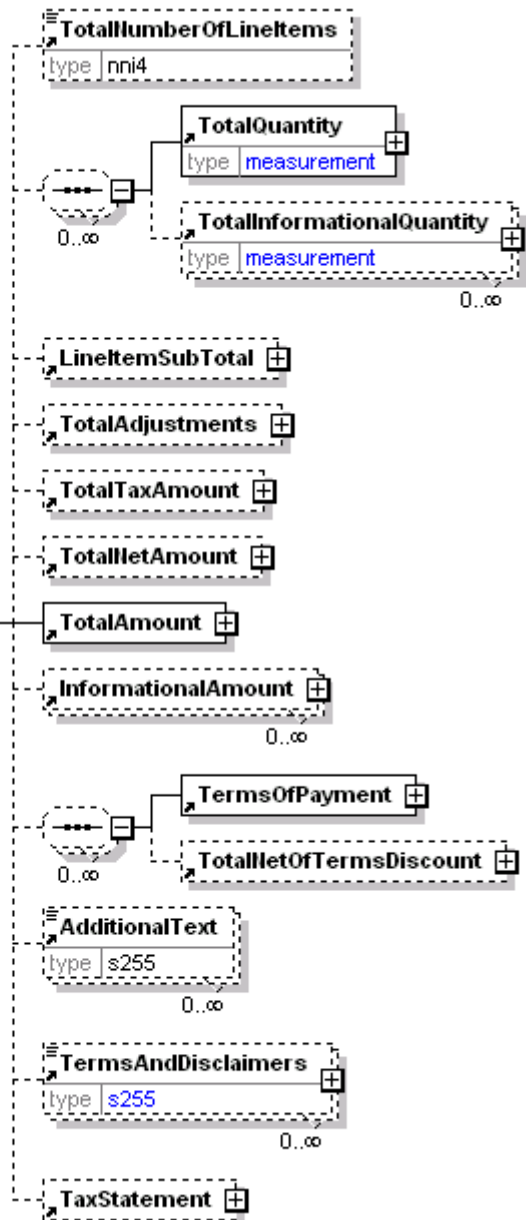

papiNet V2R31

TaxAdjustment in the document. TotalTaxAmount contains the sum of all instances of the MonetaryAdjustmentAmount for tax adjustments.

TotalNetAmount

TotalNetAmount is optional. A single instance might exist.

A field containing total amount excluding tax. For example, in the Invoice TotalNetAmount is equal to the sum of LineItemSubTotal plus TotalAdjustments. TotalNetAmount encapsulates CurrencyValue.

TotalAmount

TotalAmount is mandatory. A single instance is required.

The total amount including tax.

In e-Documents claiming payment this is the amount due for payment based on the terms of payment. Decimal rounding might be applied to this amount.

InformationalAmount

InformationalAmount is optional. Multiple instances might exist.

A monetary amount used for information purposes only (not for calculation). For example, the invoice price adjustment subtotal is expressed in sterling pounds, and the buyer wants this information expressed in U.S. dollars.

CreditDebitNote and Invoice - The TaxAmount is displayed in the currency that is applicable throughout the e-Document. When a TaxAmount needs to be displayed in a different national currency, this field is used.

(sequence)

The sequence of items below is optional. Multiple instances might exist.

TermsOfPayment

TermsOfPayment is mandatory. A single instance is required.

A group item that contains agreed-to terms defining when, how, and under what conditions the payment is to be made.

When TermsOfPayment is optional; if omitted, TermsOfPayment is controlled through previous negotiation.

TotalNetOfTermsDiscount

TotalNetOfTermsDiscount is optional. A single instance might exist.

The components of the amount to be paid if prompt payment discount terms are met, including the amount that is subject to the payment terms discount, the discount amount, and the amount due after prompt payment discount.

AdditionalText

AdditionalText is optional. Multiple instances might exist.

A text field that is used to communicate information not previously defined or for special instructions. To be used only for circumstances not covered by specific elements.

TermsAndDisclaimers

TermsAndDisclaimers is optional. Multiple instances might exist.

An element that contains legal information with an indication of what the Language is.

TaxStatement

TaxStatement is optional. A single instance might exist.

A group element for declaration of exception from normal charges of tax and the reason for tax exemption.

InvoiceType [attribute]

Defines the various types of invoices. The Invoice has been checked and found compliant with the EU Council Directive 2001/115/EC in force from 1 January 2004 in existing EU Member States and from 1 May 2004 in the Accession Countries. Directive 2001/115/EC harmonises, simplifies and modernises invoicing obligations on traders when they sell products or services that are subject to Value Added Tax (VAT). It also creates an EU legal framework for electronic transmission and storage of invoices. Refer to http://www.eic.ie/legislation/vat_invoicing.htm for additional information.

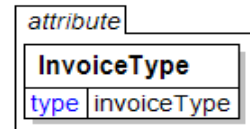

Types of invoices not covered in this standard include:

- Delcredere – An invoice sent to the party paying for a number of buyers
- Factored – An invoice assigned to a third party for collection

This item is restricted to the following list.

Approximate

An invoice that is created to record ownership transfer without the material physically being moved. Typically what occurs is that the buyer has agreed to take ownership of the item at a certain point in time but has not arranged for transportation. Approximate invoices are invoices that are claiming payment.

CreditNote

Credits that are provided for amount reductions and complaints. A CreditNode will normally have a reference to an earlier issued Invoice.

DebitNote

A DebitNote claims payment for additional charges. A DebitNote normally has a reference to an earlier issued Invoice.

Duplicate

To be removed in a future version. When an invoice is reissued as a duplicate the invoice type should be the same as on the original invoice. Use attribute Reissued = Yes to indicate a duplicate.

Invoice

A regular invoice (referred to as an invoice) claims payment for products, services, and charges supplied under conditions agreed to between seller and buyer. The invoice communicates, among other things, payment terms, payment method, and the payment amount required for one or more deliveries.

PrePayment

A prepayment invoice is used as a notification of amounts to be paid in advance. It is not a legal invoice claiming payment for provided products or services.

ProForma

A pro-forma invoice is not a legal invoice claiming payment. A pro-forma invoice is an e-Document serving as a preliminary invoice, containing on the whole the same information as the final invoice, but not actually claiming payment. Pro-forma invoices are typically used in a cross-border shipment for customs purposes. Can travel with the product or be sent to a broker.

SelfBillingStatement

A SelfBillingStatement is an invoice that is prepared by the buyer of the product (or the consumer of the service) for the provider of the product or service. The preparer will pay the invoice.

Typically, logistics cost-charges are the services that are communicated. They are incurred during a certain period of time between the party who provides the logistics services (typically the party with a LogisticsRole of "LogisticsProvider") and the requestor of such services (typically the party with a LogisticsRole of "Consignor").

Raw materials, maintenance, repair, and operating supplies are examples of products that can be entered on a self billing statement for products. This type of invoice is also referred to as an invoice for "evaluated receipts" because it developed from the receiving department's evaluation of their receipts and from that creating the invoice.

The SelfBillingStatement process exists when there is a great deal of trust between the trading partners that permits this cost savings business process.

InvoiceWood

The InvoiceWood element is the root element for the InvoiceWood e-Document.

An InvoiceWood e-Document can handle both debits and credits. Typically a seller sends an InvoiceWood to a buyer after delivering the products or services specified in a PurchaseOrder or as part of an automatic replenishment agreement.

Alternatively, an InvoiceWood can be prepared by the buyer as part of a self-billing process. The InvoiceWood is a list of the goods shipped and their quantities, or services rendered, indicating the price, terms of sale, supplemental charges, allowances, and communicates the payment required for the indicated items.

InvoiceType [attribute]

InvoiceType is mandatory. A single instance is

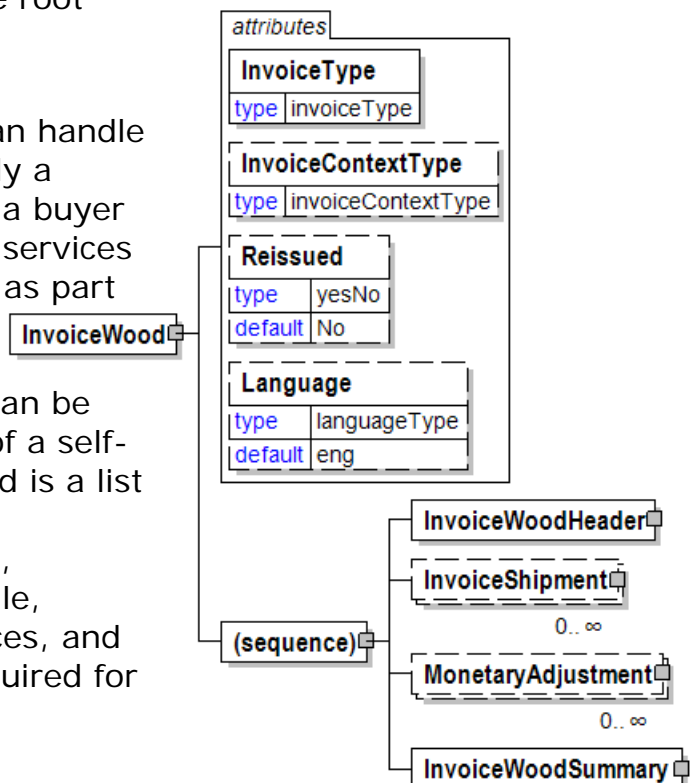

required.

Defines the various types of invoices. The Invoice has been checked and found compliant with the EU Council Directive 2001/115/EC in force from 1 January 2004 in existing EU Member States and from 1 May 2004 in the Accession Countries. Directive 2001/115/EC harmonises, simplifies and modernises invoicing obligations on traders when they sell products or services that are subject to Value Added Tax (VAT). It also creates an EU legal framework for electronic transmission and storage of invoices. Refer to http://www.eic.ie/legislation/vat_invoicing.htm for additional information.

Types of invoices not covered in this standard include:

Delcredere – An invoice sent to the party paying for a number of buyers

Factored – An invoice assigned to a third party for collection

Refer to InvoiceType definition for any enumerations.

InvoiceContextType [attribute]

InvoiceContextType is optional. A single instance might exist.

Indicates the nature of what is included in the invoice.

Refer to InvoiceContextType definition for any enumerations.

Reissued [attribute]

Reissued is optional. A single instance might exist.

Either "Yes" or "No".

Refer to Reissued definition for any enumerations.

Language [attribute]

Language is optional. A single instance might exist.

XML has embraced 2 and 3 digit language codes through the application of an addendum to the standard.

Refer to Language definition for any enumerations.

(sequence)

The sequence of items below is mandatory. A single instance is required.

InvoiceWoodHeader

InvoiceWoodHeader is mandatory. A single instance is required.

This element contains the information that is consistent for the entire InvoiceWood document.

InvoiceShipment

InvoiceShipment is optional. Multiple instances might exist.

Shipment grouping for invoiced items.

MonetaryAdjustment

MonetaryAdjustment is optional. Multiple instances might exist.

The element containing the information necessary for the understanding, calculation, and treatment of an adjustment to a currency amount.

MonetaryAdjustment contains an attribute that indicates they type of adjustment being communicated.

InvoiceWoodSummary

InvoiceWoodSummary is mandatory. A single instance is required.

Summary information that applies to all items on a Wood Market Segment Invoice.

InvoiceWoodHeader

This element contains the information that is consistent for the entire InvoiceWood document.

(sequence)

The sequence of items below is mandatory. A single instance is required.

InvoiceNumber

InvoiceNumber is mandatory. A single instance is required.

The identification number of the papiNet e-Document Invoice. This number uniquely identifies documents for all InvoiceType such as Invoice, DebitNote, CreditNote, Approximate, SelfBillingStatement etc

InvoiceDate

InvoiceDate is mandatory. A single instance is required.

A date that is qualifying the invoicing period. This date often drives payment terms. Note that this date is not necessarily the same as the issue date of the invoice.

OtherDate

OtherDate is optional. Multiple instances might exist.

A date that may not be specifically detailed within a document (example: print date at the PurchaseOrderLineItem).

InvoiceReference

InvoiceReference is optional. Multiple instances might exist.

A group item detailing relevant references pertaining to the invoice e-Document. InvoiceReferenceType describes the content.

BillToParty

BillToParty is mandatory. A single instance is required.

The address where the invoice is to be sent.

SupplierParty

SupplierParty is mandatory. A single instance is required.

The organisation or business entity responsible for providing the product. SupplierParty is also the seller of the product, if Seller is not specified as OtherParty = Seller.

BuyerParty

BuyerParty is mandatory. A single instance is required.

The legal entity to which the product is sold. Also commonly referred to as the sold-to party or customer. If no OtherParty is defined as the Payer, the Buyer is the Payer.

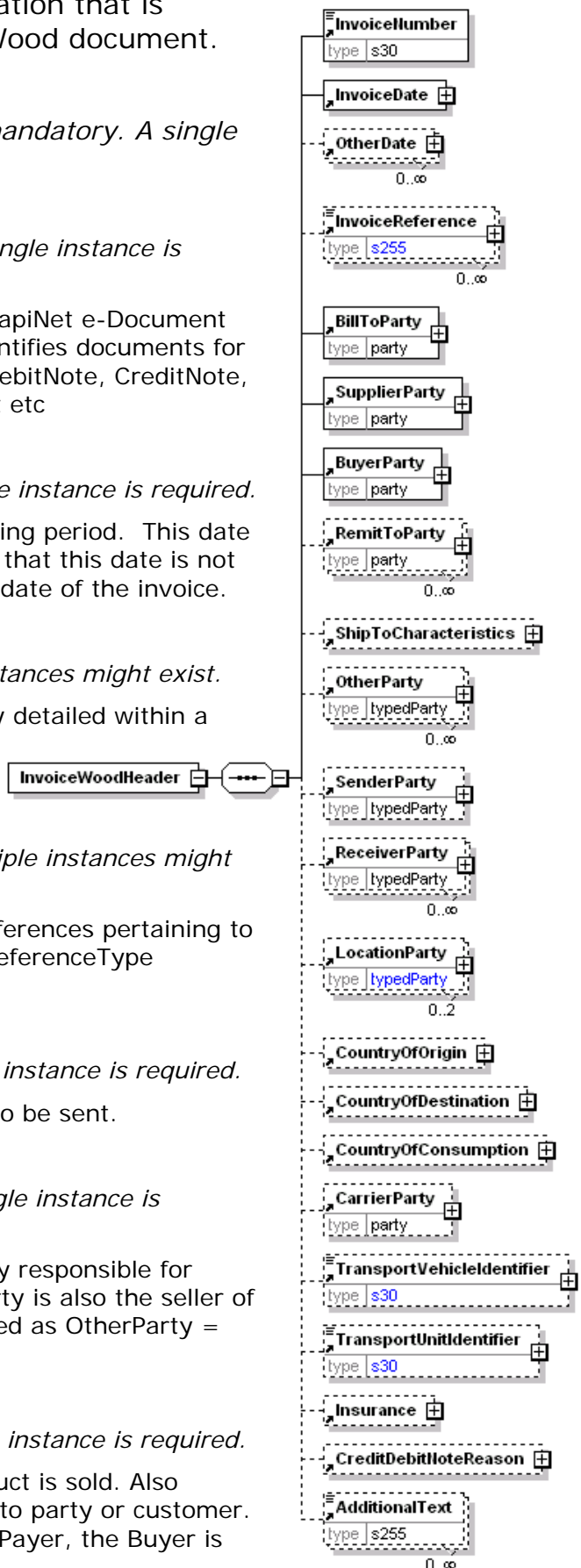

RemitToParty

RemitToParty is optional. Multiple instances might exist.

A group item containing details of the party to whom payment will be made. The RemitToParty contains all information related to remittance.

ShipToCharacteristics

ShipToCharacteristics is optional. A single instance might exist.

A group item that provides information important for the Ship-To Party.

A group item that provides information important for the Ship-To Party. ShipToCharacteristics may be referenced at both the header and line item level. The reference at the header is required and acts as a default for the value at the line level, unless overridden at the line level.

OtherParty

OtherParty is optional. Multiple instances might exist.

An organisation or business entity other than those specifically detailed within a e-Document.

SenderParty

SenderParty is optional. A single instance might exist.

The business entity issuing the e-Document, the source of the document.

The entity responsible for the content. If the sender party has out sourced the message service to a third party the SenderParty is the issuer of the e-Document and not the party performing the transmission service of the electronic message.

ReceiverParty

ReceiverParty is optional. Multiple instances might exist.

The business entity for whom the e-Document is intended, the destination of the document.

The entity interested in the content. If the receiver party has outsourced the message service to a third party the ReceiverParty is the intended party for the e-Document and not the party performing the receiving service of the electronic message.

LocationParty

LocationParty is optional.

The organization or business entity where the business event took place or will take place.

CountryOfOrigin

CountryOfOrigin is optional. A single instance might exist.

The country of origin for the material.

CountryOfDestination

CountryOfDestination is optional. A single instance might exist.

The country where the goods will be, or were, shipped to.

CountryOfConsumption

CountryOfConsumption is optional. A single instance might exist.

The country of consumption for the material.

CarrierParty

CarrierParty is optional. A single instance might exist.

The party performing the transport of the product from the pickup location to the ship-to location; could be a hauler.

TransportVehicleIdentifier

TransportVehicleIdentifier is optional. A single instance might exist.

The identifier of the transport vehicle (license plate number, voyage number, or vessel name). TransportVehicleIdentifier contains the TransportVehicleIdentifierType attribute.

TransportUnitIdentifier

TransportUnitIdentifier is optional. A single instance might exist.

The identifier of the transport unit, such as a container ID. It could be a license plate number if the transport unit is the vehicle at the same time. The type of identifier is indicated by the TransportUnitIdentifierType.

Insurance

Insurance is optional. A single instance might exist.

Group element containing information about insurance

CreditDebitNoteReason

CreditDebitNoteReason is optional. A single instance might exist.

A group item containing the reason for the entire CreditDebitNote.

AdditionalText

AdditionalText is optional. Multiple instances might exist.

A text field that is used to communicate information not previously defined or for special instructions. To be used only for circumstances not covered by specific elements.

InvoiceWoodLineItem

Specific information for a given item on an Invoice.

Note Business Rule IVW017: At least one instance of either the Product or ChargeOrAllowance elements is required.

(sequence)

The sequence of items below is mandatory. A single instance is required.

InvoiceLineNumber

InvoiceLineNumber is mandatory. A single instance is required.

The sequential number that uniquely identifies the invoice line item. It may enable the invoice to be printed, viewed, or discussed in a common order.

PurchaseOrderInformation

PurchaseOrderInformation is optional. A single instance might exist.

A group item containing information unique to this PurchaseOrder, which is provided by the buyer. PurchaseOrderInformation can be optional in the supply chain. Invoices are created without having a PurchaseOrder in Vendor Managed Inventory. Freight invoices also will not have a PurchaseOrder number.

PurchaseOrderLineItemNumber

PurchaseOrderLineItemNumber is optional. A single instance might exist.

The sequential number that uniquely identifies the PurchaseOrder line item.

DocumentReferenceInformation

DocumentReferenceInformation is optional. Multiple instances might exist.

A group item containing reference information applicable to a document.

EndsDiscountInformation

EndsDiscountInformation is optional. A single instance might exist.

Rule for calculating the ends discount, expressed by a code.

ChargeOrAllowance

ChargeOrAllowance is optional. A single instance might exist.

The description of the charge or allowance; such as freight, special handling, and stop-off handling.

Product

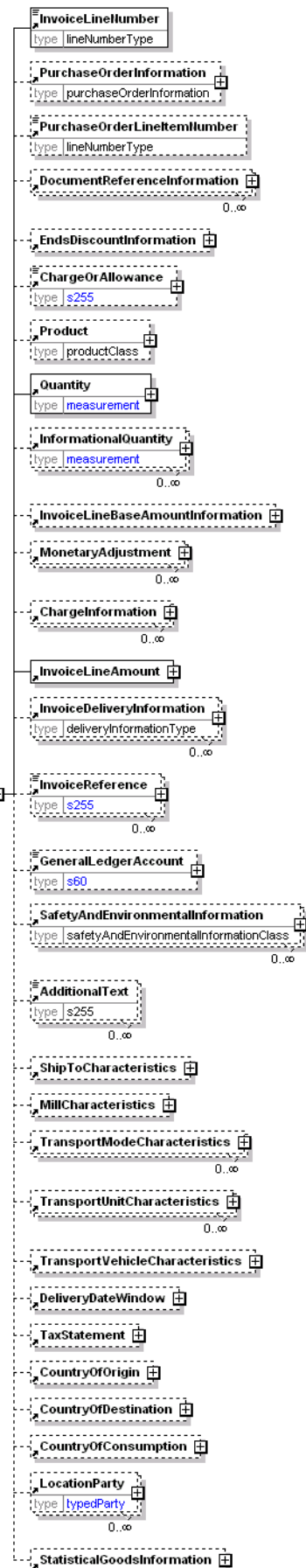

Product is optional. A single instance might exist.

Product is a group item defining the article and its characteristics. Product is used to specify product characteristics organized by ProductIdentifier, ProductDescription, and Classification. Book Manufacturing, Label Stock, Paper, Pulp, Recovered Paper, Wood Products, and Virgin Fibre market segments have defined their product characteristics and conversion features for implementation in papiNet.

Quantity

Quantity is mandatory. A single instance is required.

The Quantity element contains attributes that provide information about the type of quantity that is being communicated, the context in which the particular quantity is to be viewed, and (if the quantity represents an adjustment) an adjustment type.

The Quantity element contains three child elements that enable you to communicate a range of values for the quantity and a target or actual value. It is at this level (Value, RangeMin, and RangeMax) that the unit of measure is specified. This permits the range to be specified in a different unit of measure than the target.

InformationalQuantity

InformationalQuantity is optional. Multiple instances might exist.

A quantity given in a valid UOM used for information purposes only (not for calculation). For example, an ordered quantity was 100 reels as opposed to the invoice quantity of 20,000 pounds.

InvoiceLineBaseAmountInformation

InvoiceLineBaseAmountInformation is optional. A single instance might exist.

A group item containing the price per unit and the invoice price amount subtotal.

MonetaryAdjustment

MonetaryAdjustment is optional. Multiple instances might exist.

The element containing the information necessary for the understanding, calculation, and treatment of an adjustment to a currency amount. MonetaryAdjustment contains an attribute that indicates they type of adjustment being communicated.

ChargeInformation

ChargeInformation is optional. Multiple instances might exist.

A group element that contains elements that describe a charge.

InvoiceLineAmount

InvoiceLineAmount is mandatory. A single instance is required.

The total invoice amount per line (includes adjustments and tax).

InvoiceLineAmount is equal to the InvoiceLineBaseAmount plus the sum of the signed values of the MonetaryAdjustmentAmount for all instances of MonetaryAdjustment.

InvoiceDeliveryInformation

InvoiceDeliveryInformation is optional. Multiple instances might exist.

A group item that contains delivery information for invoice purposes. The delivery information that is contained will be similar to that on the DeliveryMessage.

InvoiceReference

InvoiceReference is optional. Multiple instances might exist.

A group item detailing relevant references pertaining to the invoice e-Document. InvoiceReferenceType describes the content.

GeneralLedgerAccount

GeneralLedgerAccount is optional. A single instance might exist.

The general ledger account to be referenced for the item.

SafetyAndEnvironmentalInformation

SafetyAndEnvironmentalInformation is optional. Multiple instances might exist.

Name of certification type, if any, on the goods (For example, FSC, PEFC). SafetyAndEnvironmental needs a value or measurement to communicate the percentage of the product is certified (for example, 75% is certified by the indicated agency).

AdditionalText

AdditionalText is optional. Multiple instances might exist.

A text field that is used to communicate information not previously defined or for special instructions. To be used only for circumstances not covered by specific elements.

ShipToCharacteristics

ShipToCharacteristics is optional. A single instance might exist.

A group item that provides information important for the Ship-To Party.

A group item that provides information important for the Ship-To Party. ShipToCharacteristics may be referenced at both the header and line item level. The reference at the header is required and acts as a default for the value at the line level, unless overridden at the line level.

MillCharacteristics

MillCharacteristics is optional. A single instance might exist.

A group item defining the mill party and machine identifier where a product is or was produced.

TransportModeCharacteristics

TransportModeCharacteristics is optional and repeatable .Multiple instances might exist.

A group item defining the primary mode of transport.

TransportUnitCharacteristics

TransportUnitCharacteristics is optional. Multiple instances might exist.

A group item defining and identifying the primary means of containing the goods. In some instances, the transport unit and vehicle are the same.

TransportVehicleCharacteristics

TransportVehicleCharacteristics is optional. A single instance might exist.

A group item defining the primary means of transporting the goods, such as a side port vessel. In some instances, the transport unit and vehicle are the same.

DeliveryDateWindow

DeliveryDateWindow is optional. A single instance might exist.

A group item defining the date/time interval for delivery to take place. An element which may contain the estimated date for which delivery is expected. This date is

not absolute.

TaxStatement

TaxStatement is optional. A single instance might exist.

A group element for declaration of exception from normal charges of tax and the reason for tax exemption.

CountryOfOrigin

CountryOfOrigin is optional. A single instance might exist.

The country of origin for the material.

CountryOfDestination

CountryOfDestination is optional. A single instance might exist.

The country where the goods will be, or were, shipped to.

CountryOfConsumption

CountryOfConsumption is optional. A single instance might exist.

The country of consumption for the material.

LocationParty

LocationParty is optional. Multiple instances might exist.

The organization or business entity where the business event took place or will take place.

StatisticalGoodsInformation

StatisticalGoodsInformation is optional. A single instance might exist.

A group item containing statistical information about handled or traded goods.

InvoiceWoodSummary

Summary information that applies to all items on a Wood Market Segment Invoice.

(sequence)

The sequence of items below is mandatory. A single instance is required.

TotalNumberOfLineItems

TotalNumberOfLineItems is mandatory. A single instance is required.

The total number of individual line items in the document, regardless of the status or type.

(sequence)

The sequence of items below is mandatory. One instance is required, multiple instances might exist.

TotalQuantity

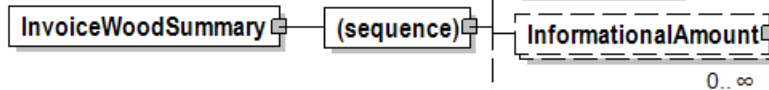

TotalQuantity is mandatory. A single instance is required.

The total quantity of similar items in the e-Document. TotalQuantity is primarily used in the summary section of documents where it is repeatable to permit totaling for different units of measure.

TotalInformationalQuantity

TotalInformationalQuantity is optional. Multiple instances might exist.

A quantity that is used to communicate related information about the parent element. This element represents a total that is derived from individual line items.

LineItemSubTotal

LineItemSubTotal is optional. A single instance might exist.

The total amount of all e-Document LineBaseAmount(s) line items without any monetary adjustments that may occur after the e-Document line items.

TotalAdjustments

TotalAdjustments is optional. A single instance might exist.

The CurrencyValue of TotalAdjustments contains the total of all MonetaryAdjustmentAmount for all instances of PriceAdjustment and FlatAmountAdjustment in the document (it excludes TaxAdjustments).

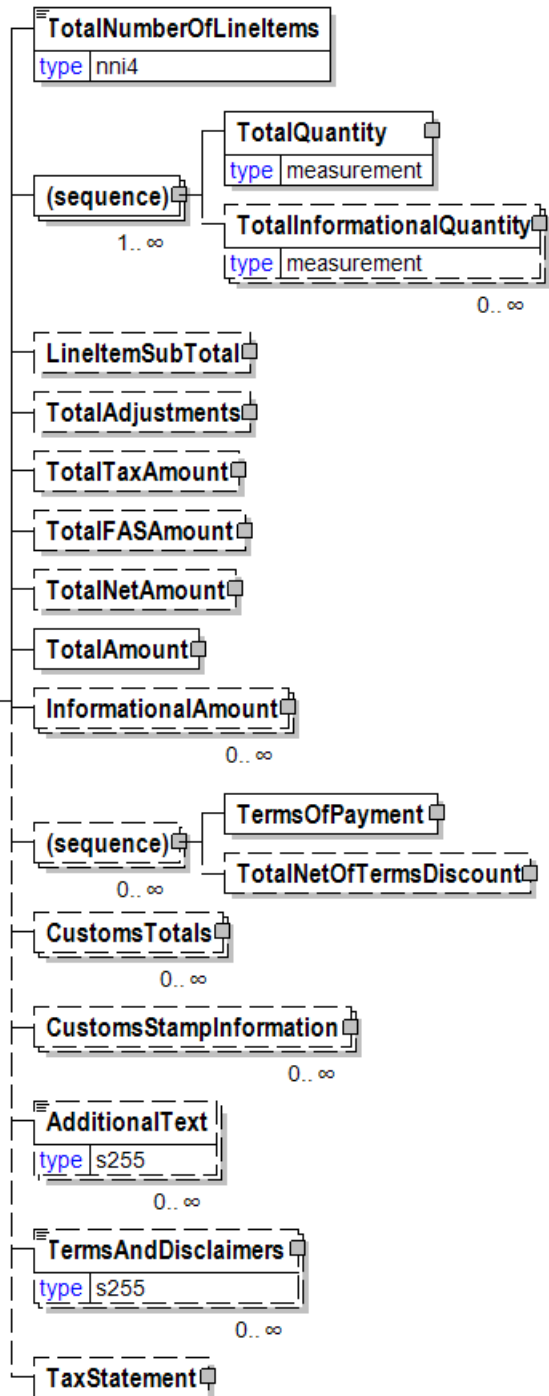

TotalTaxAmount

TotalTaxAmount is optional. A single instance might exist.

The CurrencyValue of TotalTaxAmount contains the sum of all instances of TaxAdjustment in the document. TotalTaxAmount contains the sum of all instances of the MonetaryAdjustmentAmount for tax adjustments.

TotalFASAmount

TotalFASAmount is optional. A single instance might exist.

TotalFASAmount is the total Free Alongside Ship value.

TotalNetAmount

TotalNetAmount is optional. A single instance might exist.

A field containing total amount excluding tax. For example, in the Invoice TotalNetAmount is equal to the sum of LineItemSubTotal plus TotalAdjustments. TotalNetAmount encapsulates CurrencyValue.

TotalAmount

TotalAmount is mandatory. A single instance is required.

The total amount including tax.

In e-Documents claiming payment this is the amount due for payment based on the terms of payment. Decimal rounding might be applied to this amount.

InformationalAmount

InformationalAmount is optional. Multiple instances might exist.

A monetary amount used for information purposes only (not for calculation). For example, the invoice price adjustment subtotal is expressed in sterling pounds, and the buyer wants this information expressed in U.S. dollars.

CreditDebitNote and Invoice - The TaxAmount is displayed in the currency that is applicable throughout the e-Document. When a TaxAmount needs to be displayed in a different national currency, this field is used.

(sequence)

The sequence of items below is optional. Multiple instances might exist.

TermsOfPayment

TermsOfPayment is mandatory. A single instance is required.

A group item that contains agreed-to terms defining when, how, and under what conditions the payment is to be made.

When TermsOfPayment is optional; if omitted, TermsOfPayment is controlled through previous negotiation.

TotalNetOfTermsDiscount

TotalNetOfTermsDiscount is optional. A single instance might exist.

The components of the amount to be paid if prompt payment discount terms are met, including the amount that is subject to the payment terms discount, the discount amount, and the amount due after prompt payment discount.

CustomsTotals

CustomsTotals is optional. Multiple instances might exist.

A grouping element for customs total information.

CustomsStampInformation

CustomsStampInformation is optional. Multiple instances might exist.

A grouping element that organises the information for customs.

AdditionalText

AdditionalText is optional. Multiple instances might exist.

A text field that is used to communicate information not previously defined or for special instructions. To be used only for circumstances not covered by specific elements.

TermsAndDisclaimers

TermsAndDisclaimers is optional. Multiple instances might exist.

An element that contains legal information with an indication of what the Language is.

TaxStatement

TaxStatement is optional. A single instance might exist.

A group element for declaration of exception from normal charges of tax and the reason for tax exemption.

IsAverageValue [attribute]

Indicates if the value is an average value or not.

This item is restricted to the following list.

Yes

No

IsAverageValue	
type	yesNo
default	No

IsBindingHandSeparation [attribute]

Indicates if there is hand separation required or not for books with odd page counts.

This item is restricted to the following list.

Yes

No

IsBindingHandSeparation	
type	yesNo

attributes

IsBoxed [attribute]

This item is restricted to the following list.

Yes

Indicates that the operation should be performed and the specifications are included in the e-Document.

No

Indicates that the operation will not be performed.

StandardOperatingProcedure

IsBoxed	
type	isBoxed

attribute

papiNet V2R31

Indicates the operation should be performed according to the Standard Operating Procedure manual provided by the customer that contains all procedures required for conducting business.

IsEaselBound [attribute]

Specifies if the binding is at the top of the pages or not rather than on the side which changes the pagination of the pages.

This item is restricted to the following list.

Yes

No

IsFinalInvoice [attribute]

Communicates to the receiver that this is the last invoice so that the customer can "close out" the associated PO as completely invoiced.

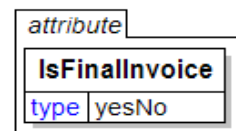

This item is restricted to the following list.

Yes

No

IsHalftones [attribute]

Indicates if the images are halftones or not.

This item is restricted to the following list.

Yes

No



ISOCountryCode [attribute]

The valid list of ISO Country Codes.

Information on the content of this attribute is available at:

http://www.iso.org/iso/country_codes/

[iso_3166_code_lists/english_country_names_and_code_elements.htm](http://www.iso.org/iso/country_codes/iso_3166_code_lists/english_country_names_and_code_elements.htm)

(Note: No spaces in this URL. URL split onto two lines.)



IsOptionalDestination [attribute]

Specifies if the Destination is optional or not. The default value is "No".

This item is restricted to the following list.

Yes

No (default)

attributes	
IsOptionalDestination	
type	yesNo
default	No

IsPalletized [attribute]

The buyer's directions for how the item is to be palletized.

This item is restricted to the following list.

Yes

Indicates that the operation should be performed and the specifications are included in the e-Document.

No

Indicates that the operation will not be performed.

StandardOperatingProcedure

Indicates the operation should be performed according to the Standard Operating Procedure manual provided by the customer that contains all procedures required for conducting business.

attribute	
IsPalletized	
type	isPalletized

IsPartialIndicator [attribute]

Specifies if the container (e.g. pallet, box) is partially full or not.

This item is restricted to the following list.

Yes

No

IsPartialIndicator	
type	yesNo
default	No

IsPartialPalletsAllowed [attribute]

Indicates if partial pallets are allowed or not.

This item is restricted to the following list.

Yes

No

attribute	
IsPartialPalletsAllowed	
type	yesNo

IssueOrEventID

Used to communicate the identifier for a job.

IssueOrEventID	
type	s30

IsThirdPartyAdvice [attribute]

An advice to a third party of a ShippingInstructions.

This item is restricted to the following list.

Yes

No

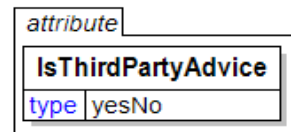

IsThirdPartyShipment [attribute]

Shipment request to a party other than the party that ordered the product from the supplier

This item is restricted to the following list.

Yes

No



IsTradeRegionAvailable [attribute]

Is the geographic area available or not.

This item is restricted to the following list.

Yes

No

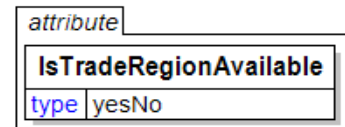

ItemCount

A count of the number of items (examples: a count of the number of boxes on a pallet or of reams in a box).

(sequence)

The sequence of items below is mandatory. A single instance is required.

Value

Value is mandatory. A single instance is required.

A numeric value expressed in the unit of measure (UOM).

RangeMin

RangeMin is optional. A single instance might exist.

The minimum value (lower boundary) allowed for the Measurement that is the parent of this element.

RangeMax

RangeMax is optional. A single instance might exist.

The maximum value (upper boundary) allowed for the Measurement that is the

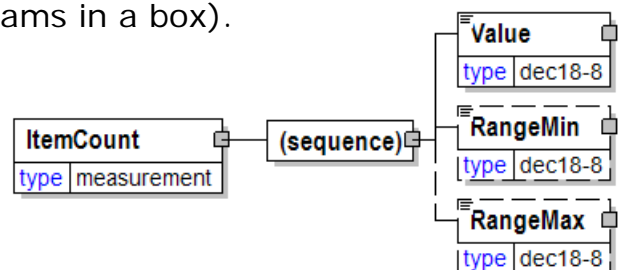

parent of this element. Some elements use the RangeMax element with an extended list of unit of measures. (Note: the red colour in the picture is an artifact of how the graphic was captured and should be disregarded.)

ItemDetails

A group element that identifies a specific item and measured attribute values for that item.

ItemType [attribute]

ItemType is mandatory. A single instance is required.

Indicates the form of the item being reported as being used. Many of the ItemType(s) indicated here have a corresponding named element equivalent, which is referenced here for definition purposes.

Refer to ItemType definition for any enumerations.

(sequence)

The sequence of items below is mandatory. A single instance is required.

Identifier

Identifier is mandatory. One instance is required, multiple instances might exist.

An Identifier is required for packages and items (pallets, reel packages, boxes, ream items, reel items, etc). The Identifier element contains the actual item identifier code. Identifier is repeatable so more than one identifier can be communicated. For example, the printed identifier on a label may be different from the barcode printed on the label.

(choice)

[choice] is optional because of choice construct.

PaperCharacteristics

PaperCharacteristics is optional because of choice construct.

The identifying characteristics of paper most important to the ordering of the item. These are the characteristics that, when associated with a given grade, allow the manufacturer to produce but not convert or package, the paper.

PulpCharacteristics

PulpCharacteristics is optional because of choice construct.

The physical and chemical characteristics of the pulp product regardless of the form that it is taking.

RecoveredPaperAttributes

RecoveredPaperAttributes is optional because of choice construct.

The attributes of Recovered Paper.

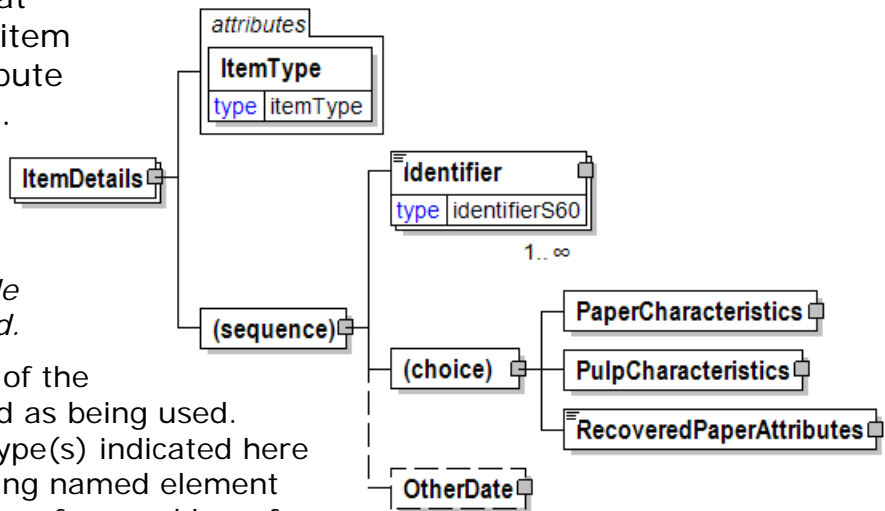

OtherDate

OtherDate is optional. A single instance might exist.

A date that may not be specifically detailed within a document (example: print date at the PurchaseOrderLineItem).

ItemInfo

A grouping element that contains information about an item. The attribute Item Type defines the type of physical item.

Item Info describes property values of an item as well as tracking information between items processed in the supply chain.

ItemType [attribute]

ItemType is optional. A single instance might exist.

Indicates the form of the item being reported as being used. Many of the ItemType(s) indicated here have a corresponding named element equivalent, which is referenced here for definition purposes.

Refer to ItemType definition for any enumerations.

(sequence)

The sequence of items below is mandatory. A single instance is required.

Identifier

Identifier is mandatory. Multiple instances might exist.

An Identifier is required for packages and items (pallets, reel packages, boxes, ream items, reel items, etc). The Identifier element contains the actual item identifier code. Identifier is repeatable so more than one identifier can be communicated. For example, the printed identifier on a label may be different from the barcode printed on the label.

TrackingReferenceID

TrackingReferenceID is optional. Multiple instances might exist.

A grouping element that defines tracking references between items processed in the supply chain.

ItemReference

ItemReference is optional. Multiple instances might exist.

An element detailing relevant references pertaining to the Item as indicated by ItemReferenceType and AssignedBy.

MapCoordinates

MapCoordinates is optional. Multiple instances might exist.

A group item defining and containing position co-ordinates of a location

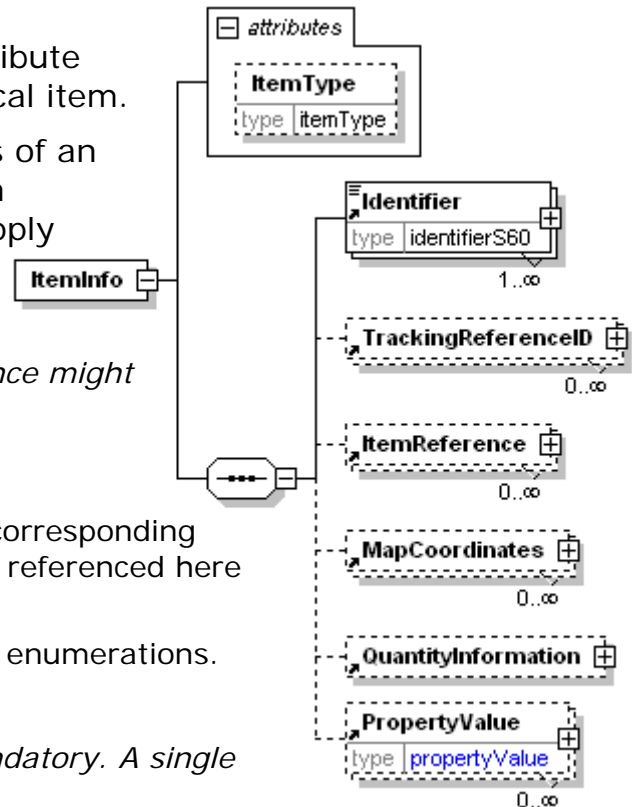

QuantityInformation

QuantityInformation is optional. A single instance might exist.

A group item containing information about quantity and informational quantity of similar items.

PropertyValue

PropertyValue is optional. Multiple instances might exist.

Specifies a value for a property of an item. The property is defined by the attribute PropertyType. The attribute MeasuringMethod and AssignedBy can be used to clarified details for a how a property is measured or calculated, e.g. Diameter for a saw log can be measured "Under Bark" or "Over Bark". The attribute MeasuringMethodType defines how the value is created, e.g. measured automatically, calculated etc. The attribute IsAverageValue Indicates if the value is an average value or not.

ItemInformation

The purpose of the ItemInformation structure is to clearly identify physical items. The attribute ItemType defines the type of physical item. Physical items can be handling units like packages as well as items contained in packages.

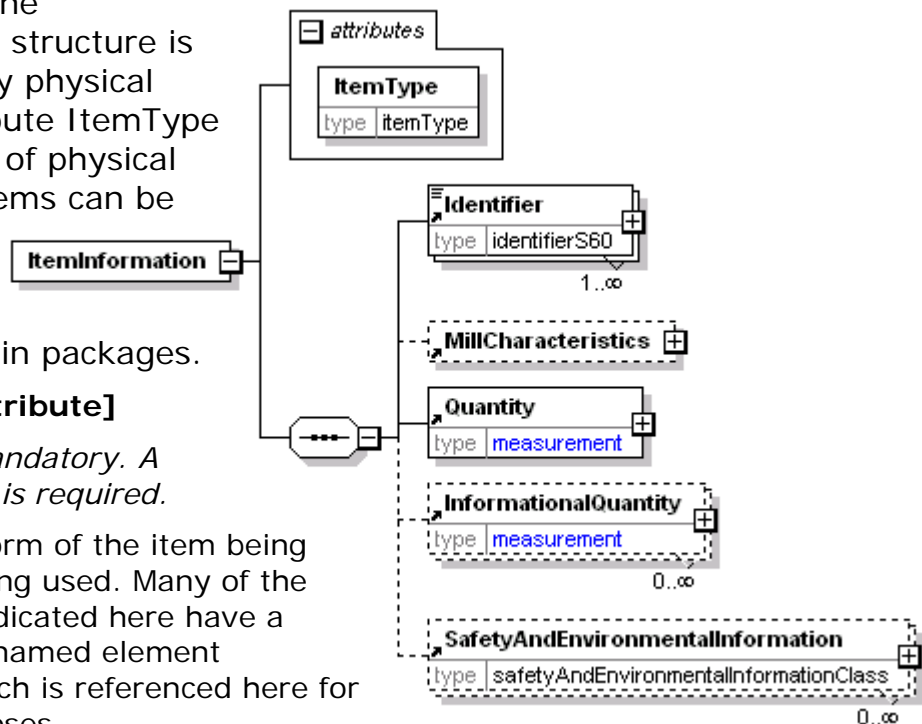

ItemType [attribute]

ItemType is mandatory. A single instance is required.

Indicates the form of the item being reported as being used. Many of the ItemType(s) indicated here have a corresponding named element equivalent, which is referenced here for definition purposes.

Refer to ItemType definition for any enumerations.

(sequence)

The sequence of items below is mandatory. A single instance is required.

Identifier

Identifier is mandatory. One instance is required, multiple instances might exist.

An Identifier is required for packages and items (pallets, reel packages, boxes, ream items, reel items, etc). The Identifier element contains the actual item identifier code. Identifier is repeatable so more than one identifier can be communicated. For example, the printed identifier on a label may be different from the barcode printed on the label.

MillCharacteristics

papiNet V2R31

MillCharacteristics is optional. A single instance might exist.

A group item defining the mill party and machine identifier where a product is or was produced.

Quantity

Quantity is mandatory. A single instance is required.

The Quantity element contains attributes that provide information about the type of quantity that is being communicated, the context in which the particular quantity is to be viewed, and (if the quantity represents an adjustment) an adjustment type.

The Quantity element contains three child elements that enable you to communicate a range of values for the quantity and a target or actual value. It is at this level (Value, RangeMin, and RangeMax) that the unit of measure is specified. This permits the range to be specified in a different unit of measure than the target.

InformationalQuantity

InformationalQuantity is optional. Multiple instances might exist.

A quantity given in a valid UOM used for information purposes only (not for calculation). For example, an ordered quantity was 100 reels as opposed to the invoice quantity of 20,000 pounds.

SafetyAndEnvironmentalInformation

SafetyAndEnvironmentalInformation is optional. Multiple instances might exist.

Name of certification type, if any, on the goods (For example, FSC, PEFC). SafetyAndEnvironmental needs a value or measurement to communicate the percentage of the product is certified (for example, 75% is certified by the indicated agency).

ItemisedUsageLineItem

A group item containing information that relates to an itemized amount of usage.

(sequence)

The sequence of items below is mandatory. A single instance is required.

Product

Product is optional. A single instance might exist.

Product is a group item defining the article and its characteristics. Product is used to specify product characteristics organized by ProductIdentifier, ProductDescription, and Classification. Book Manufacturing, Label Stock, Paper, Pulp, Recovered Paper, Wood Products, and Virgin Fibre market segments have defined their product characteristics and conversion features for implementation in papiNet.

PurchaseOrderInformation

PurchaseOrderInformation is optional. A single instance might exist.

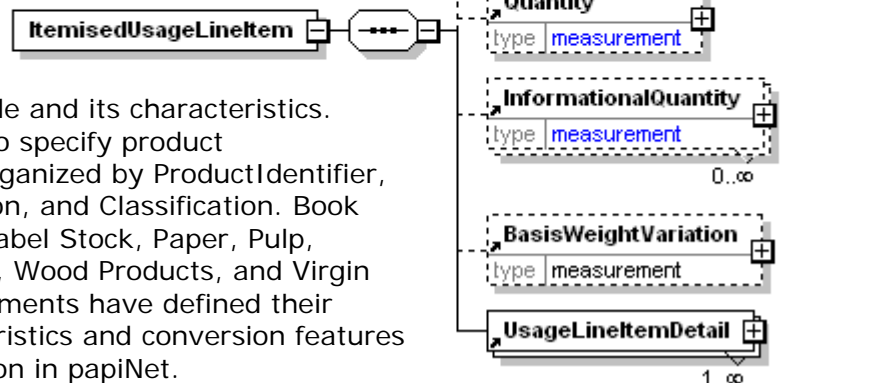

papiNet V2R31

A group item containing information unique to this PurchaseOrder, which is provided by the buyer. PurchaseOrderInformation can be optional in the supply chain. Invoices are created without having a PurchaseOrder in Vendor Managed Inventory. Freight invoices also will not have a PurchaseOrder number.

PurchaseOrderLineItemNumber

PurchaseOrderLineItemNumber is optional. A single instance might exist.

The sequential number that uniquely identifies the PurchaseOrder line item.

Quantity

Quantity is optional. A single instance might exist.

The Quantity element contains attributes that provide information about the type of quantity that is being communicated, the context in which the particular quantity is to be viewed, and (if the quantity represents an adjustment) an adjustment type.

The Quantity element contains three child elements that enable you to communicate a range of values for the quantity and a target or actual value. It is at this level (Value, RangeMin, and RangeMax) that the unit of measure is specified. This permits the range to be specified in a different unit of measure than the target.

InformationalQuantity

InformationalQuantity is optional. Multiple instances might exist.

A quantity given in a valid UOM used for information purposes only (not for calculation). For example, an ordered quantity was 100 reels as opposed to the invoice quantity of 20,000 pounds.

BasisWeightVariation

BasisWeightVariation is optional. A single instance might exist.

BasisWeightVariation is the measured difference between the mill target basis weight and the mill actual basis weight.

UsageLineItemDetail

UsageLineItemDetail is mandatory. One instance is required, multiple instances might exist.

For each ItemisedUsageLineItem there must be one or more UsageLineItemDetail. This element lists the specific product that has been consumed.

ItemMeasuringInfo

A grouping element that contains information about measured items.

UnCompletedMeasurement [attribute]

UnCompletedMeasurement is optional. A single instance might exist.

Indicates if the measuring of an item is uncompleted, i.e. if some measurement values are missing.

Refer to UnCompletedMeasurement definition for any enumerations.

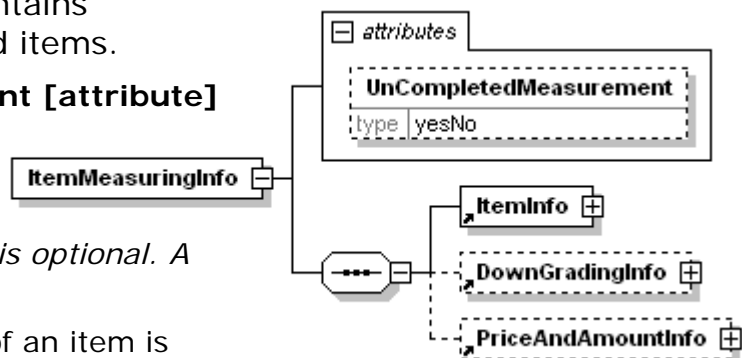

(sequence)

The sequence of items below is mandatory. A single instance is required.

ItemInfo

ItemInfo is mandatory. A single instance is required.

A grouping element that contains information about an item. The attribute `ItemType` defines the type of physical item. Item Info describes property values of an item as well as tracking information between items processed in the supply chain.

DownGradingInfo

DownGradingInfo is optional. A single instance might exist.

A grouping element that contains information about downgrading of products.

PriceAndAmountInfo

PriceAndAmountInfo is optional. A single instance might exist.

A grouping element that contains information about price and amounts.

ItemReference

An element detailing relevant references pertaining to the Item as indicated by `ItemReferenceType` and `AssignedBy`.

ItemReferenceType [attribute]

ItemReferenceType is mandatory. A single instance is required.

Provides a contextual explanation of the specific reference identifier. Many items are currently prefixed by "Buyer", "Forwarder", "Manufacturer", "Mill", "Seller", "Supplier", "Warehouse", or "Vendor". Check for an existing non-prefixed version and use the non-prefixed version instead. In the (yet to be announced release date) version 3.0 the prefixed versions will be removed. Instead the attribute `@AssignedBy` will communicate the information previously communicated in the prefix.

Refer to `ItemReferenceType` definition for any enumerations.

AssignedBy [attribute]

AssignedBy is optional. A single instance might exist.

Identifies the type of party that has assigned the associated item, e.g. a reference of type `OrderNumber`.

Refer to `AssignedBy` for any enumerations.

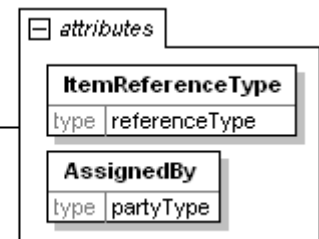

ItemReferenceType [attribute]

Provides a contextual explanation of the specific reference identifier. Many items are currently prefixed by "Buyer", "Forwarder", "Manufacturer", "Mill", "Seller", "Supplier", "Warehouse" or "Vendor". Check for an existing non-prefixed version and use the non-prefixed version instead. In the (yet to be

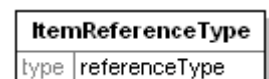

announced release date) version 3.0 the prefixed versions will be removed. Instead the attribute AssignedBy will communicate the information previously communicated in the prefix.

Refer to the [referenceType](#) entry for the list of enumerations and their definitions.

ItemsPerPallet

The number of items on the pallet (either reels or sheet or sheet-package).

ItemsPerPallet	
type	nni6

ItemsPerTier

Number of items on each full tier, e.g. number of boxes, gaylords, loose books etc. on a tier on a pallet.

ItemsPerTier	
type	nni3

ItemType [attribute]

Indicates the form of the item being reported as being used. Many of the ItemType(s) indicated here have a corresponding named element equivalent, which is referenced here for definition purposes.

attribute	
ItemType	
type	itemType

This item is restricted to the following list.

BaleItem

Box

BoxItem

CalibrationCheckItem

An item used for calibration checks of measuring equipments.

Log

A cut portion of a stem.

LogBundle

A bundle of logs (a virtual type of item).

LogPile

A pile of logs (a virtual type of package).

LooseVolumeItem

A unit containing loose volume products (during transports) (a type of virtual package).

Pallet

PulpUnit

ReamItem

ReelItem

ReelPackage

Stem

A tree without branches.

Tambour

JewelBox

Jewel box.

JewelBoxType [attribute]

JewelBoxType is optional. A single instance might exist.

The type of jewel box (container for CD or DVD).

Refer to JewelBoxType definition for any enumerations.

TrayColourType [attribute]

TrayColourType is optional. A single instance might exist.

The type of tray colour.

Refer to TrayColourType definition for any enumerations.

InlayCardQuantity [attribute]

InlayCardQuantity is optional. A single instance might exist.

Inlay card quantity

Refer to InlayCardQuantity definition for any enumerations.

WrapType [attribute]

WrapType is optional. A single instance might exist.

Communicates the type of material used to wrap the product.

Refer to WrapType definition for any enumerations.

TearStripType [attribute]

TearStripType is optional. A single instance might exist.

Tear Strip Type

Refer to TearStripType definition for any enumerations.

(sequence)

The sequence of items below is mandatory. A single instance is required.

ColourSpecs

ColourSpecs is optional. A single instance might exist.

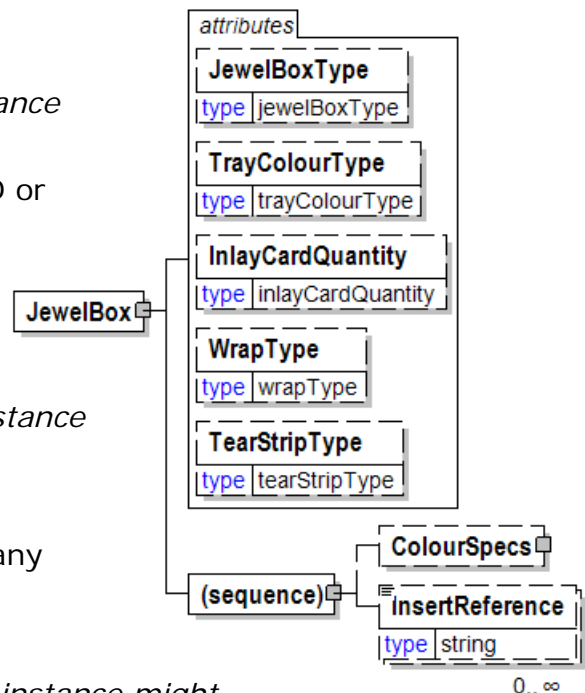

Colour specs

InsertReference

InsertReference is optional. Multiple instances might exist.

Insert reference

JewelBoxType [attribute]

The type of jewel box (container for CD or DVD).

This item is restricted to the following list.

Double

JewelBox holds 2 CDs.

DoubleSlimLine

DoubleSlimLineLiveHinge

MidFrameDouble2SingleTray

MidFrameDouble2LiveHinge

Quad3-4CDs

Quad5CDs

Quad6CDs

Single

JewelBox holds a single CD.

StandardSingleTray

Triple

JewelBox holds a single CD.

Other

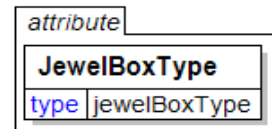

JobCode

The particular identification code of printing an entire request known as a job.

Agency [attribute]

Agency is optional. A single instance might exist.

Describes the agency maintaining the list of codes. To be included in this list the agency must be a recognized standards body or industry organisation.

For the element that owns this attribute.

For another attribute in the list of attributes associated with the parent element.

Refer to Agency definition for any enumerations.

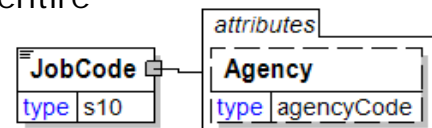

JobDateTimeRange

The specification of the date range for the job.

(sequence)

The sequence of items below is mandatory. A single instance is required.

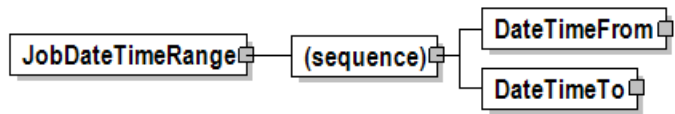

DateTimeFrom

DateTimeFrom is mandatory. A single instance is required.

The start or beginning Date and Time of a date range.

DateTimeTo

DateTimeTo is mandatory. A single instance is required.

The ending Date and Time of a date/time range.

JobDescription

A textual description of the job.

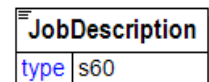

JobID

An element used to communicate the unique identifier of the Job

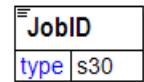

JobInformation

JobInformation is optional. This construct captures information specific to the entire job set up.

(sequence)

The sequence of items below is mandatory. A single instance is required.

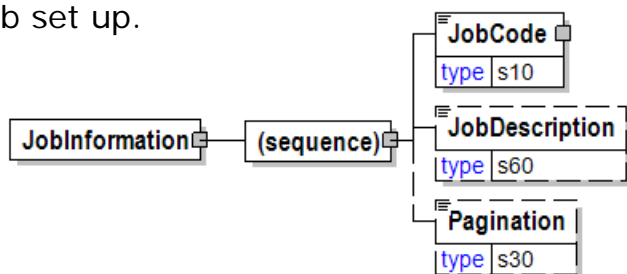

JobCode

JobCode is mandatory. A single instance is required.

The particular identification code of printing an entire request known as a job.

JobDescription

JobDescription is optional. A single instance might exist.

A textual description of the job.

Pagination

Pagination is optional. A single instance might exist.

Number of pages that make up a book.

Joining

Defines the method used to join pieces of wood.

JoiningType [attribute]

JoiningType is optional. A single instance might exist.

Defines the type of mechanical joint employed in manufacture of the product.

Refer to JoiningType definition for any enumerations.

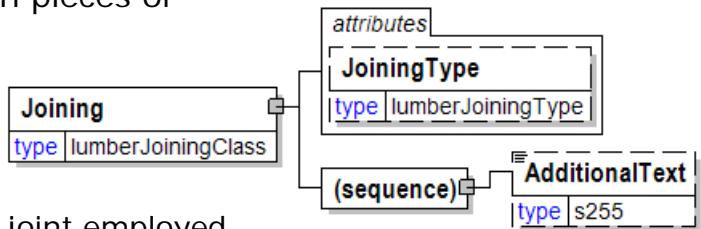

(sequence)

The sequence of items below is mandatory. A single instance is required.

AdditionalText

AdditionalText is optional. A single instance might exist.

A text field that is used to communicate information not previously defined or for special instructions. To be used only for circumstances not covered by specific elements.

JoiningType [attribute]

Defines the type of mechanical joint employed in manufacture of the product.

This item is restricted to the following list.

FingerJointed

FingerJointed-VertUseOnly

Glued-Up

Other

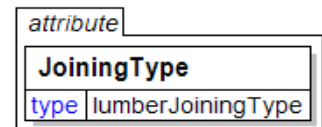

L

The "L" component of the method of communicating colour termed L^*a^*b .

(sequence)

The sequence of items below is mandatory. A single instance is required.

DetailValue

DetailValue is mandatory. A single instance is required.

A numeric value expressed in the unit of measure (UOM).

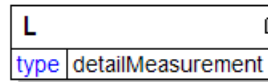

DetailRangeMin

DetailRangeMin is optional. A single instance might exist.

The minimum value (lower boundary) allowed for the DetailValue that is the parent of this element.

DetailRangeMax

DetailRangeMax is optional. A single instance might exist.

The maximum value (upper boundary) allowed for the DetailValue that is the parent of this element.

StandardDeviation

StandardDeviation is optional. A single instance might exist.

A statistic used as a measure of dispersion in a distribution.

SampleSize

SampleSize is optional. A single instance might exist.

The number of samples used to determine the product characteristic in question.

TwoSigmaLower

TwoSigmaLower is optional. A single instance might exist.

Two sigma (a measure of dispersion associated with standard deviation) on the lower side of the standard deviation.

TwoSigmaUpper

TwoSigmaUpper is optional. A single instance might exist.

Two sigma (a measure of dispersion associated with standard deviation) on the upper side of the standard deviation.

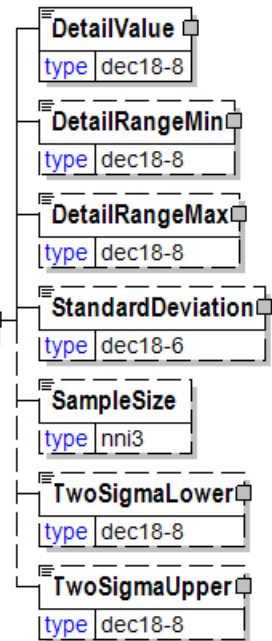

Lab

A definition of colour using the L*a*b protocol.

L*a*b colour consists of a luminance or lightness component (L) and two chromatic components: a component (from green to red) and the b component (from blue to yellow). All the components of the definition are required. The structure of Luminance, "a", and "b" follows DetailMeasurement.

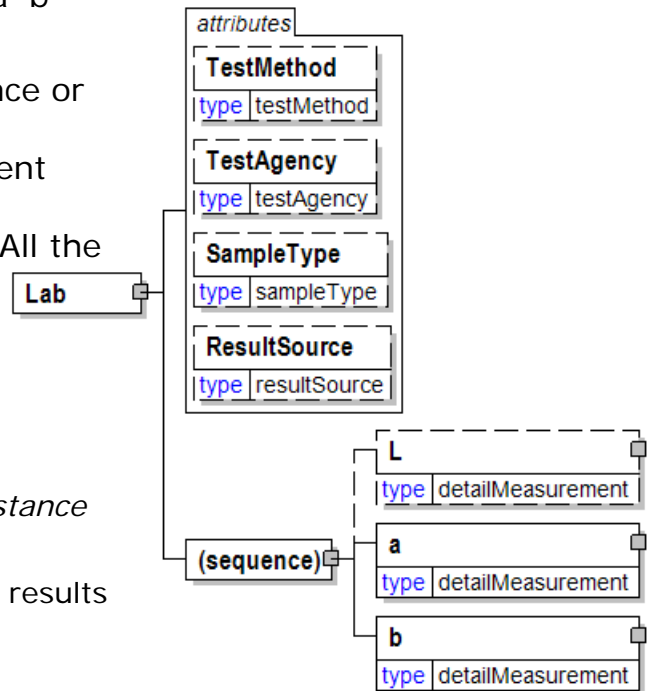

TestMethod [attribute]

TestMethod is optional. A single instance might exist.

The method used to determine the results of the test under consideration.

TestAgency [attribute]

TestAgency is optional. A single instance might exist.

The agency that has set the parameters for the testing

Refer to TestAgency definition for any enumerations.

SampleType [attribute]

SampleType is optional. A single instance might exist.

Communicates how sampling was done to measure the product characteristics.

Refer to SampleType definition for any enumerations.

ResultSource [attribute]

ResultSource is optional. A single instance might exist.

Used to define the data source of the specified test

Refer to ResultSource definition for any enumerations.

(sequence)

The sequence of items below is mandatory. A single instance is required.

L

L is optional. A single instance might exist.

The "L" component of the method of communicating colour termed L*a*b.

a

a is mandatory. A single instance is required.

The "a" portion of the method of colour represented by L*a*b.

b

b is mandatory. A single instance is required.

The "b" component of the method of communicating colour termed L*a*b.

LabelBrandName

The trade name or brand name used or, to be used for the label stock.

LabelBrandName
type s30

LabelCharacteristics

A group item that organises the labeling information.

(sequence)

The sequence of items below is mandatory. A single instance is required.

CustomerMarks

CustomerMarks is optional. Multiple instances might exist.

The text that the buyer wants the seller to print on the package label or elsewhere.

LabelStyle

LabelStyle is optional. A single instance might exist.

A text field describing the type of special label layout requested by the buyer.

LabelBrandName

LabelBrandName is optional. A single instance might exist.

The trade name or brand name used or, to be used for the label stock.

LabelPosition

LabelPosition is optional. A single instance might exist.

Information about where the label is to be placed on the package.

NumberOfLabels

NumberOfLabels is optional. A single instance might exist.

The number of labels to be placed on the package.

Length

Length is optional. A single instance might exist.

The length of the object.

Width

Width is optional. A single instance might exist.

The width of the object.

ColourCode

ColourCode is optional. A single instance might exist.

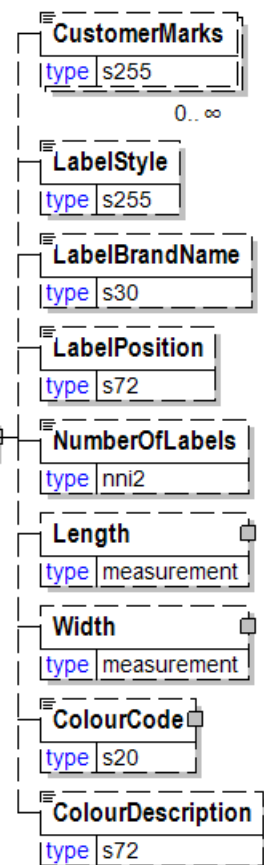

A code indicating the colour.

ColourDescription

ColourDescription is optional. A single instance might exist.

A free form description of the colour.

LabelOrientation [attribute]

Specifies label orientation for loaded goods seen in the transport direction of the goods carrier. It makes the label visible during unloading from a predetermined side.

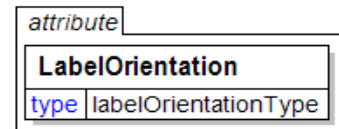

This item is restricted to the following list.

BackEndSide

Goods labels are oriented towards the back-end side

FrontEndSide

Goods labels are oriented towards the front-end side

LeftAndRightSide

Goods labels are oriented towards the left side for goods to be unloaded from the left side and towards the right side for goods to be unloaded from the right side.

LeftSide

Goods labels are oriented towards the left side

RightSide

Goods labels are oriented towards the right side

LabelPosition

Information about where the label is to be placed on the package.

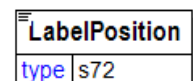

LabelStock

LabelStock contains the attributes and characteristics that define the label stock product.

(sequence)

The sequence of items below is mandatory. A single instance is required.

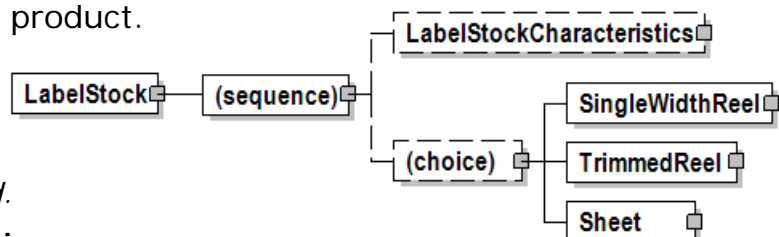

LabelStockCharacteristics

LabelStockCharacteristics is optional. A single instance might exist.

Label stock characteristics.

(choice)

[choice] is optional because of choice construct.

SingleWidthReel

SingleWidthReel is optional because of choice construct.

Single width reel information.

TrimmedReel

TrimmedReel is optional because of choice construct.

Trimmed reel

Sheet

Sheet is optional because of choice construct.

A group item that contains the conversion and packaging characteristics for sheets.

LabelStockCharacteristics

Label stock characteristics.

(sequence)

The sequence of items below is mandatory. A single instance is required.

LabelStockLayer

LabelStockLayer is optional. Multiple instances might exist.

Label stock layer

ExtraFeature

ExtraFeature is optional. Multiple instances might exist.

A special or extra feature that the label has or needs.

AdditionalText

AdditionalText is optional. Multiple instances might exist.

A text field that is used to communicate information not previously defined or for special instructions. To be used only for circumstances not covered by specific elements.

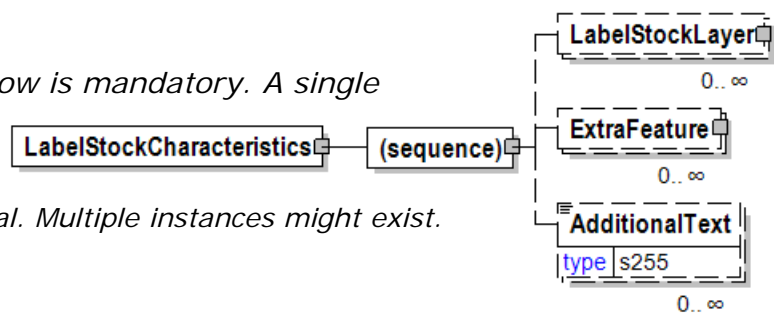

LabelStockLayer

Label stock layer

(sequence)

The sequence of items below is mandatory. A single instance is required.

LabelStockLayerType

LabelStockLayerType is mandatory. A single instance is required.

The label stock layer type

Refer to LabelStockLayerType definition for any enumerations.

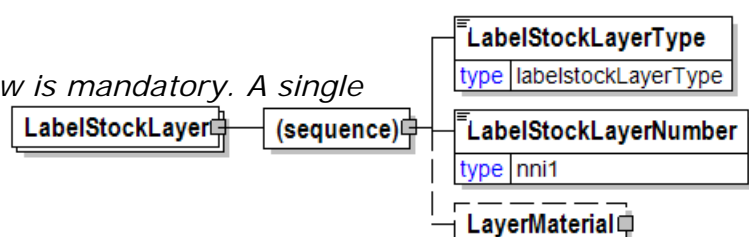

papiNet V2R31

LabelStockLayerNumber

LabelStockLayerNumber is mandatory. A single instance is required.

The label stock layer number

LayerMaterial

LayerMaterial is optional. A single instance might exist.

Used to identify the materials used in the layers of the label.

LabelStockLayerNumber

The label stock layer number

LabelStockLayerNumber	
type	nni1

LabelStockLayerType

The label stock layer type

This item is restricted to the following list.

Adhesive

Backing

Face

Silicon

LabelStockLayerType	
type	labelstockLayerType

LabelStyle

A text field describing the type of special label layout requested by the buyer.

LabelStyle	
type	s255

Language [attribute]

XML has embraced 2 and 3 digit language codes through the application of an addendum to the standard.

Information on the content of this attribute is available at: <http://www.loc.gov/standards/iso639-2/> this is the official site of the ISO 639-2 Registration Authority.

<http://www.w3.org/International/O-HTML-tags.html> provides an explanation of the errata updating XML.

<http://www.ietf.org/rfc/rfc3066.txt> is the key document that is referenced in the above errata.

attribute	
Language	
type	languageType
default	eng

LargeEndDiameter

Used to report the log butt end diameter as a measurement.

(sequence)

The sequence of items below is mandatory. A single instance is required.

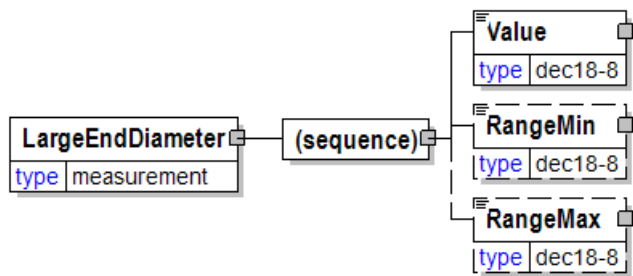

Value

Value is mandatory. A single instance is required.

A numeric value expressed in the unit of measure (UOM).

RangeMin

RangeMin is optional. A single instance might exist.

The minimum value (lower boundary) allowed for the Measurement that is the parent of this element.

RangeMax

RangeMax is optional. A single instance might exist.

The maximum value (upper boundary) allowed for the Measurement that is the parent of this element. Some elements use the RangeMax element with an extended list of unit of measures. (Note: the red colour in the picture is an artifact of how the graphic was captured and should be disregarded.)

LastDateOfChange

The last date for which changes to the line item may occur before it is "locked" in the production process.

LastDateOfChange encapsulates Date.

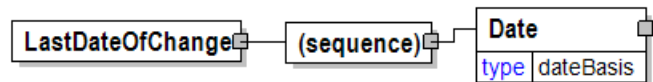

(sequence)

The sequence of items below is mandatory. A single instance is required.

Date

Date is mandatory. A single instance is required.

A group element that contains the specification of Year, Month, and Day.

Latitude

A measurement of the position of the party or contact in degrees north or south of the equator

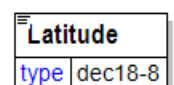

LayerMaterial

Used to identify the materials used in the layers of the label.

(sequence)

The sequence of items below is mandatory. A single instance is required.

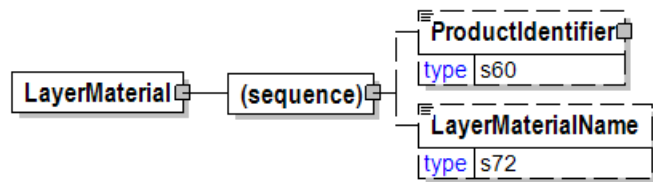

ProductIdentifier

ProductIdentifier is optional. A single instance might exist.

Used to communicate the code of the article, in a variety of formats designated by the type.

LayerMaterialName

LayerMaterialName is optional. A single instance might exist.

The layer material name

LayerMaterialName

The layer material name

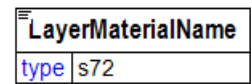

LayersPerUnit

The number of layers on the shipping, handling, or delivery unit. (This element uses pattern matching to ensure the appropriate format for latitude.)

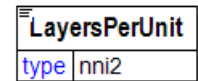

LegStageType [attribute]

LegStageType is used to identify whether this is the primary transportation process or a transportation process that comes before or after the main transportation process.

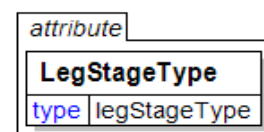

This item is restricted to the following list.

PreCarriage

The initial transport of goods from the seller's premises to the main port of shipment. Usually by truck, rail or on inland waterways.

MainCarriage

The primary transport of goods, generally for the longest part of the journey and generally from one country to another. Usually by sea vessel or by airplane, but can be truck or rail as well.

OnCarriage

Transport from the port of arrival in the country of destination to the buyer's premises. Usually by truck, rail or on inland waterways.

Length

The approach to length used in the timber/lumber related constructs.

ActualNominal [attribute]

ActualNominal is optional. A single instance might exist.

Indicates the

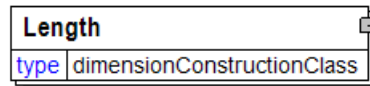

measurement approach used to communicate the dimensions of the individual pieces.

Refer to ActualNominal definition for any enumerations.

WithGrain [attribute]

WithGrain is optional. A single instance might exist.

Either "Yes" or "No".

Refer to WithGrain definition for any enumerations.

(choice)

[choice] is optional because of choice construct.

Value

Value is optional because of choice construct.

A numeric value expressed in the unit of measure (UOM).

(sequence)

The sequence of items below is mandatory. A single instance is required.

RangeMin

RangeMin is optional. A single instance might exist.

The minimum value (lower boundary) allowed for the Measurement that is the parent of this element.

RangeMax

RangeMax is optional. A single instance might exist.

The maximum value (upper boundary) allowed for the Measurement that is the parent of this element. Some elements use the RangeMax element with an extended list of unit of measures. (Note: the red colour in the picture is an artifact of how the graphic was captured and should be disregarded.)

AdditionalText

AdditionalText is optional because of choice construct.

A text field that is used to communicate information not previously defined or for special instructions. To be used only for circumstances not covered by specific elements.

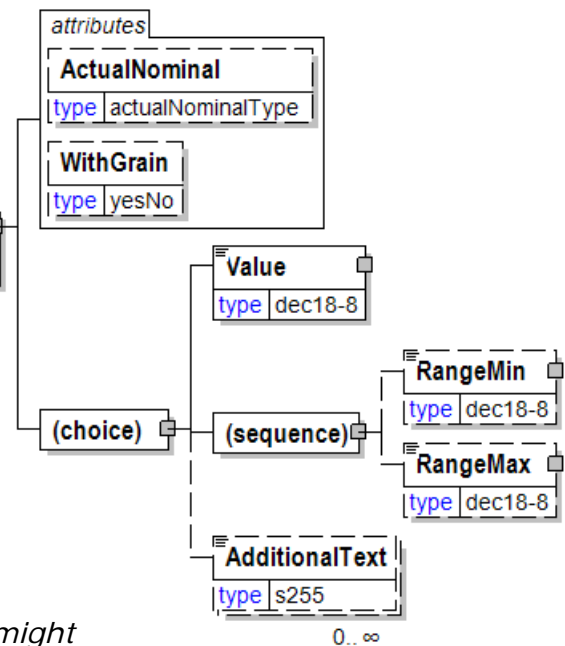

Length

The following approach is used in the timber/lumber related constructs.

ActualNominal [attribute]

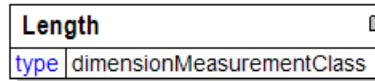

ActualNominal is optional. A single instance might exist.

Indicates the measurement approach used to communicate the dimensions of the individual pieces.

Refer to ActualNominal definition for any enumerations.

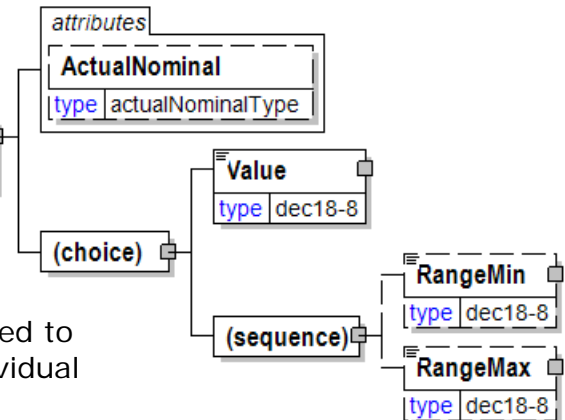

(choice)

[choice] is optional because of choice construct.

Value

Value is optional because of choice construct.

A numeric value expressed in the unit of measure (UOM).

(sequence)

The sequence of items below is mandatory. A single instance is required.

RangeMin

RangeMin is optional. A single instance might exist.

The minimum value (lower boundary) allowed for the Measurement that is the parent of this element.

RangeMax

RangeMax is optional. A single instance might exist.

The maximum value (upper boundary) allowed for the Measurement that is the parent of this element. Some elements use the RangeMax element with an extended list of unit of measures. (Note: the red colour in the picture is an artifact of how the graphic was captured and should be disregarded.)

Length

The length of the object.

(sequence)

The sequence of items below is mandatory. A single instance is required.

Value

Value is mandatory. A single instance is required.

A numeric value expressed in the unit of measure (UOM).

RangeMin

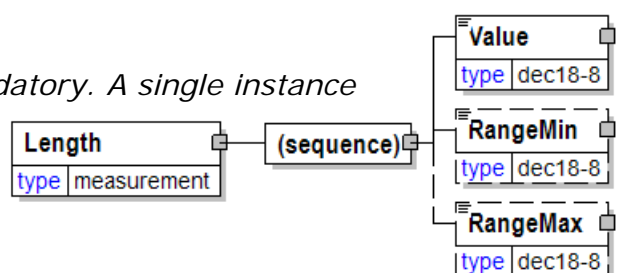

RangeMin is optional. A single instance might exist.

The minimum value (lower boundary) allowed for the Measurement that is the parent of this element.

RangeMax

RangeMax is optional. A single instance might exist.

The maximum value (upper boundary) allowed for the Measurement that is the parent of this element. Some elements use the RangeMax element with an extended list of unit of measures. (Note: the red colour in the picture is an artifact of how the graphic was captured and should be disregarded.)

LengthCategory

Value of the length category.

UOM [attribute]

UOM is optional. A single instance might exist.

Defines the unit of measure for the value.

Refer to UOM definition for any enumerations.

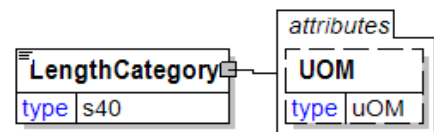

LengthCutDescription

Length Cut Description

LengthCutType [attribute]

LengthCutType is optional. A single instance might exist.

Indicates whether the timber length is in dimensional modules, free length or exact cut length.

Refer to LengthCutType definition for any enumerations.

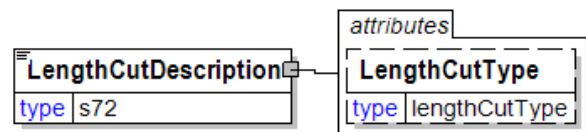

LengthCutType [attribute]

Indicates whether the timber length is in dimensional modules, free length or exact cut length.

This item is restricted to the following list.

ExactLength

The product is cut within agreed tolerance.

FreeCut

The product is free cut.

SpecialLength

The product is cut in a specific length as usually cut.

Untrimmed

e product is untrimmed.

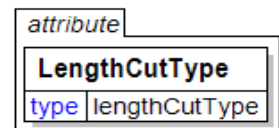

1DecimeterCut

The product is cut in one decimeter interval.

3DecimeterCut

The product is cut in three decimeter interval.

LengthFromCore

In relationship to a paper event (usually a mill join) where is the event in terms of the length of the paper.

(sequence)

The sequence of items below is mandatory. A single instance is required.

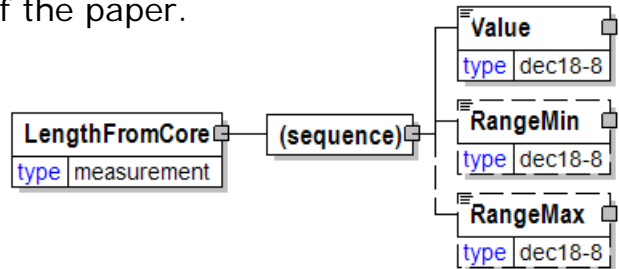

Value

Value is mandatory. A single instance is required.

A numeric value expressed in the unit of measure (UOM).

RangeMin

RangeMin is optional. A single instance might exist.

The minimum value (lower boundary) allowed for the Measurement that is the parent of this element.

RangeMax

RangeMax is optional. A single instance might exist.

The maximum value (upper boundary) allowed for the Measurement that is the parent of this element. Some elements use the RangeMax element with an extended list of unit of measures. (Note: the red colour in the picture is an artifact of how the graphic was captured and should be disregarded.)

LengthSpecification

Length specification of the wood product.

(sequence)

The sequence of items below is mandatory. A single instance is required.

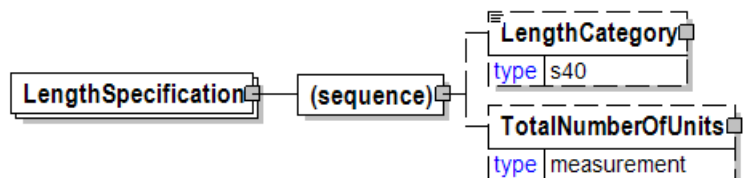

LengthCategory

LengthCategory is optional. A single instance might exist.

Value of the length category.

TotalNumberOfUnits

TotalNumberOfUnits is optional. A single instance might exist.

The total number of units.

LicenceNumber

Licence number.

Note: the spelling of this element conforms to papiNet's use of UK English.

LicenceNumber	
type	s30

LightScattering

A group item used to communicate light scattering coefficients according to a particular TestMethod.

TestMethod [attribute]

TestMethod is optional. A single instance might exist.

The method used to determine the results of the test under consideration.

TestAgency [attribute]

TestAgency is optional. A single instance might exist.

The agency that has set the parameters for the testing

Refer to TestAgency definition for any enumerations.

SampleType [attribute]

SampleType is optional. A single instance might exist.

Communicates how sampling was done to measure the product characteristics.

Refer to SampleType definition for any enumerations.

ResultSource [attribute]

ResultSource is optional. A single instance might exist.

Used to define the data source of the specified test

Refer to ResultSource definition for any enumerations.

(sequence)

The sequence of items below is mandatory. A single instance is required.

DetailValue

DetailValue is mandatory. A single instance is required.

A numeric value expressed in the unit of measure (UOM).

DetailRangeMin

DetailRangeMin is optional. A single instance might exist.

The minimum value (lower boundary) allowed for the DetailValue that is the parent

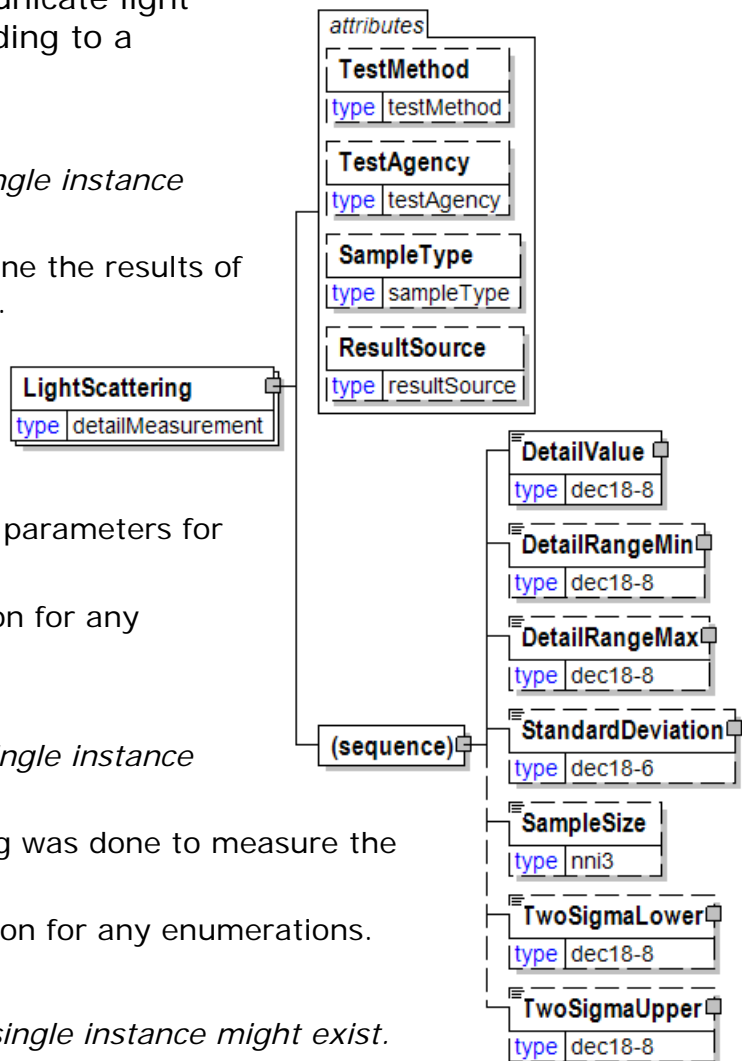

of this element.

DetailRangeMax

DetailRangeMax is optional. A single instance might exist.

The maximum value (upper boundary) allowed for the DetailValue that is the parent of this element.

StandardDeviation

StandardDeviation is optional. A single instance might exist.

A statistic used as a measure of dispersion in a distribution.

SampleSize

SampleSize is optional. A single instance might exist.

The number of samples used to determine the product characteristic in question.

TwoSigmaLower

TwoSigmaLower is optional. A single instance might exist.

Two sigma (a measure of dispersion associated with standard deviation) on the lower side of the standard deviation.

TwoSigmaUpper

TwoSigmaUpper is optional. A single instance might exist.

Two sigma (a measure of dispersion associated with standard deviation) on the upper side of the standard deviation.

LineBaseAmount

For the particular e-Document being communicated the LineBaseAmount represents the quantity times the base unit price.

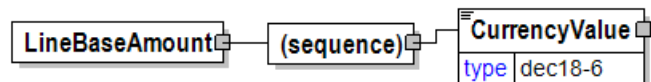

(sequence)

The sequence of items below is mandatory. A single instance is required.

CurrencyValue

CurrencyValue is mandatory. A single instance is required.

The amount in the referenced currency as defined by the CurrencyType attribute.

LineItemSubTotal

The total amount of all e-Document LineBaseAmount(s) line items without any monetary adjustments that may occur after the e-Document line items.

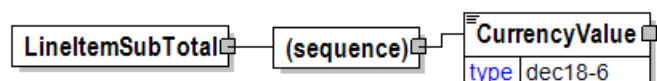

(sequence)

The sequence of items below is mandatory. A single instance is required.

CurrencyValue

CurrencyValue is mandatory. A single instance is required.

The amount in the referenced currency as defined by the CurrencyType attribute.

LoadAvailable

The LoadAvailable element is the root element for the LoadAvailable e-Document.

The Supplier party or authorized agent sends a LoadAvailable e-Document to the BuyerParty(consuming mill) indicating that load(s) for specific product is(are) ready on a specific date for acceptance and pickup.

The LoadAvailable e-Document from the supplier may include a Shipper Load Number. This number may be used as the consuming mill's release number The Shipper Load Number is used for authorization for pick-up of load at supplier point.

LoadAvailable

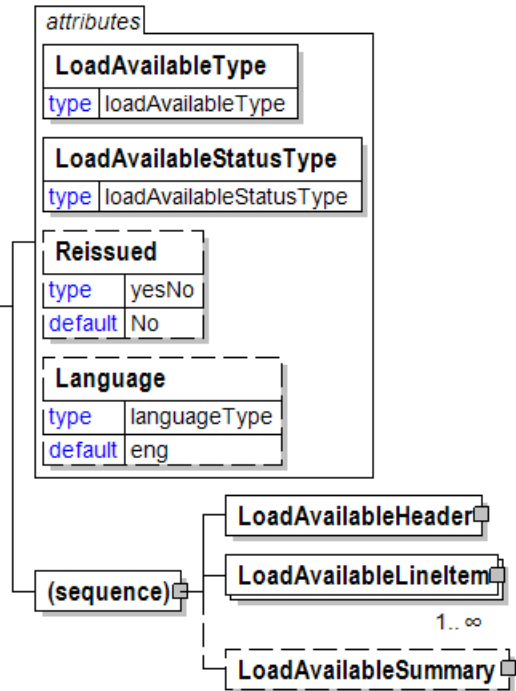

LoadAvailableType [attribute]

LoadAvailableType is mandatory. A single instance is required.

LoadAvailableType defines the type LoadAvailable e-Document.

Refer to LoadAvailableType definition for any enumerations.

LoadAvailableStatusType [attribute]

LoadAvailableStatusType is mandatory. A single instance is required.

LoadAvailableStatusType defines the status of the entire LoadAvailable e-Document.

Refer to LoadAvailableStatusType definition for any enumerations.

Reissued [attribute]

Reissued is optional. A single instance might exist.

Either "Yes" or "No".

Refer to Reissued definition for any enumerations.

Language [attribute]

Language is optional. A single instance might exist.

XML has embraced 2 and 3 digit language codes through the application of an addendum to the standard.

Refer to Language definition for any enumerations.

(sequence)

papiNet V2R31

The sequence of items below is mandatory. A single instance is required.

LoadAvailableHeader

LoadAvailableHeader is mandatory. A single instance is required.

The LoadAvailableHeader, a group item containing generic information common to the LoadAvailable e-Document.

LoadAvailableLineItem

LoadAvailableLineItem is mandatory. One instance is required, multiple instances might exist.

LoadAvailableLineItem is a group item containing information that relates to a line in the LoadAvailable e-Document.

LoadAvailableSummary

LoadAvailableSummary is optional. A single instance might exist.

LoadAvailable Summary

LoadAvailableConfirmationIssuedDate

The date of response to the LoadAvailable e-Document from originating party.

(sequence)

The sequence of items below is mandatory. A single instance is required.

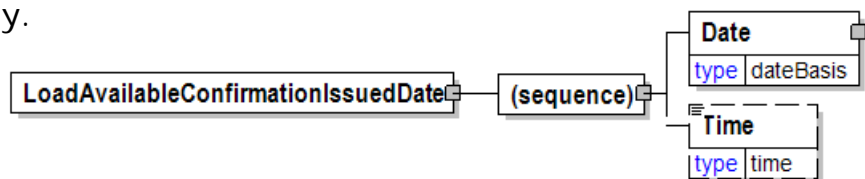

Date

Date is mandatory. A single instance is required.

A group element that contains the specification of Year, Month, and Day.

Time

Time is optional. A single instance might exist.

Times are treated in a standard XML fashion with a special case used to indicate a generalized "local" time. The standard XML approach to time is hh:mm:ss, hh:mm:ssZ, or hh:mm:ss±hh:mm.

hh:mm:ss±hh:mm is used to represent a time with a time zone. The time zone is communicated as the number of hours offset from the Universal Time Coordinate (UTC), a.k.a. Greenwich Mean Time.

hh:mm:ssZ indicates the time at Zulu (another name for UTC). Based on the convention described in the next bullet it will be important for users within UTC to use "Z" when communicating a time in their time zone to other users.

hh:mm:ss or hh:mm indicates in the XML standard the time at UTC however, within papiNet it is used to represent the applicable local time. Caution should be used when processing times of this nature as the papiNet approach may be in discord with other users of XML.

LoadAvailableHeader

The LoadAvailableHeader, a group item containing generic information common to the LoadAvailable e-Document.

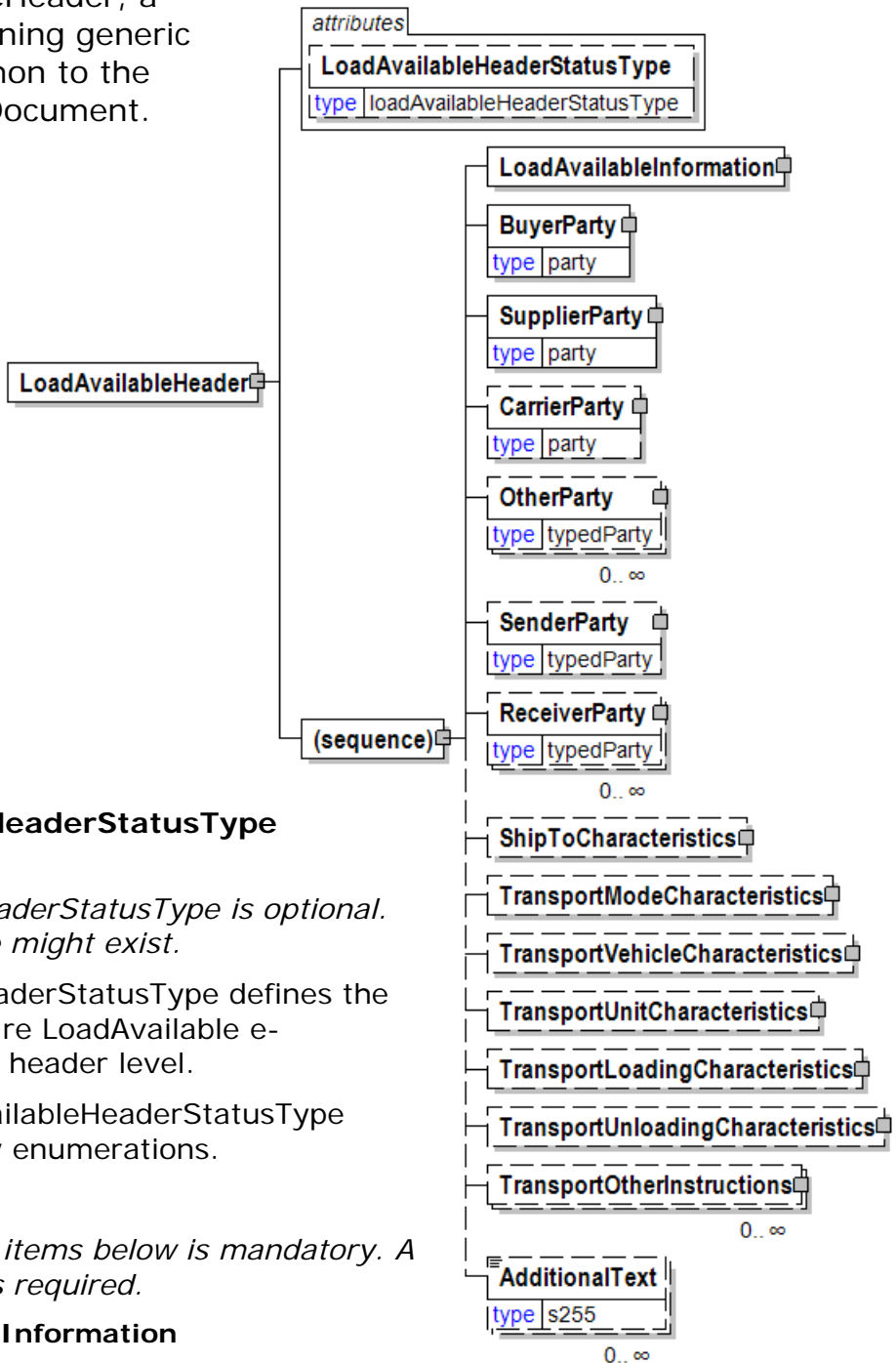

LoadAvailableHeaderStatusType [attribute]

LoadAvailableHeaderStatusType is optional. A single instance might exist.

LoadAvailableHeaderStatusType defines the status of the entire LoadAvailable e-Document at the header level.

Refer to LoadAvailableHeaderStatusType definition for any enumerations.

(sequence)

The sequence of items below is mandatory. A single instance is required.

LoadAvailableInformation

LoadAvailableInformation is mandatory. A single instance is required.

LoadAvailableInformation is a group item containing information about the whole LoadAvailable e-Document.

BuyerParty

BuyerParty is mandatory. A single instance is required.

The legal entity to which the product is sold. Also commonly referred to as the sold-to party or customer. If no OtherParty is defined as the Payer, the Buyer is the Payer.

SupplierParty

SupplierParty is mandatory. A single instance is required.

The organisation or business entity responsible for providing the product. SupplierParty is also the seller of the product, if Seller is not specified as OtherParty = Seller.

CarrierParty

CarrierParty is optional. A single instance might exist.

The party performing the transport of the product from the pickup location to the ship-to location; could be a hauler.

OtherParty

OtherParty is optional. Multiple instances might exist.

An organisation or business entity other than those specifically detailed within a e-Document.

SenderParty

SenderParty is optional. A single instance might exist.

The business entity issuing the e-Document, the source of the document.

The entity responsible for the content. If the sender party has out sourced the message service to a third party the SenderParty is the issuer of the e-Document and not the party performing the transmission service of the electronic message.

ReceiverParty

ReceiverParty is optional. Multiple instances might exist.

The business entity for whom the e-Document is intended, the destination of the document.

The entity interested in the content. If the receiver party has outsourced the message service to a third party the ReceiverParty is the intended party for the e-Document and not the party performing the receiving service of the electronic message.

ShipToCharacteristics

ShipToCharacteristics is optional. A single instance might exist.

A group item that provides information important for the Ship-To Party.

A group item that provides information important for the Ship-To Party. ShipToCharacteristics may be referenced at both the header and line item level. The reference at the header is required and acts as a default for the value at the line level, unless overridden at the line level.

TransportModeCharacteristics

TransportModeCharacteristics is optional. A single instance might exist.

A group item defining the primary mode of transport.

TransportVehicleCharacteristics

TransportVehicleCharacteristics is optional. A single instance might exist.

A group item defining the primary means of transporting the goods, such as a side port vessel. In some instances, the transport unit and vehicle are the same.

TransportUnitCharacteristics

TransportUnitCharacteristics is optional. A single instance might exist.

A group item defining and identifying the primary means of containing the goods.

In some instances, the transport unit and vehicle are the same.

TransportLoadingCharacteristics

TransportLoadingCharacteristics is optional. A single instance might exist.

A group item defining how the transported items are to be loaded.

TransportUnloadingCharacteristics

TransportUnloadingCharacteristics is optional. A single instance might exist.

A group item defining how the transported items are to be unloaded.

TransportOtherInstructions

TransportOtherInstructions is optional. Multiple instances might exist.

A group item defining any other instructions for the transport not covered in the description of transport mode, vehicle, unit, and loading characteristics or defining an alternative description for the categories mentioned above.

AdditionalText

AdditionalText is optional. Multiple instances might exist.

A text field that is used to communicate information not previously defined or for special instructions. To be used only for circumstances not covered by specific elements.

LoadAvailableHeaderStatusType [attribute]

LoadAvailableHeaderStatusType defines the status of the entire LoadAvailable e-Document at the header level.

This item is restricted to the following list.

Accepted

The supplied information is accepted.

Amended

The supplied information is changed

NoAction

The supplied information has not been amended and thereby requires no action.

Original

The supplied information is the first version of that information.

Rejected

The supplied information is rejected.



LoadAvailableInformation

LoadAvailableInformation is a group item containing information about the whole LoadAvailable e-Document.

(sequence)

The sequence of items below is mandatory. A single instance is required.

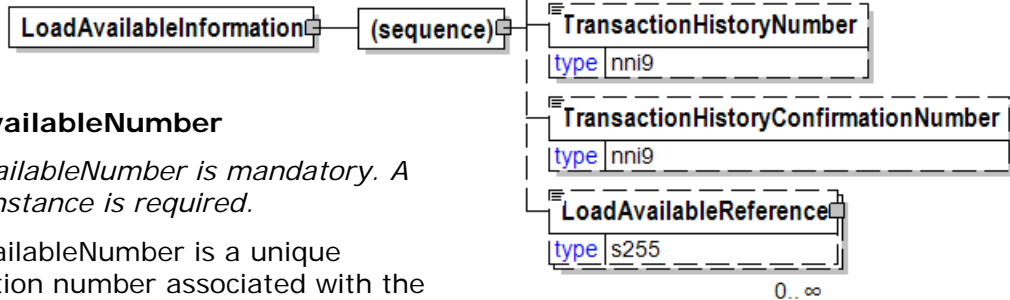

LoadAvailableNumber

LoadAvailableNumber is mandatory. A single instance is required.

LoadAvailableNumber is a unique transaction number associated with the whole LoadAvailable. This number is provided by the originator of the LoadAvailable e-Document and follows the document through its life.

LoadAvailableIssuedDate

LoadAvailableIssuedDate is mandatory. A single instance is required.

The date that the LoadAvailable was issued to the company to which the load was offered.

LoadAvailableConfirmationIssuedDate

LoadAvailableConfirmationIssuedDate is optional. A single instance might exist.

The date of response to the LoadAvailable e-Document from originating party.

TransactionHistoryNumber

TransactionHistoryNumber is optional. A single instance might exist.

A sequential number that keeps track of the version of a document being sent by the document originator except in the case where TransactionHistoryConfirmation is used, in which case the TransactionHistoryNumber refers to the trigger transaction for which the confirmation is being sent.

TransactionHistoryConfirmationNumber

TransactionHistoryConfirmationNumber is optional. A single instance might exist.

A sequential number that indicates the version of the confirmation document being sent.

LoadAvailableReference

LoadAvailableReference is optional. Multiple instances might exist.

LoadAvailableReferenceType provides a contextual explanation of the specific reference identifier.

LoadAvailableIssuedDate

The date that the LoadAvailable was issued to the company to which the load was offered.

(sequence)

The sequence of items below is mandatory. A single instance is required.

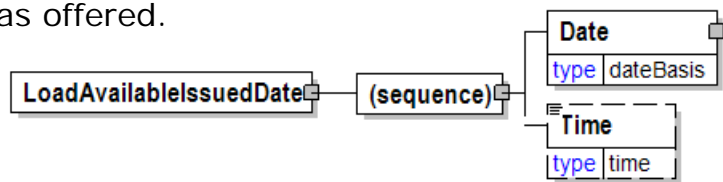

Date

Date is mandatory. A single instance is required.

A group element that contains the specification of Year, Month, and Day.

Time

Time is optional. A single instance might exist.

Times are treated in a standard XML fashion with a special case used to indicate a generalized "local" time. The standard XML approach to time is hh:mm:ss, hh:mm:ssZ, or hh:mm:ss±hh:mm.

hh:mm:ss±hh:mm is used to represent a time with a time zone. The time zone is communicated as the number of hours offset from the Universal Time Coordinate (UTC), a.k.a. Greenwich Mean Time.

hh:mm:ssZ indicates the time at Zulu (another name for UTC). Based on the convention described in the next bullet it will be important for users within UTC to use "Z" when communicating a time in their time zone to other users.

hh:mm:ss or hh:mm indicates in the XML standard the time at UTC however, within papiNet it is used to represent the applicable local time. Caution should be used when processing times of this nature as the papiNet approach may be in discord with other users of XML.

LoadAvailableLineItem

LoadAvailableLineItem is a group item containing information that relates to a line in the LoadAvailable e-Document.

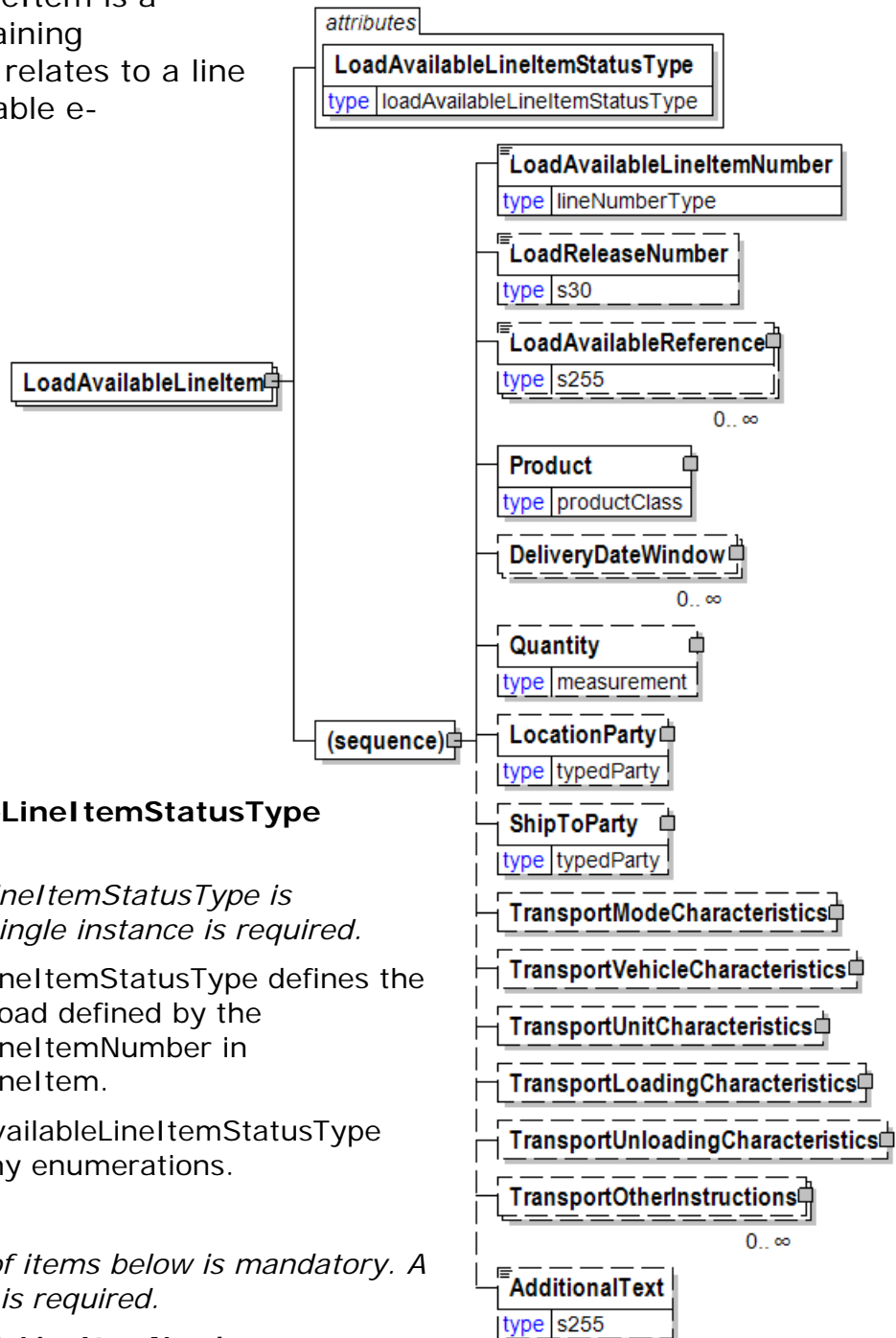

LoadAvailableLineItemStatusType [attribute]

LoadAvailableLineItemStatusType is mandatory. A single instance is required.

LoadAvailableLineItemStatusType defines the status of each load defined by the LoadAvailableLineItemNumber in LoadAvailableLineItem.

Refer to LoadAvailableLineItemStatusType definition for any enumerations.

(sequence)

The sequence of items below is mandatory. A single instance is required.

LoadAvailableLineItemNumber

LoadAvailableLineItemNumber is mandatory. A single instance is required.

LoadAvailableLineItemNumber is a unique number within a given LoadAvailable associating the number of loads available with a numeric sequence.

LoadReleaseNumber

LoadReleaseNumber is optional. A single instance might exist.

LoadReleaseNumber is a unique number identifying the load. The number comes from the company to whom the load was offered.

LoadAvailableReference

LoadAvailableReference is optional. Multiple instances might exist.

LoadAvailableReferenceType provides a contextual explanation of the specific reference identifier.

Product

Product is mandatory. A single instance is required.

Product is a group item defining the article and its characteristics. Product is used to specify product characteristics organized by ProductIdentifier, ProductDescription, and Classification. Book Manufacturing, Label Stock, Paper, Pulp, Recovered Paper, Wood Products, and Virgin Fibre market segments have defined their product characteristics and conversion features for implementation in papiNet.

DeliveryDateWindow

DeliveryDateWindow is optional. Multiple instances might exist.

A group item defining the date/time interval for delivery to take place. An element which may contain the estimated date for which delivery is expected. This date is not absolute.

Quantity

Quantity is optional. A single instance might exist.

The Quantity element contains attributes that provide information about the type of quantity that is being communicated, the context in which the particular quantity is to be viewed, and (if the quantity represents an adjustment) an adjustment type.

The Quantity element contains three child elements that enable you to communicate a range of values for the quantity and a target or actual value. It is at this level (Value, RangeMin, and RangeMax) that the unit of measure is specified. This permits the range to be specified in a different unit of measure than the target.

LocationParty

LocationParty is optional. A single instance might exist.

The organization or business entity where the business event took place or will take place.

ShipToParty

ShipToParty is optional. A single instance might exist.

The name and/or address to which the goods should be delivered with the party type indicated by the PartyType attribute.

TransportModeCharacteristics

TransportModeCharacteristics is optional. A single instance might exist.

A group item defining the primary mode of transport.

TransportVehicleCharacteristics

TransportVehicleCharacteristics is optional. A single instance might exist.

A group item defining the primary means of transporting the goods, such as a side port vessel. In some instances, the transport unit and vehicle are the same.

TransportUnitCharacteristics

TransportUnitCharacteristics is optional. A single instance might exist.

A group item defining and identifying the primary means of containing the goods. In some instances, the transport unit and vehicle are the same.

TransportLoadingCharacteristics

TransportLoadingCharacteristics is optional. A single instance might exist.

A group item defining how the transported items are to be loaded.

TransportUnloadingCharacteristics

TransportUnloadingCharacteristics is optional. A single instance might exist.

A group item defining how the transported items are to be unloaded.

TransportOtherInstructions

TransportOtherInstructions is optional. Multiple instances might exist.

A group item defining any other instructions for the transport not covered in the description of transport mode, vehicle, unit, and loading characteristics or defining an alternative description for the categories mentioned above.

AdditionalText

AdditionalText is optional. A single instance might exist.

A text field that is used to communicate information not previously defined or for special instructions. To be used only for circumstances not covered by specific elements.

LoadAvailableLineItemNumber

LoadAvailableLineItemNumber is a unique number within a given LoadAvailable associating the number of loads available with a numeric sequence.

LoadAvailableLineItemNumber
type lineNumberType

LoadAvailableLineItemStatusType [attribute]

LoadAvailableLineItemStatusType defines the status of each load defined by the LoadAvailableLineItemNumber in LoadAvailableLineItem.

attribute
LoadAvailableLineItemStatusType
type loadAvailableLineItemStatusType

This item is restricted to the following list.

Accepted

The supplied information is accepted.

Amended

The supplied information is changed

Cancelled

The supplied information has been cancelled. Items that have been cancelled are not included in totals on the summary levels of the e-Document.

NoAction

The supplied information has not been amended and thereby requires no action.

Original

The supplied information is the first version of that information.

Pending

The supplied information is not complete and will be updated later.

Rejected

The supplied information is rejected.

LoadAvailableNumber

LoadAvailableNumber is a unique transaction number associated with the whole LoadAvailable. This number is provided by the originator of the LoadAvailable e-Document and follows the document through its life.

LoadAvailableNumber	
type	s30

LoadAvailableReference

LoadAvailableReferenceType provides a contextual explanation of the specific reference identifier.

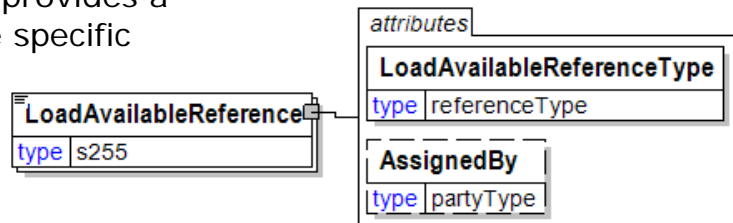

LoadAvailableReferenceType [attribute]

LoadAvailableReferenceType is mandatory. A single instance is required.

Provides a contextual explanation of the specific reference identifier. Many items are currently prefixed by "Buyer", "Forwarder", "Manufacturer", "Mill", "Seller", "Supplier", "Warehouse", or "Vendor". Check for an existing non-prefixed version and use the non-prefixed version instead. In the (yet to be announced release date) version 3.0 the prefixed versions will be removed. Instead the attribute @AssignedBy will communicate the information previously communicated in the prefix.

Refer to LoadAvailableReferenceType definition for any enumerations.

AssignedBy [attribute]

AssignedBy is optional. A single instance might exist.

Identifies the type of party that has assigned the associated item, e.g. a reference of type OrderNumber.

Refer to AssignedBy for any enumerations.

LoadAvailableReferenceType [attribute]

Provides a contextual explanation of the specific reference identifier. Many items are currently prefixed by "Buyer", "Forwarder", "Manufacturer", "Mill", "Seller", "Supplier", "Warehouse", or "Vendor". Check for an existing non-prefixed version and use the non-prefixed version instead. In

attribute	
LoadAvailableReferenceType	
type	referenceType

the (yet to be announced release date) version 3.0 the prefixed versions will be removed. Instead the attribute @AssignedBy will communicate the information previously communicated in the prefix.

Refer to the [referenceType](#) entry for the list of enumerations and their definitions.

LoadAvailableStatusType [attribute]

LoadAvailableStatusType defines the status of the entire LoadAvailable e-Document.

This item is restricted to the following list.



Accepted

The supplied information is accepted.

Amended

The supplied information is changed.

Cancelled

The supplied information has been cancelled. Items that have been cancelled are not included in totals on the summary levels of the e-Document.

Original

The supplied information is the first version of that information.

Rejected

The supplied information is rejected.

LoadAvailableSummary

LoadAvailable Summary

(sequence)

The sequence of items below is mandatory. A single instance is required.

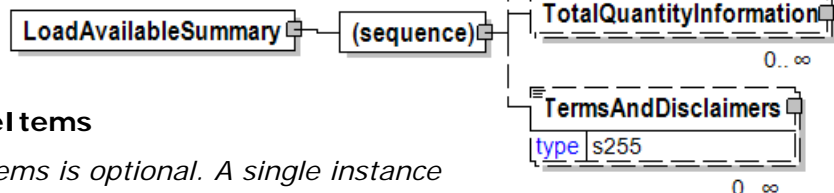

TotalNumberOfLineItems

TotalNumberOfLineItems is optional. A single instance might exist.

The total number of individual line items in the document, regardless of the status or type.

TotalQuantityInformation

TotalQuantityInformation is optional. Multiple instances might exist.

A group item containing information about the total quantity and total informational quantity of similar items in the document. TotalQuantityInformation is primarily used in the summary section of e-Documents where it is repeatable to permit totalling for different units of measure.

TermsAndDisclaimers

TermsAndDisclaimers is optional. Multiple instances might exist.

An element that contains legal information with an indication of what the Language is.

LoadAvailableType [attribute]

LoadAvailableType defines the type LoadAvailable e-Document.

This item is restricted to the following list.

LoadAvailable

LoadAvailable indicates the e-Document is from the company with the load.

LoadAvailableConfirmation

LoadAvailableConfirmation indicates the e-Document is from the company to whom the load was offered.

attribute
LoadAvailableType
type loadAvailableType

LoadingTolerance [attribute]

Specifies tolerance type for load quantity. Tolerance values are given by RangeMin and RangeMax in Quantity.

This item is restricted to the following list.

FillUpFromOtherOrder

Fill up a full load from an other order

Full

Always a full load

FullWithinTolerance

Always a full load if still within given tolerance

WithinTolerance

The load should be within given tolerance

attribute
LoadingTolerance
type loadingToleranceType

LoadNumber

An element used to communicate the unique identifier of the LoadNumber.

LoadNumber
type s30

LoadOpeningSide [attribute]

Specifies opening sides on a transport unit for loading and unloading seen in the transport direction of the goods carrier

This item is restricted to the following list.

attribute
LoadOpeningSide
type transportOrientationType

BackEndSide

Opening for loading and unloading is towards the back-end side

FrontEndSide

Opening for loading and unloading is towards the front-end side

LeftAndRightSide

Openings for loading and unloading are both towards the left side and the right side.

LeftSide

Opening for loading and unloading is towards the left side

RightSide

Opening for loading and unloading is towards the right side

LoadReleaseNumber

LoadReleaseNumber is a unique number identifying the load. The number comes from the company to whom the load was offered.

LoadReleaseNumber
type s30

LoadTender

The LoadTender element is the root element for the LoadTender e-Document.

The LoadTender e-Document supports the transport booking process. Transport booking includes the following steps:

- LoadTender – more than one carrier has been informed about the upcoming transport.
- Booking – identifies a transport booking that is part of a detail transport plan, the load has been booked with a single carrier.

LoadTenderType [attribute]

LoadTenderType is mandatory. A single instance is required.

Code indicating the function of the LoadTender e-Document.

Refer to LoadTenderType definition for any enumerations.

LoadTenderStatusType [attribute]

LoadTenderStatusType is mandatory. A single instance is required.

Identifies the status of the entire LoadTender e-Document (in other words, at

LoadTender

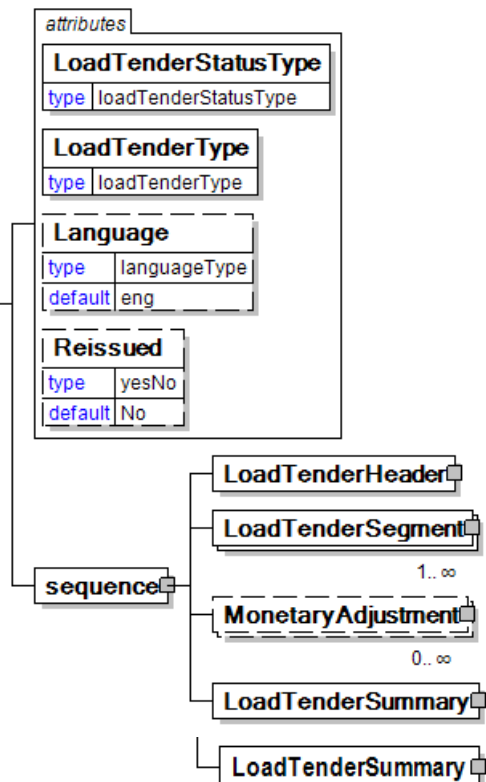

the root level).

Refer to LoadTenderStatusType definition for any enumerations.

Reissued [attribute]

Reissued is optional. A single instance might exist.

Either "Yes" or "No".

Refer to Reissued definition for any enumerations.

Language [attribute]

Language is optional. A single instance might exist.

XML has embraced 2 and 3 digit language codes through the application of an addendum to the standard.

Refer to Language definition for any enumerations.

(sequence)

The sequence of items below is mandatory. A single instance is required.

LoadTenderHeader

LoadTenderHeader is mandatory. A single instance is required.

The LoadTenderHeader contains information common to the entire LoadTender.

LoadTenderSegment

LoadTenderSegment is mandatory. One instance is required, multiple instances might exist.

The details for a particular load segment.

MonetaryAdjustment

MonetaryAdjustment is optional. Multiple instances might exist.

The element containing the information necessary for the understanding, calculation, and treatment of an adjustment to a currency amount. MonetaryAdjustment contains an attribute that indicates they type of adjustment being communicated.

LoadTenderSummary

LoadTenderSummary is mandatory. A single instance is required.

Summary information that applies to the entire LoadTender e-Document.

LoadTenderAmount

Total Amount for this LoadTender Line Item. Determined from Quantity times the PricePerUnit.

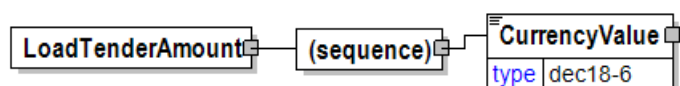

(sequence)

The sequence of items below is mandatory. A single instance is required.

CurrencyValue

CurrencyValue is mandatory. A single instance is required.

The amount in the referenced currency as defined by the CurrencyType attribute.

LoadTenderHeader

The LoadTenderHeader contains information common to the entire LoadTender.

LoadTenderHeaderStatusType [attribute]

LoadTenderHeaderStatusType is mandatory. A single instance is required.

Identifies the status of the header of the LoadTender e-Document.

Refer to

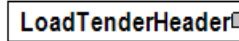

LoadTenderHeaderStatusType definition for any enumerations.

(sequence)

The sequence of items below is mandatory. A single instance is required.

LoadTenderNumber

LoadTenderNumber is mandatory. A single instance is required.

The identifier for the LoadTender b-e-Document.

LoadTenderIssueDate

LoadTenderIssueDate is mandatory. A single instance is required.

The date when the e-Document was issued.

TransactionHistoryNumber

TransactionHistoryNumber is optional. A single instance might exist.

A sequential number that keeps track of the version of a document being sent by the document originator except in the case where TransactionHistoryConfirmation is used, in which case the TransactionHistoryNumber refers to the trigger transaction for which the confirmation is being sent.

LoadTenderReference

LoadTenderReference is optional. Multiple instances might exist.

An item detailing relevant references pertaining to the LoadTender. The type of reference is identified by the LoadTenderReferenceType attribute.

TransportInformation

TransportInformation is optional. A single instance might exist.

A grouping element for transport information.

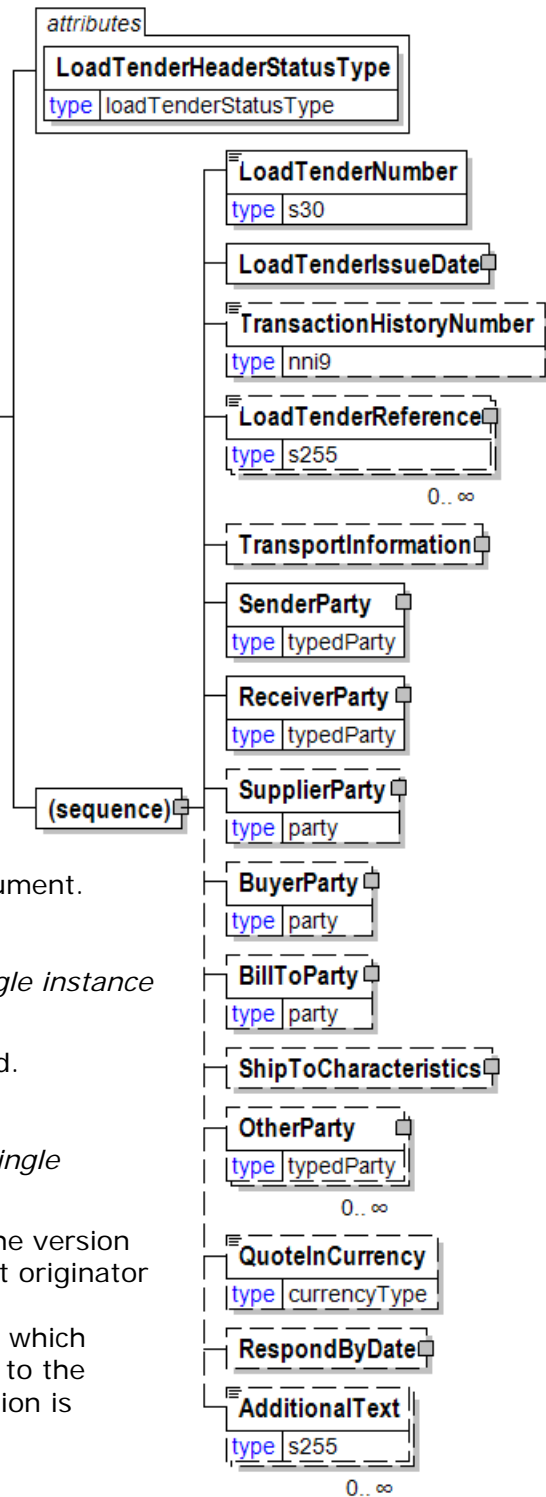

SenderParty

SenderParty is mandatory. A single instance is required.

The business entity issuing the e-Document, the source of the document.

The entity responsible for the content. If the sender party has out sourced the message service to a third party the SenderParty is the issuer of the e-Document and not the party performing the transmission service of the electronic message.

ReceiverParty

ReceiverParty is mandatory. A single instance is required.

The business entity for whom the e-Document is intended, the destination of the document.

The entity interested in the content. If the receiver party has outsourced the message service to a third party the ReceiverParty is the intended party for the e-Document and not the party performing the receiving service of the electronic message.

SupplierParty

SupplierParty is optional. A single instance might exist.

The organisation or business entity responsible for providing the product. SupplierParty is also the seller of the product, if Seller is not specified as OtherParty = Seller.

BuyerParty

BuyerParty is optional. A single instance might exist.

The legal entity to which the product is sold. Also commonly referred to as the sold-to party or customer. If no OtherParty is defined as the Payer, the Buyer is the Payer.

BillToParty

BillToParty is optional. A single instance might exist.

The address where the invoice is to be sent.

ShipToCharacteristics

ShipToCharacteristics is optional. A single instance might exist.

A group item that provides information important for the Ship-To Party.

A group item that provides information important for the Ship-To Party. ShipToCharacteristics may be referenced at both the header and line item level. The reference at the header is required and acts as a default for the value at the line level, unless overridden at the line level.

OtherParty

OtherParty is optional. Multiple instances might exist.

An organisation or business entity other than those specifically detailed within a e-Document.

QuoteInCurrency

QuoteInCurrency is optional. A single instance might exist.

Indicates that the quote is to be provided in the currency specified.

Refer to QuoteInCurrency definition for any enumerations.

RespondByDate

RespondByDate is optional. A single instance might exist.

The date that a response to the query if required.

AdditionalText

AdditionalText is optional. Multiple instances might exist.

A text field that is used to communicate information not previously defined or for special instructions. To be used only for circumstances not covered by specific elements.

LoadTenderHeaderStatusType [attribute]

Identifies the status of the header of the LoadTender e-Document.

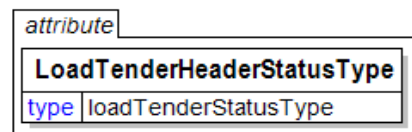

This item is restricted to the following list.

Amended

The supplied information is changed.

Cancelled

The supplied information has been cancelled. Items that have been cancelled are not included in totals on the summary levels of the e-Document.

Original

The supplied information is the first version of that information.

LoadTenderIssueDate

The date when the e-Document was issued.

(sequence)

The sequence of items below is mandatory. A single instance is required.

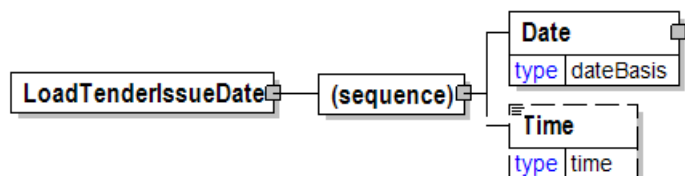

Date

Date is mandatory. A single instance is required.

A group element that contains the specification of Year, Month, and Day.

Time

Time is optional. A single instance might exist.

Times are treated in a standard XML fashion with a special case used to indicate a generalized "local" time. The standard XML approach to time is hh:mm:ss, hh:mm:ssZ, or hh:mm:ss±hh:mm.

hh:mm:ss±hh:mm is used to represent a time with a time zone. The time zone is communicated as the number of hours offset from the Universal Time Coordinate (UTC), a.k.a. Greenwich Mean Time.

hh:mm:ssZ indicates the time at Zulu (another name for UTC). Based on the convention described in the next bullet it will be important for users within UTC to use "Z" when communicating a time in their time zone to other users.

hh:mm:ss or hh:mm indicates in the XML standard the time at UTC however,

within papiNet it is used to represent the applicable local time. Caution should be used when processing times of this nature as the papiNet approach may be in discord with other users of XML.

LoadTenderLineItem

Group element identifying a line item to be included within this LoadTender Segment.

(sequence)

The sequence of items below is mandatory. A single instance is required.

LoadTenderLineItemNumber

LoadTenderLineItemNumber is mandatory. A single instance is required.

The sequential number that uniquely identifies the LoadTender line item.

SupplierParty



SupplierParty is optional. A single instance might exist.

The organisation or business entity responsible for providing the product. SupplierParty is also the seller of the product, if Seller is not specified as OtherParty = Seller.

Product

Product is optional. A single instance might exist.

Product is a group item defining the article and its characteristics. Product is used to specify product characteristics organized by ProductIdentifier, ProductDescription, and Classification. Book Manufacturing, Label Stock, Paper, Pulp, Recovered Paper, Wood Products, and Virgin Fibre market segments have defined their product characteristics and conversion features for implementation in papiNet.

QuantityInformation

QuantityInformation is mandatory. A single instance is required.

A group item containing information about quantity and informational quantity of similar items.

LoadTenderLineItemBaseAmountInformation

LoadTenderLineItemBaseAmountInformation is optional. A single instance might exist.

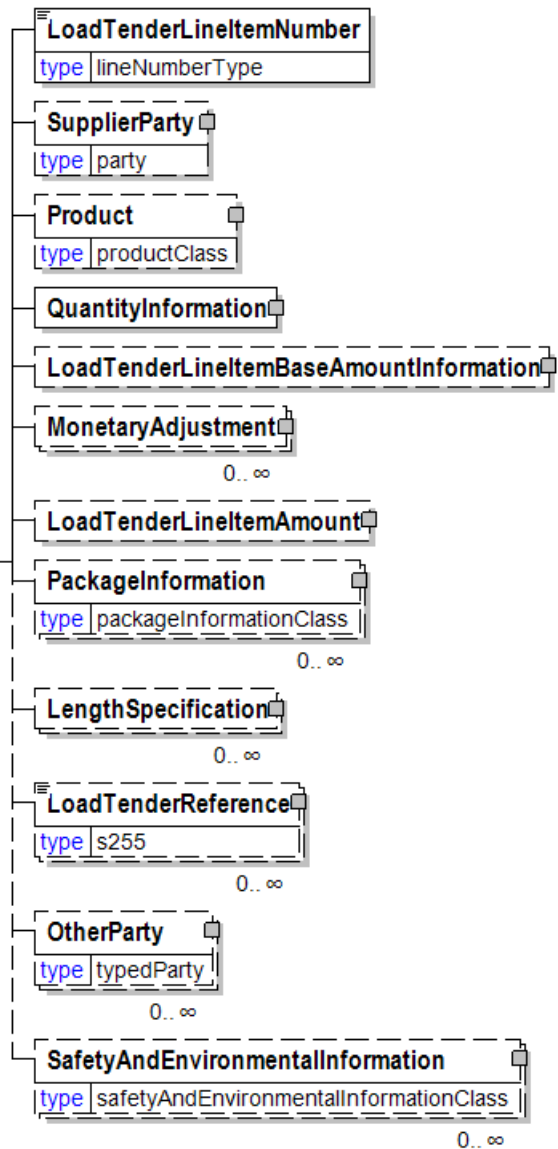

Group element used to detail the LoadTender Line Item's PriceDetails and TotalAmount. Normally used to identify the PricePerUnit of the line item.

MonetaryAdjustment

MonetaryAdjustment is optional. Multiple instances might exist.

The element containing the information necessary for the understanding, calculation, and treatment of an adjustment to a currency amount. MonetaryAdjustment contains an attribute that indicates the type of adjustment being communicated.

LoadTenderLineItemAmount

LoadTenderLineItemAmount is optional. A single instance might exist.

Total Amount of LoadTender Line Item including any adjustments. That is, the LoadTenderAmount plus all MonetaryAdjustments.

PackageInformation

PackageInformation is optional. Multiple instances might exist.

The purpose of the PackageInformation structure is to clearly identify physical handling items that constitute the delivery.

PackageInformation is the highest level of product packaging it describes the shipping or warehousing unit.

If you are communicating a package, usually for logistics or transport purposes, you should include the PackageType, Identifier, ItemCount, and Quantity. (Note: you still have the ability to describe the item with one of the "named" items.)

If you are communicating one of the named Items there is no need to include PackageType, Identifier, ItemCount, and Quantity.

Since either of these two approaches can be used the entire contents of this element are optional even though the parent may be required. It is expected that you will fill in the appropriate details.

LengthSpecification

LengthSpecification is optional. Multiple instances might exist.

Length specification of the wood product.

LoadTenderReference

LoadTenderReference is optional. Multiple instances might exist.

An item detailing relevant references pertaining to the LoadTender. The type of reference is identified by the LoadTenderReferenceType attribute.

OtherParty

OtherParty is optional. Multiple instances might exist.

An organisation or business entity other than those specifically detailed within a e-Document.

SafetyAndEnvironmentalInformation

SafetyAndEnvironmentalInformation is optional. Multiple instances might exist.

Name of certification type, if any, on the goods (For example, FSC, PEFC). SafetyAndEnvironmental needs a value or measurement to communicate the percentage of the product is certified (for example, 75% is certified by the indicated agency).

LoadTenderLineItemAmount

Total Amount of LoadTender Line Item including any adjustments. That is, the LoadTenderAmount plus all MonetaryAdjustments.

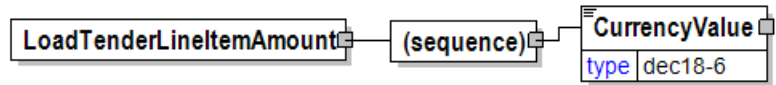

(sequence)

The sequence of items below is mandatory. A single instance is required.

CurrencyValue

CurrencyValue is mandatory. A single instance is required.

The amount in the referenced currency as defined by the CurrencyType attribute.

LoadTenderLineItemBaseAmountInformation

Group element used to detail the LoadTender Line Item's PriceDetails and TotalAmount. Normally used to identify the PricePerUnit of the line item.

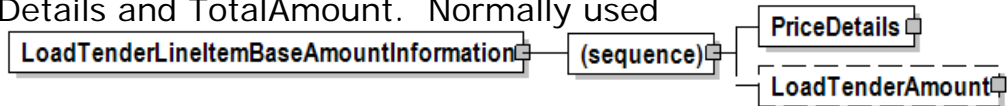

(sequence)

The sequence of items below is mandatory. A single instance is required.

PriceDetails

PriceDetails is mandatory. A single instance is required.

An element that groups together price information.

LoadTenderAmount

LoadTenderAmount is optional. A single instance might exist.

Total Amount for this LoadTender Line Item. Determined from Quantity times the PricePerUnit.

LoadTenderLineItemNumber

The sequential number that uniquely identifies the LoadTender line item.

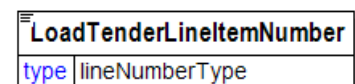

LoadTenderNumber

The identifier for the LoadTender b-e-Document.

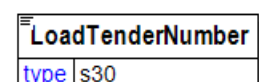

LoadTenderReference

An item detailing relevant references pertaining to the LoadTender. The type of reference is identified by the LoadTenderReferenceType attribute.

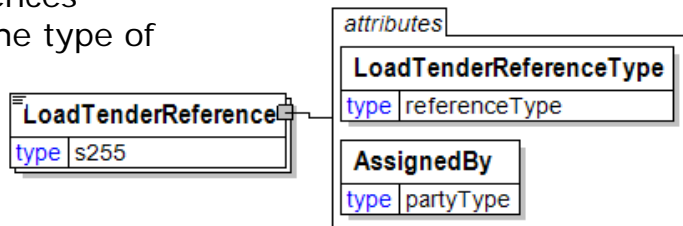

LoadTenderReferenceType [attribute]

LoadTenderReferenceType is mandatory. A single instance is required.

Provides a contextual explanation of the specific reference identifier. Many items are currently prefixed by "Buyer", "Forwarder", "Manufacturer", "Mill", "Seller", "Supplier", "Warehouse", or "Vendor". Check for an existing non-prefixed version and use the non-prefixed version instead. In the (yet to be announced release date) version 3.0 the prefixed versions will be removed. Instead the attribute @AssignedBy will communicate the information previously communicated in the prefix.

Refer to LoadTenderReferenceType definition for any enumerations.

AssignedBy [attribute]

AssignedBy is optional. A single instance might exist.

Identifies the type of party that has assigned the associated item, e.g. a reference of type OrderNumber.

Refer to AssignedBy for any enumerations.

LoadTenderReferenceType [attribute]

Provides a contextual explanation of the specific reference identifier. Many items are currently prefixed by "Buyer", "Forwarder", "Manufacturer", "Mill", "Seller", "Supplier", "Warehouse", or "Vendor". Check for an existing non-prefixed version and use the non-prefixed version instead. In the (yet to be announced release date) version 3.0 the prefixed versions will be removed. Instead the attribute @AssignedBy will communicate the information previously communicated in the prefix.

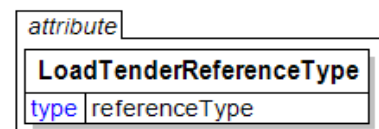

Refer to the [referenceType](#) entry for the list of enumerations and their definitions.

LoadTenderResponse

The LoadTenderResponse element is the root element for the LoadTenderResponse e-Document.

The LoadTenderResponse e-Document supports the transport booking process and is used as a response e-Document to LoadTender e-

Document. Transport booking includes the following steps:

- LoadTenderResponse – more than one carrier has been informed about the upcoming transport.
- BookingConfirmation – identifies a transport booking that is part of a detail transport plan, the load has been booked with a single carrier.

LoadTenderResponse

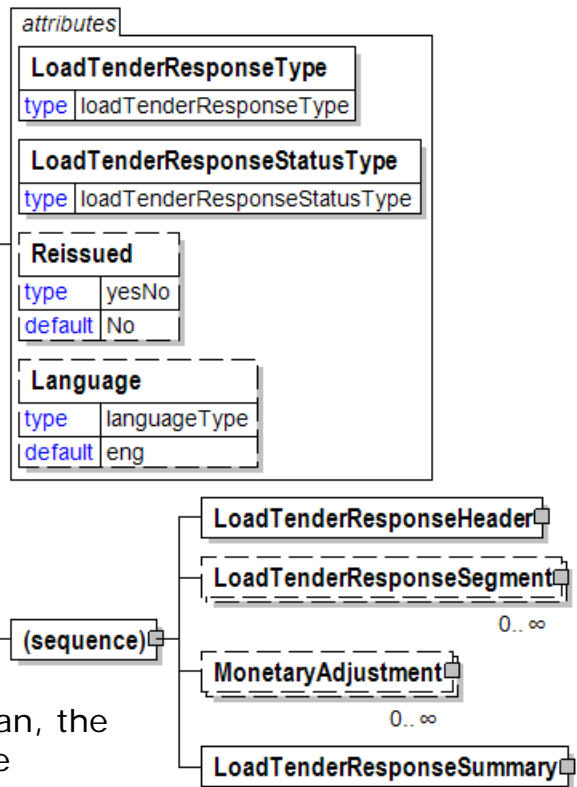

The LoadTenderResponse provides a means of communicating these events.

LoadTenderResponseType [attribute]

LoadTenderResponseType is mandatory. A single instance is required.

Code indicating the function of the e-Document.

Refer to LoadTenderResponseType definition for any enumerations.

LoadTenderResponseStatusType [attribute]

LoadTenderResponseStatusType is mandatory. A single instance is required.

Identifies the status of the entire LoadTenderResponse e-Document (in other words, at the root level).

Refer to LoadTenderResponseStatusType definition for any enumerations.

Reissued [attribute]

Reissued is optional. A single instance might exist.

Either "Yes" or "No".

Refer to Reissued definition for any enumerations.

Language [attribute]

Language is optional. A single instance might exist.

XML has embraced 2 and 3 digit language codes through the application of an addendum to the standard.

Refer to Language definition for any enumerations.

(sequence)

The sequence of items below is mandatory. A single instance is required.

LoadTenderResponseHeader

LoadTenderResponseHeader is mandatory. A single instance is required.

The LoadTenderResponseHeader contains information common to the entire LoadTenderResponse.

LoadTenderResponseSegment

LoadTenderResponseSegment is optional. Multiple instances might exist.

The details for a particular load segment.

MonetaryAdjustment

MonetaryAdjustment is optional. Multiple instances might exist.

The element containing the information necessary for the understanding, calculation, and treatment of an adjustment to a currency amount. MonetaryAdjustment contains an attribute that indicates they type of adjustment being communicated.

LoadTenderResponseSummary

LoadTenderResponseSummary is mandatory. A single instance is required.

Summary information that applies to the entire LoadTenderResponse e-Document.

LoadTenderResponseHeader

The LoadTenderResponseHeader contains information common to the entire LoadTenderResponse.

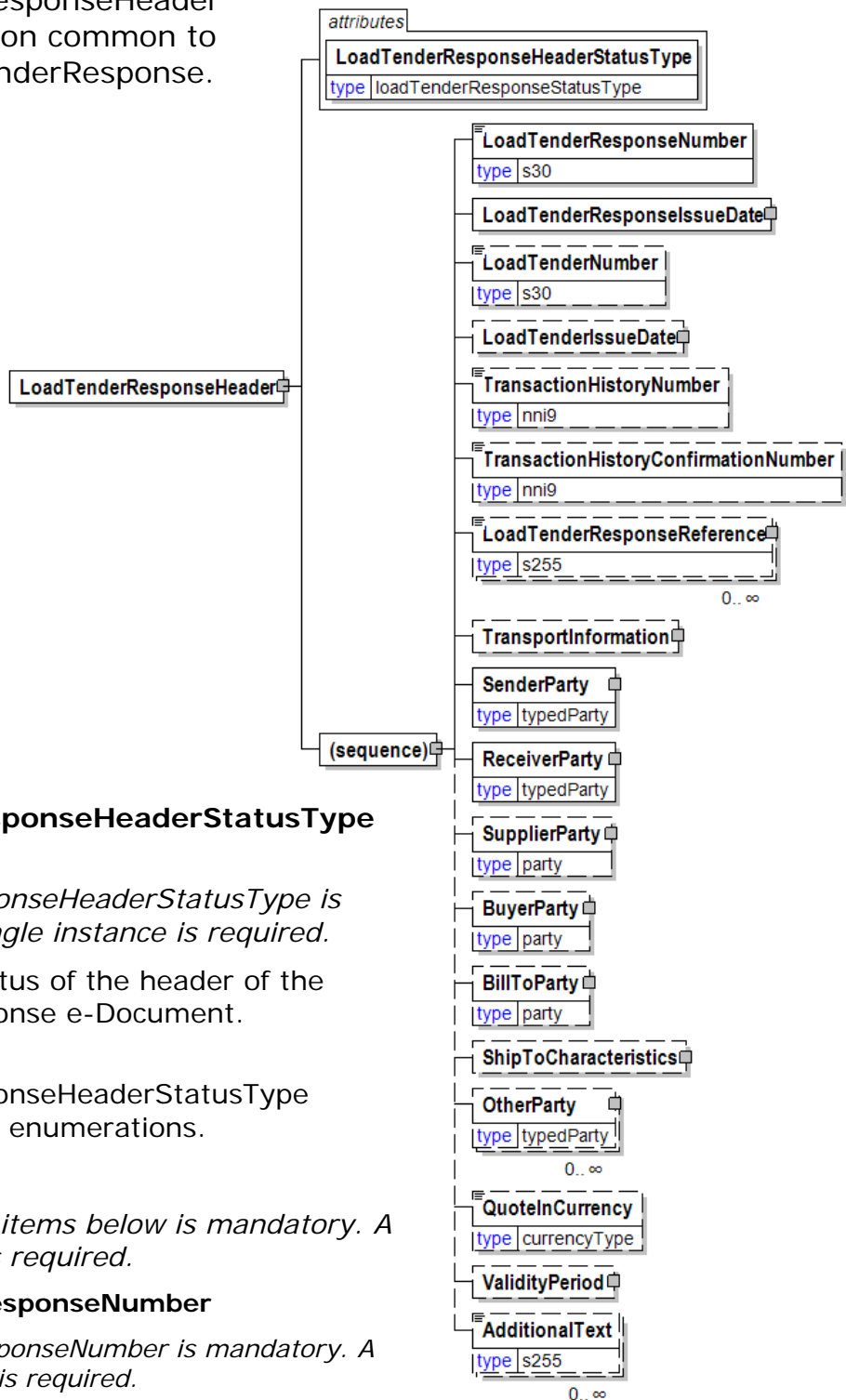

LoadTenderResponseHeaderStatusType [attribute]

LoadTenderResponseHeaderStatusType is mandatory. A single instance is required.

Identifies the status of the header of the LoadTenderResponse e-Document.

Refer to LoadTenderResponseHeaderStatusType definition for any enumerations.

(sequence)

The sequence of items below is mandatory. A single instance is required.

LoadTenderResponseNumber

LoadTenderResponseNumber is mandatory. A single instance is required.

The identifier for the LoadTenderResponse e-Document.

LoadTenderResponseIssueDate

LoadTenderResponseIssueDate is mandatory. A single instance is required.

The date when the e-Document was issued.

LoadTenderNumber

LoadTenderNumber is optional. A single instance might exist.

The identifier for the LoadTender b-e-Document.

LoadTenderIssueDate

LoadTenderIssueDate is optional. A single instance might exist.

The date when the e-Document was issued.

TransactionHistoryNumber

TransactionHistoryNumber is optional. A single instance might exist.

A sequential number that keeps track of the version of a document being sent by the document originator except in the case where TransactionHistoryConfirmation is used, in which case the TransactionHistoryNumber refers to the trigger transaction for which the confirmation is being sent.

TransactionHistoryConfirmationNumber

TransactionHistoryConfirmationNumber is optional. A single instance might exist.

A sequential number that indicates the version of the confirmation document being sent.

LoadTenderResponseReference

LoadTenderResponseReference is optional. Multiple instances might exist.

An item detailing relevant references pertaining to the LoadTenderResponse. The type of reference is identified by the LoadTenderReferenceType attribute.

TransportInformation

TransportInformation is optional. A single instance might exist.

A grouping element for transport information.

SenderParty

SenderParty is mandatory. A single instance is required.

The business entity issuing the e-Document, the source of the document.

The entity responsible for the content. If the sender party has out sourced the message service to a third party the SenderParty is the issuer of the e-Document and not the party performing the transmission service of the electronic message.

ReceiverParty

ReceiverParty is mandatory. A single instance is required.

The business entity for whom the e-Document is intended, the destination of the document.

The entity interested in the content. If the receiver party has outsourced the message service to a third party the ReceiverParty is the intended party for the e-Document and not the party performing the receiving service of the electronic message.

SupplierParty

SupplierParty is optional. A single instance might exist.

The organisation or business entity responsible for providing the product. SupplierParty is also the seller of the product, if Seller is not specified as OtherParty = Seller.

BuyerParty

BuyerParty is optional. A single instance might exist.

The legal entity to which the product is sold. Also commonly referred to as the sold-

to party or customer. If no OtherParty is defined as the Payer, the Buyer is the Payer.

BillToParty

BillToParty is optional. A single instance might exist.

The address where the invoice is to be sent.

ShipToCharacteristics

ShipToCharacteristics is optional. A single instance might exist.

A group item that provides information important for the Ship-To Party.

A group item that provides information important for the Ship-To Party. ShipToCharacteristics may be referenced at both the header and line item level. The reference at the header is required and acts as a default for the value at the line level, unless overridden at the line level.

OtherParty

OtherParty is optional. Multiple instances might exist.

An organisation or business entity other than those specifically detailed within a e-Document.

QuoteInCurrency

QuoteInCurrency is optional. A single instance might exist.

Indicates that the quote is to be provided in the currency specified.

Refer to QuoteInCurrency definition for any enumerations.

ValidityPeriod

ValidityPeriod is optional. A single instance might exist.

The validity period for a specific item, e.g. the validity period for an e-Document.

AdditionalText

AdditionalText is optional. Multiple instances might exist.

A text field that is used to communicate information not previously defined or for special instructions. To be used only for circumstances not covered by specific elements.

LoadTenderResponseHeaderStatusType [attribute]

Identifies the status of the header of the LoadTenderResponse e-Document.

This item is restricted to the following list.

attribute
LoadTenderResponseHeaderStatusType
type loadTenderResponseStatusType

Accepted

The supplied information is accepted.

Amended

The supplied information is changed

Cancelled

The supplied information has been cancelled. Items that have been cancelled are not included in totals on the summary levels of the e-Document.

Rejected

The supplied information is rejected.

LoadTenderResponseIssueDate

The date when the e-Document was issued.

(sequence)

The sequence of items below is mandatory. A single instance is required.

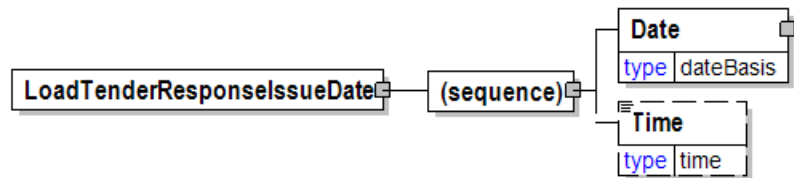

Date

Date is mandatory. A single instance is required.

A group element that contains the specification of Year, Month, and Day.

Time

Time is optional. A single instance might exist.

Times are treated in a standard XML fashion with a special case used to indicate a generalized "local" time. The standard XML approach to time is hh:mm:ss, hh:mm:ssZ, or hh:mm:ss±hh:mm.

hh:mm:ss±hh:mm is used to represent a time with a time zone. The time zone is communicated as the number of hours offset from the Universal Time Coordinate (UTC), a.k.a. Greenwich Mean Time.

hh:mm:ssZ indicates the time at Zulu (another name for UTC). Based on the convention described in the next bullet it will be important for users within UTC to use "Z" when communicating a time in their time zone to other users.

hh:mm:ss or hh:mm indicates in the XML standard the time at UTC however, within papiNet it is used to represent the applicable local time. Caution should be used when processing times of this nature as the papiNet approach may be in discord with other users of XML.

LoadTenderResponseLineItem

The details for a particular load line item.

(sequence)

The sequence of items below is mandatory. A single instance is required.



LoadTenderResponseLineItemNumber

LoadTenderResponseLineItemNumber is mandatory. A single instance is required.

The sequential number that uniquely identifies the LoadTenderResponse line item.

SupplierParty

SupplierParty is optional. A single instance might exist.

The organisation or business entity responsible for providing the product.

SupplierParty is also the seller of the product, if Seller is not specified as OtherParty = Seller.

Product

Product is optional. A single instance might exist.

Product is a group item defining the article and its characteristics. Product is used to specify product characteristics organized by ProductIdentifier, ProductDescription, and Classification. Book Manufacturing, Label Stock, Paper, Pulp, Recovered Paper, Wood Products, and Virgin Fibre market segments have defined their product characteristics and conversion features for implementation in

papiNet.

QuantityInformation

QuantityInformation is mandatory. A single instance is required.

A group item containing information about quantity and informational quantity of similar items.

LoadTenderLineItemBaseAmountInformation

LoadTenderLineItemBaseAmountInformation is optional. A single instance might exist.

Group element used to detail the LoadTender Line Item's PriceDetails and TotalAmount. Normally used to identify the PricePerUnit of the line item.

MonetaryAdjustment

MonetaryAdjustment is optional. Multiple instances might exist.

The element containing the information necessary for the understanding, calculation, and treatment of an adjustment to a currency amount. MonetaryAdjustment contains an attribute that indicates they type of adjustment being communicated.

LoadTenderLineItemAmount

LoadTenderLineItemAmount is optional. A single instance might exist.

Total Amount of LoadTender Line Item including any adjustments. That is, the LoadTenderAmount plus all MonetaryAdjustments.

PackageInformation

PackageInformation is optional. Multiple instances might exist.

The purpose of the PackageInformation structure is to clearly identify physical handling items that constitute the delivery.

PackageInformation is the highest level of product packaging it describes the shipping or warehousing unit.

If you are communicating a package, usually for logistics or transport purposes, you should include the PackageType, Identifier, ItemCount, and Quantity. (Note: you still have the ability to describe the item with one of the "named" items.)

If you are communicating one of the named Items there is no need to include PackageType, Identifier, ItemCount, and Quantity.

Since either of these two approaches can be used the entire contents of this element are optional even though the parent may be required. It is expected that you will fill in the appropriate details.

LengthSpecification

LengthSpecification is optional. Multiple instances might exist.

Length specification of the wood product.

LoadTenderResponseReference

LoadTenderResponseReference is optional. Multiple instances might exist.

An item detailing relevant references pertaining to the LoadTenderResponse. The type of reference is identified by the LoadTenderReferenceType attribute.

OtherParty

OtherParty is optional. Multiple instances might exist.

An organisation or business entity other than those specifically detailed within a e-Document.

SafetyAndEnvironmentalInformation

SafetyAndEnvironmentalInformation is optional. Multiple instances might exist.

Name of certification type, if any, on the goods (For example, FSC, PEFC). SafetyAndEnvironmental needs a value or measurement to communicate the percentage of the product is certified (for example, 75% is certified by the indicated agency).

LoadTenderResponseLineItemNumber

The sequential number that uniquely identifies the LoadTenderResponse line item.

LoadTenderResponseLineItemNumber
type lineNumberType

LoadTenderResponseNumber

The identifier for the LoadTenderResponse e-Document.

LoadTenderResponseNumber
type s30

LoadTenderResponseReference

An item detailing relevant references pertaining to the LoadTenderResponse. The type of reference is identified by the

LoadTenderResponseReference
type s255

attributes
LoadTenderResponseReferenceType
type referenceType
AssignedBy
type partyType

LoadTenderReferenceType attribute.

LoadTenderResponseReferenceType [attribute]

LoadTenderResponseReferenceType is mandatory. A single instance is required.

Provides a contextual explanation of the specific reference identifier. Many items are currently prefixed by "Buyer", "Forwarder", "Manufacturer", "Mill", "Seller", "Supplier", "Warehouse", or "Vendor". Check for an existing non-prefixed version and use the non-prefixed version instead. In the (yet to be announced release date) version 3.0 the prefixed versions will be removed. Instead the attribute @AssignedBy will communicate the information previously communicated in the prefix.

Refer to LoadTenderResponseReferenceType definition for any enumerations.

AssignedBy [attribute]

AssignedBy is optional. A single instance might exist.

Identifies the type of party that has assigned the associated item, e.g. a reference of type OrderNumber.

Refer to AssignedBy for any enumerations.

LoadTenderResponseReferenceType [attribute]

Provides a contextual explanation of the specific reference identifier. Many items are currently prefixed by "Buyer", "Forwarder", "Manufacturer", "Mill", "Seller", "Supplier", "Warehouse", or "Vendor". Check for an existing non-prefixed version and use the non-prefixed version instead. In the (yet to be announced release date) version 3.0 the prefixed versions will be removed. Instead the attribute @AssignedBy will communicate the information previously communicated in the prefix.

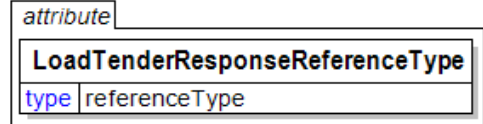

Refer to the [referenceType](#) entry for the list of enumerations and their definitions.

LoadTenderResponseSegment

The details for a particular load segment.

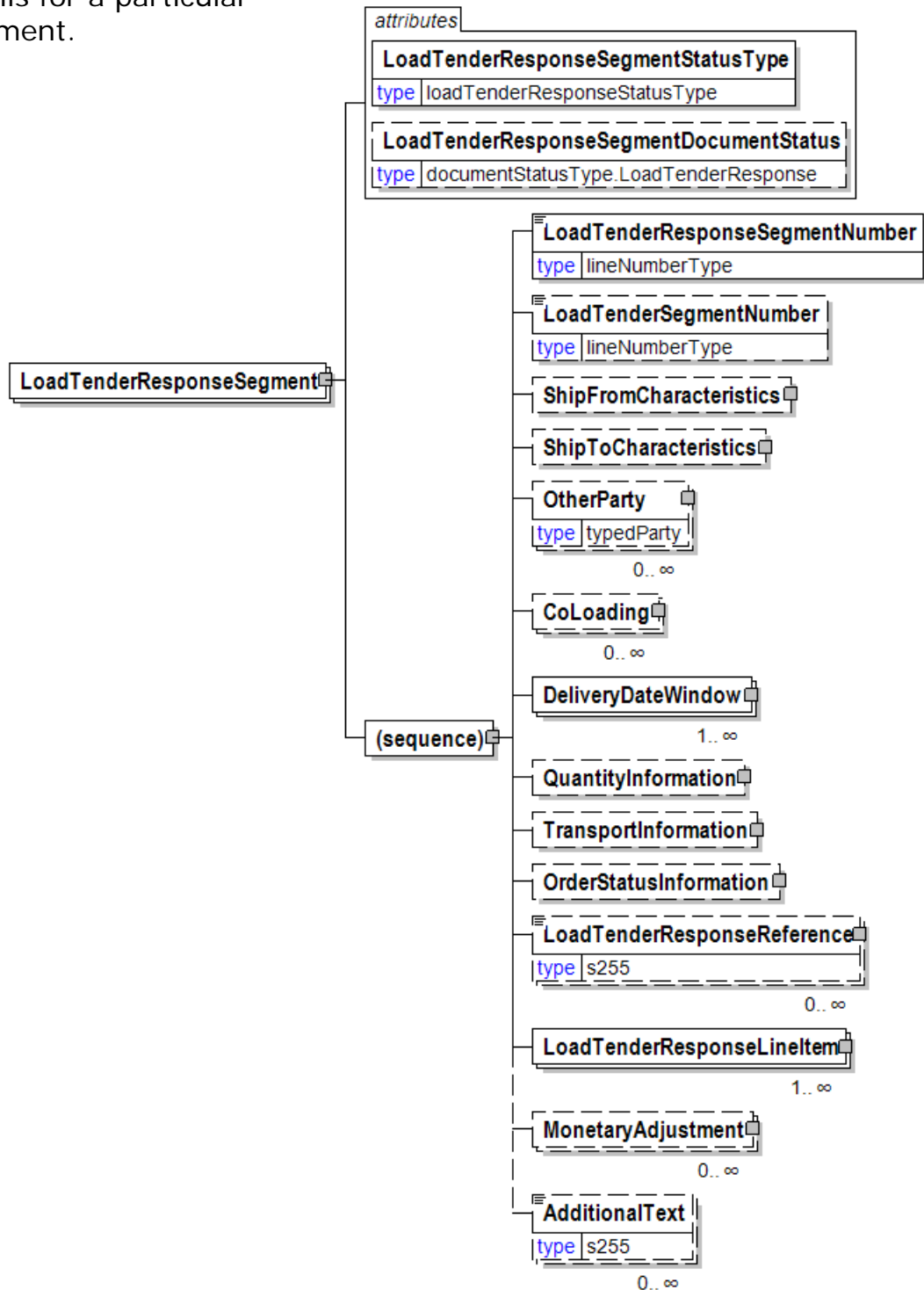

LoadTenderResponseSegmentStatusType [attribute]

LoadTenderResponseSegmentStatusType is mandatory. A single instance is required.

Identifies the status of the load tender segment.

Refer to `LoadTenderResponseSegmentStatusType` definition for any enumerations.

LoadTenderResponseSegmentDocumentStatus [attribute]

LoadTenderResponseSegmentDocumentStatus is optional. A single instance might exist.

Defines the actual document status for the LoadTenderResponseSegment.

Refer to LoadTenderResponseSegmentDocumentStatus definition for any enumerations.

(sequence)

The sequence of items below is mandatory. A single instance is required.

LoadTenderResponseSegmentNumber

LoadTenderResponseSegmentNumber is mandatory. A single instance is required.

The identifier for the LoadTenderResponse segment.

LoadTenderSegmentNumber

LoadTenderSegmentNumber is optional. A single instance might exist.

The identifier for the LoadTender segment.

ShipFromCharacteristics

ShipFromCharacteristics is optional. A single instance might exist.

A group item that provides information pertaining to the Ship-From Party.

ShipFromCharacteristics may be referenced at both the header and line item level. The reference at the header, if it exists, acts as a default for the value at the line level, unless overridden at the line level.

ShipToCharacteristics

ShipToCharacteristics is optional. A single instance might exist.

A group item that provides information important for the Ship-To Party.

A group item that provides information important for the Ship-To Party. ShipToCharacteristics may be referenced at both the header and line item level. The reference at the header is required and acts as a default for the value at the line level, unless overridden at the line level.

OtherParty

OtherParty is optional. Multiple instances might exist.

An organisation or business entity other than those specifically detailed within a e-Document.

CoLoading

CoLoading is optional. Multiple instances might exist.

A group item specifying information about items to be loaded or loaded on the same transport unit.

Used to identify:

- Delivery together to the drop point

- Transport Orders stuffed together in a container

- Transport Orders not splittable

DeliveryDateWindow

DeliveryDateWindow is mandatory. One instance is required, multiple instances might exist.

papiNet V2R31

A group item defining the date/time interval for delivery to take place. An element which may contain the estimated date for which delivery is expected. This date is not absolute.

QuantityInformation

QuantityInformation is optional. A single instance might exist.

A group item containing information about quantity and informational quantity of similar items.

TransportInformation

TransportInformation is optional. A single instance might exist.

A grouping element for transport information.

OrderStatusInformation

OrderStatusInformation is optional. A single instance might exist.

A group element that stores two levels of order status codes.

LoadTenderResponseReference

LoadTenderResponseReference is optional. Multiple instances might exist.

An item detailing relevant references pertaining to the LoadTenderResponse. The type of reference is identified by the LoadTenderReferenceType attribute.

LoadTenderResponseLineItem

LoadTenderResponseLineItem is mandatory. One instance is required, multiple instances might exist.

The details for a particular load line item.

MonetaryAdjustment

MonetaryAdjustment is optional. Multiple instances might exist.

The element containing the information necessary for the understanding, calculation, and treatment of an adjustment to a currency amount. MonetaryAdjustment contains an attribute that indicates they type of adjustment being communicated.

AdditionalText

AdditionalText is optional. Multiple instances might exist.

A text field that is used to communicate information not previously defined or for special instructions. To be used only for circumstances not covered by specific elements.

LoadTenderResponseSegmentDocumentStatus [attribute]

Defines the actual document status for the LoadTenderResponseSegment.

This item is restricted to the following list.

Cancelled

The supplied information of the document item is cancelled. Items that have been cancelled are not included in totals on the summary level of e-Documents.

attribute
LoadTenderResponseSegmentDocumentStatus
type documentStatusType.LoadTenderResponse

Confirmed

The supplied information of the document item is agreed. If a requested change or cancellation of an existing document item can not be accepted, then the earlier agreed information of the document item will be re-confirmed.

Pending

The supplied information of the document item is being investigated.

Rejected

The supplied information of the document item can not be accepted. The document item is new or not earlier confirmed.

LoadTenderResponseSegmentNumber

The identifier for the LoadTenderResponse segment.

LoadTenderResponseSegmentNumber
type lineNumberType

LoadTenderResponseSegmentStatusType [attribute]

Identifies the status of the LoadTender segment.

This item is restricted to the following list.

attribute
LoadTenderResponseSegmentStatusType
type loadTenderResponseStatusType

Accepted

The supplied information is accepted.

Amended

The supplied information is changed.

Cancelled

The supplied information has been cancelled. Items that have been cancelled are not included in totals on the summary levels of the e-Document.

Rejected

The supplied information is rejected.

LoadTenderResponseStatusType [attribute]

Identifies the status of the entire LoadTender response e-Document (in other words, at the root level).

This item is restricted to the following list.

attribute
LoadTenderResponseStatusType
type loadTenderResponseStatusType

Accepted

The supplied information is accepted.

Amended

The supplied information is changed

Cancelled

The supplied information has been cancelled. Items that have been cancelled are not included in totals on the summary levels of the e-Documents.

Rejected

The supplied information is rejected.

LoadTenderResponseSummary

Summary information that applies to the entire LoadTenderResponse e-Documents.

(sequence)

The sequence of items below is mandatory. A single instance is required.

TotalQuantityInformation

TotalQuantityInformation is optional. Multiple instances might exist.

A group item

containing information about the total quantity and total informational quantity of similar items in the document. TotalQuantityInformation is primarily used in the summary section of e-Documents where it is repeatable to permit totalling for different units of measure.

LineItemSubTotal

LineItemSubTotal is optional. A single instance might exist.

The total amount of all e-Documents LineBaseAmount(s) line items without any monetary adjustments that may occur after the e-Documents line items.

TotalAdjustments

TotalAdjustments is optional. A single instance might exist.

The CurrencyValue of TotalAdjustments contains the total of all MonetaryAdjustmentAmount for all instances of PriceAdjustment and FlatAmountAdjustment in the document (it excludes TaxAdjustments).

TotalTaxAmount

TotalTaxAmount is optional. A single instance might exist.

The CurrencyValue of TotalTaxAmount contains the sum of all instances of TaxAdjustment in the document. TotalTaxAmount contains the sum of all instances of the MonetaryAdjustmentAmount for tax adjustments.

TotalNetAmount

TotalNetAmount is optional. A single instance might exist.

A field containing total amount excluding tax. For example, in the Invoice TotalNetAmount is equal to the sum of LineItemSubTotal plus TotalAdjustments. TotalNetAmount encapsulates CurrencyValue.

TotalAmount

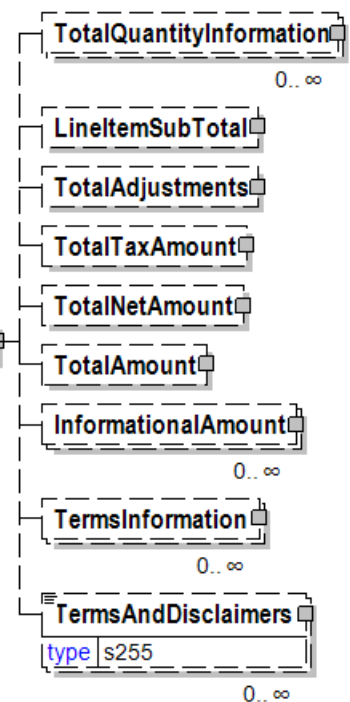

TotalAmount is optional. A single instance might exist.

The total amount including tax.

In e-Documents claiming payment this is the amount due for payment based on the terms of payment. Decimal rounding might be applied to this amount.

InformationalAmount

InformationalAmount is optional. Multiple instances might exist.

A monetary amount used for information purposes only (not for calculation). For example, the invoice price adjustment subtotal is expressed in sterling pounds, and the buyer wants this information expressed in U.S. dollars.

CreditDebitNote and Invoice - The TaxAmount is displayed in the currency that is applicable throughout the e-Document. When a TaxAmount needs to be displayed in a different national currency, this field is used.

TermsInformation

TermsInformation is optional. Multiple instances might exist.

An element that contains the term related information.

TermsAndDisclaimers

TermsAndDisclaimers is optional. Multiple instances might exist.

An element that contains legal information with an indication of what the Language is.

LoadTenderResponseType [attribute]

Code indicating the function of the e-Document.

This item is restricted to the following list.

PreBookingConfirmation

A communication of the requirement for a transport vehicle or unit reservation that has risen from a rough transport plan.

BookingConfirmation

A communication affirming the placement of the booking with a particular party.

LoadTenderResponse

Indicates the ability of the respondent to fulfill the load tender request.



LoadTenderSegment

The details for a particular load segment.

LoadTenderSegmentStatusType [attribute]

LoadTenderSegmentStatusType is mandatory. A single instance is required.

Identifies the status of the LoadTender segment.

Refer to

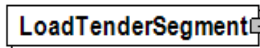

LoadTenderSegmentStatusType definition for any enumerations.

LoadTenderSegmentDocumentStatus [attribute]

LoadTenderSegmentDocumentStatus is optional. A single instance might exist.

Defines the actual document status for the LoadTenderSegment.

Refer to LoadTenderSegmentDocumentStatus definition for any enumerations.

(sequence)

The sequence of items below is mandatory. A single instance is required.

LoadTenderSegmentNumber

LoadTenderSegmentNumber is mandatory. A single instance is required.

The identifier for the LoadTender segment.

ShipFromCharacteristics

ShipFromCharacteristics is optional. A single instance might exist.

A group item that provides information pertaining to the Ship-From Party.

ShipFromCharacteristics may be referenced at both the header and line item level. The reference at the header, if it exists, acts as a default for the value at the line level, unless overridden at the line level.

ShipToCharacteristics

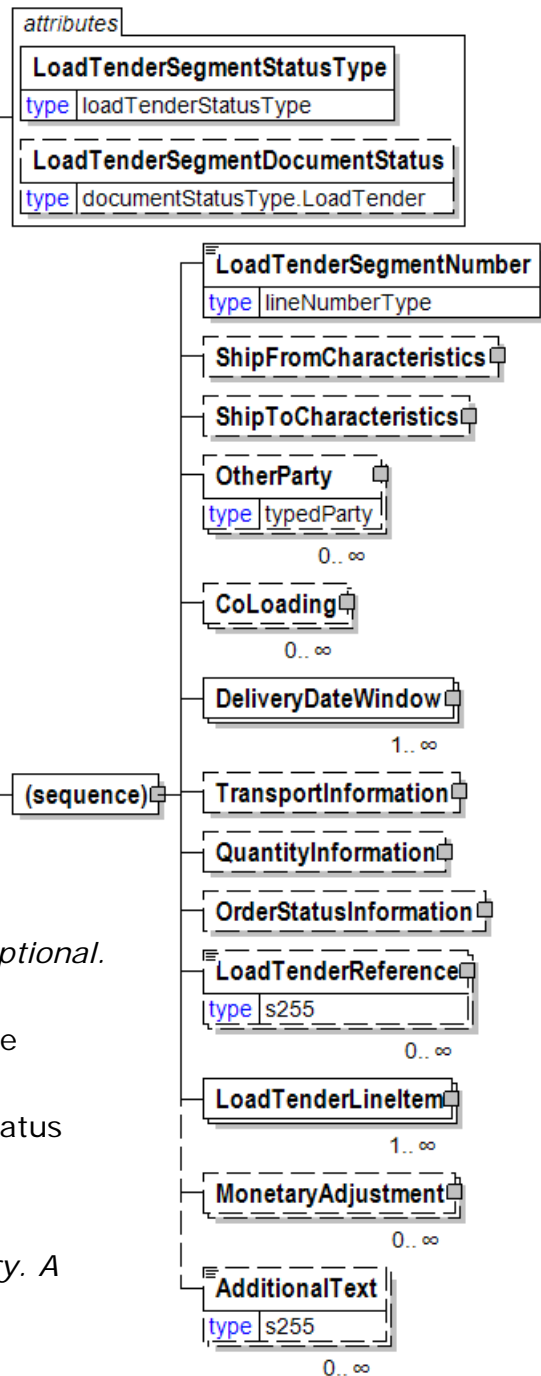

ShipToCharacteristics is optional. A single instance might exist.

A group item that provides information important for the Ship-To Party.

A group item that provides information important for the Ship-To Party. ShipToCharacteristics may be referenced at both the header and line item level. The reference at the header is required and acts as a default for the value at the line level, unless overridden at the line level.

OtherParty

OtherParty is optional. Multiple instances might exist.

An organisation or business entity other than those specifically detailed within a e-Document.

CoLoading

CoLoading is optional. Multiple instances might exist.

A group item specifying information about items to be loaded or loaded on the same transport unit.

Used to identify:

- Delivery together to the drop point
- Transport Orders stuffed together in a container
- Transport Orders not splittable

DeliveryDateWindow

DeliveryDateWindow is mandatory. One instance is required, multiple instances might exist.

A group item defining the date/time interval for delivery to take place. An element which may contain the estimated date for which delivery is expected. This date is not absolute.

TransportInformation

TransportInformation is optional. A single instance might exist.

A grouping element for transport information.

QuantityInformation

QuantityInformation is optional. A single instance might exist.

A group item containing information about quantity and informational quantity of similar items.

OrderStatusInformation

OrderStatusInformation is optional. A single instance might exist.

A group element that stores two levels of order status codes.

LoadTenderReference

LoadTenderReference is optional. Multiple instances might exist.

An item detailing relevant references pertaining to the LoadTender. The type of reference is identified by the LoadTenderReferenceType attribute.

LoadTenderLineItem

LoadTenderLineItem is mandatory. One instance is required, multiple instances might exist.

Group element identifying a line item to be included within this LoadTender Segment.

MonetaryAdjustment

MonetaryAdjustment is optional. Multiple instances might exist.

The element containing the information necessary for the understanding, calculation, and treatment of an adjustment to a currency amount. MonetaryAdjustment contains an attribute that indicates they type of adjustment being communicated.

AdditionalText

AdditionalText is optional. Multiple instances might exist.

A text field that is used to communicate information not previously defined or for special instructions. To be used only for circumstances not covered by specific elements.

LoadTenderSegmentDocumentStatus [attribute]

Defines the actual document status for the LoadTenderSegment.

This item is restricted to the following list.

attribute
LoadTenderSegmentDocumentStatus
type documentStatusType.LoadTender

Cancelled

The supplied information of the document item is cancelled. Items that have been cancelled are not included in totals on the summary level of e-Documents.

Requested

The supplied information of the document item is ordered.

LoadTenderSegmentNumber

The identifier for the LoadTender segment.

LoadTenderSegmentNumber
type lineNumberType

LoadTenderSegmentStatusType [attribute]

Identifies the status of the LoadTender segment.

This item is restricted to the following list.

attribute
LoadTenderSegmentStatusType
type loadTenderStatusType

Amended

The supplied information is changed.

Cancelled

The supplied information has been cancelled. Items that have been cancelled are not included in totals on the summary levels of the e-Document.

Original

The supplied information is the first version of that information.

LoadTenderStatusType [attribute]

Identifies the status of the entire LoadTender e-Document (in other words, at the root level).

This item is restricted to the following list.

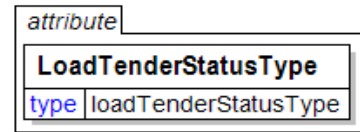

Amended

The supplied information is changed

Cancelled

The supplied information has been cancelled. Items that have been cancelled are not included in totals on the summary levels of the e-Document.

Original

The supplied information is the first version of that information.

LoadTenderSummary

Summary information that applies to the entire LoadTender e-Document.

(sequence)

The sequence of items below is mandatory. A single instance is required.

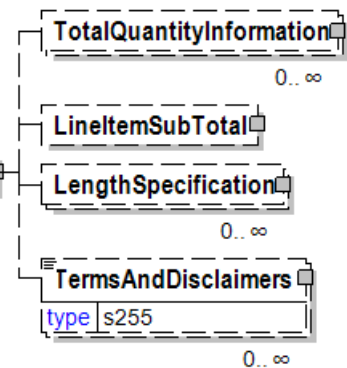
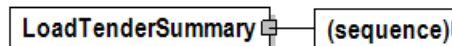

TotalQuantityInformation

TotalQuantityInformation is optional. Multiple instances might exist.

A group item containing information about the total quantity and total informational quantity of similar items in the document. TotalQuantityInformation is primarily used in the summary section of e-Documents where it is repeatable to permit totalling for different units of measure.

LineItemSubTotal

LineItemSubTotal is optional. A single instance might exist.

The total amount of all e-Document LineBaseAmount(s) line items without any monetary adjustments that may occur after the e-Document line items.

LengthSpecification

LengthSpecification is optional. Multiple instances might exist.

Length specification of the wood product.

TermsAndDisclaimers

TermsAndDisclaimers is optional. Multiple instances might exist.

An element that contains legal information with an indication of what the Language is.

LoadTenderType [attribute]

Code indicating the function of the LoadTender e-Document.

This item is restricted to the following list.

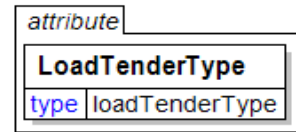

PreBooking

A requirement for a transport vehicle or unit reservation that has risen from a rough transport plan.

Booking

An indication that time for a service is required. For example a booking that is part of a detail transport plan.

LoadTender

More than one carrier has been informed about the upcoming transport requirement (the load).

LocationCode

A code used to identify a specific physical location within a site identified by a party, e.g. a loading station in a warehouse or an unloading station at a printer site. LocationCode will be deprecated in a future version. Use SupplyPoint instead of LocationCode.

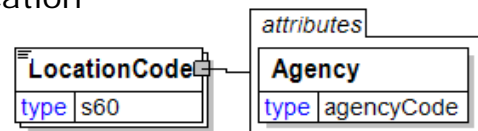

Agency [attribute]

Agency is mandatory. A single instance is required.

Describes the agency maintaining the list of codes. To be included in this list the agency must be a recognized standards body or industry organisation.

For the element that owns this attribute.

For another attribute in the list of attributes associated with the parent element.

Refer to Agency definition for any enumerations.

LocationIdentifier

Options for identifying a physical location.

(choice)

[choice] is optional because of choice construct.

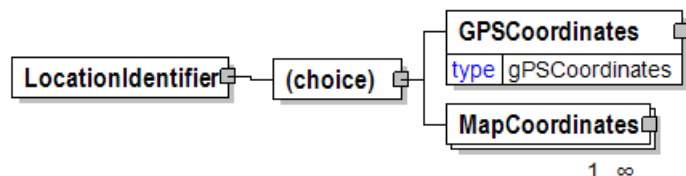

GPSCoordinates

GPSCoordinates is optional because of choice construct.

The location of the party as specified using a Global Positioning System.

MapCoordinates

MapCoordinates is optional because of choice construct.

A group item defining and containing position co-ordinates of a location.

LocationInformation

A grouping element describing the location of the shipment.

(sequence)

The sequence of items below is mandatory. A single instance is required.

(choice)

[choice] is optional because of choice construct.



LocationIdentifier

LocationIdentifier is optional because of choice construct.

Options for identifying a physical location.

LocationParty

LocationParty is optional because of choice construct.

The organization or business entity where the business event took place or will take place.

(choice)

[choice] is optional because of choice construct.

SupplyPoint

SupplyPoint is optional because of choice construct.

Grouping element that contains items describing a supply point. A SupplyPoint belongs to a LocationParty, e.g. in a DeliveryOrigin or DeliveryDestination, and describes where goods are stored and can be loaded or unloaded. A SupplyPoint can for example be a loading or unloading gate at a warehouse or a road side landing at a logging area in the forest.

LocationCode

LocationCode is optional because of choice construct.

A code used to identify a specific physical location within a site identified by a party, e.g. a loading station in a warehouse or an unloading station at a printer site.

LocationCode will be deprecated in a future version. Use SupplyPoint instead of LocationCode.

StopOffInformation

StopOffInformation is optional. A single instance might exist.

Where is the shipment and how far to the next stop.

LocationParty

The organization or business entity where the business event took place or will take place.

LocationType [attribute]

LocationType is optional. A single instance might exist.

Defines type of location when context needs to be specified, e.g. when goods are moved from one location to a new location..

Refer to LocationType definition for any enumerations.

PartyType [attribute]

PartyType is mandatory. A single instance is required.

Identifies the business role associated with the particular party

Refer to PartyType definition for any enumerations.

LogisticsRole [attribute]

LogisticsRole is optional. A single instance might exist.

Communicates the nature of the logistics role, if any, the party plays in the transaction.

Refer to LogisticsRole definition for any enumerations.

(sequence)

The sequence of items below is mandatory. A single instance is required.

PartyIdentifier

PartyIdentifier is optional. Multiple instances might exist.

A unique identifier of a specific party. This element contains an attribute PartyIdentifierType that indicates the type of party.

NameAddress

NameAddress is mandatory. A single instance is required.

A group item containing name and address of an organisation or business entity.

URL

URL is optional. A single instance might exist.

Universal Resource Locator. While typically a web address you could use this field to hold an email address.

CommonContact

CommonContact is optional. Multiple instances might exist.

Identifies a specific individual associated with the party.

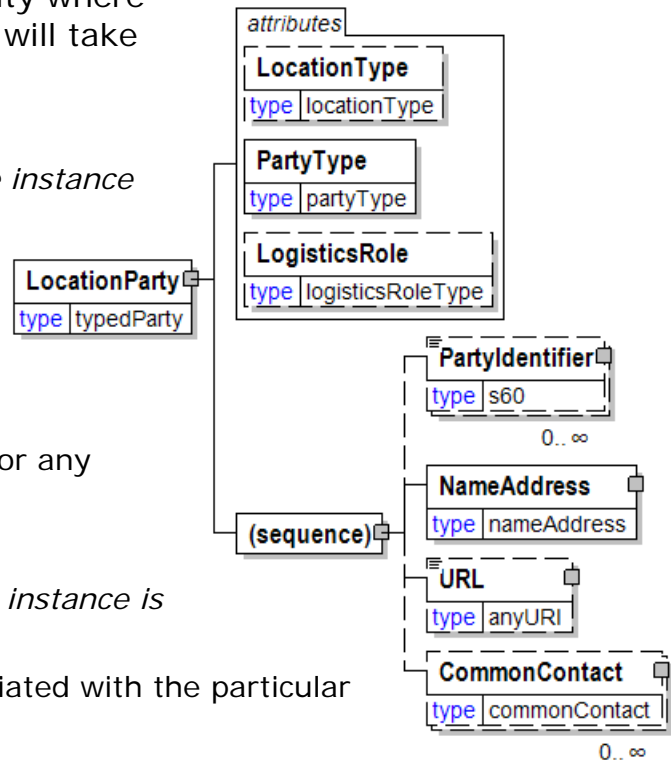

LocationQualifier [attribute]

An attribute of the shipment method of payment describing the location to which the delivery terms refer. This location determines where and when the goods ownership is transferred from the seller to the buyer.

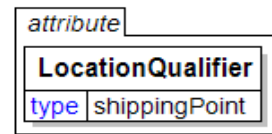

This item is restricted to the following list.

Destination

Ownership is transferred at the final destination.

DistributionCentre

Ownership is transferred at the distribution centre, which is an intermediate warehouse.

Dock

Ownership is transferred at the dock.

Factory

Ownership is transferred where the product is made.

Mill

Ownership is transferred at the manufacturing unit (paper mill).

OnVesselFOBPoint

Ownership is transferred on the vessel.

Origin

Ownership is transferred at the originating shipment location.

OriginAfterLoadingOnEquipment

Ownership is transferred at the time equipment is loaded at the mill/warehouse/terminal.

OriginShippingPoint

Ownership is transferred at the origin shipping point, in other words, at the port of loading.

Plant

Ownership does not transfer until received at the buyer's facility.

Port

Ownership is transferred at the port.

Reload

Ownership is transferred when the product is reloaded for final shipment.

Terminal

Ownership is transferred at the terminal

Warehouse

Ownership changes upon departure of the goods from the warehouse.

LocationType [attribute]

Defines type of location when context needs to be specified, e.g. when goods are moved from one location to a new location.

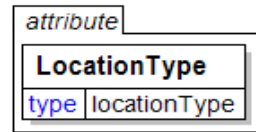

This item is restricted to the following list.

Destination

Defines location as a Destination

Origin

Defines location as an Origin

LocationType [attribute]

Location of Break on the Press. A group item detailing relevant locations on the press to the Performance e-Document.



This item is restricted to the following list.

AirTurn

After Colour Unit – just prior to Dryer

Chills

After Dryer – on chill rolls

Dryer

Within Dryer equipment

Folder

Within Folders ; prior to cut off delivery

Infeed

Prior to Printing Units, after Reel Stand /Splicing Area

PrintingUnit

Within any colour unit

ReelStand

Non Splice phase – prior to Infeed

RibbonDeck

After slitting ; prior to folder

Slitter

As Web is slit to ribbons

Splicer

During the pasting cycle

Log

Log information

(sequence)

The sequence of items below is mandatory. A single instance is required.

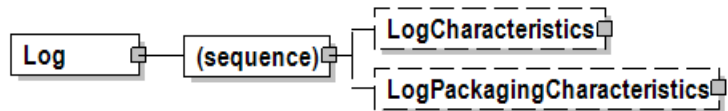

LogCharacteristics

LogCharacteristics is optional. A single instance might exist.

Log characteristics

LogPackagingCharacteristics

LogPackagingCharacteristics is optional. A single instance might exist.

Log packaging characteristics

LogCharacteristics

Log characteristics

LogLengthType [attribute]

LogLengthType is optional. A single instance might exist.

Log length type

Refer to LogLengthType definition for any enumerations.

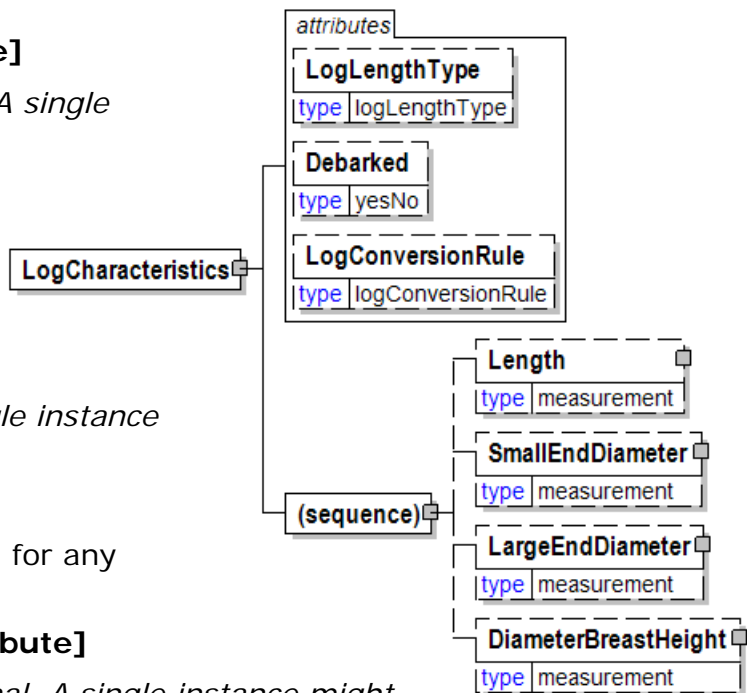

Debarked [attribute]

Debarked is optional. A single instance might exist.

Either "Yes" or "No".

Refer to Debarked definition for any enumerations.

LogConversionRule [attribute]

LogConversionRule is optional. A single instance might exist.

Used to report the standard conversion rule used when converting log size to board-feet or other volume measurement

Refer to LogConversionRule definition for any enumerations.

(sequence)

The sequence of items below is mandatory. A single instance is required.

Length

Length is optional. A single instance might exist.

The length of the object.

SmallEndDiameter

SmallEndDiameter is optional. A single instance might exist.

Reports the log crown end diameter as a measurement.

LargeEndDiameter

LargeEndDiameter is optional. A single instance might exist.

Used to report the log butt end diameter as a measurement.

DiameterBreastHeight

DiameterBreastHeight is optional. A single instance might exist.

Used to report the log diameter 4.5 feet from the butt end as a measurement. Used with the LogConversionRule attribute to determine log's volume conversion to board-feet or other measure.

LogConversionRule [attribute]

Used to report the standard conversion rule used when converting log size to board-feet or other volume measurement



This item is restricted to the following list.

Doyle

The Doyle Log Rule, developed around 1825, is based on a mathematical formula and is widely used throughout the southern United States. This rule allows for a saw kerf of 5/16 inch and a slabbing allowance of 4 inches, which is about twice the normal amount. Because of this, the Doyle Rule is somewhat inconsistent; it underestimates small logs and overestimates large logs. As a seller of timber, you must be aware that for smaller logs the Doyle Rule will underestimate the actual volume of wood that you have in your trees.

International

This rule was developed in 1906 and is based on a reasonably accurate mathematical formula. The rule allows for a 1/4-inch saw kerf and a fixed taper allowance of 1/2 inch per 4 feet of log length. Deductions are also allowed for shrinkage of boards and a slab thickness that varies with the log diameter. Overall, the International 1/4-Inch Log Rule is the most consistent and is often used as a basis of comparison for log rules.

Scribner

The Scribner Log Rule, developed around 1846, is a good example of a diagram rule. It was created by drawing the cross-sections of 1-inch boards within circles representing the end view of logs. A space of 1/4 inch was left between the boards to account for saw kerf. The Scribner Rule does not have an allowance for log taper and typically underestimates logs, particularly if the log length is long.

ScribnerDecimalC

The Scribner Decimal C is a different form of the Scribner Rule; it rounds the volumes to the nearest 10 board feet. For example, 392 board feet on the Scribner is equivalent to 390 board feet on the Scribner Decimal C scale.

LogisticsRole [attribute]

Communicates the nature of the logistics role, if any, the party plays in the transaction.

This item is restricted to the following list.

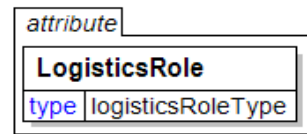

Consignee

The party to whom the goods are turned over to.

Consignor

The party who is responsible for the goods prior to the shipping process.

LogisticsProvider

The party who is responsible for logistics services. This definition of LogisticsProvider allows you to define a party as a buyer of logistics services as well as a supplier of logistics services.

LogLengthType [attribute]

Log length type

This item is restricted to the following list.

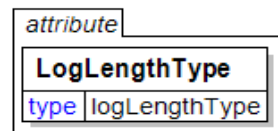

CutToLength

RandomLength

Short

TreeLength

LogPackagingCharacteristics

Log packaging characteristics

DoubleBunked [attribute]

DoubleBunked is optional. A single instance might exist.

Either "Yes" or "No".

Refer to DoubleBunked definition for any enumerations.

(sequence)

The sequence of items below is mandatory. A single instance is required.

Identifier

Identifier is mandatory. One instance is required, multiple instances might exist.

An Identifier is required for packages and items (pallets, reel packages, boxes, ream items, reel items, etc). The Identifier element contains the actual item identifier code. Identifier is repeatable so more than one identifier can be communicated. For example, the printed identifier on a label may be different from

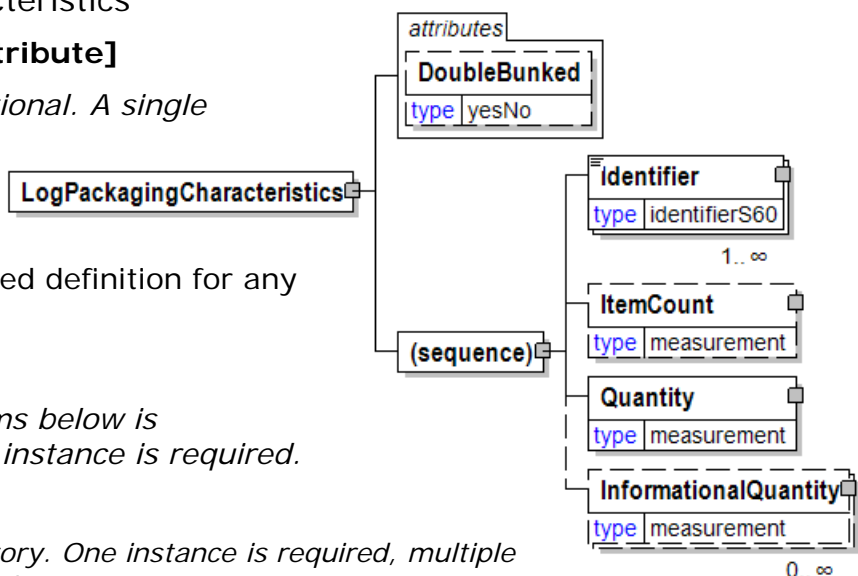

the barcode printed on the label.

ItemCount

ItemCount is optional. A single instance might exist.

A count of the number of items (examples: a count of the number of boxes on a pallet or of reams in a box).

Quantity

Quantity is mandatory. A single instance is required.

The Quantity element contains attributes that provide information about the type of quantity that is being communicated, the context in which the particular quantity is to be viewed, and (if the quantity represents an adjustment) an adjustment type.

The Quantity element contains three child elements that enable you to communicate a range of values for the quantity and a target or actual value. It is at this level (Value, RangeMin, and RangeMax) that the unit of measure is specified. This permits the range to be specified in a different unit of measure than the target.

InformationalQuantity

InformationalQuantity is optional. Multiple instances might exist.

A quantity given in a valid UOM used for information purposes only (not for calculation). For example, an ordered quantity was 100 reels as opposed to the invoice quantity of 20,000 pounds.

Longitude

A measurement of the position of the party or contact in degrees east or west of the prime meridian

Longitude	
type	dec18-8

LumberGrade

Defines quality characteristics achieved by selecting pieces based on a grading rule.

GradeType [attribute]

GradeType is optional. A single instance might exist.

Grade Type

Refer to GradeType definition for any enumerations.

GradingRule [attribute]

GradingRule is optional. A single instance might exist.

Grading rule, the rules under which the product has been graded.

Refer to GradingRule definition for any enumerations.

GradeAgency [attribute]

GradeAgency is optional. A single instance might exist.

LumberAgency identifies which agency is responsible for assigning the lumber attributes.

Refer to GradeAgency definition for any enumerations.

ModulusElasticity [attribute]

ModulusElasticity is optional. A single instance might exist.

Modulus elasticity

Refer to ModulusElasticity definition for any enumerations.

Face [attribute]

Face is optional. A single instance might exist.

Used to describe which side (or face) of the product that the grade is applicable to.

Refer to Face definition for any enumerations.

(sequence)

The sequence of items below is mandatory. A single instance is required.

GradeName

GradeName is optional. A single instance might exist.

A specific product name for which the owner or source is specified in the "@AssignedBy" attribute (for example, ImprovedNewsprint-45-1479)

GradeCode

GradeCode is optional. A single instance might exist.

A specific product code for which the owner or source is specified in the "@AssignedBy" attribute

AdditionalText

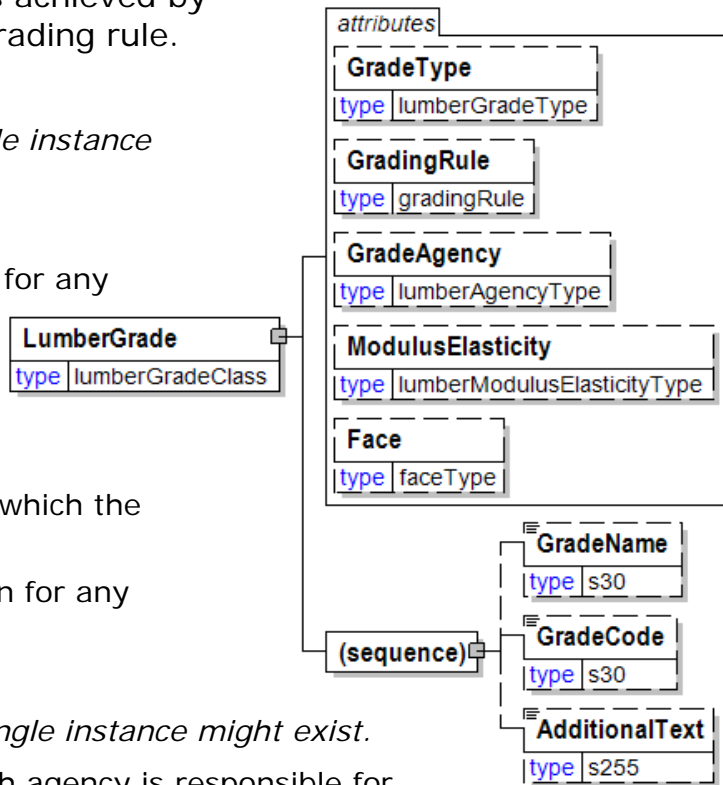

AdditionalText is optional. A single instance might exist.

A text field that is used to communicate information not previously defined or for special instructions. To be used only for circumstances not covered by specific elements.

LumberSpecies

Specifies the raw material species.

SpeciesType [attribute]

SpeciesType is optional. A single instance might exist.

Defines the species or mix of species comprising the product.

Refer to SpeciesType definition for any enumerations.

SpeciesOrigin [attribute]

SpeciesOrigin is optional. A single instance might exist.

The country of origin of the species employed in manufacture of the product.

Refer to SpeciesOrigin definition for any enumerations.

SpeciesAgency [attribute]

SpeciesAgency is optional. A single instance might exist.

Defines the governing organisation of the scheme employed in determining the species of the product.

Refer to SpeciesAgency definition for any enumerations.

(sequence)

The sequence of items below is mandatory. A single instance is required.

SpeciesCode

SpeciesCode is optional. A single instance might exist.

Species Code

AdditionalText

AdditionalText is optional. A single instance might exist.

A text field that is used to communicate information not previously defined or for special instructions. To be used only for circumstances not covered by specific elements.

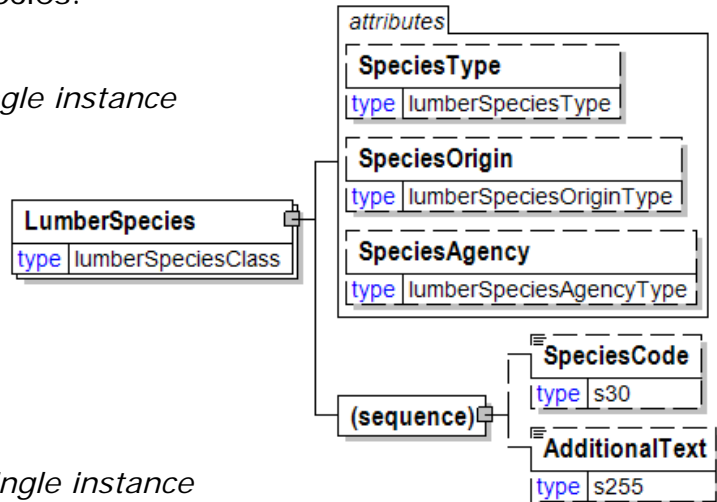

Luminance

Luminance

TestMethod [attribute]

TestMethod is optional. A single instance might exist.

The method used to determine the results of the test under consideration.

TestAgency [attribute]

TestAgency is optional. A single instance might exist.

The agency that has set the parameters for the testing

Refer to TestAgency definition for any enumerations.

SampleType [attribute]

SampleType is optional. A single instance might exist.

Communicates how sampling was done to measure the product characteristics.

Refer to SampleType definition for any enumerations.

ResultSource [attribute]

ResultSource is optional. A single instance might exist.

Used to define the data source of the specified test

Refer to ResultSource definition for any enumerations.

(sequence)

The sequence of items below is mandatory. A single instance is required.

DetailValue

DetailValue is mandatory. A single instance is required.

A numeric value expressed in the unit of measure (UOM).

DetailRangeMin

DetailRangeMin is optional. A single instance might exist.

The minimum value (lower boundary) allowed for the DetailValue that is the parent of this element.

DetailRangeMax

DetailRangeMax is optional. A single instance might exist.

The maximum value (upper boundary) allowed for the DetailValue that is the parent of this element.

StandardDeviation

StandardDeviation is optional. A single instance might exist.

A statistic used as a measure of dispersion in a distribution.

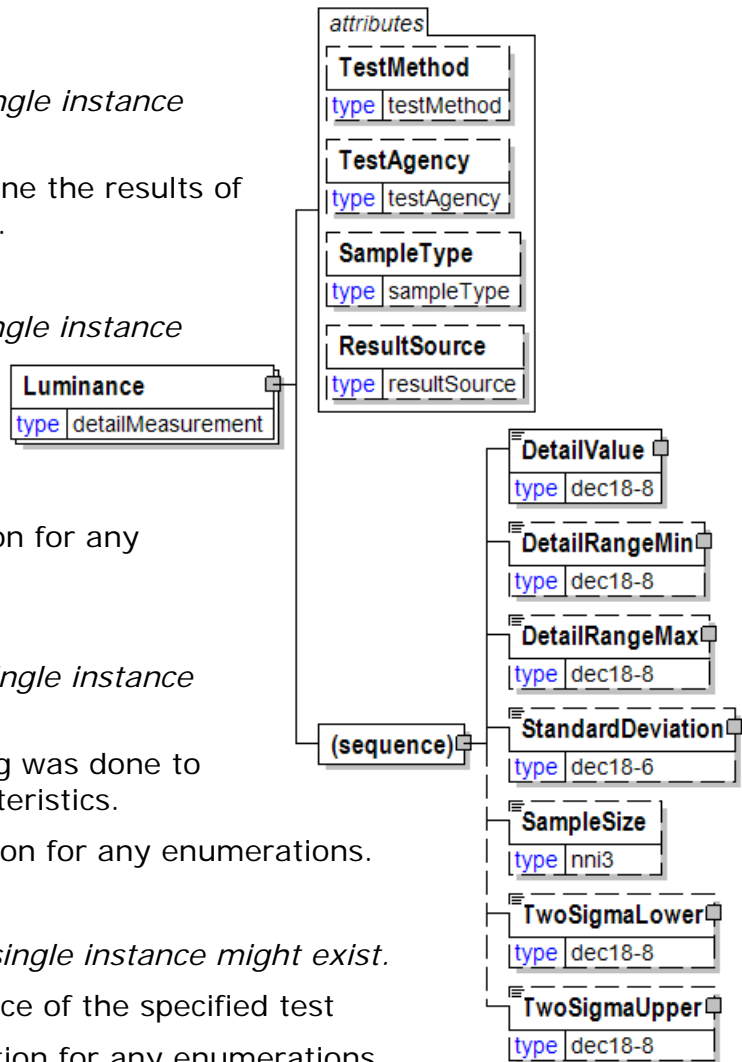

SampleSize

SampleSize is optional. A single instance might exist.

The number of samples used to determine the product characteristic in question.

TwoSigmaLower

TwoSigmaLower is optional. A single instance might exist.

Two sigma (a measure of dispersion associated with standard deviation) on the lower side of the standard deviation.

TwoSigmaUpper

TwoSigmaUpper is optional. A single instance might exist.

Two sigma (a measure of dispersion associated with standard deviation) on the upper side of the standard deviation.

Machine

Machine is used to capture information specific to the particular machine used in the conversion or consumption process.

(sequence)

The sequence of items below is mandatory. A single instance is required.

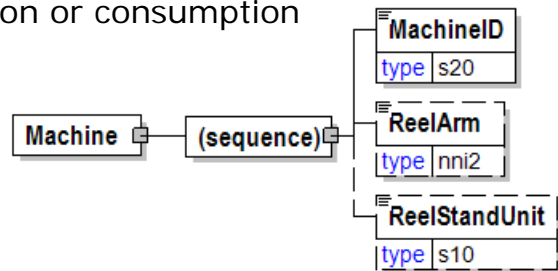

MachineID

MachineID is mandatory. A single instance is required.

An identifier assigned to the particular machine being referenced. For example, a machine could be a paper machine, an off-line coater, a sheeter, or a printing press. The particular machine being referenced will be determined by the business event being supported.

ReelArm

ReelArm is optional. A single instance might exist.

The reel arm number.

ReelStandUnit

ReelStandUnit is optional. A single instance might exist.

The reelstand unit number.

MachineConditions

A grouping element for all the environmental measurement at the time of the run.

(sequence)

The sequence of items below is mandatory. A single instance is required.

Humidity

Humidity is optional. Multiple instances might exist.

Humidity

AmbientTemperature

AmbientTemperature is optional. Multiple instances might exist.

The temperature of the surrounding environment.

MachineSpeed

MachineSpeed is optional. Multiple instances might exist.

The rate at which the machine is, was, or should be running.

Tension

Tension is optional. Multiple instances might exist.

Tension of the web on the printing press.

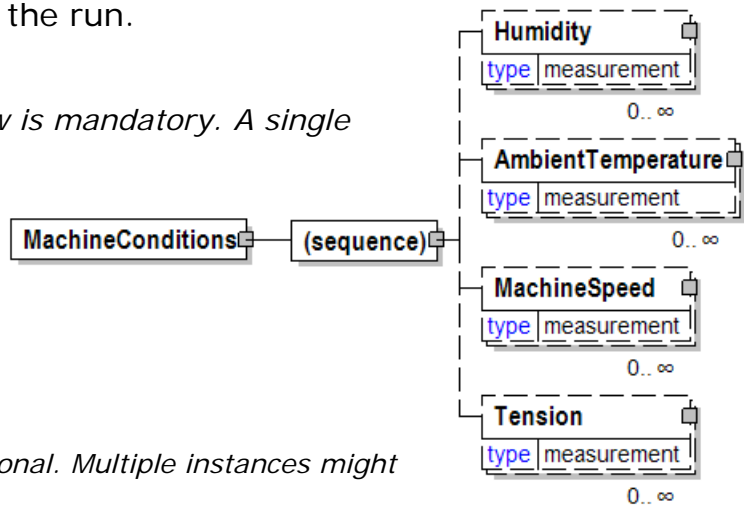

MachineDownTime

The length of loss production time that a machine experienced due to malfunction regardless of cause.

(sequence)

The sequence of items below is mandatory. A single instance is required.

Value

Value is mandatory. A single instance is required.

A numeric value expressed in the unit of measure (UOM).

RangeMin

RangeMin is optional. A single instance might exist.

The minimum value (lower boundary) allowed for the Measurement that is the parent of this element.

RangeMax

RangeMax is optional. A single instance might exist.

The maximum value (upper boundary) allowed for the Measurement that is the parent of this element. Some elements use the RangeMax element with an extended list of unit of measures. (Note: the red colour in the picture is an artifact of how the graphic was captured and should be disregarded.)

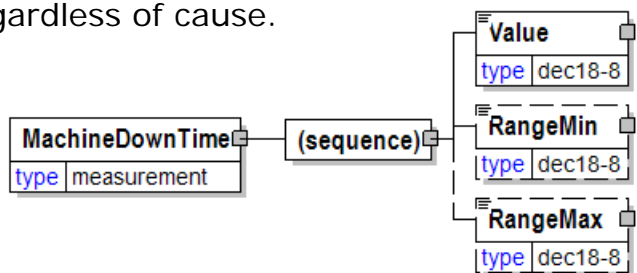

MachineID

An identifier assigned to the particular machine being referenced. For example, a machine could be a paper machine, an off-line coater, a sheeter, or a printing press. The particular machine being referenced will be determined by the business event being supported.

MachineID	
type	s20

MachineLocation

A unique and defined area in the operating machine. On a printing press it would include areas such as: "Splicer", "Infeed", "Print Unit", "folder", "Silcone coater". Also see PressBreakLocation.

MachineLocation	
type	s20

MachineSpeed

The rate at which the machine is, was, or should be running.

SpeedType [attribute]

SpeedType is optional. A single instance might exist.

Speed Type

Refer to SpeedType definition for any enumerations.

(sequence)

The sequence of items below is mandatory. A single instance is required.

Value

Value is mandatory. A single instance is required.

A numeric value expressed in the unit of measure (UOM).

RangeMin

RangeMin is optional. A single instance might exist.

The minimum value (lower boundary) allowed for the Measurement that is the parent of this element.

RangeMax

RangeMax is optional. A single instance might exist.

The maximum value (upper boundary) allowed for the Measurement that is the parent of this element. Some elements use the RangeMax element with an extended list of unit of measures. (Note: the red colour in the picture is an artifact of how the graphic was captured and should be disregarded.)

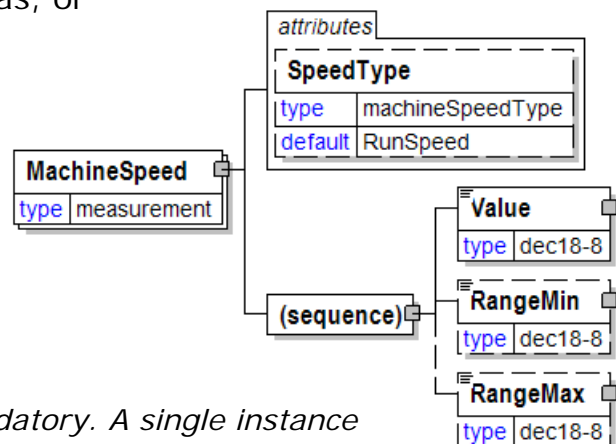

MachineStoppage [attribute]

An indicator on whether the production had to be periodically stopped.

This item is restricted to the following list.

Yes

No

attribute	
MachineStoppage	
type	yesNo
default	No

Magenta

The Magenta component of a colour.

Magenta is a locally defined element used in the CMYK element.

(sequence)

The sequence of items below is mandatory. A single instance is required.

DetailValue

DetailValue is mandatory. A single instance is required.

A numeric value expressed in the unit of measure (UOM).

DetailRangeMin

DetailRangeMin is optional. A single instance might exist.

The minimum value (lower boundary) allowed for the DetailValue that is the parent of this element.

DetailRangeMax

DetailRangeMax is optional. A single instance might exist.

The maximum value (upper boundary) allowed for the DetailValue that is the parent of this element.

StandardDeviation

StandardDeviation is optional. A single instance might exist.

A statistic used as a measure of dispersion in a distribution.

SampleSize

SampleSize is optional. A single instance might exist.

The number of samples used to determine the product characteristic in question.

TwoSigmaLower

TwoSigmaLower is optional. A single instance might exist.

Two sigma (a measure of dispersion associated with standard deviation) on the lower side of the standard deviation.

TwoSigmaUpper

TwoSigmaUpper is optional. A single instance might exist.

Two sigma (a measure of dispersion associated with standard deviation) on the

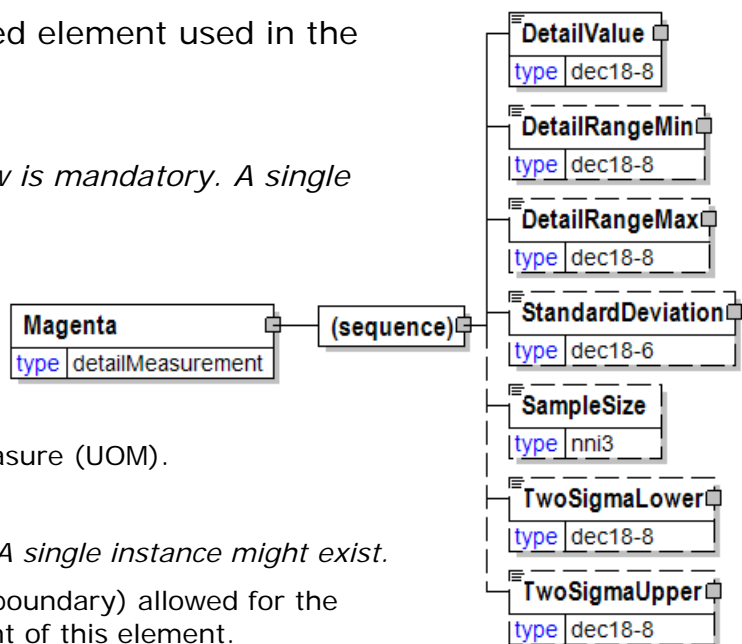

upper side of the standard deviation.

MailAttachment

MailAttachment enables the complainer to indicate that they are providing by mail (express courier, snail mail etc.) proof of the Complaint.

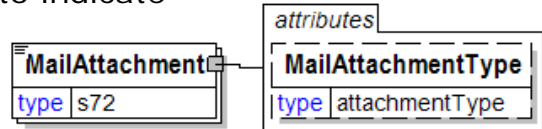

MailAttachmentType [attribute]

MailAttachmentType is optional. A single instance might exist.

The type of mail attachment.

Refer to MailAttachmentType definition for any enumerations.

MailAttachmentType [attribute]

The type of mail attachment.

This item is restricted to the following list.

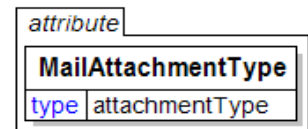

BillOfLading

The mail attachment is a bill of lading.

CMR

Collection maintenance repair, a standard book repair method

Photo

The mail attachment is a photo.

Sample

The mail attachment is a sample.

Waybill

The forwarding agreement or carrying agreement that is used as a receipt for cargo and as a contract of carriage.

MakeTo

Indicates upon which constraint production should be based on (length or diameter). Specifies the basis of the finished diameter of a reel, either a Diameter specification or a Length of paper specification

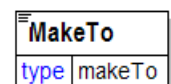

This item is restricted to the following list.

Length

Diameter

ManufacturingProcess

Defines the different machining and processes made for the product.

ManufacturingProcessType [attribute]

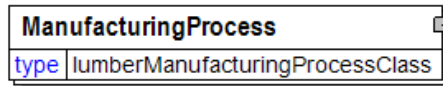

ManufacturingProcessType is optional. A single instance might exist.

Describes the exact nature of any further mechanical processing applied to the product.

Refer to ManufacturingProcessType definition for any enumerations.

ManufacturingProcessAgency [attribute]

ManufacturingProcessAgency is optional. A single instance might exist.

Manufacturing process agency

Refer to ManufacturingProcessAgency definition for any enumerations.

(sequence)

The sequence of items below is mandatory. A single instance is required.

Value

Value is optional. A single instance might exist.

A numeric value expressed in the unit of measure (UOM).

AdditionalText

AdditionalText is optional. A single instance might exist.

A text field that is used to communicate information not previously defined or for special instructions. To be used only for circumstances not covered by specific elements.

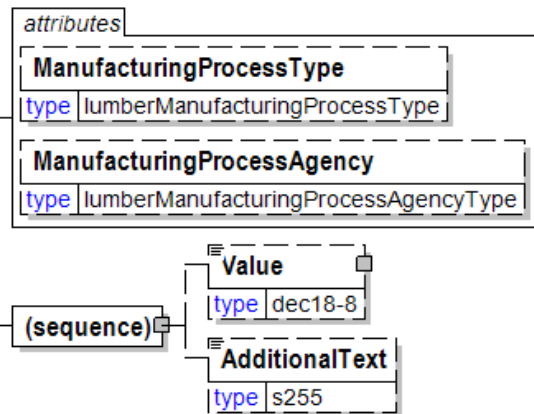

ManufacturingProcessAgency [attribute]

Manufacturing process agency

This item is restricted to the following list.

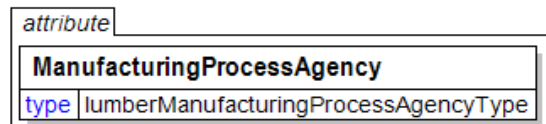

ISO

International Organization for Standardization

prEN TC(1113-1)

Supplier

Product supplier is the agency for the coding structure.

ManufacturingProcessType [attribute]

Describes the exact nature of any further mechanical processing applied to the product.

attribute
ManufacturingProcessType
type lumberManufacturingProcessType

This item is restricted to the following list.

Chamfered

The edge is beveled.

Combed

Compressed

Cut

DrySplitted

EndMatched

Finesawn

FJ-Lam

FJ-Lam components are knotless, finger-jointed and laminated blanks up to 6 meters

FJ-Blank

FurtherProcess

FingerJointed

GlueLamBeam

GreenSplitted

H and M

H or M

HeatTreated

Impregnated

ImpregnatedA

ImpregnatedWolmanitAB

KD56/30

Phyto sanitary treatment. Kiln Dried up to a temperature in the core of the piece of at least 56 C for at least 30 minutes.

Lacquered

Lamwood

A piece of wood built up of plies or laminations that have been joined either with glue or with mechanical fastenings: the term is most frequently applied where the plies are too thick to be classified as veneer and when the grain of all plies is parallel.

MachineStrengthGraded

NorthFloor

Notched

OilTreated

Opti-Blank

Painted

Planed

Pro-Lam

Resawn

Rough

Uneven texture, not smooth as passed through a saw.

Rougher Headed

RoughSawn

S1E

Surfaced one edge

S1S

Surfaced one side

S1S EdgeRgh

Surfaced one side, edge rough

S1S1E

Surfaced one side, one edge

S1S2E

Surfaced one side, two edges

S2E

Surfaced two edges

S2S

Surfaced two sides

S2S EdgeRgh

Surfaced two sides, edge rough

S2S1E

Surfaced two sides, one edge

S4S

Surfaced four sides

S4SEE

Surfaced four sides, eased edges

Sawn

SawTexture

Smooth

Split

StrengthGraded

Treated
 Vstol
 Other

ManufacturingSpecifications

Manufacturing specifications.

PressType [attribute]

PressType is optional. A single instance might exist.

The type of press used.

Refer to PressType definition for any enumerations.

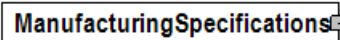

PressImpositionType [attribute]

PressImpositionType is optional. A single instance might exist.

The type of press imposition

Refer to PressImpositionType definition for any enumerations.

(sequence)

The sequence of items below is mandatory. A single instance is required.

Margins

Margins is optional. A single instance might exist.

Margins.

InkCharacteristics

InkCharacteristics is optional. A single instance might exist.

The ink characteristics.

Note: The child element, InkCoverage, will be deprecated from InkCharacteristics in an upcoming version. Use the instance of InkCoverage found in ColourSpecs.

FinishSpecs

FinishSpecs is optional. A single instance might exist.

Finish specifications

FinishPrep

FinishPrep is optional. A single instance might exist.

Finish prep

PrintedMediaSpecs

PrintedMediaSpecs is optional. A single instance might exist.

Printed media specifications

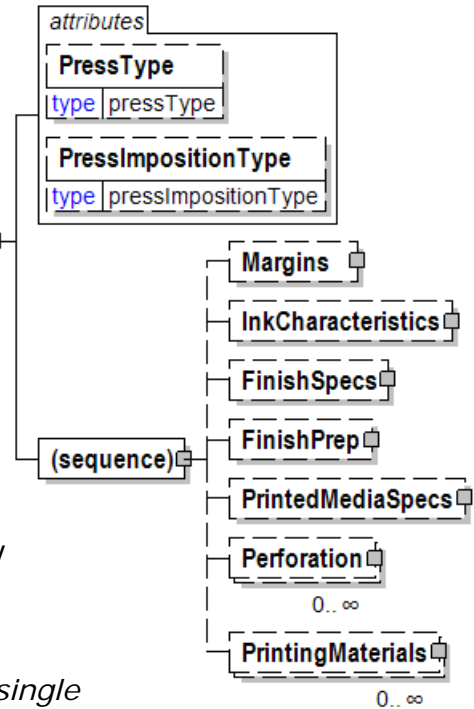

Perforation

Perforation is optional. Multiple instances might exist.

Perforation information

PrintingMaterials

PrintingMaterials is optional. Multiple instances might exist.

Printing materials information.

MapCoordinates

A group item defining and containing position co-ordinates of a location.

MapReferenceSystem [attribute]

MapReferenceSystem is mandatory. A single instance is required.

MapReferenceSystem defines the map projection and the origin of the co-ordinate system used for production of the map. Also referred to as Map Datum.

Refer to MapReferenceSystem definition for any enumerations.

MapCoordinateType [attribute]

MapCoordinateType is mandatory. A single instance is required.

MapCoordinateType defines the co-ordinate system.

Refer to MapCoordinateType definition for any enumerations.

(sequence)

The sequence of items below is mandatory. A single instance is required.

Coordinates

Coordinates is mandatory. A single instance is required.

Contains the position co-ordinates of a location.

Altitude

Altitude is optional. A single instance might exist.

The height of a location above a ground reference point as specified by the map reference system.

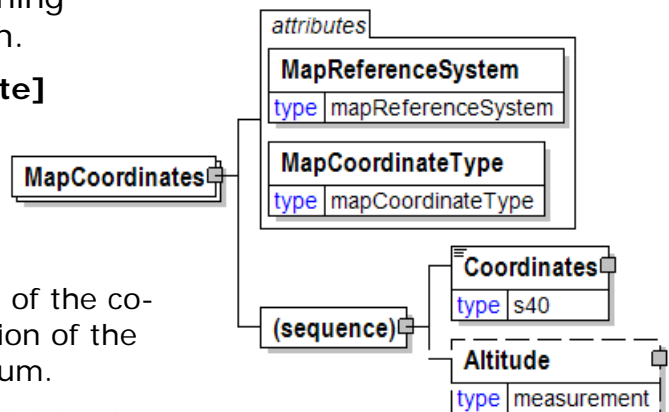

MapCoordinateType [attribute]

MapCoordinateType defines the co-ordinate system.

This item is restricted to the following list.

ETRS-TM35FIN

ETRS-TM35FIN is a co-ordinate system used in Finland.

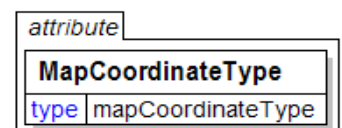

KKJ1

KKJ zone 1 is a map coordinate system used in western part of Finland with rectangular grid-coordinates (northing, easting).

KKJ2

KKJ zone 2 is a map coordinate system used in western part of Finland with rectangular grid-coordinates (northing, easting).

KKJ3

KKJ zone 3 is a map coordinate system used in middle part of Finland with rectangular grid-coordinates (northing, easting).

KKJ4

KKJ zone 4 is a map coordinate system used in eastern part of Finland with rectangular grid-coordinates (northing, easting).

Lambert93

Lambert 93 is the official map projection of Metropolitan France since December 26, 2000 (<http://www.ign.fr/telechargement/P.I/Objectifs/Statuts/texte-26.12.2000.pdf>)

More info at:

http://www.ign.fr/telechargement/MPro/geodesie/CIRCE/NTG_87.pdf

Lambert1

Lambert Zone 1 is a co-ordinate system used for the northern part of France.

More info at:

<http://www.ign.fr/telechargement/education/fiches/geodesie/projections.pdf>

http://www.ign.fr/telechargement/education/fiches/geodesie/projections_EN.pdf

Lambert2

Lambert Zone 2 is a co-ordinate system used for the centre part of France.

More info at:

<http://www.ign.fr/telechargement/education/fiches/geodesie/projections.pdf>

http://www.ign.fr/telechargement/education/fiches/geodesie/projections_EN.pdf

Lambert3

Lambert Zone 3 is a co-ordinate system used for the southern part of France.

More info at:

<http://www.ign.fr/telechargement/education/fiches/geodesie/projections.pdf>

http://www.ign.fr/telechargement/education/fiches/geodesie/projections_EN.pdf

Lambert4

Lambert Zone 4 is a co-ordinate system used for Corsica.

More info at:

<http://www.ign.fr/telechargement/education/fiches/geodesie/projections.pdf>

http://www.ign.fr/telechargement/education/fiches/geodesie/projections_EN.pdf

Lambert2Etendu

papiNet V2R31

Lambert 2 Etendu is a co-ordinate system used for all of France. It is an extension of Lambert Zone 2 for metropolitan France.

More info at:

<http://www.ign.fr/telechargement/education/fiches/geodesie/projections.pdf>

http://www.ign.fr/telechargement/education/fiches/geodesie/projections_EN.pdf

LatLong

Co-ordinates specified as Latitude and Longitude.

RT90_2.5GonV

RT90 2.5 gon V 0: -15 is a co-ordinate system used in Sweden.

More info at <http://www.lantmateriet.se>

SWEREF99TM

SWEREF99 TM is a co-ordinate system used in Sweden.

More info at <http://www.lantmateriet.se>

UTM

The Universal Transverse Mercator (UTM) coordinate system is a grid-based method of specifying locations on the surface of the Earth. The system employs a series of sixty zones, each of which is based on a specifically defined secant Transverse Mercator projection.

MapPoint

A grouping element for items describing a point on a map. A map point is normally named waypoint in a GPS.

MapPointType [attribute]

MapPointType is optional. A single instance might exist.

Type of object specified by a map point.

Refer to MapPointType definition for any enumerations.

MapPointDisplayType [attribute]

MapPointDisplayType is optional. A single instance might exist.

Defines how map points are processed and displayed on maps by map applications.

Refer to MapPointDisplayType definition for any enumerations.

(sequence)

The sequence of items below is mandatory. A single instance is required.

MapPointName

MapPointName is mandatory. A single instance is required.

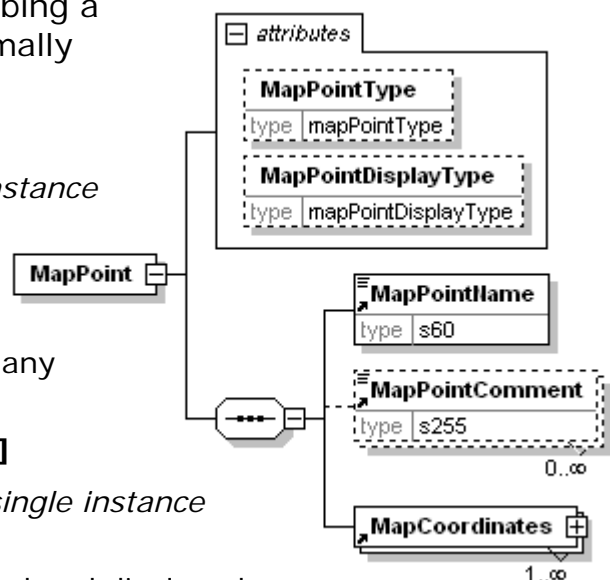

A unique name for a point on a map. It is also normally the name of the corresponding waypoint in a GPS.

MapPointComment

MapPointComment is optional. Multiple instances might exist.

A descriptive text for a point on a map. It is also normally shown in a GPS as a comment for the corresponding waypoint.

MapCoordinates

MapCoordinates is mandatory. One instance is required, multiple instances might exist.

A group item defining and containing position co-ordinates of a location.

MapPointComment

A descriptive text for a point on a map. It is also normally shown in a GPS as a comment for the corresponding waypoint.

MapPointComment	
type	s255

MapPointDisplayType [attribute]

Defines how map points are processed and displayed on maps by map applications.

This item is restricted to the following list.

LinePoint

A map point that is connected with a line to the next consecutive map point having the same MapPointDisplayType "LinePoint".

UserWaypoint

A map point that is displayed as a normal waypoint visible for the user.

MapPointDisplayType	
type	mapPointDisplayType

MapPointName

A unique name for a point on a map. It is also normally the name of the corresponding waypoint in a GPS.

MapPointName	
type	s60

MapPointType [attribute]

Type of object specified by a map point.

This item is restricted to the following list.

ApproachingWay

A map point showing the way how to approach the destination, e.g. a supply point. The advised way starts from the first given map point continuing to the next ones. Extra information about the way can be given in MapPointComment.

MapPointType	
attribute	
type	mapPointType

Barrier

An object serving to obstruct passage or to maintain separation, e.g. a gate.

BearingCapacityRestriction

A map point showing where bearing capacity restriction exists on the road.

Bridge

A bridge, e.g. for crossing over a river. A bridge might be restricted by width and bearing capacity.

CraneTemporaryStorage

A place where a crane used for loading and unloading can temporarily be put.

DrivingProhibited

A map point specifying that driving is prohibited on this leg of the road.

Ferry

A ferry crossing with restrictions along a road. Typically restricted by width and bearing capacity.

ForestRoad

Usually a light constructed road used mainly for forestry operations and wood transportations.

HazardPlace

A map point which needs to be noticed in order to drive or work safely, e.g. a point on a road or at a roadside landing.

MainIntersection

Connection point between a main road and minor roads.

Passage

A section or crossing with restrictions along a road. Typically restricted by width.

PassingPossibility

Place where vehicles can turn around.

PointOfNatureValues

A map point of special nature values which have to be taken into account in the operations.

PointOfRemark

A map point with special information which has to be taken into account in the operations.

PowerLine

A power line which can cause a danger to drivers and has to be taken into account in the operations.

RoadWorks

Repairs to a road forming a hazard or obstruction to traffic.

RouteLegEnd

End point of a route leg.

RouteLegStart

Start point of a route leg.

RouteEnd

End point of a route.

RouteStart

Start point of a route.

Slope

A section of a road with a gradient forming obstruction to traffic.

SupplyPoint

A map point showing a supply point, e.g. a roadside landing.

TelephoneCable

A telephone or a data communication cable which has to be taken into account in the operations.

TemporaryRoad

Usually a light constructed and temporary road used for wood transportations and loggings, e.g. a winter road.

TrafficRestriction

A map point with special restriction to the traffic. Detailed information of the restriction can be given in MapPointComment.

TrafficWarning

A map point with special warning or notice concerning the traffic on the road. Detailed information of the warning can be given in MapPointComment.

TurningPossibility

A place where vehicles can turn around.

UnderPass

A section of a road that passes under another road, railway line, etc. Typically restricted by height and width.

WeighBridge

Place for weighing of vehicles.

MapReferenceSystem [attribute]

MapReferenceSystem defines the map projection and the origin of the co-ordinate system used for production of the map. Also referred to as Map Datum.

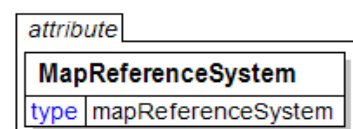

This item is restricted to the following list.

ETRS89

The European Terrestrial Reference System 1989 is a three-dimensional

geodetic frame of reference - a mapping coordinate system used as the standard high accuracy system for GPS in Europe. ETRS89 is the EU-recommended frame of reference for geodata for Europe.

More info at <http://lareg.ensg.ign.fr/EUREF>

EUREF-FIN

A map reference system used in Finland

KKJ

A map reference system used in Finland. This older system will be replaced by ETRS89 (EUREF-FIN) on new maps.

NTF

NTF is a Map reference System used in France. Although the official MapReference System in France is RGF93, NTF is still the most used reference system in year 2007.

Code EPSG used by Open Geospatial Consortium: 4807 More info at:

<http://www.ign.fr/telechargement/education/fiches/geodesie/syst%C3%A8mes.pdf>

http://www.ign.fr/telechargement/education/fiches/geodesie/systemes_EN.pdf

http://www.ign.fr/telechargement/education/fiches/geodesie/coordonnees_EN.pdf

RGF93

RGF93 is the official geodetic frame of reference for France (<http://www.ign.fr/telechargement/P.I/Objectifs/Statuts/texte-26.12.2000.pdf>). It is a subset of ETRS89.

Code EPSG used by Open Geospatial Consortium for RGF93: 4965 (3D), 4171 (2D).

We can consider that the latitude and the longitude defined with the MapReferenceSystem RGF93 are equivalent to the latitude and the longitude defined with WGS84 (1 to 2 centimetres of gap).

RT90

A map reference system used in Sweden.

More info at <http://www.lantmateriet.se>

SWEREF99

A map reference system used in Sweden. The older reference system RT90 will be replaced by SWEREF99 on new maps.

More info at <http://www.lantmateriet.se>

WGS84

The World Geodetic System defines a global reference system for the earth. WGS84 is the revision from year 1984. It is the reference system used by the Global Positioning System (GPS). WGS 84 is the most common reference system used for web based maps, e.g. Googlemaps and Google Earth.

Margins

Margins.

(sequence)

The sequence of items below is mandatory. A single instance is required.

Head

Head is optional. A single instance might exist.

Head.

Thumb

Thumb is optional. A single instance might exist.

Thumb.

Gutter

Gutter is optional. A single instance might exist.

Gutter

Foot

Foot is optional. A single instance might exist.

Foot

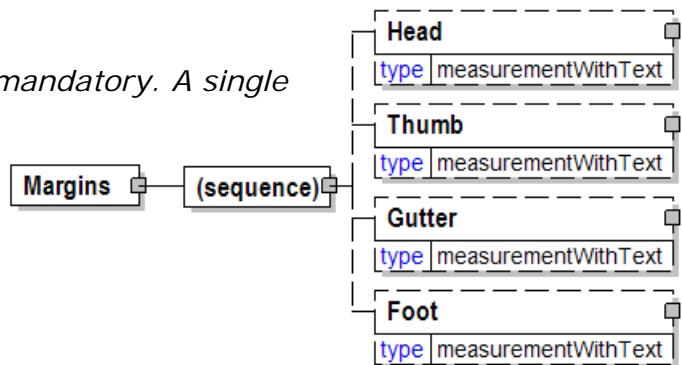

MasterReelWidth

The master reel width.

(sequence)

The sequence of items below is mandatory. A single instance is required.

Value

Value is mandatory. A single instance is required.

A numeric value expressed in the unit of measure (UOM).

RangeMin

RangeMin is optional. A single instance might exist.

The minimum value (lower boundary) allowed for the Measurement that is the parent of this element.

RangeMax

RangeMax is optional. A single instance might exist.

The maximum value (upper boundary) allowed for the Measurement that is the parent of this element. Some elements use the RangeMax element with an extended list of unit of measures. (Note: the red colour in the picture is an artifact of how the graphic was captured and should be disregarded.)

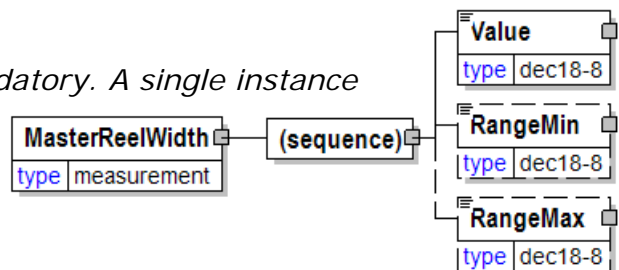

MasterSource [attribute]

The source of the master

This item is restricted to the following list.

1610/1630

1/4Inch2TrackR2RTape

CDR

The source is Compact Disc Recordable.

DAT

The source is Digital Audio Tape.

DATWithLog

Diskette

DVD

The source is Digital Video Disk.

Electronic

Exabyte

A company (and, by extension, a tape format) for computer data backup and transfer onto data quality 8-mm VCR tape. Exabyte units can store 5 Gbytes of data per tape.

Jazz

The Jazz drive is a removable storage solution developed by Iomega Corp. The Jaz drive has a 12-ms average seek time and the removable cartridges hold up to 2 GB of data.

MagneticOptical

Syquest

A removable hard disk drive that is connected to the computer via a SCSI interface.

Zip

A high-capacity floppy disk drive.

Other

attribute
MasterSource
type masterSource

MasterStorageOption

Master storage option

MasterStorageOption
type s72

MaterialCharacteristics

Material characteristics.

FinishType [attribute]

FinishType is optional. A single instance might exist.

Defines the finish of a sheet of paper, which means the condition of its surface (refer to Embossing for more information).

Finishes may be produced on or off machine. Finishes that are created off-machine are called embossed. (Embossing is a child element of ReelConversionCharacteristics and

SheetConversionCharacteristics.)

Note:

Embossed" as a finish type is just a generalized choice for one of the more specific choices listed.

Unsupercalendered" as a finish type would be indicated by not communicating a finish type.

Refer to FinishType definition for any enumerations.

(sequence)

The sequence of items below is mandatory. A single instance is required.

(sequence)

The sequence of items below is mandatory. One instance is required, multiple instances might exist.

ProductIdentifier

ProductIdentifier is mandatory. A single instance is required.

Used to communicate the code of the article, in a variety of formats designated by the type.

ProductDescription

ProductDescription is optional. Multiple instances might exist.

An element used to communicate a human readable description of the product in the language specified by the Language attribute.

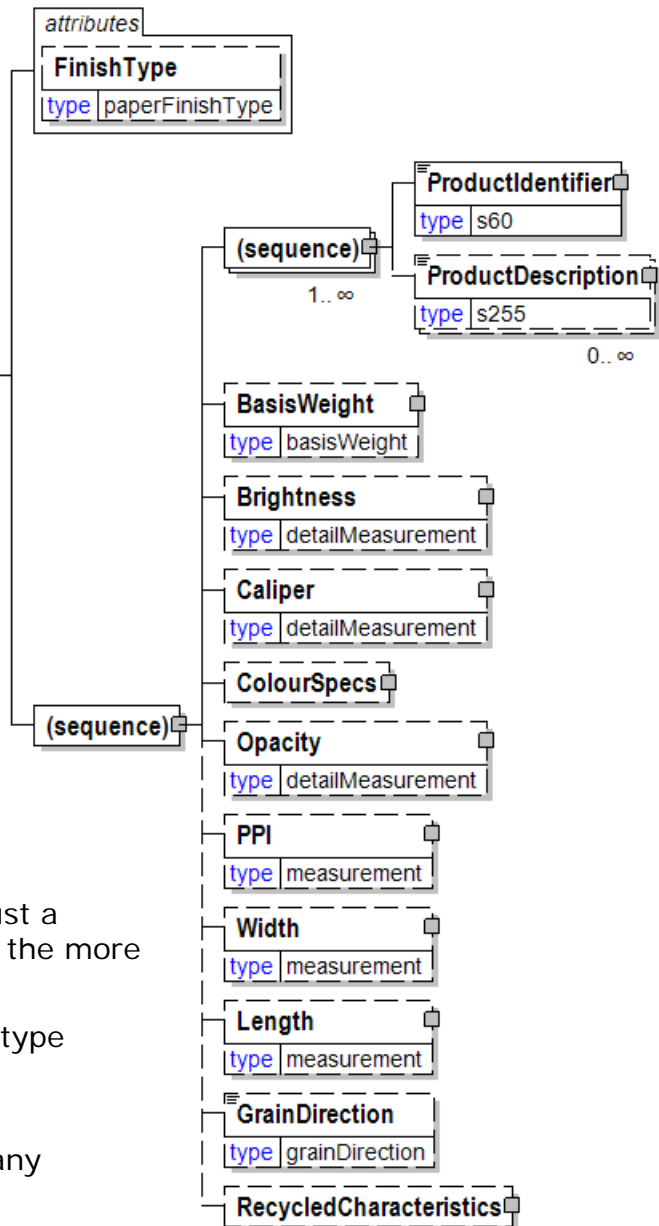

BasisWeight

BasisWeight is optional. A single instance might exist.

The weight of the paper expressed as a mass for a given surface area. In countries using the metric system, the basis weight is expressed as the weight in grams of one sheet of paper that is one square meter in area—not dependent on basic sheet size. In countries using the imperial system, the weight is expressed in pounds for a given ProductBasisSizeType.

Brightness

Brightness is optional. A single instance might exist.

A measurement of the degree of light reflectivity of the product.

Caliper

Caliper is optional. A single instance might exist.

The thickness of a sheet of paper under standard test conditions.

ColourSpecs

ColourSpecs is optional. A single instance might exist.

Colour specs

Opacity

Opacity is optional. A single instance might exist.

A group item used to communicate opacity target or test value according to a particular TestMethod.

PPI

PPI is optional. A single instance might exist.

A group item used to communicate the number of pages in an inch of thickness either as a target or actual value. Equal to the number of sheets per inch times 2.

Width

Width is optional. A single instance might exist.

The width of the object.

Length

Length is optional. A single instance might exist.

The length of the object.

GrainDirection

GrainDirection is optional. A single instance might exist.

Defines the primary orientation/alignment (Long or Short) of the cellulose fibres in a sheet or web of paper, which results from the flow of fibres in a water suspension during the papermaking process.

Refer to GrainDirection definition for any enumerations.

RecycledCharacteristics

RecycledCharacteristics is optional. A single instance might exist.

RecycledCharacteristics groups together the concepts associated with recycled material.

MaxCurrencyValue

The upper range of the allowed currency amount..

CurrencyType [attribute]

CurrencyType is optional. A single instance might exist.

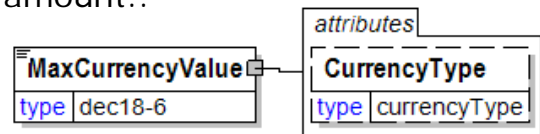

A three-character ISO 4217 currency code in capital letters. The ISO standard classification for currencies.

Refer to CurrencyType definition for any enumerations.

MaximumClampingForce

Specifies maximum clamp force allowed during handling of an item.

(sequence)

The sequence of items below is mandatory. A single instance is required.

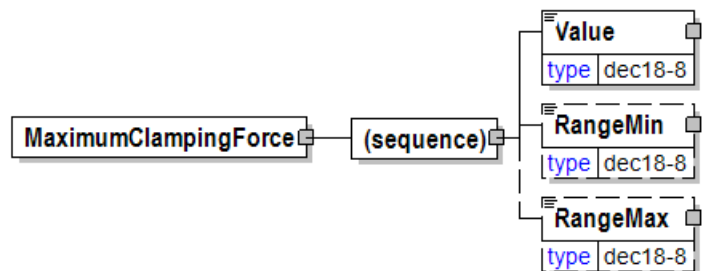

Value

Value is mandatory. A single instance is required.

A numeric value expressed in the unit of measure (UOM).

RangeMin

RangeMin is optional. A single instance might exist.

The minimum value (lower boundary) allowed for the Measurement that is the parent of this element.

RangeMax

RangeMax is optional. A single instance might exist.

The maximum value (upper boundary) allowed for the Measurement that is the parent of this element. Some elements use the RangeMax element with an extended list of unit of measures. (Note: the red colour in the picture is an artifact of how the graphic was captured and should be disregarded.)

MaximumGrossWeight

The maximum weight allowed including the pallet.

(sequence)

The sequence of items below is mandatory. A single instance is required.

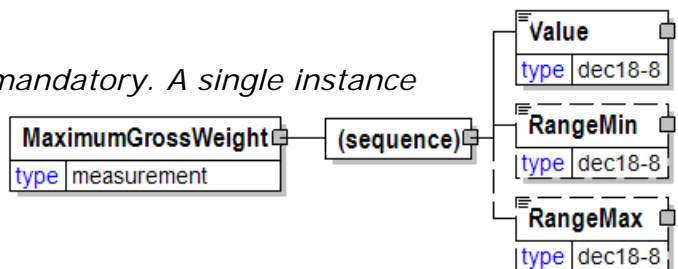

Value

Value is mandatory. A single instance is required.

A numeric value expressed in the unit of measure (UOM).

RangeMin

RangeMin is optional. A single instance might exist.

papiNet V2R31

The minimum value (lower boundary) allowed for the Measurement that is the parent of this element.

RangeMax

RangeMax is optional. A single instance might exist.

The maximum value (upper boundary) allowed for the Measurement that is the parent of this element. Some elements use the RangeMax element with an extended list of unit of measures. (Note: the red colour in the picture is an artifact of how the graphic was captured and should be disregarded.)

MaximumHeight

The maximum height allowed including the pallet.

(sequence)

The sequence of items below is mandatory. A single instance is required.

Value

Value is mandatory. A single instance is required.

A numeric value expressed in the unit of measure (UOM).

RangeMin

RangeMin is optional. A single instance might exist.

The minimum value (lower boundary) allowed for the Measurement that is the parent of this element.

RangeMax

RangeMax is optional. A single instance might exist.

The maximum value (upper boundary) allowed for the Measurement that is the parent of this element. Some elements use the RangeMax element with an extended list of unit of measures. (Note: the red colour in the picture is an artifact of how the graphic was captured and should be disregarded.)

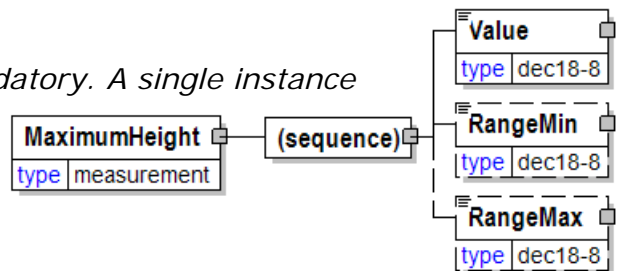

MaximumNumberOfJoins

The maximum number of joins requested (permitted). Permits customers to indicate join-free reels.

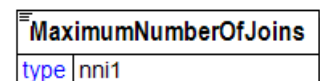

MaximumOffcut

Maximum off cut.

(sequence)

The sequence of items below is mandatory. A single instance is required.

Value

Value is mandatory. A single instance is required.

A numeric value expressed in the unit of measure (UOM).

RangeMin

RangeMin is optional. A single instance might exist.

The minimum value (lower boundary) allowed for the Measurement that is the parent of this element.

RangeMax

RangeMax is optional. A single instance might exist.

The maximum value (upper boundary) allowed for the Measurement that is the parent of this element. Some elements use the RangeMax element with an extended list of unit of measures. (Note: the red colour in the picture is an artifact of how the graphic was captured and should be disregarded.)

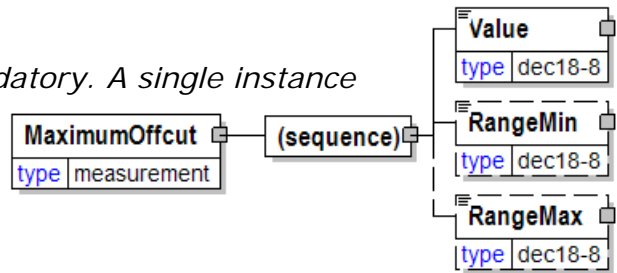

MaximumOrderQuantity

The maximum amount that can be ordered at one time.

(sequence)

The sequence of items below is mandatory. A single instance is required.

Quantity

Quantity is mandatory. A single instance is required.

The Quantity element contains attributes that provide information about the type of quantity that is being communicated, the context in which the particular quantity is to be viewed, and (if the quantity represents an adjustment) an adjustment type.

The Quantity element contains three child elements that enable you to communicate a range of values for the quantity and a target or actual value. It is at this level (Value, RangeMin, and RangeMax) that the unit of measure is specified. This permits the range to be specified in a different unit of measure than the target.

InformationalQuantity

InformationalQuantity is optional. Multiple instances might exist.

A quantity given in a valid UOM used for information purposes only (not for calculation). For example, an ordered quantity was 100 reels as opposed to the invoice quantity of 20,000 pounds.

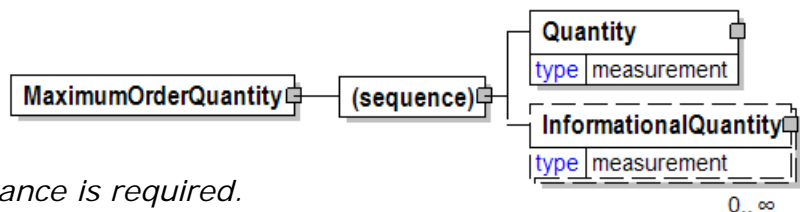

MeasurementModule

A text element describing the module used for measuring.

MeasurementModule	
type	s255

MeasurementsAre [attribute]

Used to define for a product whether the details provided are ranges and lists of properties, or whether they are discrete, single properties of the product.

MeasurementsAre	
type	measurementType

This item is restricted to the following list.

Discreet

For a product, elements with measurements are observed or target values, and elements that allow a list of attributes for the product to be specified must have zero or one occurrence.

Range

For a product, elements with measurements specify a range, and elements that allow a list of attributes for the product to be specified may have zero or more occurrences.

MeasurementSystem

A text element describing the system used for measuring.

MeasurementSystem	
type	s255

MeasuringAgency [attribute]

The agency defining measuring methods.

This item is restricted to the following list.

MeasuringAgency	
type	agencyCode.Measuring

Buyer

The buyer has defined the codes used in the particular element of the transaction. Care must be used when using this agency to assure that the recipient of the e-Document understands what is being communicated.

RVR

Agency maintaining codes for the German wood supply segment.

RVR is the abbreviation for "RahmenVereinbarung für den Rohholzhandel in Deutschland".

(www.rvr-deutschland.de).

SD

Agency maintaining codes for the Norwegian wood supply segment (www.skogdata.no).

SDC

Agency maintaining codes for the Swedish wood supply segment (www.sdc.se).

Supplier

The supplier has defined the codes used in the particular element of the transaction. Care must be used when using this agency to assure that the recipient of the e-Document understands what is being communicated.

MeasuringCode

A code defining the measuring procedure.

Agency [attribute]

Agency is mandatory. A single instance is required.

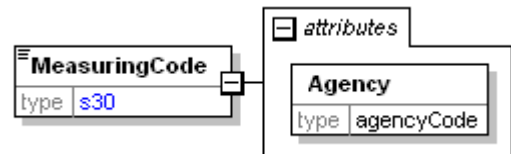

Describes the agency maintaining the list of codes. To be included in this list the agency must be a recognized standards body or industry organisation.

- For the element that owns this attribute.
- For another attribute in the list of attributes associated with the parent element.

Refer to Agency definition for any enumerations.

MeasuringDate

The date when the measuring was done.

(sequence)

The sequence of items below is mandatory. A single instance is required.

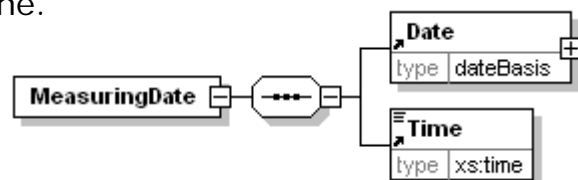

Date

Date is mandatory. A single instance is required.

A group element that contains the specification of Year, Month, and Day.

Time

Time is mandatory. A single instance is required.

Times are treated in a standard XML fashion with a special case used to indicate a generalized "local" time. The standard XML approach to time is hh:mm:ss, hh:mm:ssZ, or hh:mm:ss±hh:mm.

- hh:mm:ss±hh:mm is used to represent a time with a time zone. The time zone is communicated as the number of hours offset from the Universal Time Coordinate (UTC), a.k.a. Greenwich Mean Time.
 - hh:mm:ssZ indicates the time at Zulu (another name for UTC). Based on the convention described in the next bullet it will be important for users within UTC to use "Z" when communicating a time in their time zone to other users.
 - hh:mm:ss or hh:mm indicates in the XML standard the time at UTC however,
-

within papiNet it is used to represent the applicable local time. Caution should be used when processing times of this nature as the papiNet approach may be in discord with other users of XML.

MeasuringDescription

A text element describing the measuring procedure.

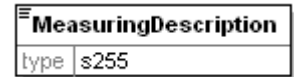

MeasuringEquipment

A grouping element that contains information about the equipment used for measuring.

(sequence)

The sequence of items below is mandatory. A single instance is required.

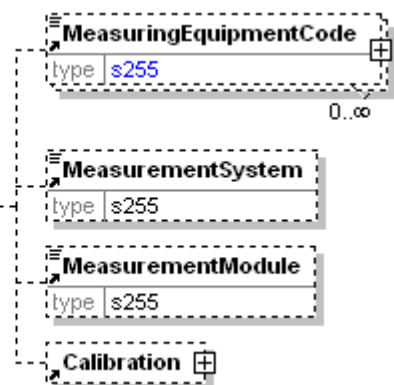

MeasuringEquipmentCode

MeasuringCode is optional. Multiple instances might exist.

A code used for identifying the measuring equipment.

MeasurementSystem

MeasurementSystem is optional. A single instance might exist.

A text element describing the system used for measuring.

MeasurementModule

MeasurementModule is optional. A single instance might exist.

A text element describing the module used for measuring.

Calibration

Calibration is optional. A single instance might exist.

A grouping element that contains information about calibration of the measuring equipment.

MeasuringEquipmentCode

A code used for identifying the measuring equipment.

Agency [attribute]

Agency is mandatory. A single instance is required.

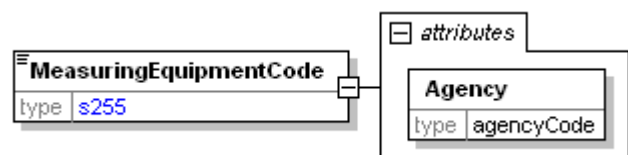

Describes the agency maintaining the list of codes. To be included in this list the agency must be a recognized standards body or industry organisation.

- For the element that owns this attribute.
- For another attribute in the list of attributes associated with the parent element.

Refer to Agency definition for any enumerations.

MeasuringLineID

The unique identifier for the measuring line at a measuring location.

MeasuringLineID	
type	s60

MeasuringLocation

A grouping element that contains information about where the measuring is taken place.

(sequence)

The sequence of items below is mandatory. A single instance is required.

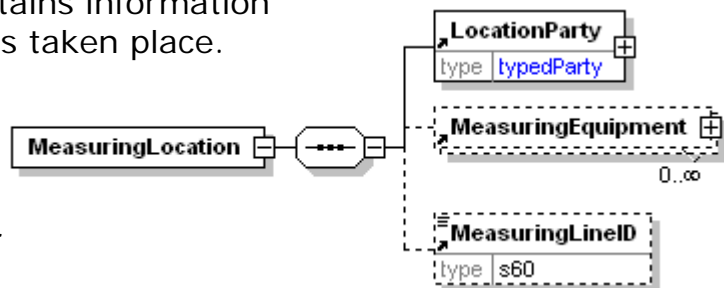

LocationParty

LocationParty is mandatory. A single instance is required

The organization or business entity where the business event took place or will take place.

MeasuringEquipment

MeasuringEquipment is optional. Multiple instances might exist.

A grouping element that contains information about the equipment used for measuring.

MeasuringLineID

MeasuringLineID is optional. A single instance might exist.

The unique identifier for the measuring line at a measuring location.

MeasuringMethod [attribute]

The method used to determine how the item under consideration is measured. Measuring methods are defined by the measuring agency.

attribute	
MeasuringMethod	
type	s60

MeasuringMethodType [attribute]

Specifies how a measurement value is created.

This item is restricted to the following list.

Automatic

The value is created by automatic measurement.

MeasuringMethodType	
type	measuringMethodType
default	Automatic

Calculated

The value is calculated.

Classified

The value is created by applying rules for classification based on a number of properties.

Manual

The value is created by manual measurement.

VisualEstimated

The value is created by visual estimation.

MeasuringNumber

A unique identifier for the measuring event.

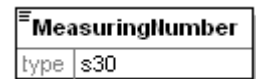

MeasuringParty

The party that is responsible for the measurements at the measuring location.

LogisticsRole [attribute]

LogisticsRole is optional. A single instance might exist.

Communicates the nature of the logistics role, if any, the party plays in the transaction.

Refer to LogisticsRole definition for any enumerations.

(sequence)

The sequence of items below is mandatory. A single instance is required.

PartyIdentifier

PartyIdentifier is optional. Multiple instances might exist.

A unique identifier of a specific party. This element contains an attribute PartyIdentifierType that indicates the type of party.

NameAddress

NameAddress is mandatory. A single instance is required.

A group item containing name and address of an organisation or business entity.

URL

URL is optional. A single instance might exist.

Universal Resource Locator. While typically a web address you could use this field to hold an email address.

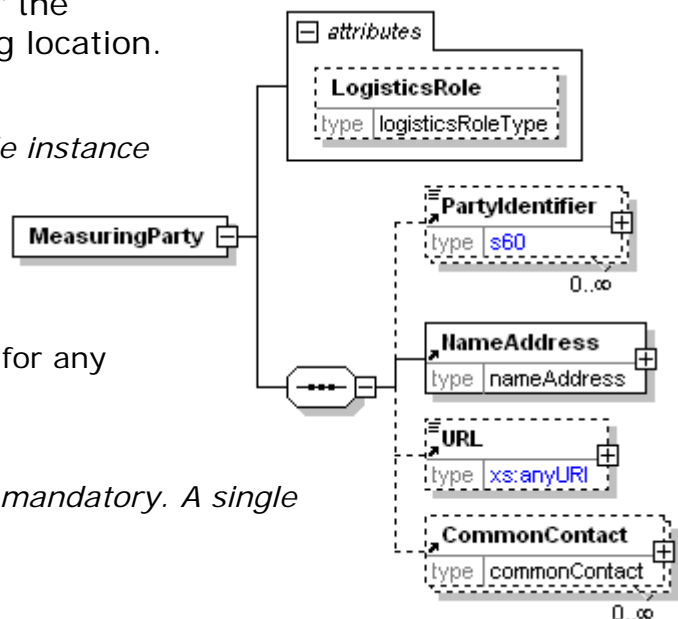

CommonContact

CommonContact is optional. Multiple instances might exist.

Identifies a specific individual associated with the party.

MeasuringSpecification

A grouping element that contains a specification for measurement procedures.

MeasuringType [attribute]

MeasuringType is mandatory. A single instance is required.

Specifies how detailed the measurements are done.

Refer to MeasuringType definition for any enumerations.

(sequence)

The sequence of items below is mandatory. A single instance is required.

MeasuringCode

MeasuringCode is optional. A single instance might exist.

A code defining the measuring procedure.

MeasuringDescription

MeasuringDescription is optional. Multiple instances might exist.

A text element describing the measuring procedure.

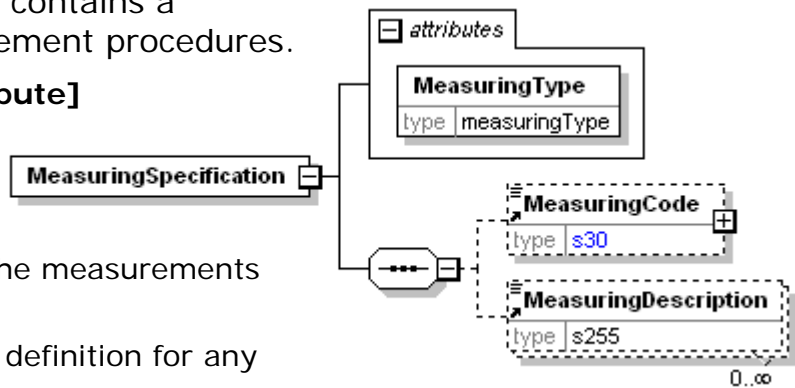

MeasuringTicket

The MeasuringTicket element is the root element for the MeasuringTicket e-Document.

The MeasuringTicket e-Document specifies the details from measuring of items. Packages and loads can be measured as well as individual items in packages and loads. Products, Quantities and various measured properties can be reported. These measurements can be used as a base for calculation of billable products.

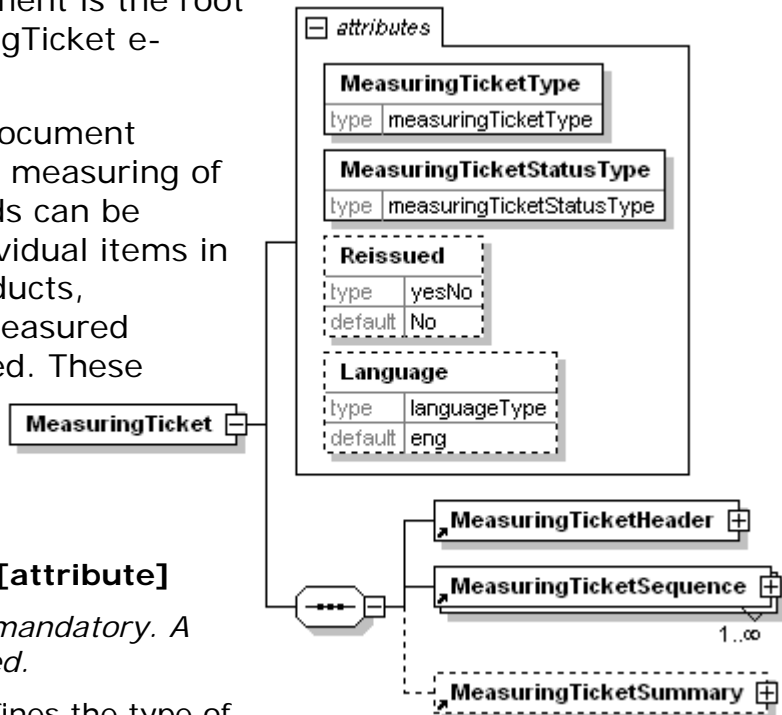

MeasuringTicketType [attribute]

MeasuringTicketType is mandatory. A single instance is required.

MeasuringTicketType defines the type of MeasuringTicket.

Refer to MeasuringTicketType definition for any enumerations.

MeasuringTicketStatusType [attribute]

MeasuringTicketStatusType is mandatory. A single instance is required.

Identifies the status of the entire MeasuringTicket e-Document.

Refer to MeasuringTicketStatusType definition for any enumerations.

Reissued [attribute]

Reissued is optional. A single instance might exist.

Either "Yes" or "No".

Refer to Reissued definition for any enumerations.

Language [attribute]

Language is optional. A single instance might exist.

XML has embraced 2 and 3 digit language codes through the application of an addendum to the standard.

Refer to Language definition for any enumerations.

(sequence)

The sequence of items below is mandatory. A single instance is required.

MeasuringTicketHeader

MeasuringTicketHeader is mandatory. A single instance is required.

The MeasuringTicketHeader contains information common to the entire MeasuringTicket e-Document.

MeasuringTicketSequence

MeasuringTicketSequence is mandatory. Multiple instances might exist.

A grouping element that contains information for a measuring event, e.g. a truck load.

MeasuringTicketSummary

MeasuringTicketSummary is optional. A single instance might exist.

A grouping element that contains summary information that applies to the entire MeasuringTicket e-Document.

MeasuringTicketHeader

The MeasuringTicketHeader contains information common to the entire MeasuringTicket e-Document.

(sequence)

The sequence of items below is mandatory. A single instance is required.

MeasuringTicketNumber

MeasuringTicketNumber is mandatory. A single instance is required.

The unique identifier for the MeasuringTicket e-Document.

MeasuringTicketIssueDate

MeasuringTicketIssueDate is mandatory. A single instance is required.

The date and time when the MeasuringTicket e-Document was issued.

TransactionHistoryNumber

TransactionHistoryNumber is optional. A single instance might exist.

A sequential number that keeps track of the version of a document being sent by the document originator except in the case where TransactionHistoryConfirmation is used, in which case the TransactionHistoryNumber refers to the trigger transaction for which the confirmation is being sent.

SenderParty

SenderParty is mandatory. A single instance is required.

The business entity issuing the e-Document, the source of the document.

- The entity responsible for the content. If the sender party has out sourced the message service to a third party the SenderParty is the issuer of the e-Document and not the party performing the transmission service of the electronic message.

ReceiverParty

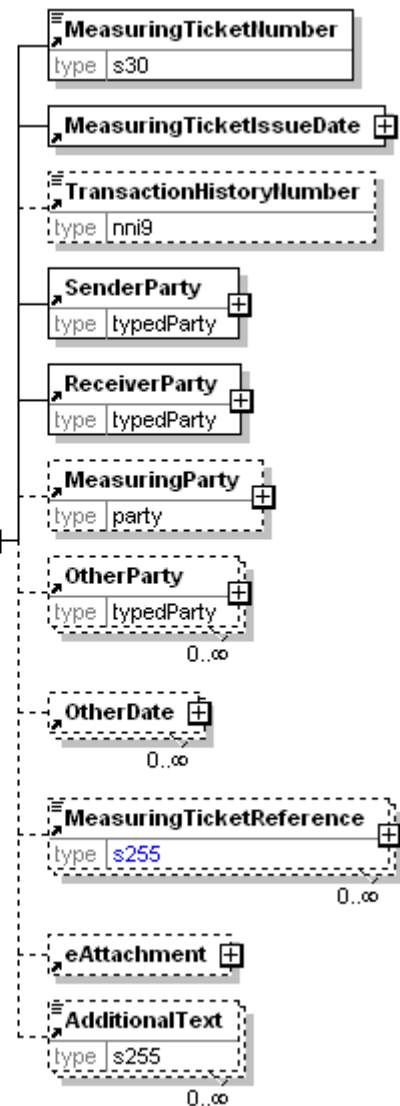

papiNet V2R31

ReceiverParty is mandatory. One instance is required, multiple instances might exist.

The business entity for whom the e-Document is intended, the destination of the document.

- The entity interested in the content. If the receiver party has outsourced the message service to a third party the ReceiverParty is the intended party for the e-Document and not the party performing the receiving service of the electronic message.

MeasuringParty

MeasuringParty is optional. A single instance might exist.

The party that is responsible for the measurements at the measuring location.

OtherParty

OtherParty is optional. Multiple instances might exist.

An organisation or business entity other than those specifically detailed within a e-Document.

OtherDate

OtherDate is optional. Multiple instances might exist.

A date that may not be specifically detailed within a document (example: print date at the PurchaseOrderLineItem).

MeasuringTicketReference

MeasuringTicketReference is optional. Multiple instances might exist.

An element detailing relevant references pertaining to the MeasuringTicket as indicated by MeasuringTicketReferenceType and AssignedBy.

eAttachment

eAttachment is optional. A single instance might exist.

eAttachment enables the sender to provide information about attachments to the document.

- Note: An element "e-Attachment" also exists. papiNet will no longer use hyphens in our element and attribute names as this causes issues with BizTalk.

AdditionalText

AdditionalText is optional. Multiple instances might exist.

A text field that is used to communicate information not previously defined or for special instructions. To be used only for circumstances not covered by specific elements.

MeasuringTicketIssueDate

The date and time when the MeasuringTicket e-Document was issued.

(sequence)

The sequence of items below is mandatory. A single instance is required.

Date

Date is mandatory. A single instance is required.

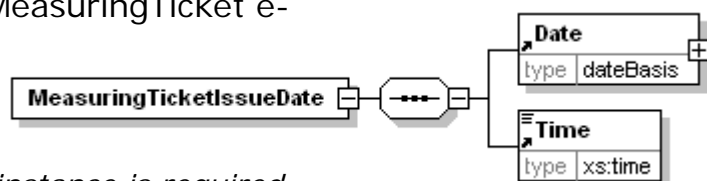

papiNet V2R31

A group element that contains the specification of Year, Month, and Day.

Time

Time is mandatory. A single instance is required.

Times are treated in a standard XML fashion with a special case used to indicate a generalized "local" time. The standard XML approach to time is hh:mm:ss, hh:mm:ssZ, or hh:mm:ss±hh:mm.

- hh:mm:ss±hh:mm is used to represent a time with a time zone. The time zone is communicated as the number of hours offset from the Universal Time Coordinate (UTC), a.k.a. Greenwich Mean Time.
- hh:mm:ssZ indicates the time at Zulu (another name for UTC). Based on the convention described in the next bullet it will be important for users within UTC to use "Z" when communicating a time in their time zone to other users.
- hh:mm:ss or hh:mm indicates in the XML standard the time at UTC however, within papiNet it is used to represent the applicable local time. Caution should be used when processing times of this nature as the papiNet approach may be in discord with other users of XML.

MeasuringTicketNumber

The unique identifier for the MeasuringTicket e-Document.

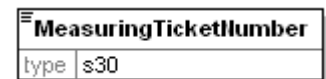

MeasuringTicketReference

An element detailing relevant references pertaining to the MeasuringTicket as indicated by

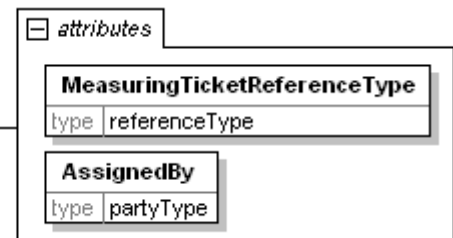
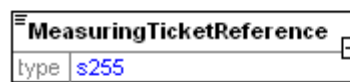

MeasuringTicketReferenceType and AssignedBy.

MeasuringTicketReferenceType [attribute]

MeasuringTicketReferenceType is mandatory. A single instance is required.

Provides a contextual explanation of the specific reference identifier. Many items are currently prefixed by "Buyer", "Forwarder", "Manufacturer", "Mill", "Seller", "Supplier", "Warehouse", or "Vendor". Check for an existing non-prefixed version and use the non-prefixed version instead. In the (yet to be announced release date) version 3.0 the prefixed versions will be removed. Instead the attribute @AssignedBy will communicate the information previously communicated in the prefix.

Refer to MeasuringTicketReferenceType definition for any enumerations.

AssignedBy [attribute]

AssignedBy is mandatory. A single instance is required.

Identifies the type of party that has assigned the associated item, e.g. a

reference of type OrderNumber.

Refer to AssignedBy for any enumerations.

MeasuringTicketReferenceType [attribute]

Provides a contextual explanation of the specific reference identifier. Many items are currently prefixed by "Buyer", Forwarder", "Manufacturer", "Mill", "Seller", "Supplier", Warehouse" or Vendor". Check for an existing non-prefixed version and use the non-prefixed version instead. In the (yet to be announced release date) version 3.0 the prefixed versions will be removed. Instead the attribute AssignedBy will communicate the information previously communicated in the prefix.

MeasuringTicketReferenceType	
type	referenceType

Refer to the [referenceType](#) entry for the list of enumerations and their definitions.

MeasuringTicketSequence

A grouping element that contains information for a measuring event, e.g. a truck load.

(sequence)

The sequence of items below is mandatory. A single instance is required.

MeasuringTicketSequenceNumber

MeasuringTicketSequenceNumber is mandatory. A single instance is required.

A sequential number that uniquely identifies the Sequence of a MeasuringTicket.

MeasuringNumber

MeasuringNumber is optional. A single instance might exist.

A unique identifier for the measuring event.

MeasuringDate

MeasuringDate is optional. A single instance might exist.

The date when the measuring was done.

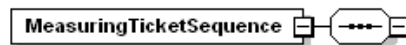

MeasuringSpecification

MeasuringSpecification is mandatory. A single instance is required.

A grouping element that contains a specification for measurement procedures.

MeasuringTicketReference

MeasuringTicketReference is optional. Multiple instances might exist.

An element detailing relevant references pertaining to the MeasuringTicket as indicated by MeasuringTicketReferenceType and AssignedBy.

OtherDate

OtherDate is optional. Multiple instances might exist.

A date that may not be specifically detailed within a document (example: print date at the PurchaseOrderLineItem).

MeasuringLocation

MeasuringLocation is mandatory. A single instance is required.

A grouping element that contains information about where the measuring is taken place.

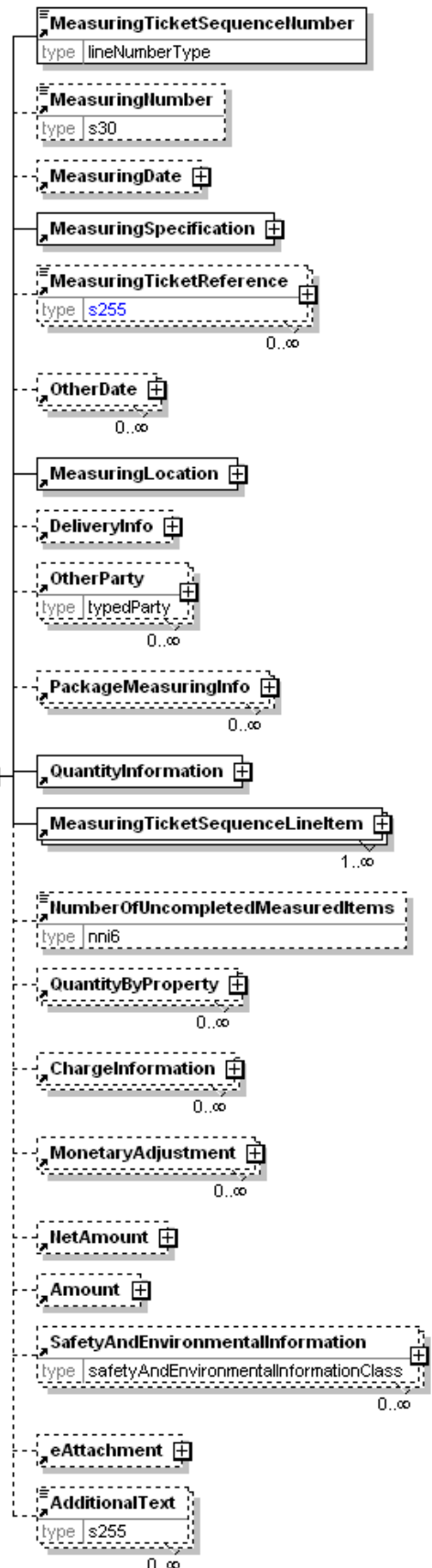

DeliveryInfo

DeliveryInfo is optional. A single instance might exist.

Information about the delivery.

OtherParty

OtherParty is optional. Multiple instances might exist.

An organisation or business entity other than those specifically detailed within a e-Document.

PackageMeasuringInfo

PackageMeasuringInfo is optional. Multiple instances might exist.

A grouping element that contains information about a measured package or a measured load when the load is treated as one package.

QuantityInformation

QuantityInformation is mandatory. A single instance is required.

A group item containing information about quantity and informational quantity of similar items.

MeasuringTicketSequenceLineItem

MeasuringTicketSequenceLineItem is mandatory. Multiple instances might exist.

A grouping element identifying a line item included within the MeasuringTicket Sequence.

NumberOfUnCompletedMeasuredItems

NumberOfUnCompletedMeasuredItems is optional. A single instance might exist.

Specifies the number of items that are uncompleted measured, i.e. some measurement values are missing for these items.

QuantityByProperty

QuantityByProperty is optional. Multiple instances might exist.

A grouping element that contains specification of quantities per property value.

ChargeInformation

ChargeInformation is optional. Multiple instances might exist.

A group element that contains elements that describe a charge.

MonetaryAdjustment

MonetaryAdjustment is optional. Multiple instances might exist.

The element containing the information necessary for the understanding, calculation, and treatment of an adjustment to a currency amount. MonetaryAdjustment contains an attribute that indicates they type of adjustment being communicated.

NetAmount

NetAmount is optional. A single instance might exist.

An element that contains the net amount excluding tax. Adjustments are included in NetAmount. NetAmount encapsulates CurrencyValue.

Amount

Amount is optional. A single instance might exist.

An element that contains the amount including tax. The Amount encapsulates

CurrencyValue.

SafetyAndEnvironmentalInformation

SafetyAndEnvironmentalInformation is optional. Multiple instances might exist.

Name of certification type, if any, on the goods (For example, FSC, PEFC). SafetyAndEnvironmental needs a value or measurement to communicate the percentage of the product is certified (for example, 75% is certified by the indicated agency).

eAttachment

eAttachment is optional. A single instance might exist.

eAttachment enables the sender to provide information about attachments to the document.

- Note: An element "e-Attachment" also exists. papiNet will no longer use hyphens in our element and attribute names as this causes issues with BizTalk.

AdditionalText

AdditionalText is optional. Multiple instances might exist.

A text field that is used to communicate information not previously defined or for special instructions. To be used only for circumstances not covered by specific elements.

MeasuringTicketSequenceLineItem

A grouping element identifying a line item included within the MeasuringTicket Sequence.

(sequence)

The sequence of items below is mandatory. A single instance is required.

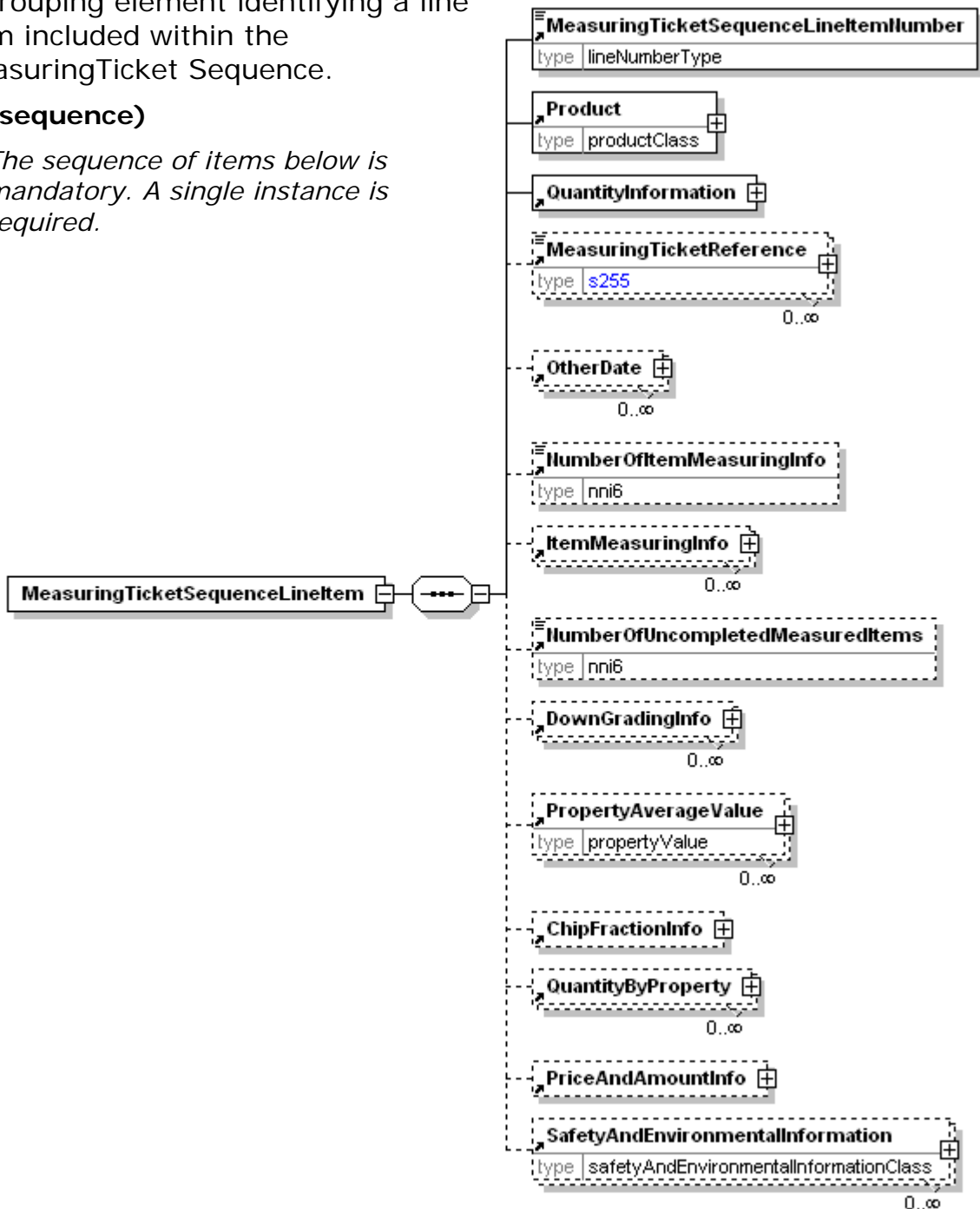

MeasuringTicketSequenceLineItemNumber

MeasuringTicketSequenceLineItemNumber is mandatory. A single instance is required.

A sequential number that uniquely identifies the line item of the MeasuringTicket Sequence.

Product

Product is optional. A single instance might exist.

Product is a group item defining the article and its characteristics. Product is used to specify product characteristics organized by ProductIdentifier, ProductDescription, and Classification. Book Manufacturing, Label Stock, Paper,

Pulp, Recovered Paper, Wood Products, and Virgin Fibre market segments have defined their product characteristics and conversion features for implementation in papiNet.

QuantityInformation

QuantityInformation is mandatory. A single instance is required.

A group item containing information about quantity and informational quantity of similar items.

MeasuringTicketReference

MeasuringTicketReference is optional. Multiple instances might exist.

An element detailing relevant references pertaining to the MeasuringTicket as indicated by MeasuringTicketReferenceType and AssignedBy.

OtherDate

OtherDate is optional. Multiple instances might exist.

A date that may not be specifically detailed within a document (example: print date at the PurchaseOrderLineItem).

NumberOfItemMeasuringInfo

NumberOfItemMeasuringInfo is optional. A single instance might exist.

Number of reported items by ItemMeasuringInfo.

ItemMeasuringInfo

ItemMeasuringInfo is optional. Multiple instances might exist.

A grouping element that contains information about measured items.

NumberOfUnCompletedMeasuredItems

NumberOfUnCompletedMeasuredItems is optional. A single instance might exist.

Specifies the number of items that are uncompleted measured, i.e. some measurement values are missing for these items.

DownGradingInfo

DownGradingInfo is optional. Multiple instances might exist.

A grouping element that contains information about downgrading of products.

PropertyAverageValue

PropertyAverageValue is optional. Multiple instances might exist.

Specifies an average value for a property for a number of items. The property is defined by the attribute PropertyType. The attribute MeasuringMethod and AssignedBy can be used to clarified details for a how a property is measured or calculated, e.g. Diameter for a sawlog can be measured "Under Bark" or "Over Bark". The attribute MeasuringMethodType defines how the value is created, e.g. measured automatically, calculated etc.

ChipFractionInfo

ChipFractionInfo is optional. A single instance might exist.

Grouping element that contains information about analysis of chip fractions.

QuantityByProperty

QuantityByProperty is optional. Multiple instances might exist.

A grouping element that contains specification of quantities per property value.

PriceAndAmountInfo

PriceAndAmountInfo is optional. A single instance might exist.

A grouping element that contains information about price and amounts.

SafetyAndEnvironmentalInformation

SafetyAndEnvironmentalInformation is optional. Multiple instances might exist.

Name of certification type, if any, on the goods (For example, FSC, PEFC). SafetyAndEnvironmental needs a value or measurement to communicate the percentage of the product is certified (for example, 75% is certified by the indicated agency).

MeasuringTicketSequenceLineItemNumber

A sequential number that uniquely identifies the line item of the MeasuringTicket Sequence.

MeasuringTicketSequenceLineItemNumber	
type	lineNumberType

MeasuringTicketSequenceNumber

A sequential number that uniquely identifies the Sequence of a MeasuringTicket.

MeasuringTicketSequencellumber	
type	lineNumberType

MeasuringTicketStatusType [attribute]

Identifies the status of the entire MeasuringTicket e-Document.

MeasuringTicketStatusType	
type	measuringTicketStatusType

This item is restricted to the following list.

Cancelled

The supplied information has been cancelled. Items that have been cancelled are not included in totals on the summary levels of the e-Document.

Original

The supplied information is the first version of that information.

Replaced

The supplied information is replacing earlier supplied information. The receiver should revalidate the information in their system based upon the entire information received.

MeasuringTicketSummary

A grouping element that contains summary information that applies to the entire MeasuringTicket e-Document.

(sequence)

The sequence of items below is mandatory. A single instance is required.

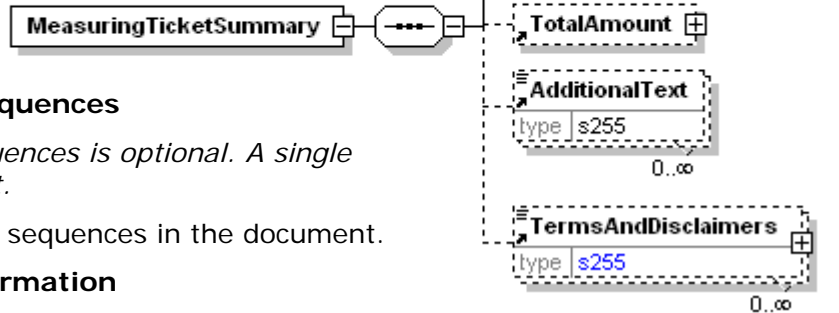

TotalNumberOfSequences

TotalNumberOfSequences is optional. A single instance might exist.

The total number of sequences in the document.

TotalQuantityInformation

TotalQuantityInformation is mandatory. A single instance is required.

A group item containing information about the total quantity and total informational quantity of similar items in the document.

TotalNetAmount

TotalNetAmount is optional. A single instance might exist.

A field containing total amount excluding tax. For example, in the Invoice TotalNetAmount is equal to the sum of LineItemSubTotal plus TotalAdjustments. TotalNetAmount encapsulates CurrencyValue.

TotalAmount

TotalAmount is optional. A single instance might exist.

The total amount including tax.

In e-Documents claiming payment this is the amount due for payment based on the terms of payment. Decimal rounding might be applied to this amount.

AdditionalText

AdditionalTexts is optional. Multiple instances might exist.

A text field that is used to communicate information not previously defined or for special instructions. To be used only for circumstances not covered by specific elements.

TermsAndDisclaimers

TermsAndDisclaimers is optional. Multiple instances might exist.

An element that contains legal information with an indication of what the Language is.

MeasuringTicketType [attribute]

MeasuringTicketType defines the type of MeasuringTicket.

This item is restricted to the following list.



CalibrationCheckLog

A MeasuringTicketType that contains a check log with information about calibration of measuring equipment.

InvoiceSpecification

A MeasuringTicketType that contains information about measured products including prices and amounts. This MeasuringTicketType is normally used as a detailed specification of billable or invoiced products.

MeasuringTicket

A MeasuringTicketType that contains detailed information about measured products and items. This information can be used as a base for calculation of billable products.

ProductionTicket

A MeasuringTicketType that contains information about produced products and items. A ProductionTicket can also contain measuring information for produced items.

SampleMeasuringTicket

A MeasuringTicketType that contains detailed information about measured samples taken from e.g. a delivery.

MeasuringType [attribute]

Specifies how detailed the measurements are done.

This item is restricted to the following list.

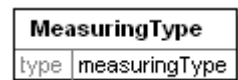

ByItem

Each item is measured separately, e.g. a logs on a truck load.

ByLoad

The whole truck load is measured as one unit.

ByPackage

Each package is measured separately, e.g. packages on a truck load or a roadside logpile.

MechanicalMaterial

Mechanical material information

(sequence)

The sequence of items below is mandatory. A single instance is required.

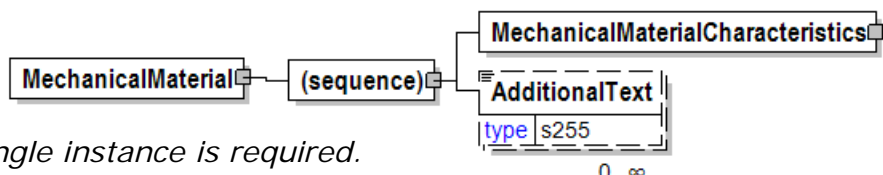

MechanicalMaterialCharacteristics

MechanicalMaterialCharacteristics is mandatory. A single instance is required.

Mecahnical material characteristics.

AdditionalText

AdditionalText is optional. Multiple instances might exist.

A text field that is used to communicate information not previously defined or for special instructions. To be used only for circumstances not covered by specific elements.

MechanicalMaterialCharacteristics

Mecahnical material characteristics.

(sequence)

The sequence of items below is mandatory. A single instance is required.

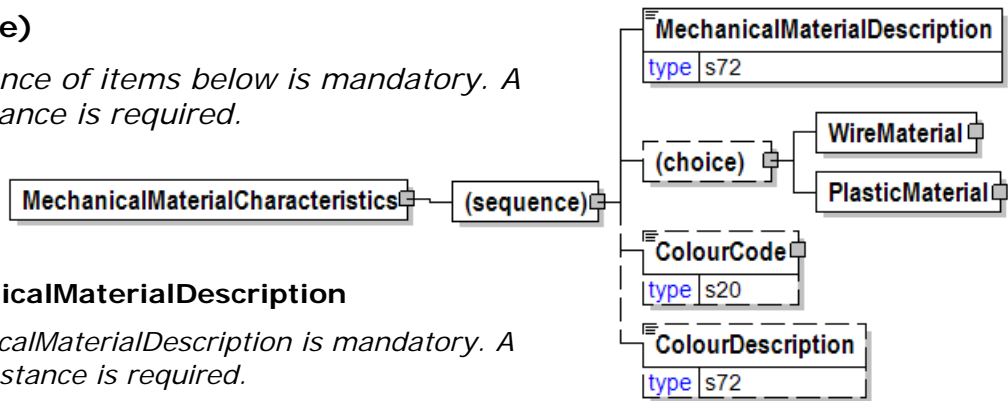

MechanicalMaterialDescription

MechanicalMaterialDescription is mandatory. A single instance is required.

Mechanical material description

(choice)

[choice] is optional because of choice construct.

WireMaterial

WireMaterial is optional because of choice construct.

Wire Material

PlasticMaterial

PlasticMaterial is optional because of choice construct.

Describes the plastic used in the process.

ColourCode

ColourCode is optional. A single instance might exist.

A code indicating the colour.

ColourDescription

ColourDescription is optional. A single instance might exist.

A free form description of the colour.

MechanicalMaterialDescription

Mechanical material description

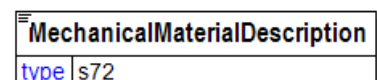

Media

Media.

MasterSource [attribute]

MasterSource is optional. A single instance might exist.

The source of the master

Refer to MasterSource definition for any enumerations.

(sequence)

The sequence of items below is mandatory. A single instance is required.

TotalRunningLength

TotalRunningLength is optional. A single instance might exist.

Summary value of amount measured in running meters, etc.

TotalNumberOfUnits

TotalNumberOfUnits is optional. A single instance might exist.

The total number of units.

MasterStorageOption

MasterStorageOption is optional. A single instance might exist.

Master storage option

(choice)

[choice] is optional because of choice construct.

AudioCassette

AudioCassette is optional because of choice construct.

Audio cassette

VideoCassette

VideoCassette is optional because of choice construct.

Video cassette information.

CD

CD is optional because of choice construct.

CD

DVD

DVD is optional because of choice construct.

DVD

Slide

Slide is optional because of choice construct.

Slide

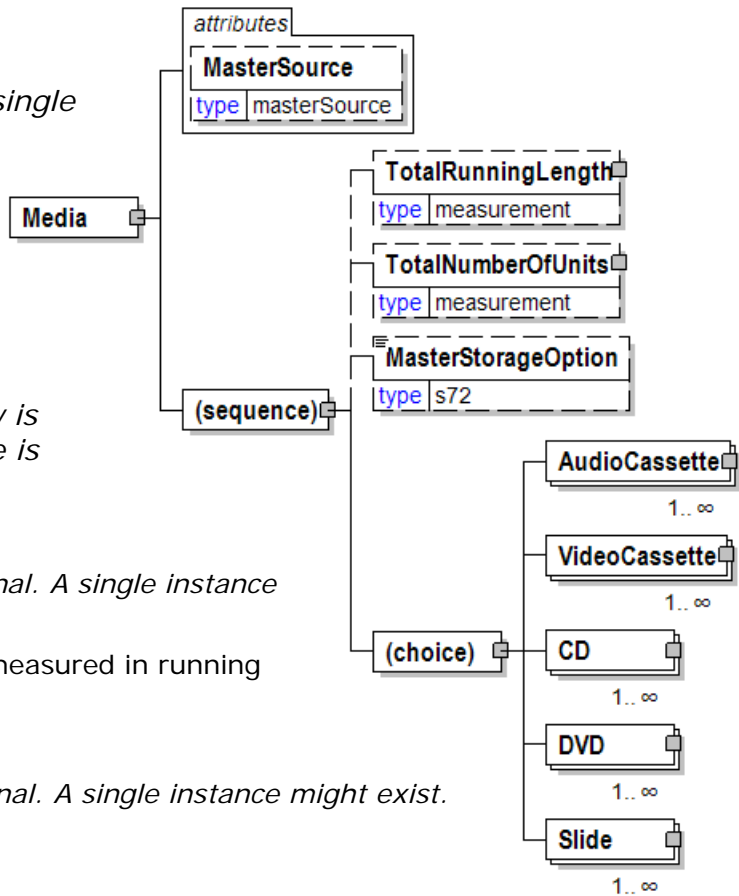

MediaLength

Media length

(sequence)

The sequence of items below is mandatory. A single instance is required.

TotalTime

TotalTime is optional. A single instance might exist.

The total time.

SideOneTime

SideOneTime is optional. A single instance might exist.

The time for side one.

SideTwoTime

SideTwoTime is optional. A single instance might exist.

The time for side two.

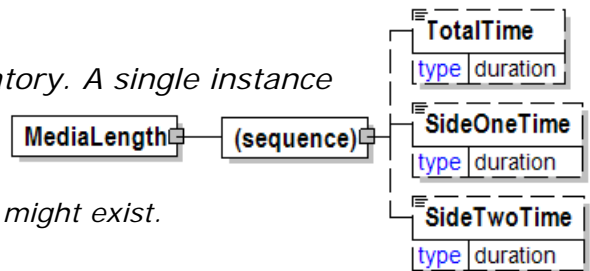

MediaType [attribute]

The type of media

This item is restricted to the following list.

CD

Compact Disk

DVD

Digital Video Disk

Electronic

Jaz

High capacity storage media

Syquest

A removable hard disk drive that is connected to the computer via a SCSI interface.

Zip

Other

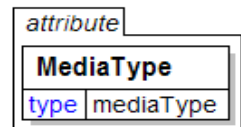

MerchantParty

This named party represents the merchant involved in the business transaction. This party is only used in the communication of OrderStatus otherwise it is handled via OtherParty.

LogisticsRole [attribute]

LogisticsRole is optional. A single instance might exist.

Communicates the nature of the logistics role, if any, the party plays in the transaction.

Refer to LogisticsRole definition for any enumerations.

(sequence)

The sequence of items below is mandatory. A single instance is required.

PartyIdentifier

PartyIdentifier is optional. Multiple instances might exist.

A unique identifier of a specific party. This element contains an attribute PartyIdentifierType that indicates the type of party.

NameAddress

NameAddress is mandatory. A single instance is required.

A group item containing name and address of an organisation or business entity.

URL

URL is optional. A single instance might exist.

Universal Resource Locator. While typically a web address you could use this field to hold an email address.

CommonContact

CommonContact is optional. Multiple instances might exist.

Identifies a specific individual associated with the party.

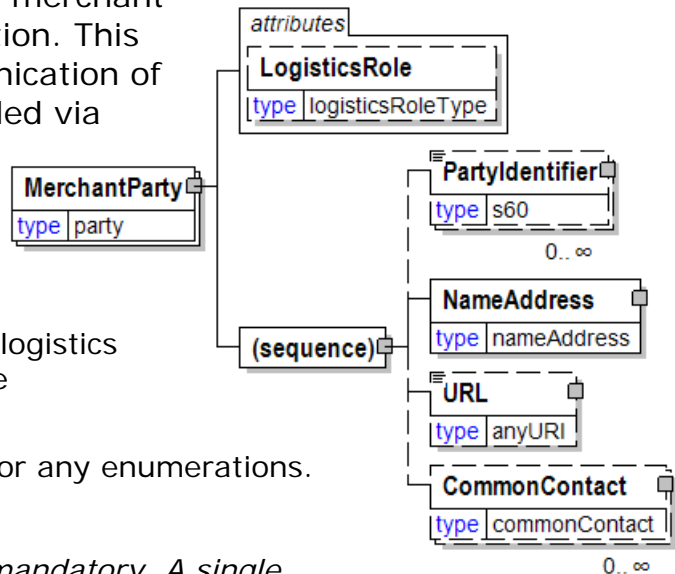

Method [attribute]

An attribute of the shipment method of payment, which defines the responsibilities of buyers and sellers for delivery under a sales contract.

It especially determines the obligations of the seller and the buyer regarding the payment of the freight costs.

This item is restricted to the following list.

CollectFreight

CollectFreightAndAllowed



CollectFreightCreditedBackToCustomer

Defines the difference between the invoice freight cost and the allowance by the mill. This can be a credit or a debit to the customer.

CustomerPickupBackhaul

Specifies that the carrier who is doing the delivery can pick a return load.

Pickup

Specifies that the customer will pick up the goods; in other words, the goods transport is organised by the buyer who will therefore pay for the freight.

PrepaidButChargedToCustomer

Specifies that the freight costs will be prepaid by the seller but will be charged back to the buyer.

PrepaidBySeller

Specifies that the seller will prepay the freight costs.

MethodOfPayment

The manner in which payment is to be transmitted to the seller.

MethodOfPayment	
type	s72

MillCharacteristics

A group item defining the mill party and machine identifier where a product is or was produced.

(sequence)

The sequence of items below is mandatory. A single instance is required.

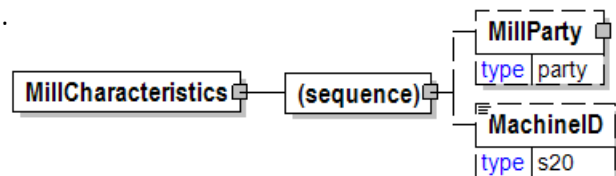

MillParty

MillParty is optional. A single instance might exist.

The organisation or business entity that actually produces the product.

MachineID

MachineID is optional. A single instance might exist.

An identifier assigned to the particular machine being referenced. For example, a machine could be a paper machine, an off-line coater, a sheeter, or a printing press. The particular machine being referenced will be determined by the business event being supported.

MillJoinLocation

A group element detailing the location of each mill join in a reel. The element DeliveryMessageReelCharacteristics/NumberOfMillJoins gives the total number of joins in a reel.

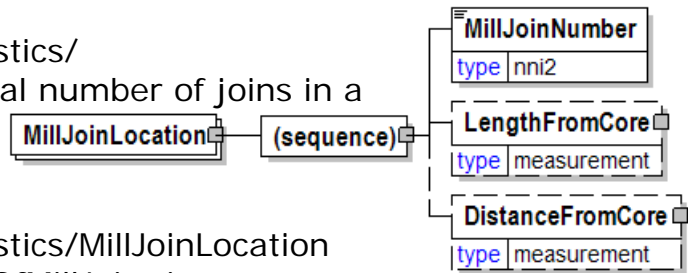

DeliveryMessageReelCharacteristics/MillJoinLocation would be repeated the NumberOfMillJoin times.

(sequence)

The sequence of items below is mandatory. A single instance is required.

MillJoinNumber

MillJoinNumber is mandatory. A single instance is required.

A sequential number that identifies each mill join in a reel. The element DeliveryMessageReelCharacteristics/NumberOfMillJoins gives the total number of joins in a reel.

LengthFromCore

LengthFromCore is optional. A single instance might exist.

In relationship to a paper event (usually a mill join) where is the event in terms of the length of the paper.

DistanceFromCore

DistanceFromCore is optional. A single instance might exist.

The distance from the radius of the core. This element can be used to communicate where a mill join is located. Compare to LengthFromCore.

MillJoinNumber

A sequential number that identifies each mill join in a reel. The element DeliveryMessageReelCharacteristics/NumberOfMillJoins gives the total number of joins in a reel.

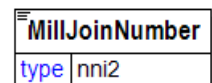

MillOrderInformation

A group item containing information unique to a mill order.

(sequence)

The sequence of items below is mandatory. A single instance is required.

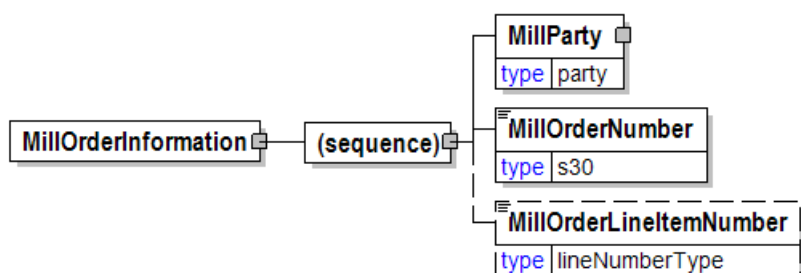

MillParty

MillParty is mandatory. A single instance is required.

The organisation or business entity that actually produces the product.

MillOrderNumber

MillOrderNumber is mandatory. A single instance is required.

The manufacturing order number the mill uses.

MillOrderLineNumber

MillOrderLineNumber is optional. A single instance might exist.

A number that uniquely identifies the line items of the Mill Order.

MillOrderLineNumber

A number that uniquely identifies the line items of the Mill Order.

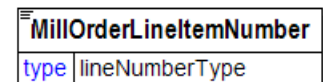

MillOrderNumber

The manufacturing order number the mill uses.

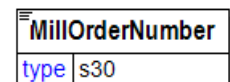

MillParty

The organisation or business entity that actually produces the product.

LogisticsRole [attribute]

LogisticsRole is optional. A single instance might exist.

Communicates the nature of the logistics role, if any, the party plays in the transaction.

Refer to LogisticsRole definition for any enumerations.

(sequence)

The sequence of items below is mandatory. A single instance is required.

PartyIdentifier

PartyIdentifier is optional. Multiple instances might exist.

A unique identifier of a specific party. This element contains an attribute PartyIdentifierType that indicates the type of party.

NameAddress

NameAddress is mandatory. A single instance is required.

A group item containing name and address of an organisation or business entity.

URL

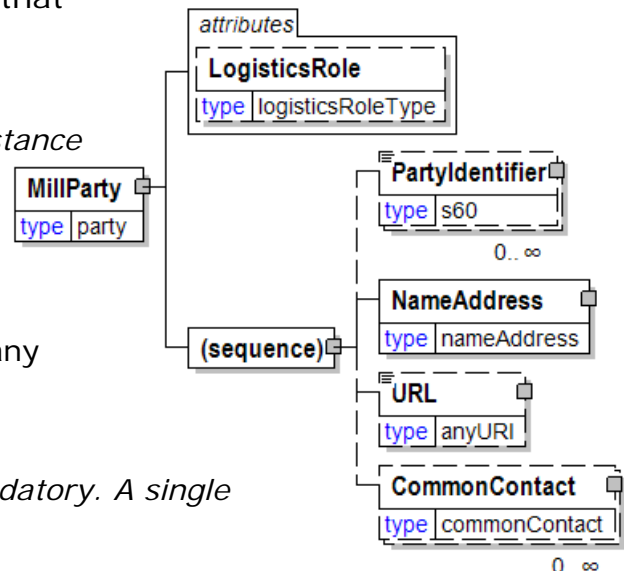

URL is optional. A single instance might exist.

Universal Resource Locator. While typically a web address you could use this field to hold an email address.

CommonContact

CommonContact is optional. Multiple instances might exist.

Identifies a specific individual associated with the party.

MillProductionInformation

A grouping element that contains information about production at the mill.

(sequence)

The sequence of items below is mandatory. A single instance is required.

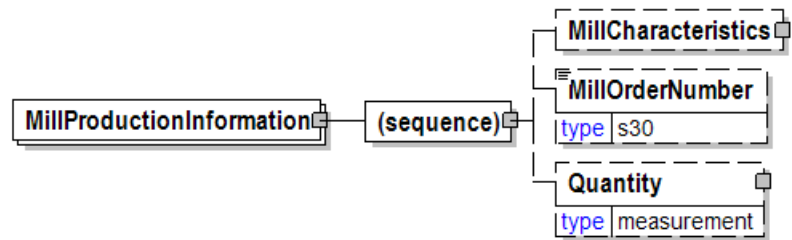

MillCharacteristics

MillCharacteristics is optional. A single instance might exist.

A group item defining the mill party and machine identifier where a product is or was produced.

MillOrderNumber

MillOrderNumber is optional. A single instance might exist.

The manufacturing order number the mill uses.

Quantity

Quantity is optional. A single instance might exist.

The Quantity element contains attributes that provide information about the type of quantity that is being communicated, the context in which the particular quantity is to be viewed, and (if the quantity represents an adjustment) an adjustment type.

The Quantity element contains three child elements that enable you to communicate a range of values for the quantity and a target or actual value. It is at this level (Value, RangeMin, and RangeMax) that the unit of measure is specified.

This permits the range to be specified in a different unit of measure than the target.

Millwork

A placeholder for the further definition of millwork items.

(sequence)

The sequence of items below is mandatory. A single instance is required.

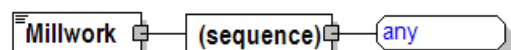

[Any Type]

Any type of content is permitted at this point.

MinCurrencyValue

The lower range of the allowed currency amount.

CurrencyType [attribute]

CurrencyType is optional. A single instance might exist.

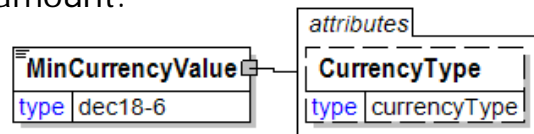

A three-character ISO 4217 currency code in capital letters. The ISO standard classification for currencies.

Refer to CurrencyType definition for any enumerations.

MinimumOrderQuantity

The minimum amount that can be ordered on a PurchaseOrder.

(sequence)

The sequence of items below is mandatory. A single instance is required.

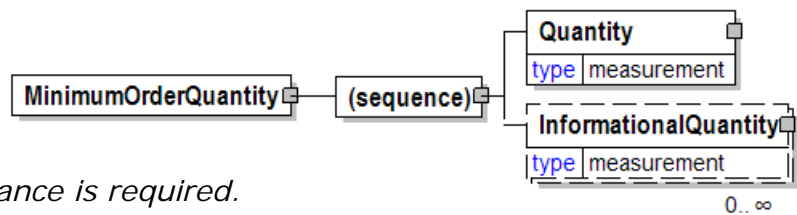

Quantity

Quantity is mandatory. A single instance is required.

The Quantity element contains attributes that provide information about the type of quantity that is being communicated, the context in which the particular quantity is to be viewed, and (if the quantity represents an adjustment) an adjustment type.

The Quantity element contains three child elements that enable you to communicate a range of values for the quantity and a target or actual value. It is at this level (Value, RangeMin, and RangeMax) that the unit of measure is specified. This permits the range to be specified in a different unit of measure than the target.

InformationalQuantity

InformationalQuantity is optional. Multiple instances might exist.

A quantity given in a valid UOM used for information purposes only (not for calculation). For example, an ordered quantity was 100 reels as opposed to the invoice quantity of 20,000 pounds.

Minutes

A qualifier for the DeliveryTransitTime.

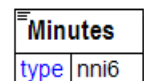

MixedProductPalletIndicator [attribute]

Specifies whether a product can be mixed with other products on the same pallet.

This item is restricted to the following list.

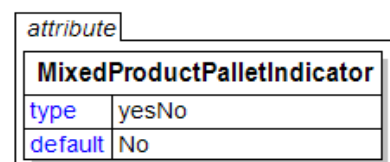

Yes

No

MixProductIndicator [attribute]

Specifies whether a product can be mixed with other products on the same shipment.

This item is restricted to the following list.

Yes

No

attribute	
MixProductIndicator	
type	yesNo
default	No

MobilePhone

The mobile phone number of the individual associated with the ContactName.

MobilePhone	
type	phoneNumber

ModulusElasticity [attribute]

Modulus elasticity

This item is restricted to the following list.

1.0E

1.1E

1.2E

1.3E

1.4E

1.5E

1.6E

1.7E

1.8E

1.9E

2.0E

2.1E

2.2E

2.3E

2.4E

attribute	
ModulusElasticity	
type	lumberModulusElasticityType

Moisture

Desired percentage, or other indicator, of water in the product at the time of shipment.

TestMethod [attribute]

TestMethod is optional. A single instance might exist.

The method used to determine the results of the test under consideration.

TestAgency [attribute]

TestAgency is optional. A single instance might exist.

The agency that has set the parameters for the testing

Refer to TestAgency definition for any enumerations.

SampleType [attribute]

SampleType is optional. A single instance might exist.

Communicates how sampling was done to measure the product characteristics.

Refer to SampleType definition for any enumerations.

ResultSource [attribute]

ResultSource is optional. A single instance might exist.

Used to define the data source of the specified test

Refer to ResultSource definition for any enumerations.

(sequence)

The sequence of items below is mandatory. A single instance is required.

DetailValue

DetailValue is mandatory. A single instance is required.

A numeric value expressed in the unit of measure (UOM).

DetailRangeMin

DetailRangeMin is optional. A single instance might exist.

The minimum value (lower boundary) allowed for the DetailValue that is the parent of this element.

DetailRangeMax

DetailRangeMax is optional. A single instance might exist.

The maximum value (upper boundary) allowed for the DetailValue that is the parent of this element.

StandardDeviation

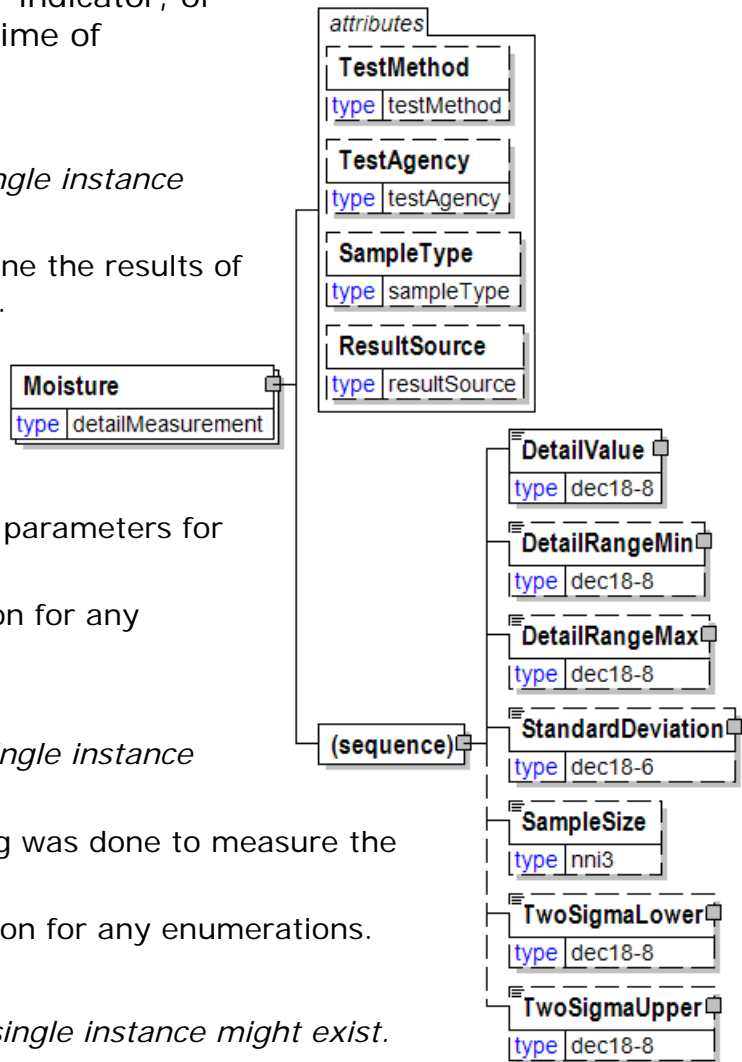

StandardDeviation is optional. A single instance might exist.

A statistic used as a measure of dispersion in a distribution.

SampleSize

SampleSize is optional. A single instance might exist.

The number of samples used to determine the product characteristic in question.

TwoSigmaLower

TwoSigmaLower is optional. A single instance might exist.

Two sigma (a measure of dispersion associated with standard deviation) on the lower side of the standard deviation.

TwoSigmaUpper

TwoSigmaUpper is optional. A single instance might exist.

Two sigma (a measure of dispersion associated with standard deviation) on the upper side of the standard deviation.

MoistureContent

Defines the moisture content percentage of the product.

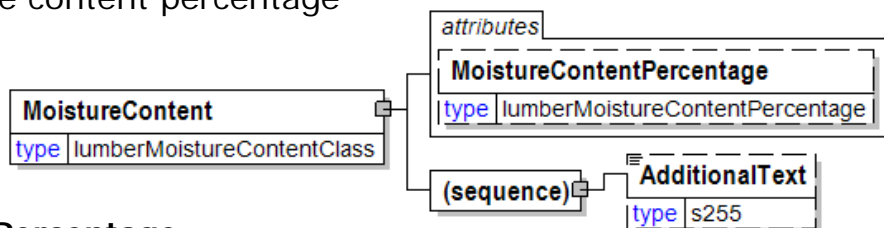

MoistureContentPercentage [attribute]

MoistureContentPercentage is optional. A single instance might exist.

Defines the percentage moisture content to which the product has been dried.

Refer to MoistureContentPercentage definition for any enumerations.

(sequence)

The sequence of items below is mandatory. A single instance is required.

AdditionalText

AdditionalText is optional. A single instance might exist.

A text field that is used to communicate information not previously defined or for special instructions. To be used only for circumstances not covered by specific elements.

MoistureContentPercentage [attribute]

Defines the percentage moisture content to which the product has been dried.

This item is restricted to the following list.

- 1
- 2

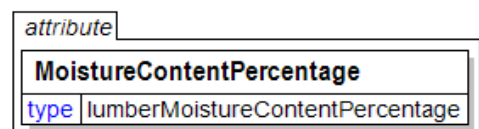

3

4

5

6

7

8

9

10

11

12

13

14

15

16

18

19

20

21

22

23

Other

MonetaryAdjustment

The element containing the information necessary for the understanding, calculation, and treatment of an adjustment to a currency amount.

MonetaryAdjustment contains an attribute that indicates they type of adjustment being communicated.

AdjustmentType [attribute]

AdjustmentType is mandatory. A single instance is required.

Describes the type of adjustment applied to a monetary oriented element. Adjustment values should always be given as negative or positive adjustments even if AdjustmentType indicates the sign. For example, a rebate of 1% on an invoice should be given as an adjustment percentage of -1%.

Refer to AdjustmentType definition for any enumerations.

(sequence)

The sequence of items below is mandatory. A single instance is required.

MonetaryAdjustmentLine

MonetaryAdjustmentLine is mandatory. A single instance is required.

A sequence number indicating the order of printing or the sequence in which a group of adjustments are to be considered.

MonetaryAdjustmentStartAmount

MonetaryAdjustmentStartAmount is optional. A single instance might exist.

The beginning currency amount used in the calculation of a monetary adjustment.

MonetaryAdjustmentStartQuantity

MonetaryAdjustmentStartQuantity is optional. A single instance might exist.

The beginning quantity used in the calculation of a monetary adjustment.

(choice)

[choice] is optional because of choice construct.

PriceAdjustment

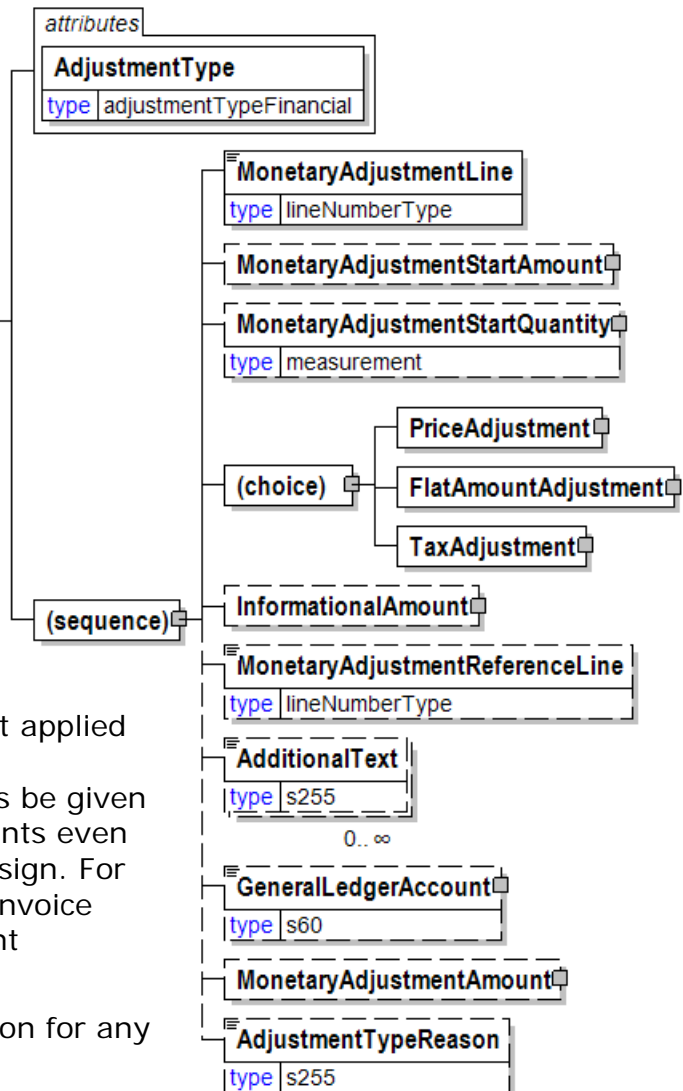

PriceAdjustment is optional because of choice construct.

A group item defining a deviation from the PricePerUnit.

FlatAmountAdjustment

FlatAmountAdjustment is optional because of choice construct.

A group item that contains flat adjustment amount information.

TaxAdjustment

TaxAdjustment is optional because of choice construct.

This content element contains the necessary information to describe, calculate, and handle a tax adjustment.

InformationalAmount

InformationalAmount is optional. A single instance might exist.

A monetary amount used for information purposes only (not for calculation). For example, the invoice price adjustment subtotal is expressed in sterling pounds, and the buyer wants this information expressed in U.S. dollars.

CreditDebitNote and Invoice - The TaxAmount is displayed in the currency that is applicable throughout the e-Document. When a TaxAmount needs to be displayed in a different national currency, this field is used.

MonetaryAdjustmentReferenceLine

MonetaryAdjustmentReferenceLine is optional. A single instance might exist.

A link to a previously defined MonetaryAdjustmentLine upon which this adjustment is based.

AdditionalText

AdditionalText is optional. Multiple instances might exist.

A text field that is used to communicate information not previously defined or for special instructions. To be used only for circumstances not covered by specific elements.

GeneralLedgerAccount

GeneralLedgerAccount is optional. A single instance might exist.

The general ledger account to be referenced for the item.

MonetaryAdjustmentAmount

MonetaryAdjustmentAmount is optional. A single instance might exist.

The actual amount of the monetary adjustment.

AdjustmentTypeReason

AdjustmentTypeReason is optional. A single instance might exist.

Provides additional information about the type of adjustment. Can be viewed as a sub-classification of the adjustment type attribute or as a textual explanation.

MonetaryAdjustmentAmount

The actual amount of the monetary adjustment.

(sequence)

The sequence of items

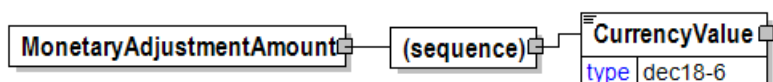

below is mandatory. A single instance is required.

CurrencyValue

CurrencyValue is mandatory. A single instance is required.

The amount in the referenced currency as defined by the CurrencyType attribute.

MonetaryAdjustmentLine

A sequence number indicating the order of printing or the sequence in which a group of adjustments are to be considered.

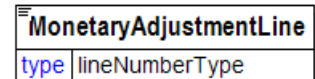

MonetaryAdjustmentReferenceLine

A link to a previously defined MonetaryAdjustmentLine upon which this adjustment is based.

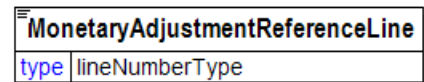

MonetaryAdjustmentStartAmount

The beginning currency amount used in the calculation of a monetary adjustment.

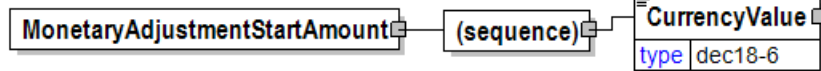

(sequence)

The sequence of items below is mandatory. A single instance is required.

CurrencyValue

CurrencyValue is mandatory. A single instance is required.

The amount in the referenced currency as defined by the CurrencyType attribute.

MonetaryAdjustmentStartQuantity

The beginning quantity used in the calculation of a monetary adjustment.

(sequence)

The sequence of items below is mandatory. A single instance is required.

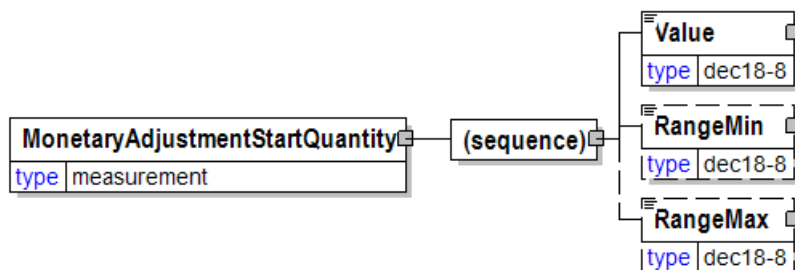

Value

Value is mandatory. A single instance is required.

A numeric value expressed in the unit of measure (UOM).

RangeMin

RangeMin is optional. A single instance might exist.

The minimum value (lower boundary) allowed for the Measurement that is the

parent of this element.

RangeMax

RangeMax is optional. A single instance might exist.

The maximum value (upper boundary) allowed for the Measurement that is the parent of this element. Some elements use the RangeMax element with an extended list of unit of measures. (Note: the red colour in the picture is an artifact of how the graphic was captured and should be disregarded.)

Month

Identifies the month number when communicating a Calendar date.

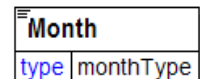

Mullen

Mullen, also called "burst strength", is the amount of pressure required to rupture paper or linerboard when applied to its surface. The unit of measure is KiloPascal (sometimes abbreviated as "kPa").

TestMethod [attribute]

TestMethod is optional. A single instance might exist.

The method used to determine the results of the test under consideration.

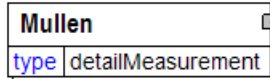

TestAgency [attribute]

TestAgency is optional. A single instance might exist.

The agency that has set the parameters for the testing

Refer to TestAgency definition for any enumerations.

SampleType [attribute]

SampleType is optional. A single instance might exist.

Communicates how sampling was done to measure the product characteristics.

Refer to SampleType definition for any enumerations.

ResultSource [attribute]

ResultSource is optional. A single instance might exist.

Used to define the data source of the specified test

Refer to ResultSource definition for any enumerations.

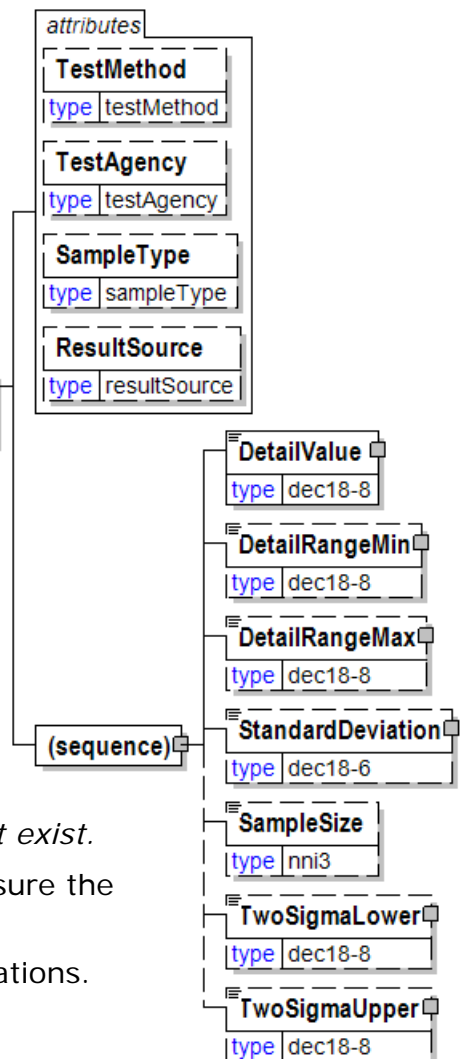

(sequence)

The sequence of items below is mandatory. A single instance is required.

DetailValue

DetailValue is mandatory. A single instance is required.

A numeric value expressed in the unit of measure (UOM).

DetailRangeMin

DetailRangeMin is optional. A single instance might exist.

The minimum value (lower boundary) allowed for the DetailValue that is the parent of this element.

DetailRangeMax

DetailRangeMax is optional. A single instance might exist.

The maximum value (upper boundary) allowed for the DetailValue that is the parent of this element.

StandardDeviation

StandardDeviation is optional. A single instance might exist.

A statistic used as a measure of dispersion in a distribution.

SampleSize

SampleSize is optional. A single instance might exist.

The number of samples used to determine the product characteristic in question.

TwoSigmaLower

TwoSigmaLower is optional. A single instance might exist.

Two sigma (a measure of dispersion associated with standard deviation) on the lower side of the standard deviation.

TwoSigmaUpper

TwoSigmaUpper is optional. A single instance might exist.

Two sigma (a measure of dispersion associated with standard deviation) on the upper side of the standard deviation.

MWeight

The weight of 1000 sheets.

(sequence)

The sequence of items below is mandatory. A single instance is required.

Value

Value is mandatory. A single instance is required.

A numeric value expressed in the unit of measure (UOM).

RangeMin

RangeMin is optional. A single instance might exist.

The minimum value (lower boundary) allowed for the Measurement that is the parent of this element.

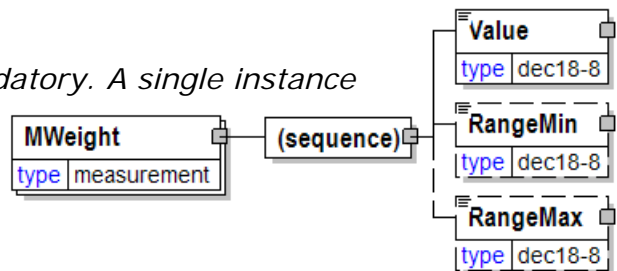

papiNet V2R31

RangeMax

RangeMax is optional. A single instance might exist.

The maximum value (upper boundary) allowed for the Measurement that is the parent of this element. Some elements use the RangeMax element with an extended list of unit of measures. (Note: the red colour in the picture is an artifact of how the graphic was captured and should be disregarded.)

Name1

The primary-level name of an organisation or business entity (for example, company name).

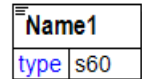

Name2

The second-level name of an organisation or business entity (for example, department, division, and so on).

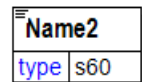

Name3

The third-level name of an organisation or business entity.

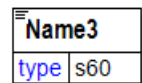

NameAddress

A group item containing name and address of an organisation or business entity.

CommunicationRole [attribute]

CommunicationRole is optional. A single instance might exist.

Provides information about the sender, receiver, and participants to the document communication.

Refer to

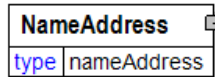

CommunicationRole definition for any enumerations.

(sequence)

The sequence of items below is mandatory. A single instance is required.

Name1

Name1 is mandatory. A single instance is required.

The primary-level name of an organisation or business entity (for example, company name).

Name2

Name2 is optional. A single instance might exist.

The second-level name of an organisation or business entity (for example, department, division, and so on).

Name3

Name3 is optional. A single instance might exist.

The third-level name of an organisation or business entity.

OrganisationUnit

OrganisationUnit is optional. A single instance might exist.

A segment of a business or the entire business.

Address1

Address1 is optional. A single instance might exist.

The primary-level address of an organisation or business entity (for example, street name, and number).

Address2

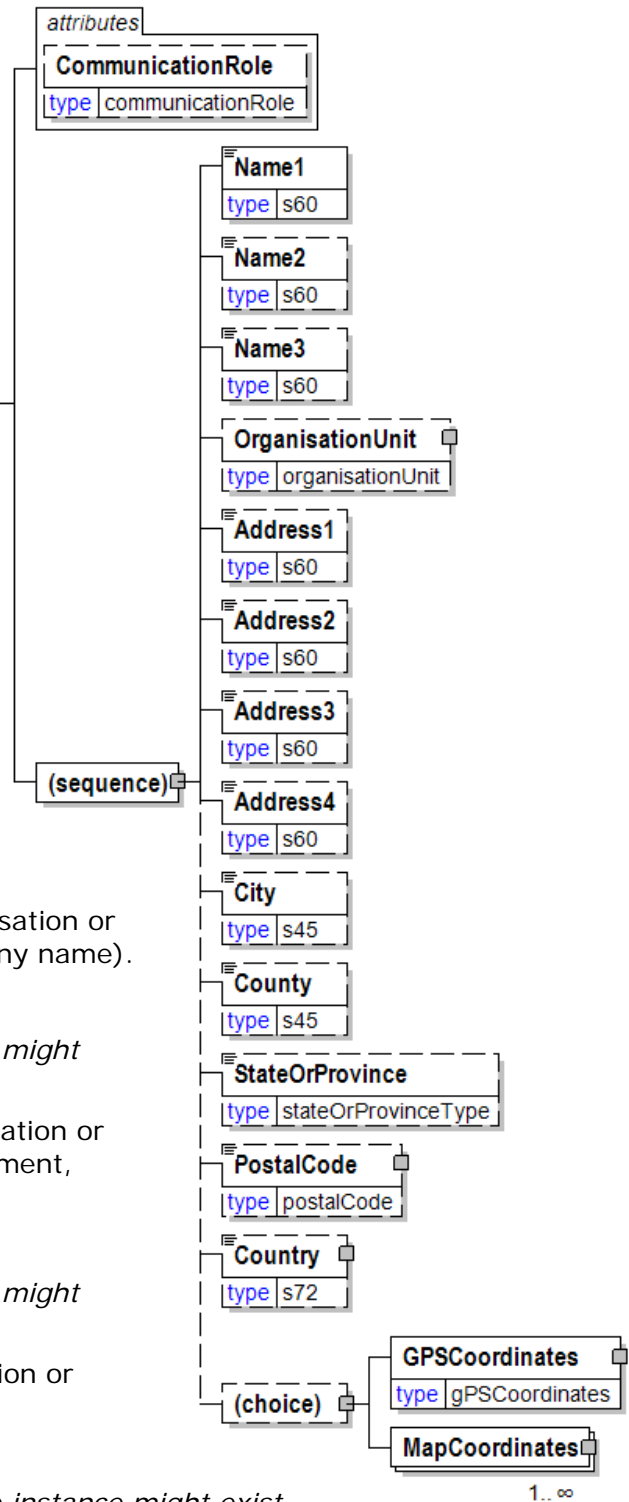

papiNet V2R31

Address2 is optional. A single instance might exist.

The second-level address of an organisation or business entity.

Address3

Address3 is optional. A single instance might exist.

The third-level address of an organisation or business entity.

Address4

Address4 is optional. A single instance might exist.

The fourth-level address of an organisation or business entity.

City

City is optional. A single instance might exist.

Name of the city associated with the address elements.

County

County is optional. A single instance might exist.

The name of the county that the address is in.

StateOrProvince

StateOrProvince is optional. A single instance might exist.

The political designation or boundary of a specific area of land.

PostalCode

PostalCode is optional. A single instance might exist.

The postal code associated with the address elements.

Country

Country is optional. A single instance might exist.

The name of the country associated with the address elements. To ensure reliable matching of addresses, it is suggested to use the attribute ISOCountryCode as well.

(choice)

[choice] is optional because of choice construct.

GPSCoordinates

GPSCoordinates is optional because of choice construct.

The location of the party as specified using a Global Positioning System.

MapCoordinates

MapCoordinates is optional because of choice construct.

A group item defining and containing position co-ordinates of a location.

NASTA [attribute]

Indicates if the specification must conform to the NASTA (National Association of State Textbook Administrators) requirements.

This item is restricted to the following list.

Yes

attribute	
NASTA	
type	yesNo
default	No

Book production must adhere to NASTA specifications.

No

Book production is not subject to NASTA specifications.

NaturalWoodSiding

Natural wood siding

(sequence)

The sequence of items below is mandatory. A single instance is required.

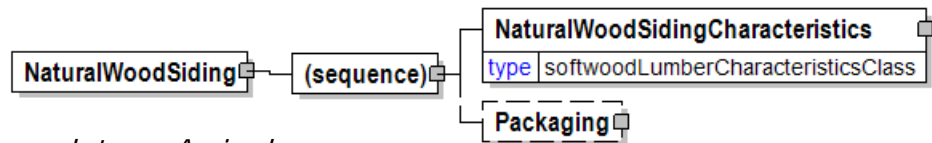

NaturalWoodSidingCharacteristics

NaturalWoodSidingCharacteristics is mandatory. A single instance is required.

Natural wood siding characteristics

Packaging

Packaging is optional. A single instance might exist.

Type of a package that includes individual products.

NaturalWoodSidingCharacteristics

Natural wood siding characteristics

(sequence)

The sequence of items below is mandatory. A single instance is required.

LumberSpecies

LumberSpecies is mandatory. One instance is required, multiple instances might exist.

Specifies the raw material species.

LumberGrade

LumberGrade is mandatory. A single instance is required.

Defines quality characteristics achieved by selecting pieces based on a grading rule.

Length

Length is optional.

The length of the object.

Width

Width is optional.

The width of the object.

Thickness

Thickness is optional.

Physical dimension of a product.

Seasoning

Seasoning is optional. A single instance might exist.

Describes drying/ moisture control method.

MoistureContent

MoistureContent is optional. A single instance might exist.

Defines the moisture content percentage of the product.

HeatTreatment

HeatTreatment is optional. A single instance might exist.

Defines the heat treatment method.

ManufacturingProcess

ManufacturingProcess is optional. Multiple instances might exist.

Defines the different machining and processes made for the product.

PatternProfile

PatternProfile is optional. A single instance might exist.

Defines the pattern used in machining the product.

Trim

Trim is optional. A single instance might exist.



Trim

Joining

Joining is optional. A single instance might exist.

Defines the method used to join pieces of wood.

PressureTreatment

PressureTreatment is optional. A single instance might exist.

Method and parameter values of pressure treatment.

FireTreatment

FireTreatment is optional. A single instance might exist.

Fire treatment

OtherTreatment

OtherTreatment is optional. A single instance might exist.

Other treatment

GradeStamp

GradeStamp is optional. A single instance might exist.

Grade stamp information

ExLog

ExLog is optional. A single instance might exist.

Describes the cutting pattern of the log.

ClassIdentifier

ClassIdentifier is optional. Multiple instances might exist.

Standard used for product identification.

Weight

Weight is optional. A single instance might exist.

The weight of the item.

LabelCharacteristics

LabelCharacteristics is optional. A single instance might exist.

A group item that organises the labeling information.

StencilCharacteristics

StencilCharacteristics is optional. A single instance might exist.

A group element specifying attributes of a stencil to be applied to an item, and optional text.

Wrap

Wrap is optional. A single instance might exist.

A group item that organises wrapping detail information.

SafetyAndEnvironmentalInformation

SafetyAndEnvironmentalInformation is optional. Multiple instances might exist.

Name of certification type, if any, on the goods (For example, FSC, PEFC). SafetyAndEnvironmental needs a value or measurement to communicate the percentage of the product is certified (for example, 75% is certified by the

indicated agency).

AdditionalText

AdditionalText is optional. Multiple instances might exist.

A text field that is used to communicate information not previously defined or for special instructions. To be used only for circumstances not covered by specific elements.

LengthCutDescription

LengthCutDescription is optional. A single instance might exist.

Length Cut Description

ShippingMark

ShippingMark is optional. A single instance might exist.

A shipping mark identifies the producer and quality on the end side of the product. Not to be mixed with company code/logo or other product marking.

NaturalWoodSiding-Other

Natural Wood Siding - Other

(sequence)

The

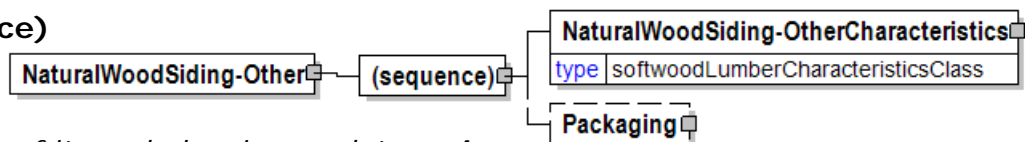

sequence of items below is mandatory. A single instance is required.

NaturalWoodSiding-OtherCharacteristics

NaturalWoodSiding-OtherCharacteristics is mandatory. A single instance is required.

Natural Wood Siding - Other Characteristics

Packaging

Packaging is optional. A single instance might exist.

Type of a package that includes individual products.

NaturalWoodSiding-OtherCharacteristics

Natural Wood Siding - Other Characteristics

(sequence)

The sequence of items below is mandatory. A single instance is required.

LumberSpecies

LumberSpecies is mandatory. One instance is required, multiple instances might exist.

Specifies the raw material species.

LumberGrade

LumberGrade is mandatory. A single instance is required.

Defines quality characteristics achieved by selecting pieces based on a grading rule.

Length

Length is optional.

The length of the object.

Width

Width is optional.

The width of the object.

Thickness

Thickness is optional.

Physical dimension of a product.

Seasoning

Seasoning is optional. A single instance might exist.

Describes drying/ moisture control method.

MoistureContent

MoistureContent is optional. A single instance might exist.

Defines the moisture content percentage of the product.

HeatTreatment

HeatTreatment is optional. A single instance might exist.

Defines the heat treatment method.

ManufacturingProcess

ManufacturingProcess is optional. Multiple instances might exist.

Defines the different machining and processes made for the product.

PatternProfile

PatternProfile is optional. A single instance might exist.

Defines the pattern used in machining the product.

Trim

Trim is optional. A single instance might exist.



Trim

Joining

Joining is optional. A single instance might exist.

Defines the method used to join pieces of wood.

PressureTreatment

PressureTreatment is optional. A single instance might exist.

Method and parameter values of pressure treatment.

FireTreatment

FireTreatment is optional. A single instance might exist.

Fire treatment

OtherTreatment

OtherTreatment is optional. A single instance might exist.

Other treatment

GradeStamp

GradeStamp is optional. A single instance might exist.

Grade stamp information

ExLog

ExLog is optional. A single instance might exist.

Describes the cutting pattern of the log.

ClassIdentifier

ClassIdentifier is optional. Multiple instances might exist.

Standard used for product identification.

Weight

Weight is optional. A single instance might exist.

The weight of the item.

LabelCharacteristics

LabelCharacteristics is optional. A single instance might exist.

A group item that organises the labeling information.

StencilCharacteristics

StencilCharacteristics is optional. A single instance might exist.

A group element specifying attributes of a stencil to be applied to an item, and optional text.

Wrap

Wrap is optional. A single instance might exist.

A group item that organises wrapping detail information.

SafetyAndEnvironmentalInformation

SafetyAndEnvironmentalInformation is optional. Multiple instances might exist.

Name of certification type, if any, on the goods (For example, FSC, PEFC). SafetyAndEnvironmental needs a value or measurement to communicate the percentage of the product is certified (for example, 75% is certified by the

indicated agency).

AdditionalText

AdditionalText is optional. Multiple instances might exist.

A text field that is used to communicate information not previously defined or for special instructions. To be used only for circumstances not covered by specific elements.

LengthCutDescription

LengthCutDescription is optional. A single instance might exist.

Length Cut Description

ShippingMark

ShippingMark is optional. A single instance might exist.

A shipping mark identifies the producer and quality on the end side of the product. Not to be mixed with company code/logo or other product marking.

NetAmount

An element that contains the net amount excluding tax. Adjustments are included in NetAmount.

NetAmount encapsulates CurrencyValue.

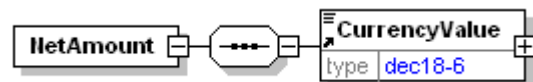

(sequence)

The sequence of items below is mandatory. A single instance is required.

CurrencyValue

CurrencyValue is mandatory. A single instance is required.

The amount in the referenced currency as defined by the CurrencyType attribute.

NetChargeAmount

A field containing the sum of all instances of the Complaint charges.

(sequence)

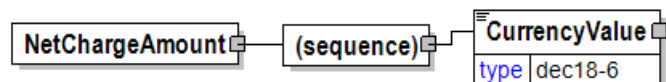

The sequence of items below is mandatory. A single instance is required.

CurrencyValue

CurrencyValue is mandatory. A single instance is required.

The amount in the referenced currency as defined by the CurrencyType attribute.

NoiseReduction [attribute]

The noise reduction method

This item is restricted to the following list.

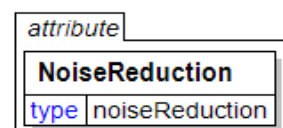

DolbyB

A simplified version of type A noise reduction targeted towards consumer recording equipment.

DolbyC

An improvement of the B type consumer technology filters result in 20 dB of noise reduction but still confined 1KHz and over typically found built into mid and high end cassette recorders.

DolbyS

A multiband consumer version of the Dolby system.

None

NonPressComponent

Non-press component.

(choice)

[choice] is optional because of choice construct.

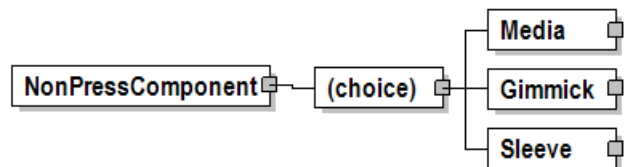

Media

Media is optional because of choice construct.

Media.

Gimmick

Gimmick is optional because of choice construct.

Gimmick

Sleeve

Sleeve is optional because of choice construct.

Sleeve.

NonStandardPulp

The characteristics of the form that pulp in a nonstandard presentation takes.

(sequence)

The sequence of items below is mandatory. A single instance is required.

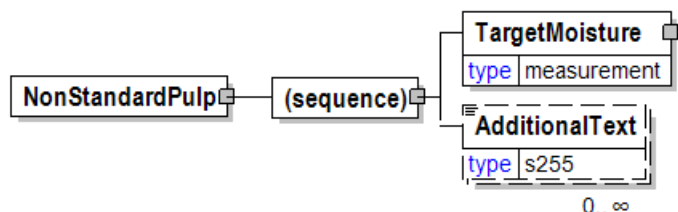

TargetMoisture

TargetMoisture is mandatory. A single instance is required.

The moisture target for the product being specified.

AdditionalText

AdditionalText is optional. Multiple instances might exist.

A text field that is used to communicate information not previously defined or for special instructions. To be used only for circumstances not covered by specific

elements.

NumberOfAttachments

NumberOfAttachments indicates the number of attachments enclosed in the e-Document

NumberOfAttachments	
type	nni3

NumberOfBands

The number of bands to be applied to the package.

NumberOfBands	
type	nni2

NumberOfBindComponents

Total number of components contained in the book block.

NumberOfBindComponents	
type	nni4

NumberOfColours

The number of colours

NumberOfColours	
type	nni4

NumberOfComplaintLineItemDetail

The number of ComplaintLineItemDetail elements for a given ComplaintLineItem (Example: the number of reels in a ComplaintLineItem)

NumberOfComplaintLineItemDetail	
type	nni4

NumberOfComplaintResponseLineItemDetail

The number of ComplaintResponseLineItemDetail elements for a given ComplaintResponseLineItem

NumberOfComplaintResponseLineItemDetail	
type	nni4

NumberOfDocuments

Specifies the number of documents needed.

Original [attribute]

Original is optional. A single instance might exist.

Either "Yes" or "No".

NumberOfDocuments	
type	nni2

attributes	
Original	
type	yesNo

papiNet V2R31

Refer to Original definition for any enumerations.

NumberOfDocumentsRequired

The number of copies of the document required.

NumberOfDocumentsRequired	
type	nni2

NumberOfGoodsReceiptPackages

A count of the number of packages detailed in the GoodsReceiptLineItem.

NumberOfGoodsReceiptPackages	
type	nni4

NumberOfHits

The number of hits

NumberOfHits	
type	nni4

NumberOfHoles

The number of holes punched in a sheet of paper.

NumberOfHoles	
type	nni3

NumberOfInventoryChangeLineItemDetails

The number of InventoryChangeLineItemDetail elements included in the InventoryChangeLineItem.

NumberOfInventoryChangeLineItemDetails	
type	nni4

NumberOfInventoryStatusLineItemDetails

The number of InventoryStatusLineItemDetail elements included in the InventoryStatusLineItem.

NumberOfInventoryStatusLineItemDetails	
type	nni4

NumberOfItemMeasuringInfo

Number of reported items by ItemMeasuringInfo.

NumberOfItemMeasuringInfo	
type	nni6

papiNet V2R31

NumberOfLabels

The number of labels to be placed on the package.

NumberOfLabels	
type	nni2

NumberOfMillJoins

The number of joins in the reel.

NumberOfMillJoins	
type	nni1

NumberOfPackages

The number of packages in the delivery.

NumberOfPackages	
type	nni4

NumberOfPackingListItems

The number of PackingList items in a PackingUnit of the PackingList.

NumberOfPackingListItems	
type	nni3

NumberOfPages

The number of pages.

NumberOfPages	
type	nni6

NumberOfPlies

The number of layers of paper product joined together to make the final saleable product.

NumberOfPlies	
type	nni1

NumberOfRibbons

The number of ribbons.

NumberOfRibbons	
type	nni2

NumberOfSides

The number of sides.

NumberOfSides	
type	nni2

NumberOfSignatures

The number of signatures.

NumberOfSignatures	
type	nni4

NumberOfUncompletedMeasuredItems

Specifies the number of items that are uncompleted measured, i.e. some measurement values are missing for these items.

NumberOfUncompletedMeasuredItems	
type	nni6

NumberOfWraps

The number of turns of wrapping material to be applied to the package.

NumberOfWraps	
type	dec03-2

NumberOrderDocumentRequired

There are certain business cases whereby a party is required to reference external documents to the transaction. Additionally, in these cases, the party is required to communicate the number of these external documents. This element is used to indicate how many of these external documents will be required. Typically used to indicate how many hard copies of the referenced document are needed.

NumberOrderDocumentRequired	
type	nni2

NumberPerProduct

The number of components or items per assembly or constructed product

NumberPerProduct	
type	dec18-8

NumericValue

A grouping element for a numeric value and its statistical measures.

(sequence)

The sequence of items below is mandatory. A single instance is required.

DetailValue

DetailValue is mandatory. A single instance is required.

A numeric value expressed in the unit of measure (UOM).

DetailRangeMin

DetailRangeMin is optional. A single instance might exist.

The minimum value (lower boundary) allowed for the DetailValue that is the parent of this element.

DetailRangeMax

DetailRangeMax is optional. A single instance might exist.

The maximum value (upper boundary) allowed for the DetailValue that is the parent of this element.

StandardDeviation

StandardDeviation is optional. A single instance might exist.

A statistic used as a measure of dispersion in a distribution.

SampleSize

SampleSize is optional. A single instance might exist.

The number of samples used to determine the product characteristic in question.

TwoSigmaLower

TwoSigmaLower is optional. A single instance might exist.

Two sigma (a measure of dispersion associated with standard deviation) on the lower side of the standard deviation.

TwoSigmaUpper

TwoSigmaUpper is optional. A single instance might exist.

Two sigma (a measure of dispersion associated with standard deviation) on the upper side of the standard deviation.

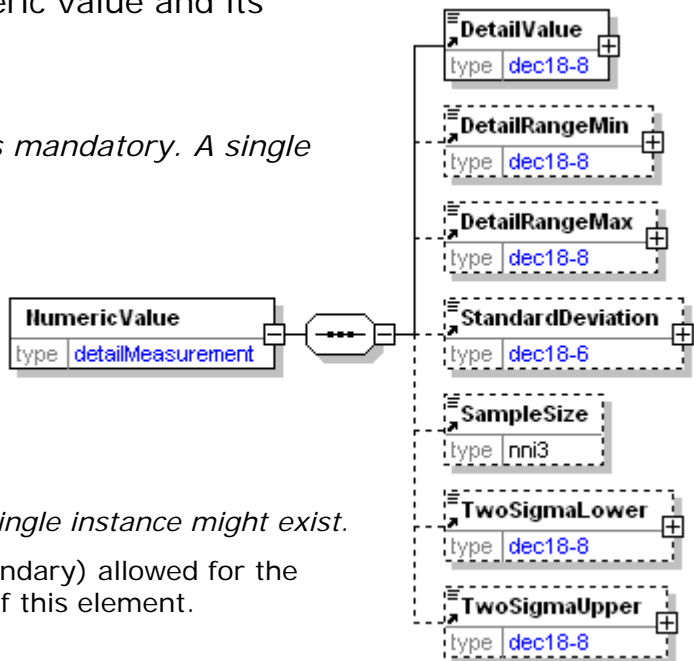

Old InformationalQuantity

What the InformationalQuantity was prior to the event described taking place.

QuantityType [attribute]

QuantityType is mandatory. A single instance is required.



QuantityType communicates information about the type of quantity being communicated and how the receiver might use the information.

Refer to QuantityType definition for any enumerations.

QuantityTypeContext [attribute]

QuantityTypeContext is optional. A single instance might exist.

Provides the location in the value chain where the quantity is being reported.

Refer to QuantityTypeContext definition for any enumerations.

AdjustmentType [attribute]

AdjustmentType is optional. A single instance might exist.

Describes the type of adjustment associated with a quantity.

Refer to AdjustmentType definition for any enumerations.

MeasuringMethodType [attribute]

MeasuringMethodType is optional. A single instance might exist.

Specifies how a measurement value is created.

Refer to MeasuringMethodType definition for any enumerations.

MeasuringAgency [attribute]

MeasuringAgency is optional. A single instance might exist.

The agency defining measuring methods.

Refer to MeasuringAgency definition for any enumerations.

MeasuringMethod [attribute]

MeasuringMethod is optional. A single instance might exist.

The method used to determine how the item under consideration is measured. Measuring methods are defined by the measuring agency.

(sequence)

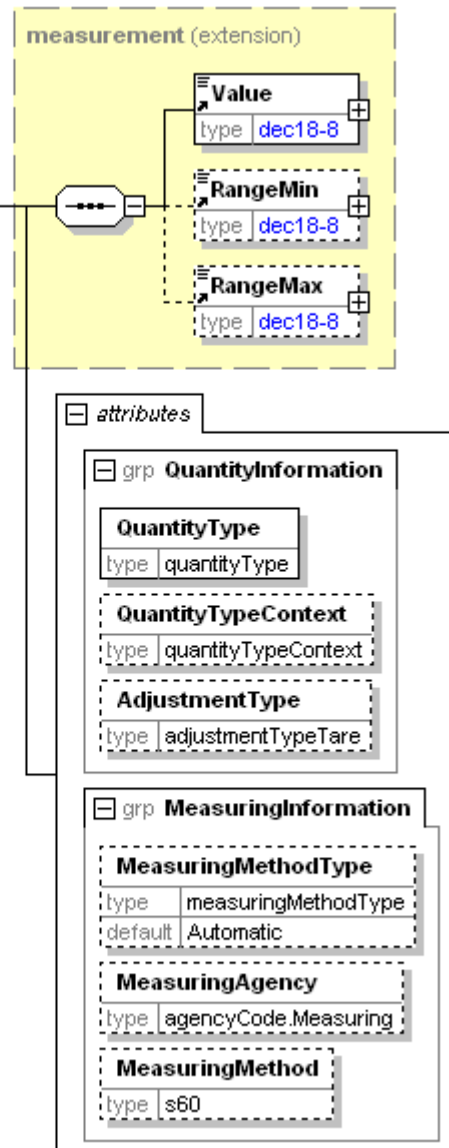

The sequence of items below is mandatory. A single instance is required.

Value

Value is mandatory. A single instance is required.

A numeric value expressed in the unit of measure (UOM).

RangeMin

RangeMin is optional. A single instance might exist.

The minimum value (lower boundary) allowed for the Measurement that is the parent of this element.

RangeMax

RangeMax is optional. A single instance might exist.

The maximum value (upper boundary) allowed for the Measurement that is the parent of this element. Some elements use the RangeMax element with an extended list of unit of measures. (Note: the red colour in the picture is an artifact of how the graphic was captured and should be disregarded.)

OldInventoryClass

A group item containing information about what the InventoryClass was prior to the event described taking place.

InventoryStatusType

OldInventoryClass

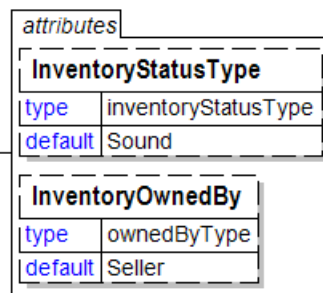

[attribute]

InventoryStatusType is optional. A single instance might exist.

Provides the status type for inventory/goods belonging to a product and/or an order.

Refer to InventoryStatusType definition for any enumerations.

InventoryOwnedBy [attribute]

InventoryOwnedBy is optional. A single instance might exist.

Specifies who is the owner of the inventory/goods.

Refer to InventoryOwnedBy definition for any enumerations.

(sequence)

The sequence of items below is mandatory. A single instance is required.

(sequence)

The sequence of items below is optional. Multiple instances might exist.

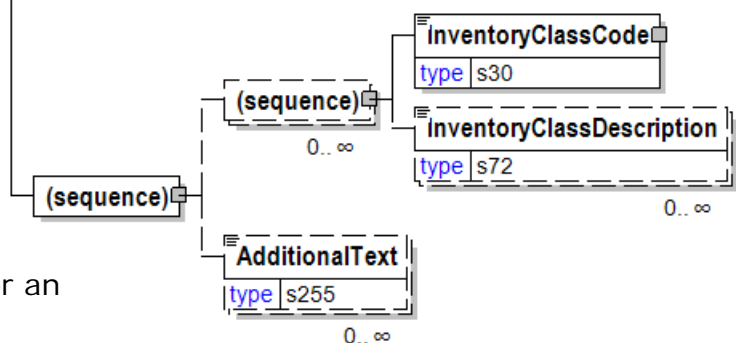

InventoryClassCode

InventoryClassCode is mandatory. A single instance is required.

A code specifying the inventory and goods status. Classification of statuses can be done on multiple levels indicated by InventoryClassLevel.

InventoryClassDescription

InventoryClassDescription is optional. Multiple instances might exist.

A description of the inventory class.

AdditionalText

AdditionalText is optional. Multiple instances might exist.

A text field that is used to communicate information not previously defined or for special instructions. To be used only for circumstances not covered by specific elements.

OldQuantity

What the Quantity was prior to the event described taking place

QuantityType [attribute]

QuantityType is mandatory. A single instance is required.

QuantityType communicates information about the type of quantity being communicated and how the receiver might use the information.

Refer to QuantityType definition for any enumerations.

QuantityTypeContext [attribute]

QuantityTypeContext is optional. A single instance might exist.

Provides the location in the value chain where the quantity is being reported.

Refer to QuantityTypeContext definition for any enumerations.

AdjustmentType [attribute]

AdjustmentType is optional. A single instance might exist.

Describes the type of adjustment associated with a quantity.

Refer to AdjustmentType definition for any enumerations.

MeasuringMethodType [attribute]

MeasuringMethodType is optional. A single instance might exist.

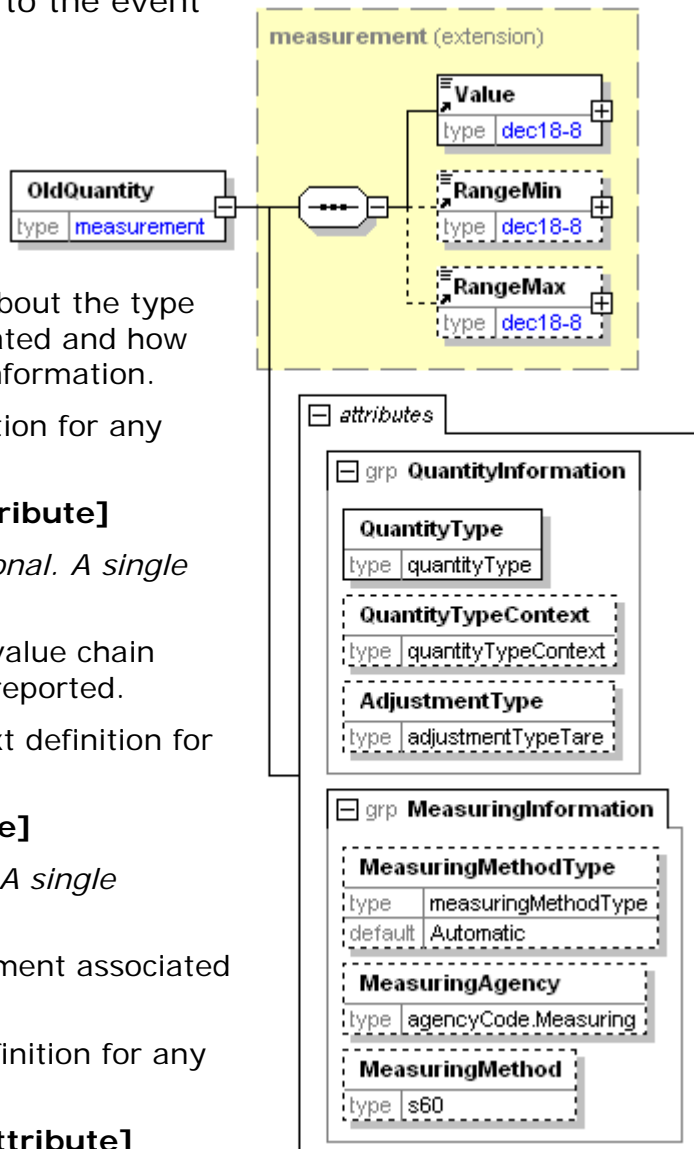

instance might exist.

Specifies how a measurement value is created.

Refer to MeasuringMethodType definition for any enumerations.

MeasuringAgency [attribute]

MeasuringAgency is optional. A single instance might exist.

The agency defining measuring methods.

Refer to MeasuringAgency definition for any enumerations.

MeasuringMethod [attribute]

MeasuringMethod is optional. A single instance might exist.

The method used to determine how the item under consideration is measured. Measuring methods are defined by the measuring agency.

(sequence)

The sequence of items below is mandatory. A single instance is required.

Value

Value is mandatory. A single instance is required.

A numeric value expressed in the unit of measure (UOM).

RangeMin

RangeMin is optional. A single instance might exist.

The minimum value (lower boundary) allowed for the Measurement that is the parent of this element.

RangeMax

RangeMax is optional. A single instance might exist.

The maximum value (upper boundary) allowed for the Measurement that is the parent of this element. Some elements use the RangeMax element with an extended list of unit of measures. (Note: the red colour in the picture is an artifact of how the graphic was captured and should be disregarded.)

Opacity

A group item used to communicate opacity target or test value according to a particular TestMethod.

TestMethod [attribute]

TestMethod is optional. A single instance might exist.

The method used to determine the results of the test under consideration.

TestAgency [attribute]

TestAgency is optional. A single instance might exist.

The agency that has set the parameters for the testing

Refer to TestAgency definition for any enumerations.

SampleType [attribute]

SampleType is optional. A single instance might exist.

Communicates how sampling was done to measure the product characteristics.

Refer to SampleType definition for any enumerations.

ResultSource [attribute]

ResultSource is optional. A single instance might exist.

Used to define the data source of the specified test

Refer to ResultSource definition for any enumerations.

(sequence)

The sequence of items below is mandatory. A single instance is required.

DetailValue

DetailValue is mandatory. A single instance is required.

A numeric value expressed in the unit of measure (UOM).

DetailRangeMin

DetailRangeMin is optional. A single instance might exist.

The minimum value (lower boundary) allowed for the DetailValue that is the parent of this element.

DetailRangeMax

DetailRangeMax is optional. A single instance might exist.

The maximum value (upper boundary) allowed for the DetailValue that is the parent of this element.

StandardDeviation

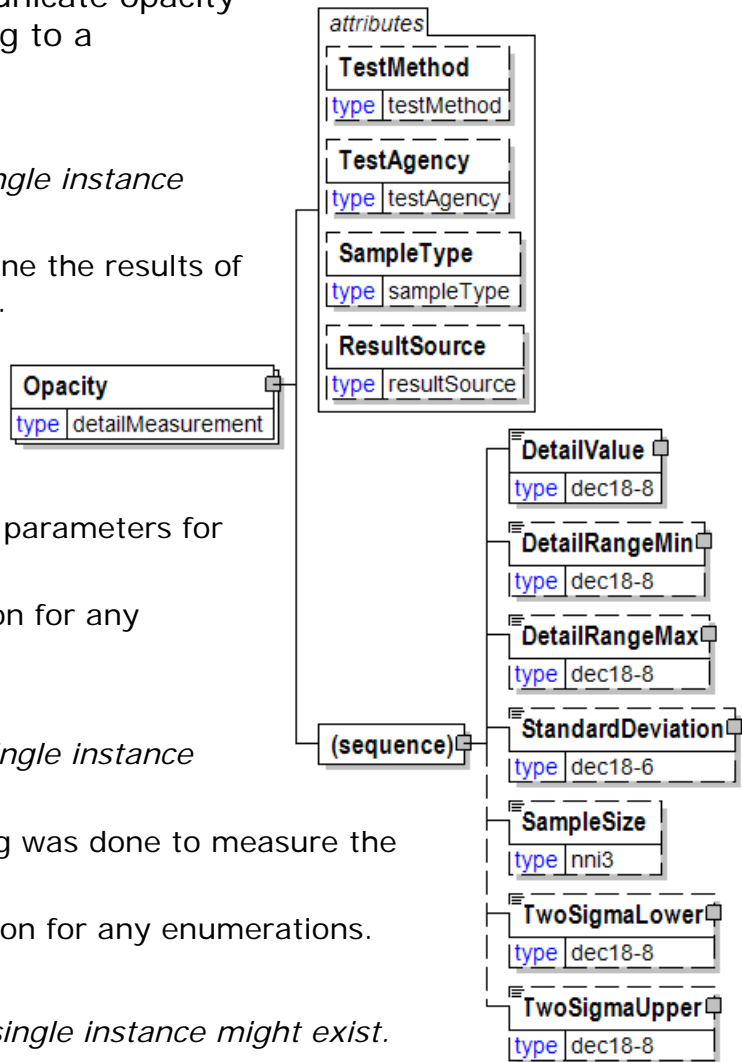

StandardDeviation is optional. A single instance might exist.

A statistic used as a measure of dispersion in a distribution.

SampleSize

SampleSize is optional. A single instance might exist.

The number of samples used to determine the product characteristic in question.

TwoSigmaLower

TwoSigmaLower is optional. A single instance might exist.

Two sigma (a measure of dispersion associated with standard deviation) on the lower side of the standard deviation.

TwoSigmaUpper

TwoSigmaUpper is optional. A single instance might exist.

Two sigma (a measure of dispersion associated with standard deviation) on the upper side of the standard deviation.

OrderConfirmation

The OrderConfirmation element is the root element for the OrderConfirmation e-Document.

A seller sends an OrderConfirmation e-Document to a buyer after receiving a PurchaseOrder from that buyer. The e-Document contains a response to the conditions specified in the PurchaseOrder. A supplier may also send an OrderConfirmation e-Document to convey changes that the supplier has made in the order or to convey new information such as a Supplier Reference Number or Job Number.

OrderConfirmation

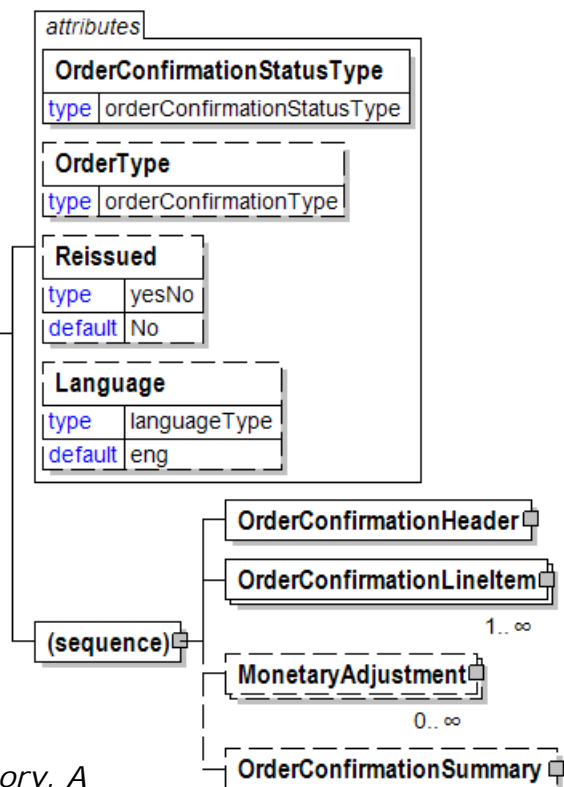

OrderConfirmationStatusType [attribute]

OrderConfirmationStatusType is mandatory. A single instance is required.

Identifies the status of the whole OrderConfirmation e-Document (i.e. at the root level)

Refer to OrderConfirmationStatusType definition for any enumerations.

OrderType [attribute]

OrderType is optional. A single instance might exist.

Defines the type of OrderConfirmation being communicated.

Refer to OrderType definition for any enumerations.

Reissued [attribute]

Reissued is optional. A single instance might exist.

Either "Yes" or "No".

Refer to Reissued definition for any enumerations.

Language [attribute]

Language is optional. A single instance might exist.

XML has embraced 2 and 3 digit language codes through the application of an addendum to the standard.

Refer to Language definition for any enumerations.

(sequence)

The sequence of items below is mandatory. A single instance is required.

OrderConfirmationHeader

OrderConfirmationHeader is mandatory. A single instance is required.

Information that is common to all items on the OrderConfirmation.

OrderConfirmationLineItem

OrderConfirmationLineItem is mandatory. One instance is required, multiple instances might exist.

The detail of the items that are communicated in the OrderConfirmation e-Document.

MonetaryAdjustment

MonetaryAdjustment is optional. Multiple instances might exist.

The element containing the information necessary for the understanding, calculation, and treatment of an adjustment to a currency amount. MonetaryAdjustment contains an attribute that indicates they type of adjustment being communicated.

OrderConfirmationSummary

OrderConfirmationSummary is optional. A single instance might exist.

Summary information that applies to the whole OrderConfirmation e-Document.

OrderConfirmationHeader

Information that is common to all items on the OrderConfirmation.

OrderConfirmationHeaderStatusType [attribute]

OrderConfirmationHeaderStatusType is mandatory. A single instance is required.

An attribute defining the status of the OrderConfirmation header

Refer to

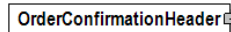

OrderConfirmationHeaderStatusType definition for any enumerations.

(sequence)

The sequence of items below is mandatory. A single instance is required.

OrderConfirmationNumber

OrderConfirmationNumber is optional. A single instance might exist.

The unique order identifier as designated by the seller.

OrderConfirmationHeaderStatusTypeText

OrderConfirmationHeaderStatusTypeText is optional. A single instance might exist.

A text field that may provide detail explaining the status of the OrderConfirmationHeader.

This field is required if the OrderConfirmationHeaderStatusType is "Rejected".

When the OrderConfirmationHeaderStatusType is "Pending", the reason can be specified in this field.

Not required if the PurchaseOrder is "Accepted".

OrderConfirmationIssuedDate

OrderConfirmationIssuedDate is mandatory. A single instance is required.

The Date and optionally the Time that the OrderConfirmation was issued.

TransactionHistoryNumber

TransactionHistoryNumber is optional. A single instance might exist.

A sequential number that keeps track of the version of a document being sent by the document originator except in the case where TransactionHistoryConfirmation is used, in which case the TransactionHistoryNumber refers to the trigger transaction for which the confirmation is being sent.

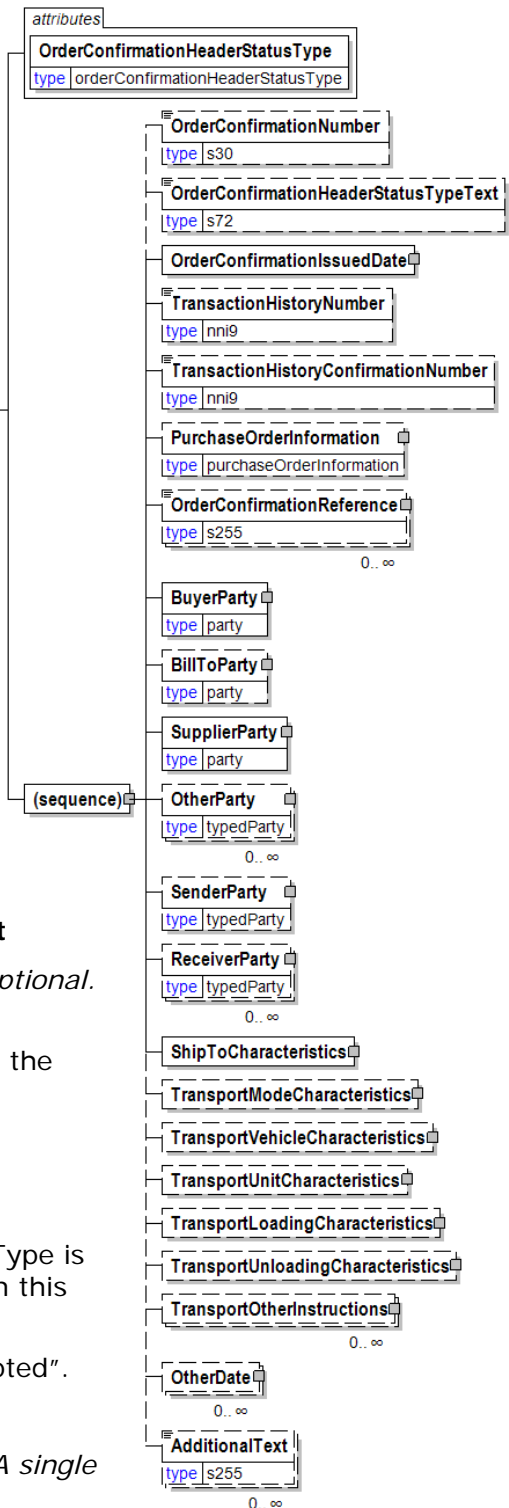

TransactionHistoryConfirmationNumber

TransactionHistoryConfirmationNumber is optional. A single instance might exist.

A sequential number that indicates the version of the confirmation document being sent.

PurchaseOrderInformation

PurchaseOrderInformation is optional. A single instance might exist.

A group item containing information unique to this PurchaseOrder, which is provided by the buyer. PurchaseOrderInformation can be optional in the supply chain. Invoices are created without having a PurchaseOrder in Vendor Managed Inventory. Freight invoices also will not have a PurchaseOrder number.

OrderConfirmationReference

OrderConfirmationReference is optional. Multiple instances might exist.

A group item detailing relevant references pertaining to the OrderConfirmation. Typically, the ContractNumber is referenced. OrderConfirmationReferenceType provides the identification of what the reference represents.

BuyerParty

BuyerParty is mandatory. A single instance is required.

The legal entity to which the product is sold. Also commonly referred to as the sold-to party or customer. If no OtherParty is defined as the Payer, the Buyer is the Payer.

BillToParty

BillToParty is optional. A single instance might exist.

The address where the invoice is to be sent.

SupplierParty

SupplierParty is mandatory. A single instance is required.

The organisation or business entity responsible for providing the product. SupplierParty is also the seller of the product, if Seller is not specified as OtherParty = Seller.

OtherParty

OtherParty is optional. Multiple instances might exist.

An organisation or business entity other than those specifically detailed within a e-Document.

SenderParty

SenderParty is optional. A single instance might exist.

The business entity issuing the e-Document, the source of the document.

The entity responsible for the content. If the sender party has out sourced the message service to a third party the SenderParty is the issuer of the e-Document and not the party performing the transmission service of the electronic message.

ReceiverParty

ReceiverParty is optional. Multiple instances might exist.

The business entity for whom the e-Document is intended, the destination of the document.

The entity interested in the content. If the receiver party has outsourced the

message service to a third party the ReceiverParty is the intended party for the e-Document and not the party performing the receiving service of the electronic message.

ShipToCharacteristics

ShipToCharacteristics is mandatory. A single instance is required.

A group item that provides information important for the Ship-To Party.

A group item that provides information important for the Ship-To Party. ShipToCharacteristics may be referenced at both the header and line item level. The reference at the header is required and acts as a default for the value at the line level, unless overridden at the line level.

TransportModeCharacteristics

TransportModeCharacteristics is optional. A single instance might exist.

A group item defining the primary mode of transport.

TransportVehicleCharacteristics

TransportVehicleCharacteristics is optional. A single instance might exist.

A group item defining the primary means of transporting the goods, such as a side port vessel. In some instances, the transport unit and vehicle are the same.

TransportUnitCharacteristics

TransportUnitCharacteristics is optional. A single instance might exist.

A group item defining and identifying the primary means of containing the goods. In some instances, the transport unit and vehicle are the same.

TransportLoadingCharacteristics

TransportLoadingCharacteristics is optional. A single instance might exist.

A group item defining how the transported items are to be loaded.

TransportUnloadingCharacteristics

TransportUnloadingCharacteristics is optional. A single instance might exist.

A group item defining how the transported items are to be unloaded.

TransportOtherInstructions

TransportOtherInstructions is optional. Multiple instances might exist.

A group item defining any other instructions for the transport not covered in the description of transport mode, vehicle, unit, and loading characteristics or defining an alternative description for the categories mentioned above.

OtherDate

OtherDate is optional. Multiple instances might exist.

A date that may not be specifically detailed within a document (example: print date at the PurchaseOrderLineItem).

AdditionalText

AdditionalText is optional. Multiple instances might exist.

A text field that is used to communicate information not previously defined or for special instructions. To be used only for circumstances not covered by specific elements.

OrderConfirmationHeaderStatusType [attribute]

An attribute defining the status of the OrderConfirmation header

This item is restricted to the following list.

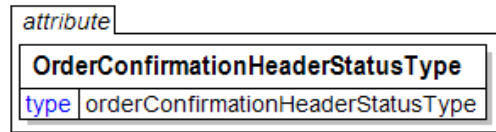

Accepted

The supplied information is accepted.

Amended

The supplied information is changed.

Cancelled

The supplied information has been cancelled. Items that have been cancelled are not included in totals on the summary levels of the e-Document.

NoAction

The supplied information has not been amended and thereby requires no action.

Pending

The supplied information is not complete and will be updated later.

Rejected

The supplied information is rejected.

OrderConfirmationHeaderStatusTypeText

A text field that may provide detail explaining the status of the OrderConfirmationHeader.

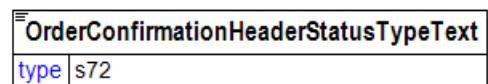

This field is required if the OrderConfirmationHeaderStatusType is "Rejected".

When the OrderConfirmationHeaderStatusType is "Pending", the reason can be specified in this field.

Not required if the PurchaseOrder is "Accepted".

OrderConfirmationIssuedDate

The Date and optionally the Time that the OrderConfirmation was issued.

(sequence)

The sequence of items below is mandatory. A single instance is required.

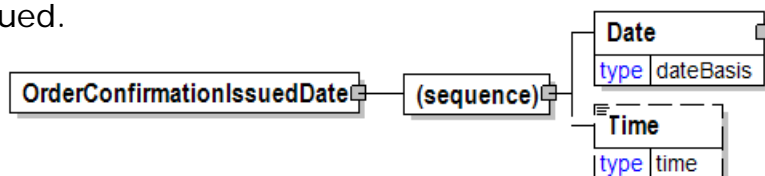

Date

Date is mandatory. A single instance is required.

papiNet V2R31

A group element that contains the specification of Year, Month, and Day.

Time

Time is optional. A single instance might exist.

Times are treated in a standard XML fashion with a special case used to indicate a generalized "local" time. The standard XML approach to time is hh:mm:ss, hh:mm:ssZ, or hh:mm:ss±hh:mm.

hh:mm:ss±hh:mm is used to represent a time with a time zone. The time zone is communicated as the number of hours offset from the Universal Time Coordinate (UTC), a.k.a. Greenwich Mean Time.

hh:mm:ssZ indicates the time at Zulu (another name for UTC). Based on the convention described in the next bullet it will be important for users within UTC to use "Z" when communicating a time in their time zone to other users.

hh:mm:ss or hh:mm indicates in the XML standard the time at UTC however, within papiNet it is used to represent the applicable local time. Caution should be used when processing times of this nature as the papiNet approach may be in discord with other users of XML.

OrderConfirmationLineItem

The detail of the items that are communicated in the OrderConfirmation e-Document.

OrderConfirmationLineItemStatusType [attribute]

OrderConfirmationLineItemStatusType is mandatory. A single instance is required.

Defines the status of the OrderConfirmation line item

Refer to OrderConfirmationLineItemStatusType definition for any enumerations.

OrderConfirmationLineItemDocumentStatus [attribute]

OrderConfirmationLineItemDocumentStatus is optional. A single instance might exist.

Defines the actual document status for the OrderConfirmationLineItem.

Refer to OrderConfirmationLineItemDocumentStatus definition for any enumerations.

Billable [attribute]

Billable is optional. A single instance might exist.

Either "Yes" or "No".

Refer to Billable definition for any enumerations.

(sequence)

The sequence of items below is mandatory. A single instance is required.

OrderConfirmationLineItemNumber

OrderConfirmationLineItemNumber is optional. A single instance might exist.

The sequential number that uniquely identifies the OrderConfirmation line item.

OrderConfirmationLineItemStatusTypeText

OrderConfirmationLineItemStatusTypeText is optional. A single instance might exist.

A text field that may provide detail explaining the status of the OrderConfirmationLineItem.

When a PurchaseOrderLineItem is rejected, the reason for the rejection must be specified in this field.

Not required if the PurchaseOrder is accepted or no changes have been made.

If the item is pending, the reason may be specified here.

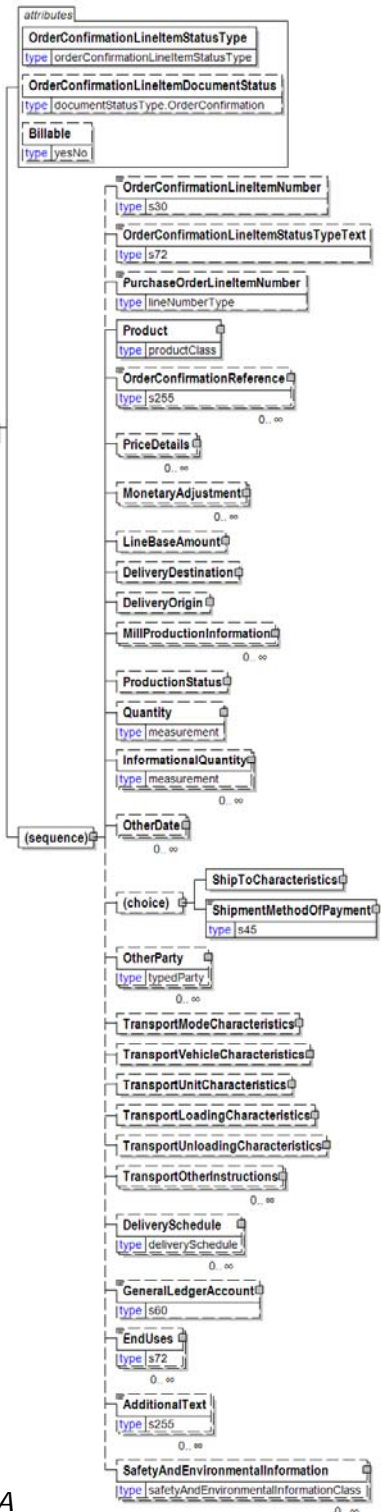

PurchaseOrderLineItemNumber

PurchaseOrderLineItemNumber is optional. A single instance might exist.

The sequential number that uniquely identifies the PurchaseOrder line item.

Product

Product is mandatory. A single instance is required.

Product is a group item defining the article and its characteristics. Product is used to specify product characteristics organized by ProductIdentifier, ProductDescription, and Classification. Book Manufacturing, Label Stock, Paper, Pulp, Recovered Paper, Wood Products, and Virgin Fibre market segments have defined their product characteristics and conversion features for implementation in papiNet.

OrderConfirmationReference

OrderConfirmationReference is optional. Multiple instances might exist.

A group item detailing relevant references pertaining to the OrderConfirmation. Typically, the ContractNumber is referenced. OrderConfirmationReferenceType provides the identification of what the reference represents.

PriceDetails

PriceDetails is optional. Multiple instances might exist.

An element that groups together price information.

MonetaryAdjustment

MonetaryAdjustment is optional. Multiple instances might exist.

The element containing the information necessary for the understanding, calculation, and treatment of an adjustment to a currency amount. MonetaryAdjustment contains an attribute that indicates the type of adjustment being communicated.

LineBaseAmount

LineBaseAmount is optional. A single instance might exist.

For the particular e-Document being communicated the LineBaseAmount represents the quantity times the base unit price.

DeliveryDestination

DeliveryDestination is optional. A single instance might exist.

The DeliveryDestination specifies the end of one leg of the delivery. In order to comply with the US Trade Act of 2002 you would use this element with a LocationParty/@PartyType of Port.

DeliveryOrigin

DeliveryOrigin is optional. A single instance might exist.

A group item that represents the start of one leg in a route. Compare to DeliveryDestination.

The DeliveryOrigin specifies the start of one leg of the delivery.

In order to comply with the US Trade Act of 2002 you would use this element with a LocationParty/@PartyType of Port.

MillProductionInformation

MillProductionInformation is optional. Multiple instances might exist.

A grouping element that contains information about production at the mill.

ProductionStatus

ProductionStatus is optional. A single instance might exist.

A group item used to communicate the release of a delivery line number.

Quantity

Quantity is optional. A single instance might exist.

The Quantity element contains attributes that provide information about the type of quantity that is being communicated, the context in which the particular quantity is to be viewed, and (if the quantity represents an adjustment) an adjustment type.

The Quantity element contains three child elements that enable you to communicate a range of values for the quantity and a target or actual value. It is at this level (Value, RangeMin, and RangeMax) that the unit of measure is specified. This permits the range to be specified in a different unit of measure than the target.

InformationalQuantity

InformationalQuantity is optional. Multiple instances might exist.

A quantity given in a valid UOM used for information purposes only (not for calculation). For example, an ordered quantity was 100 reels as opposed to the invoice quantity of 20,000 pounds.

OtherDate

OtherDate is optional. Multiple instances might exist.

A date that may not be specifically detailed within a document (example: print date at the PurchaseOrderLineItem).

(choice)

[choice] is optional because of choice construct.

ShipToCharacteristics

ShipToCharacteristics is optional because of choice construct.

A group item that provides information important for the Ship-To Party.

A group item that provides information important for the Ship-To Party. ShipToCharacteristics may be referenced at both the header and line item level. The reference at the header is required and acts as a default for the value at the line level, unless overridden at the line level.

ShipmentMethodOfPayment

ShipmentMethodOfPayment is optional because of choice construct.

An element communicating responsibility of freight payment and when transfer of ownership will occur.

OtherParty

OtherParty is optional. Multiple instances might exist.

An organisation or business entity other than those specifically detailed within a e-Document.

TransportModeCharacteristics

TransportModeCharacteristics is optional. A single instance might exist.

A group item defining the primary mode of transport.

TransportVehicleCharacteristics

TransportVehicleCharacteristics is optional. A single instance might exist.

A group item defining the primary means of transporting the goods, such as a side port vessel. In some instances, the transport unit and vehicle are the same.

TransportUnitCharacteristics

TransportUnitCharacteristics is optional. A single instance might exist.

A group item defining and identifying the primary means of containing the goods. In some instances, the transport unit and vehicle are the same.

TransportLoadingCharacteristics

TransportLoadingCharacteristics is optional. A single instance might exist.

A group item defining how the transported items are to be loaded.

TransportUnloadingCharacteristics

TransportUnloadingCharacteristics is optional. A single instance might exist.

A group item defining how the transported items are to be unloaded.

TransportOtherInstructions

TransportOtherInstructions is optional. Multiple instances might exist.

A group item defining any other instructions for the transport not covered in the description of transport mode, vehicle, unit, and loading characteristics or defining an alternative description for the categories mentioned above.

DeliverySchedule

DeliverySchedule is optional. Multiple instances might exist.

A group item defining a series of DeliveryDateWindow(s) in which specified quantities must be delivered.

GeneralLedgerAccount

GeneralLedgerAccount is optional. A single instance might exist.

The general ledger account to be referenced for the item.

EndUses

EndUses is optional. Multiple instances might exist.

A text element used to express in human readable form a list of applicable end uses for a product. Examples of end uses are:

- Magazine
- Book
- Commercial print
- etc

AdditionalText

AdditionalText is optional. Multiple instances might exist.

A text field that is used to communicate information not previously defined or for special instructions. To be used only for circumstances not covered by specific elements.

SafetyAndEnvironmentalInformation

SafetyAndEnvironmentalInformation is optional. Multiple instances might exist.

Name of certification type, if any, on the goods (For example, FSC, PEFC). SafetyAndEnvironmental needs a value or measurement to communicate the percentage of the product is certified (for example, 75% is certified by the indicated agency).

OrderConfirmationLineItemDocumentStatus [attribute]

Defines the actual document status for the OrderConfirmationLineItem.

This item is restricted to the following list.

attribute
OrderConfirmationLineItemDocumentStatus
type documentStatusType.OrderConfirmation

Cancelled

The supplied information of the document item is cancelled. Items that have been cancelled are not included in totals on the summary level of e-Documents.

Confirmed

The supplied information of the document item is agreed. If a requested change or cancellation of an existing document item can not be accepted, then the earlier agreed information of the document item will be re-confirmed.

Pending

The supplied information of the document item is being investigated.

Rejected

The supplied information of the document item can not be accepted. The document item is new or not earlier confirmed.

OrderConfirmationLineItemDocumentStatus [attribute]

Defines the actual document status for the OrderConfirmationLineItem.

This item is restricted to the following list.

attribute
OrderConfirmationLineItemDocumentStatus
type documentStatusType.OrderConfirmationWood

Cancelled

The supplied information of the document item is cancelled. Items that have been cancelled are not included in totals on the summary level of e-Documents.

Confirmed

The supplied information of the document item is agreed. If a requested change or cancellation of an existing document item can not be accepted, then the earlier agreed information of the document item will be re-confirmed.

Pending

The supplied information of the document item is being investigated.

Rejected

The supplied information of the document item can not be accepted. The document item is new or not earlier confirmed.

OrderConfirmationLineItemNumber

The sequential number that uniquely identifies the OrderConfirmation line item.

OrderConfirmationLineItemNumber
type s30

OrderConfirmationLineItemStatusType [attribute]

Defines the status of the OrderConfirmation line item

This item is restricted to the following list.

attribute
OrderConfirmationLineItemStatusType
type orderConfirmationLineItemStatusType

Accepted

The supplied information is accepted.

Amended

The supplied information is changed

Cancelled

The supplied information has been cancelled. Items that have been cancelled are not included in totals on the summary levels of the e-Document.

NoAction

The supplied information has not been amended and thereby requires no action.

Pending

The supplied information is not complete and will be updated later.

Rejected

The supplied information is rejected.

OrderConfirmationLineItemStatusTypeText

A text field that may provide detail explaining the status of the OrderConfirmationLineItem.

OrderConfirmationLineItemStatusTypeText
type s72

When a PurchaseOrderLineItem is rejected, the reason for the rejection must be specified in this field.

Not required if the PurchaseOrder is accepted or no changes have been made.

If the item is pending, the reason may be specified here.

OrderConfirmationNumber

The unique order identifier as designated by the seller.

OrderConfirmationNumber
type s30

OrderConfirmationReference

A group item detailing relevant references pertaining to the OrderConfirmation.

Typically, the ContractNumber is referenced.

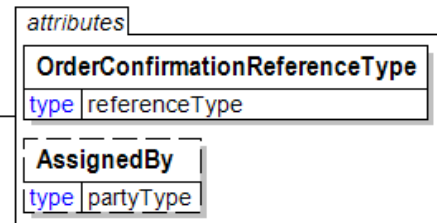
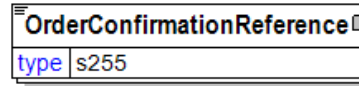

OrderConfirmationReferenceType provides the identification of what the reference represents.

OrderConfirmationReferenceType [attribute]

OrderConfirmationReferenceType is mandatory. A single instance is required.

Provides a contextual explanation of the specific reference identifier. Many items are currently prefixed by "Buyer", "Forwarder", "Manufacturer", "Mill", "Seller", "Supplier", "Warehouse", or "Vendor". Check for an existing non-prefixed version and use the non-prefixed version instead. In the (yet to be announced release date) version 3.0 the prefixed versions will be removed. Instead the attribute @AssignedBy will communicate the information previously communicated in the prefix.

Refer to OrderConfirmationReferenceType definition for any enumerations.

AssignedBy [attribute]

AssignedBy is optional. A single instance might exist.

Identifies the type of party that has assigned the associated item, e.g. a reference of type OrderNumber.

Refer to AssignedBy for any enumerations.

OrderConfirmationReferenceType [attribute]

Provides a contextual explanation of the specific reference identifier. Many items are currently prefixed by "Buyer", "Forwarder", "Manufacturer", "Mill", "Seller", "Supplier", "Warehouse", or "Vendor". Check for an

existing non-prefixed version and use the non-prefixed version instead. In the (yet to be announced release date) version 3.0 the prefixed versions will be removed. Instead the attribute @AssignedBy will communicate the information previously communicated in the prefix.

Refer to the [referenceType](#) entry for the list of enumerations and their definitions.

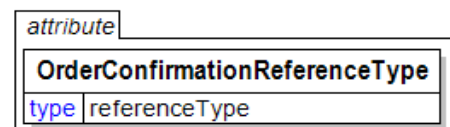

OrderConfirmationStatusType [attribute]

Identifies the status of the whole OrderConfirmation e-Document (i.e. at the root level)

This item is restricted to the following list.

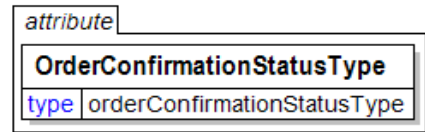

Accepted

The supplied information is accepted.

Amended

The supplied information is changed.

Cancelled

The supplied information has been cancelled. Items that have been cancelled are not included in totals on the summary levels of the e-Document.

Rejected

The supplied information is rejected.

OrderConfirmationSummary

Summary information that applies to the whole OrderConfirmation e-Document.

(sequence)

The sequence of items below is mandatory. A single instance is required.

TotalNumberOfLineItems

TotalNumberOfLineItems is optional. A single instance might exist.

The total number of individual line items in the document, regardless of the status or type.

(sequence)

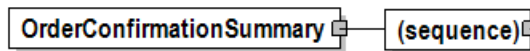

The sequence of items below is optional. Multiple instances might exist.

TotalQuantity

TotalQuantity is mandatory. A single instance is required.

The total quantity of similar items in the e-Document. TotalQuantity is primarily used in the summary section of documents where it is repeatable to permit totaling for different units of measure.

TotalInformationalQuantity

TotalInformationalQuantity is optional. Multiple instances might exist.

A quantity that is used to communicate related information about the parent element. This element represents a total that is derived from individual line items.

LineItemSubTotal

LineItemSubTotal is optional. A single instance might exist.

The total amount of all e-Document LineBaseAmount(s) line items without any monetary adjustments that may occur after the e-Document line items.

TotalAdjustments

TotalAdjustments is optional. A single instance might exist.

The CurrencyValue of TotalAdjustments contains the total of all MonetaryAdjustmentAmount for all instances of PriceAdjustment and FlatAmountAdjustment in the document (it excludes TaxAdjustments).

TotalTaxAmount

TotalTaxAmount is optional. A single instance might exist.

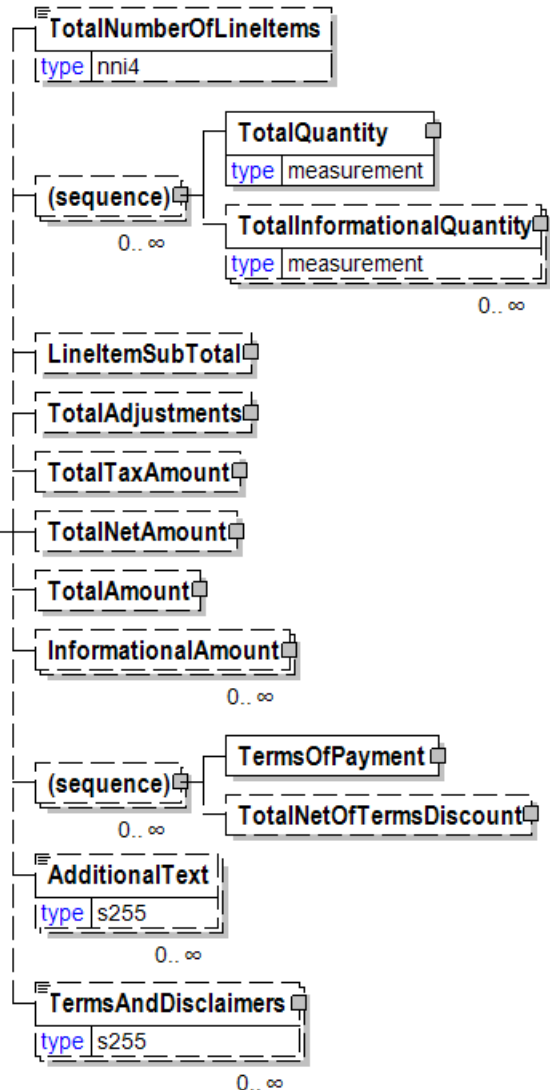

The CurrencyValue of TotalTaxAmount contains the sum of all instances of TaxAdjustment in the document. TotalTaxAmount contains the sum of all instances of the MonetaryAdjustmentAmount for tax adjustments.

TotalNetAmount

TotalNetAmount is optional. A single instance might exist.

A field containing total amount excluding tax. For example, in the Invoice TotalNetAmount is equal to the sum of LineItemSubTotal plus TotalAdjustments. TotalNetAmount encapsulates CurrencyValue.

TotalAmount

TotalAmount is optional. A single instance might exist.

The total amount including tax.

In e-Documents claiming payment this is the amount due for payment based on the terms of payment. Decimal rounding might be applied to this amount.

InformationalAmount

InformationalAmount is optional. Multiple instances might exist.

A monetary amount used for information purposes only (not for calculation). For example, the invoice price adjustment subtotal is expressed in sterling pounds, and the buyer wants this information expressed in U.S. dollars.

CreditDebitNote and Invoice - The TaxAmount is displayed in the currency that is applicable throughout the e-Document. When a TaxAmount needs to be displayed in a different national currency, this field is used.

(sequence)

The sequence of items below is optional. Multiple instances might exist.

TermsOfPayment

TermsOfPayment is mandatory. A single instance is required.

A group item that contains agreed-to terms defining when, how, and under what conditions the payment is to be made.

When TermsOfPayment is optional; if omitted, TermsOfPayment is controlled through previous negotiation.

TotalNetOfTermsDiscount

TotalNetOfTermsDiscount is optional. A single instance might exist.

The components of the amount to be paid if prompt payment discount terms are met, including the amount that is subject to the payment terms discount, the discount amount, and the amount due after prompt payment discount.

AdditionalText

AdditionalText is optional. Multiple instances might exist.

A text field that is used to communicate information not previously defined or for special instructions. To be used only for circumstances not covered by specific elements.

TermsAndDisclaimers

TermsAndDisclaimers is optional. Multiple instances might exist.

An element that contains legal information with an indication of what the Language is.

OrderConfirmationWood

The OrderConfirmationWood element is the root element for the OrderConfirmationWood e-Document.

A seller sends an OrderConfirmationWood e-Document to a buyer after receiving a PurchaseOrder from that buyer. The e-Document contains a response to the conditions specified in the PurchaseOrder. A supplier may also send an OrderConfirmationWood e-Document to convey changes that the supplier has made in the order or to convey new information such as a Supplier Reference Number or Job Number.

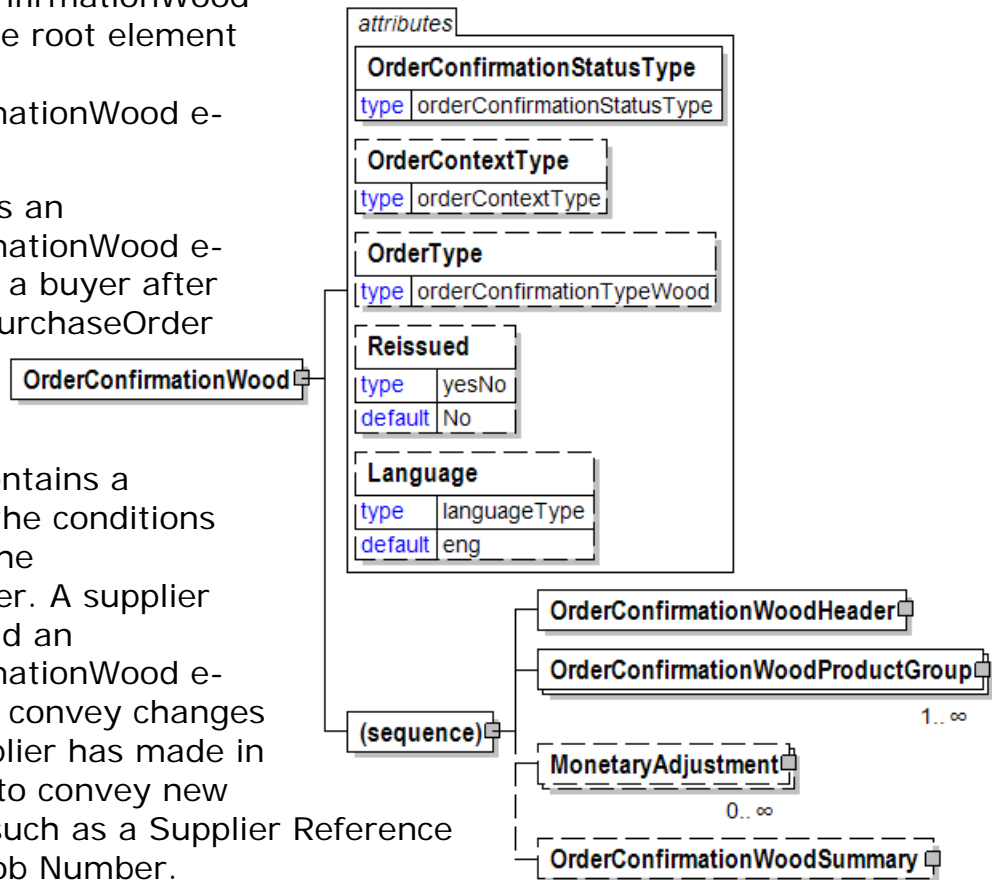

OrderConfirmationStatusType [attribute]

OrderConfirmationStatusType is mandatory. A single instance is required.

Identifies the status of the whole OrderConfirmation e-Document (i.e. at the root level)

Refer to OrderConfirmationStatusType definition for any enumerations.

OrderContextType [attribute]

OrderContextType is optional. A single instance might exist.

Qualifies the source of the PurchaseOrder.

Refer to OrderContextType definition for any enumerations.

OrderType [attribute]

OrderType is optional. A single instance might exist.

Defines the type of OrderConfirmationWood being communicated.

Refer to OrderType definition for any enumerations.

Reissued [attribute]

Reissued is optional. A single instance might exist.

Either "Yes" or "No".

Refer to Reissued definition for any enumerations.

Language [attribute]

Language is optional. A single instance might exist.

XML has embraced 2 and 3 digit language codes through the application of an addendum to the standard.

Refer to Language definition for any enumerations.

(sequence)

The sequence of items below is mandatory. A single instance is required.

OrderConfirmationWoodHeader

OrderConfirmationWoodHeader is mandatory. A single instance is required.

OrderConfirmationWoodHeader contains information that is consistent across the entire document.

OrderConfirmationWoodProductGroup

OrderConfirmationWoodProductGroup is mandatory. One instance is required, multiple instances might exist.

Group element used to potentially group like products together. Construct consists of a product group id, line items, and a product grouping summary.

MonetaryAdjustment

MonetaryAdjustment is optional. Multiple instances might exist.

The element containing the information necessary for the understanding, calculation, and treatment of an adjustment to a currency amount.

MonetaryAdjustment contains an attribute that indicates they type of adjustment being communicated.

OrderConfirmationWoodSummary

OrderConfirmationWoodSummary is optional. A single instance might exist.

Summary information that applies to the Wood market segment OrderConfirmationWood e-Document.

OrderConfirmationWoodHeader

OrderConfirmationWoodHeader contains information that is consistent across the entire document.

OrderConfirmationHeaderStatusType [attribute]

OrderConfirmationHeaderStatusType is mandatory. A single instance is required.

An attribute defining the status of the OrderConfirmationWood header

Refer to

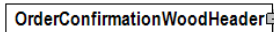

OrderConfirmationHeaderStatusType definition for any enumerations.

(sequence)

The sequence of items below is mandatory. A single instance is required.

OrderConfirmationNumber

OrderConfirmationNumber is optional. A single instance might exist.

The unique order identifier as designated by the seller.

OrderConfirmationHeaderStatusTypeText

OrderConfirmationHeaderStatusTypeText is optional. A single instance might exist.

A text field that may provide detail explaining the status of the OrderConfirmationHeader.

This field is required if the OrderConfirmationHeaderStatusType is "Rejected".

When the OrderConfirmationHeaderStatusType is "Pending", the reason can be specified in this field.

Not required if the PurchaseOrder is "Accepted".

OrderConfirmationIssuedDate

OrderConfirmationIssuedDate is mandatory. A single instance is required.

The Date and optionally the Time that the OrderConfirmation was issued.

TransactionHistoryNumber

TransactionHistoryNumber is optional. A single instance might exist.

A sequential number that keeps track of the version of a document being sent by the document originator except in the case where TransactionHistoryConfirmation is used, in which case the TransactionHistoryNumber refers to the trigger

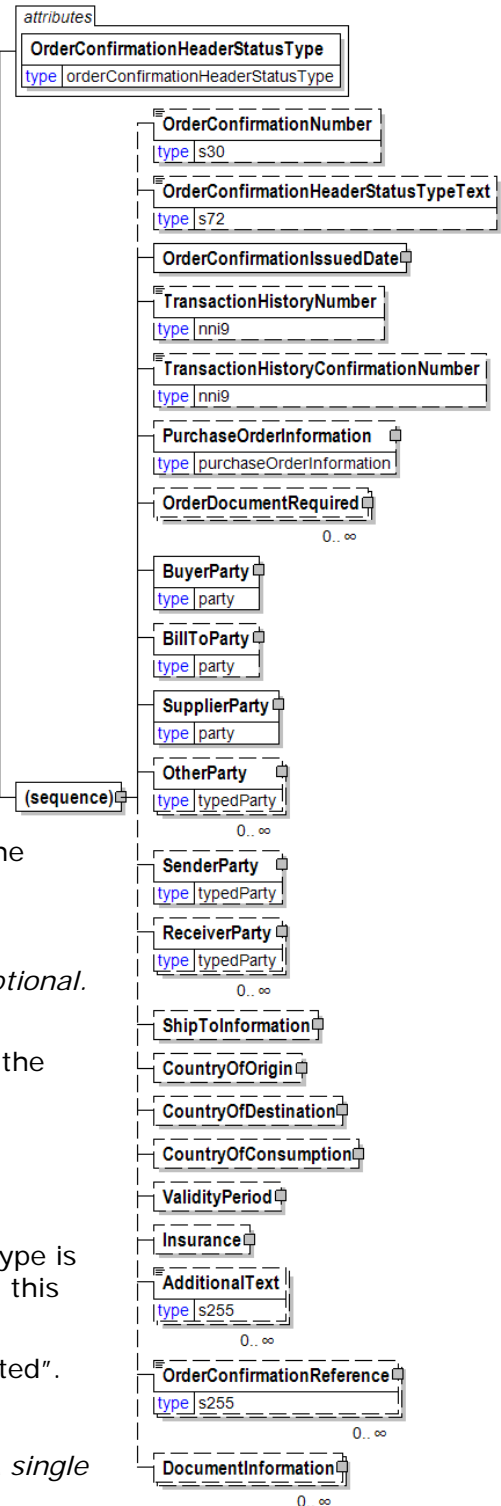

transaction for which the confirmation is being sent.

TransactionHistoryConfirmationNumber

TransactionHistoryConfirmationNumber is optional. A single instance might exist.

A sequential number that indicates the version of the confirmation document being sent.

PurchaseOrderInformation

PurchaseOrderInformation is optional. A single instance might exist.

A group item containing information unique to this PurchaseOrder, which is provided by the buyer. PurchaseOrderInformation can be optional in the supply chain. Invoices are created without having a PurchaseOrder in Vendor Managed Inventory. Freight invoices also will not have a PurchaseOrder number.

OrderDocumentRequired

OrderDocumentRequired is optional. Multiple instances might exist.

Group element used to identify any external documents that need to be referenced and how many of those documents are required. Typically, used to identify hard copy documents.

This element will be deprecated in the next version of papiNet. Use the DocumentInformation element instead.

BuyerParty

BuyerParty is mandatory. A single instance is required.

The legal entity to which the product is sold. Also commonly referred to as the sold-to party or customer. If no OtherParty is defined as the Payer, the Buyer is the Payer.

BillToParty

BillToParty is optional. A single instance might exist.

The address where the invoice is to be sent.

SupplierParty

SupplierParty is mandatory. A single instance is required.

The organisation or business entity responsible for providing the product. SupplierParty is also the seller of the product, if Seller is not specified as OtherParty = Seller.

OtherParty

OtherParty is optional. Multiple instances might exist.

An organisation or business entity other than those specifically detailed within a e-Document.

SenderParty

SenderParty is optional. A single instance might exist.

The business entity issuing the e-Document, the source of the document.

The entity responsible for the content. If the sender party has out sourced the message service to a third party the SenderParty is the issuer of the e-Document and not the party performing the transmission service of the electronic message.

ReceiverParty

ReceiverParty is optional. Multiple instances might exist.

The business entity for whom the e-Document is intended, the destination of the document.

The entity interested in the content. If the receiver party has outsourced the message service to a third party the ReceiverParty is the intended party for the e-Document and not the party performing the receiving service of the electronic message.

ShipToInformation

ShipToInformation is optional. A single instance might exist.

Group element containing information about the ship to and delivery of a product.

CountryOfOrigin

CountryOfOrigin is optional. A single instance might exist.

The country of origin for the material.

CountryOfDestination

CountryOfDestination is optional. A single instance might exist.

The country where the goods will be, or were, shipped to.

CountryOfConsumption

CountryOfConsumption is optional. A single instance might exist.

The country of consumption for the material.

ValidityPeriod

ValidityPeriod is optional. A single instance might exist.

The validity period for a specific item, e.g. the validity period for an e-Document.

Insurance

Insurance is optional. A single instance might exist.

Group element containing information about insurance

AdditionalText

AdditionalText is optional. Multiple instances might exist.

A text field that is used to communicate information not previously defined or for special instructions. To be used only for circumstances not covered by specific elements.

OrderConfirmationReference

OrderConfirmationReference is optional. Multiple instances might exist.

A group item detailing relevant references pertaining to the OrderConfirmation. Typically, the ContractNumber is referenced. OrderConfirmationReferenceType provides the identification of what the reference represents.

DocumentInformation

DocumentInformation is optional. Multiple instances might exist.

A group element containing a specification of required documents in the business process. Additional free text to be printed on documents can also be specified.

OrderConfirmationWoodLineItem

The details of the line items that are communicated on the Wood market segment OrderConfirmationWood.

OrderConfirmationLineItemStatusType [attribute]

OrderConfirmationLineItemStatusType is mandatory. A single instance is required.

Defines the status of the OrderConfirmation line item

Refer to

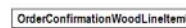

OrderConfirmationLineItemStatusType definition for any enumerations.

OrderConfirmationLineItemDocumentStatus [attribute]

OrderConfirmationLineItemDocumentStatus is optional. A single instance might exist.

Defines the actual document status for the OrderConfirmationLineItem.

Refer to

OrderConfirmationLineItemDocumentStatus definition for any enumerations.

(sequence)

The sequence of items below is mandatory. A single instance is required.

OrderConfirmationLineItemNumber

OrderConfirmationLineItemNumber is optional. A single instance might exist.

The sequential number that uniquely identifies the OrderConfirmation line item.

OrderConfirmationLineItemStatusTypeText

OrderConfirmationLineItemStatusTypeText is optional. A single instance might exist.

A text field that may provide detail explaining the status of the OrderConfirmationLineItem.

When a PurchaseOrderLineItem is rejected, the reason for the rejection must be specified in this field.

Not required if the PurchaseOrder is accepted or no changes have been made.

If the item is pending, the reason may be specified here.

PurchaseOrderLineItemNumber

PurchaseOrderLineItemNumber is optional. A single instance might exist.

The sequential number that uniquely identifies the PurchaseOrder line item.

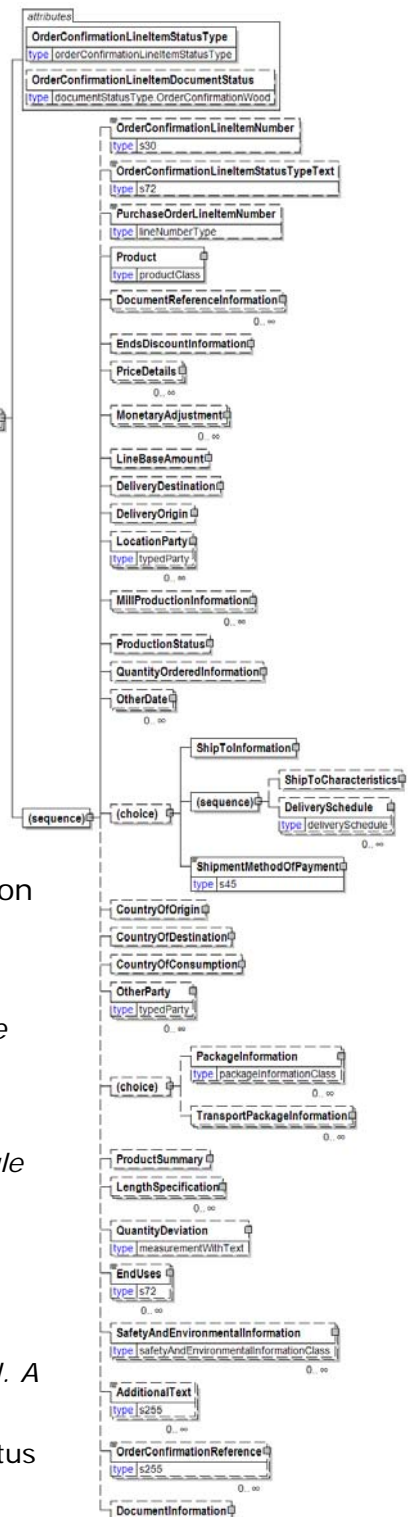

Product

Product is mandatory. A single instance is required.

Product is a group item defining the article and its characteristics. Product is used to specify product characteristics organized by ProductIdentifier, ProductDescription, and Classification. Book Manufacturing, Label Stock, Paper, Pulp, Recovered Paper, Wood Products, and Virgin Fibre market segments have defined their product characteristics and conversion features for implementation in papiNet.

DocumentReferenceInformation

DocumentReferenceInformation is optional. Multiple instances might exist.

A group item containing reference information applicable to a document.

EndsDiscountInformation

EndsDiscountInformation is optional. A single instance might exist.

Rule for calculating the ends discount, expressed by a code.

PriceDetails

PriceDetails is optional. Multiple instances might exist.

An element that groups together price information.

MonetaryAdjustment

MonetaryAdjustment is optional. Multiple instances might exist.

The element containing the information necessary for the understanding, calculation, and treatment of an adjustment to a currency amount. MonetaryAdjustment contains an attribute that indicates the type of adjustment being communicated.

LineBaseAmount

LineBaseAmount is optional. A single instance might exist.

For the particular e-Document being communicated the LineBaseAmount represents the quantity times the base unit price.

DeliveryDestination

DeliveryDestination is optional. A single instance might exist.

The DeliveryDestination specifies the end of one leg of the delivery. In order to comply with the US Trade Act of 2002 you would use this element with a LocationParty/@PartyType of Port.

DeliveryOrigin

DeliveryOrigin is optional. A single instance might exist.

A group item that represents the start of one leg in a route. Compare to DeliveryDestination.

The DeliveryOrigin specifies the start of one leg of the delivery.

In order to comply with the US Trade Act of 2002 you would use this element with a LocationParty/@PartyType of Port.

LocationParty

LocationParty is optional. Multiple instances might exist.

The organization or business entity where the business event took place or will take place.

MillProductionInformation

MillProductionInformation is optional. Multiple instances might exist.

A grouping element that contains information about production at the mill.

ProductionStatus

ProductionStatus is optional. A single instance might exist.

A group item used to communicate the release of a delivery line number.

QuantityOrderedInformation

QuantityOrderedInformation is optional. A single instance might exist.

Used to identify quantity. The construct provides via InformationalQuantity the ability to provide the Quantity in another UOM. Length is also provided to further specify the quantity.

OtherDate

OtherDate is optional. Multiple instances might exist.

A date that may not be specifically detailed within a document (example: print date at the PurchaseOrderLineItem).

(choice)

[choice] is optional because of choice construct.

ShipToInformation

ShipToInformation is optional because of choice construct.

Group element containing information about the ship to and delivery of a product.

(sequence)

The sequence of items below is mandatory. A single instance is required.

ShipToCharacteristics

ShipToCharacteristics is optional. A single instance might exist.

A group item that provides information important for the Ship-To Party.

A group item that provides information important for the Ship-To Party. ShipToCharacteristics may be referenced at both the header and line item level. The reference at the header is required and acts as a default for the value at the line level, unless overridden at the line level.

DeliverySchedule

DeliverySchedule is optional. Multiple instances might exist.

A group item defining a series of DeliveryDateWindow(s) in which specified quantities must be delivered.

ShipmentMethodOfPayment

ShipmentMethodOfPayment is optional because of choice construct.

An element communicating responsibility of freight payment and when transfer of ownership will occur.

CountryOfOrigin

CountryOfOrigin is optional. A single instance might exist.

The country of origin for the material.

CountryOfDestination

CountryOfDestination is optional. A single instance might exist.

The country where the goods will be, or were, shipped to.

CountryOfConsumption

CountryOfConsumption is optional. A single instance might exist.

The country of consumption for the material.

OtherParty

OtherParty is optional. Multiple instances might exist.

An organisation or business entity other than those specifically detailed within a e-Document.

(choice)

[choice] is optional because of choice construct.

PackageInformation

PackageInformation is optional because of choice construct.

The purpose of the PackageInformation structure is to clearly identify physical handling items that constitute the delivery.

PackageInformation is the highest level of product packaging it describes the shipping or warehousing unit.

If you are communicating a package, usually for logistics or transport purposes, you should include the PackageType, Identifier, ItemCount, and Quantity. (Note: you still have the ability to describe the item with one of the "named" items.)

If you are communicating one of the named Items there is no need to include PackageType, Identifier, ItemCount, and Quantity.

Since either of these two approaches can be used the entire contents of this element are optional even though the parent may be required. It is expected that you will fill in the appropriate details.

TransportPackageInformation

TransportPackageInformation is optional because of choice construct.

Information of a package used in transportation, can include several normal packages.

ProductSummary

ProductSummary is optional. A single instance might exist.

Group of elements to provide summary information on product level.

LengthSpecification

LengthSpecification is optional. Multiple instances might exist.

Length specification of the wood product.

QuantityDeviation

QuantityDeviation is optional. A single instance might exist.

To be deprecated in a future version. Use the Quantity element with a QuantityContext of "Deviation".

EndUses

EndUses is optional. Multiple instances might exist.

A text element used to express in human readable form a list of applicable end uses for a product. Examples of end uses are:

Magazine

Book
Commercial print
etc

SafetyAndEnvironmentalInformation

SafetyAndEnvironmentalInformation is optional. Multiple instances might exist.

Name of certification type, if any, on the goods (For example, FSC, PEFC). SafetyAndEnvironmental needs a value or measurement to communicate the percentage of the product is certified (for example, 75% is certified by the indicated agency).

AdditionalText

AdditionalText is optional. Multiple instances might exist.

A text field that is used to communicate information not previously defined or for special instructions. To be used only for circumstances not covered by specific elements.

OrderConfirmationReference

OrderConfirmationReference is optional. Multiple instances might exist.

A group item detailing relevant references pertaining to the OrderConfirmation. Typically, the ContractNumber is referenced. OrderConfirmationReferenceType provides the identification of what the reference represents.

DocumentInformation

DocumentInformation is optional. A single instance might exist.

A group element containing a specification of required documents in the business process. Additional free text to be printed on documents can also be specified.

OrderConfirmationWoodProductGroup

Group element used to potentially group like products together. Construct consists of a product group id, line items, and a product

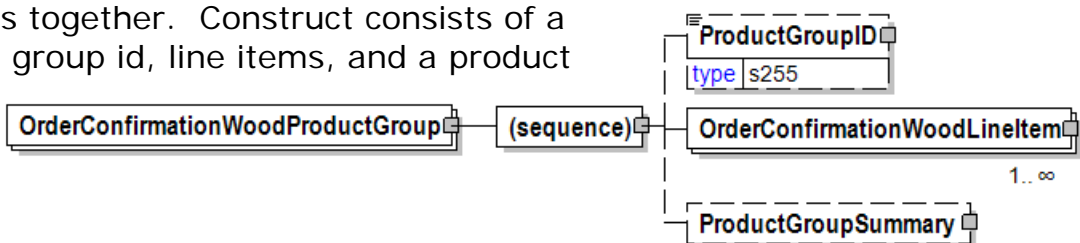

grouping summary.

(sequence)

The sequence of items below is mandatory. A single instance is required.

ProductGroupID

ProductGroupID is optional. A single instance might exist.

Possibility to group packages or Shipments. Example: Creating temporary group ID's for logistic reasons or lot number.

OrderConfirmationWoodLineItem

OrderConfirmationWoodLineItem is mandatory. One instance is required, multiple instances might exist.

The details of the line items that are communicated on the Wood market segment OrderConfirmationWood.

ProductGroupSummary

ProductGroupSummary is optional. A single instance might exist.

Group of elements to provide summary information on product level.

OrderConfirmationWoodSummary

Summary information that applies to the Wood market segment OrderConfirmationWood e-Document.

(sequence)

The sequence of items below is mandatory. A single instance is required.

TotalNumberOfLineItems

TotalNumberOfLineItems is optional. A single instance might exist.

The total number of individual line items in the document, regardless of the status or type.

(sequence)

The sequence of items below is optional. Multiple instances might exist.

TotalQuantity



TotalQuantity is mandatory. A single instance is required.

The total quantity of similar items in the e-Document. TotalQuantity is primarily used in the summary section of documents where it is repeatable to permit totaling for different units of measure.

TotalInformationalQuantity

TotalInformationalQuantity is optional. Multiple instances might exist.

A quantity that is used to communicate related information about the parent element. This element represents a total that is derived from individual line items.

ProductSummary

ProductSummary is optional. A single instance might exist.

Group of elements to provide summary information on product level.

LengthSpecification

LengthSpecification is optional. Multiple instances might exist.

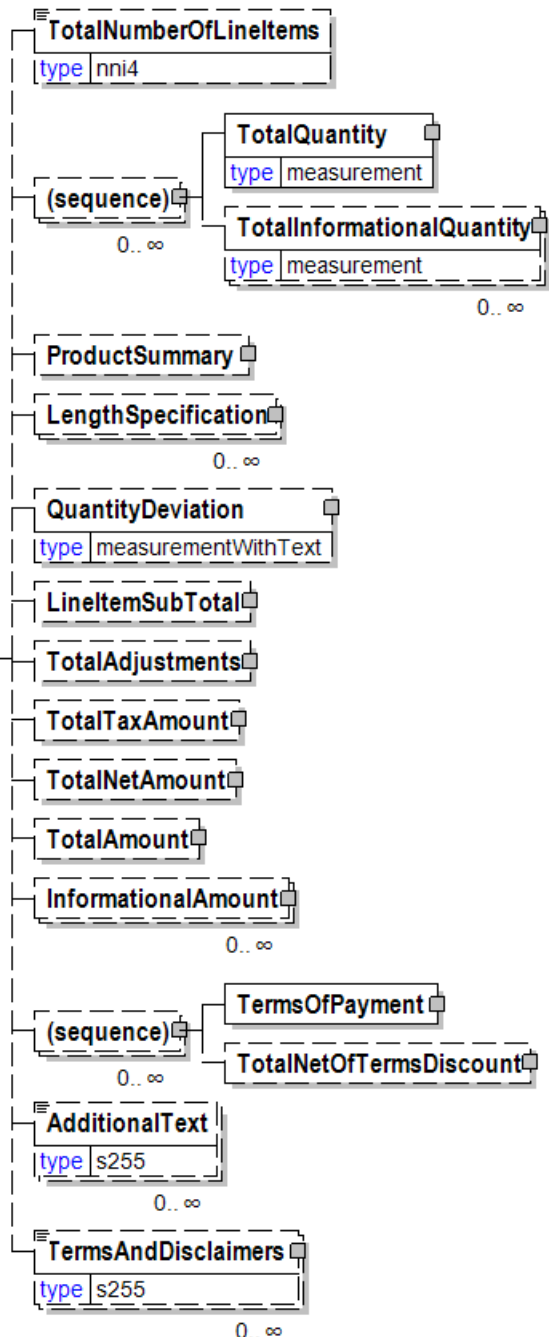

Length specification of the wood product.

QuantityDeviation

QuantityDeviation is optional. A single instance might exist.

To be deprecated in a future version. Use the Quantity element with a QuantityContext of "Deviation".

LineItemSubTotal

LineItemSubTotal is optional. A single instance might exist.

The total amount of all e-Document LineBaseAmount(s) line items without any monetary adjustments that may occur after the e-Document line items.

TotalAdjustments

TotalAdjustments is optional. A single instance might exist.

The CurrencyValue of TotalAdjustments contains the total of all MonetaryAdjustmentAmount for all instances of PriceAdjustment and FlatAmountAdjustment in the document (it excludes TaxAdjustments).

TotalTaxAmount

TotalTaxAmount is optional. A single instance might exist.

The CurrencyValue of TotalTaxAmount contains the sum of all instances of TaxAdjustment in the document. TotalTaxAmount contains the sum of all instances of the MonetaryAdjustmentAmount for tax adjustments.

TotalNetAmount

TotalNetAmount is optional. A single instance might exist.

A field containing total amount excluding tax. For example, in the Invoice TotalNetAmount is equal to the sum of LineItemSubTotal plus TotalAdjustments. TotalNetAmount encapsulates CurrencyValue.

TotalAmount

TotalAmount is optional. A single instance might exist.

The total amount including tax.

In e-Documents claiming payment this is the amount due for payment based on the terms of payment. Decimal rounding might be applied to this amount.

InformationalAmount

InformationalAmount is optional. Multiple instances might exist.

A monetary amount used for information purposes only (not for calculation). For example, the invoice price adjustment subtotal is expressed in sterling pounds, and the buyer wants this information expressed in U.S. dollars.

CreditDebitNote and Invoice - The TaxAmount is displayed in the currency that is applicable throughout the e-Document. When a TaxAmount needs to be displayed in a different national currency, this field is used.

(sequence)

The sequence of items below is optional. Multiple instances might exist.

TermsOfPayment

TermsOfPayment is mandatory. A single instance is required.

A group item that contains agreed-to terms defining when, how, and under what conditions the payment is to be made.

When TermsOfPayment is optional; if omitted, TermsOfPayment is controlled

through previous negotiation.

TotalNetOfTermsDiscount

TotalNetOfTermsDiscount is optional. A single instance might exist.

The components of the amount to be paid if prompt payment discount terms are met, including the amount that is subject to the payment terms discount, the discount amount, and the amount due after prompt payment discount.

AdditionalText

AdditionalText is optional. Multiple instances might exist.

A text field that is used to communicate information not previously defined or for special instructions. To be used only for circumstances not covered by specific elements.

TermsAndDisclaimers

TermsAndDisclaimers is optional. Multiple instances might exist.

An element that contains legal information with an indication of what the Language is.

OrderContextType [attribute]

Qualifies the source of the PurchaseOrder.

This item is restricted to the following list.

PurchaseOrder

The source is the buyer.

SalesOrder

The source is the supplier.

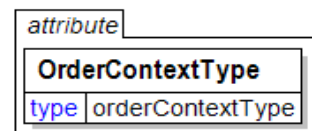

OrderDocumentRequired

Group element used to identify any external documents that need to be referenced and how many of those documents are required. Typically, used to identify hard copy documents.

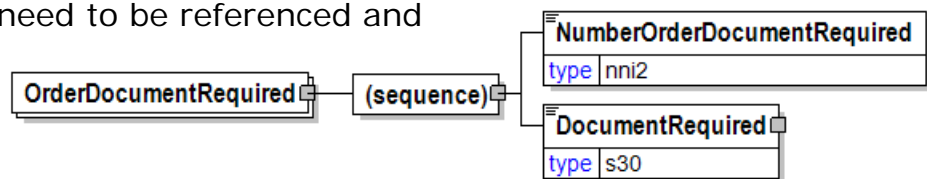

This element will be deprecated in the next version of papiNet. Use the DocumentInformation element instead.

(sequence)

The sequence of items below is mandatory. A single instance is required.

NumberOrderDocumentRequired

NumberOrderDocumentRequired is mandatory. A single instance is required.

There are certain business cases whereby a party is required to reference external documents to the transaction. Additionally, in these cases, the party is required to

papiNet V2R31

communicate the number of these external documents. This element is used to indicate how many of these external documents will be required. Typically used to indicate how many hard copies of the referenced document are needed.

DocumentRequired

DocumentRequired is mandatory. A single instance is required.

An element that permits the listing of the documents required.

OrderHeaderStatusType [attribute]

Defines the status of the PurchaseOrder header

This item is restricted to the following list.

Amended

The supplied information is changed.

Cancelled

The supplied information has been cancelled. Items that have been cancelled are not included in totals on the summary levels of the e-Document.

New

The supplied information is new and supplied for the first time.

NoAction

The supplied information has not been amended and thereby requires no action.

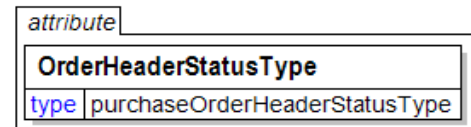

OrderLineItemDocumentStatus [attribute]

Defines the actual document status for the PurchaseOrderLineItem.

This item is restricted to the following list.

Cancelled

The supplied information of the document item is cancelled. Items that have been cancelled are not included in totals on the summary level of e- Documents.

Requested

The supplied information of the document item is ordered.

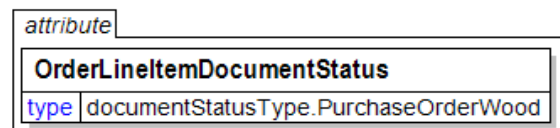

OrderLineItemStatusType [attribute]

Defines the status of the PurchaseOrder line item

This item is restricted to the following list.

Amended

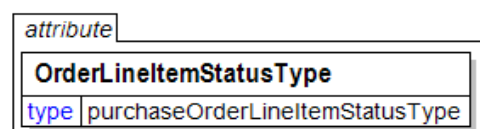

The supplied information is changed.

Cancelled

The supplied information has been cancelled. Items that have been cancelled are not included in totals on the summary levels of the e-Document.

New

The supplied information is new and supplied for the first time.

NoAction

The supplied information has not been amended and thereby requires no action.

OrderPrimaryStatus

An element that contains the highest level status code pertaining to an entire order.

OrderStatusCode [attribute]

OrderStatusCode is mandatory. A single instance is required.

This attribute communicates the overall status of the order.

Refer to OrderStatusCode definition for any enumerations.

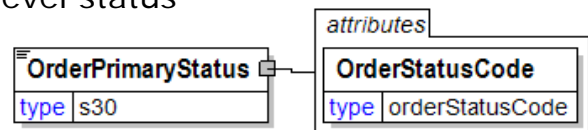

OrderQuantities

An element that contains the quantities that can be used for ordering.

(sequence)

The sequence of items below is mandatory. A single instance is required.

MinimumOrderQuantity

MinimumOrderQuantity is optional. A single instance might exist.

The minimum amount that can be ordered on a PurchaseOrder.

MaximumOrderQuantity

MaximumOrderQuantity is optional. A single instance might exist.

The maximum amount that can be ordered at one time.

IncrementalOrderQuantity

IncrementalOrderQuantity is optional. A single instance might exist.

An incremental quantity and units of measure that is added to MinimumOrderQuantity to arrive at an order quantity.

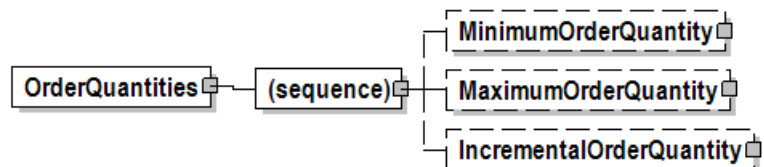

OrderSecondaryStatus

An element that contains a secondary status description pertaining to the entire order.

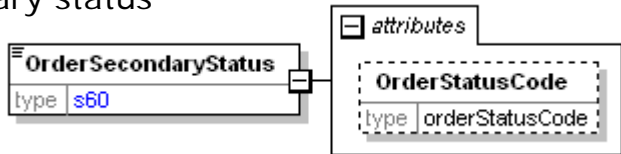

OrderStatus

The OrderStatus element is the root element for the OrderStatus e-Document.

The OrderStatus e-Document permits the sender to report the current status of an order, specific order line items, or to report status of multiple orders based upon some specified criteria. The e-Document enables the sender to indicate a primary status as well as an additional secondary status at the order level as well as for each line and component.

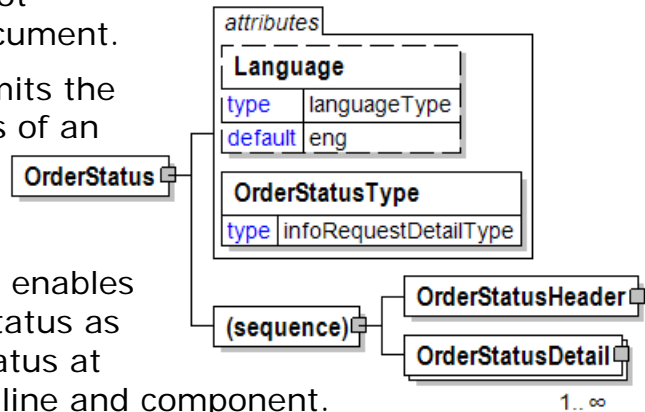

Language [attribute]

Language is optional. A single instance might exist.

XML has embraced 2 and 3 digit language codes through the application of an addendum to the standard.

Refer to Language definition for any enumerations.

OrderStatusType [attribute]

OrderStatusType is mandatory. A single instance is required.

Communicates the method in which the OrderStatus has been, or should be, summarized.

Refer to OrderStatusType definition for any enumerations.

(sequence)

The sequence of items below is mandatory. A single instance is required.

OrderStatusHeader

OrderStatusHeader is mandatory. A single instance is required.

Information that applies to the entire OrderStatus e-Document.

OrderStatusDetail

OrderStatusDetail is mandatory. One instance is required, multiple instances might exist.

The specifics of the information being communicated in the OrderStatus e-Document.

OrderStatusCode [attribute]

This attribute communicates the overall status of the order.

attribute
OrderStatusCode
type orderStatusCode

This item is restricted to the following list.

ActiveFree

The PO, order, or line item has been accepted or confirmed by the supplier. It may not have been manufactured, packed, or shipped yet. It is free for production. This status is also known as open status.

ActiveHold

The PO, order, or line item has been accepted or confirmed by the supplier. It may not have been manufactured, packed, or shipped yet. It is not free for production. Examples of this status include a reserved order or line item, the print time has not been determined, other payment terms not completed, or the last date for change has not been received.

Cancelled

The PO, order, or line item has a cancelled status in the supplier's system. It will not be manufactured nor shipped.

Complete

The PO, order, or line item has a complete status in the supplier's system. It has been packed, shipped, and invoiced successfully.

Delayed

An unexpected event has caused a delay.

FinalPlanning

The order is undergoing the final planning process.

Invoiced

The PO, order, or line item has an invoiced status in the supplier's system. It has been billed to the customer for payment purposes.

Loaded

The PO, order, or line item has a loaded status in the supplier's system. It has been loaded onto a transport vehicle shipping purposes.

NotReceived

Not received by either the buyer or seller.

OrderLineConfirmed

The order line has been confirmed.

Packed

The PO, order, or line item has a packed status in the supplier's system. It has been packaged or staged for loading and shipping purposes.

PartiallyShipped

The PO, order, or line item has a partially shipped status in the supplier's system. Part of the quantity requested has been shipped to the customer but part of the request still remains to be shipped.

Pending

The PO, order, or line item has a pending status in the supplier's system. It has not yet been confirmed, accepted, nor rejected by the supplier. This status indicates that the supplier requires more time to determine acceptance.

Planned

The PO, order, or line item has a planned or scheduled status in the supplier's system. It has not yet begun the manufacturing process.

ProductionComplete

The PO, order, or line item has completed the manufacture process by the supplier.

ProductionPlanned

Production has been planned for the order.

ProductionStarted

The PO, order, or line item has begun to be manufactured by the supplier.

Received

The material has arrived at the destination and has been processed by that location.

ReservedInProductionPlanningSystem

Material and capacity is available for production.

Scheduled

The order has been scheduled.

ShipmentComplete

The order has been fully shipped.

ShipmentPlanned

Shipment has been planned for the order

Shuttled

Material has been moved.

Staged

Material has been positioned for production.

Transferred

The manufacturing order has been moved.

TransferredToMillSystem

The order has been loaded onto the mill manufacturing system.

Unscheduled

The order has not yet been scheduled.

Unshipped

The PO, order, or line item is in the supplier's mill or warehouse but has yet to be shipped.

OrderStatusDetail

The specifics of the information being communicated in the OrderStatus e-Document.

(sequence)

The sequence of items below is mandatory. A single instance is required.

PurchaseOrderInformation

PurchaseOrderInformation is mandatory. A single instance is required.

A group item containing information unique to this PurchaseOrder, which is provided by the buyer. PurchaseOrderInformation can be optional in the supply chain. Invoices are created without having a PurchaseOrder in Vendor Managed Inventory. Freight invoices also will not have a PurchaseOrder number.

PurchaseOrderLineItemNumber

PurchaseOrderLineItemNumber is mandatory. A single instance is required.

The sequential number that uniquely identifies the PurchaseOrder line item.

(sequence)

The sequence of items below is optional. Multiple instances might exist.

SupplierOrderNumber

SupplierOrderNumber is mandatory. A single instance is required.

The number of the supplier order.

SupplierOrderLineItemNumber

SupplierOrderLineItemNumber is optional. A single instance might exist.

The number of the line item on the supplier order.

LocationParty

LocationParty is optional. A single instance might exist.

The organization or business entity where the business event took place or will take place.

Product

Product is mandatory. A single instance is required.

Product is a group item defining the article and its characteristics. Product is used to specify

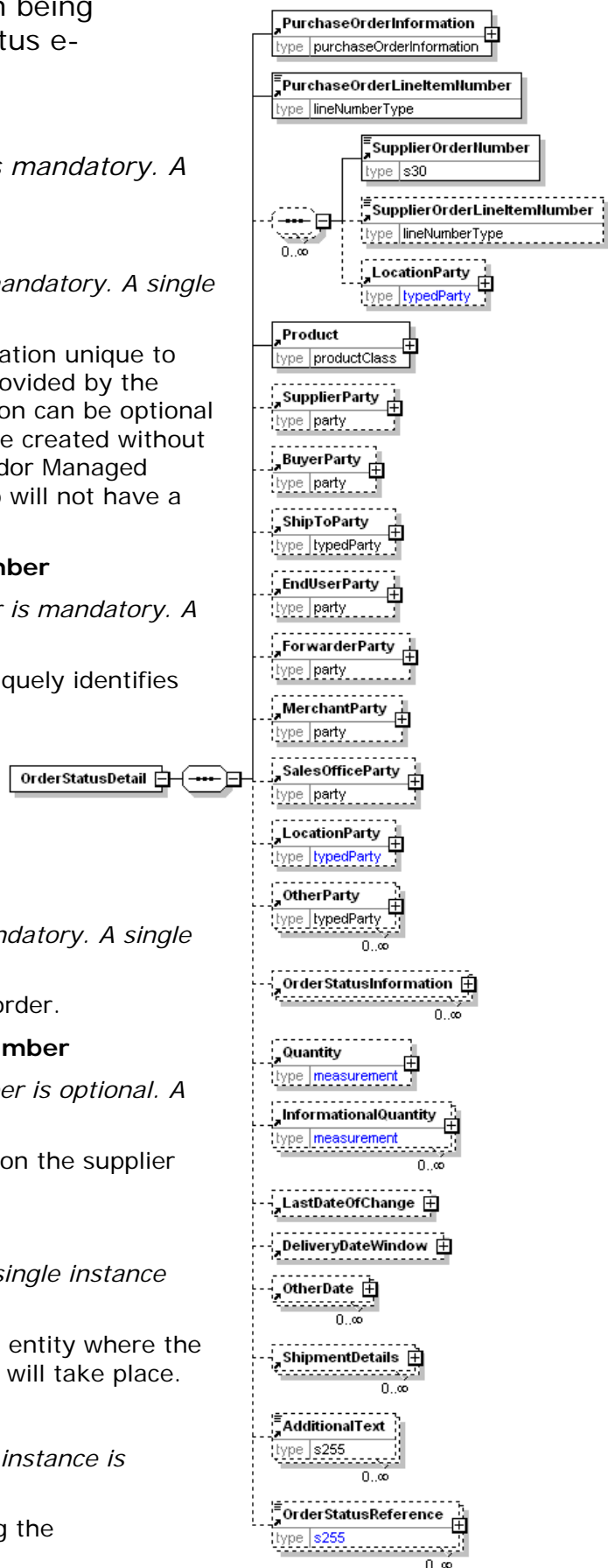

product characteristics organized by ProductIdentifier, ProductDescription, and Classification. Book Manufacturing, Label Stock, Paper, Pulp, Recovered Paper, Wood Products, and Virgin Fibre market segments have defined their product characteristics and conversion features for implementation in papiNet.

SupplierParty

SupplierParty is optional. A single instance might exist.

The organisation or business entity responsible for providing the product. SupplierParty is also the seller of the product, if Seller is not specified as OtherParty = Seller.

BuyerParty

BuyerParty is optional. A single instance might exist.

The legal entity to which the product is sold. Also commonly referred to as the sold-to party or customer. If no OtherParty is defined as the Payer, the Buyer is the Payer.

ShipToParty

ShipToParty is optional. A single instance might exist.

The name and/or address to which the goods should be delivered with the party type indicated by the PartyType attribute.

EndUserParty

EndUserParty is optional. A single instance might exist.

The party using, consuming, or converting the product. For example, a printer using paper reels for a print job for a publisher. The final ShipTo destination for a product is normally to the end user's facilities.

ForwarderParty

ForwarderParty is optional. A single instance might exist.

The trading partner involved in the forwarding of the shipment.

MerchantParty

MerchantParty is optional. A single instance might exist.

This named party represents the merchant involved in the business transaction. This party is only used in the communication of OrderStatus otherwise it is handled via OtherParty.

SalesOfficeParty

SalesOfficeParty is optional. A single instance might exist.

This named party represents the sales office involved in the business transaction. This party is only used in the communication of OrderStatus otherwise it is handled via OtherParty.

LocationParty

LocationParty is optional. A single instance might exist.

The organization or business entity where the business event took place or will take place.

OtherParty

OtherParty is optional. Multiple instances might exist.

An organisation or business entity other than those specifically detailed within a e-Document.

OrderStatusInformation

OrderStatusInformation is optional. Multiple instances might exist.

A group element that stores two levels of order status codes.

Quantity

Quantity is optional. A single instance might exist.

The Quantity element contains attributes that provide information about the type of quantity that is being communicated, the context in which the particular quantity is to be viewed, and (if the quantity represents an adjustment) an adjustment type.

The Quantity element contains three child elements that enable you to communicate a range of values for the quantity and a target or actual value. It is at this level (Value, RangeMin, and RangeMax) that the unit of measure is specified. This permits the range to be specified in a different unit of measure than the target.

InformationalQuantity

InformationalQuantity is optional. Multiple instances might exist.

A quantity given in a valid UOM used for information purposes only (not for calculation). For example, an ordered quantity was 100 reels as opposed to the invoice quantity of 20,000 pounds.

LastDateOfChange

LastDateOfChange is optional. A single instance might exist.

The last date for which changes to the line item may occur before it is "locked" in the production process. LastDateOfChange encapsulates Date.

DeliveryDateWindow

DeliveryDateWindow is optional. A single instance might exist.

A group item defining the date/time interval for delivery to take place. An element which may contain the estimated date for which delivery is expected. This date is not absolute.

OtherDate

OtherDate is optional. Multiple instances might exist.

A date that may not be specifically detailed within a document (example: print date at the PurchaseOrderLineItem).

ShipmentDetails

ShipmentDetails is optional. Multiple instances might exist.

A group element containing information that relates to the shipment details for the line item.

AdditionalText

AdditionalText is optional. Multiple instances might exist.

A text field that is used to communicate information not previously defined or for special instructions. To be used only for circumstances not covered by specific elements.

OrderStatusReference

OrderStatusReference is optional. Multiple instances might exist.

An item detailing relevant references (such as contract number) pertaining to the OrderStatus. The type of reference is identified by the attribute OrderStatusReferenceType.

OrderStatusHeader

Information that applies to the entire OrderStatus e-Document.

(sequence)

The sequence of items below is mandatory. A single instance is required.

OrderStatusNumber

OrderStatusNumber is mandatory. A single instance is required.

A number used to identify the OrderStatus report.

OrderStatusResponseDate

OrderStatusResponseDate is mandatory. A single instance is required.

The Date and Time that the OrderStatus e-Document was created.

RequestNumber

RequestNumber is optional. A single instance might exist.

A unique tracking number specifically identifying the InfoRequest e-Document to the originator. The tracking number is returned with the "information", the answer, to help match the answer to the request.

RequestingParty

RequestingParty is optional. A single instance might exist.

The party requesting the information.

RespondToParty

RespondToParty is optional. Multiple instances might exist.

The party the document should be responded to.

SenderParty

SenderParty is optional. A single instance might exist.

The business entity issuing the e-Document, the source of the document.

The entity responsible for the content. If the sender party has out sourced the message service to a third party the SenderParty is the issuer of the e-Document and not the party performing the transmission service of the electronic message.

ReceiverParty

ReceiverParty is optional. Multiple instances might exist.

The business entity for whom the e-Document is intended, the destination of the document.

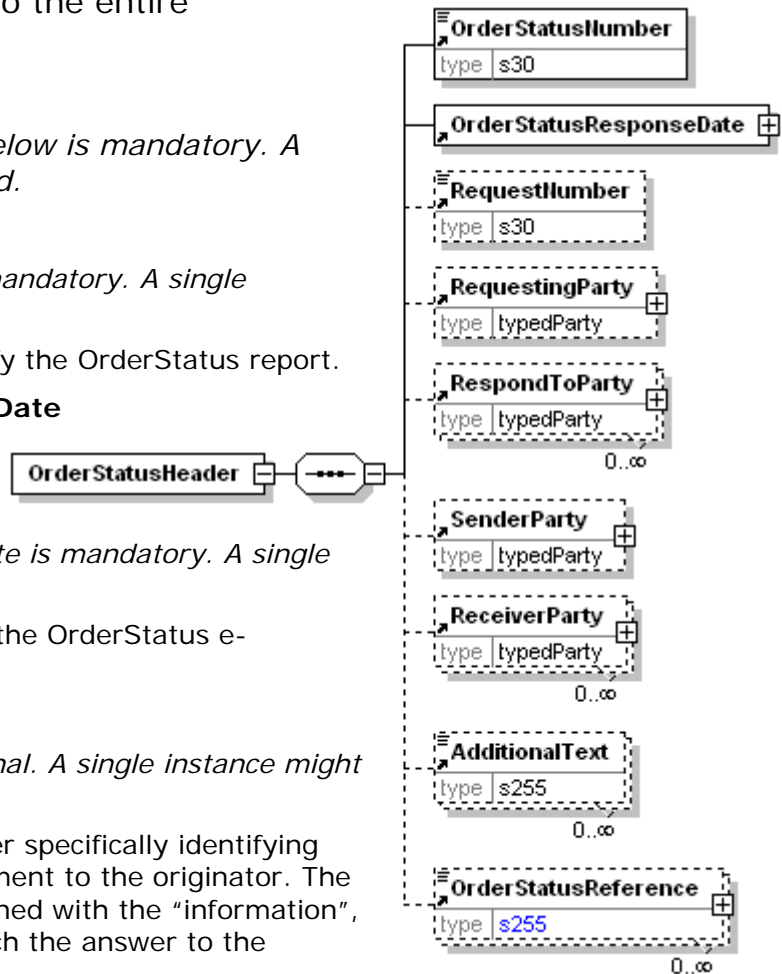

The entity interested in the content. If the receiver party has outsourced the message service to a third party the ReceiverParty is the intended party for the e-Document and not the party performing the receiving service of the electronic message.

AdditionalText

AdditionalText is optional. Multiple instances might exist.

A text field that is used to communicate information not previously defined or for special instructions. To be used only for circumstances not covered by specific elements.

OrderStatusReference

OrderStatusReference is optional. Multiple instances might exist.

An item detailing relevant references (such as contract number) pertaining to the OrderStatus. The type of reference is identified by the attribute OrderStatusReferenceType.

OrderStatusInformation

A group element that stores two levels of order status codes.

(sequence)

The sequence of items below is mandatory. A single instance is required.

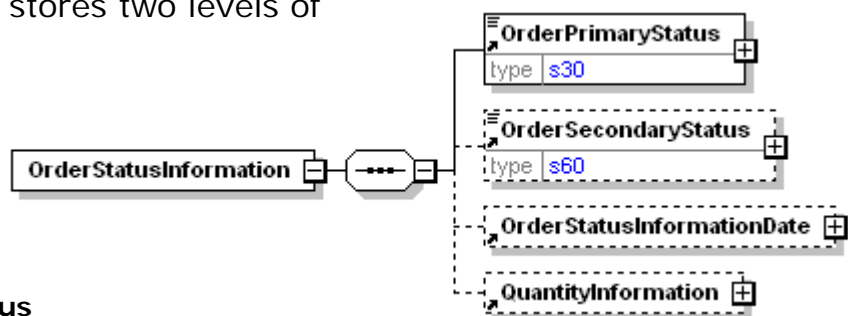

OrderPrimaryStatus

OrderPrimaryStatus is mandatory. A single instance is required.

An element that contains the highest level status code pertaining to an entire order.

OrderSecondaryStatus

OrderSecondaryStatus is optional. A single instance might exist.

An element that contains a secondary status description pertaining to the entire order.

OrderStatusInformationDate

OrderStatusInformationDate is optional. A single instance might exist.

The date and time when the specified OrderStatus was achieved.

QuantityInformation

QuantityInformation is optional. A single instance might exist.

A group item containing information about quantity and informational quantity of similar items.

OrderStatusInformationDate

The date and time when the specified OrderStatus was achieved.

(sequence)

The sequence of items

below is mandatory. A single instance is required.

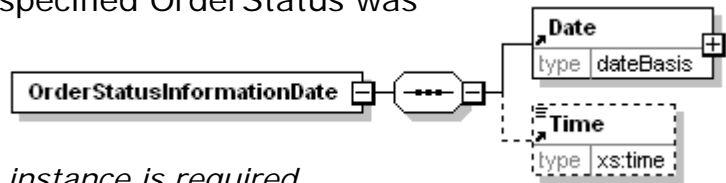

Date

Date is mandatory. A single instance is required.

A group element that contains the specification of Year, Month, and Day.

Time

Time is optional. A single instance might exist.

Times are treated in a standard XML fashion with a special case used to indicate a generalized "local" time. The standard XML approach to time is hh:mm:ss, hh:mm:ssZ, or hh:mm:ss±hh:mm.

hh:mm:ss±hh:mm is used to represent a time with a time zone. The time zone is communicated as the number of hours offset from the Universal Time Coordinate (UTC), a.k.a. Greenwich Mean Time.

hh:mm:ssZ indicates the time at Zulu (another name for UTC). Based on the convention described in the next bullet it will be important for users within UTC to use "Z" when communicating a time in their time zone to other users.

hh:mm:ss or hh:mm indicates in the XML standard the time at UTC however, within papiNet it is used to represent the applicable local time. Caution should be used when processing times of this nature as the papiNet approach may be in discord with other users of XML.

OrderStatusNumber

A number used to identify the OrderStatus report.

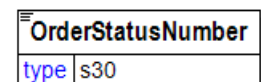

OrderStatusReference

An item detailing relevant references (such as contract number) pertaining to the OrderStatus. The type of reference is identified by the attribute OrderStatusReferenceType.

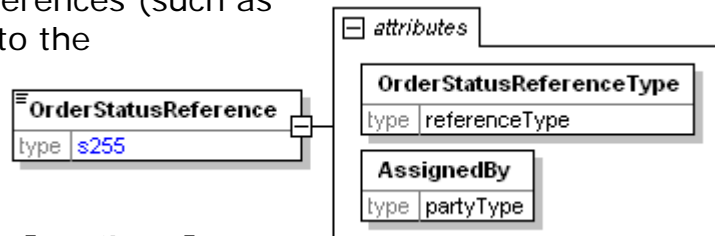

OrderStatusReferenceType [attribute]

OrderStatusReferenceType is mandatory. A single instance is required.

Provides a contextual explanation of the specific reference identifier. Many items are currently prefixed by "Buyer", "Forwarder", "Manufacturer", "Mill", "Seller", "Supplier", "Warehouse", or "Vendor". Check for an existing non-prefixed version and use the non-prefixed version instead. In the (yet to be

announced release date) version 3.0 the prefixed versions will be removed. Instead the attribute @AssignedBy will communicate the information previously communicated in the prefix.

Refer to OrderStatusReferenceType definition for any enumerations.

AssignedBy [attribute]

AssignedBy is mandatory. A single instance is required.

Identifies the type of party that has assigned the associated item, e.g. a reference of type OrderNumber.

Refer to AssignedBy for any enumerations.

OrderStatusReferenceType [attribute]

Provides a contextual explanation of the specific reference identifier. Many items are currently prefixed by "Buyer", "Forwarder", "Manufacturer", "Mill", "Seller", "Supplier", "Warehouse" or "Vendor". Check for an existing non-prefixed version and use the non-prefixed version instead. In the (yet to be announced release date) version 3.0 the prefixed versions will be removed. Instead the attribute AssignedBy will communicate the information previously communicated in the prefix.

OrderStatusReferenceType	
type	referenceType

Refer to the [referenceType](#) entry for the list of enumerations and their definitions.

OrderStatusRequestDetail

A grouping element that provides the parameters to be used when responding with an OrderStatus e-Document.

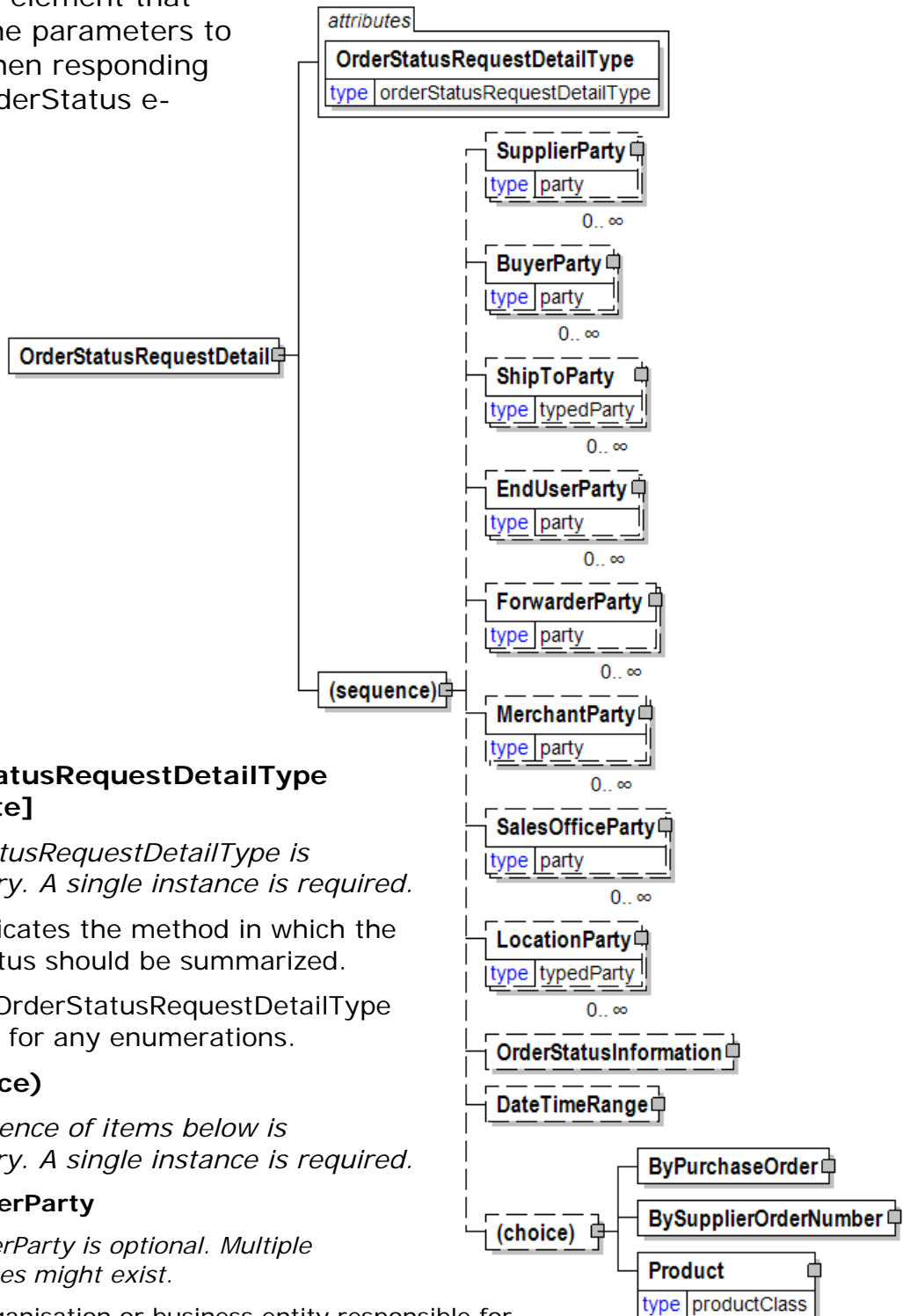

OrderStatusRequestDetailType [attribute]

OrderStatusRequestDetailType is mandatory. A single instance is required.

Communicates the method in which the OrderStatus should be summarized.

Refer to OrderStatusRequestDetailType definition for any enumerations.

(sequence)

The sequence of items below is mandatory. A single instance is required.

SupplierParty

SupplierParty is optional. Multiple instances might exist.

The organisation or business entity responsible for providing the product. SupplierParty is also the seller of the product, if Seller is not specified as OtherParty = Seller.

BuyerParty

BuyerParty is optional. Multiple instances might exist.

The legal entity to which the product is sold. Also commonly referred to as the sold-to party or customer. If no OtherParty is defined as the Payer, the Buyer is the Payer.

ShipToParty

ShipToParty is optional. Multiple instances might exist.

The name and/or address to which the goods should be delivered with the party type indicated by the PartyType attribute.

EndUserParty

EndUserParty is optional. Multiple instances might exist.

The party using, consuming, or converting the product. For example, a printer using paper reels for a print job for a publisher. The final ShipTo destination for a product is normally to the end user's facilities.

ForwarderParty

ForwarderParty is optional. Multiple instances might exist.

The trading partner involved in the forwarding of the shipment.

MerchantParty

MerchantParty is optional. Multiple instances might exist.

This named party represents the merchant involved in the business transaction. This party is only used in the communication of OrderStatus otherwise it is handled via OtherParty.

SalesOfficeParty

SalesOfficeParty is optional. Multiple instances might exist.

This named party represents the sales office involved in the business transaction. This party is only used in the communication of OrderStatus otherwise it is handled via OtherParty.

LocationParty

LocationParty is optional. Multiple instances might exist.

The organization or business entity where the business event took place or will take place.

OrderStatusInformation

OrderStatusInformation is optional. A single instance might exist.

A group element that stores two levels of O order status codes.

DateTimeRange

DateTimeRange is optional. A single instance might exist.

Specifies a date and/or time range.

(choice)

[choice] is optional because of choice construct.

ByPurchaseOrder

ByPurchaseOrder is optional because of choice construct.

Selection criteria for communicating purchase order information.

BySupplierOrderNumber

BySupplierOrderNumber is optional because of choice construct.

Selection criteria for communicating Supplier Order information

Product

papiNet V2R31

Product is optional because of choice construct.

Product is a group item defining the article and its characteristics. Product is used to specify product characteristics organized by ProductIdentifier, ProductDescription, and Classification. Book Manufacturing, Label Stock, Paper, Pulp, Recovered Paper, Wood Products, and Virgin Fibre market segments have defined their product characteristics and conversion features for implementation in papiNet.

OrderStatusRequestDetailType [attribute]

Communicates the method in which the OrderStatus should be summarized.

This item is restricted to the following list.

ByProduct

By product

ByPurchaseOrder

By the PurchaseOrder the material was ordered

BySupplierOrderNumber

By the order the material was manufactured

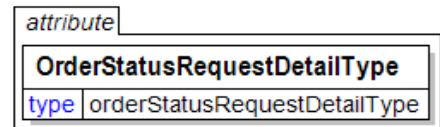

OrderStatusResponseDate

The Date and Time that the OrderStatus e-Document was created.

(sequence)

The sequence of items below is mandatory. A single instance is required.

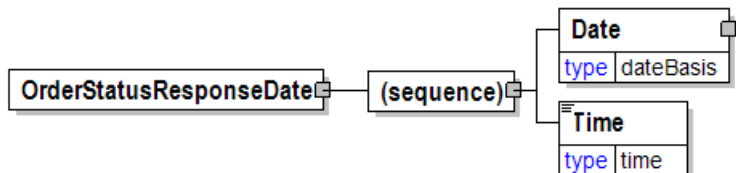

Date

Date is mandatory. A single instance is required.

A group element that contains the specification of Year, Month, and Day.

Time

Time is mandatory. A single instance is required.

Times are treated in a standard XML fashion with a special case used to indicate a generalized "local" time. The standard XML approach to time is hh:mm:ss, hh:mm:ssZ, or hh:mm:ss±hh:mm.

hh:mm:ss±hh:mm is used to represent a time with a time zone. The time zone is communicated as the number of hours offset from the Universal Time Coordinate (UTC), a.k.a. Greenwich Mean Time.

hh:mm:ssZ indicates the time at Zulu (another name for UTC). Based on the convention described in the next bullet it will be important for users within UTC to use "Z" when communicating a time in their time zone to other users.

hh:mm:ss or hh:mm indicates in the XML standard the time at UTC however, within papiNet it is used to represent the applicable local time. Caution should be used when processing times of this nature as the papiNet approach may be

in discord with other users of XML.

OrderStatusType [attribute]

Communicates the method in which the OrderStatus has been, or should be, summarized.

This item is restricted to the following list.

ByProduct

By product

ByPurchaseOrder

By the PurchaseOrder the material was ordered

BySupplierOrderNumber

By the order the material was manufactured

attribute
OrderStatusType
type infoRequestDetailType

OrderStatusType [attribute]

Defines the status of the entire PurchaseOrder e-Document, in other words, at the root level

This item is restricted to the following list.

Amended

The supplied information is changed.

Cancelled

The supplied information has been cancelled. Items that have been cancelled are not included in totals on the summary levels of the e-Document.

Original

The supplied information is the first version of that information.

attribute
OrderStatusType
type purchaseOrderStatusType

OrderType [attribute]

Defines the type of OrderConfirmation being communicated.

This item is restricted to the following list.

Agreement

A legally binding exchange of promises between parties that the law will enforce.

BlanketOrder

An order that communicates the same information as a StandardOrder but also indicates that the order may be completed over a period of time or, until a certain volume is achieved or, until a certain currency amount is spent.

ConfirmingOrder

A confirming order is used to electronically confirm an order that has not been

attribute
OrderType
type orderConfirmationType

placed electronically by the customer that is, it was placed using another mean such as fax, phone or email.

ConsumptionOrder

A PurchaseOrder that is based upon consumption for a particular period of time or instance.

ReleaseOrder

A release order is used to release a product to be made. This type of order refers to a previous order or agreement, such as a reservation order, a contract, or a blanket order. A release number version which is an incremented number, is used in this type.

ReservationOrder

A reservation order is used to book a paper supplier's capacity for specific quantities of specific products, but it is not yet a firm commitment to buy. Consequently, all line items of a reservation order have a ProductionStatusType of NotFree. To release one or more PurchaseOrder line items of a reservation order, a buyer can use a standard order or a release order.

StandardOrder

A standard order is a regular one-time order. It defines quantities for one or more products to be purchased and may also define a delivery location and date. A standard order may reference a previous agreement (for example, a quotation, a contract, or a reservation order) for information.

TrialOrder

A trial order is used whenever a seller has agreed to have a buyer sample a product. The seller needs to process this order differently from other orders, because a trial order may include a product sold at a discounted rate or even provided for free. A trial order typically is for small quantities.

OrderType [attribute]

Defines the type of OrderConfirmationWood being communicated.

This item is restricted to the following list.

attribute
OrderType
type orderConfirmationTypeWood

Agreement

A legally binding exchange of promises between parties that the law will enforce.

BlanketOrder

An order that communicates the same information as a StandardOrder but also indicates that the order may be completed over a period of time or, until a certain volume is achieve or, until a certain currency amount is spent.

ReleaseOrder

A release order is used to release a product to be made. This type of order refers to a previous order or agreement, such as a reservation order, a contract, or a blanket order. A release number version which is an

incremented number, is used in this type.

ReservationOrder

A reservation order is used to book a paper supplier's capacity for specific quantities of specific products, but it is not yet a firm commitment to buy. Consequently, all line items of a reservation order have a ProductionStatusType of NotFree. To release one or more PurchaseOrder line items of a reservation order, a buyer can use a standard order or a release order.

StandardOrder

A standard order is a regular one-time order. It defines quantities for one or more products to be purchased and may also define a delivery location and date. A standard order may reference a previous agreement (for example, a quotation, a contract, or a reservation order) for information.

OrderType [attribute]

Defines the type of PurchaseOrder issued.

This item is restricted to the following list.

attribute	
OrderType	
type	purchaseOrderTypeWood

BlanketOrder

A PurchaseOrder that communicates the same information as a StandardOrder but also indicates that the order may be completed over a period of time or, until a certain volume is achieved or, until a certain currency amount is spent.

ReleaseOrder

A release order is used to release a product to be made. This type of PurchaseOrder refers to a previous order or agreement, such as a reservation order, a contract, or a blanket order. A release number version called PurchaseOrderReleaseNumber, which is an incremented number, is used in this e-Document.

ReservationOrder

A reservation order is used to book a paper supplier's capacity for specific quantities of specific products, but it is not yet a firm commitment to buy. Consequently, all PurchaseOrder line items of a reservation order have a ProductionStatusType of NotFree. To release one or more PurchaseOrder line items of a reservation order, a buyer can use a standard order or a release order.

StandardOrder

OrganisationUnit

A segment of a business or the entire business.

OrganisationUnitType [attribute]

OrganisationUnitType is mandatory. A single instance is required.

Identifies the type of organisation being communicated

Refer to OrganisationUnitType definition for any enumerations.

(sequence)

The sequence of items below is mandatory. A single instance is required.

OrganisationUnitName

OrganisationUnitName is optional. A single instance might exist.

A description of the organisation unit.

OrganisationUnitCode

OrganisationUnitCode is optional. A single instance might exist.

A short representation for the organisation unit.

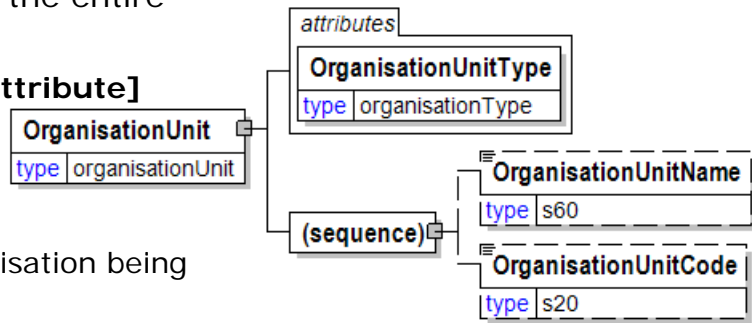

OrganisationUnitCode

A short representation for the organisation unit.

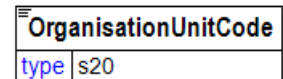

OrganisationUnitName

A description of the organisation unit.

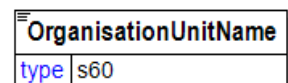

OrganisationUnitType [attribute]

Identifies the type of organisation being communicated

This item is restricted to the following list.

Department

A major division of a business.

Division

An administrative or operating unit of a business

Dock

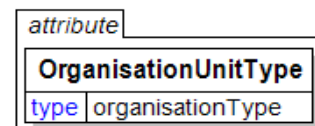

A place for the unloading or loading of material.

Location

A place marked by some distinguishing feature.

Region

An administrative area of a business.

StorageLocation

A place that supports the functions associated with warehousing of material.

Terminal

A point along a carrier line having facilities for the handling of freight.

Other

Another type of unit, not defined above.

OrientationWithFaceWoodPanelGrain [attribute]

Either "Yes" or "No".

This item is restricted to the following list.

Yes

No

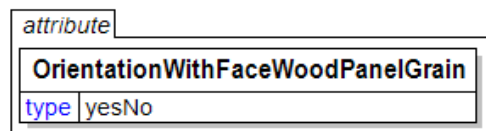

Original [attribute]

Either "Yes" or "No".

This item is restricted to the following list.

Yes

No

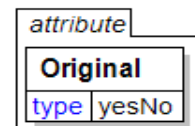

OtherDate

A date that may not be specifically detailed within a document (example: print date at the PurchaseOrderLineItem).

DateType [attribute]

DateType is mandatory. A single instance is required.

Provides a context for the other date used in the document.

Refer to DateType definition for any enumerations.

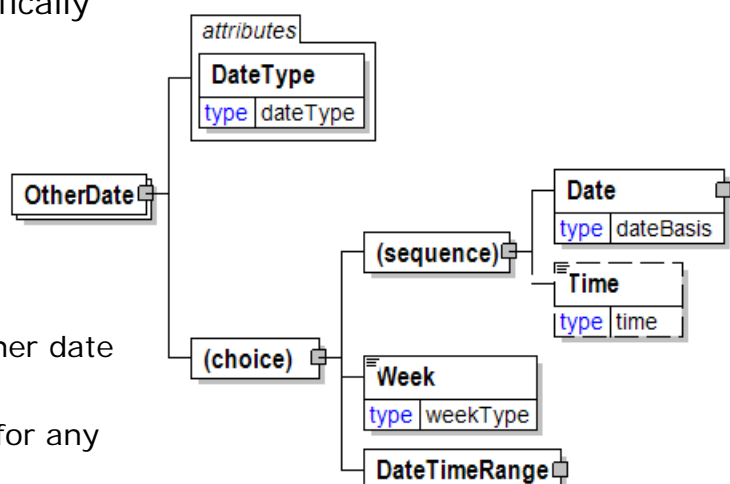

(choice)

[choice] is optional because of choice construct.

(sequence)

The sequence of items below is mandatory. A single instance is required.

Date

Date is mandatory. A single instance is required.

A group element that contains the specification of Year, Month, and Day.

Time

Time is optional. A single instance might exist.

Times are treated in a standard XML fashion with a special case used to indicate a generalized "local" time. The standard XML approach to time is hh:mm:ss, hh:mm:ssZ, or hh:mm:ss±hh:mm.

hh:mm:ss±hh:mm is used to represent a time with a time zone. The time zone is communicated as the number of hours offset from the Universal Time Coordinate (UTC), a.k.a. Greenwich Mean Time.

hh:mm:ssZ indicates the time at Zulu (another name for UTC). Based on the convention described in the next bullet it will be important for users within UTC to use "Z" when communicating a time in their time zone to other users.

hh:mm:ss or hh:mm indicates in the XML standard the time at UTC however, within papiNet it is used to represent the applicable local time. Caution should be used when processing times of this nature as the papiNet approach may be in discord with other users of XML.

Week

Week is optional because of choice construct.

A field defining the week number of the calendar year. ISO 8601 is used as the basis for this element, "Week 01 of a year is the first week that has the Thursday in this year, which is equivalent to the week that contains the fourth day of January."

DateTimeRange

DateTimeRange is optional because of choice construct.

Specifies a date and/or time range.

OtherParty

An organisation or business entity other than those specifically detailed within a e-Document.

PartyType [attribute]

PartyType is mandatory. A single instance is required.

Identifies the business role associated with the particular party

Refer to PartyType definition for any enumerations.

LogisticsRole [attribute]

LogisticsRole is optional. A single instance might exist.

Communicates the nature of the logistics role, if any, the party plays in the transaction.

Refer to LogisticsRole definition for any enumerations.

(sequence)

The sequence of items below is mandatory. A single instance is required.

PartyIdentifier

PartyIdentifier is optional. Multiple instances might exist.

A unique identifier of a specific party. This element contains an attribute PartyIdentifierType that indicates the type of party.

NameAddress

NameAddress is mandatory. A single instance is required.

A group item containing name and address of an organisation or business entity.

URL

URL is optional. A single instance might exist.

Universal Resource Locator. While typically a web address you could use this field to hold an email address.

CommonContact

CommonContact is optional. Multiple instances might exist.

Identifies a specific individual associated with the party.

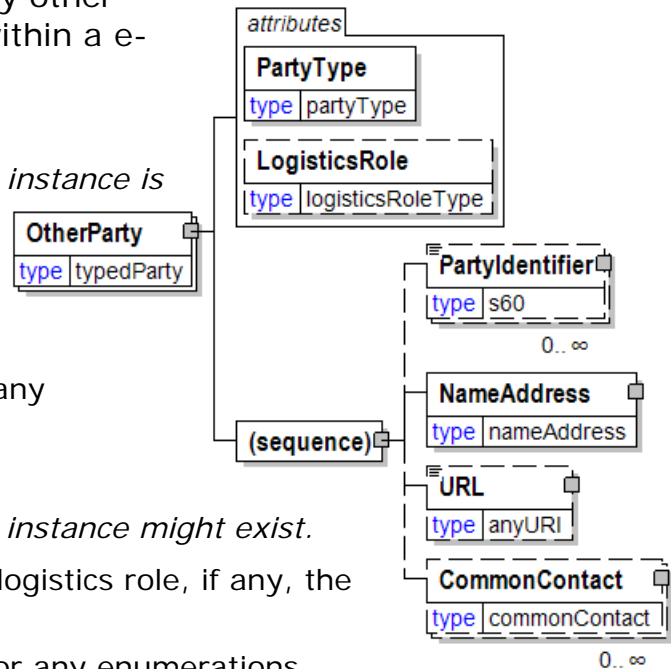

OtherTreatment

Other treatment

(sequence)

The sequence of items below is mandatory. A single instance is required.

AdditionalText

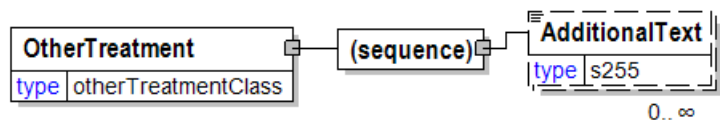

papiNet V2R31

AdditionalText is optional. Multiple instances might exist.

A text field that is used to communicate information not previously defined or for special instructions. To be used only for circumstances not covered by specific elements.

Overlay

Overlay

OverlaySide [attribute]

OverlaySide is optional. A single instance might exist.

Overlay side

Refer to OverlaySide definition for any enumerations.

(sequence)

The sequence of items below is mandatory. A single instance is required.

AdditionalText

AdditionalText is optional. Multiple instances might exist.

A text field that is used to communicate information not previously defined or for special instructions. To be used only for circumstances not covered by specific elements.

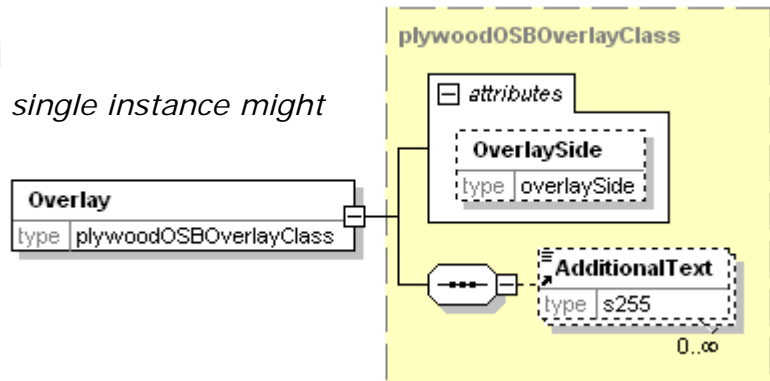

OverlaySide [attribute]

Overlay side

This item is restricted to the following list.

- 1
- 2

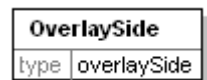

PackageAgency [attribute]

LumberAgency identifies which agency is responsible for assigning the lumber attributes.

This item is restricted to the following list.

BS

BS-EN

British standard based on a European standard.

CEN

European Committee for Standardisation (<http://www.cenorm.be>)

DIN

EN338

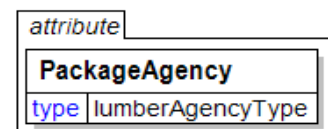

EN1912

EN1611-1

EDISAW

Generic

GOST

Russian federal agency on technical regulating and metrology
(<http://www.gost.ru>)

ISO

JAS

Japanese Agricultural Standard

NELMA

NLGA

NS

NSLB

RIS

RT

SIS

SPIB

WCLIB

WRCLA

WWPA

Supplier

PackageCharacteristics

The package characteristics.

(sequence)

The sequence of items below is mandatory. A single instance is required.

Height

Height is optional. A single instance might exist.

The height of the object.

Width

Width is optional. A single instance might exist.

The width of the object.

Length

Length is optional. A single instance might exist.

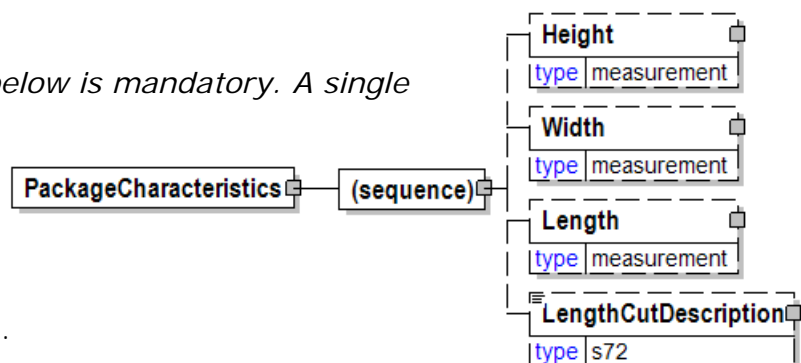

papiNet V2R31

The length of the object.

LengthCutDescription

LengthCutDescription is optional. A single instance might exist.

Length Cut Description

PackageCode

This element is used to identify the package code or identifier. This code can be no-standard and vary among companies or it can be assigned by a recognized agency.

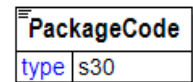

PackageIdentifier

The identifier of the productpackage (such as reel ID or pallet ID) that is used along with the

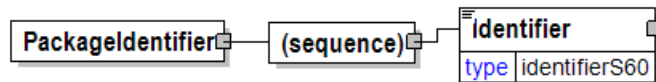

PurchaseOrderLineItemNumber to call off the product.

(sequence)

The sequence of items below is mandatory. A single instance is required.

Identifier

Identifier is mandatory. A single instance is required.

An Identifier is required for packages and items (pallets, reel packages, boxes, ream items, reel items, etc). The Identifier element contains the actual item identifier code. Identifier is repeatable so more than one identifier can be communicated. For example, the printed identifier on a label may be different from the barcode printed on the label.

PackageIDInformation

Group element identifying a lumber (wood) package. The package name may also be communicated.

PackageAgency [attribute]

PackageAgency is optional. A single instance might exist.

LumberAgency identifies which agency is responsible for assigning the lumber attributes.

Refer to PackageAgency definition for any enumerations.

(sequence)

The sequence of items below is mandatory. A single instance is required.

PackageCode

PackageCode is optional. A single instance might exist.

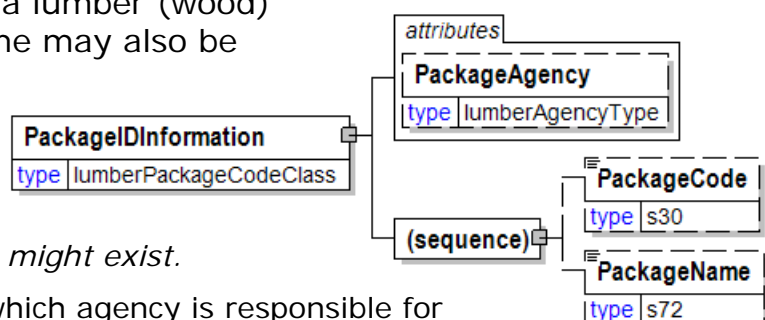

papiNet V2R31

This element is used to identify the package code or identifier. This code can be non-standard and vary among companies or it can be assigned by a recognized agency.

PackageName

PackageName is optional. A single instance might exist.

Element used to identify the name of a package.

PackageInformation

The purpose of the PackageInformation structure is to clearly identify physical handling items that constitute the delivery.

PackageInformation is the highest level of product packaging it describes the shipping or warehousing unit.

If you are communicating a package, usually for logistics or transport purposes, you should include the PackageType, Identifier, ItemCount, and Quantity. (Note: you still have the ability to describe the item with one of the "named" items.)

If you are communicating one of the named Items there is no need to include PackageType, Identifier, ItemCount, and Quantity.

Since either of these two approaches can be used the entire contents of this element are optional even though the parent may be required. It is expected that you will fill in the appropriate details.

PackageType [attribute]

PackageType is optional. A single instance might exist.

Communicates the configuration of the item being reported.

Refer to PackageType definition for any enumerations.

MixedProductPalletIndicator [attribute]

MixedProductPalletIndicator is optional. A single instance might exist.

Specifies whether a product can be mixed with other products on the same pallet

Refer to MixedProductPalletIndicator definition for any enumerations.

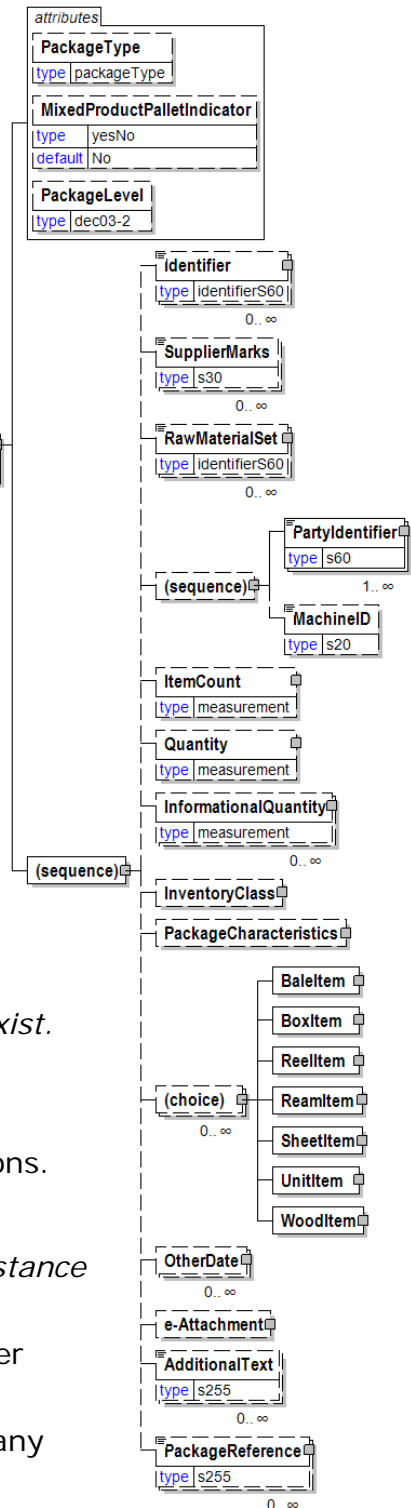
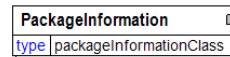

PackageLevel [attribute]

PackageLevel is optional. A single instance might exist.

An hierarchical numbering approach that communicates containerization and identity.

(sequence)

The sequence of items below is mandatory. A single instance is required.

Identifier

Identifier is optional. Multiple instances might exist.

An Identifier is required for packages and items (pallets, reel packages, boxes, ream items, reel items, etc). The Identifier element contains the actual item identifier code. Identifier is repeatable so more than one identifier can be communicated. For example, the printed identifier on a label may be different from the barcode printed on the label.

SupplierMarks

SupplierMarks is optional. Multiple instances might exist.

Supplier provided markings.

RawMaterialSet

RawMaterialSet is optional. Multiple instances might exist.

This identifier derived element indicates a grouping of raw materials that were used to manufacture the product.

(sequence)

The sequence of items below is optional. A single instance might exist.

PartyIdentifier

PartyIdentifier is mandatory. One instance is required, multiple instances might exist.

A unique identifier of a specific party. This element contains an attribute PartyIdentifierType that indicates the type of party.

MachineID

MachineID is optional. A single instance might exist.

An identifier assigned to the particular machine being referenced. For example, a machine could be a paper machine, an off-line coater, a sheeter, or a printing press. The particular machine being referenced will be determined by the business event being supported.

ItemCount

ItemCount is optional. A single instance might exist.

A count of the number of items (examples: a count of the number of boxes on a pallet or of reams in a box).

Quantity

Quantity is optional. A single instance might exist.

The Quantity element contains attributes that provide information about the type of quantity that is being communicated, the context in which the particular quantity is to be viewed, and (if the quantity represents an adjustment) an adjustment type.

The Quantity element contains three child elements that enable you to communicate a range of values for the quantity and a target or actual value. It is at

this level (Value, RangeMin, and RangeMax) that the unit of measure is specified. This permits the range to be specified in a different unit of measure than the target.

InformationalQuantity

InformationalQuantity is optional. Multiple instances might exist.

A quantity given in a valid UOM used for information purposes only (not for calculation). For example, an ordered quantity was 100 reels as opposed to the invoice quantity of 20,000 pounds.

InventoryClass

InventoryClass is optional. A single instance might exist.

A group item containing information about status of inventory and goods items.

PackageCharacteristics

PackageCharacteristics is optional. A single instance might exist.

The package characteristics.

(choice)

[choice] is optional because of choice construct.

BaleItem

BaleItem is optional because of choice construct.

An individual bale included as part of a delivery.

BoxItem

BoxItem is optional because of choice construct.

A four-sided container for reams or sheet items. A pallet can contain zero or more boxes. The term Carton is a synonym for BoxItem. The term "Box" is used as constraint within the ItemType attribute of the UsageLineItemDetail to refer to a box that contains other boxes.

ReelItem

ReelItem is optional because of choice construct.

A group item representing details of an actual (as opposed to specified) reel. One or several reels can be contained in a package.

ReamItem

ReamItem is optional because of choice construct.

A wrapped quantity of SheetItem(s).

SheetItem

SheetItem is optional because of choice construct.

A group item consisting potentially of the date the sheets were converted into sheets and/or packaged or finished.

UnitItem

UnitItem is optional because of choice construct.

Unit Item.

WoodItem

WoodItem is optional because of choice construct.

Group element containing elements describing a wood industry product.

OtherDate

OtherDate is optional. Multiple instances might exist.

A date that may not be specifically detailed within a document (example: print date at the PurchaseOrderLineItem).

e-Attachment

e-Attachment is optional. A single instance might exist.

e-Attachment enables the sender to provide information about attachments to the document.

Note: BizTalk users may have problems in processing this element. See the papiNet FAQs (papiNet.org) for more information.

AdditionalText

AdditionalText is optional. Multiple instances might exist.

A text field that is used to communicate information not previously defined or for special instructions. To be used only for circumstances not covered by specific elements.

PackageReference

PackageReference is optional. Multiple instances might exist.

An element detailing the relevant references pertaining to a package. The type of reference is identified by the attributes PackageReferenceType and AssignedBy.

PackageLevel [attribute]

An hierarchical numbering approach that communicates containerization and identity.

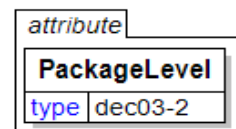

PackageMeasuringInfo

A grouping element that contains information about a measured package or a measured load when the load is treated as one package.

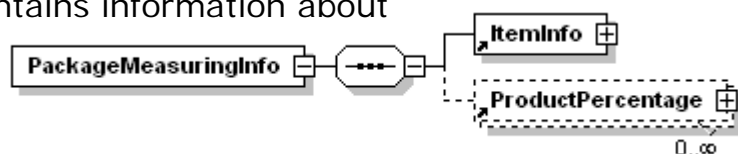

(sequence)

The sequence of items below is mandatory. A single instance is required.

ItemInfo

ItemInfo is mandatory. A single instance is required.

A grouping element that contains information about an item. The attribute ItemType defines the type of physical item. Item Info describes property values of an item as well as tracking information between items processed in the supply chain.

ProductPercentage

ProductPercentage is optional. Multiple instances might exist.

The quantity of a product in percentage of the total quantity for an item containing

many products.

PackageName

Element used to identify the name of a package.

PackageName	
type	s72

PackageReference

An element detailing the relevant references pertaining to a package. The type of reference is identified by the attributes PackageReferenceType and AssignedBy.

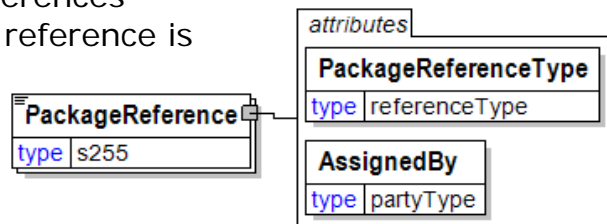

PackageReferenceType [attribute]

PackageReferenceType is mandatory. A single instance is required.

PackageReferenceType provides a contextual explanation of the specific reference identifier. Many items are currently prefixed by "Buyer", "Customer", "Seller", and/or "Supplier". Check for an existing non-prefixed version and use the non-prefixed version instead. In the (yet to be announced release date) version 3.0 the prefixed versions will be removed. Instead the attribute @AssignedBy will communicate the information previously communicated in the prefix.

Refer to PackageReferenceType definition for any enumerations.

AssignedBy [attribute]

AssignedBy is optional. A single instance might exist.

Identifies the type of party that has assigned the associated item, e.g. a reference of type OrderNumber.

Refer to AssignedBy for any enumerations.

PackageReferenceType [attribute]

PackageReferenceType provides a contextual explanation of the specific reference identifier. Many items are currently prefixed by "Buyer", "Customer", "Seller", and/or "Supplier". Check for an existing non-prefixed version and use the non-prefixed version instead. In the (yet to be announced release date) version 3.0 the prefixed versions will be removed. Instead the attribute @AssignedBy will communicate the information previously communicated in the prefix.

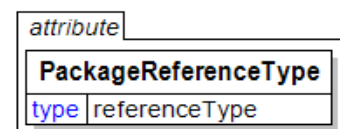

Refer to the [referenceType](#) entry for the list of enumerations and their definitions.

PackagesPerWrap

The number of packages wrapped together.

PackagesPerWrap
type nni2

PackageType [attribute]

Communicates the configuration of the item being reported.

This item is restricted to the following list.

attribute
PackageType
type packageType

Bag

A container of flexible material used for storage.

Bale

Unbound materials bulk packed without pieces of board and at least 1 band

Barrel

A large cylindrical container.

Box

Note: Box is the papiNet way of referring to a Carton

Bundle

Unbound materials bulk packed with pieces of board at each end and at least 1 band

Container

Crate

A shipping container used for storage.

Drum

FullWoodPackage

HalfWoodPackage

LengthPackage

Package contains pieces of a single length.

Lift

LogPile

A pile of logs (a virtual type of package).

LooseVolumeItem

A unit containing loose volume products (during transports) (a type of virtual package).

Pail

Pallet

A portable platform.

Piece

PulpUnit

ReelPackage

StepPackage

Package in which pieces are group together by length, with longest length at the bottom of the package and shortest on top.

TruckPackage

Package contains pieces of mixed random lengths.

UnformedPulp

Vehicle

PackageType

Communicates the configuration of the item being reported.

PackageType
type packageType

This item is restricted to the following list.

Bag

A container of flexible material used for storage.

Bale

Unbound materials bulk packed without pieces of board and at least 1 band

Barrel

A large cylindrical container.

Box

Note: Box is the papiNet way of referring to a Carton

Bundle

Unbound materials bulk packed with pieces of board at each end and at least 1 band

Container

Crate

A shipping container used for storage.

Drum

FullWoodPackage

HalfWoodPackage

LengthPackage

Package contains pieces of a single length.

Lift

LogPile

A pile of logs (a virtual type of package).

Pail

Pallet

A portable platform.

Piece

PulpUnit

ReelPackage

StepPackage

Package in which pieces are group together by length, with longest length at the bottom of the package and shortest on top.

TruckPackage

Package contains pieces of mixed random lengths.

UnformedPulp

Vehicle

Packaging

Type of a package that includes individual products.

(sequence)

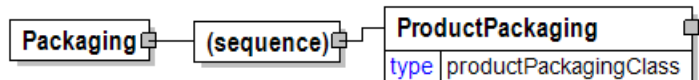

The sequence of items below is mandatory. A single instance is required.

ProductPackaging

ProductPackaging is mandatory. A single instance is required.

Defines the methods and materials used for packaging.

PackagingCharacteristics

An element containing carton or pallet packing information. PackagingCharacteristics can either have the BoxCharacteristics or

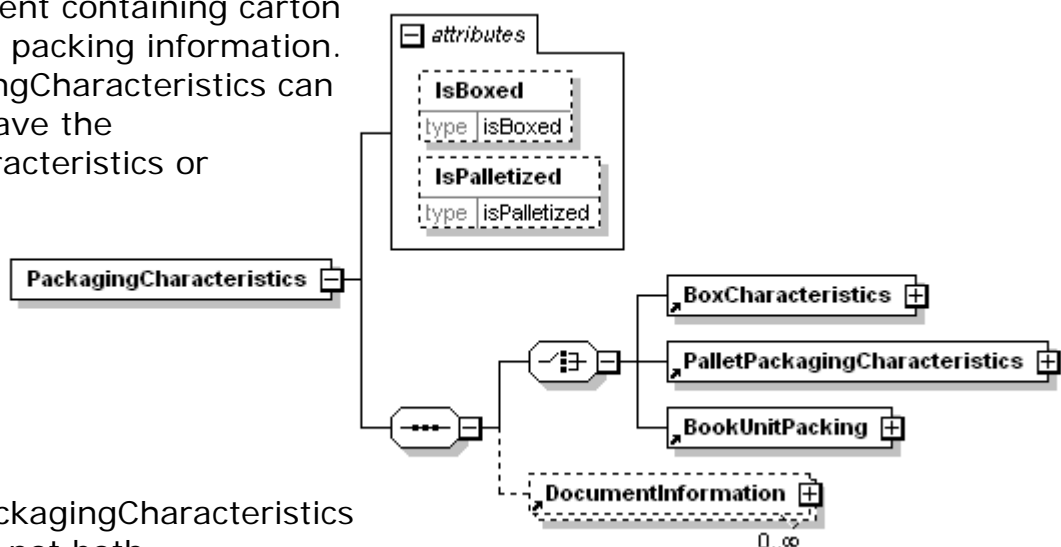

PalletPackagingCharacteristics element not both.

IsBoxed [attribute]

IsBoxed is optional. A single instance might exist.

Refer to IsBoxed definition for any enumerations.

IsPalletized [attribute]

IsPalletized is optional. A single instance might exist.

The buyer's directions for how the item is to be palletized.

Refer to IsPalletized definition for any enumerations.

(choice)

[choice] is optional because of choice construct.

BoxCharacteristics

BoxCharacteristics is optional because of choice construct.

BoxCharacteristics is a group element that contains information about the box (or carton)

PalletPackagingCharacteristics

PalletPackagingCharacteristics is optional because of choice construct.

PalletPackagingCharacteristics details the characteristics of the packaging for a pallet.

BookUnitPacking

BookUnitPacking is optional because of choice construct.

Book unit packing information

DocumentInformation

DocumentInformation is optional. Multiple instances might exist.

A group element containing a specification of required documents in the business process. Additional free text to be printed on documents can also be specified.

PackagingCode

PackagingCode is a code describing the packaging of the product.

Agency [attribute]

Agency is mandatory. A single instance is required.

Describes the agency maintaining the list of codes. To be included in this list the agency must be a recognized standards body or industry organisation.

For the element that owns this attribute.

For another attribute in the list of attributes associated with the parent element.

Refer to Agency definition for any enumerations.

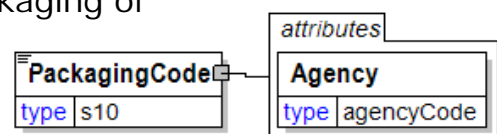

PackagingCodeSpecification

A grouping element specifying code and description for packaging details.

(sequence)

The sequence of items below is mandatory. A single instance is required.

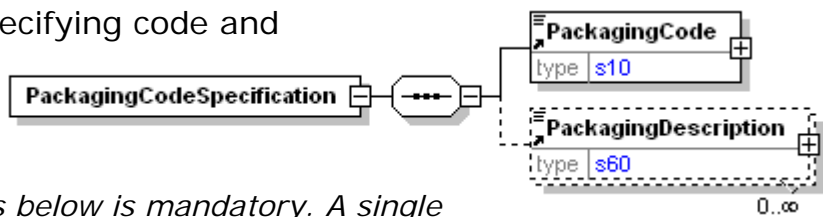

PackagingCode

PackagingCode mandatory. A single instance is required.

PackagingCode is a code describing the packaging of the product.

PackagingDescription

PackagingDescription is optional. Multiple instances might exist.

A text field element describing the packaging of a product A text field element describing the packaging of a product.

PackagingDescription

A text field element describing the packaging of a product.

Language [attribute]

Language is optional. A single instance might exist.

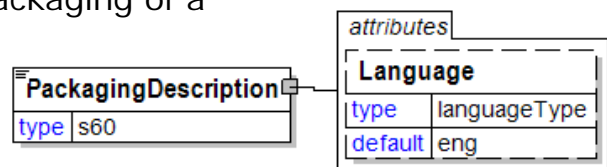

XML has embraced 2 and 3 digit language codes through the application of an addendum to the standard.

Refer to Language definition for any enumerations.

PackagingInformation

Group element construct used to all information associated with the packaging of a product. Measurements, package ID, label, stencil, band, pallet and wrap characteristics may all be detailed.

(sequence)

The sequence of items below is mandatory. A single instance is required.

QuantityInUnit

QuantityInUnit is optional. A single instance might exist.

Used to identify the number of items packed within this package unit.

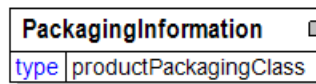

UnitDimension

UnitDimension is optional. A single instance might exist.

Unit Dimension

Weight

Weight is optional. A single instance might exist.

The weight of the item.

PackageIDInformation

PackageIDInformation is optional. A single instance might exist.

Group element identifying a lumber (wood) package. The package name may also be communicated.

LabelCharacteristics

LabelCharacteristics is optional. Multiple instances might exist.

A group item that organises the labeling information.

StencilCharacteristics

StencilCharacteristics is optional. Multiple instances might exist.

A group element specifying attributes of a stencil to be applied to an item, and optional text.

BandCharacteristics

BandCharacteristics is optional. Multiple instances might exist.

A group item that organises the packaging band detail information.

PalletCharacteristics

PalletCharacteristics is optional. Multiple instances might exist.

A group item that provides pallet detail information.

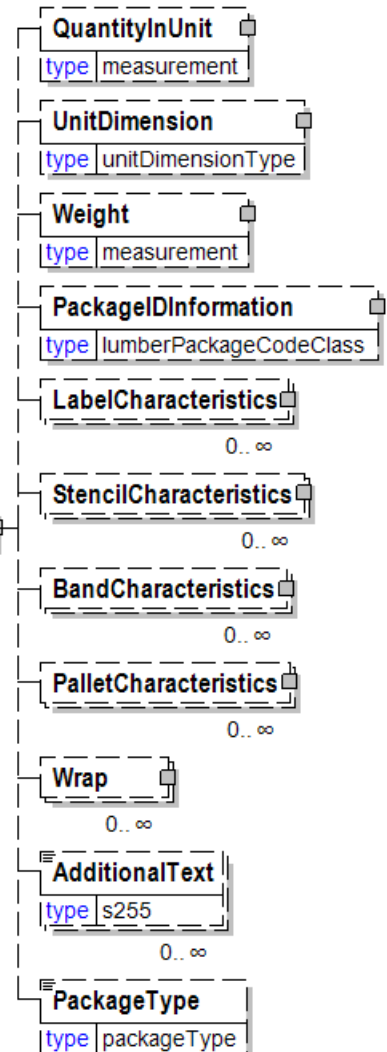

Wrap

Wrap is optional. Multiple instances might exist.

A group item that organises wrapping detail information.

AdditionalText

AdditionalText is optional. Multiple instances might exist.

A text field that is used to communicate information not previously defined or for special instructions. To be used only for circumstances not covered by specific elements.

PackageType

PackageType is optional. A single instance might exist.

Communicates the configuration of the item being reported.

Refer to PackageType definition for any enumerations.

PackingList

The PackingList element is the root element for the PackingList e-Document.

The PackingList e-Document specifies the details of a shipment that is being despatched. The seller should send the PackingList e-Document in sufficient time so that the recipient can process the information before the goods arrive. The recipient can then prepare efficiently for the receipt of the goods.

PackingListStatusType [attribute]

PackingListStatusType is mandatory. A single instance is required.

Attribute is used to identify the PackingList status.

Refer to PackingListStatusType definition for any enumerations.

Reissued [attribute]

Reissued is optional. A single instance might exist.

Either "Yes" or "No".

Refer to Reissued definition for any enumerations.

Language [attribute]

Language is optional. A single instance might exist.

XML has embraced 2 and 3 digit language codes through the application of an addendum to the standard.

Refer to Language definition for any enumerations.

(sequence)

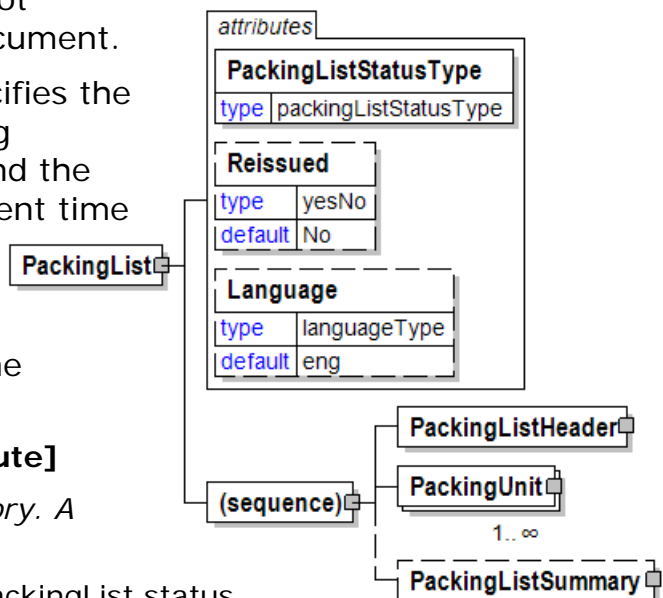

The sequence of items below is mandatory. A single instance is required.

PackingListHeader

PackingListHeader is mandatory. A single instance is required.

Information that is applicable to every item on the PackingList e-Document.

PackingUnit

PackingUnit is mandatory. One instance is required, multiple instances might exist.

Describes the major unit of packing the materials in the shipment.

PackingListSummary

PackingListSummary is optional. A single instance might exist.

PackingListSummary contains summary information applicable to the entire PackingList.

PackingListDate

Used to identify the issue date of the PackingList transaction.

(sequence)

The sequence of items below is mandatory. A single instance is required.

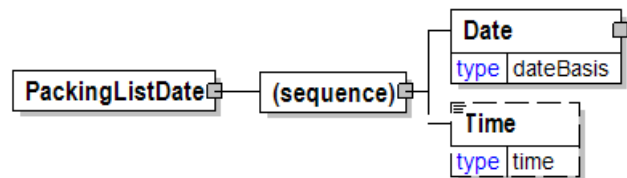

Date

Date is mandatory. A single instance is required.

A group element that contains the specification of Year, Month, and Day.

Time

Time is optional. A single instance might exist.

Times are treated in a standard XML fashion with a special case used to indicate a generalized "local" time. The standard XML approach to time is hh:mm:ss, hh:mm:ssZ, or hh:mm:ss±hh:mm.

hh:mm:ss±hh:mm is used to represent a time with a time zone. The time zone is communicated as the number of hours offset from the Universal Time Coordinate (UTC), a.k.a. Greenwich Mean Time.

hh:mm:ssZ indicates the time at Zulu (another name for UTC). Based on the convention described in the next bullet it will be important for users within UTC to use "Z" when communicating a time in their time zone to other users.

hh:mm:ss or hh:mm indicates in the XML standard the time at UTC however, within papiNet it is used to represent the applicable local time. Caution should be used when processing times of this nature as the papiNet approach may be in discord with other users of XML.

PackingListHeader

Information that is applicable to every item on the PackingList e-Document.

(sequence)

The sequence of items below is mandatory. A single instance is required.

PackingListNumber

PackingListNumber is mandatory. A single instance is required.

The PackingList identifying number.

TransactionHistoryNumber

TransactionHistoryNumber is optional. A single instance might exist.

A sequential number that keeps track of the version of a document being sent by the document originator except in the case where

TransactionHistoryConfirmation is used, in which case the TransactionHistoryNumber refers to the trigger transaction for which the confirmation is being sent.

PackingListDate

PackingListDate is mandatory. A single instance is required.

Used to identify the issue date of the PackingList transaction.

PackingListReference

PackingListReference is optional. Multiple instances might exist.

Element used to identify any external or associated documents, identifiers, etc.

BuyerParty

BuyerParty is mandatory. A single instance is required.

The legal entity to which the product is sold. Also commonly referred to as the sold-to party or customer. If no OtherParty is defined as the Payer, the Buyer is the Payer.

BillToParty

BillToParty is optional. A single instance might exist.

The address where the invoice is to be sent.

SupplierParty

SupplierParty is mandatory. A single instance is required.

The organisation or business entity responsible for providing the product. SupplierParty is also the seller of the product, if Seller is not specified as OtherParty = Seller.

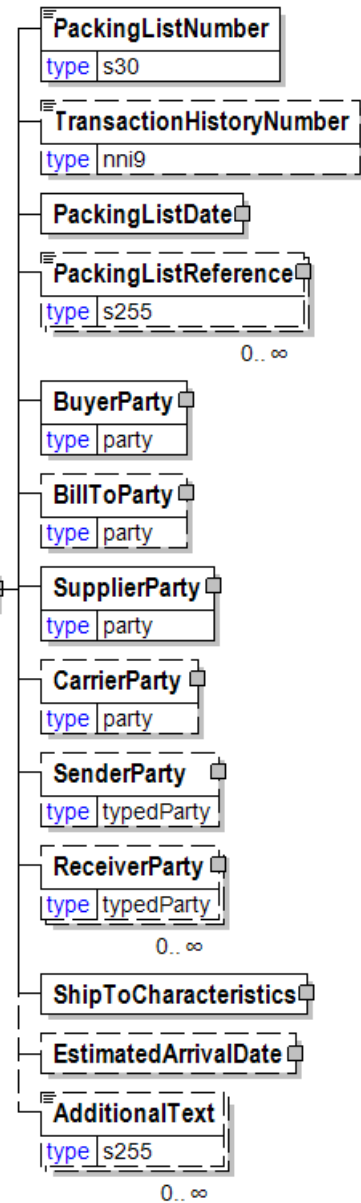

CarrierParty

CarrierParty is optional. A single instance might exist.

The party performing the transport of the product from the pickup location to the ship-to location; could be a hauler.

SenderParty

SenderParty is optional. A single instance might exist.

The business entity issuing the e-Document, the source of the document.

The entity responsible for the content. If the sender party has out sourced the message service to a third party the SenderParty is the issuer of the e-Document and not the party performing the transmission service of the electronic message.

ReceiverParty

ReceiverParty is optional. Multiple instances might exist.

The business entity for whom the e-Document is intended, the destination of the document.

The entity interested in the content. If the receiver party has outsourced the message service to a third party the ReceiverParty is the intended party for the e-Document and not the party performing the receiving service of the electronic message.

ShipToCharacteristics

ShipToCharacteristics is mandatory. A single instance is required.

A group item that provides information important for the Ship-To Party.

A group item that provides information important for the Ship-To Party. ShipToCharacteristics may be referenced at both the header and line item level. The reference at the header is required and acts as a default for the value at the line level, unless overridden at the line level.

EstimatedArrivalDate

EstimatedArrivalDate is optional. A single instance might exist.

An estimation of the arrival date.

AdditionalText

AdditionalText is optional. Multiple instances might exist.

A text field that is used to communicate information not previously defined or for special instructions. To be used only for circumstances not covered by specific elements.

PackingListItem

The required element PackingListItem refers to one and only one PurchaseOrder and one and only one PurchaseOrderLineItem of that PurchaseOrder.

PackingListItemType [attribute]

PackingListItemType is mandatory. A single instance is required.

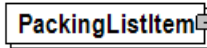

This attribute is used to identify the type of package configuration the item is. To help with physical identification.

Refer to PackingListItemType definition for any enumerations.

(sequence)

The sequence of items below is mandatory. A single instance is required.

PackingListItemNumber

PackingListItemNumber is mandatory. A single instance is required.

Used to uniquely identify this item within the PackingList.

Identifier

Identifier is optional. Multiple instances might exist.

An Identifier is required for packages and items (pallets, reel packages, boxes, ream items, reel items, etc). The Identifier element contains the actual item identifier code. Identifier is repeatable so more than one identifier can be communicated. For example, the printed identifier on a label may be different from the barcode printed on the label.

PurchaseOrderInformation

PurchaseOrderInformation is mandatory. A single instance is required.

A group item containing information unique to this PurchaseOrder, which is provided by the buyer. PurchaseOrderInformation can be optional in the supply chain. Invoices are created without having a PurchaseOrder in Vendor Managed Inventory. Freight invoices also will not have a PurchaseOrder number.

PurchaseOrderLineItemNumber

PurchaseOrderLineItemNumber is optional. A single instance might exist.

The sequential number that uniquely identifies the PurchaseOrder line item.

PackingListReference

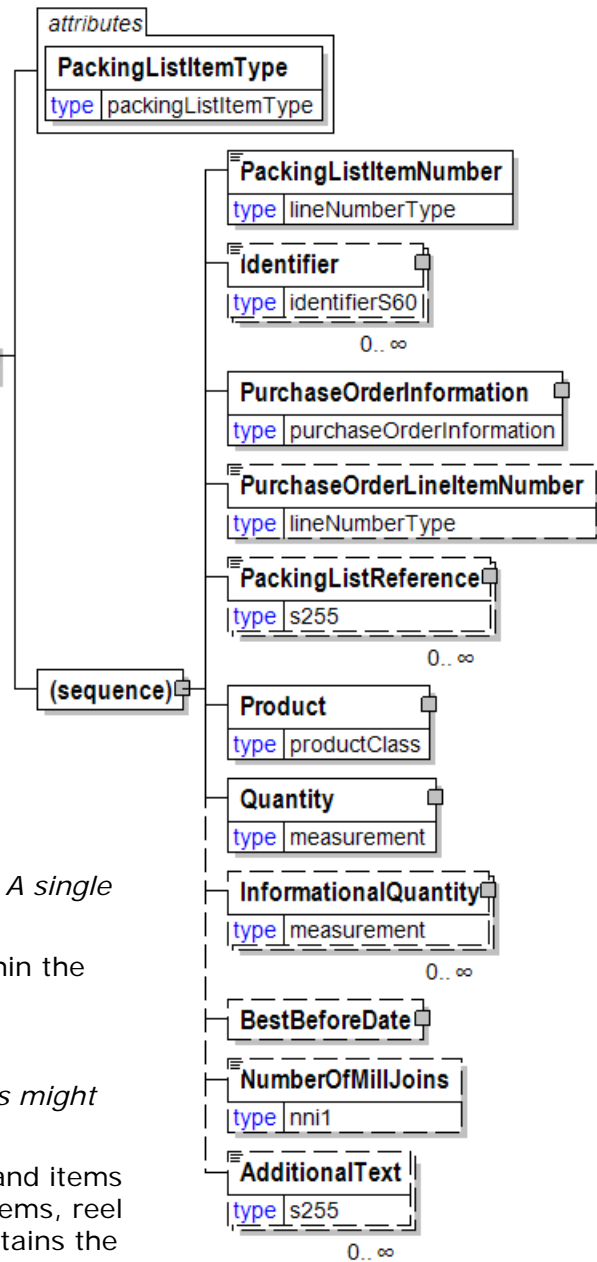

papiNet V2R31

PackingListReference is optional. Multiple instances might exist.

Element used to identify any external or associated documents, identifiers, etc.

Product

Product is mandatory. A single instance is required.

Product is a group item defining the article and its characteristics. Product is used to specify product characteristics organized by ProductIdentifier, ProductDescription, and Classification. Book Manufacturing, Label Stock, Paper, Pulp, Recovered Paper, Wood Products, and Virgin Fibre market segments have defined their product characteristics and conversion features for implementation in papiNet.

Quantity

Quantity is mandatory. A single instance is required.

The Quantity element contains attributes that provide information about the type of quantity that is being communicated, the context in which the particular quantity is to be viewed, and (if the quantity represents an adjustment) an adjustment type.

The Quantity element contains three child elements that enable you to communicate a range of values for the quantity and a target or actual value. It is at this level (Value, RangeMin, and RangeMax) that the unit of measure is specified. This permits the range to be specified in a different unit of measure than the target.

InformationalQuantity

InformationalQuantity is optional. Multiple instances might exist.

A quantity given in a valid UOM used for information purposes only (not for calculation). For example, an ordered quantity was 100 reels as opposed to the invoice quantity of 20,000 pounds.

BestBeforeDate

BestBeforeDate is optional. A single instance might exist.

The date, prior to which, the product is suggested to be used.

NumberOfMillJoins

NumberOfMillJoins is optional. A single instance might exist.

The number of joins in the reel.

AdditionalText

AdditionalText is optional. Multiple instances might exist.

A text field that is used to communicate information not previously defined or for special instructions. To be used only for circumstances not covered by specific elements.

PackingListItemNumber

Used to uniquely identify this item within the PackingList.

PackingListItemNumber
type lineNumberType

PackingListItemType [attribute]

This attribute is used to identify the type of package configuration the item is. To help with physical identification.

This item is restricted to the following list.

- Box**
- Ream**
- Reel**
- Sheet**
- Other**

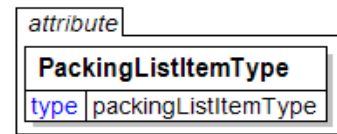

PackingListNumber

The PackingList identifying number.



PackingListReference

Element used to identify any external or associated documents, identifiers, etc.

PackingListReferenceType [attribute]

PackingListReferenceType is mandatory. A single instance is required.

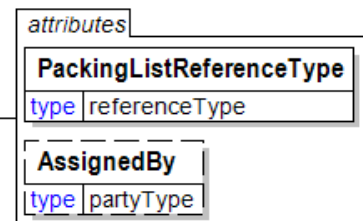

Provides a contextual explanation of the specific reference identifier. Many items are currently prefixed by "Buyer", "Forwarder", "Manufacturer", "Mill", "Seller", "Supplier", "Warehouse", or "Vendor". Check for an existing non-prefixed version and use the non-prefixed version instead. In the (yet to be announced release date) version 3.0 the prefixed versions will be removed. Instead the attribute @AssignedBy will communicate the information previously communicated in the prefix.

Refer to PackingListReferenceType definition for any enumerations.

AssignedBy [attribute]

AssignedBy is optional. A single instance might exist.

Identifies the type of party that has assigned the associated item, e.g. a reference of type OrderNumber.

Refer to AssignedBy for any enumerations.

PackingListReferenceType [attribute]

Provides a contextual explanation of the specific reference identifier. Many items are currently prefixed by "Buyer", "Forwarder", "Manufacturer", "Mill", "Seller", "Supplier", "Warehouse", or "Vendor". Check for an existing non-prefixed version and use the non-prefixed version instead. In the (yet to be announced release date) version 3.0 the prefixed versions will be removed. Instead the attribute @AssignedBy will communicate the information previously communicated in the prefix.

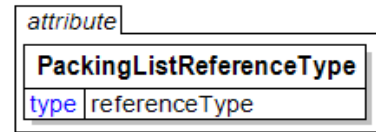

Refer to the [referenceType](#) entry for the list of enumerations and their definitions.

PackingListStatusType [attribute]

Attribute is used to identify the PackingList status.

This item is restricted to the following list.



Cancelled

The supplied information has been cancelled. Items that have been cancelled are not included in totals on the summary levels of the e-Document.

Original

The supplied information is the first version of that information.

Replaced

The supplied information is replacing earlier supplied information. The receiver should revalidate the information in their system based upon the entire information received.

PackingListSummary

PackingListSummary contains summary information applicable to the entire PackingList.

(sequence)

The sequence of items below is mandatory. A single instance is required.

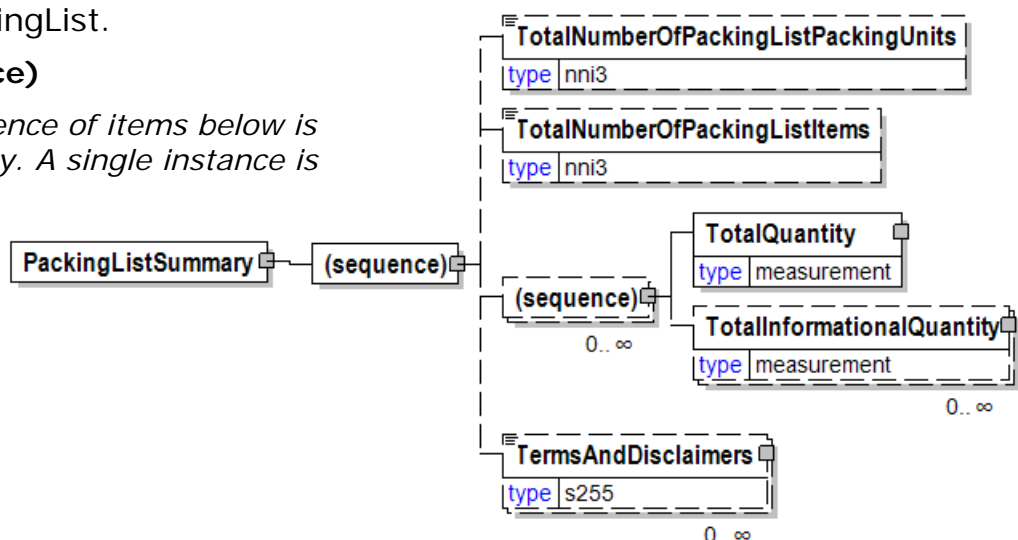

TotalNumberOfPackingListPackingUnits

TotalNumberOfPackingListPackingUnits is optional. A single instance might exist.

TotalNumberOfPackingListPackingUnits

TotalNumberOfPackingListItems

TotalNumberOfPackingListItems is optional. A single instance might exist.

Total Number Of PackingList Items

(sequence)

The sequence of items below is optional. Multiple instances might exist.

TotalQuantity

TotalQuantity is mandatory. A single instance is required.

The total quantity of similar items in the e-Document. TotalQuantity is primarily used in the summary section of documents where it is repeatable to permit totaling for different units of measure.

TotalInformationalQuantity

TotalInformationalQuantity is optional. Multiple instances might exist.

A quantity that is used to communicate related information about the parent element. This element represents a total that is derived from individual line items.

TermsAndDisclaimers

TermsAndDisclaimers is optional. Multiple instances might exist.

An element that contains legal information with an indication of what the Language is.

PackingUnit

Describes the major unit of packing the materials in the shipment.

PackingUnitType [attribute]

PackingUnitType is mandatory. A single instance is required.

Attribute used to identify the type of this packing unit.

Refer to PackingUnitType definition for any enumerations.

(sequence)

The sequence of items below is mandatory. A single instance is required.

PackingUnitSerialNumber

PackingUnitSerialNumber is mandatory. A single instance is required.

The serial number of the packing unit.

Identifier

Identifier is mandatory. One instance is required, multiple instances might exist.

An Identifier is required for packages and items (pallets, reel packages, boxes, ream items, reel items, etc). The Identifier element contains the actual item identifier code. Identifier is repeatable so more than one identifier can be communicated. For example, the printed identifier on a label may be different from the barcode printed on the label.

PackingUnitMeasurements

PackingUnitMeasurements is optional. A single instance might exist.

A group element construct detailing the measurements, height, weight, and length, of the specified packing unit.

PackingListReference

PackingListReference is optional. Multiple instances might exist.

Element used to identify any external or associated documents, identifiers, etc.

Quantity

Quantity is mandatory. A single instance is required.

The Quantity element contains attributes that provide information about the type of quantity that is being communicated, the context in which the particular quantity is to be viewed, and (if the quantity represents an adjustment) an adjustment type.

The Quantity element contains three child elements that enable you to communicate a range of values for the quantity and a target or actual value. It is at this level (Value, RangeMin, and RangeMax) that the unit of measure is specified. This permits the range to be specified in a different unit of measure than the target.

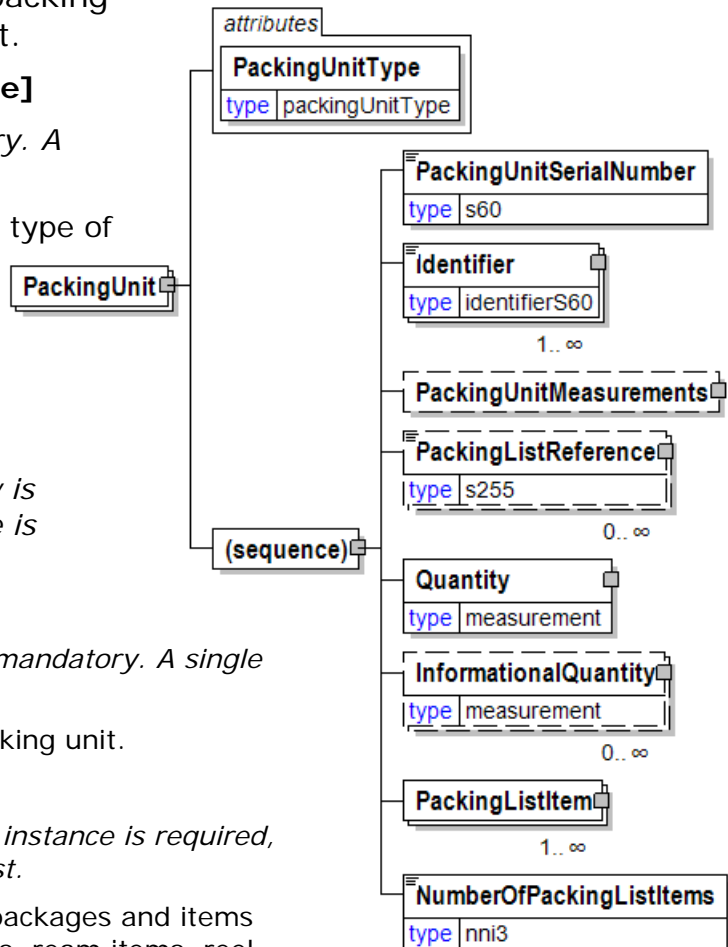

InformationalQuantity

InformationalQuantity is optional. Multiple instances might exist.

A quantity given in a valid UOM used for information purposes only (not for calculation). For example, an ordered quantity was 100 reels as opposed to the invoice quantity of 20,000 pounds.

PackingListItem

PackingListItem is mandatory. One instance is required, multiple instances might exist.

The required element PackingListItem refers to one and only one PurchaseOrder and one and only one PurchaseOrderLineItem of that PurchaseOrder.

NumberOfPackingListItems

NumberOfPackingListItems is mandatory. A single instance is required.

The number of PackingList items in a PackingUnit of the PackingList.

PackingUnitMeasurements

A group element construct detailing the measurements, height, weight, and length, of the specified packing unit.

(sequence)

The sequence of items below is mandatory. A single instance is required.

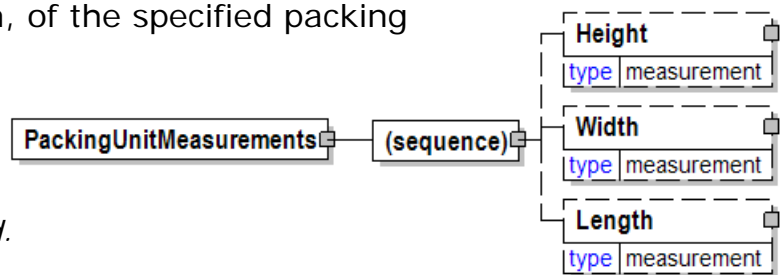

Height

Height is optional. A single instance might exist.

The height of the object.

Width

Width is optional. A single instance might exist.

The width of the object.

Length

Length is optional. A single instance might exist.

The length of the object.

PackingUnitSerialNumber

The serial number of the packing unit.

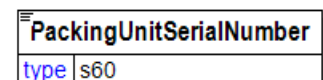

PackingUnitType [attribute]

Attribute used to identify the type of this packing unit.

This item is restricted to the following list.

Container

Pallet

Stack

Other

attribute	
PackingUnitType	
type	packingUnitType

PagesPerSet

Pages per Set

PagesPerSet	
type	nni4

PagesPerSignature

Pages per signature

PagesPerSignature	
type	nni4

Pagination

Number of pages that make up a book.

Pagination	
type	s30

PalletAdditionsType [attribute]

Gives additional characteristics of the pallet

This item is restricted to the following list.

FullPerimeter

The pallet has a full perimeter.

FungicideTreatment

The pallet wood has received a fungicide treatment.

LongSlats

The pallet has long slats.

NoBlockOffset

The pallet is a no-block offset.

Reinforced

The pallet is reinforced.

TrimmedEdges

attribute	
PalletAdditionsType	
type	palletAdditionsType

The pallet has trimmed edges

PalletCharacteristics

A group item that provides pallet detail information.

MixedProductPalletIndicator [attribute]

MixedProductPalletIndicator is optional. A single instance might exist.

Specifies whether a product can be mixed with other products on the same pallet

Refer to MixedProductPalletIndicator definition for any enumerations.

PalletType [attribute]

PalletType is optional. A single instance might exist.

Details the type of pallet that can be used These pallets are common in the industry

Refer to PalletType definition for any enumerations.

PalletLedgeType [attribute]

PalletLedgeType is optional. A single instance might exist.

Details the type of pallet ledges that can be used

Refer to PalletLedgeType definition for any enumerations.

PalletCoverType [attribute]

PalletCoverType is optional. A single instance might exist.

Details the type of cover that can be used on top of the pallet body

Refer to PalletCoverType definition for any enumerations.

PalletAdditionsType [attribute]

PalletAdditionsType is optional. A single instance might exist.

Gives additional characteristics of the pallet

Refer to PalletAdditionsType definition for any enumerations.

PalletTopType [attribute]

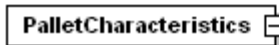
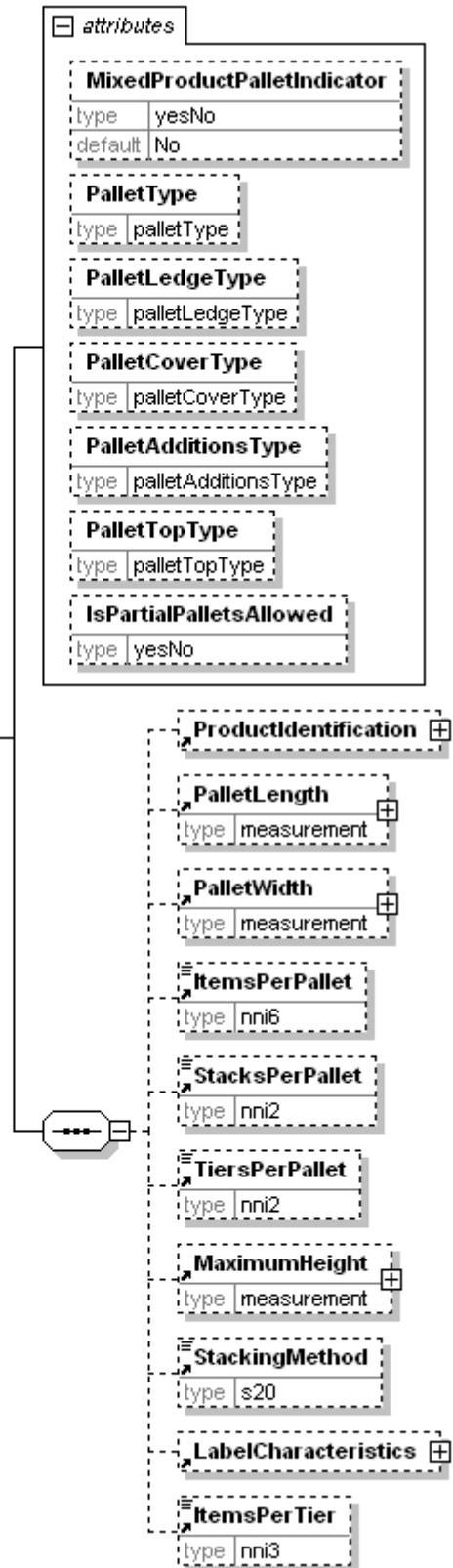

PalletTopType is optional. A single instance might exist.

Details the type of pallet top that can be used

Refer to PalletTopType definition for any enumerations.

IsPartialPalletsAllowed [attribute]

IsPartialPalletsAllowed is optional. A single instance might exist.

Indicates if partial pallets are allowed or not.

This item is restricted to the following list.

Refer to IsPartialPalletsAllowed definition for any enumerations.

(sequence)

The sequence of items below is mandatory. A single instance is required.

ProductIdentification

ProductIdentification is optional. A single instance might exist.

A grouping element designed to communicate product identification related to the parent element that contains this item.

PalletLength

PalletLength is optional. A single instance might exist.

The measurement value of the length of the pallet.

PalletWidth

PalletWidth is optional. A single instance might exist.

The measurement value of the width of the pallet.

ItemsPerPallet

ItemsPerPallet is optional. A single instance might exist.

The number of items on the pallet (either reels or sheet or sheet-package).

StacksPerPallet

StacksPerPallet is optional. A single instance might exist.

The number of stacks on a pallet, where a stack is a vertical arrangement of items (looking down from above).

TiersPerPallet

TiersPerPallet is optional. A single instance might exist.

The number of tiers on the pallet, where a tier is a layer of items.

MaximumHeight

MaximumHeight is optional. A single instance might exist.

The maximum height allowed including the pallet.

StackingMethod

StackingMethod is optional. A single instance might exist.

A text field describing the pattern used when stacking of pallets.

LabelCharacteristics

LabelCharacteristics is optional. A single instance might exist.

A group item that organises the labeling information.

ItemsPerTier

ItemsPerTier is optional. A single instance might exist.

Number of items on each full tier, e.g. number of boxes, gaylords, loose books etc. on a tier on a pallet.

PalletCoverType [attribute]

Details the type of cover that can be used on top of the pallet body

This item is restricted to the following list.

attribute
PalletCoverType
type palletCoverType

MetalPlateWithPE

A metal plate covers the pallet with polyethylene on top.

WithoutPE

The pallet cover is without polyethylene on top.

WithPE

The pallet cover is with polyethylene on top.

WithPEUnderCover

The pallet cover is with polyethylene under the wooden plates.

WoodStripWithPE

The pallet cover is made up from a wood strip with polyethylene on top

WoodStripWithoutPE

The pallet cover is made up from a wood strip without polyethylene on top.

PalletLedgeType [attribute]

Details the type of pallet ledges that can be used

This item is restricted to the following list.

attribute
PalletLedgeType
type palletLedgeType

LongWay

The ledge wood is on the long side of the pallet.

LongWayWithBelt

The ledge wood is on the long side of the pallet, with a packaging belt.

ShortWay

The ledge wood is on the short side of the pallet.

ShortWayWithBelt

The ledge wood is on the short side of the pallet, with a packaging belt

PalletLength

The measurement value of the length of the pallet.

(sequence)

The sequence of items below is mandatory. A single instance is required.

Value

Value is mandatory. A single instance is required.

A numeric value expressed in the unit of measure (UOM).

RangeMin

RangeMin is optional. A single instance might exist.

The minimum value (lower boundary) allowed for the Measurement that is the parent of this element.

RangeMax

RangeMax is optional. A single instance might exist.

The maximum value (upper boundary) allowed for the Measurement that is the parent of this element. Some elements use the RangeMax element with an extended list of unit of measures. (Note: the red colour in the picture is an artifact of how the graphic was captured and should be disregarded.)

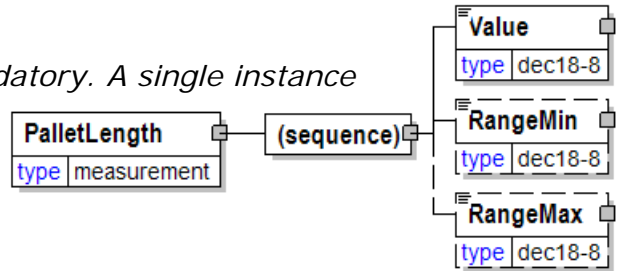

PalletPackagingCharacteristics

PalletPackagingCharacteristics details the characteristics of the packaging for a pallet.

(sequence)

The sequence of items below is mandatory. A single instance is required.

PackagingCode

PackagingCode is optional. A single instance might exist.

PackagingCode is a code describing the packaging of the product.

PackagingDescription

PackagingDescription is optional. A single instance might exist.

A text field element describing the packaging of a product.

WrapCharacteristics

WrapCharacteristics is optional. A single instance might exist.

A group element that contains elements that describe

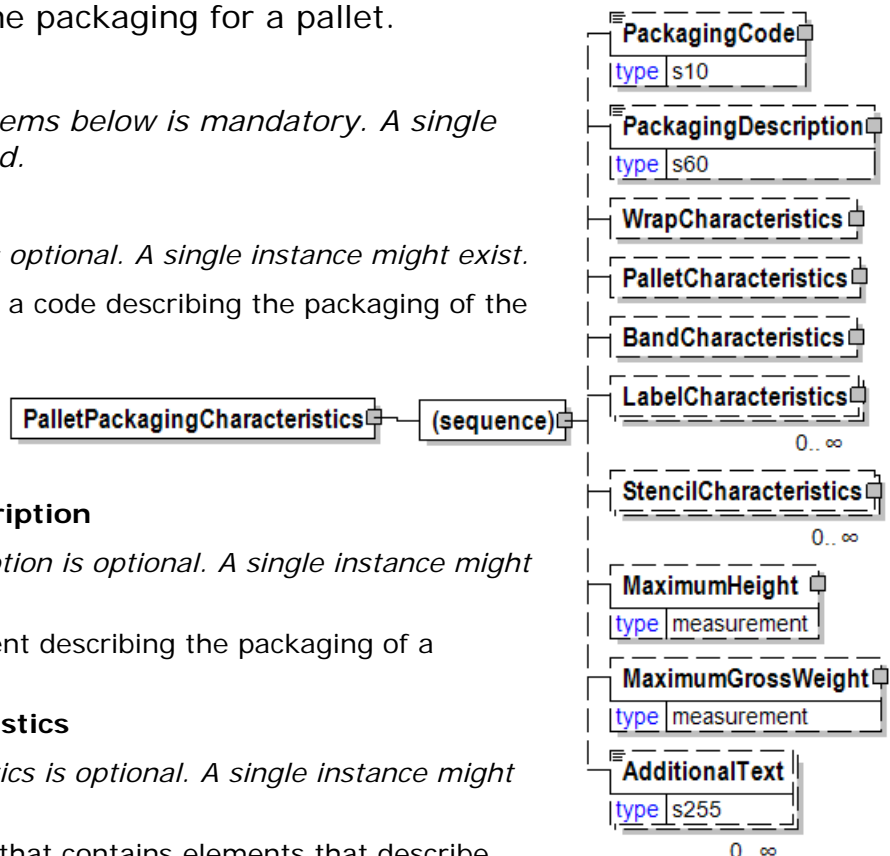

the manner in which the item is wrapped.

PalletCharacteristics

PalletCharacteristics is optional. A single instance might exist.

A group item that provides pallet detail information.

BandCharacteristics

BandCharacteristics is optional. A single instance might exist.

A group item that organises the packaging band detail information.

LabelCharacteristics

LabelCharacteristics is optional. Multiple instances might exist.

A group item that organises the labeling information.

StencilCharacteristics

StencilCharacteristics is optional. Multiple instances might exist.

A group element specifying attributes of a stencil to be applied to an item, and optional text.

MaximumHeight

MaximumHeight is optional. A single instance might exist.

The maximum height allowed including the pallet.

MaximumGrossWeight

MaximumGrossWeight is optional. A single instance might exist.

The maximum weight allowed including the pallet.

AdditionalText

AdditionalText is optional. Multiple instances might exist.

A text field that is used to communicate information not previously defined or for special instructions. To be used only for circumstances not covered by specific elements.

PalletTopType [attribute]

Details the type of pallet top that can be used

This item is restricted to the following list.

CartonboardCover

The pallet top is composed of carton-board

Chipboard

The pallet top is composed of chipboard.

Corrugated

The pallet top is composed of corrugated board.

EdgeProtection

The pallet top has edge protections for the sheets of paper placed on top. They are placed on the top pallet edges.

FiveStripsOfWood

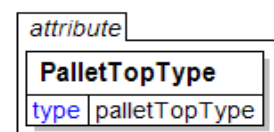

papiNet V2R31

The pallet top is composed of five strips of wood.

FullyCoverThreeCrossBoards

The pallet top is composed of a fully wooden cover with three cross ledges on top.

FungicTreatWoodFrame

The pallet top is composed of a wooden frame, which is treated with fungicide.

OneStripOfWood

The pallet top is composed of one strip of wood.

PlywoodCover

The pallet top is composed of plywood.

TwoStripsOfWood

The pallet top is composed of two strips of wood.

ThreeStripsOfWood

The pallet top is composed of three strips of wood.

WoodenFrame

The pallet top is composed of a wooden frame

PalletType [attribute]

Details the type of pallet that can be used These pallets are common in the industry

This item is restricted to the following list.

Euro

The pallet is the standardized Euro pallet type.

Export

The pallet is the standardized export pallet type.

ISPM15Treated

Specifies that wood pallet must be treated or fumigated according to the ISPM 15 regulation.

NonPalletised

The product is not on a pallet.

NonStop

The pallet is the standardized non-stop pallet type.

Twinned

Two pallets have been joined together

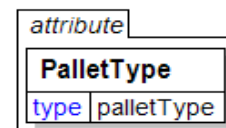

PalletWidth

The measurement value of the width of the pallet.

(sequence)

The sequence of items below is mandatory. A single instance is required.

Value

Value is mandatory. A single instance is required.

A numeric value expressed in the unit of measure (UOM).

RangeMin

RangeMin is optional. A single instance might exist.

The minimum value (lower boundary) allowed for the Measurement that is the parent of this element.

RangeMax

RangeMax is optional. A single instance might exist.

The maximum value (upper boundary) allowed for the Measurement that is the parent of this element. Some elements use the RangeMax element with an extended list of unit of measures. (Note: the red colour in the picture is an artifact of how the graphic was captured and should be disregarded.)

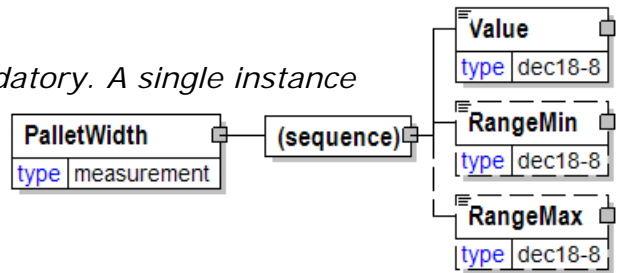

Paper

A group item defining the characteristics of the paper product.

(sequence)

The sequence of items below is mandatory. A single instance is required.

PaperCharacteristics

PaperCharacteristics is optional. A single instance might exist.

The identifying characteristics of paper most important to the ordering of the item. These are the characteristics that, when associated with a given grade, allow the manufacturer to produce but not convert or package, the paper.

(choice)

[choice] is optional because of choice construct.

Reel

Reel is optional because of choice construct.

A group item that contains the conversion and packaging characteristics of a reel.

Sheet

Sheet is optional because of choice construct.

A group item that contains the conversion and packaging characteristics for sheets.

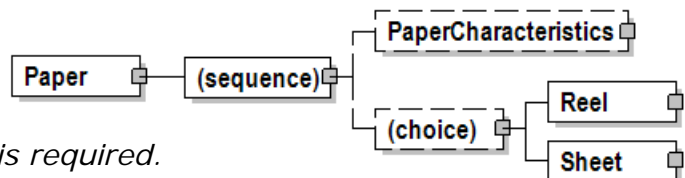

PaperCharacteristics

The identifying characteristics of paper most important to the ordering of the item. These are the characteristics that, when associated with a given grade, allow the manufacturer to produce but not convert or package, the paper.

CoatingTop [attribute]

CoatingTop is optional. A single instance might exist.

Used to specify the type of coating applied to the top or bottom of the paper sheet

Refer to CoatingTop definition for any enumerations.

CoatingBottom [attribute]

CoatingBottom is optional. A single instance might exist.

Used to specify the type of coating applied to the top or bottom of the paper sheet

Refer to CoatingBottom definition for any enumerations.

FinishType [attribute]

FinishType is optional. A single instance might exist.

Defines the finish of a sheet of paper, which means the condition of its surface (refer to Embossing for more information).

Finishes may be produced on or off machine. Finishes that are created off-machine are called embossed. (Embossing is a child element of ReelConversionCharacteristics and SheetConversionCharacteristics.)

Note:

 "Embossed" as a finish type is just a generalized choice for one of the more specific choices listed.

 "Unsupercalendered" as a finish type would be indicated by not communicating a finish type.

Refer to FinishType definition for any enumerations.

PrintType [attribute]

PrintType is optional. A single instance might exist.

Refer to PrintType definition for any enumerations.

(sequence)

The sequence of items below is mandatory. A single instance is required.

Abrasion

Abrasion is optional. Multiple instances might exist.

A group item used to communicate abrasion loss target or test value.

AbsorptionInk

AbsorptionInk is optional. Multiple instances might exist.

A group item used to communicate ink absorption target or test value.

AbsorptionLight



AbsorptionLight is optional. Multiple instances might exist.

A group item used to communicate light absorption target or test value.

AbsorptionWater

AbsorptionWater is optional. Multiple instances might exist.

A group item used to communicate water absorption target or test value.

Appearance

Appearance is optional. Multiple instances might exist.

A group item used to communicate appearance.

Ash

Ash is optional. Multiple instances might exist.

A group item used to communicate the ash content of the product according to a particular TestMethod.

BasisWeight

BasisWeight is optional. Multiple instances might exist.

The weight of the paper expressed as a mass for a given surface area. In countries using the metric system, the basis weight is expressed as the weight in grams of one sheet of paper that is one square meter in area—not dependent on basic sheet size. In countries using the imperial system, the weight is expressed in pounds for a given ProductBasisSizeType.

BendingResistance

BendingResistance is optional. Multiple instances might exist.

Bending resistance

BendingStiffness

BendingStiffness is optional. Multiple instances might exist.

BendingStiffness

Brightness

Brightness is optional. Multiple instances might exist.

A measurement of the degree of light reflectivity of the product.

Bulk

Bulk is optional. Multiple instances might exist.

A group item used to communicate bulking thickness target or test value.

Burst

Burst is optional. Multiple instances might exist.

A group item used to communicate bursting strength target or test value according to a particular TestMethod.

BurstIndex

BurstIndex is optional. Multiple instances might exist.

The burst index.

Caliper

Caliper is optional. Multiple instances might exist.

The thickness of a sheet of paper under standard test conditions.

CoatWeight

CoatWeight is optional. Multiple instances might exist.

A group item used to communicate the coating thickness target or test value according to a particular TestMethod.

ColourDetail

ColourDetail is optional. Multiple instances might exist.

A group item used to communicate details of colour according to the selected colour definition scheme.

Density

Density is optional. Multiple instances might exist.

A group item used to communicate density target or test value according to a particular TestMethod.

Dirt

Dirt is optional. Multiple instances might exist.

A group item used to communicate dirt content target or test value according to a particular TestMethod.

DominantWavelength

DominantWavelength is optional. Multiple instances might exist.

Dominant wavelength

ExcitationPurity

ExcitationPurity is optional. Multiple instances might exist.

Excitation purity

FibreLength

FibreLength is optional. Multiple instances might exist.

A group item used to communicate fibre length target or test value according to a particular TestMethod.

FibreClassification

FibreClassification is optional. Multiple instances might exist.

A group item used to communicate fibre classification according to the specified classification scheme.

Folding

Folding is optional. Multiple instances might exist.

A group item used to communicate folding endurance target or test value according to a particular TestMethod.

Formation

Formation is optional. Multiple instances might exist.

A group item used to communicate sheet formation target or test value according to a particular TestMethod.

Freeness

Freeness is optional. Multiple instances might exist.

Freeness

Friction

Friction is optional. Multiple instances might exist.

A group item used to communicate static and kinetic friction target or test value according to a particular TestMethod.

Gloss

Gloss is optional. Multiple instances might exist.

A group item used to communicate specular gloss target or test value according to a particular TestMethod.

LightScattering

LightScattering is optional. Multiple instances might exist.

A group item used to communicate light scattering coefficients according to a particular TestMethod.

Luminance

Luminance is optional. Multiple instances might exist.

Luminance

Moisture

Moisture is optional. Multiple instances might exist.

Desired percentage, or other indicator, of water in the product at the time of shipment.

Mullen

Mullen is optional. Multiple instances might exist.

Mullen, also called "burst strength", is the amount of pressure required to rupture paper or linerboard when applied to its surface. The unit of measure is KiloPascal (sometimes abbreviated as "kPa").

Opacity

Opacity is optional. Multiple instances might exist.

A group item used to communicate opacity target or test value according to a particular TestMethod.

Permeability

Permeability is optional. Multiple instances might exist.

A group item used to communicate air permeability target or test value according to a particular TestMethod.

pH

pH is optional. Multiple instances might exist.

A group item used to communicate pH (degree of acidity versus basicity) target or test value according to a particular TestMethod.

PlyBond

PlyBond is optional. Multiple instances might exist.

A group item used to communicate internal bond strength target or test value between plies according to a particular TestMethod.

Porosity

Porosity is optional. Multiple instances might exist.

A group item used to communicate a permeability target or test value.

PostConsumerWaste

PostConsumerWaste is optional. Multiple instances might exist.

A group item used to communicate the target or test value percentage of post consumer waste fibre in the product according to a particular TestMethod.

PPI

PPI is optional. Multiple instances might exist.

A group item used to communicate the number of pages in an inch of thickness either as a target or actual value. Equal to the number of sheets per inch times 2.

PreConsumerWaste

PreConsumerWaste is optional. Multiple instances might exist.

A group item used to communicate the target or test value percentage of pre-consumer waste fibre in the product according to a particular TestMethod.

Recycled

Recycled is optional. Multiple instances might exist.

A group item used to communicate the target or test value total percentage of waste fibre in the product according to a particular TestMethod.

Resistance

Resistance is optional. Multiple instances might exist.

A group item used to communicate air resistance target or test value according to a particular TestMethod.

RingCrush

RingCrush is optional. Multiple instances might exist.

Ring Crush

Roughness

Roughness is optional. Multiple instances might exist.

A group item used to communicate surface roughness target or test value according to a particular TestMethod.

RunnabilityIndex

RunnabilityIndex is optional. Multiple instances might exist.

A group item used to communicate the calculated run-ability index target or test value.

ShowThrough

ShowThrough is optional. Multiple instances might exist.

Show through

Sizing

Sizing is optional. Multiple instances might exist.

A group item used to communicate size test of paper by ink resistance target or test value.

Smoothness

Smoothness is optional. Multiple instances might exist.

A group item used to communicate surface smoothness target or test value according to a particular TestMethod.

Stiffness

Stiffness is optional. Multiple instances might exist.

A group item used to communicate stiffness target or test value.

Stretch

Stretch is optional. Multiple instances might exist.

A group item used to communicate stretch target or test value.

SurfaceStrength

SurfaceStrength is optional. Multiple instances might exist.

Surface Strength

TEA

TEA is optional. Multiple instances might exist.

Tensile Energy Absorption.

Tear

Tear is optional. Multiple instances might exist.

A group item used to communicate tearing resistance target or test value according to a particular TestMethod.

TearIndex

TearIndex is optional. Multiple instances might exist.

TearIndex

Tensile

Tensile is optional. Multiple instances might exist.

A group item used to communicate zero-span tensile strength target or test value according to a particular TestMethod.

TensileIndex

TensileIndex is optional. Multiple instances might exist.

Tensile Index

Whiteness

Whiteness is optional. Multiple instances might exist.

A group item used to communicate degree of whiteness target or test value according to a particular TestMethod.

AdditionalTest

AdditionalTest is optional. A single instance might exist.

AdditionalTest exists to enable the inclusion of a test that has not been identified by papiNet.org. It is always a single-instance element so it is very important that users, who come upon a test that papiNet.org has not identified, communicate the need for this test to us at www.papiNet.org.

NumberOfPlies

NumberOfPlies is optional. Multiple instances might exist.

The number of layers of paper product joined together to make the final saleable product.

PlyAttributes

PlyAttributes is optional. Multiple instances might exist.

The characteristics of the plies of paper or tissue. Manufacturing data relevant to each ply that constitutes the final product

PlySet

PlySet is optional. Multiple instances might exist.

PlySet.

PaperSizeType

A field that defines the sheet size using the DIN standard (DINA4, DINA3, and so on).

PaperSizeType	
type	s20

PartyIdentifier

A unique identifier of a specific party. This element contains an attribute PartyIdentifierType that indicates the type of party.

PartyIdentifierType [attribute]

PartyIdentifierType is mandatory. A single instance is required.

Provides a contextual definition for the party identifier value. This party identifier enables the trading partners to use ID codes for the different organisation versus business entities involved in the transaction.

Refer to PartyIdentifierType definition for any enumerations.

Agency [attribute]

Agency is optional. A single instance might exist.

Describes the agency maintaining the list of codes. To be included in this list the agency must be a recognized standards body or industry organisation.

For the element that owns this attribute.

For another attribute in the list of attributes associated with the parent element.

Refer to Agency definition for any enumerations.

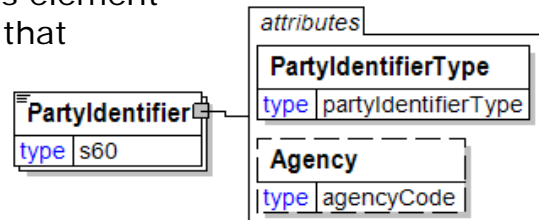

PartyIdentifierType [attribute]

Provides a contextual definition for the party identifier value. This party identifier enables the trading partners to use ID codes for the different organisation versus business entities involved in the transaction.

This item is restricted to the following list.

ABI Number



Associazione Bancaria Italiana – Identifies the bank as an entity in Italy.

ABNNumber

The Australian Business Number (ABN) is a single identifier for dealings with the Australian Taxation Office (ATO). The Australian Business Register assigns it.

AFPA

American Forest and Paper Association identifier.

AssignedByAgency

A unique identifier for the party in question that has been assigned by the agency given in the attribute Agency for the PartyIdentifier. Attribute Agency is mandatory when party identifier type AssignedByAgency is used.

AssignedByBuyer

A unique identifier for the party in question that has been assigned by the buyer (for example, a seller's code).

AssignedByReceiver

A unique identifier for the party in question that has been assigned by the receiver of the e-Document.

AssignedBySeller

A unique identifier for the party in question that has been assigned by the seller (for example, account number for the buyer).

AssignedBySender

A unique identifier for the party in question that has been assigned by the sender of the e-Document.

BankIdentificationCode

A unique country-specific code to identify a bank organisation for electronic transaction. Used to specify the bank routing information needed for electronic remittance. This information is used with the RemitToParty information to effect payment. Examples include:

ACH Number in the United States

Sort Code in the UK

Bankleitzahl in Germany

Code banque/agence in France

BankIdentificationCode should not be mixed up with Bank Identifier Code (BIC). Bank Identifier Code (BIC) is an international standard for identifying Financial Institutions. Please see enumeration SWIFT for more information about BIC.

BankgiroAccountNumber

Defines an account number in the bankgiro system for domestic payments in Sweden. See <http://www.bankgirot.se/> for more information.

CABNumber

Codice Avviamento Bancario – Identifies which branch of the bank in Italy.

ChamberOfCommerceRegistrationNumber

C.C.I.A.A. Number in Italy.

Domicile

Domicile

DunsNumber

A 9-digit identifier maintained by Dun & Bradstreet to uniquely identify a commercial enterprise.

Duns4Number

Similar to the DunsNumber that defines a parent company/organization. The additional 4 digits enable the definition/identification of a sub-entity, such as a mill/plant of this parent company/organisation.

EANNumber

To be deprecated in the next version. Use GlobalLocationNumber instead.

EORI Number

An Economic Operators Registration and Identification Number. This unique identifier for economic operators within European Community must be communicated to customs authorities within European Community as well as to customers. Mandatory since 26 February 2009 for all communication within customs offices. For more information please see

[http://ec.europa.eu/taxation_customs/resources/documents/customs/policy_issues/e-customs_initiative/it_projects/TAXUD1633\(2008\)_rev19_en.pdf](http://ec.europa.eu/taxation_customs/resources/documents/customs/policy_issues/e-customs_initiative/it_projects/TAXUD1633(2008)_rev19_en.pdf)

GlobalLocationNumber

The globally unique EAN-UCC System identification number for legal entities, functional entities and physical locations. The Global Location Number uses the EAN/UCC-13 Data Structure. Details about the structure and usage are available at the <http://www.gs1.org> website.

IBAN

International Banking Account Number. For payments emanating from and destined for abroad, the European banks (ECBS) have agreed to structure bank accounts in a uniform way.

This uniform structure of the account number is known as IBAN (International Bank Account Number). An IBAN consists of the code of the country where the account is held, 2 numeric check digits and a national account number (your traditional account number).

ISO6523Number

This partyidentifier type is defined by ISO 6523, Structure for the Identification of Organizations, which defines the standard for a code to be used for party identification in electronic data interchange. The code is globally unique, because of the used structure. The structure of the identifier is, using xxxx99999999(NNNNN) as the example:

xxxx The International Code Designator (ICD-code) is a fixed-length code of four digits that identifies the authority issuing the ISO 6523 organization code; e.g. 0037 is the ICD-code (International Code Designator) for National Board of Taxes in Finland.

99999999 The organization code consists of up to 14 characters. The Code Designator (defined by ICD-code) defines the use of the organization code. The

papiNet V2R31

used code can be an existing code or, the code designator assigns the code to companies based on request. The Code Designator makes sure that the codes in their list are unique.

(NNNNN) Optional variable length information, to further identify the organization. The use of this is part defined by the code designator.

papiNetGlobalPartyIdentifier

A readily available and free identifier supported by IANA (the Internet Assigned Numbers Authority). Private Enterprise Numbers that conforms to proper URI naming conventions are available, free-of-charge from the Internet Assigned Numbers Authority (IANA). The application form is available at the <http://www.iana.org/cgi-bin/enterprise.pl> website. papiNet will be developing a broader recommendation for party naming in the future however, obtaining an IANA Private Enterprise Number (PEN) will permit globally unique trading partner identification.

PatenteNumber

A unique four-digit assigned to each Mexican Freight broker.

PayeeAccountNumber

Defines the bank account number of the party receiving payment.

PayeeInternalAccountNumber

The company's internal bank which is used to settle payments between internal units. It's not the bank account.

PayeeFinancialInstitution

The designation of the financial institution of the party receiving the payment.

PayerAccountNumber

Defines the bank account number of the party responsible for making the payment.

PayerFinancialInstitution

The designation of the financial institution of the party responsible for making the payment.

PlusgiroAccountNumber

Defines an account number in the plusgiro system for domestic payments in Sweden. See www.plusgirot.se for more information.

RegisterOfCompaniesSubscriptionNumber

Iscrizione al Reg. Imprese Nr. In Italy.

StandardAddressNumber

A 7-digit code to uniquely identify an organisation and its location. The number consists of 6 digits with an 11-modulus check digit as the seventh digit. ISAN is the same with the ISO Country code as a prefix. This identifier is solely used by the book industry.

StandardCarrierAlphaCode

A 4-character code identifying a trucking company. The Washington National Motor Freight Association maintains these codes in the United States.

StockCapital

Capitale Sociale in Italy.

SWIFT

SWIFT also refer to as Bank Identifier Code (BIC) is an international standard for identifying Financial Institutions.

The Bank Identifier Code (BIC) developed by SWIFT is adopted by the International Organization for Standardization (ISO). ISO has appointed SWIFT as the registration authority for the assignment of BICs (ISO 9362) and for the publication of BICs in the BIC Directory.

There are two types of BIC, 8 character BIC and 11 character BIC. The 8 character BIC identifies a financial institution in a country or a location. The 11 character BIC identifies the financial institution's branch.

For more information please see

http://www.swift.com/biconline/index.cfm?fuseaction=display_aboutbic

TaxIdentifier

A unique number assigned by the relevant tax authority to identify a party. This constraint is used in relation to tax. Note: This constraint must be specified when the party is tax exempt.

TradeRegNumber

Trade Registration Number

UN/ECE

To be deprecated in the next version. Use @Agency to indicate this selection.

VATIdentificationNumber

A unique number assigned by the relevant tax authority to identify a party. This constraint is used in relation to value-added tax (VAT).

Other

Used for any other identification schemes not covered by this list.

PartyType [attribute]

Identifies the business role associated with the particular party

This item is restricted to the following list.

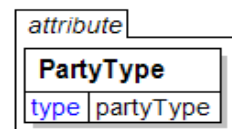

Auditor

A third party that is authorized for making audits and checkings.

Bank

The banking representative.

BillTo

The address where the invoice is to be sent. (Not to be used for logistics BillTo, see LogisticsBillTo.)

BorderCrossing

A geographic location separating two countries authorised to validate customs documentation.

Broker

The organisation acting as a broker for the buyer or supplier.

Buyer

The legal entity to which the product is sold. Also commonly referred to as the sold-to party or customer. If no OtherParty is defined as the "Payer", the "Buyer" is the "Payer". (Not to be used for logistics buyer, see LogisticsBuyer.)

BuyerAgent

The entity acting for the buyer in the transaction. (Not to be used for logistics BuyerAgent, see LogisticsBuyerAgent.)

Carrier

The organisation or business entity that transports goods.

CarrierAssignmentResponsible

The organisation to which the carrier has assigned some task.

ComponentVendor

Vendor producing supplied components.

Consignee

To be deprecated in version 3.0 (no date determined). Use LogisticsRole attribute to communicate this information.

Consignor

To be deprecated in version 3.0 (no date determined). Use LogisticsRole attribute to communicate this information.

Consuming

The eventual consumer of the material

Converter

The organisation responsible for changing one form of paper into another form, providing specialised functions not available to the supplier.

CreditDepartment

The party responsible for credit authorization.

CrossDock

A third party involved in the transport of goods.

CustomerFacility

The type of the origin or destination location of a transport leg in a route is a buyer facility, usually a print site, or a warehouse owned by the buyer.

CustomerStock

A "virtual" location that indicates that the material is owned by the customer.

Customs

Any customs agency.

CustomsForwarder

A forwarder responsible for managing the transfer of goods through customs.

DomesticForwarder

A forwarder responsible for managing the transfer of goods.

EndUser

EndUser is the party using, consuming, or converting the product. For example, a printer using paper reels to print a job for a publisher (printer is the end user). The final ShipTo destination for a product is normally to the EndUser facilities.

ExportForwarder

A forwarder responsible for managing the export process.

ForestForwarder

The party responsible for transporting forest wood products from logging areas to roadside landings.

ForestHarvester

The party responsible for harvesting of forest wood products at logging areas.

Forwarder

The party responsible for shipping arrangements.

FreightPayer

The party responsible for paying freight.

Insurer

The party providing insurance coverage for the goods.

Landowner

The party who owns the land upon which the product was produced.

LoadingOperator

A party that is carrying out loading of transport units.

LoggingArea

A geographic location in the forest where logging takes place.

LogisticsBillTo

The address where the logistics invoice is to be sent.

LogisticsBuyer

The buyer of logistics services. The legal entity to which the service is sold. Also commonly referred to as the sold-to party or customer. If no OtherParty is defined as the "LogisticsPayer", the "LogisticsBuyer" is the payer.

LogisticsBuyerAgent

The entity acting for the logistics buyer in the transaction.

LogisticsSeller

The seller of logistics services. LogisticsSupplier is the seller of the service, if logistics seller is not specified as OtherParty = LogisticsSeller

LogisticsSupplier

The party responsible for providing the service. LogisticsSupplier is also the

seller of the service, if logistics seller is not specified as OtherParty = LogisticsSeller

LogisticsPayee

The party handling and receiving logistics payments on behalf of another party.

LogisticsPayer

The party handling and sending logistics payments of behalf of another party.

MainCarrier

The primary carrier involved in the movement of goods.

Measurer

The party that's carrying out the measurement of the products quantity and/or quality. The party is doing this for example on behalf of both the buyer and seller and the result can be used as basis for invoicing.

Merchant

A third party buying and reselling products.

Mill

A production facility.

NotifyParty

A party that needs to be notified of the status of the transaction.

OnBehalfOf

The activity in question is being made on behalf of this party.

OrderParty

The organisation or business entity placing the order if different from the buyer party.

OriginalSupplier

The first supplier in a supply chain. OriginalSupplier is only intended to identify the business party, not the origin of the product.

Payee

The party handling and receiving payments on behalf of another party. (Not to be used for logistics payee, see LogisticsPayee.)

Payer

The party handling and sending payments of behalf of another party. (Not to be used for logistics payer, see LogisticsPayer.)

PlaceFinalDestination

The final destination of the goods.

PlaceOfAccept

The location where acceptance of the goods is to take place.

PlaceOfDespatch

The location where despatch took place.

PlaceOfDischarge

The location where the goods were unloaded.

PlaceOfLoading

The location where loading is to or took place.

PlaceOfMeasuring

The location where the products are measured.

PlaceOfReloading

A location where the goods were transferred from one transport type to another.

Port

The type of the origin or destination location of a transport leg in a route. It is a maritime location.

PreCarrier

The party responsible for activities prior to carrier accepting the goods (but after shipping has taken place).

PrinterFacility

The location of the printer who will be using the product.

ProFormal Invoice

The organisation or business entity to which the pro-forma invoice will be sent.

Producer

The manufacturer of the goods.

RemitTo

The organisation or business entity to which payment will be made.

Requestor

The originator of the original PurchaseOrder requisition (for example, a printing plant ordering through a central purchasing organisation).

RoadKeeper

The party who is responsible for the maintenance of the road.

RoadOwner

The party who is the legal owner of the road.

SalesAgent

The organisation or person responsible for product sales acting on behalf of the seller.

SalesOffice

The functional unit in an organisation or business entity that is responsible for product sales.

Seller

The seller of the product. SupplierParty is the seller of the product, if Seller is not specified as OtherParty = Seller. (Not to be used for logistics seller, see

LogisticsSeller.)

ShipFromLocation

The location the goods were shipped from.

ShipOwner

The owner of the vessel used to ship the goods.

ShipTo

The address the material should be shipped to.

SubCarrier

A sub carrier of another the shipping company.

Supplier

The organisation or business entity responsible for providing the product. SupplierParty is also the seller of the product, if Seller is not specified as OtherParty = Seller. (Not to be used for logistics supplier, see LogisticsSupplier.)

Terminal

The type of the origin or destination location of a transport leg in a route. It can be a sea, road or rail terminal.

TerminalOperator

The party providing facilities such as loading, unloading, or warehousing.

UnloadingOperator

A party that is carrying out unloading of transport units.

Warehouse

A storage location. It can be the origin or destination location of a transport leg in a route.

WillAdvise

Indicates that party will be identified at a later time

Other

Any other organisation or business entity that may get involved in the transaction and that is not covered by the list.

PasteDiameter

The diameter measurement of a reel when a new reel of paper is glued or pasted to it to continue running.

(sequence)

The sequence of items below is mandatory. A single instance is required.

Value

Value is mandatory. A single instance is required.

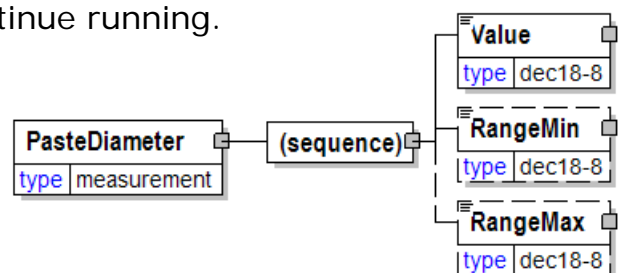

A numeric value expressed in the unit of measure (UOM).

RangeMin

RangeMin is optional. A single instance might exist.

The minimum value (lower boundary) allowed for the Measurement that is the parent of this element.

RangeMax

RangeMax is optional. A single instance might exist.

The maximum value (upper boundary) allowed for the Measurement that is the parent of this element. Some elements use the RangeMax element with an extended list of unit of measures. (Note: the red colour in the picture is an artifact of how the graphic was captured and should be disregarded.)

PatternProfile

Defines the pattern used in machining the product.

PatternProfileType [attribute]

PatternProfileType is optional. A single instance might exist.

Defines the name of any pattern or profile applied to the product.

Refer to PatternProfileType definition for any enumerations.

PatternProfileAgency [attribute]

PatternProfileAgency is optional. A single instance might exist.

LumberAgency identifies which agency is responsible for assigning the lumber attributes.

Refer to PatternProfileAgency definition for any enumerations.

(sequence)

The sequence of items below is mandatory. A single instance is required.

PatternProfileCode

PatternProfileCode is optional. A single instance might exist.

Defines the code which is used to describe the pattern profile.

AdditionalText

AdditionalText is optional. A single instance might exist.

A text field that is used to communicate information not previously defined or for special instructions. To be used only for circumstances not covered by specific elements.

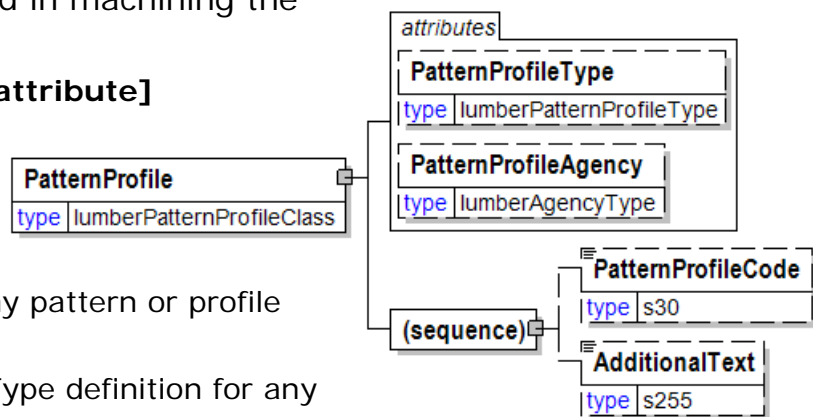

PatternProfileAgency [attribute]

LumberAgency identifies which agency is responsible for assigning the lumber attributes.

This item is restricted to the following list.

attribute
PatternProfileAgency
type lumberAgencyType

BS

BS-EN

British standard based on a European standard.

CEN

European Committee for Standardisation (<http://www.cenorm.be>)

DIN

EN338

EN1912

EN1611-1

EDISAW

Generic

GOST

Russian federal agency on technical regulating and metrology (<http://www.gost.ru>)

ISO

JAS

Japanese Agricultural Standard

NELMA

NLGA

NS

NSLB

RIS

RT

SIS

SPIB

WCLIB

WRCLA

WWPA

Supplier

PatternProfileCode

Defines the code which is used to describe the pattern profile.

PatternProfileCode
type s30

PatternProfileType [attribute]

Defines the name of any pattern or profile applied to the product.

This item is restricted to the following list.

attribute
PatternProfileType
type lumberPatternProfileType

Beveled Siding

Wedge shaped boards, installed so that each board is lapped over the edge of the board below.

Bungalow Siding

Channel Rustic Siding

Siding that includes a decorative molding with a concave groove

Colonial Siding

Dolly Varden Siding

Bevel siding, which is a wedge shaped board, installed so that each board is lapped over the edge of the board below, that has the addition of an L-shaped cutout at the edge or side of the wedge, overlapping the top of the board below.

Log Cabin Siding

Siding based on an Early American frontier style of housing, constructed of logs

Boston Pattern

Type of roofing where shingles butt tightly against each other at the hip with alternating shingle courses lapping over the edges of the opposing shingles.

CaulkingSeam

CB1S

Center bead on one side

CB2S

Center bead on two sides

CG2E

Center groove on two edges

CM

Center matched

CM 1/4 T and G

Center matched , 1/4 inch tongued and grooved

CM 3/8 T and G

Center matched, 3/8 inch tongued and grooved Center matched and edge V one side

CM and EV 1S

Center matched and edge V one side

CM and EV 2S

Center matched and edge V two sided

CV1S

Center V on one side

CV2S

Center V on two sides

D and CM

Dressed and center matched

DbI Plowed

E and CB1S

E and CB2S

Edge and center bead one side

E and CV2S

Edge and center bead two sides

EB1S

Edge bead one side

EB2S

Edge bead on two sides

EV1S

Edge V one side

EV2S

Edge V on two sides

Grooved for Splines

Plowed

S2S and CM 1/4 T and G

Surfaced two sides, center matched , 1/4 inch tongued and grooved

S2S and CM 3/8 T and G

Surfaced two sides, center matched , 3/8 inch tongued and grooved

ShipLap

Boards with rabbeted edges overlapping.

ShipLap - 1/2 lap

Boards with 1/2 inch rabbeted edges overlapping.

ShipLap - 3/8 lap

Boards with 3/8 inch rabbeted edges overlapping.

ShipLap and EV1S

Boards with rabbeted edges overlapping and edge V on one side.

T and G

Tongued and grooved

V Rustic

V-CV Rustic

Channel Decking

S2S CM and EV1S Decking

Comnation Ceiling

DbIBeaded Ceiling

Double Beaded Ceiling

E and CB Ceiling

E and CV Ceiling

EB Ceiling

EV Ceiling

V Ceiling

Beaded Partition

DbIBeaded Partition

E and CB Partition

E and CV Partition

V Partition

Flooring

Flooring D and M

Flooring S2S and CM

Special D and M Flooring

EasedEdge

Rabbeted

RadiusEdge

Beaded Shelving 2 Bead

Beaded Shelving 3 Bead

Casket Stock S3S G1E

Casket Stock S3S T1E

Corn Cribbing

Grooved Roofing

Gutter-Boston

Gutter-Ohio

Jamb

Ogee Batten

Patent Lath

Pulley Stile

Still

- 1
- 2
- 3
- 4
- 5
- 6
- 7
- 8
- 9
- 10
- 11
- 12
- 13
- 14
- 16
- 18
- 20
- 50
- 52
- 54
- 56
- 58
- 60
- 62
- 64
- 66
- 68
- 71
- 101
- 102
- 103
- 104
- 105
- 106
- 109
- 110

115
116
117
118
119
121
122
123
124
125
130
131
132
133
134
136
137
138
139
140
141
142
143
144
145
153
161
165
166
168
170
171
172
173
173 Spline
174
200

202
204
206
220A
222A
224A
300
302
304
305-a
305-b
305-c
305-d
305-e
405-a
405-b
405-c
405-d
405-e
Other

PerCarton

A field indicating the number of sheets per carton.

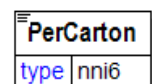

Perforated [attribute]

Either "Yes" or "No".

This item is restricted to the following list.

Yes
No

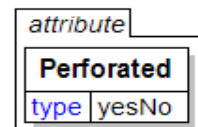

Perforation

Perforation information

PerforationType [attribute]

PerforationType is optional. A single instance might exist.

Perforation type

Refer to PerforationType definition for any enumerations.

(sequence)

The sequence of items below is mandatory. A single instance is required.

DistanceFromEdge

DistanceFromEdge is optional. A single instance might exist.

The distance from the edge of the paper. This element is used to communicate where the hole is.

AdditionalText

AdditionalText is optional. Multiple instances might exist.

A text field that is used to communicate information not previously defined or for special instructions. To be used only for circumstances not covered by specific elements.

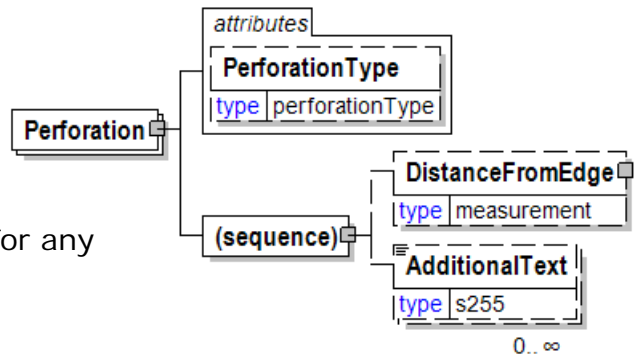

PerforationType [attribute]

Perforation type

This item is restricted to the following list.

Pattern

Workbook

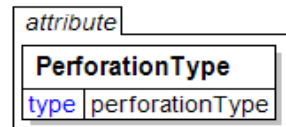

PeriodType [attribute]

Duration of time

This item is restricted to the following list.

Day

The time period is 24 hours specified as a date.

FinancialPeriodBeginning

Will be deprecated in next version of papiNet.

Hour

The time period is one hour specified as a Date and Time.

MonthBeginning

Will be deprecated in next version of papiNet.

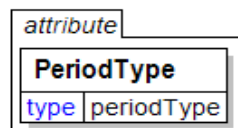

Period

The time period is specified as a date time range with a From Date Time and a To Date Time.

QuarterBeginning

Will be deprecated in next version of papiNet.

WeekBeginning

Will be deprecated in next version of papiNet.

WeekNumber

The time period is one week specified as a week number.

ISO 8601 is used as the basis for week numbers, "Week 01 of a year is the first week that has the Thursday in this year, which is equivalent to the week that contains the fourth day of January."

YearBeginning

Will be deprecated in next version of papiNet.

Permeability

A group item used to communicate air permeability target or test value according to a particular TestMethod.

TestMethod [attribute]

TestMethod is optional. A single instance might exist.

The method used to determine the results of the test under consideration.

TestAgency [attribute]

TestAgency is optional. A single instance might exist.

The agency that has set the parameters for the testing

Refer to TestAgency definition for any enumerations.

SampleType [attribute]

SampleType is optional. A single instance might exist.

Communicates how sampling was done to measure the product characteristics.

Refer to SampleType definition for any enumerations.

ResultSource [attribute]

ResultSource is optional. A single instance might exist.

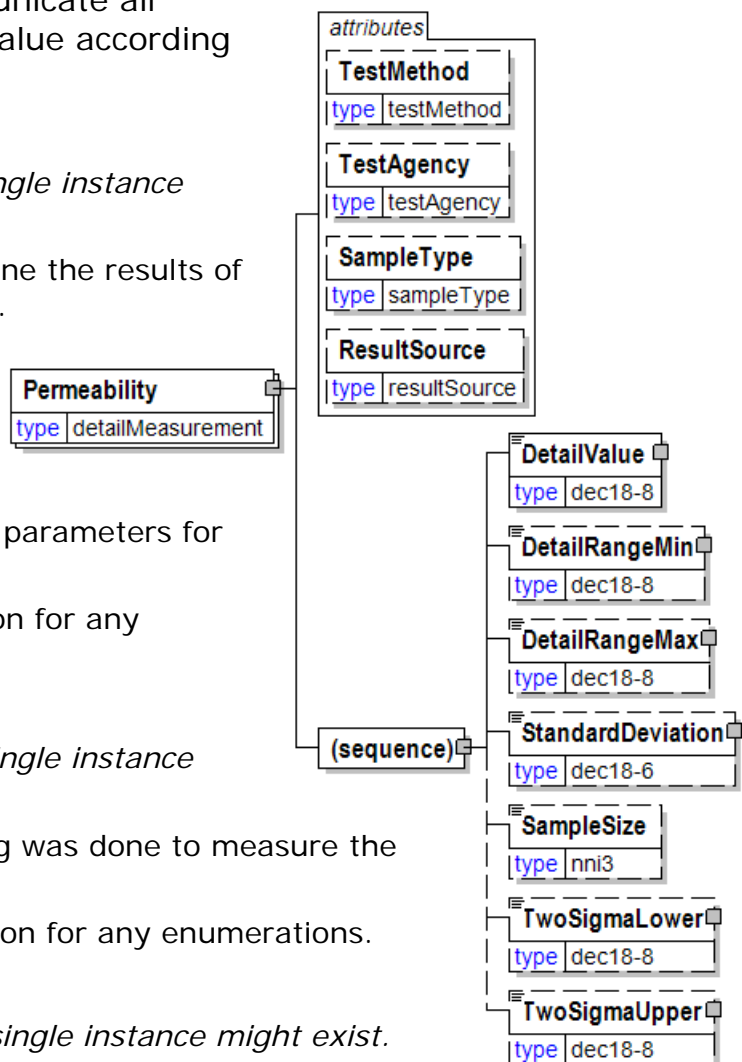

papiNet V2R31

Used to define the data source of the specified test
Refer to ResultSource definition for any enumerations.

(sequence)

The sequence of items below is mandatory. A single instance is required.

DetailValue

DetailValue is mandatory. A single instance is required.

A numeric value expressed in the unit of measure (UOM).

DetailRangeMin

DetailRangeMin is optional. A single instance might exist.

The minimum value (lower boundary) allowed for the DetailValue that is the parent of this element.

DetailRangeMax

DetailRangeMax is optional. A single instance might exist.

The maximum value (upper boundary) allowed for the DetailValue that is the parent of this element.

StandardDeviation

StandardDeviation is optional. A single instance might exist.

A statistic used as a measure of dispersion in a distribution.

SampleSize

SampleSize is optional. A single instance might exist.

The number of samples used to determine the product characteristic in question.

TwoSigmaLower

TwoSigmaLower is optional. A single instance might exist.

Two sigma (a measure of dispersion associated with standard deviation) on the lower side of the standard deviation.

TwoSigmaUpper

TwoSigmaUpper is optional. A single instance might exist.

Two sigma (a measure of dispersion associated with standard deviation) on the upper side of the standard deviation.

PerPallet

A field indicating the number of sheets on the pallet.

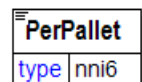

PerReam

A field indicating the number of sheets per ream.

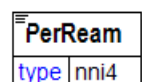

PerTab

A field indicating the number of sheets per tab marking.

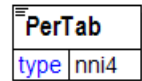

pH

A group item used to communicate pH (degree of acidity versus basicity) target or test value according to a particular TestMethod.

TestMethod [attribute]

TestMethod is optional. A single instance might exist.

The method used to determine the results of the test under consideration.

TestAgency [attribute]

TestAgency is optional. A single instance might exist.

The agency that has set the parameters for the testing

Refer to TestAgency definition for any enumerations.

SampleType [attribute]

SampleType is optional. A single instance might exist.

Communicates how sampling was done to measure the product characteristics.

Refer to SampleType definition for any enumerations.

ResultSource [attribute]

ResultSource is optional. A single instance might exist.

Used to define the data source of the specified test

Refer to ResultSource definition for any enumerations.

(sequence)

The sequence of items below is mandatory. A single instance is required.

DetailValue

DetailValue is mandatory. A single instance is required.

A numeric value expressed in the unit of measure (UOM).

DetailRangeMin

DetailRangeMin is optional. A single instance might exist.

The minimum value (lower boundary) allowed for the DetailValue that is the parent

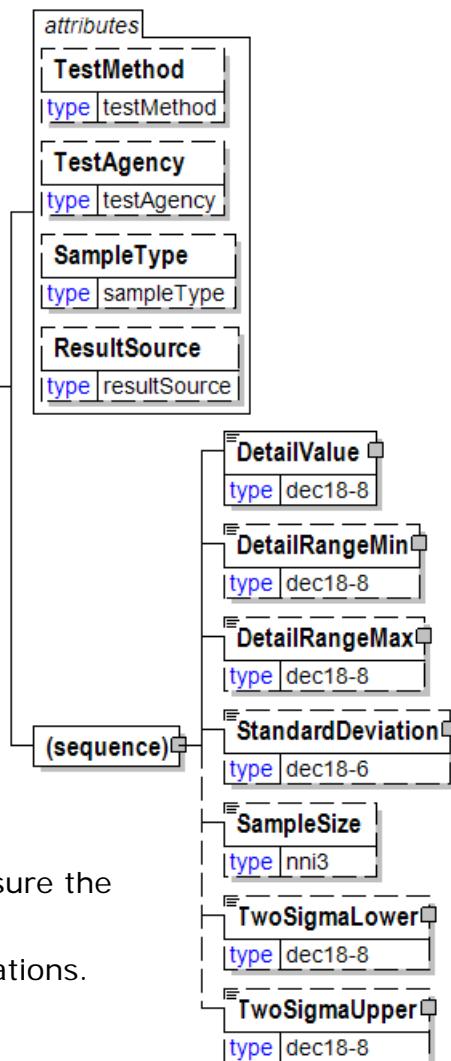
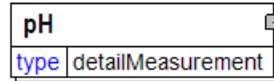

of this element.

DetailRangeMax

DetailRangeMax is optional. A single instance might exist.

The maximum value (upper boundary) allowed for the DetailValue that is the parent of this element.

StandardDeviation

StandardDeviation is optional. A single instance might exist.

A statistic used as a measure of dispersion in a distribution.

SampleSize

SampleSize is optional. A single instance might exist.

The number of samples used to determine the product characteristic in question.

TwoSigmaLower

TwoSigmaLower is optional. A single instance might exist.

Two sigma (a measure of dispersion associated with standard deviation) on the lower side of the standard deviation.

TwoSigmaUpper

TwoSigmaUpper is optional. A single instance might exist.

Two sigma (a measure of dispersion associated with standard deviation) on the upper side of the standard deviation.

PiecesPerRow

This element details the number of pieces or individual items that are to be placed/packaged in a row within the unit. Usually used to identify the standard number of pieces in a standard packaging unit of the product.

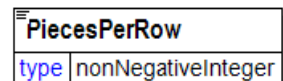

PlacementInOrderOfMatter

Element used to identify where the component is to be placed amongst other components when assembling a book.

PlacementReference [attribute]

PlacementReference is mandatory. A single instance is required.

Placement reference

Refer to PlacementReference definition for any enumerations.

RelativeLocation [attribute]

RelativeLocation is optional. A single instance might exist.

The relative position in the end-item where the component

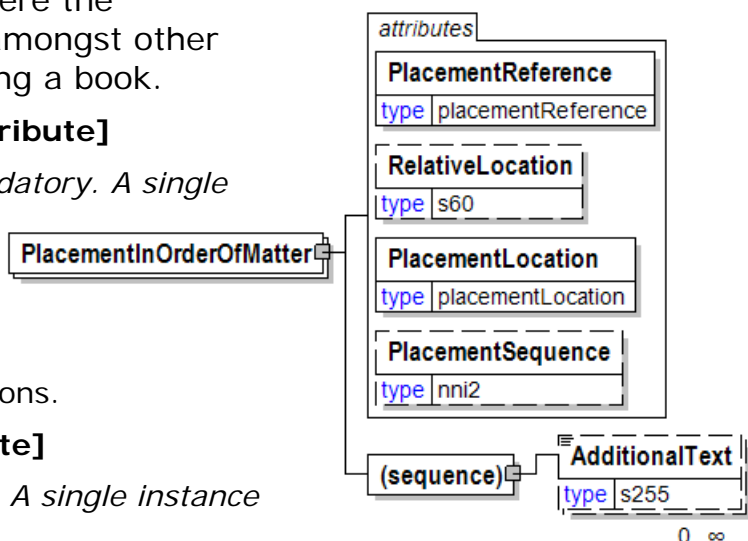

is to be placed.

PlacementLocation [attribute]

PlacementLocation is mandatory. A single instance is required.

Placement location.

Refer to PlacementLocation definition for any enumerations.

PlacementSequence [attribute]

PlacementSequence is optional. A single instance might exist.

The placement sequence. Any non negative integer between 1 and 99.

(sequence)

The sequence of items below is mandatory. A single instance is required.

AdditionalText

AdditionalText is optional. Multiple instances might exist.

A text field that is used to communicate information not previously defined or for special instructions. To be used only for circumstances not covered by specific elements.

PlacementLocation [attribute]

Placement location.

This item is restricted to the following list.

Inside

Outside

Before

After



PlacementReference [attribute]

Placement reference

This item is restricted to the following list.

BackCover

BacktEndsheet

Chapter

FrontCover

FrontEndsheet

Item

Page

Signature

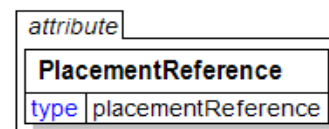

PlacementSequence [attribute]

The placement sequence. Any non negative integer between 1 and 99.

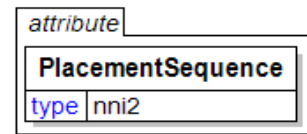

Planning

The Planning element is the root element for the Planning e-Document.

The Planning e-Document provides a tool for trading partners to exchange forecasted or planned information for a specific product or event within a specified timeframe. The e-Document is designed to support a variety of business processes, which may include securing needed supplies or simply the exchange of information.

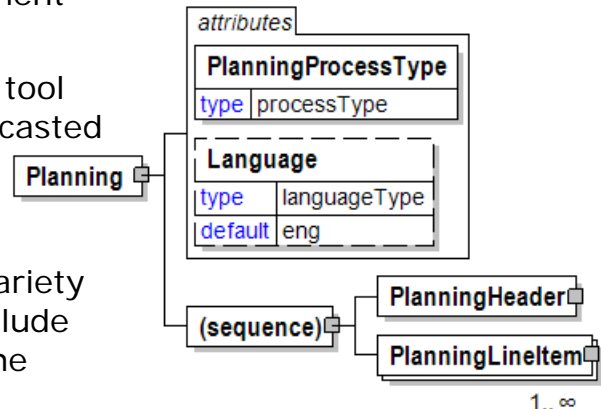

PlanningProcessType [attribute]

PlanningProcessType is mandatory. A single instance is required.

The type of process that the Planning e-Document communicates.

Refer to PlanningProcessType definition for any enumerations.

Language [attribute]

Language is optional. A single instance might exist.

XML has embraced 2 and 3 digit language codes through the application of an addendum to the standard.

Refer to Language definition for any enumerations.

(sequence)

The sequence of items below is mandatory. A single instance is required.

PlanningHeader

PlanningHeader is mandatory. A single instance is required.

Information that applies to all the items on the Planning e-Document.

PlanningLineItem

PlanningLineItem is mandatory. One instance is required, multiple instances might exist.

The PlanningLineItem must reference either a Product or Downtime. The PlanningLineItem presents information for a particular product or downtime event.

PlanningBucket

PlanningBucket groups together the elements required to communicate the time and quantity related information for the parent item (either Product or Downtime).

BucketType [attribute]

BucketType is mandatory. A single instance is required.

The type of planning information being communicated in the bucket.

Refer to BucketType definition for any enumerations.

(sequence)

The sequence of items below is mandatory. A single instance is required.

TimePeriod

TimePeriod is mandatory. A single instance is required.

The TimePeriod element is used to communicate a duration period of time as indicated in PeriodType.

OtherDate

OtherDate is optional. A single instance might exist.

A date that may not be specifically detailed within a document (example: print date at the PurchaseOrderLineItem).

Quantity

Quantity is mandatory. A single instance is required.

The Quantity element contains attributes that provide information about the type of quantity that is being communicated, the context in which the particular quantity is to be viewed, and (if the quantity represents an adjustment) an adjustment type.

The Quantity element contains three child elements that enable you to communicate a range of values for the quantity and a target or actual value. It is at this level (Value, RangeMin, and RangeMax) that the unit of measure is specified. This permits the range to be specified in a different unit of measure than the target.

InformationalQuantity

InformationalQuantity is optional. Multiple instances might exist.

A quantity given in a valid UOM used for information purposes only (not for calculation). For example, an ordered quantity was 100 reels as opposed to the invoice quantity of 20,000 pounds.

ProductionRunNumber

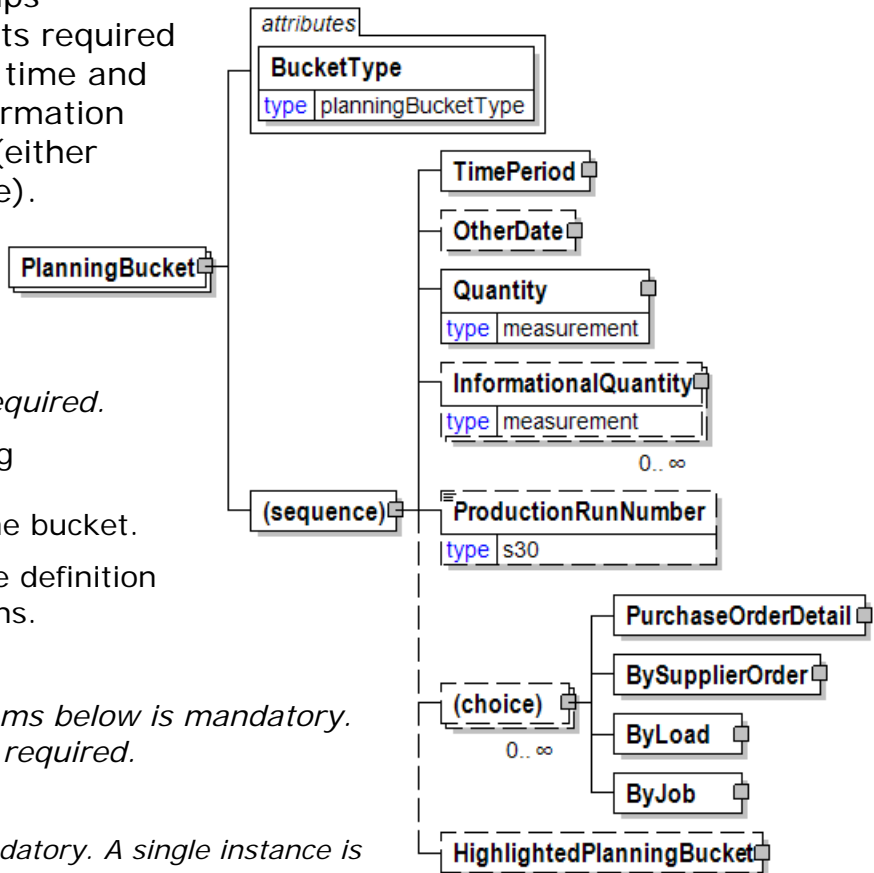

papiNet V2R31

ProductionRunNumber is optional. A single instance might exist.

The ProductionRunNumber assigned by the issuer.

(choice)

[choice] is optional because of choice construct.

PurchaseOrderDetail

PurchaseOrderDetail is optional because of choice construct.

Multiple PurchaseOrderDetail instances are allowed.

BySupplierOrder

BySupplierOrder is optional because of choice construct.

Selection criteria for communicating Supplier Order information.

ByLoad

ByLoad is optional because of choice construct.

By Load

ByJob

ByJob is optional because of choice construct.

Information about the job being communicated.

HighlightedPlanningBucket

HighlightedPlanningBucket is optional. A single instance might exist.

Provides an indication and information that the planning bucket should be reviewed.

PlanningBucketStatusType [attribute]

Used to identify the Planning bucket's status. Typically used to highlight a change in status to the receiver of the e-Document.

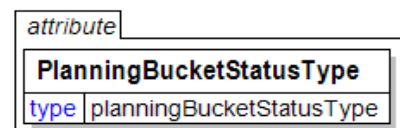

This item is restricted to the following list.

Amended

The supplied information is changed.

Cancelled

The supplied information has been cancelled. Items that have been cancelled are not included in totals on the summary levels of the e-Document.

New

The information is new and supplied for the first time.

NoAction

The supplied information has not been amended and thereby requires no action.

PlanningHeader

Information that applies to all the items on the Planning e-Document.

(sequence)

The sequence of items below is mandatory. A single instance is required.

PlanningMessageNumber

PlanningMessageNumber is mandatory. A single instance is required.

A unique identifier assigned to the Planning e-Document assigned by the issuer that makes this Planning unique. Subsequent Planning e-Documents with updates will use this same PlanningMessageNumber.

PlanningIssueDate

PlanningIssueDate is mandatory. A single instance is required.

The date and time this version of the Planning data was issued.

PlanningIdentifier

PlanningIdentifier is optional. A single instance might exist.

An identifier that communicates the scope or content of the Planning e-Document. This field is used to communicate which sub-set of planning information is being maintained.

RequestNumber

RequestNumber is optional. A single instance might exist.

A unique tracking number specifically identifying the InfoRequest e-Document to the originator. The tracking number is returned with the "information", the answer, to help match the answer to the request.

SenderParty

SenderParty is optional. A single instance might exist.

The business entity issuing the e-Document, the source of the document.

The entity responsible for the content. If the sender party has out sourced the message service to a third party the SenderParty is the issuer of the e-Document and not the party performing the transmission service of the electronic message.

ReceiverParty

ReceiverParty is optional. Multiple instances might exist.

The business entity for whom the e-Document is intended, the destination of the document.

The entity interested in the content. If the receiver party has outsourced the message service to a third party the ReceiverParty is the intended party for

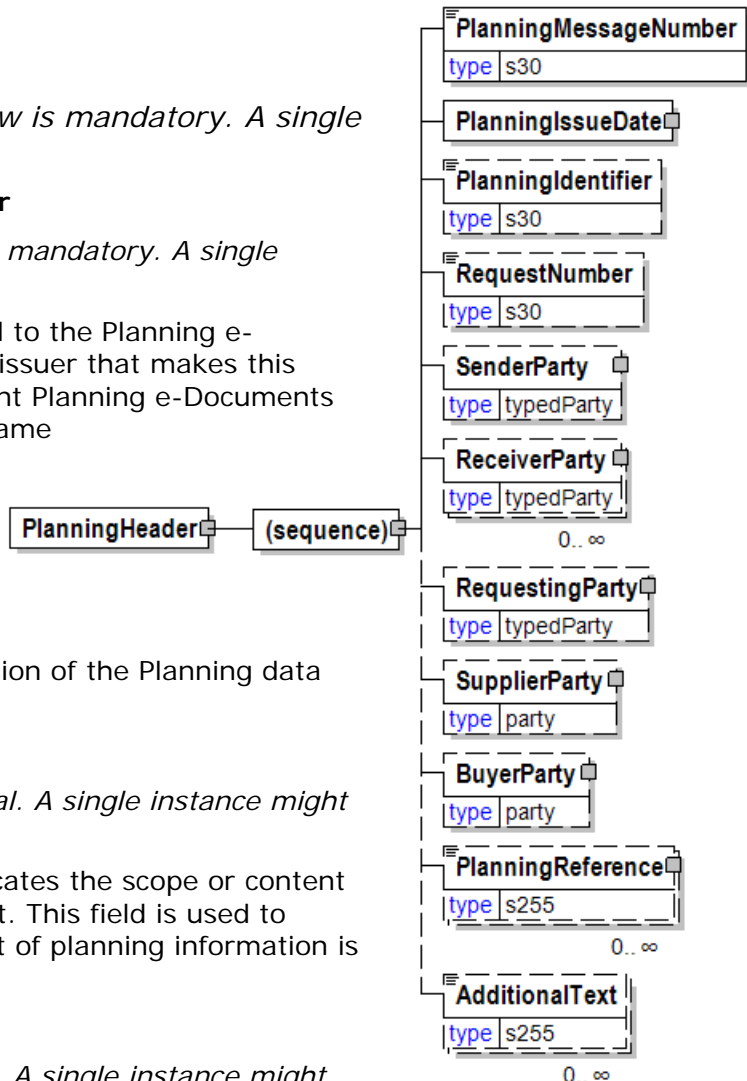

papiNet V2R31

the e-Document and not the party performing the receiving service of the electronic message.

RequestingParty

RequestingParty is optional. A single instance might exist.

The party requesting the information.

SupplierParty

SupplierParty is optional. A single instance might exist.

The organisation or business entity responsible for providing the product. SupplierParty is also the seller of the product, if Seller is not specified as OtherParty = Seller.

BuyerParty

BuyerParty is optional. A single instance might exist.

The legal entity to which the product is sold. Also commonly referred to as the sold-to party or customer. If no OtherParty is defined as the Payer, the Buyer is the Payer.

PlanningReference

PlanningReference is optional. Multiple instances might exist.

An element detailing relevant references pertaining to the Planning e-Document.

AdditionalText

AdditionalText is optional. Multiple instances might exist.

A text field that is used to communicate information not previously defined or for special instructions. To be used only for circumstances not covered by specific elements.

PlanningIdentifier

An identifier that communicates the scope or content of the Planning e-Document. This field is used to communicate which sub-set of planning information is being maintained.

PlanningIdentifier	
type	s30

PlanningIssueDate

The date and time this version of the Planning data was issued.

(sequence)

The sequence of items below is mandatory. A single instance is required.

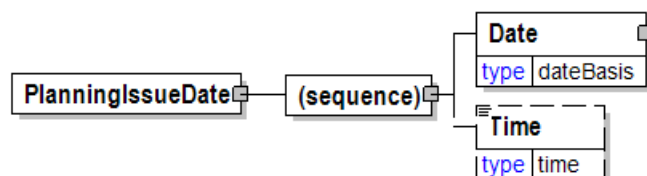

Date

Date is mandatory. A single instance is required.

A group element that contains the specification of Year, Month, and Day.

Time

Time is optional. A single instance might exist.

papiNet V2R31

Times are treated in a standard XML fashion with a special case used to indicate a generalized "local" time. The standard XML approach to time is hh:mm:ss, hh:mm:ssZ, or hh:mm:ss±hh:mm.

hh:mm:ss±hh:mm is used to represent a time with a time zone. The time zone is communicated as the number of hours offset from the Universal Time Coordinate (UTC), a.k.a. Greenwich Mean Time.

hh:mm:ssZ indicates the time at Zulu (another name for UTC). Based on the convention described in the next bullet it will be important for users within UTC to use "Z" when communicating a time in their time zone to other users.

hh:mm:ss or hh:mm indicates in the XML standard the time at UTC however, within papiNet it is used to represent the applicable local time. Caution should be used when processing times of this nature as the papiNet approach may be in discord with other users of XML.

PlanningLineItem

The PlanningLineItem must reference either a Product or Downtime. The PlanningLineItem presents information for a particular product or downtime event.

PrintType [attribute]

PrintType is optional. A single instance might exist.

Refer to PrintType definition for any enumerations.

(sequence)

The sequence of items below is mandatory. A single instance is required.

PlanningLineItemNumber

PlanningLineItemNumber is mandatory. A single instance is required.

A sequential number that uniquely identifies the PlanningLineItemNumber.

LocationParty

LocationParty is mandatory. A single instance is required.

The organization or business entity where the business event took place or will take place.

MachineID

MachineID is optional. A single instance might exist.

An identifier assigned to the particular machine being referenced. For example, a machine could be a paper machine, an off-line coater, a sheeter, or a printing press. The particular machine being referenced will be determined by the business event being supported.

OtherParty

OtherParty is optional. Multiple instances might exist.

An organisation or business entity other than those specifically detailed within a e-Document.

PlanningReference

PlanningReference is optional. Multiple instances might exist.

An element detailing relevant references pertaining to the Planning e-Document.

(choice)

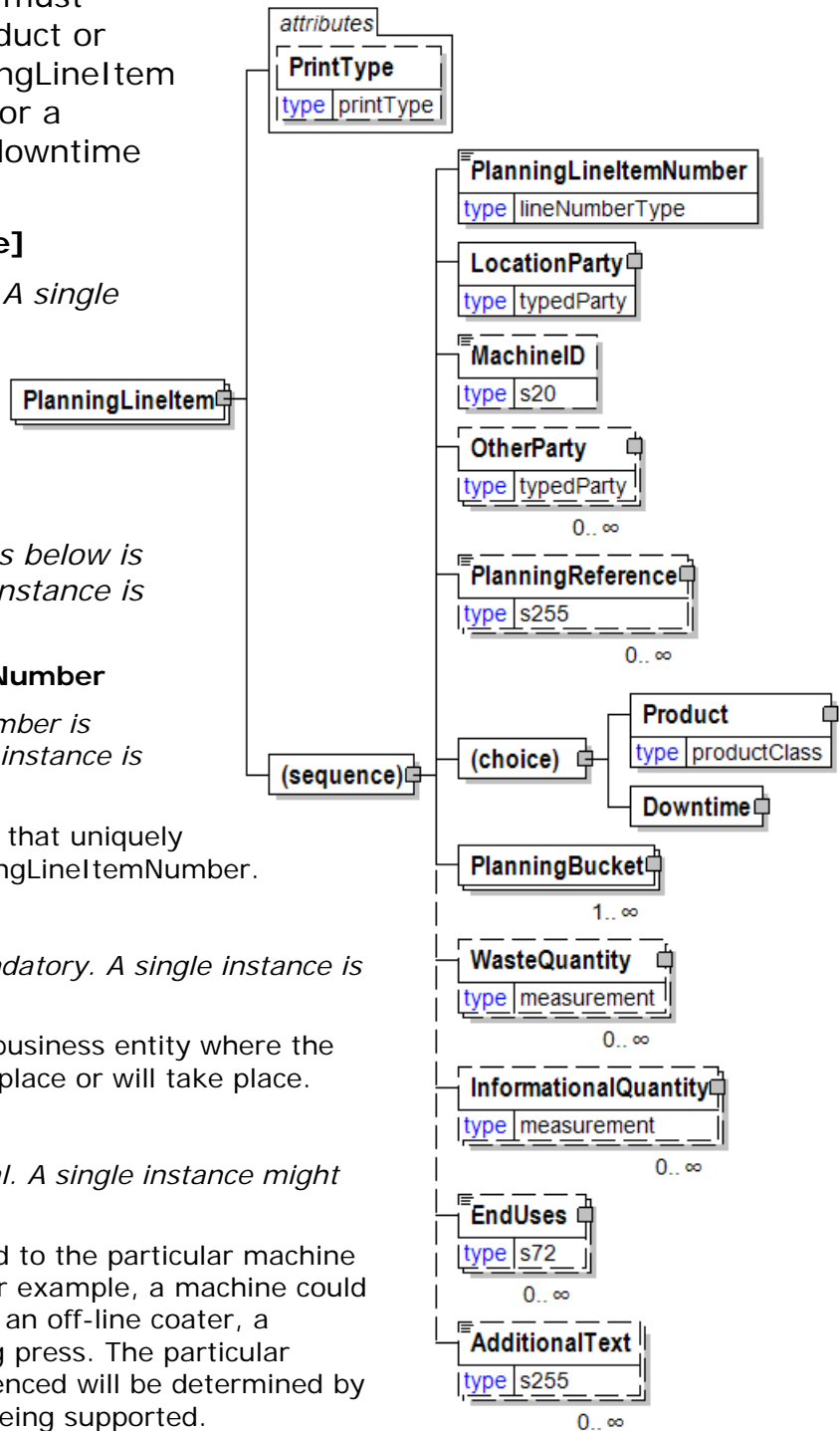

[choice] is optional because of choice construct.

Product

Product is optional because of choice construct.

Product is a group item defining the article and its characteristics. Product is used to specify product characteristics organized by ProductIdentifier, ProductDescription, and Classification. Book Manufacturing, Label Stock, Paper, Pulp, Recovered Paper, Wood Products, and Virgin Fibre market segments have defined their product characteristics and conversion features for implementation in papiNet.

Downtime

Downtime is optional because of choice construct.

An element used to communicate when equipment is not available for manufacturing purposes.

PlanningBucket

PlanningBucket is mandatory. One instance is required, multiple instances might exist.

PlanningBucket groups together the elements required to communicate the time and quantity related information for the parent item (either Product or Downtime).

WasteQuantity

WasteQuantity is optional. Multiple instances might exist.

The quantity of product wasted.

InformationalQuantity

InformationalQuantity is optional. Multiple instances might exist.

A quantity given in a valid UOM used for information purposes only (not for calculation). For example, an ordered quantity was 100 reels as opposed to the invoice quantity of 20,000 pounds.

EndUses

EndUses is optional. Multiple instances might exist.

A text element used to express in human readable form a list of applicable end uses for a product. Examples of end uses are:

- Magazine
- Book
- Commercial print
- etc

AdditionalText

AdditionalText is optional. Multiple instances might exist.

A text field that is used to communicate information not previously defined or for special instructions. To be used only for circumstances not covered by specific elements.

PlanningLineItemNumber

A sequential number that uniquely identifies the PlanningLineItemNumber.

PlanningLineItemNumber	
type	lineNumberType

PlanningMessageNumber

A unique identifier assigned to the Planning e-Document assigned by the issuer that makes this Planning unique. Subsequent Planning e-Documents with updates will use this same PlanningMessageNumber.

PlanningMessageNumber	
type	s30

PlanningProcessType [attribute]

The type of process that the Planning e-Document communicates.

This item is restricted to the following list.

attribute	
PlanningProcessType	
type	processType

Consumption

Consumed in manufacturing.

DeliveryReceipt

Delivered to the ship-to location.

Despatch

Ready to shipped.

Inventory

In available inventory at the storage location.

Production

The quantity added to stock through a manufacturing or conversion process.

Sales

A PurchaseOrder has been placed for the product.

PlanningReference

An element detailing relevant references pertaining to the Planning e-Document.

PlanningReferenceType [attribute]

PlanningReferenceType is mandatory. A single instance is required.

PlanningReference	
type	s255

attributes	
PlanningReferenceType	
type	referenceType
AssignedBy	
type	partyType

Provides a contextual explanation of the specific reference identifier. Many items are currently prefixed by "Buyer", "Forwarder", "Manufacturer", "Mill",

"Seller", "Supplier", "Warehouse", or "Vendor". Check for an existing non-prefixed version and use the non-prefixed version instead. In the (yet to be announced release date) version 3.0 the prefixed versions will be removed. Instead the attribute @AssignedBy will communicate the information previously communicated in the prefix.

Refer to PlanningReferenceType definition for any enumerations.

AssignedBy [attribute]

AssignedBy is optional. A single instance might exist.

Identifies the type of party that has assigned the associated item, e.g. a reference of type OrderNumber.

Refer to AssignedBy for any enumerations.

PlanningReferenceType [attribute]

Provides a contextual explanation of the specific reference identifier. Many items are currently prefixed by "Buyer", "Forwarder", "Manufacturer", "Mill", "Seller", "Supplier", "Warehouse", or "Vendor". Check for an existing non-prefixed version and use the non-prefixed version instead. In the (yet to be announced release date) version 3.0 the prefixed versions will be removed. Instead the attribute @AssignedBy will communicate the information previously communicated in the prefix.

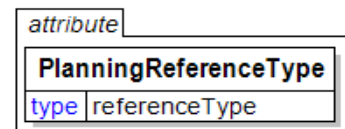

Refer to the [referenceType](#) entry for the list of enumerations and their definitions.

PlanningRequestDetail

A grouping element that provides the parameters to be used when responding with a Planning e-Document.

(sequence)

The sequence of items below is mandatory. A single instance is required.

Product

Product is mandatory. A single instance is required.

Product is a group item defining the article and its characteristics. Product is used to specify product characteristics organized by ProductIdentifier, ProductDescription, and Classification. Book Manufacturing, Label Stock, Paper, Pulp, Recovered Paper, Wood Products, and Virgin Fibre market segments have defined their product characteristics and conversion features for implementation in papiNet.

LocationParty

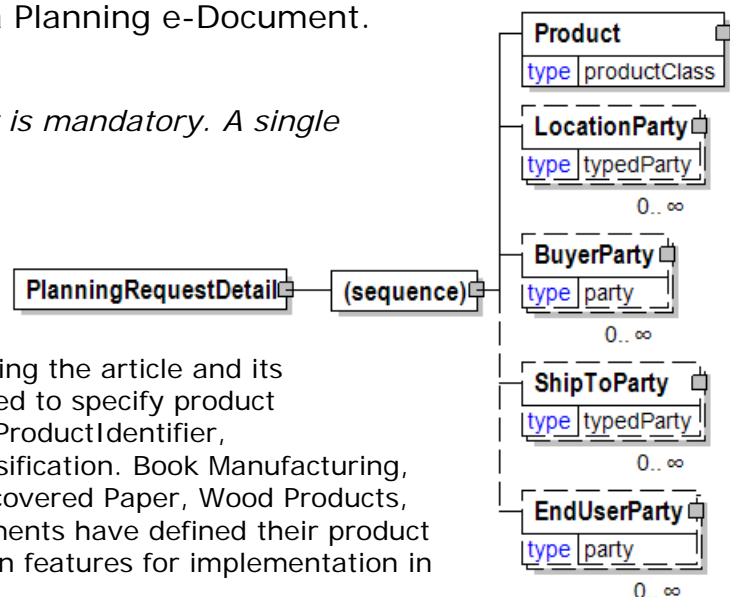

LocationParty is optional. Multiple instances might exist.

The organization or business entity where the business event took place or will take place.

BuyerParty

BuyerParty is optional. Multiple instances might exist.

The legal entity to which the product is sold. Also commonly referred to as the sold-to party or customer. If no OtherParty is defined as the Payer, the Buyer is the Payer.

ShipToParty

ShipToParty is optional. Multiple instances might exist.

The name and/or address to which the goods should be delivered with the party type indicated by the PartyType attribute.

EndUserParty

EndUserParty is optional. Multiple instances might exist.

The party using, consuming, or converting the product. For example, a printer using paper reels for a print job for a publisher. The final ShipTo destination for a product is normally to the end user's facilities.

PlasticMaterial

Describes the plastic used in the process.

PlasticPrinting [attribute]

PlasticPrinting is optional. A single instance might exist.

Either "Yes" or "No".

Refer to PlasticPrinting definition for any enumerations.

PlasticMaterialType [attribute]

PlasticMaterialType is optional. A single instance might exist.

The type of plastic material

Refer to PlasticMaterialType definition for any enumerations.

(sequence)

The sequence of items below is mandatory. A single instance is required.

Thickness

Thickness is mandatory. A single instance is required.

Physical dimension of a product.

PlasticPrintingDescription

PlasticPrintingDescription is optional. A single instance might exist.

Plastic printing description

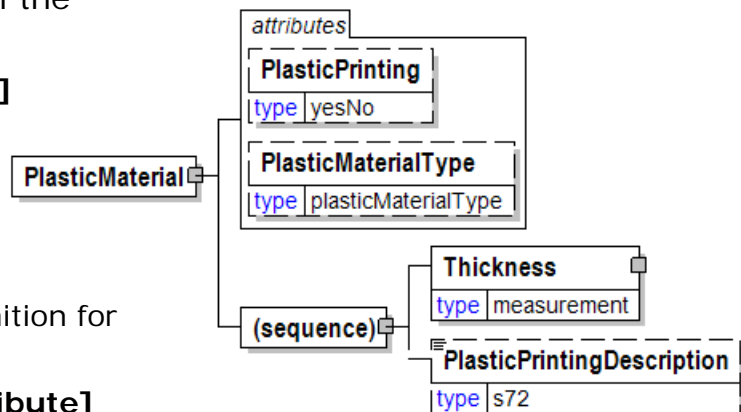

PlasticMaterialType [attribute]

The type of plastic material

This item is restricted to the following list.

- PC
- PET
- PVC
- Other



PlasticPrinting [attribute]

Either "Yes" or "No".

This item is restricted to the following list.

- Yes
- No



PlasticPrintingDescription

Plastic printing description

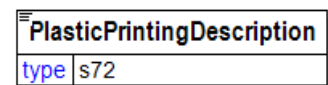

Plate

The image carrying medium.

(sequence)

The sequence of items below is mandatory. A single instance is required.

PlateType

PlateType is optional. A single instance might exist.

The category of material used to carry an image to reproduce a print impress.
(paper, metal, plastic, rubber)

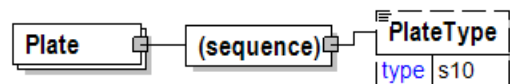

PlateType

The category of material used to carry an image to reproduce a print impress. (paper, metal, plastic, rubber)

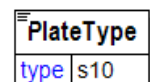

PlyAttributes

The characteristics of the plies of paper or tissue. Manufacturing data relevant to each ply that constitutes the final product

CoatingLocation [attribute]

CoatingLocation is optional. A single instance might exist.

Coating location

Refer to CoatingLocation definition for any enumerations.

(sequence)

The sequence of items below is mandatory. A single instance is required.

PlyNumber

PlyNumber is mandatory. A single instance is required.

Product attributes can be detailed for each ply. If product attributes are defined for the plies this element defines the ply that these product attributes apply to.

Abrasion

Abrasion is optional. Multiple instances might exist.

A group item used to communicate abrasion loss target or test value.

AbsorptionInk

AbsorptionInk is optional. Multiple instances might exist.

A group item used to communicate ink absorption target or test value.

AbsorptionLight

AbsorptionLight is optional. Multiple instances might exist.

A group item used to communicate light absorption target or test value.

AbsorptionWater

AbsorptionWater is optional. Multiple instances might exist.

A group item used to communicate water absorption target or test value.

Appearance

Appearance is optional. Multiple instances might exist.

A group item used to communicate appearance.

Ash

Ash is optional. Multiple instances might exist.

A group item used to communicate the ash content of the product according to a particular TestMethod.

BasisWeight

BasisWeight is optional. Multiple instances might exist.

The weight of the paper expressed as a mass for a given surface area. In countries using the metric system, the basis weight is expressed as the weight in grams of one sheet of paper that is one square meter in area—not dependent on basic sheet size. In countries using the imperial system, the weight is expressed in pounds for a given ProductBasisSizeType.



BendingResistance

BendingResistance is optional. Multiple instances might exist.

Bending resistance

BendingStiffness

BendingStiffness is optional. Multiple instances might exist.

BendingStiffness

Brightness

Brightness is optional. Multiple instances might exist.

A measurement of the degree of light reflectivity of the product.

Bulk

Bulk is optional. Multiple instances might exist.

A group item used to communicate bulking thickness target or test value.

Burst

Burst is optional. Multiple instances might exist.

A group item used to communicate bursting strength target or test value according to a particular TestMethod.

BurstIndex

BurstIndex is optional. Multiple instances might exist.

The burst index.

Caliper

Caliper is optional. Multiple instances might exist.

The thickness of a sheet of paper under standard test conditions.

CoatWeight

CoatWeight is optional. Multiple instances might exist.

A group item used to communicate the coating thickness target or test value according to a particular TestMethod.

ColourDetail

ColourDetail is optional. Multiple instances might exist.

A group item used to communicate details of colour according to the selected colour definition scheme.

Density

Density is optional. Multiple instances might exist.

A group item used to communicate density target or test value according to a particular TestMethod.

Dirt

Dirt is optional. Multiple instances might exist.

A group item used to communicate dirt content target or test value according to a particular TestMethod.

DominantWavelength

DominantWavelength is optional. Multiple instances might exist.

Dominant wavelength

FibreLength

FibreLength is optional. Multiple instances might exist.

A group item used to communicate fibre length target or test value according to a particular TestMethod.

FibreClassification

FibreClassification is optional. Multiple instances might exist.

A group item used to communicate fibre classification according to the specified classification scheme.

Folding

Folding is optional. Multiple instances might exist.

A group item used to communicate folding endurance target or test value according to a particular TestMethod.

Formation

Formation is optional. Multiple instances might exist.

A group item used to communicate sheet formation target or test value according to a particular TestMethod.

Freeness

Freeness is optional. Multiple instances might exist.

Freeness

Friction

Friction is optional. Multiple instances might exist.

A group item used to communicate static and kinetic friction target or test value according to a particular TestMethod.

Gloss

Gloss is optional. Multiple instances might exist.

A group item used to communicate specular gloss target or test value according to a particular TestMethod.

LightScattering

LightScattering is optional. Multiple instances might exist.

A group item used to communicate light scattering coefficients according to a particular TestMethod.

Moisture

Moisture is optional. Multiple instances might exist.

Desired percentage, or other indicator, of water in the product at the time of shipment.

Opacity

Opacity is optional. Multiple instances might exist.

A group item used to communicate opacity target or test value according to a particular TestMethod.

Permeability

Permeability is optional. Multiple instances might exist.

A group item used to communicate air permeability target or test value according

to a particular TestMethod.

pH

pH is optional. Multiple instances might exist.

A group item used to communicate pH (degree of acidity versus basicity) target or test value according to a particular TestMethod.

PlyBond

PlyBond is optional. Multiple instances might exist.

A group item used to communicate internal bond strength target or test value between plies according to a particular TestMethod.

Porosity

Porosity is optional. Multiple instances might exist.

A group item used to communicate a permeability target or test value.

PostConsumerWaste

PostConsumerWaste is optional. Multiple instances might exist.

A group item used to communicate the target or test value percentage of post consumer waste fibre in the product according to a particular TestMethod.

PPI

PPI is optional. Multiple instances might exist.

A group item used to communicate the number of pages in an inch of thickness either as a target or actual value. Equal to the number of sheets per inch times 2.

PreConsumerWaste

PreConsumerWaste is optional. Multiple instances might exist.

A group item used to communicate the target or test value percentage of pre-consumer waste fibre in the product according to a particular TestMethod.

Recycled

Recycled is optional. Multiple instances might exist.

A group item used to communicate the target or test value total percentage of waste fibre in the product according to a particular TestMethod.

Resistance

Resistance is optional. Multiple instances might exist.

A group item used to communicate air resistance target or test value according to a particular TestMethod.

RingCrush

RingCrush is optional. Multiple instances might exist.

Ring Crush

Roughness

Roughness is optional. Multiple instances might exist.

A group item used to communicate surface roughness target or test value according to a particular TestMethod.

RunnabilityIndex

RunnabilityIndex is optional. Multiple instances might exist.

A group item used to communicate the calculated run-ability index target or test

value.

ShowThrough

ShowThrough is optional. Multiple instances might exist.

Show through

Sizing

Sizing is optional. Multiple instances might exist.

A group item used to communicate size test of paper by ink resistance target or test value.

Smoothness

Smoothness is optional. Multiple instances might exist.

A group item used to communicate surface smoothness target or test value according to a particular TestMethod.

Stiffness

Stiffness is optional. Multiple instances might exist.

A group item used to communicate stiffness target or test value.

Stretch

Stretch is optional. Multiple instances might exist.

A group item used to communicate stretch target or test value.

SurfaceStrength

SurfaceStrength is optional. Multiple instances might exist.

Surface Strength

TEA

TEA is optional. Multiple instances might exist.

Tensile Energy Absorption.

Tear

Tear is optional. Multiple instances might exist.

A group item used to communicate tearing resistance target or test value according to a particular TestMethod.

TearIndex

TearIndex is optional. Multiple instances might exist.

TearIndex

Tensile

Tensile is optional. Multiple instances might exist.

A group item used to communicate zero-span tensile strength target or test value according to a particular TestMethod.

TensileIndex

TensileIndex is optional. Multiple instances might exist.

Tensile Index

Whiteness

Whiteness is optional. Multiple instances might exist.

papiNet V2R31

A group item used to communicate degree of whiteness target or test value according to a particular TestMethod.

AdditionalTest

AdditionalTest is optional. A single instance might exist.

AdditionalTest exists to enable the inclusion of a test that has not been identified by papiNet.org. It is always a single-instance element so it is very important that users, who come upon a test that papiNet.org has not identified, communicate the need for this test to us at www.papiNet.org.

PlyBond

A group item used to communicate internal bond strength target or test value between plies according to a particular TestMethod.

TestMethod [attribute]

TestMethod is optional. A single instance might exist.

The method used to determine the results of the test under consideration.

TestAgency [attribute]

TestAgency is optional. A single instance might exist.

The agency that has set the parameters for the testing

Refer to TestAgency definition for any enumerations.

SampleType [attribute]

SampleType is optional. A single instance might exist.

Communicates how sampling was done to measure the product characteristics.

Refer to SampleType definition for any enumerations.

ResultSource [attribute]

ResultSource is optional. A single instance might exist.

Used to define the data source of the specified test

Refer to ResultSource definition for any enumerations.

(sequence)

The sequence of items below is mandatory. A single instance is required.

DetailValue

DetailValue is mandatory. A single instance is required.

A numeric value expressed in the unit of measure (UOM).

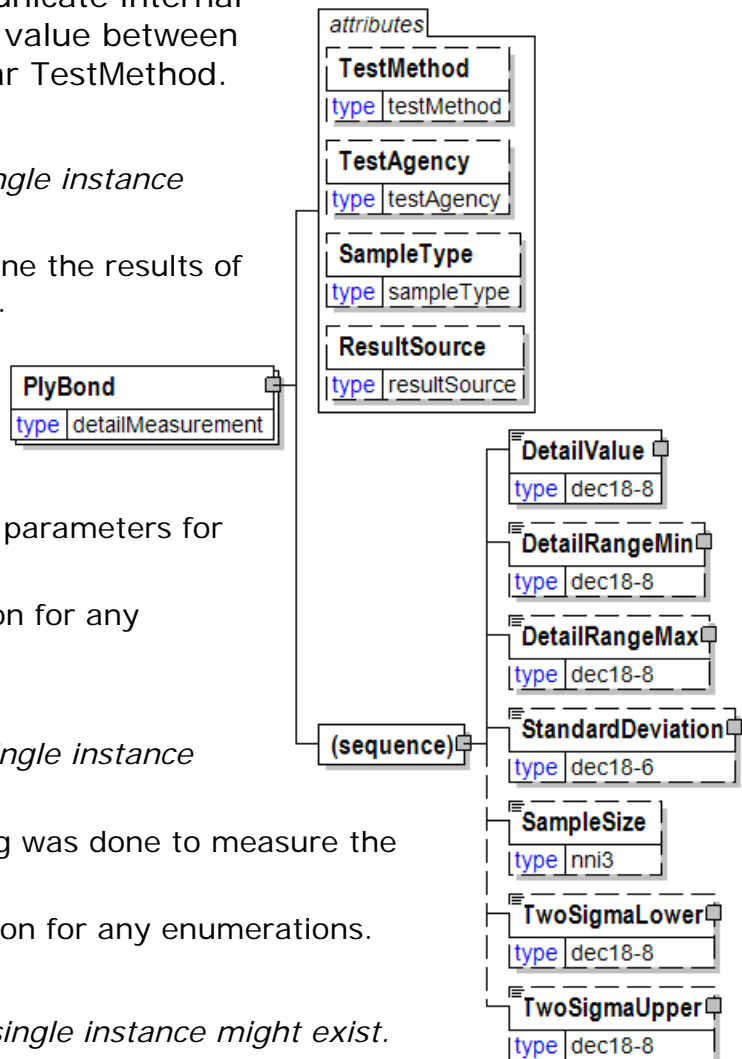

DetailRangeMin

DetailRangeMin is optional. A single instance might exist.

The minimum value (lower boundary) allowed for the DetailValue that is the parent of this element.

DetailRangeMax

DetailRangeMax is optional. A single instance might exist.

The maximum value (upper boundary) allowed for the DetailValue that is the parent of this element.

StandardDeviation

StandardDeviation is optional. A single instance might exist.

A statistic used as a measure of dispersion in a distribution.

SampleSize

SampleSize is optional. A single instance might exist.

The number of samples used to determine the product characteristic in question.

TwoSigmaLower

TwoSigmaLower is optional. A single instance might exist.

Two sigma (a measure of dispersion associated with standard deviation) on the lower side of the standard deviation.

TwoSigmaUpper

TwoSigmaUpper is optional. A single instance might exist.

Two sigma (a measure of dispersion associated with standard deviation) on the upper side of the standard deviation.

PlyNumber

Product attributes can be detailed for each ply. If product attributes are defined for the plies this element defines the ply that these product attributes apply to.

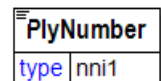

PlySet

PlySet.

EdgePaddable [attribute]

EdgePaddable is optional. A single instance might exist.

Refers to the process of applying edge padding glue or adhesive (Yes) or not (No). A liquid adhesive mixture which when brushed or sprayed onto the side of a pile of paper binds the sheets together along one edge, thus forming a pad.

Refer to EdgePaddable definition for any enumerations.

(sequence)

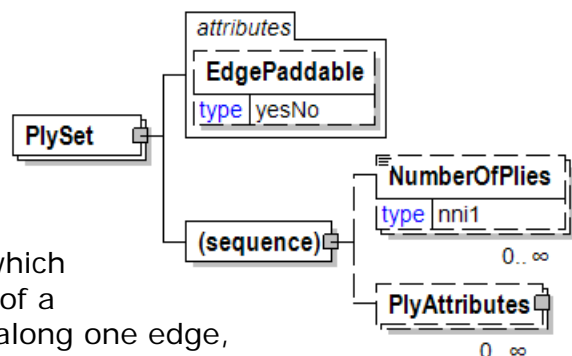

The sequence of items below is mandatory. A single instance is required.

NumberOfPlies

NumberOfPlies is optional. Multiple instances might exist.

The number of layers of paper product joined together to make the final saleable product.

PlyAttributes

PlyAttributes is optional. Multiple instances might exist.

The characteristics of the plies of paper or tissue. Manufacturing data relevant to each ply that constitutes the final product

PlywoodLayupStructure

(sequence)

The sequence of items below is mandatory. A single instance is required.

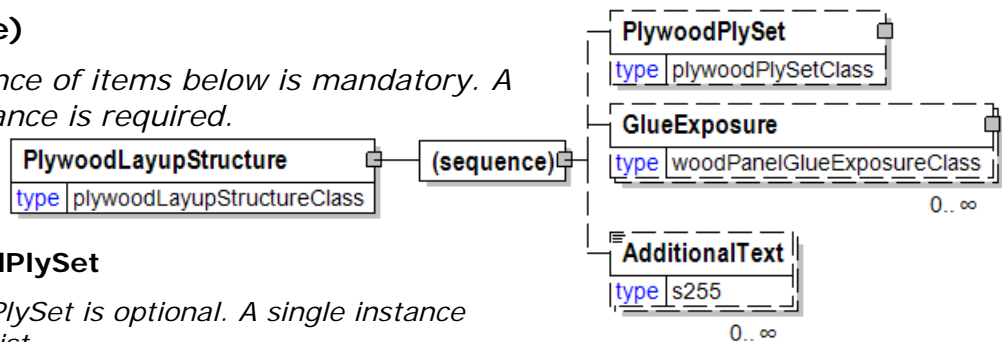

PlywoodPlySet

PlywoodPlySet is optional. A single instance might exist.

GlueExposure

GlueExposure is optional. Multiple instances might exist.

AdditionalText

AdditionalText is optional. Multiple instances might exist.

A text field that is used to communicate information not previously defined or for special instructions. To be used only for circumstances not covered by specific elements.

PlywoodMachining

PlywoodMachining defines the machining made to the panel (for example, grooving).

Agency [attribute]

Agency is mandatory. A single instance is required.

Describes the agency maintaining the list of codes. To be included in this list the agency must be a recognized standards body or industry organisation.

For the element that owns this attribute.

For another attribute in the list of attributes associated with the parent element.

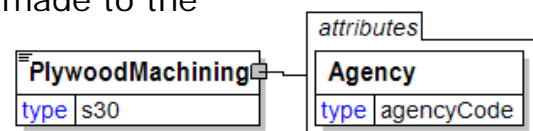

Refer to Agency definition for any enumerations.

PlywoodOSBGrade

Defines the grade of plywood, OSB product

Face [attribute]

Face is optional. A single instance might exist.

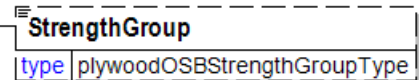
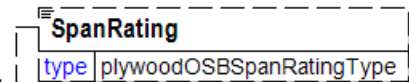
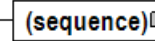
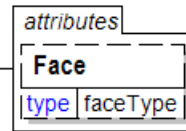
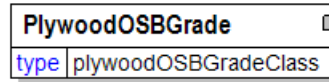

Used to describe which side (or face) of the product that the grade is applicable to.

Refer to Face definition for any enumerations.

(sequence)

The sequence of items below is mandatory. A single instance is required.

SpanRating

SpanRating is optional. A single instance might exist.

Span Rating according to NIST standards and indicated on grade stamp.

Refer to SpanRating definition for any enumerations.

StrengthGroup

StrengthGroup is optional. A single instance might exist.

As defined in the NIST standard, an additional classification of panel strength.

Refer to StrengthGroup definition for any enumerations.

PlywoodOSBSpecies

Defines the raw material species of plywood, OSB product.

This item is restricted to the following list.

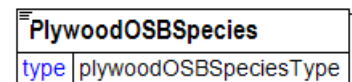

Southern

Western

Aspen

DF

Hemlock

Larch

WhiteFir

PlywoodPlyCharacteristics

(sequence)

The

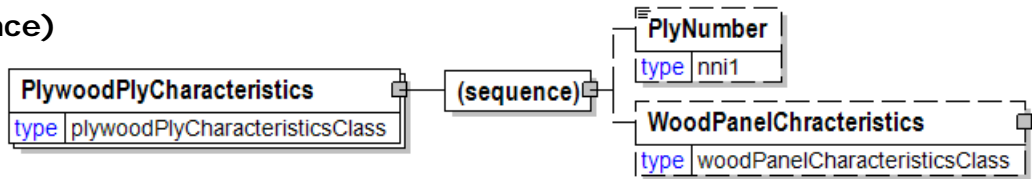

sequence of items below is mandatory. A single instance is required.

PlyNumber

PlyNumber is optional. A single instance might exist.

Product attributes can be detailed for each ply. If product attributes are defined for the plies this element defines the ply that these product attributes apply to.

WoodPanelChracteristics

WoodPanelChracteristics is optional. A single instance might exist.

PlywoodPlyGrade

Defines the grade of one ply, used with Agency to specify the grading agency.

Agency [attribute]

Agency is mandatory. A single instance is required.

Describes the agency maintaining the list of codes. To be included in this list the agency must be a recognized standards body or industry organisation.

For the element that owns this attribute.

For another attribute in the list of attributes associated with the parent element.

Refer to Agency definition for any enumerations.

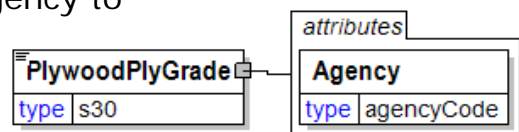

PlywoodPlySet

(sequence)

The sequence of items below is mandatory. A single instance is required.

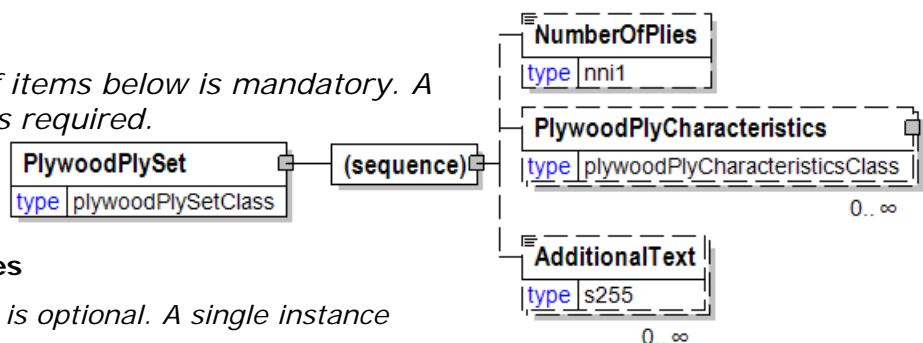

NumberOfPlies

NumberOfPlies is optional. A single instance might exist.

The number of layers of paper product joined together to make the final saleable

product.

PlywoodPlyCharacteristics

PlywoodPlyCharacteristics is optional. Multiple instances might exist.

AdditionalText

AdditionalText is optional. Multiple instances might exist.

A text field that is used to communicate information not previously defined or for special instructions. To be used only for circumstances not covered by specific elements.

Porosity

A group item used to communicate a permeability target or test value.

TestMethod [attribute]

TestMethod is optional. A single instance might exist.

The method used to determine the results of the test under consideration.

TestAgency [attribute]

TestAgency is optional. A single instance might exist.

The agency that has set the parameters for the testing

Refer to TestAgency definition for any enumerations.

SampleType [attribute]

SampleType is optional. A single instance might exist.

Communicates how sampling was done to measure the product characteristics.

Refer to SampleType definition for any enumerations.

ResultSource [attribute]

ResultSource is optional. A single instance might exist.

Used to define the data source of the specified test

Refer to ResultSource definition for any enumerations.

(sequence)

The sequence of items below is mandatory. A single instance is required.

DetailValue

DetailValue is mandatory. A single instance is required.

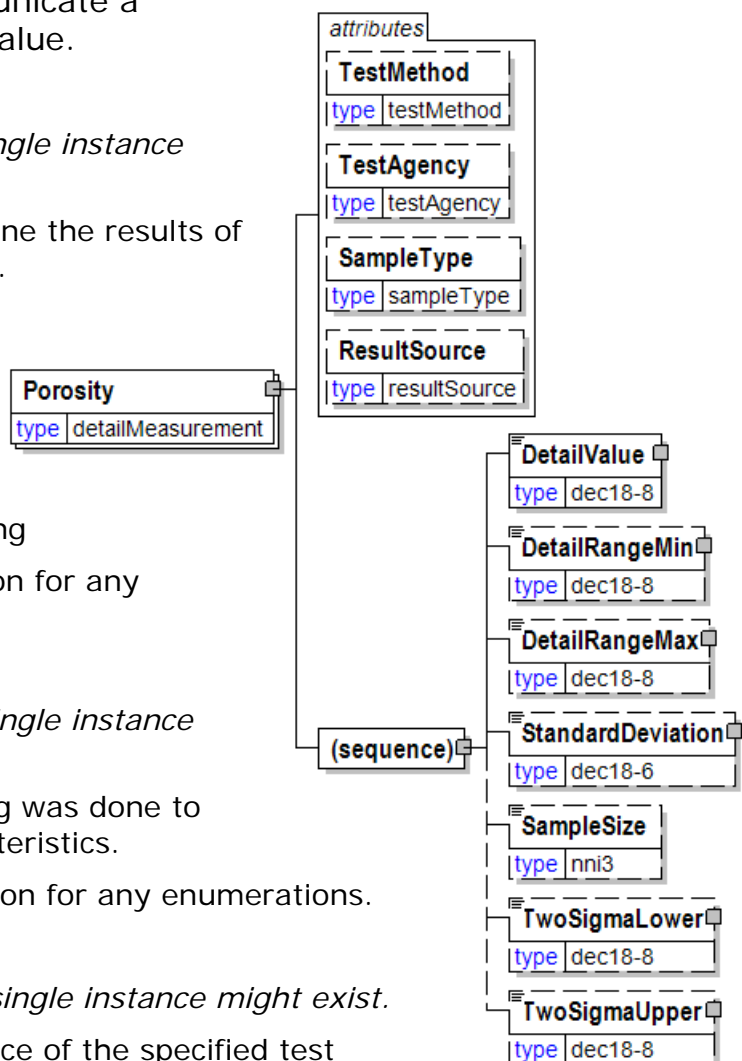

papiNet V2R31

A numeric value expressed in the unit of measure (UOM).

DetailRangeMin

DetailRangeMin is optional. A single instance might exist.

The minimum value (lower boundary) allowed for the DetailValue that is the parent of this element.

DetailRangeMax

DetailRangeMax is optional. A single instance might exist.

The maximum value (upper boundary) allowed for the DetailValue that is the parent of this element.

StandardDeviation

StandardDeviation is optional. A single instance might exist.

A statistic used as a measure of dispersion in a distribution.

SampleSize

SampleSize is optional. A single instance might exist.

The number of samples used to determine the product characteristic in question.

TwoSigmaLower

TwoSigmaLower is optional. A single instance might exist.

Two sigma (a measure of dispersion associated with standard deviation) on the lower side of the standard deviation.

TwoSigmaUpper

TwoSigmaUpper is optional. A single instance might exist.

Two sigma (a measure of dispersion associated with standard deviation) on the upper side of the standard deviation.

PositionInSheet

Location in the sheet where the defect was identified.

PositionInSheet	
type	s20

PositionMeasuredFrom [attribute]

Defines from where the position is measured on an item.

PositionMeasuredFrom	
type	positionMeasuredFrom

This item is restricted to the following list.

Bottom

The position is measured from the bottom of the item.

BackEnd

The position is measured from the back end of the item.

FrontEnd

The position is measured from the front end of the item.

LargeEnd

papiNet V2R31

The position is measured from the large end of the item.

SmallEnd

The position is measured from the small end of the item.

Top

The position is measured from the top of the item.

PositionOnItem

Specifies a position on an item. The attribute PositionMeasuredFrom defines the reference point for the position.

PositionMeasuredFrom [attribute]

PositionMeasuredFrom is mandatory. A single instance is required.

Specifies how detailed the measurements are done.

Refer to PositionMeasuredFrom definition for any enumerations.

UOM [attribute]

UOM is mandatory. A single instance is required.

Defines the unit of measure for the value.

Refer to UOM definition for any enumerations.

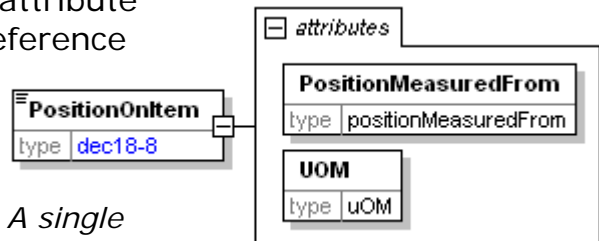

PostalCode

The postal code associated with the address elements.



PostConsumerWaste

A group item used to communicate the target or test value percentage of post consumer waste fibre in the product according to a particular TestMethod.

TestMethod [attribute]

TestMethod is optional. A single instance might exist.

The method used to determine the results of the test under consideration.

TestAgency [attribute]

TestAgency is optional. A single instance might exist.

The agency that has set the parameters for the testing

Refer to TestAgency definition for any enumerations.

SampleType [attribute]

SampleType is optional. A single instance might exist.

Communicates how sampling was done to measure the product characteristics.

Refer to SampleType definition for any enumerations.

ResultSource [attribute]

ResultSource is optional. A single instance might exist.

Used to define the data source of the specified test

Refer to ResultSource definition for any enumerations.

(sequence)

The sequence of items below is mandatory. A single instance is required.

DetailValue

DetailValue is mandatory. A single instance is required.

A numeric value expressed in the unit of measure (UOM).

DetailRangeMin

DetailRangeMin is optional. A single instance might exist.

The minimum value (lower boundary) allowed for the DetailValue that is the parent of this element.

DetailRangeMax

DetailRangeMax is optional. A single instance might exist.

The maximum value (upper boundary) allowed for the DetailValue that is the parent of this element.

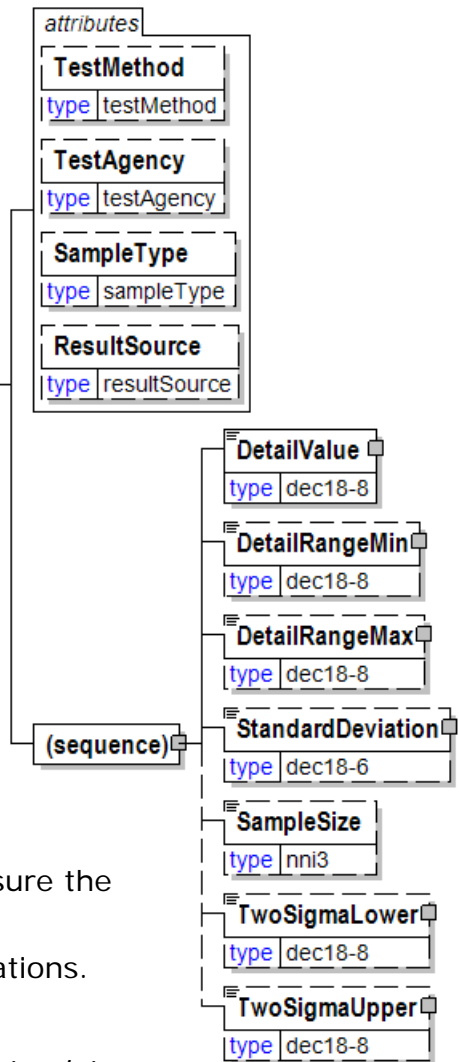

papiNet V2R31

StandardDeviation

StandardDeviation is optional. A single instance might exist.

A statistic used as a measure of dispersion in a distribution.

SampleSize

SampleSize is optional. A single instance might exist.

The number of samples used to determine the product characteristic in question.

TwoSigmaLower

TwoSigmaLower is optional. A single instance might exist.

Two sigma (a measure of dispersion associated with standard deviation) on the lower side of the standard deviation.

TwoSigmaUpper

TwoSigmaUpper is optional. A single instance might exist.

Two sigma (a measure of dispersion associated with standard deviation) on the upper side of the standard deviation.

PPI

A group item used to communicate the number of pages in an inch of thickness either as a target or actual value. Equal to the number of sheets per inch times 2.

(sequence)

The sequence of items below is mandatory. A single instance is required.

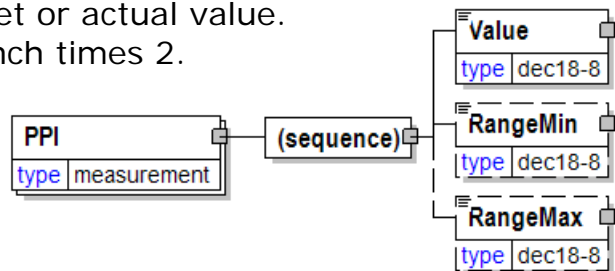

Value

Value is mandatory. A single instance is required.

A numeric value expressed in the unit of measure (UOM).

RangeMin

RangeMin is optional. A single instance might exist.

The minimum value (lower boundary) allowed for the Measurement that is the parent of this element.

RangeMax

RangeMax is optional. A single instance might exist.

The maximum value (upper boundary) allowed for the Measurement that is the parent of this element. Some elements use the RangeMax element with an extended list of unit of measures. (Note: the red colour in the picture is an artifact of how the graphic was captured and should be disregarded.)

PreConsumerWaste

A group item used to communicate the target or test value percentage of pre-consumer waste fibre in the product according to a particular TestMethod.

TestMethod [attribute]

TestMethod is optional. A single instance might exist.

The method used to determine the results of the test under consideration.

TestAgency [attribute]

TestAgency is optional. A single instance might exist.

The agency that has set the parameters for the testing

Refer to TestAgency definition for any enumerations.

SampleType [attribute]

SampleType is optional. A single instance might exist.

Communicates how sampling was done to measure the product characteristics.

Refer to SampleType definition for any enumerations.

ResultSource [attribute]

ResultSource is optional. A single instance might exist.

Used to define the data source of the specified test

Refer to ResultSource definition for any enumerations.

(sequence)

The sequence of items below is mandatory. A single instance is required.

DetailValue

DetailValue is mandatory. A single instance is required.

A numeric value expressed in the unit of measure (UOM).

DetailRangeMin

DetailRangeMin is optional. A single instance might exist.

The minimum value (lower boundary) allowed for the DetailValue that is the parent of this element.

DetailRangeMax

DetailRangeMax is optional. A single instance might exist.

The maximum value (upper boundary) allowed for the DetailValue that is the parent of this element.

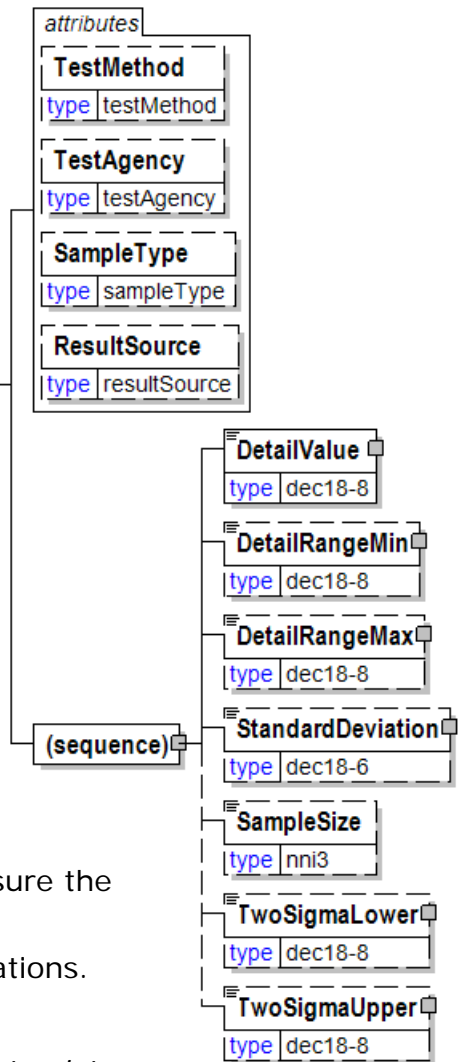
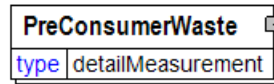

StandardDeviation

StandardDeviation is optional. A single instance might exist.

A statistic used as a measure of dispersion in a distribution.

SampleSize

SampleSize is optional. A single instance might exist.

The number of samples used to determine the product characteristic in question.

TwoSigmaLower

TwoSigmaLower is optional. A single instance might exist.

Two sigma (a measure of dispersion associated with standard deviation) on the lower side of the standard deviation.

TwoSigmaUpper

TwoSigmaUpper is optional. A single instance might exist.

Two sigma (a measure of dispersion associated with standard deviation) on the upper side of the standard deviation.

PrepDueDate

The preparation due date.

(sequence)

The sequence of items below is mandatory. A single instance is required.

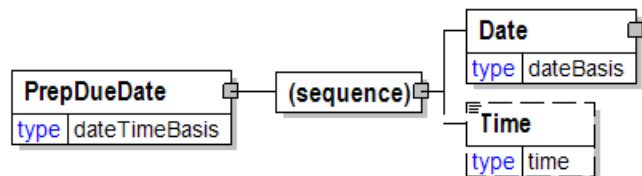

Date

Date is mandatory. A single instance is required.

A group element that contains the specification of Year, Month, and Day.

Time

Time is optional. A single instance might exist.

Times are treated in a standard XML fashion with a special case used to indicate a generalized "local" time. The standard XML approach to time is hh:mm:ss, hh:mm:ssZ, or hh:mm:ss±hh:mm.

hh:mm:ss±hh:mm is used to represent a time with a time zone. The time zone is communicated as the number of hours offset from the Universal Time Coordinate (UTC), a.k.a. Greenwich Mean Time.

hh:mm:ssZ indicates the time at Zulu (another name for UTC). Based on the convention described in the next bullet it will be important for users within UTC to use "Z" when communicating a time in their time zone to other users.

hh:mm:ss or hh:mm indicates in the XML standard the time at UTC however, within papiNet it is used to represent the applicable local time. Caution should be used when processing times of this nature as the papiNet approach may be in discord with other users of XML.

PrepInformation

Information related to the preparation of the Book.

PrepType [attribute]

PrepType is optional. A single instance might exist.

The type of input for press preparation

Refer to PrepType definition for any enumerations.

(sequence)

The sequence of items below is mandatory. A single instance is required.

SupplierParty

SupplierParty is mandatory. A single instance is required.

The organisation or business entity responsible for providing the product. SupplierParty is also the seller of the product, if Seller is not specified as OtherParty = Seller.

PrepShipDate

PrepShipDate is optional. A single instance might exist.

The preparation ship date.

PrepDueDate

PrepDueDate is optional. A single instance might exist.

The preparation due date.

PrepNeededDate

PrepNeededDate is optional. A single instance might exist.

The preparations need date.

AdditionalText

AdditionalText is optional. Multiple instances might exist.

A text field that is used to communicate information not previously defined or for special instructions. To be used only for circumstances not covered by specific elements.

PrepReference

PrepReference is optional. Multiple instances might exist.

An element detailing relevant references pertaining to the preparation of a book or a book component. The type of reference is identified by the attributes PrepReferenceType and AssignedBy.

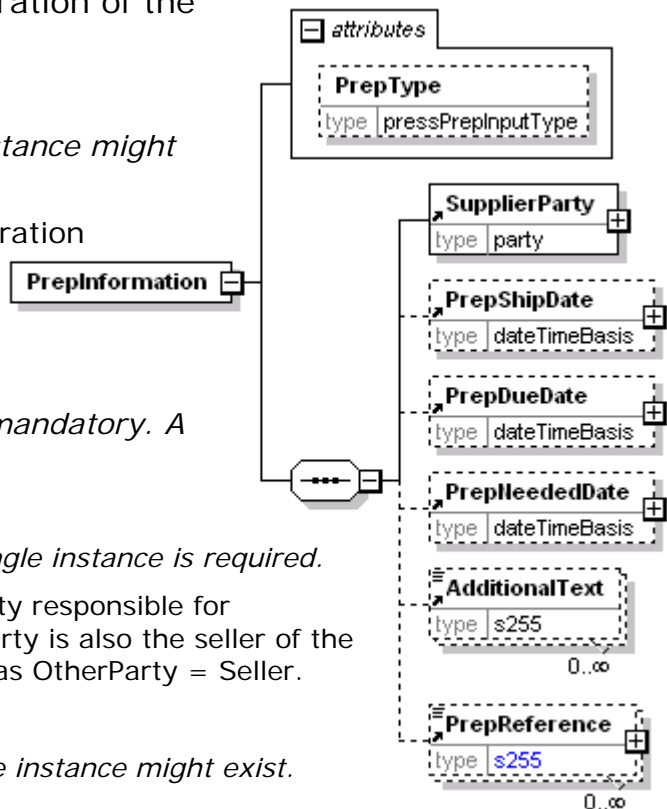

PrepNeededDate

The preparations need date.

(sequence)

The sequence of items below is mandatory. A single instance is required.

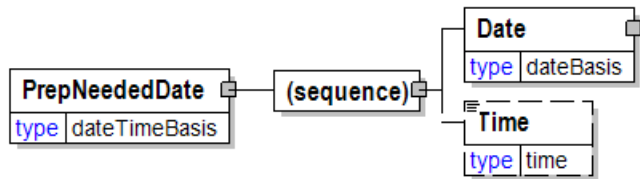

Date

Date is mandatory. A single instance is required.

A group element that contains the specification of Year, Month, and Day.

Time

Time is optional. A single instance might exist.

Times are treated in a standard XML fashion with a special case used to indicate a generalized "local" time. The standard XML approach to time is hh:mm:ss, hh:mm:ssZ, or hh:mm:ss±hh:mm.

hh:mm:ss±hh:mm is used to represent a time with a time zone. The time zone is communicated as the number of hours offset from the Universal Time Coordinate (UTC), a.k.a. Greenwich Mean Time.

hh:mm:ssZ indicates the time at Zulu (another name for UTC). Based on the convention described in the next bullet it will be important for users within UTC to use "Z" when communicating a time in their time zone to other users.

hh:mm:ss or hh:mm indicates in the XML standard the time at UTC however, within papiNet it is used to represent the applicable local time. Caution should be used when processing times of this nature as the papiNet approach may be in discord with other users of XML.

PrepReference

An element detailing relevant references pertaining to the preparation of a book or a book component. The type of reference is identified by the attributes PrepReferenceType and AssignedBy.

PrepReferenceType [attribute]

PrepReferenceType is mandatory. A single instance is required.

Provides a contextual explanation of the specific reference identifier. Many items are currently prefixed by "Buyer", "Forwarder", "Manufacturer", "Mill", "Seller", "Supplier", "Warehouse", or "Vendor". Check for an existing non-prefixed version and use the non-prefixed version instead. In the (yet to be announced release date) version 3.0 the prefixed versions will be removed. Instead the attribute @AssignedBy will communicate the information previously communicated in the prefix.

Refer to PrepReferenceType definition for any enumerations.

AssignedBy [attribute]

AssignedBy is optional. A single instance might exist.

Identifies the type of party that has assigned the associated item, e.g. a reference of type OrderNumber.

Refer to AssignedBy for any enumerations.

PrepReferenceType [attribute]

Provides a contextual explanation of the specific reference identifier. Many items are currently prefixed by "Buyer", "Forwarder", "Manufacturer", "Mill", "Seller", "Supplier", "Warehouse", or "Vendor". Check for an existing non-prefixed version and use the non-prefixed version instead. In the (yet to be announced release date) version 3.0 the prefixed versions will be removed. Instead the attribute @AssignedBy will communicate the information previously communicated in the prefix.

Refer to the [referenceType](#) entry for the list of enumerations and their definitions.

PrepShipDate

The preparation ship date.

(sequence)

The sequence of items below is mandatory. A single instance is required.

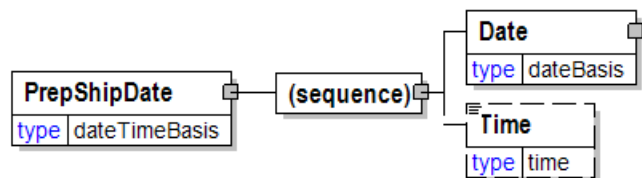

Date

Date is mandatory. A single instance is required.

A group element that contains the specification of Year, Month, and Day.

Time

Time is optional. A single instance might exist.

Times are treated in a standard XML fashion with a special case used to indicate a generalized "local" time. The standard XML approach to time is hh:mm:ss, hh:mm:ssZ, or hh:mm:ss±hh:mm.

hh:mm:ss±hh:mm is used to represent a time with a time zone. The time zone is communicated as the number of hours offset from the Universal Time Coordinate (UTC), a.k.a. Greenwich Mean Time.

hh:mm:ssZ indicates the time at Zulu (another name for UTC). Based on the convention described in the next bullet it will be important for users within UTC to use "Z" when communicating a time in their time zone to other users.

hh:mm:ss or hh:mm indicates in the XML standard the time at UTC however, within papiNet it is used to represent the applicable local time. Caution should be used when processing times of this nature as the papiNet approach may be in discord with other users of XML.

PrepType [attribute]

The type of input for press preparation

This item is restricted to the following list.

4PageImposedFilm
8PageImposedFilm
ApplicationFiles
Bookmap
CameraCopy
CopyBook
DuplicateStrip
ElectronicFiles
ElectronicGraphic
Film
FilmPageNegatives
FilmPagePositives
IllustrationFilm
NegativeImposedPlateMakingFilm
Originals
OriginalArt
Other
Overtakes
PageProof
PDF
PositiveImposedPlateMakingFilm
RachwalFilm
ReflectiveArtBoard
ReproProof
RestripSuppliedFlats
TearSheet
Transparencies

attribute
PrepType
type pressPrepInputType

PressBreakLocation

The specific location identified within a printing press.

LocationType [attribute]

LocationType is mandatory. A single instance is required.

Location of Break on the Press. A group item detailing relevant locations on the press to the Performance e-Document.

Refer to LocationType definition for any enumerations.

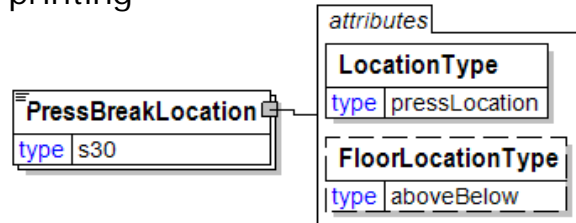

FloorLocationType [attribute]

FloorLocationType is optional. A single instance might exist.

Floor Location Type

Refer to FloorLocationType definition for any enumerations.

PressComponent

Press Component.

BarcodeSuppliedByPublisher [attribute]

BarcodeSuppliedByPublisher is optional. A single instance might exist.

Barcode supplied by publisher

Refer to



BarcodeSuppliedByPublisher definition for any enumerations.

(sequence)

The sequence of items below is mandatory. A single instance is required.

NumberOfPages

NumberOfPages is optional. A single instance might exist.

The number of pages.

Signatures

Signatures is optional. Multiple instances might exist.

Signatures.

PressPrep

PressPrep is optional. A single instance might exist.

Press preparation information

ManufacturingSpecifications

ManufacturingSpecifications is optional. A single instance might exist.

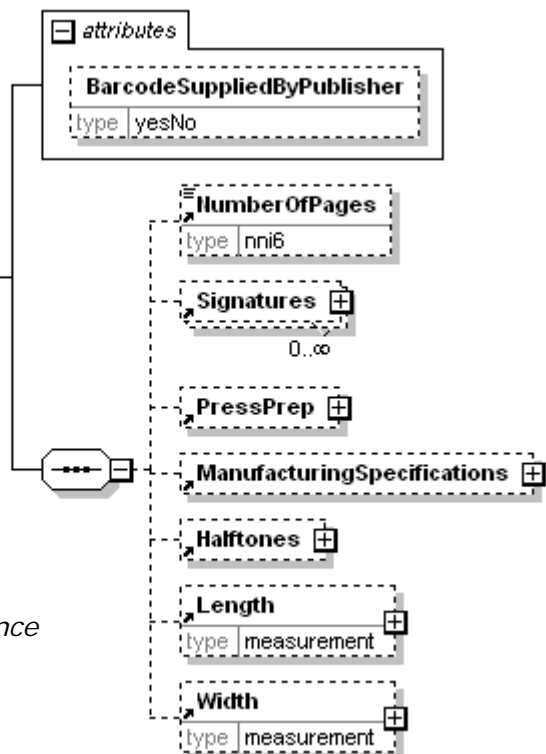

Manufacturing specifications.

Halftones

Halftones is optional. A single instance might exist.

Halftones are images made up of a series of dots in a specific pattern that simulates the look of a continuous tone image.

Length

Length is optional. A single instance might exist.

The length of the object.

Width

Width is optional. A single instance might exist.

The width of the object.

PressConditions

Construct contains environmental conditions of the press during operations

(sequence)

The sequence of items below is mandatory. A single instance is required.

Humidity

Humidity is optional. Multiple instances might exist.

Humidity

AmbientTemperature

AmbientTemperature is optional. Multiple instances might exist.

The temperature of the surrounding environment.

MachineSpeed

MachineSpeed is optional. Multiple instances might exist.

The rate at which the machine is, was, or should be running.

Impressions

Impressions is optional. Multiple instances might exist.

The work produced by one revolution of the printing cylinder or unit.

Tension

Tension is optional. Multiple instances might exist.

Tension of the web on the printing press.

Alignment

Alignment is optional. Multiple instances might exist.

A measurement of how the reel is aligned on printing press

PrintUnit

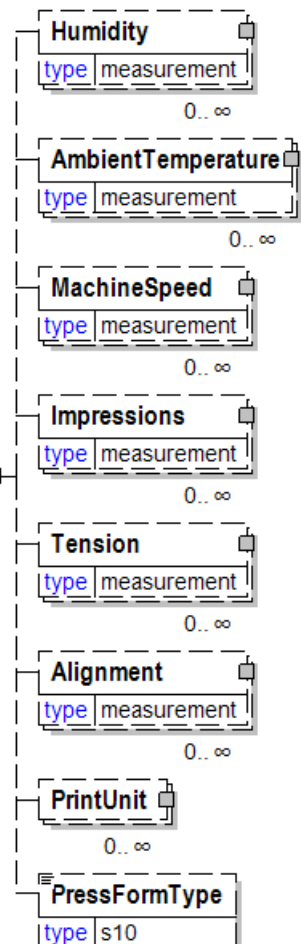
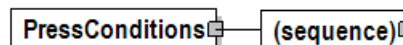

PrintUnit is optional. Multiple instances might exist.

PrintUnit identifies the unique qualities associated with the individual unit of the printing press.

PressFormType

PressFormType is optional. A single instance might exist.

Description of press form, expressed as deliveries and number of pages in the signature being printed, e.g. 2X16, 4X4.

PressFormType

Description of press form, expressed as deliveries and number of pages in the signature being printed, e.g. 2X16, 4X4.

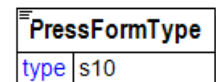

PressImpositionType [attribute]

The type of press imposition

This item is restricted to the following list.

HeadToHead

FootToFoot

HeadToFoot

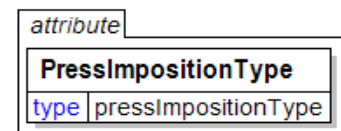

PressPrep

Press preparation information

PressPrepOutputType [attribute]

PressPrepOutputType is optional. A single instance might exist.

The press prep output type.

Refer to PressPrepOutputType definition for any enumerations.

(sequence)

The sequence of items below is mandatory. A single instance is required.

PressPrepInput

PressPrepInput is mandatory. One instance is required, multiple instances might exist.

Element used to identify press preparation media and type of media required for input to the press component.

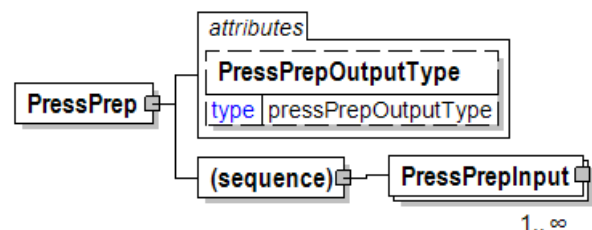

PressPreInput

Element used to identify press preparation media and type of media required for input to the press component.

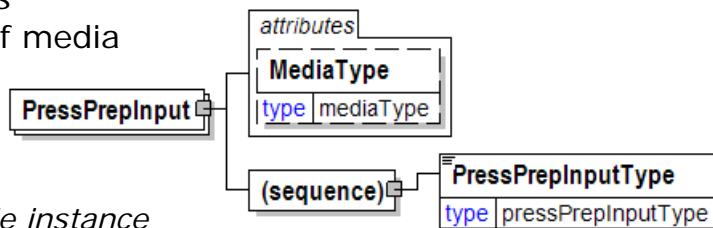

MediaType [attribute]

MediaType is optional. A single instance might exist.

The type of media

Refer to MediaType definition for any enumerations.

(sequence)

The sequence of items below is mandatory. A single instance is required.

PressPreInputType

PressPreInputType is mandatory. A single instance is required.

Press prep input type

Refer to PressPreInputType definition for any enumerations.

PressPreInputType

Press prep input type

This item is restricted to the following list.

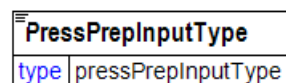

4PageImposedFilm

8PageImposedFilm

ApplicationFiles

Bookmap

CameraCopy

CopyBook

DuplicateStrip

ElectronicFiles

ElectronicGraphic

Film

FilmPageNegatives

FilmPagePositives

IllustrationFilm

NegativeImposedPlateMakingFilm

Originals

OriginalArt

Other

Overtakes

PageProof
PDF
PositiveImposedPlateMakingFilm
RachwalFilm
ReflectiveArtBoard
ReproProof
RestripSuppliedFlats
TearSheet
Transparencies

PressPrepOutputType [attribute]

The press prep output type.

This item is restricted to the following list.

DirectToFilm
DirectToPlate
DirectToPress
Film

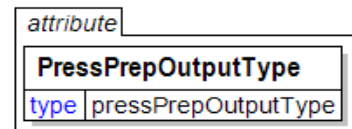

PressType [attribute]

The type of press used.

This item is restricted to the following list.

Cameron

A type of belt press that both prints and binds a book.

ColdsetOffset

An offset printing method suitable for newspapers, in other words, ink dries by penetration into the paper.

Digital

Digital print process that uses electronic files in print production.

DigitalInkJet.

Digital print process that uses inkjet technology.

DigitalToner

Digital print process that uses toner technology.

Electronic

Any technology that reproduces pages without the use of traditional ink, water, chemistry, or plates; also known as plateless printing.

Flexographic

A type of printing that uses rubber printing plates.

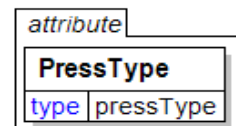

Gravure

A method of printing in which the image is etched into the printing plates, as opposed to letterpress printing, in which the image is slightly raised from the rest of the plate. Gravure printing produces consistent quality in long production runs.

HeatsetOffset

An offset printing method.

LetterPress

The oldest printing method, in which the image to be printed is raised from the plate, inked, and applied directly to paper.

Offset

Use this option when you do not wish to designate which type of offset press approach to use, just that offset printing is the preferred printing method.

SheetFed

A type of printing press that accepts paper in the form of sheets.

SilkScreen

A printing method in which ink is pushed through a stencil, used for imprinting T-shirts and heavier paper stocks.

Web

A printing press that uses rolls (webs) of paper rather than sheets. Also called web-fed press.

PressureTreatment

Method and parameter values of pressure treatment.

(sequence)

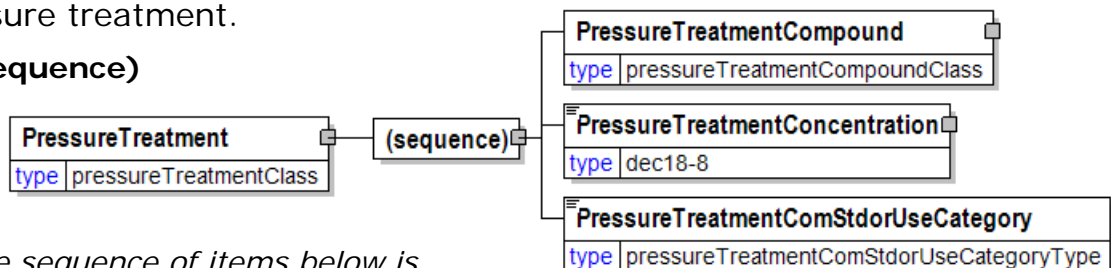

The sequence of items below is mandatory. A single instance is required.

PressureTreatmentCompound

PressureTreatmentCompound is mandatory. A single instance is required.

The substance used for pressure treatment.

PressureTreatmentConcentration

PressureTreatmentConcentration is mandatory. A single instance is required.

Retained concentration of preservative chemical.

PressureTreatmentComStdorUseCategory

PressureTreatmentComStdorUseCategory is mandatory. A single instance is required.

Pressure treatment compound standard or use category

Refer to PressureTreatmentComStdorUseCategory definition for any enumerations.

PressureTreatmentCompound

The substance used for pressure treatment.

CompoundType [attribute]

CompoundType is optional. A single instance might exist.

Defines the type of chemical treatment used.

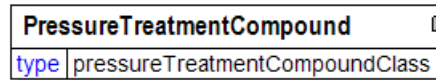

CompoundAgency [attribute]

CompoundAgency is optional. A single instance might exist.

The agency responsible for the compound coding. Defines the trade name of the treatment.

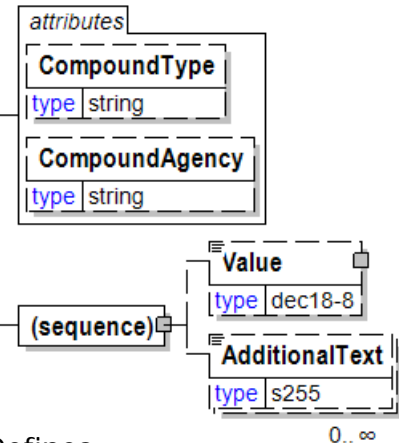

(sequence)

The sequence of items below is mandatory. A single instance is required.

Value

Value is optional. A single instance might exist.

A numeric value expressed in the unit of measure (UOM).

AdditionalText

AdditionalText is optional. Multiple instances might exist.

A text field that is used to communicate information not previously defined or for special instructions. To be used only for circumstances not covered by specific elements.

PressureTreatmentComStdorUseCategory

Pressure treatment compound standard or use category

This item is restricted to the following list.

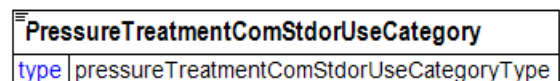

C2

C3

C4

C5

C6

C9

C11

C14

C15

C17

C18

C20

C22

C23

C24

C25

C27

C28

C29

C30

C31

C32

C33

C34

C35

N1

N2

UC2

UC3A

UC3B

UC4A

UC4B

UC4C

UC5A

UC5B

UC5C

UCFA

UCFB

PressureTreatmentConcentration

Retained concentration of preservative chemical.

UOM [attribute]

UOM is optional. A single instance

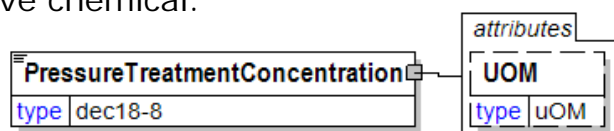

might exist.

Defines the unit of measure for the value.

Refer to UOM definition for any enumerations.

PriceAdjustment

A group item defining a deviation from the PricePerUnit.

(sequence)

The sequence of items below is mandatory. A single instance is required.

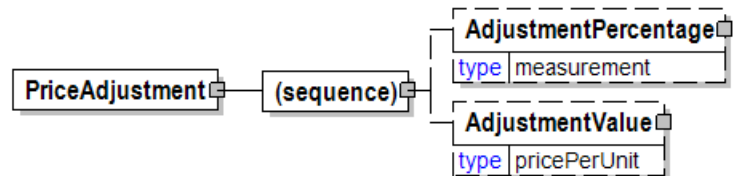

AdjustmentPercentage

AdjustmentPercentage is optional. A single instance might exist.

A percentage, either negative or positive, that is applied to either the price, or a starting amount to determine the value of the particular MonetaryAdjustment.

AdjustmentValue

AdjustmentValue is optional. A single instance might exist.

A group element that contains a currency value, either positive or negative, and a measurement value (in other words a price per unit structure) that will be used in the price adjustment AdjustmentValue.

PriceAndAmountInfo

A grouping element that contains information about price and amounts.

(sequence)

The sequence of items below is mandatory. A single instance is required.

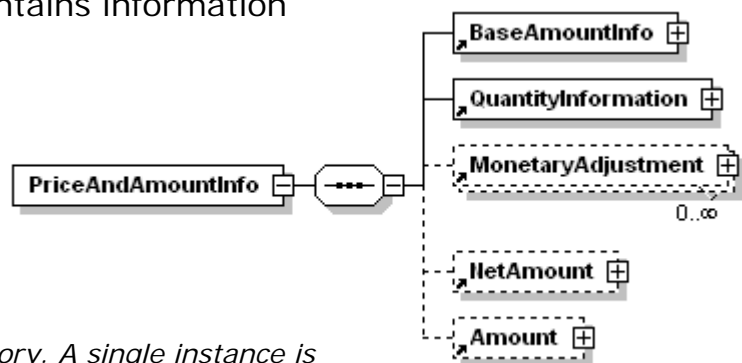

BaseAmountInfo

BaseAmountInfo is mandatory. A single instance is required.

A grouping element that contains information about price and base amount without any taxes.

QuantityInformation

QuantityInformation is mandatory. A single instance is required.

A group item containing information about quantity and informational quantity of similar items.

MonetaryAdjustment

MonetaryAdjustment is optional. Multiple instances might exist.

The element containing the information necessary for the understanding, calculation, and treatment of an adjustment to a currency amount.

MonetaryAdjustment contains an attribute that indicates they type of adjustment being communicated.

NetAmount

NetAmount is optional. A single instance might exist.

An element that contains the net amount excluding tax. Adjustments are included in NetAmount. NetAmount encapsulates CurrencyValue.

Amount

Amount is optional. A single instance might exist.

An element that contains the amount including tax. The Amount encapsulates CurrencyValue.

PriceDetails

An element that groups together price information.

PriceQuantityBasis [attribute]

PriceQuantityBasis is mandatory. A single instance is required.

The basis for the determination of the price.

Refer to PriceQuantityBasis definition for any enumerations.

PriceTaxBasis [attribute]

PriceTaxBasis is optional. A single instance might exist.

This price provides the basis for tax.

Refer to PriceTaxBasis definition for any enumerations.

(sequence)

The sequence of items below is mandatory. A single instance is required.

PricePerUnit

PricePerUnit is mandatory. A single instance is required.

PricePerUnit is an element designed to support flexibility in price representation.

This structure is read as CurrencyValue per MeasurementValue, or alternatively CurrencyValue per number of UOM(s).

InformationalPricePerUnit

InformationalPricePerUnit is optional. Multiple instances might exist.

A group item containing a currency value and a measurement value used convey a secondary PricePerUnit. For example, where PricePerUnit is dollars per ton. InformationalPricePerUnit could be dollars per kilogram.

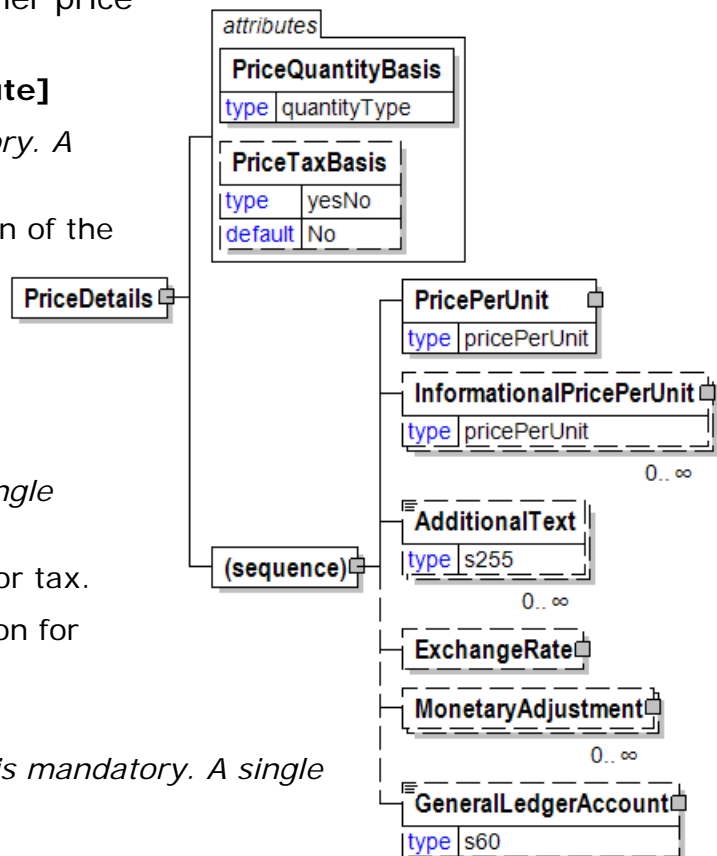

AdditionalText

AdditionalText is optional. Multiple instances might exist.

A text field that is used to communicate information not previously defined or for special instructions. To be used only for circumstances not covered by specific elements.

ExchangeRate

ExchangeRate is optional. A single instance might exist.

The exchange rate as of the date included in the element.

MonetaryAdjustment

MonetaryAdjustment is optional. Multiple instances might exist.

The element containing the information necessary for the understanding, calculation, and treatment of an adjustment to a currency amount. MonetaryAdjustment contains an attribute that indicates they type of adjustment being communicated.

GeneralLedgerAccount

GeneralLedgerAccount is optional. A single instance might exist.

The general ledger account to be referenced for the item.

PricePerUnit

PricePerUnit is an element designed to support flexibility in price representation.

This structure is read as CurrencyValue per MeasurementValue, or alternatively CurrencyValue per number of UOM(s).

(sequence)

The sequence of items below is mandatory. A single instance is required.

CurrencyValue

CurrencyValue is mandatory. A single instance is required.

The amount in the referenced currency as defined by the CurrencyType attribute.

Value

Value is mandatory. A single instance is required.

A numeric value expressed in the unit of measure (UOM).

RangeMin

RangeMin is optional. A single instance might exist.

The minimum value (lower boundary) allowed for the Measurement that is the parent of this element.

RangeMax

RangeMax is optional. A single instance might exist.

The maximum value (upper boundary) allowed for the Measurement that is the parent of this element. Some elements use the RangeMax element with an extended list of unit of measures. (Note: the red colour in the picture is an artifact)

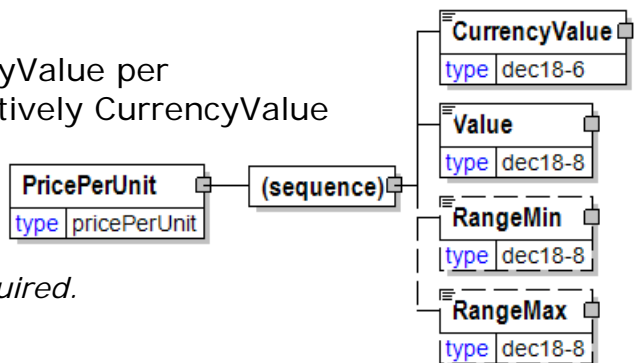

of how the graphic was captured and should be disregarded.)

PriceQuantityBasis [attribute]

The basis for the determination of the price.

This item is restricted to the following list.

attribute
PriceQuantityBasis
type quantityType

ActualVolume

Actual product space.

AirDryWeight

Contains a normal amount of moisture.

Area

A number that represents the length multiplied by the width is being communicated.

BoneDry

Contains insignificant moisture.

Count

The number of items.

Distance

The quantity being communicated is a distance.

GrossWeight

The weight including all packaging and furnishing. The gross weight of the deliveries is being used, includes tare weight.

Energy

The quantity represents energy content.

Length

The length of the object.

LogPileVolume

The volume of a pile of logs, including gaps.

NetWeight

The net weight of the product is being used, does not include tare weights. May include certain conversion components.

NetNetWeight

The net weight of the product without any packaging or conversion materials.

NominalWeight

A calculated weight that is derived from another measurement. For example, the length of paper multiplied by the specified basis weight could be used to derive a nominal weight.

Percent

The number being communicated is a percentage.

papiNet V2R31

RunningLength

The length of the reel.

ShortLengthVolume

SolidWoodVolume

The volume of logs, stems, chips, etc. without bark and gaps.

TareWeight

The weight of the previously agreed to packaging and furnishing.

Time

The number being communicated represents an amount of time.

TippedLooseVolume

The volume of tipped loose content, including gaps. Often used as a quantity type for piles of chips, sawdust, etc.

Volume

WoodVolume

The volume of logs, stems, chips, etc. without gaps but including bark.

PriceTaxBasis [attribute]

This price provides the basis for tax.

This item is restricted to the following list.

Yes

No

attribute	
PriceTaxBasis	
type	yesNo
default	No

PrintedMediaSpecs

Printed media specifications

Perforated [attribute]

Perforated is optional. A single instance might exist.

Either "Yes" or "No".

Refer to Perforated definition for any enumerations.

Scored [attribute]

Scored is optional. A single instance might exist.

Is this item scored?

Refer to Scored definition for any enumerations.

Folded [attribute]

Folded is optional. A single instance might exist.

Either "Yes" or "No".

Refer to Folded definition for any enumerations.

Collated [attribute]

Collated is optional. A single instance might exist.

Either "Yes" or "No".

Refer to Collated definition for any enumerations.

RoundCornered [attribute]

RoundCornered is optional. A single instance might exist.

Is the item round cornered?

Refer to RoundCornered definition for any enumerations.

Drilled [attribute]

Drilled is optional. A single instance might exist.

Either "Yes" or "No".

Refer to Drilled definition for any enumerations.

DieCut [attribute]

DieCut is optional. A single instance might exist.

Either "Yes" or "No".

Refer to DieCut definition for any enumerations.

(sequence)

The sequence of items below is mandatory. A single instance is required.

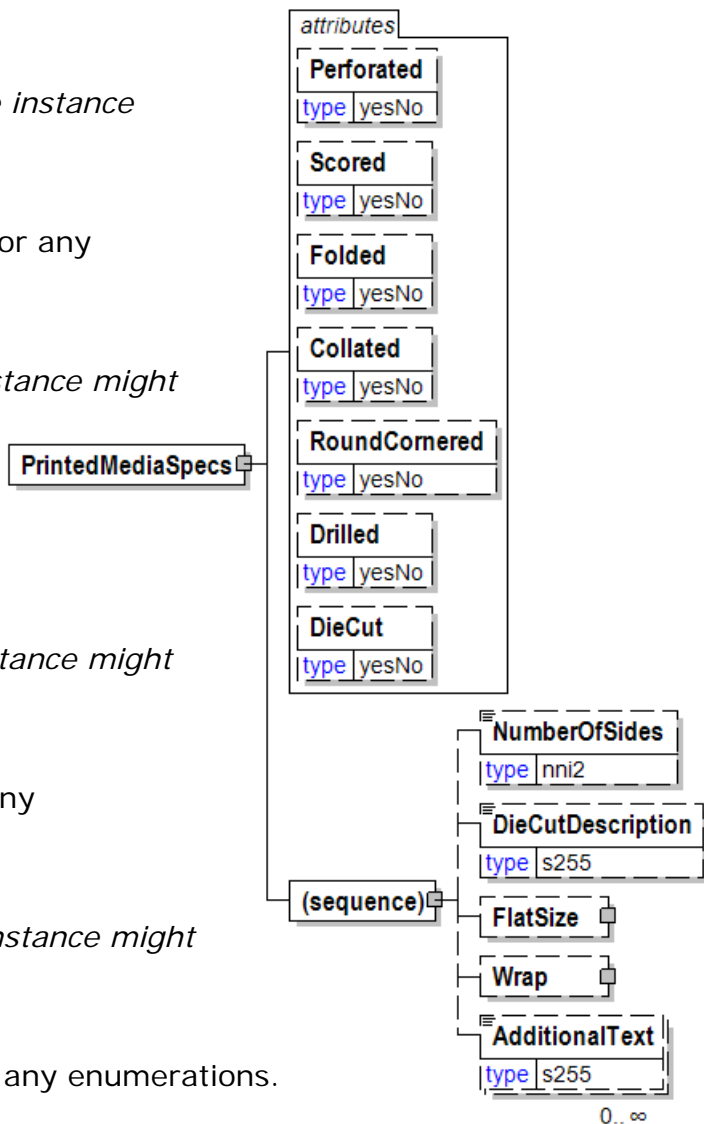

NumberOfSides

NumberOfSides is optional. A single instance might exist.

The number of sides.

DieCutDescription

DieCutDescription is optional. A single instance might exist.

Die cut description

FlatSize

FlatSize is optional. A single instance might exist.

Flat size

Wrap

Wrap is optional. A single instance might exist.

A group item that organises wrapping detail information.

AdditionalText

AdditionalText is optional. Multiple instances might exist.

A text field that is used to communicate information not previously defined or for special instructions. To be used only for circumstances not covered by specific elements.

PrintingMaterials

Printing materials information.

(sequence)

The sequence of items below is mandatory. A single instance is required.

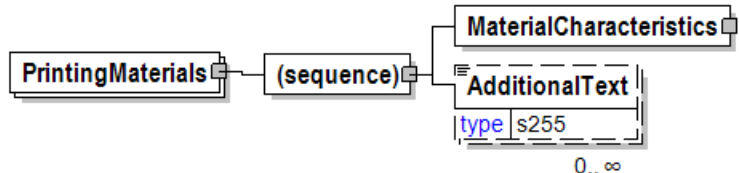

MaterialCharacteristics

MaterialCharacteristics is mandatory. A single instance is required.

Material characteristics.

AdditionalText

AdditionalText is optional. Multiple instances might exist.

A text field that is used to communicate information not previously defined or for special instructions. To be used only for circumstances not covered by specific elements.

PrintParameters

PrintParameters is optional. The set up parameters of how a print machine or print job is within this construct.

PrintType [attribute]

PrintType is optional. A single instance might exist.

Refer to PrintType definition for any enumerations.

(sequence)

The sequence of items below is mandatory. A single instance is required.

WebConfiguration

WebConfiguration is optional. A single instance might exist.

The way the web runs through the press.

Webbing

Webbing is optional. A single instance might exist.

The webbing that is used in the printing process.

InkDelivery

InkDelivery is optional. A single instance might exist.

The delivery mechanism used in the printing process.

PasteDiameter

PasteDiameter is optional. A single instance might exist.

The diameter measurement of a reel when a new reel of paper is glued or pasted to it to continue running.

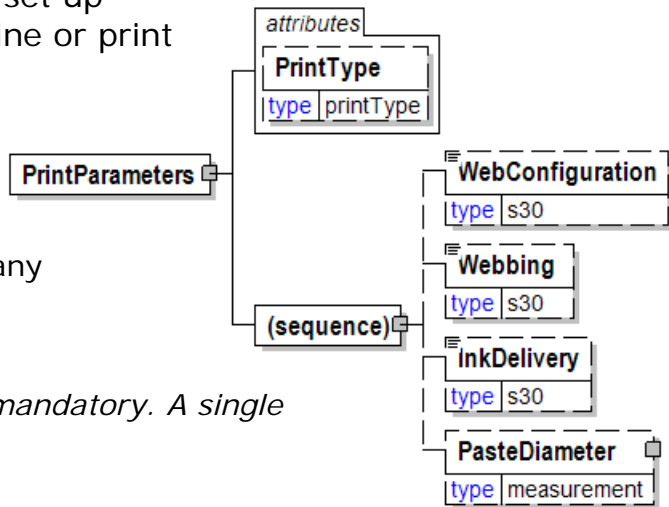

PrintType [attribute]

This item is restricted to the following list.

ColdsetOffset

An offset printing method suitable for newspapers, in other words, ink dries by penetration into the paper.

ContinuousForms

An offset printing method, generally without a hot drying section and suitable for reels.

Digital

An electrostatic printing method, typically a large black-and-white or multicolour printer/copier.

Flexography

A special printing method, which is a follow-up of letter print with advanced print cylinder surface. Suitable for sheets.

FoilPrint

A special printing/finishing method suitable for foils through embossed print plate/cylinder; flat/flat, or circle/flat (form to sheet).

Forms

An offset printing method, generally without a hot drying section and suitable for sheets.

Gravure

A standard printing method with embossed print cylinders. Suitable for sheets.

HeatsetOffset

An offset printing method.

InkJet

An inkjet printing method, typically a large black-and-white or multicolour printer.

InstantOffset

A standard flat printing method (for example, wet offset, or waterless offset) suitable for small print orders and small sheet sizes (for example, max. DIN A3).

Laser

A laser-based printing method, typically a large black-and-white or multicolour printer/copier.

Letterpress

A special printing method suitable for books or newspapers (old style) with advanced letters. Suitable for sheets.

LightPrint

- A printing method similar to a facsimile print, a photo-like print with a specific prepared cylinder surface on photo basis or an artificial print.

MiniWeb

A digital printing method suitable for reels less than 20 inch wide.

RotoFlexography

RotoGravure

RotoLetterpress

RotoSilkScreen

SheetfedOffset

SilkScreen

WebOffset

PrintUnit

PrintUnit identifies the unique qualities associated with the individual unit of the printing press.

PrintUnitType [attribute]

PrintUnitType is optional. A single instance might exist.

Print UnitT ype

Refer to PrintUnitType definition for any enumerations.

(sequence)

The sequence of items below is mandatory. A single instance is required.

PrintUnitNumber

PrintUnitNumber is mandatory. A single instance is required.

The number of the print unit.

Ink

Ink is optional. Multiple instances might exist.

A grouping element that describes the ink used in the process.

Blanket

Blanket is optional. Multiple instances might exist.

Blanket is a group element that contains elements that describe this component of the printing process.

Plate

Plate is optional. Multiple instances might exist.

The image carrying medium.

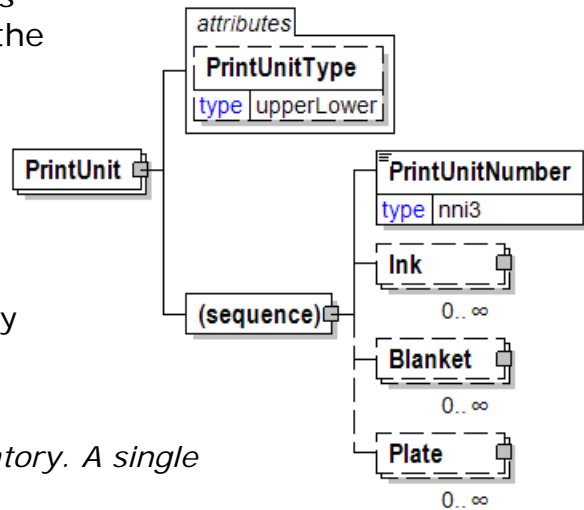

PrintUnitNumber

The number of the print unit.

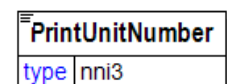

PrintUnitType [attribute]

Print UnitT ype

This item is restricted to the following list.

Upper

Lower

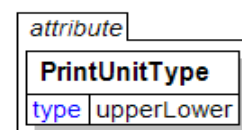

PriorityOrder [attribute]

Specifies the priority order of the item as a two digit positive integer. Value 1 is the highest priority.



ProcessingCode

A code defining processing details for a product.

Agency [attribute]

Agency is mandatory. A single instance is required.

Describes the agency maintaining the list of codes. To be included in this list the agency must be a recognized standards body or industry organisation.

For the element that owns this attribute.

- For another attribute in the list of attributes associated with the parent element.

Refer to Agency definition for any enumerations.

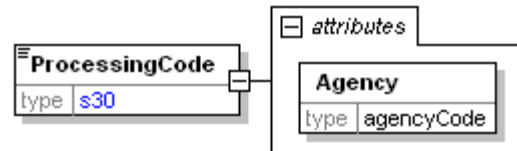

ProcessingCodeSpecification

A grouping element specifying code and description for processing details.

(sequence)

The sequence of items below is mandatory. A single instance is required.

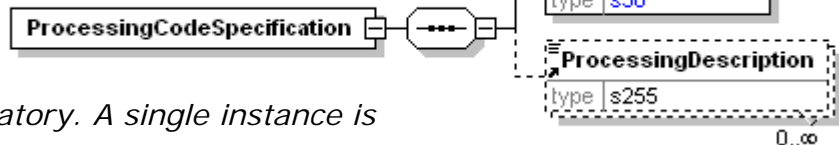

ProcessingCode

ProcessingCode is mandatory. A single instance is required.

A code defining processing details for a product.

ProcessingDescription

ProcessingDescription is optional. Multiple instances might exist.

A text element describing processing details for a product.

ProcessingDescription

A text element describing processing details for a product.

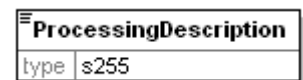

Product

Product is a group item defining the article and its characteristics. Product is used to specify product characteristics organized by ProductIdentifier, ProductDescription, and Classification. Book Manufacturing, Forest Wood, Label Stock, Paper, Pulp, Recovered Paper, Wood Products, and Virgin Fibre market segments have defined their product characteristics and conversion features for implementation in papiNet.

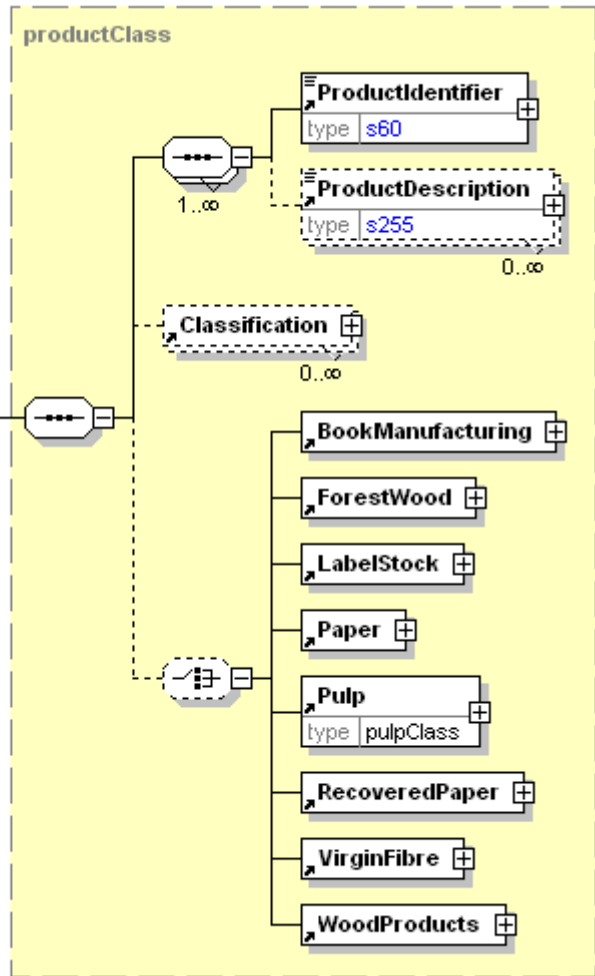
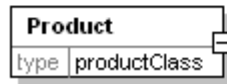

(sequence)

The sequence of items below is mandatory. A single instance is required.

(sequence)

The sequence of items below is mandatory. One instance is required, multiple instances might exist.

ProductIdentifier

ProductIdentifier is mandatory. A single instance is required.

Used to communicate the code of the article, in a variety of formats designated by the type.

ProductDescription

ProductDescription is optional. Multiple instances might exist.

An element used to communicate a human readable description of the product in the language specified by the Language attribute.

Classification

Classification is optional. Multiple instances might exist.

A group item that details the product classification according to a particular organization's scheme. An item across multiple classifications would still be recognized as the same item. Examples of some product classifications are: Containerboard, Pulp-Dissolving, or Newsprint.

(choice)

[choice] is optional because of choice construct.

BookManufacturing

BookManufacturing is optional because of choice construct.

BookManufacturing is a group element that contains the elements that describe the book manufacturing process.

ForestWood

ForestWood is optional because of choice construct.

A grouping element with information about characteristics for Forest Wood products.

LabelStock

LabelStock is optional because of choice construct.

LabelStock contains the attributes and characteristics that define the label stock product.

Paper

Paper is optional because of choice construct.

A group item defining the characteristics of the paper product.

Pulp

Pulp is optional because of choice construct.

A group item defining the characteristics of pulp that are not dependent on a particular conversion process.

RecoveredPaper

RecoveredPaper is optional because of choice construct.

A group item defining the characteristics of recycled fibre that are not dependent on a particular conversion process.

VirginFibre

VirginFibre is optional because of choice construct.

Virgin Fibre

WoodProducts

WoodProducts is optional because of choice construct.

A grouping element for all wood products.

ProductAttributes

The ProductAttributes element is the root element for the ProductAttributes e-Document.

The ProductAttributes e-Document provides the means to communicate information about products between business partners.

ProductAttributesType [attribute]

ProductAttributesType is mandatory. A single instance is required.

The type of information being communicated in the ProductAttributes e-Document

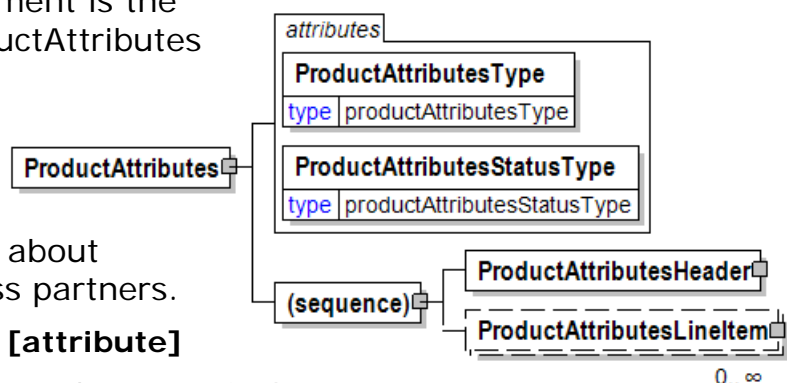

Refer to ProductAttributesType definition for any enumerations.

ProductAttributesStatusType [attribute]

ProductAttributesStatusType is mandatory. A single instance is required.

Defines the status of the entire ProductAttributes e-Document, in other words, at the root level

Refer to ProductAttributesStatusType definition for any enumerations.

(sequence)

The sequence of items below is mandatory. A single instance is required.

ProductAttributesHeader

ProductAttributesHeader is mandatory. A single instance is required.

Information that applies to the entire ProductAttributes e-Document.

ProductAttributesLineItem

ProductAttributesLineItem is optional. Multiple instances might exist.

A group element that contains data relevant to the Product described on the line item.

ProductAttributesHeader

Information that applies to the entire ProductAttributes e-Document.

(sequence)

The sequence of items below is mandatory. A single instance is required.

ProductAttributesIssueDate

ProductAttributesIssueDate is mandatory. A single instance is required.

The Date and Time the ProductAttributes are issued. (Compare to ValidityPeriod.)

TransactionHistoryNumber

TransactionHistoryNumber is optional. A single instance might exist.

A sequential number that keeps track of the version of a document being sent by the



document originator except in the case where TransactionHistoryConfirmation is used, in which case the TransactionHistoryNumber refers to the trigger transaction for which the confirmation is being sent.

SenderProductAttributesIdentifier

SenderProductAttributesIdentifier is mandatory. A single instance is required.

A unique identifier assigned to the combination of products, properties, and ReceivingParty that makes this list of ProductAttributes unique from the SendingParty's point of view. Subsequent ProductAttributes with updates will use this same identifier.

SenderProductAttributesName

SenderProductAttributesName is optional. A single instance might exist.

The name given to the set of products sent in the ProductAttributes e-Document.

SenderProductAttributesDescription

SenderProductAttributesDescription is optional. Multiple instances might exist.

An element containing free text used to describe the set of products sent in the ProductAttributes.

OtherParty

OtherParty is optional. Multiple instances might exist.

An organisation or business entity other than those specifically detailed within a e-Document.

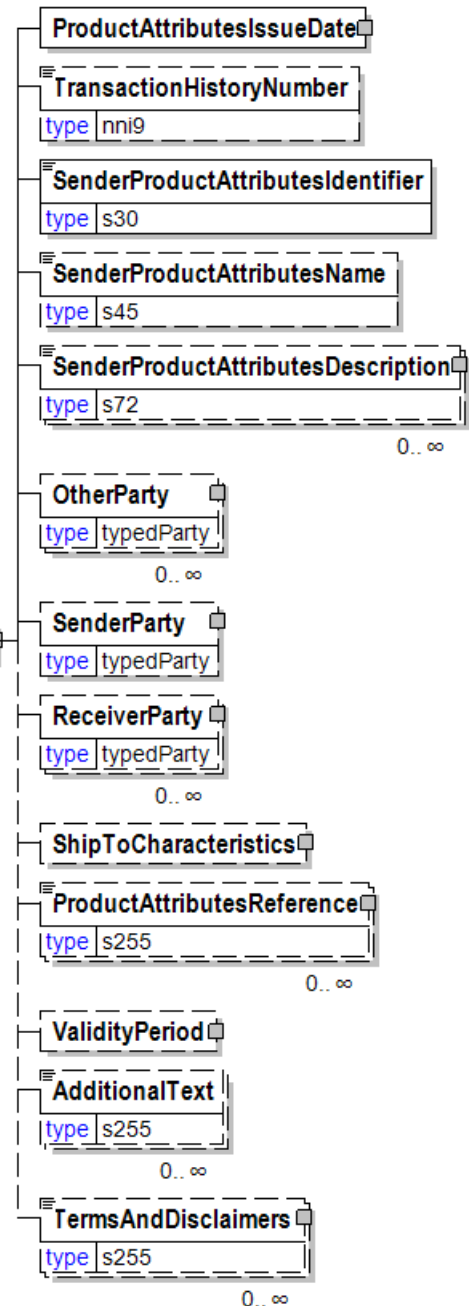

SenderParty

SenderParty is optional. A single instance might exist.

The business entity issuing the e-Document, the source of the document.

The entity responsible for the content. If the sender party has out sourced the message service to a third party the SenderParty is the issuer of the e-Document and not the party performing the transmission service of the electronic message.

ReceiverParty

ReceiverParty is optional. Multiple instances might exist.

The business entity for whom the e-Document is intended, the destination of the document.

The entity interested in the content. If the receiver party has outsourced the message service to a third party the ReceiverParty is the intended party for the e-Document and not the party performing the receiving service of the electronic message.

ShipToCharacteristics

ShipToCharacteristics is optional. A single instance might exist.

A group item that provides information important for the Ship-To Party.

A group item that provides information important for the Ship-To Party. ShipToCharacteristics may be referenced at both the header and line item level. The reference at the header is required and acts as a default for the value at the line level, unless overridden at the line level.

ProductAttributesReference

ProductAttributesReference is optional. Multiple instances might exist.

References that apply to the ProductAttributes e-Document, contains the ProductAttributesReferenceType attribute.

ValidityPeriod

ValidityPeriod is optional. A single instance might exist.

The validity period for a specific item, e.g. the validity period for an e-Document.

AdditionalText

AdditionalText is optional. Multiple instances might exist.

A text field that is used to communicate information not previously defined or for special instructions. To be used only for circumstances not covered by specific elements.

TermsAndDisclaimers

TermsAndDisclaimers is optional. Multiple instances might exist.

An element that contains legal information with an indication of what the Language is.

ProductAttributesIssueDate

The Date and Time the ProductAttributes are issued.
(Compare to ValidityPeriod.)

(sequence)

The sequence of items below is mandatory. A single instance is required.

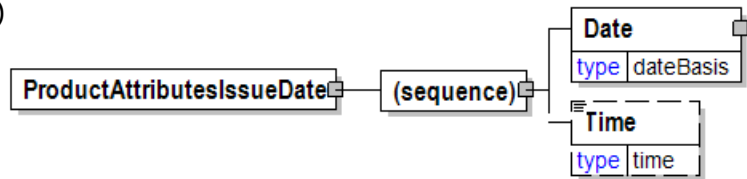

Date

Date is mandatory. A single instance is required.

A group element that contains the specification of Year, Month, and Day.

Time

Time is optional. A single instance might exist.

Times are treated in a standard XML fashion with a special case used to indicate a generalized "local" time. The standard XML approach to time is hh:mm:ss, hh:mm:ssZ, or hh:mm:ss±hh:mm.

hh:mm:ss±hh:mm is used to represent a time with a time zone. The time zone is communicated as the number of hours offset from the Universal Time Coordinate (UTC), a.k.a. Greenwich Mean Time.

hh:mm:ssZ indicates the time at Zulu (another name for UTC). Based on the convention described in the next bullet it will be important for users within UTC to use "Z" when communicating a time in their time zone to other users.

hh:mm:ss or hh:mm indicates in the XML standard the time at UTC however, within papiNet it is used to represent the applicable local time. Caution should be used when processing times of this nature as the papiNet approach may be in discord with other users of XML.

ProductAttributesLineItem

A group element that contains data relevant to the Product described on the line item.

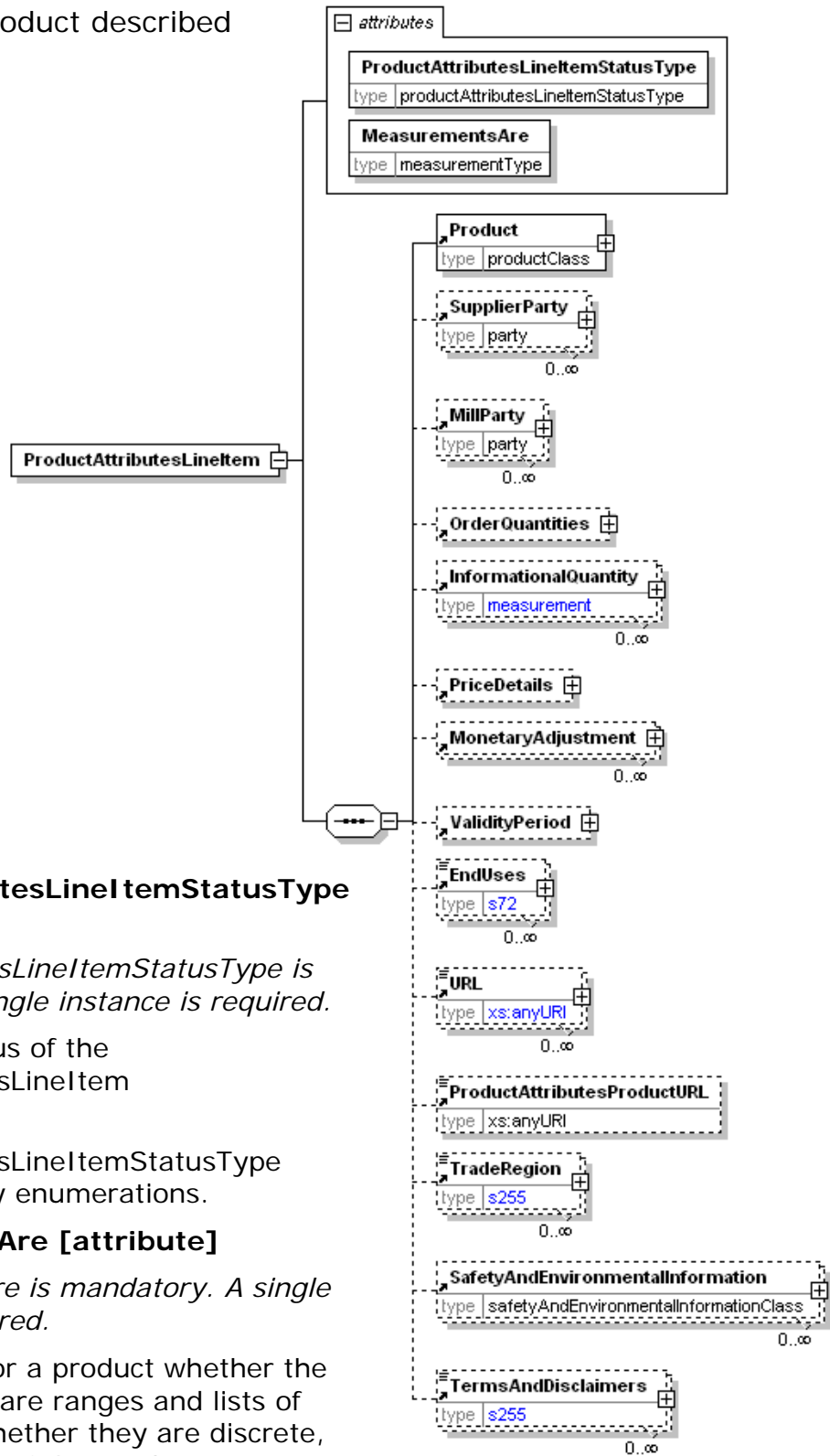

ProductAttributesLineItemStatusType [attribute]

ProductAttributesLineItemStatusType is mandatory. A single instance is required.

Defines the status of the ProductAttributesLineItem

Refer to ProductAttributesLineItemStatusType definition for any enumerations.

MeasurementsAre [attribute]

MeasurementsAre is mandatory. A single instance is required.

Used to define for a product whether the details provided are ranges and lists of properties, or whether they are discrete, single properties of the product.

Refer to MeasurementsAre definition for any enumerations.

(sequence)

The sequence of items below is mandatory. A single instance is required.

Product

Product is mandatory. A single instance is required.

Product is a group item defining the article and its characteristics. Product is used to specify product characteristics organized by ProductIdentifier, ProductDescription, and Classification. Book Manufacturing, Label Stock, Paper, Pulp, Recovered Paper, Wood Products, and Virgin Fibre market segments have defined their product characteristics and conversion features for implementation in papiNet.

SupplierParty

SupplierParty is optional. Multiple instances might exist.

The organisation or business entity responsible for providing the product. SupplierParty is also the seller of the product, if Seller is not specified as OtherParty = Seller.

MillParty

MillParty is optional. Multiple instances might exist.

The organisation or business entity that actually produces the product.

OrderQuantities

OrderQuantities is optional. A single instance might exist.

An element that contains the quantities that can be used for ordering.

InformationalQuantity

InformationalQuantity is optional. Multiple instances might exist.

A quantity given in a valid UOM used for information purposes only (not for calculation). For example, an ordered quantity was 100 reels as opposed to the invoice quantity of 20,000 pounds.

PriceDetails

PriceDetails is optional. A single instance might exist.

An element that groups together price information.

MonetaryAdjustment

MonetaryAdjustment is optional. Multiple instances might exist.

The element containing the information necessary for the understanding, calculation, and treatment of an adjustment to a currency amount. MonetaryAdjustment contains an attribute that indicates the type of adjustment being communicated.

ValidityPeriod

ValidityPeriod is optional. A single instance might exist.

The validity period for a specific item, e.g. the validity period for an e-Document.

EndUses

EndUses is optional. Multiple instances might exist.

A text element used to express in human readable form a list of applicable end uses for a product. Examples of end uses are:

- Magazine
- Book
- Commercial print

etc

URL

URL is optional. Multiple instances might exist.

Universal Resource Locator. While typically a web address you could use this field to hold an email address.

ProductAttributesProductURL

ProductAttributesProductURL is optional. A single instance might exist.

The web address of information pertinent to a particular product.

TradeRegion

TradeRegion is optional. Multiple instances might exist.

A geographic area for product availability communication.

SafetyAndEnvironmentalInformation

SafetyAndEnvironmentalInformation is optional. Multiple instances might exist.

Name of certification type, if any, on the goods (For example, FSC, PEFC). SafetyAndEnvironmental needs a value or measurement to communicate the percentage of the product is certified (for example, 75% is certified by the indicated agency).

TermsAndDisclaimers

TermsAndDisclaimers is optional. Multiple instances might exist.

An element that contains legal information with an indication of what the Language is.

ProductAttributesLineItemStatusType [attribute]

Defines the status of the ProductAttributesLineItem

ProductAttributesLineItemStatusType
type productAttributesLineItemStatusType

This item is restricted to the following list.

Amended

The supplied information is changed.

Cancelled

The supplied information has been cancelled. Items that have been cancelled are not included in totals on the summary levels of the e-Document.

Original

The supplied information is the first version of that information.

ProductAttributesProductURL

The web address of information pertinent to a particular product.

ProductAttributesProductURL
type anyURI

ProductAttributesReference

References that apply to the ProductAttributes e-Document, contains the

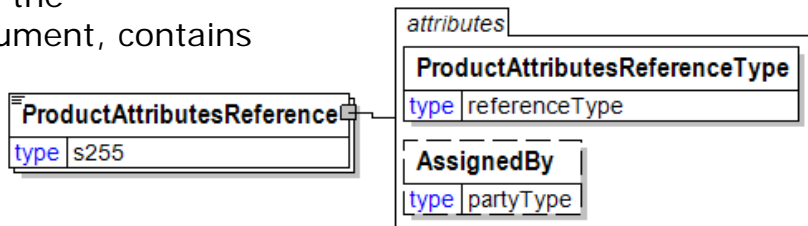

ProductAttributesReferenceType attribute.

ProductAttributesReferenceType [attribute]

ProductAttributesReferenceType is mandatory. A single instance is required.

Provides a contextual explanation of the specific reference identifier. Many items are currently prefixed by "Buyer", "Forwarder", "Manufacturer", "Mill", "Seller", "Supplier", "Warehouse", or "Vendor". Check for an existing non-prefixed version and use the non-prefixed version instead. In the (yet to be announced release date) version 3.0 the prefixed versions will be removed. Instead the attribute `@AssignedBy` will communicate the information previously communicated in the prefix.

Refer to ProductAttributesReferenceType definition for any enumerations.

AssignedBy [attribute]

AssignedBy is optional. A single instance might exist.

Identifies the type of party that has assigned the associated item, e.g. a reference of type `OrderNumber`.

Refer to AssignedBy for any enumerations.

ProductAttributesReferenceType [attribute]

Provides a contextual explanation of the specific reference identifier. Many items are currently prefixed by "Buyer", "Forwarder", "Manufacturer", "Mill", "Seller", "Supplier", "Warehouse", or "Vendor". Check for an

existing non-prefixed version and use the non-prefixed version instead. In the (yet to be announced release date) version 3.0 the prefixed versions will be removed. Instead the attribute `@AssignedBy` will communicate the information previously communicated in the prefix.

Refer to the [referenceType](#) entry for the list of enumerations and their definitions.

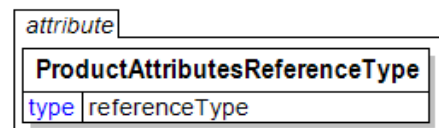

ProductAttributesStatusType [attribute]

Defines the status of the entire ProductAttributes e-Document, in other words, at the root level



This item is restricted to the following list.

Amended

The supplied information is changed.

Cancelled

The supplied information has been cancelled. Items that have been cancelled are not included in totals on the summary levels of the e-Document.

Original

The supplied information is the first version of that information.

Replaced

The supplied information is replacing earlier supplied information. The receiver should revalidate the information in their system based upon the entire information received.

ProductAttributesType [attribute]

The type of information being communicated in the ProductAttributes e-Document



This item is restricted to the following list.

PriceList

The information represents a price list.

ProductCrossReference

The information contains product cross reference information

ProductProperties

The information is a representation of the properties of the products.

ProductBasisSizeType [attribute]

An attribute list that indicates the size of paper used as the base for the basis weight calculation

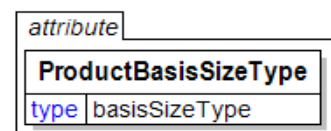

This item is restricted to the following list.

GramsPerSquareMeter

The basis size type is in metric measurement of grams per square meter.

16x18

The surface area of a ream (500 sheets) is 16x18 in inches.

17x22

The surface area of a ream (500 sheets) is 17x22 in inches. This size is also

papiNet V2R31

known as Bond.

20x26

The surface area of a ream (500 sheets) is 20x26 in inches. This size is also known as Cover.

20x30

The surface area of a ream (500 sheets) is 20x30 in inches.

22.5x22.5

The surface area of a ream (500 sheets) is 22.5x22.5 in inches.

22.5x28.5

The surface area of a ream (500 sheets) is 22.5x28.5 in inches.

24x26

The surface area of a ream (500 sheets) is 24x26 in inches.

24x36

The surface area of a ream (500 sheets) is 24x36 in inches. This size is also known as Newsprint.

25x38

The surface area of a ream (500 sheets) is 25x38 in inches. This size is also known as Book.

25x40

The surface area of a ream (500 sheets) is 25x40 in inches.

25.5x28.5

The surface area of a ream (500 sheets) is 25.5x28.5 in inches.

25.5x30.5

The surface area of a ream (500 sheets) is 25.5x30.5 in inches.

35.5x30.5

The surface area of a ream (500 sheets) is 35.5x30.5 in inches.

1000SqFt

The surface area of one sheet is 1000 square feet.

ProductDescription

An element used to communicate a human readable description of the product in the language specified by the Language attribute.

Language [attribute]

Language is optional. A single instance might exist.

XML has embraced 2 and 3 digit language codes through the application of an addendum to the standard.

Refer to Language definition for any enumerations.

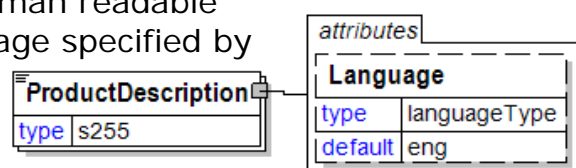

ProductGroupID

Possibility to group packages or Shipments.

Example: Creating temporary group ID's for logistic reasons or lot number.

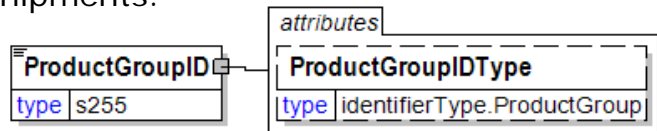

ProductGroupIDType [attribute]

ProductGroupIDType is optional. A single instance might exist.

Product Group ID Type

Refer to ProductGroupIDType definition for any enumerations.

ProductGroupIDType [attribute]

Product Group ID Type

This item is restricted to the following list.

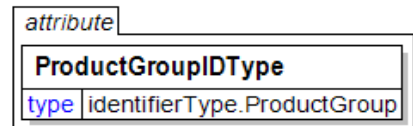

BillOfLadingMark

Assigning party's reference mark on each package used for logistic purposes (a mark which is painted to packages just to make handling easier). Not to be confused with Bill of Lading Number.

LotIdentifier

A unique code used to identify a grouping of product with one set of quality statistics common to all members of that group. Synonym: Lot Number

ProductIdentifier

Product Identifier.

ProductGroupSummary

Group of elements to provide summary information on product level.

(sequence)

The sequence of items below is mandatory. A single instance is required.

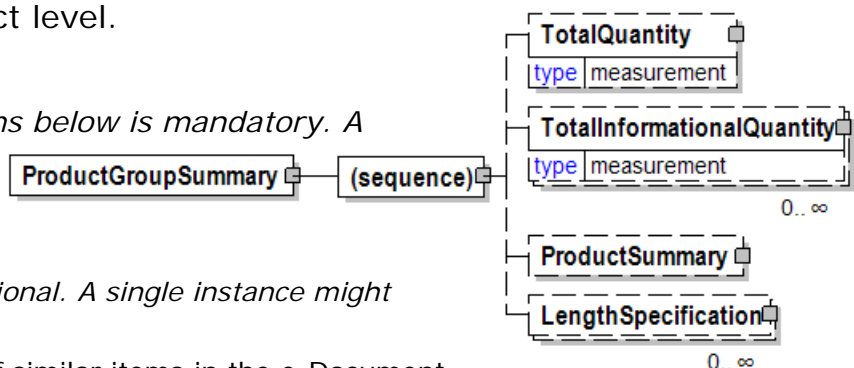

TotalQuantity

TotalQuantity is optional. A single instance might exist.

The total quantity of similar items in the e-Document.

TotalQuantity is primarily used in the summary section of documents where it is repeatable to permit totaling for different units of measure.

TotalInformationalQuantity

TotalInformationalQuantity is optional. Multiple instances might exist.

A quantity that is used to communicate related information about the parent

element. This element represents a total that is derived from individual line items.

ProductSummary

ProductSummary is optional. A single instance might exist.

Group of elements to provide summary information on product level.

LengthSpecification

LengthSpecification is optional. Multiple instances might exist.

Length specification of the wood product.

ProductIdentification

A grouping element designed to communicate product identification related to the parent element that contains this item.

(sequence)

The sequence of items

below is mandatory. A single instance is required.

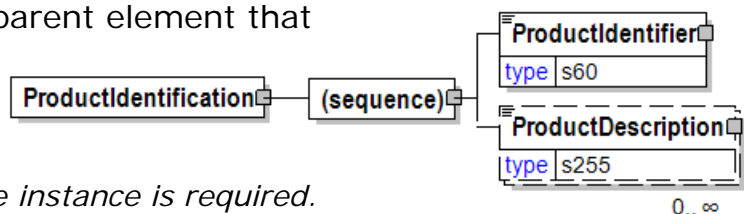

ProductIdentifier

ProductIdentifier is mandatory. A single instance is required.

Used to communicate the code of the article, in a variety of formats designated by the type.

ProductDescription

ProductDescription is optional. Multiple instances might exist.

An element used to communicate a human readable description of the product in the language specified by the Language attribute.

ProductIdentifier

Used to communicate the code of the article, in a variety of formats designated by the type.

Agency [attribute]

Agency is mandatory. A single instance is required.

Describes the agency maintaining the list of codes. To be included in this list the agency must be a recognized standards body or industry organisation.

For the element that owns this attribute.

For another attribute in the list of attributes associated with the parent element.

Refer to Agency definition for any enumerations.

ProductIdentifierType [attribute]

ProductIdentifierType is mandatory. A single instance is required.

Provides a contextual definition to the product identifier value.

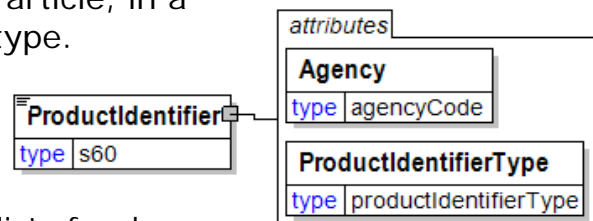

Refer to ProductIdentifierType definition for any enumerations.

ProductIdentifierType [attribute]

Provides a contextual definition to the product identifier value.

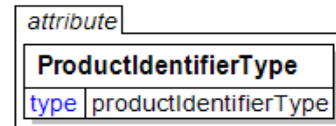

This item is restricted to the following list.

BrandName

A specific product brand name for which the owner or source is specified in the "@AssignedBy" attribute.

CatalogueNumber

A unique reference for a product in a catalogue.

CustomsTariffNumber

EAN8

An 8-digit code that uniquely identifies an article. This is the European article-numbering scheme.

EAN13

A 13-digit code that uniquely identifies an article. This is the European article-numbering scheme.

ExportHarmonisedSystemCode

The Harmonised System Code is an international goods classification system developed by the Customs Co-operation Council.

USA: It is a 10-digit number, the first 6 of which compose the harmonised code. The remaining 4 digits represent statistical subdivisions. The schedule is a statistical classification of domestic and foreign commodities exported from the United States.

Canada: Canadians have adopted the scheme as a basis for a new Canadian Tariff and Statistical Classification System. The Canadian export number consists of 8 digits prefixed by "HS" and is shown in the format HS5911.31.10, for example.

FinishedGoodIdentifier

Product Identifier assigned by an Agency, e.g. a Publisher, to identify the finished product.

GradeCode

A specific product code for which the owner or source is specified in the "@AssignedBy" attribute.

GradeName

A specific product name for which the owner or source is specified in the "@AssignedBy" attribute (for example, ImprovedNewsprint-45-1479).

ImportHarmonisedSystemCode

The Harmonised System Code is an international goods classification system developed by the Customs Co-operation Council.

papiNet V2R31

USA: It is a 10-digit number, the first 6 of which compose the harmonised code. The remaining 4 digits represent statistical subdivisions. The schedule is a statistical classification of domestic and foreign commodities exported from the United States.

Canada: Canadians have adopted the scheme as a basis for a new Canadian Tariff and Statistical Classification System. The Canadian export number consists of 8 digits prefixed by "HS" and is shown in the format HS5911.31.10, for example.

ManufacturingGradeCode

A specific grade code to the actual manufactured product which may be different to the grade code under which the product is sold.. These codes generally refer to a product manufactured on a pulp or paper machine.

ManufacturingGradeName

A specific grade name assigned to the actual manufactured product which may be different to the grade name under which the product is sold. These codes generally refer to a product manufactured on a pulp or paper machine.

Ondule

A product code issued by the Groupement Ondulé, which is the European Association of Corrugated Base Papers Manufacturers.

PartNumber

An equivalent to the Stock Keeping Unit (SKU) for which the owner or source is specified in the "@AssignedBy" attribute. In other words, this code fully defines the product.

RFQPartNumber

The part number communicated as part of the RFQ process. This may be a form of the RFQ number itself. This field is designed to handle the situation where there is no part number assigned to the particular blend of product characteristics.

SKU

The Stock Keeping Unit that is assigned by the buyer or supplier and that includes all relevant information to make an individual item ready for shipping.

UPC

The Universal Product Code administered by the Universal Code Council. Note: There are several formats used for this coding scheme.

Other

Used for any other product identifier type that is not covered by the list.

ProductionLastDateOfChange

The final Date and Time that a line item or delivery line may be amended or cancelled by the buyer.

(sequence)

The sequence of items below is mandatory. A single instance is required.

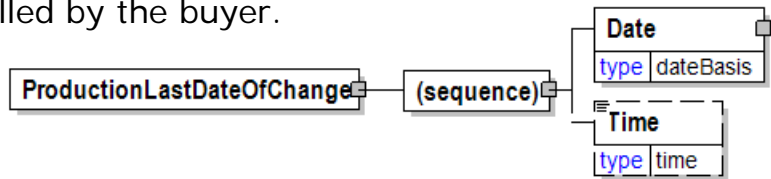

Date

Date is mandatory. A single instance is required.

A group element that contains the specification of Year, Month, and Day.

Time

Time is optional. A single instance might exist.

Times are treated in a standard XML fashion with a special case used to indicate a generalized "local" time. The standard XML approach to time is hh:mm:ss, hh:mm:ssZ, or hh:mm:ss±hh:mm.

hh:mm:ss±hh:mm is used to represent a time with a time zone. The time zone is communicated as the number of hours offset from the Universal Time Coordinate (UTC), a.k.a. Greenwich Mean Time.

hh:mm:ssZ indicates the time at Zulu (another name for UTC). Based on the convention described in the next bullet it will be important for users within UTC to use "Z" when communicating a time in their time zone to other users.

hh:mm:ss or hh:mm indicates in the XML standard the time at UTC however, within papiNet it is used to represent the applicable local time. Caution should be used when processing times of this nature as the papiNet approach may be in discord with other users of XML.

ProductionRunNumber

The ProductionRunNumber assigned by the issuer.

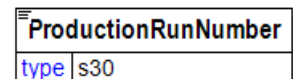

ProductionStatus

A group item used to communicate the release of a delivery line number.

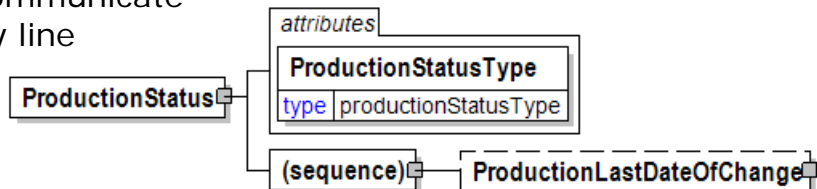

ProductionStatusType [attribute]

ProductionStatusType is mandatory. A single instance is required.

Indicates whether the ordered quantities to which it refers are allowed to be produced.

When goods are free for delivery but the buyer wants to specify a more detailed DeliverySchedule, a CallOff is used.

PurchaseOrder - Typically, a buyer sets ProductionStatusType for an order to "Free", which means the seller can produce the product(s) on the order. A PurchaseOrder of type ReservationOrder is an exception because the buyer is booking capacity at the mill but not making a commitment to buy; for this type of order, the status is "NotFree". The buyer uses one or more ReleaseOrder(s) referring to the ReservationOrder to change the ProductionStatusType to "Free" for one or more products on the ReservationOrder.

The level of specification in the DeliverySchedule element is used will indicate whether the PurchaseOrder is "Free" for delivery.

Refer to ProductionStatusType definition for any enumerations.

(sequence)

The sequence of items below is mandatory. A single instance is required.

ProductionLastDateOfChange

ProductionLastDateOfChange is optional. A single instance might exist.

The final Date and Time that a line item or delivery line may be amended or cancelled by the buyer.

ProductionStatusType [attribute]

Indicates whether the ordered quantities to which it refers are allowed to be produced.

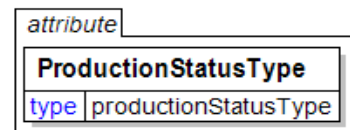

When goods are free for delivery but the buyer wants to specify a more detailed DeliverySchedule, a CallOff is used.

PurchaseOrder - Typically, a buyer sets ProductionStatusType for an order to "Free", which means the seller can produce the product(s) on the order. A PurchaseOrder of type ReservationOrder is an exception because the buyer is booking capacity at the mill but not making a commitment to buy; for this type of order, the status is "NotFree". The buyer uses one or more ReleaseOrder(s) referring to the ReservationOrder to change the ProductionStatusType to "Free" for one or more products on the ReservationOrder.

The level of specification in the DeliverySchedule element is used will indicate whether the PurchaseOrder is "Free" for delivery.

This item is restricted to the following list.

Free

The ordered quantities to which it refers can be produced, in other words, are free to make.

NotFree

The ordered quantities to which it refers cannot be produced, in other words, are not free to make

ProductPackaging

Defines the methods and materials used for packaging.

(sequence)

The sequence of items below is mandatory. A single instance is required.

QuantityInUnit

QuantityInUnit is optional. A single instance might exist.

Used to identify the number of items packed within this package unit.

UnitDimension

UnitDimension is optional. A single instance might exist.

Unit
Dimension

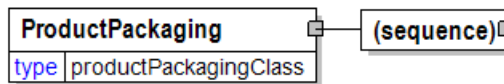

Weight

Weight is optional. A single instance might exist.

The weight of the item.

PackageIDInformation

PackageIDInformation is optional. A single instance might exist.

Group element identifying a lumber (wood) package. The package name may also be communicated.

LabelCharacteristics

LabelCharacteristics is optional. Multiple instances might exist.

A group item that organises the labeling information.

StencilCharacteristics

StencilCharacteristics is optional. Multiple instances might exist.

A group element specifying attributes of a stencil to be applied to an item, and optional text.

BandCharacteristics

BandCharacteristics is optional. Multiple instances might exist.

A group item that organises the packaging band detail information.

PalletCharacteristics

PalletCharacteristics is optional. Multiple instances might exist.

A group item that provides pallet detail information.

Wrap

Wrap is optional. Multiple instances might exist.

A group item that organises wrapping detail information.

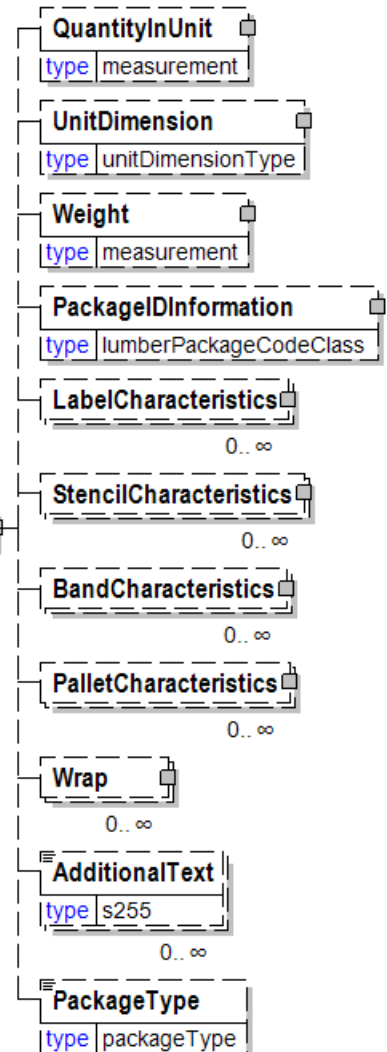

AdditionalText

AdditionalText is optional. Multiple instances might exist.

A text field that is used to communicate information not previously defined or for special instructions. To be used only for circumstances not covered by specific elements.

PackageType

PackageType is optional. A single instance might exist.

Communicates the configuration of the item being reported.

Refer to PackageType definition for any enumerations.

ProductPercentage

The quantity of a product in percentage of the total quantity for an item containing many products.

(sequence)

The sequence of items below is mandatory. A single instance is required.

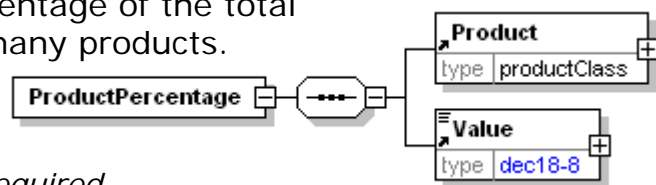

Product

Product is mandatory. A single instance is required.

Product is a group item defining the article and its characteristics. Product is used to specify product characteristics organized by ProductIdentifier, ProductDescription, and Classification. Book Manufacturing, Label Stock, Paper, Pulp, Recovered Paper, Wood Products, and Virgin Fibre market segments have defined their product characteristics and conversion features for implementation in papiNet.

Value

Value is mandatory. A single instance is required.

A numeric value expressed in the unit of measure (UOM).

ProductPerformance

The ProductPerformance element is the root element for the ProductPerformance e-Document.

The ProductPerformance e-Document is created by the product consumer

in order to communicate back to the manufacturer the performance of the product. This e-Document will enable the manufacturer to focus on improvements related to product defects that create inefficiency during performance. The aggregation of performance

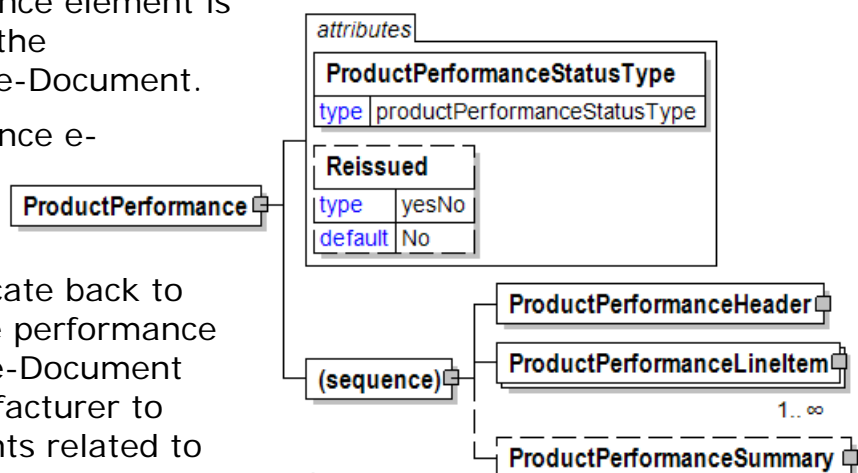

factors by product will provide the mechanism for achieving the value aspect of the e-Document. The goal is to keep the products of the Pulp & Paper Industry attractive versus competing alternatives.

ProductPerformanceStatusType [attribute]

ProductPerformanceStatusType is mandatory. A single instance is required.

ProductPerformanceStatusType

Refer to ProductPerformanceStatusType definition for any enumerations.

Reissued [attribute]

Reissued is optional. A single instance might exist.

Either "Yes" or "No".

Refer to Reissued definition for any enumerations.

(sequence)

The sequence of items below is mandatory. A single instance is required.

ProductPerformanceHeader

ProductPerformanceHeader is mandatory. A single instance is required.

Information that applies to the entire ProductPerformance e-Document.

ProductPerformanceLineItem

ProductPerformanceLineItem is mandatory. One instance is required, multiple instances might exist.

Information for each item in the ProductPerformance e-Document.

ProductPerformanceSummary

ProductPerformanceSummary is optional. A single instance might exist.

Summary information for the items on the ProductPerformance e-Document

ProductPerformanceConcerns

A grouping element used to hold information about the product performance concerns.

ConcernIndicatorType [attribute]

ConcernIndicatorType is mandatory. A single instance is required.

Either "Yes" or "No".

Refer to ConcernIndicatorType definition for any enumerations.

(choice)

[choice] is optional because of choice construct.

WebConcerns

WebConcerns is optional because of choice construct.

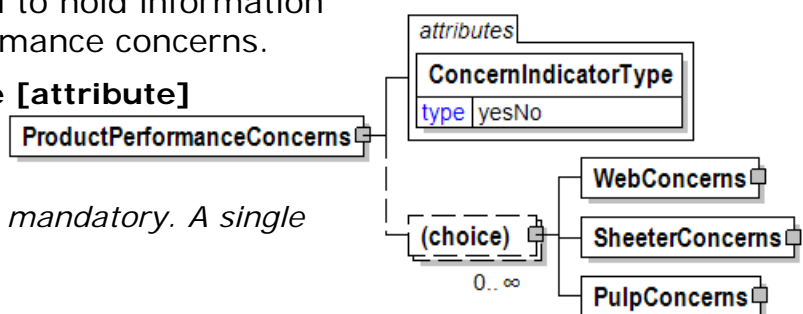

A grouping element that contains the information about a web break.

SheeterConcerns

SheeterConcerns is optional because of choice construct.

SheeterConcerns is a group element that provides information about an event on a sheeter.

PulpConcerns

PulpConcerns is optional because of choice construct.

If the ConcernIndicatorType is "Y" for a pulp related product then a defect cause must be give.

ProductPerformanceConditions

The ProductPerformanceConditions, while not absolutely necessary to determine whether there is a product concern is available.

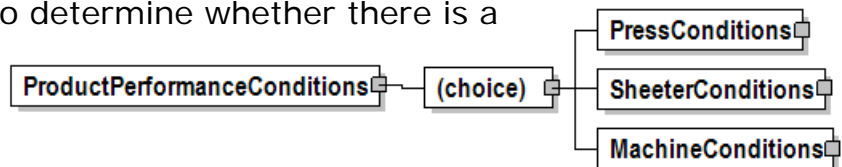

(choice)

[choice] is optional because of choice construct.

PressConditions

PressConditions is optional because of choice construct.

Construct contains environmental conditions of the press during operations

SheeterConditions

SheeterConditions is optional because of choice construct.

Identifies the environmental conditions when the sheet was printed on.

MachineConditions

MachineConditions is optional because of choice construct.

A grouping element for all the environmental measurement at the time of the run.

ProductPerformanceDate

The date the e-Document was issued.

(sequence)

The sequence of items

below is mandatory. A single instance is required.

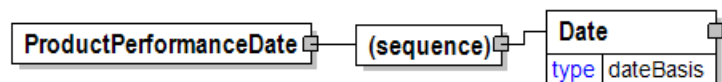

Date

Date is mandatory. A single instance is required.

A group element that contains the specification of Year, Month, and Day.

ProductPerformanceHeader

Information that applies to the entire ProductPerformance e-Document.

(sequence)

The sequence of items below is mandatory. A single instance is required.

ProductPerformanceNumber

ProductPerformanceNumber is mandatory. A single instance is required.

The report number used to identify the entire ProductPerformance.

ProductPerformanceIssueDate

ProductPerformanceIssueDate is mandatory. A single instance is required.

The date and time the ProductPerformance was issued.

ProductPerformanceReference

ProductPerformanceReference is optional. Multiple instances might exist.

Reference back to another e-Document.

EndUserParty

EndUserParty is mandatory. A single instance is required.

The party using, consuming, or converting the product. For example, a printer using paper reels for a print job for a publisher. The final ShipTo destination for a product is normally to the end user's facilities.

SupplierParty

SupplierParty is mandatory. A single instance is required.

The organisation or business entity responsible for providing the product. SupplierParty is also the seller of the product, if Seller is not specified as OtherParty = Seller.

MillParty

MillParty is optional. A single instance might exist.

The organisation or business entity that actually produces the product.

SenderParty

SenderParty is optional. A single instance might exist.

The business entity issuing the e-Document, the source of the document.

The entity responsible for the content. If the sender party has out sourced the message service to a third party the SenderParty is the issuer of the e-Document and not the party performing the transmission service of the electronic message.

ReceiverParty

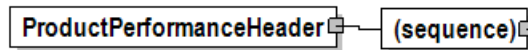
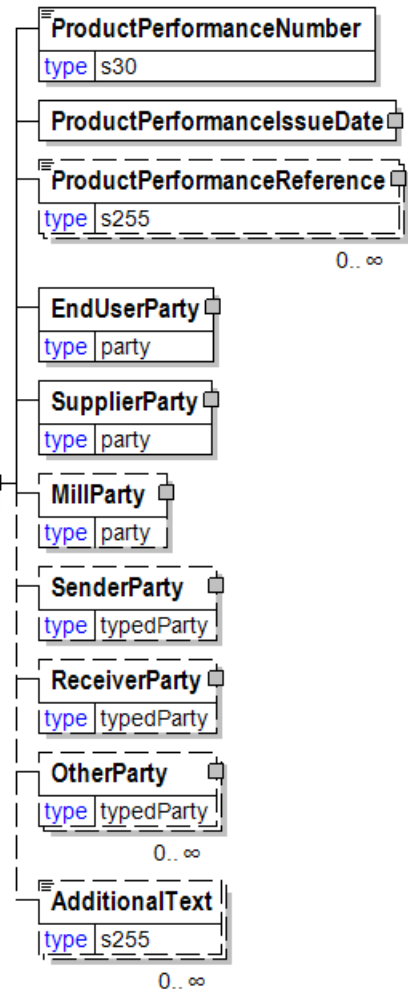

papiNet V2R31

ReceiverParty is optional. A single instance might exist.

The business entity for whom the e-Document is intended, the destination of the document.

The entity interested in the content. If the receiver party has outsourced the message service to a third party the ReceiverParty is the intended party for the e-Document and not the party performing the receiving service of the electronic message.

OtherParty

OtherParty is optional. Multiple instances might exist.

An organisation or business entity other than those specifically detailed within a e-Document.

AdditionalText

AdditionalText is optional. Multiple instances might exist.

A text field that is used to communicate information not previously defined or for special instructions. To be used only for circumstances not covered by specific elements.

ProductPerformanceIssueDate

The date and time the ProductPerformance was issued.

(sequence)

The sequence of items below is mandatory. A single instance is required.

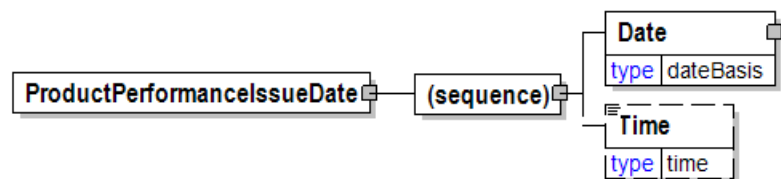

Date

Date is mandatory. A single instance is required.

A group element that contains the specification of Year, Month, and Day.

Time

Time is optional. A single instance might exist.

Times are treated in a standard XML fashion with a special case used to indicate a generalized "local" time. The standard XML approach to time is hh:mm:ss, hh:mm:ssZ, or hh:mm:ss±hh:mm.

hh:mm:ss±hh:mm is used to represent a time with a time zone. The time zone is communicated as the number of hours offset from the Universal Time Coordinate (UTC), a.k.a. Greenwich Mean Time.

hh:mm:ssZ indicates the time at Zulu (another name for UTC). Based on the convention described in the next bullet it will be important for users within UTC to use "Z" when communicating a time in their time zone to other users.

hh:mm:ss or hh:mm indicates in the XML standard the time at UTC however, within papiNet it is used to represent the applicable local time. Caution should be used when processing times of this nature as the papiNet approach may be in discord with other users of XML.

ProductPerformanceLineItem

Information for each item in the ProductPerformance e-Document.

ItemType [attribute]

ItemType is mandatory. A single instance is required.

Indicates the form of the item being



reported as being used. Many of the ItemType(s) indicated here have a corresponding named element equivalent, which is referenced here for definition purposes.

Refer to ItemType definition for any enumerations.

(sequence)

The sequence of items below is mandatory. A single instance is required.

ProductPerformanceLineItemNumber

ProductPerformanceLineItemNumber is mandatory. A single instance is required.

The line item identifying the one line being communicated from the Printer to Supplier.

ProductPerformanceReference

ProductPerformanceReference is optional. Multiple instances might exist.

Reference back to another e-Document.

Identifier

Identifier is mandatory. One instance is required, multiple instances might exist.

An Identifier is required for packages and items (pallets, reel packages, boxes, ream items, reel items, etc). The Identifier element contains the actual item identifier code. Identifier is repeatable so more than one identifier can be communicated. For example, the printed identifier on a label may be different from the barcode printed on the label.

LocationParty

LocationParty is optional. A single instance might exist.

The organization or business entity where the business event took place or will take place.

PrintParameters

PrintParameters is optional. A single instance might exist.

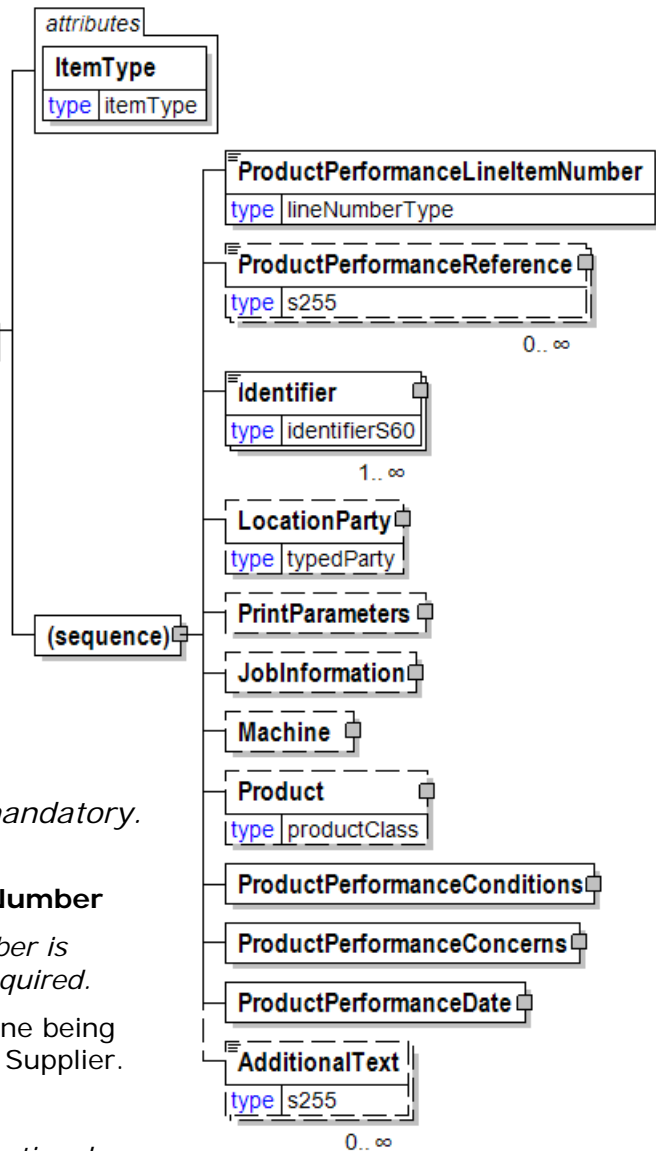

papiNet V2R31

PrintParameters is optional. The set up parameters of how a print machine or print job is within this construct.

JobInformation

JobInformation is optional. A single instance might exist.

JobInformation is optional. This construct captures information specific to the entire job set up.

Machine

Machine is optional. A single instance might exist.

Machine is used to capture information specific to the particular machine used in the conversion or consumption process.

Product

Product is optional. A single instance might exist.

Product is a group item defining the article and its characteristics. Product is used to specify product characteristics organized by ProductIdentifier, ProductDescription, and Classification. Book Manufacturing, Label Stock, Paper, Pulp, Recovered Paper, Wood Products, and Virgin Fibre market segments have defined their product characteristics and conversion features for implementation in papiNet.

ProductPerformanceConditions

ProductPerformanceConditions is mandatory. A single instance is required.

The ProductPerformanceConditions, while not absolutely necessary to determine whether there is a product concern is available.

ProductPerformanceConcerns

ProductPerformanceConcerns is mandatory. A single instance is required.

A grouping element used to hold information about the product performance concerns.

ProductPerformanceDate

ProductPerformanceDate is mandatory. A single instance is required.

The date the e-Document was issued.

AdditionalText

AdditionalText is optional. Multiple instances might exist.

A text field that is used to communicate information not previously defined or for special instructions. To be used only for circumstances not covered by specific elements.

ProductPerformanceLineItemNumber

The line item identifying the one line being communicated from the Printer to Supplier.

ProductPerformanceLineItemNumber
type lineNumberType

ProductPerformanceNumber

The report number used to identify the entire ProductPerformance.

ProductPerformanceNumber	
type	s30

ProductPerformanceReference

Reference back to another e-Document.

ProductPerformanceReferenceType [attribute]

ProductPerformanceReference	
type	s255

attributes	
ProductPerformanceReferenceType	
type	referenceType
AssignedBy	
type	partyType

ProductPerformanceReferenceType is mandatory. A single instance is required.

Provides a contextual explanation of the specific reference identifier. Many items are currently prefixed by "Buyer", "Forwarder", "Manufacturer", "Mill", "Seller", "Supplier", "Warehouse", or "Vendor". Check for an existing non-prefixed version and use the non-prefixed version instead. In the (yet to be announced release date) version 3.0 the prefixed versions will be removed. Instead the attribute @AssignedBy will communicate the information previously communicated in the prefix.

Refer to ProductPerformanceReferenceType definition for any enumerations.

AssignedBy [attribute]

AssignedBy is optional. A single instance might exist.

Identifies the type of party that has assigned the associated item, e.g. a reference of type OrderNumber.

Refer to AssignedBy for any enumerations.

ProductPerformanceReferenceType [attribute]

Provides a contextual explanation of the specific reference identifier. Many items are currently prefixed by "Buyer", "Forwarder", "Manufacturer", "Mill", "Seller", "Supplier", "Warehouse", or "Vendor". Check for an existing non-prefixed version and use the non-prefixed version instead. In the (yet to be announced release date) version 3.0 the prefixed versions will be removed. Instead the attribute @AssignedBy will communicate the information previously communicated in the prefix.

attribute	
ProductPerformanceReferenceType	
type	referenceType

Refer to the [referenceType](#) entry for the list of enumerations and their definitions.

ProductPerformanceStatusType [attribute]

ProductPerformanceStatusType

This item is restricted to the following list.

Original

The supplied information is the first version of that information.

Replaced

The supplied information is replacing earlier supplied information. The receiver should revalidate the information in their system based upon the entire information received.

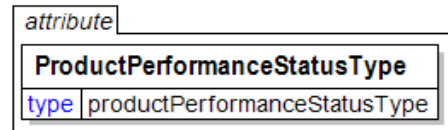

ProductPerformanceSummary

Summary information for the items on the ProductPerformance e-Document

(sequence)

The sequence of items below is mandatory. A single instance is required.

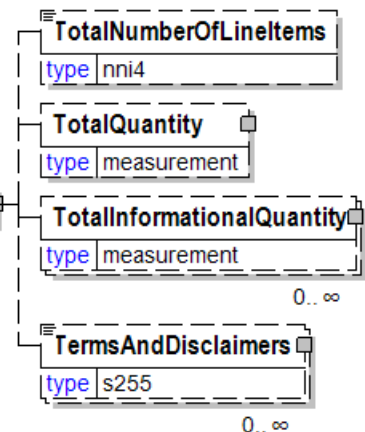

TotalNumberOfLineItems

TotalNumberOfLineItems is optional. A single instance might exist.

The total number of individual line items in the document, regardless of the status or type.

TotalQuantity

TotalQuantity is optional. A single instance might exist.

The total quantity of similar items in the e-Document. TotalQuantity is primarily used in the summary section of documents where it is repeatable to permit totaling for different units of measure.

TotalInformationalQuantity

TotalInformationalQuantity is optional. Multiple instances might exist.

A quantity that is used to communicate related information about the parent element. This element represents a total that is derived from individual line items.

TermsAndDisclaimers

TermsAndDisclaimers is optional. Multiple instances might exist.

An element that contains legal information with an indication of what the Language is.

ProductQuality

The ProductQuality element is the root element for the ProductQuality e-Document.

The

ProductQuality e-Document supports the exchange of quality data for individual items. The agreed properties of the product that are exchanged can include statistical values such as minimum and maximum, standard deviation, sample size, two sigma (lower-limit, upper-limit).

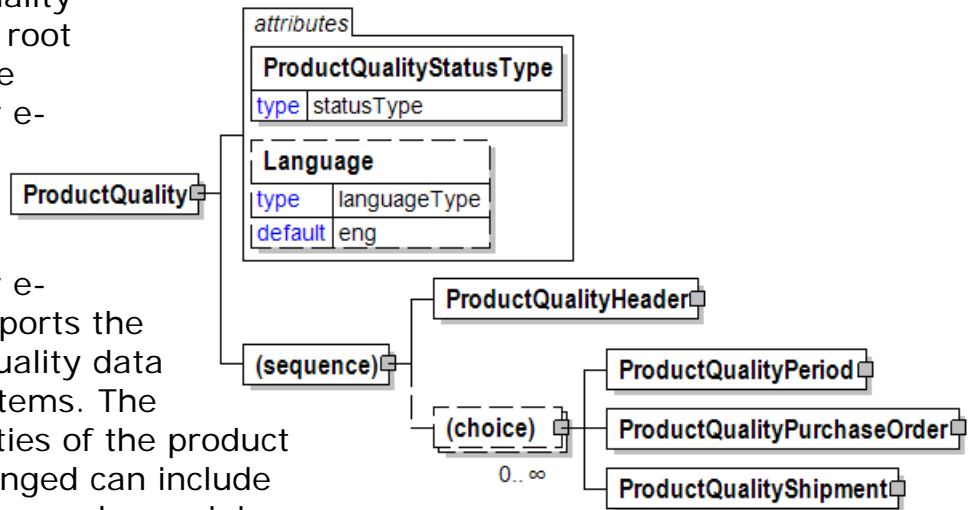

ProductQualityStatusType [attribute]

ProductQualityStatusType is mandatory. A single instance is required.

Communicates the status of the ProductQuality e-Document

Refer to ProductQualityStatusType definition for any enumerations.

Language [attribute]

Language is optional. A single instance might exist.

XML has embraced 2 and 3 digit language codes through the application of an addendum to the standard.

Refer to Language definition for any enumerations.

(sequence)

The sequence of items below is mandatory. A single instance is required.

ProductQualityHeader

ProductQualityHeader is mandatory. A single instance is required.

Information the common to all items on the ProductQuality e-Document.

(choice)

[choice] is optional because of choice construct.

ProductQualityPeriod

ProductQualityPeriod is optional because of choice construct.

ProductQualityPeriod

ProductQualityPurchaseOrder

ProductQualityPurchaseOrder is optional because of choice construct.

Multiple instances of purchase order information is allowed to support a list of purchase orders manufactured during the indicated period. Alternatively, ProductQualityPeriod may be repeated with the same TimePeriod for each PurchaseOrder if the quality data is available at this level of detail.

ProductQualityShipment

ProductQualityShipment is optional because of choice construct.

Product quality information communicated by shipment.

ProductQualityHeader

Information the common to all items on the ProductQuality e-Document.

(sequence)

The sequence of items below is mandatory. A single instance is required.

ProductQualityIssueDate

ProductQualityIssueDate is mandatory. A single instance is required.

The date and time the ProductQuality was issued.

ProductQualityMessageNumber

ProductQualityMessageNumber is mandatory. A single instance is required.

A unique identifier assigned to each e-Document for identification purposes.

Subsequent ProductQuality e-Documents with updates or cancellations will use this same ProductQualityMessageNumber.

RequestNumber

RequestNumber is optional. A single instance might exist.

A unique tracking number specifically identifying the InfoRequest e-Document to the originator. The tracking number is returned with the "information", the answer, to help match the answer to the request.

TransactionHistoryNumber

TransactionHistoryNumber is optional. A single instance might exist.

A sequential number that keeps track of the version of a document being sent by the document originator except in the case where TransactionHistoryConfirmation is used, in which case the TransactionHistoryNumber refers to the trigger transaction for which the confirmation is being sent.

SenderParty

SenderParty is mandatory. A single instance is required.

The business entity issuing the e-Document, the source of the document.

The entity responsible for the content. If the sender party has out sourced the

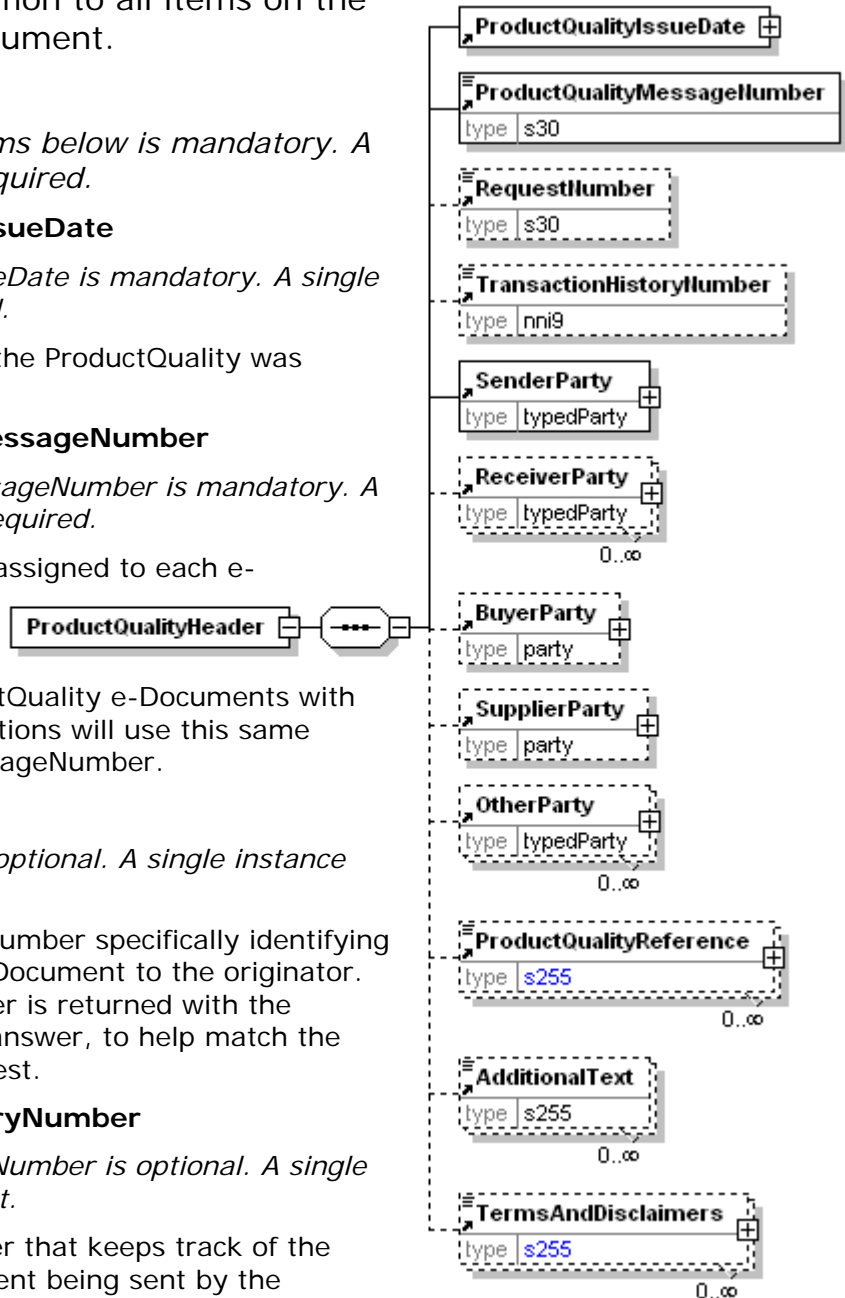

message service to a third party the SenderParty is the issuer of the e-Document and not the party performing the transmission service of the electronic message.

ReceiverParty

ReceiverParty is optional. Multiple instances might exist.

The business entity for whom the e-Document is intended, the destination of the document.

The entity interested in the content. If the receiver party has outsourced the message service to a third party the ReceiverParty is the intended party for the e-Document and not the party performing the receiving service of the electronic message.

BuyerParty

BuyerParty is optional. A single instance might exist.

The legal entity to which the product is sold. Also commonly referred to as the sold-to party or customer. If no OtherParty is defined as the Payer, the Buyer is the Payer.

SupplierParty

SupplierParty is optional. A single instance might exist.

The organisation or business entity responsible for providing the product. SupplierParty is also the seller of the product, if Seller is not specified as OtherParty = Seller.

OtherParty

OtherParty is optional. Multiple instances might exist.

An organisation or business entity other than those specifically detailed within a e-Document.

ProductQualityReference

ProductQualityReference is optional. Multiple instances might exist.

An element detailing relevant references pertaining to the ProductQuality.

AdditionalText

AdditionalText is optional. Multiple instances might exist.

A text field that is used to communicate information not previously defined or for special instructions. To be used only for circumstances not covered by specific elements.

TermsAndDisclaimers

TermsAndDisclaimers is optional. Multiple instances might exist.

An element that contains legal information with an indication of what the Language is.

ProductQualityIssueDate

The date and time the ProductQuality was issued.

(sequence)

The sequence of items below is mandatory. A single instance is required.

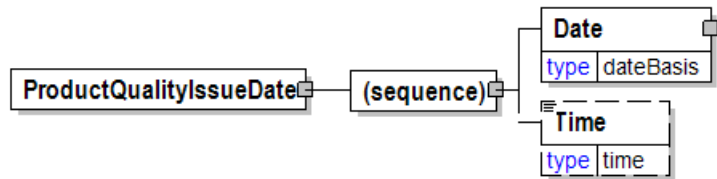

Date

Date is mandatory. A single instance is required.

A group element that contains the specification of Year, Month, and Day.

Time

Time is optional. A single instance might exist.

Times are treated in a standard XML fashion with a special case used to indicate a generalized "local" time. The standard XML approach to time is hh:mm:ss, hh:mm:ssZ, or hh:mm:ss±hh:mm.

hh:mm:ss±hh:mm is used to represent a time with a time zone. The time zone is communicated as the number of hours offset from the Universal Time Coordinate (UTC), a.k.a. Greenwich Mean Time.

hh:mm:ssZ indicates the time at Zulu (another name for UTC). Based on the convention described in the next bullet it will be important for users within UTC to use "Z" when communicating a time in their time zone to other users.

hh:mm:ss or hh:mm indicates in the XML standard the time at UTC however, within papiNet it is used to represent the applicable local time. Caution should be used when processing times of this nature as the papiNet approach may be in discord with other users of XML.

ProductQualityMessageNumber

A unique identifier assigned to each e-Document for identification purposes. Subsequent ProductQuality e-Documents with updates or cancellations will use this same ProductQualityMessageNumber.

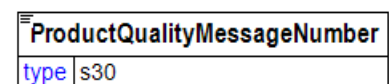

ProductQualityPeriod

ProductQualityPeriod

(sequence)

The sequence of items below is mandatory. A single instance is required.

TimePeriod

TimePeriod is mandatory. A single instance is required.

The TimePeriod element is used to communicate a duration period of time as indicated in PeriodType.

Product

Product is mandatory. A single instance is required.

Product is a group item defining the article and its characteristics. Product is used to specify product characteristics organized by ProductIdentifier, ProductDescription, and

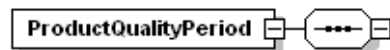

Classification. Book Manufacturing, Label Stock, Paper, Pulp, Recovered Paper, Wood Products, and Virgin Fibre market segments have defined their product characteristics and conversion features for implementation in papiNet.

(sequence)

The sequence of items below is optional. Multiple instances might exist.

PurchaseOrderInformation

PurchaseOrderInformation is mandatory. A single instance is required.

A group item containing information unique to this PurchaseOrder, which is provided by the buyer. PurchaseOrderInformation can be optional in the supply chain. Invoices are created without having a PurchaseOrder in Vendor Managed Inventory. Freight invoices also will not have a PurchaseOrder number.

PurchaseOrderLineItemNumber

PurchaseOrderLineItemNumber is optional. A single instance might exist.

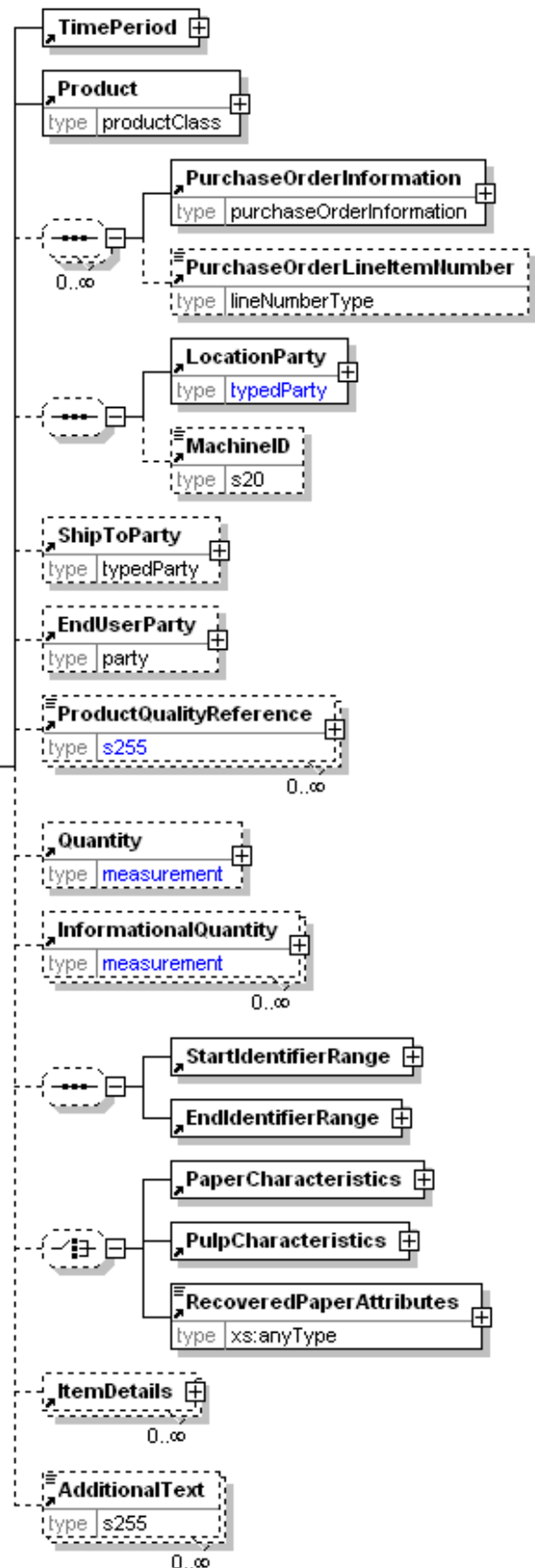

papiNet V2R31

The sequential number that uniquely identifies the PurchaseOrder line item.

(sequence)

The sequence of items below is optional. A single instance might exist.

LocationParty

LocationParty is mandatory. A single instance is required.

The organization or business entity where the business event took place or will take place.

MachineID

MachineID is optional. A single instance might exist.

An identifier assigned to the particular machine being referenced. For example, a machine could be a paper machine, an off-line coater, a sheeter, or a printing press. The particular machine being referenced will be determined by the business event being supported.

ShipToParty

ShipToParty is optional. A single instance might exist.

The name and/or address to which the goods should be delivered with the party type indicated by the PartyType attribute.

EndUserParty

EndUserParty is optional. A single instance might exist.

The party using, consuming, or converting the product. For example, a printer using paper reels for a print job for a publisher. The final ShipTo destination for a product is normally to the end user's facilities.

ProductQualityReference

ProductQualityReference is optional. Multiple instances might exist.

An element detailing relevant references pertaining to the ProductQuality.

Quantity

Quantity is optional. A single instance might exist.

The Quantity element contains attributes that provide information about the type of quantity that is being communicated, the context in which the particular quantity is to be viewed, and (if the quantity represents an adjustment) an adjustment type.

The Quantity element contains three child elements that enable you to communicate a range of values for the quantity and a target or actual value. It is at this level (Value, RangeMin, and RangeMax) that the unit of measure is specified. This permits the range to be specified in a different unit of measure than the target.

InformationalQuantity

InformationalQuantity is optional. Multiple instances might exist.

A quantity given in a valid UOM used for information purposes only (not for calculation). For example, an ordered quantity was 100 reels as opposed to the invoice quantity of 20,000 pounds.

(sequence)

The sequence of items below is optional. A single instance might exist.

StartIdentifierRange

StartIdentifierRange is mandatory. A single instance is required.

An element that identifies the starting item identifier in the range of items that contributed to the aggregated measurements for the range.

EndIdentifierRange

EndIdentifierRange is mandatory. A single instance is required.

A group element that identifies the ending item identifier in the range of items that contributed to the aggregated measurements for the range.

(choice)

[choice] is optional because of choice construct.

PaperCharacteristics

PaperCharacteristics is optional because of choice construct.

The identifying characteristics of paper most important to the ordering of the item. These are the characteristics that, when associated with a given grade, allow the manufacturer to produce but not convert or package, the paper.

PulpCharacteristics

PulpCharacteristics is optional because of choice construct.

The physical and chemical characteristics of the pulp product regardless of the form that it is taking.

RecoveredPaperAttributes

RecoveredPaperAttributes is optional because of choice construct.

The attributes of Recovered Paper.

ItemDetails

ItemDetails is optional. Multiple instances might exist.

A group element that identifies a specific item and measured attribute values for that item.

AdditionalText

AdditionalText is optional. Multiple instances might exist.

A text field that is used to communicate information not previously defined or for special instructions. To be used only for circumstances not covered by specific elements.

ProductQualityPurchaseOrder

Multiple instances of PurchaseOrder information is allowed to support a list of purchase orders manufactured during the indicated period. Alternatively, ProductQualityPeriod may be repeated with the same TimePeriod for each PurchaseOrder if the quality data is available at this level of detail.

(sequence)

The sequence of items below is mandatory. A single instance is required.

PurchaseOrderInformation

PurchaseOrderInformation is mandatory. A single instance is required.

A group item containing information unique to this PurchaseOrder, which

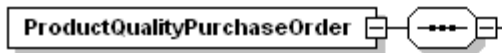

is provided by the buyer. PurchaseOrderInformation can be optional in the supply chain. Invoices are created without having a PurchaseOrder in Vendor Managed Inventory. Freight invoices also will not have a PurchaseOrder number.

PurchaseOrderLineItemNumber

PurchaseOrderLineItemNumber is optional. A single instance might exist.

The sequential number that uniquely identifies the PurchaseOrder line item.

Product

Product is mandatory. A single instance is required.

Product is a group item defining the article and its characteristics. Product is used to specify product characteristics organized by ProductIdentifier, ProductDescription, and Classification. Book Manufacturing, Label Stock, Paper, Pulp, Recovered Paper, Wood Products, and Virgin Fibre market segments have defined their product characteristics and conversion features for implementation in papiNet.

(sequence)

The sequence of items below is optional. A single instance might exist.

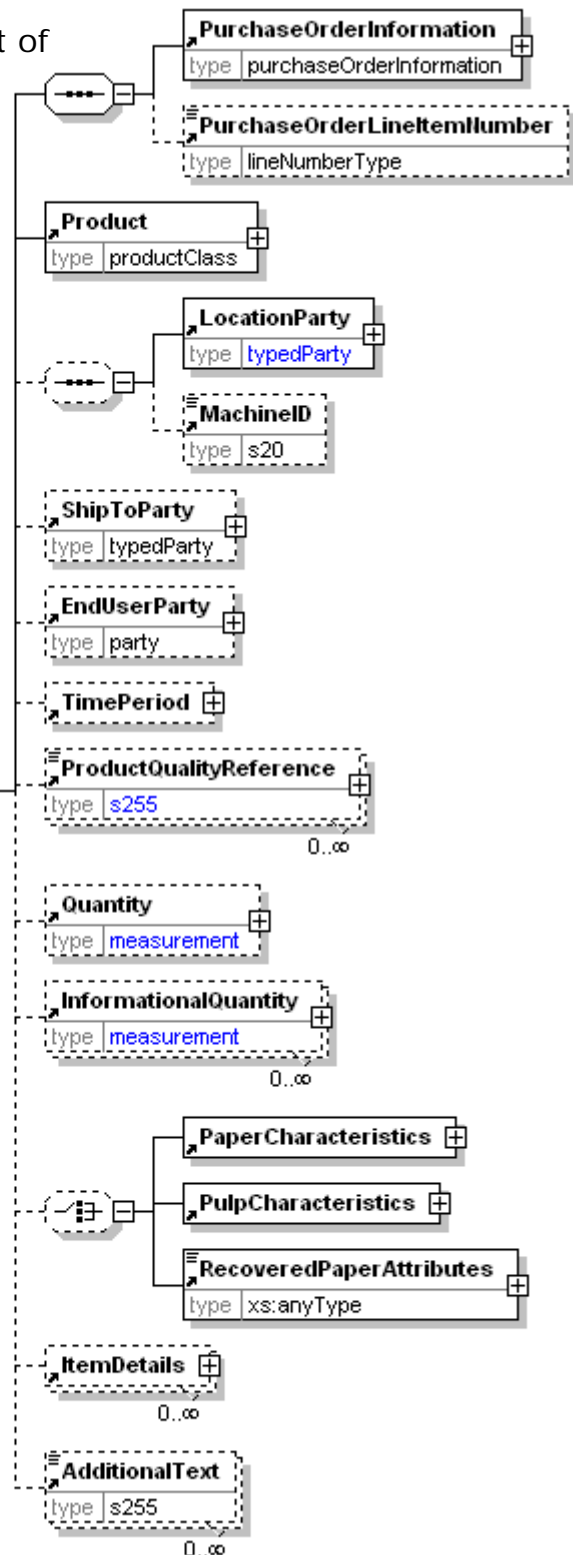

LocationParty

LocationParty is mandatory. A single instance is required.

The organization or business entity where the business event took place or will take place.

MachineID

MachineID is optional. A single instance might exist.

An identifier assigned to the particular machine being referenced. For example, a machine could be a paper machine, an off-line coater, a sheeter, or a printing press. The particular machine being referenced will be determined by the business event being supported.

ShipToParty

ShipToParty is optional. A single instance might exist.

The name and/or address to which the goods should be delivered with the party type indicated by the PartyType attribute.

EndUserParty

EndUserParty is optional. A single instance might exist.

The party using, consuming, or converting the product. For example, a printer using paper reels for a print job for a publisher. The final ShipTo destination for a product is normally to the end user's facilities.

TimePeriod

TimePeriod is optional. A single instance might exist.

The TimePeriod element is used to communicate a duration period of time as indicated in PeriodType.

ProductQualityReference

ProductQualityReference is optional. Multiple instances might exist.

An element detailing relevant references pertaining to the ProductQuality.

Quantity

Quantity is optional. A single instance might exist.

The Quantity element contains attributes that provide information about the type of quantity that is being communicated, the context in which the particular quantity is to be viewed, and (if the quantity represents an adjustment) an adjustment type.

The Quantity element contains three child elements that enable you to communicate a range of values for the quantity and a target or actual value. It is at this level (Value, RangeMin, and RangeMax) that the unit of measure is specified. This permits the range to be specified in a different unit of measure than the target.

InformationalQuantity

InformationalQuantity is optional. Multiple instances might exist.

A quantity given in a valid UOM used for information purposes only (not for calculation). For example, an ordered quantity was 100 reels as opposed to the invoice quantity of 20,000 pounds.

(choice)

[choice] is optional because of choice construct.

PaperCharacteristics

papiNet V2R31

PaperCharacteristics is optional because of choice construct.

The identifying characteristics of paper most important to the ordering of the item. These are the characteristics that, when associated with a given grade, allow the manufacturer to produce but not convert or package, the paper.

PulpCharacteristics

PulpCharacteristics is optional because of choice construct.

The physical and chemical characteristics of the pulp product regardless of the form that it is taking.

RecoveredPaperAttributes

RecoveredPaperAttributes is optional because of choice construct.

The attributes of Recovered Paper.

ItemDetails

ItemDetails is optional. Multiple instances might exist.

A group element that identifies a specific item and measured attribute values for that item.

AdditionalText

AdditionalText is optional. Multiple instances might exist.

A text field that is used to communicate information not previously defined or for special instructions. To be used only for circumstances not covered by specific elements.

ProductQualityReference

An element detailing relevant references pertaining to the ProductQuality.

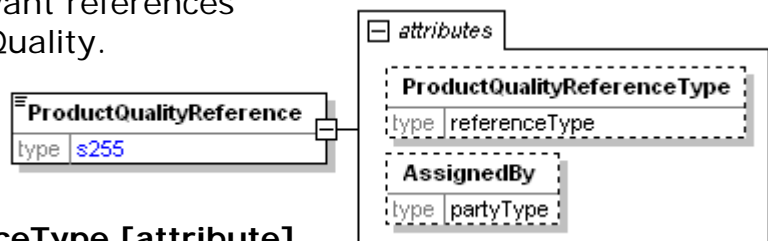

ProductQualityReferenceType [attribute]

ProductQualityReferenceType is optional. A single instance might exist.

Provides a contextual explanation of the specific reference identifier. Many items are currently prefixed by "Buyer", "Forwarder", "Manufacturer", "Mill", "Seller", "Supplier", "Warehouse", or "Vendor". Check for an existing non-prefixed version and use the non-prefixed version instead. In the (yet to be announced release date) version 3.0 the prefixed versions will be removed. Instead the attribute @AssignedBy will communicate the information previously communicated in the prefix.

Refer to ProductQualityReferenceType definition for any enumerations.

AssignedBy [attribute]

AssignedBy is optional. A single instance might exist.

Identifies the type of party that has assigned the associated item, e.g. a reference of type OrderNumber.

Refer to AssignedBy definition for any enumerations.

ProductQualityReferenceType [attribute]

Provides a contextual explanation of the specific reference identifier. Many items are currently prefixed by "Buyer", "Forwarder", "Manufacturer", "Mill", "Seller", "Supplier", "Warehouse", or "Vendor". Check for an

existing non-prefixed version and use the non-prefixed version instead. In the (yet to be announced release date) version 3.0 the prefixed versions will be removed. Instead the attribute @AssignedBy will communicate the information previously communicated in the prefix.

Refer to the [referenceType](#) entry for the list of enumerations and their definitions.

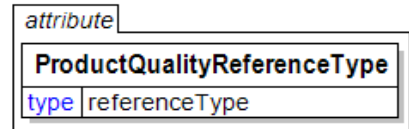

ProductQualityRequestDetail

A grouping element that provides the parameters to be used when responding with a ProductQuality e-Document.

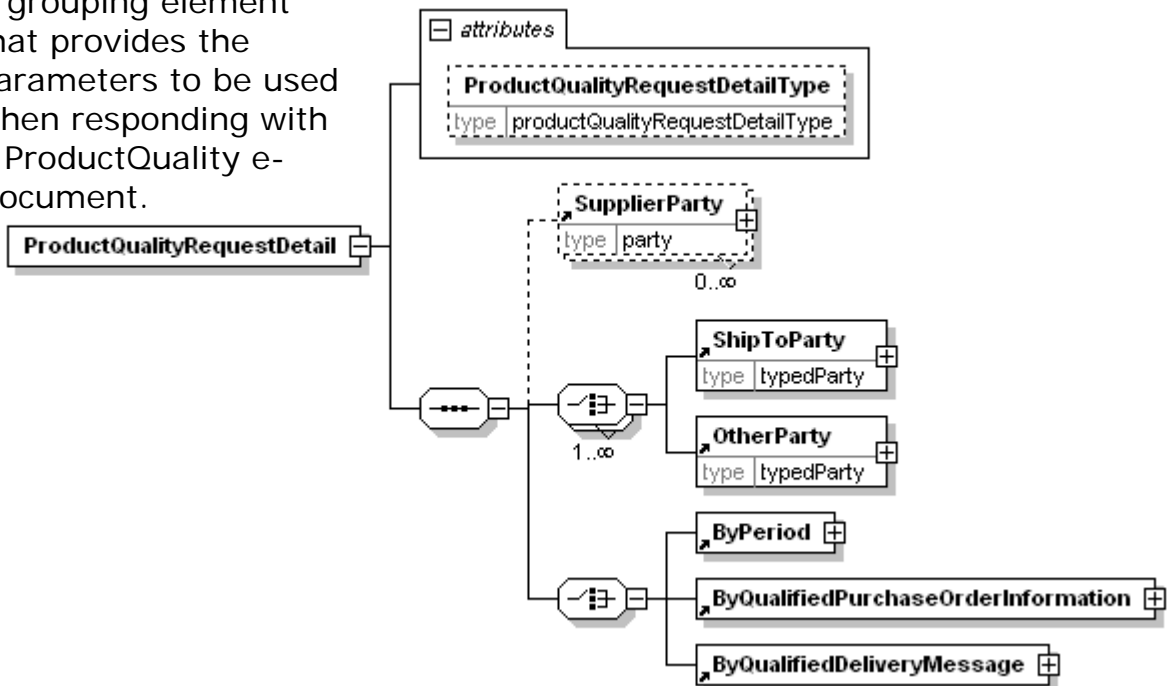

ProductQualityRequestDetailType [attribute]

ProductQualityRequestDetailType is optional. A single instance might exist.

Communicates the method in which the OrderStatus has been, or should be, summarized.

Refer to ProductQualityRequestDetailType definition for any enumerations.

(sequence)

The sequence of items below is mandatory. A single instance is required.

SupplierParty

SupplierParty is optional. Multiple instances might exist.

The organisation or business entity responsible for providing the product.

SupplierParty is also the seller of the product, if Seller is not specified as OtherParty = Seller.

(choice)

[choice] is optional because of choice construct.

ShipToParty

ShipToParty is optional because of choice construct.

The name and/or address to which the goods should be delivered with the party type indicated by the PartyType attribute.

OtherParty

OtherParty is optional because of choice construct.

An organisation or business entity other than those specifically detailed within a e-Document.

(choice)

[choice] is optional because of choice construct.

ByPeriod

ByPeriod is optional because of choice construct.

This element is mutually exclusive of ByQualifiedPurchaseOrderInformation and ByQualifiedDeliveryMessage.

ByQualifiedPurchaseOrderInformation

ByQualifiedPurchaseOrderInformation is optional because of choice construct.

ByQualifiedPurchaseOrderInformation is a conditional element. This element is mutually exclusive of ByPeriod and ByShipment. The use of the term "qualified" is to indicate that PurchaseOrderInformation is qualified by the use of PurchaseOrderLineNumber.

ByQualifiedDeliveryMessage

ByQualifiedDeliveryMessage is optional because of choice construct.

ByQualifiedDeliveryMessage is a conditional element. This element is mutually exclusive of ByQualifiedPurchaseOrderInformation and ByPeriod. The use of the term "qualified" is to indicate that DeliveryMessageNumber is qualified by the use of DeliveryMessageLineNumber.

ProductQualityRequestDetailType [attribute]

Communicates the method in which the OrderStatus has been, or should be, summarized.

ProductQualityRequestDetailType
type productQualityRequestDetailType

This item is restricted to the following list.

ByPeriod

ByPeriod is a conditional element. This element is mutually exclusive of ByQualifiedPurchaseOrderInformation and ByQualifiedDeliveryMessage.

ByQualifiedPurchaseOrderInformation

By a PurchaseOrder that has additional items associated with it. (The PO has been differentiated, or qualified, by these items.)

ByShipment

By shipment

ProductQualityShipment

Product quality information communicated by shipment.

(sequence)

The sequence of items below is mandatory. A single instance is required.

DeliveryMessageNumber

DeliveryMessageNumber is mandatory. A single instance is required.

A unique delivery identifier assigned to each DeliveryMessage as agreed between the trading partners.

DeliveryMessageLineItemNumber

DeliveryMessageLineItemNumber is optional. A single instance might exist.

The sequential number that uniquely identifies the delivery line item.

TransportVehicleCharacteristics

TransportVehicleCharacteristics is optional. A single instance might exist.

A group item defining the primary means of transporting the goods, such as a side port vessel. In some instances, the transport unit and vehicle are the same.

TransportUnitCharacteristics

TransportUnitCharacteristics is optional. A single instance might exist.

A group item defining and identifying the primary means of containing the goods. In some instances, the transport unit and vehicle are the same.

Product

Product is mandatory. A single instance is required.

Product is a group item defining the article and its characteristics. Product is used to specify product characteristics organized by ProductIdentifier, ProductDescription, and Classification. Book Manufacturing, Label Stock, Paper, Pulp, Recovered Paper, Wood Products, and Virgin Fibre market segments

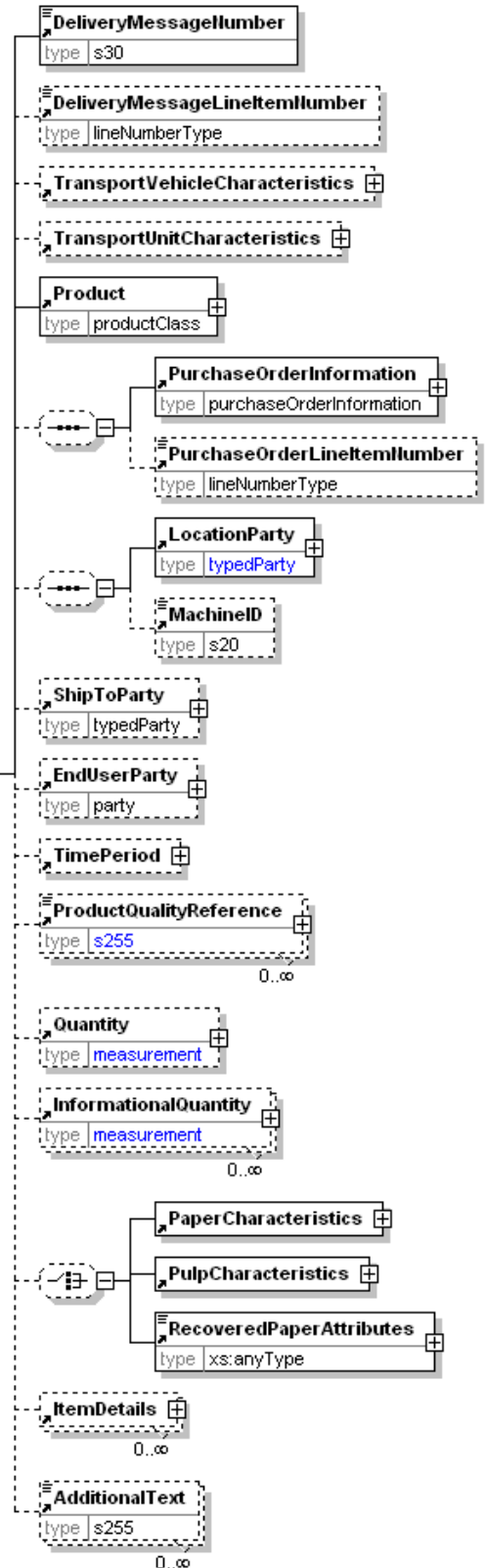

have defined their product characteristics and conversion features for implementation in papiNet.

(sequence)

The sequence of items below is optional. A single instance might exist.

PurchaseOrderInformation

PurchaseOrderInformation is mandatory. A single instance is required.

A group item containing information unique to this PurchaseOrder, which is provided by the buyer. PurchaseOrderInformation can be optional in the supply chain. Invoices are created without having a PurchaseOrder in Vendor Managed Inventory. Freight invoices also will not have a PurchaseOrder number.

PurchaseOrderLineItemNumber

PurchaseOrderLineItemNumber is optional. A single instance might exist.

The sequential number that uniquely identifies the PurchaseOrder line item.

(sequence)

The sequence of items below is optional. A single instance might exist.

LocationParty

LocationParty is mandatory. A single instance is required.

The organization or business entity where the business event took place or will take place.

MachineID

MachineID is optional. A single instance might exist.

An identifier assigned to the particular machine being referenced. For example, a machine could be a paper machine, an off-line coater, a sheeter, or a printing press. The particular machine being referenced will be determined by the business event being supported.

ShipToParty

ShipToParty is optional. A single instance might exist.

The name and/or address to which the goods should be delivered with the party type indicated by the PartyType attribute.

EndUserParty

EndUserParty is optional. A single instance might exist.

The party using, consuming, or converting the product. For example, a printer using paper reels for a print job for a publisher. The final ShipTo destination for a product is normally to the end user's facilities.

TimePeriod

TimePeriod is optional. A single instance might exist.

The TimePeriod element is used to communicate a duration period of time as indicated in PeriodType.

ProductQualityReference

ProductQualityReference is optional. Multiple instances might exist.

An element detailing relevant references pertaining to the ProductQuality.

Quantity

Quantity is optional. A single instance might exist.

papiNet V2R31

The Quantity element contains attributes that provide information about the type of quantity that is being communicated, the context in which the particular quantity is to be viewed, and (if the quantity represents an adjustment) an adjustment type.

The Quantity element contains three child elements that enable you to communicate a range of values for the quantity and a target or actual value. It is at this level (Value, RangeMin, and RangeMax) that the unit of measure is specified. This permits the range to be specified in a different unit of measure than the target.

InformationalQuantity

InformationalQuantity is optional. Multiple instances might exist.

A quantity given in a valid UOM used for information purposes only (not for calculation). For example, an ordered quantity was 100 reels as opposed to the invoice quantity of 20,000 pounds.

(choice)

[choice] is optional because of choice construct.

PaperCharacteristics

PaperCharacteristics is optional because of choice construct.

The identifying characteristics of paper most important to the ordering of the item. These are the characteristics that, when associated with a given grade, allow the manufacturer to produce but not convert or package, the paper.

PulpCharacteristics

PulpCharacteristics is optional because of choice construct.

The physical and chemical characteristics of the pulp product regardless of the form that it is taking.

RecoveredPaperAttributes

RecoveredPaperAttributes is optional because of choice construct.

The attributes of Recovered Paper.

ItemDetails

ItemDetails is optional. Multiple instances might exist.

A group element that identifies a specific item and measured attribute values for that item.

AdditionalText

AdditionalText is optional. Multiple instances might exist.

A text field that is used to communicate information not previously defined or for special instructions. To be used only for circumstances not covered by specific elements.

ProductQualityStatusType [attribute]

Communicates the status of the ProductQuality e-Document

This item is restricted to the following list.

Cancelled

The supplied information has been cancelled. Items that have been cancelled

attribute
ProductQualityStatusType
type statusType

are not included in totals on the summary levels of the e-Document.

Original

The supplied information is the first version of that information.

Replaced

The supplied information is replacing earlier supplied information. The receiver should revalidate the information in their system based upon the entire information received.

ProductSummary

Group of elements to provide summary information on product level.

(sequence)

The sequence of items below is mandatory. A single instance is required.

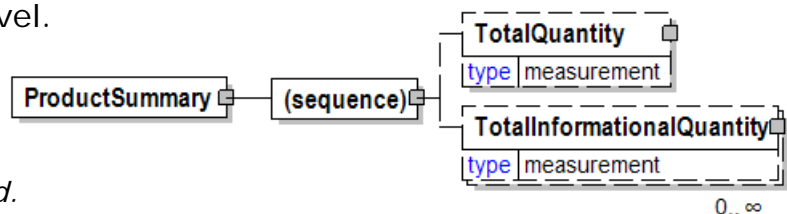

TotalQuantity

TotalQuantity is optional. A single instance might exist.

The total quantity of similar items in the e-Document. TotalQuantity is primarily used in the summary section of documents where it is repeatable to permit totaling for different units of measure.

TotalInformationalQuantity

TotalInformationalQuantity is optional. Multiple instances might exist.

A quantity that is used to communicate related information about the parent element. This element represents a total that is derived from individual line items.

ProofApprovalDate

Date field indicating when proofs will be approved.

(sequence)

The sequence of items below is mandatory. A single instance is required.

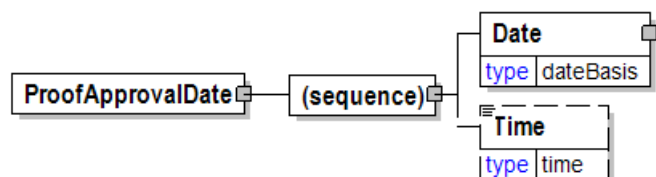

Date

Date is mandatory. A single instance is required.

A group element that contains the specification of Year, Month, and Day.

Time

Time is optional. A single instance might exist.

Times are treated in a standard XML fashion with a special case used to indicate a generalized "local" time. The standard XML approach to time is hh:mm:ss, hh:mm:ssZ, or hh:mm:ss±hh:mm.

hh:mm:ss±hh:mm is used to represent a time with a time zone. The time zone is communicated as the number of hours offset from the Universal Time Coordinate (UTC), a.k.a. Greenwich Mean Time.

hh:mm:ssZ indicates the time at Zulu (another name for UTC). Based on the convention described in the next bullet it will be important for users within UTC to use "Z" when communicating a time in their time zone to other users.

hh:mm:ss or hh:mm indicates in the XML standard the time at UTC however, within papiNet it is used to represent the applicable local time. Caution should be used when processing times of this nature as the papiNet approach may be in discord with other users of XML.

ProofDueDate

Proof due date

(sequence)

The sequence of items below is mandatory. A single instance is required.

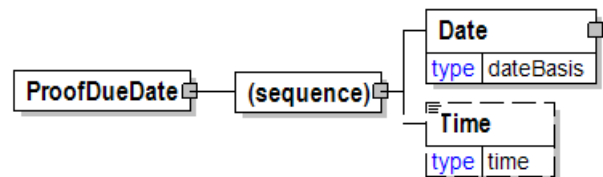

Date

Date is mandatory. A single instance is required.

A group element that contains the specification of Year, Month, and Day.

Time

Time is optional. A single instance might exist.

Times are treated in a standard XML fashion with a special case used to indicate a generalized "local" time. The standard XML approach to time is hh:mm:ss, hh:mm:ssZ, or hh:mm:ss±hh:mm.

hh:mm:ss±hh:mm is used to represent a time with a time zone. The time zone is communicated as the number of hours offset from the Universal Time Coordinate (UTC), a.k.a. Greenwich Mean Time.

hh:mm:ssZ indicates the time at Zulu (another name for UTC). Based on the convention described in the next bullet it will be important for users within UTC to use "Z" when communicating a time in their time zone to other users.

hh:mm:ss or hh:mm indicates in the XML standard the time at UTC however, within papiNet it is used to represent the applicable local time. Caution should be used when processing times of this nature as the papiNet approach may be in discord with other users of XML.

ProofInformationalQuantity

ProofInformationalQuantity

ProofType [attribute]

ProofType is optional. A single instance might exist.

Proof Type

Refer to ProofType definition for any enumerations.

(sequence)

The sequence of items below is mandatory. A single instance is required.

Quantity

Quantity is mandatory. A single instance is required.

The Quantity element contains attributes that provide information about the type of quantity that is being communicated, the context in which the particular quantity is to be viewed, and (if the quantity represents an adjustment) an adjustment type.

The Quantity element contains three child elements that enable you to communicate a range of values for the quantity and a target or actual value. It is at this level (Value, RangeMin, and RangeMax) that the unit of measure is specified. This permits the range to be specified in a different unit of measure than the target.

InformationalQuantity

InformationalQuantity is optional. Multiple instances might exist.

A quantity given in a valid UOM used for information purposes only (not for calculation). For example, an ordered quantity was 100 reels as opposed to the invoice quantity of 20,000 pounds.

OtherParty

OtherParty is optional. A single instance might exist.

An organisation or business entity other than those specifically detailed within a e-Document.

ProofApprovalDate

ProofApprovalDate is optional. A single instance might exist.

Date field indicating when proofs will be approved.

ProofDueDate

ProofDueDate is optional. A single instance might exist.

Proof due date

AdditionalText

AdditionalText is optional. Multiple instances might exist.

A text field that is used to communicate information not previously defined or for special instructions. To be used only for circumstances not covered by specific elements.

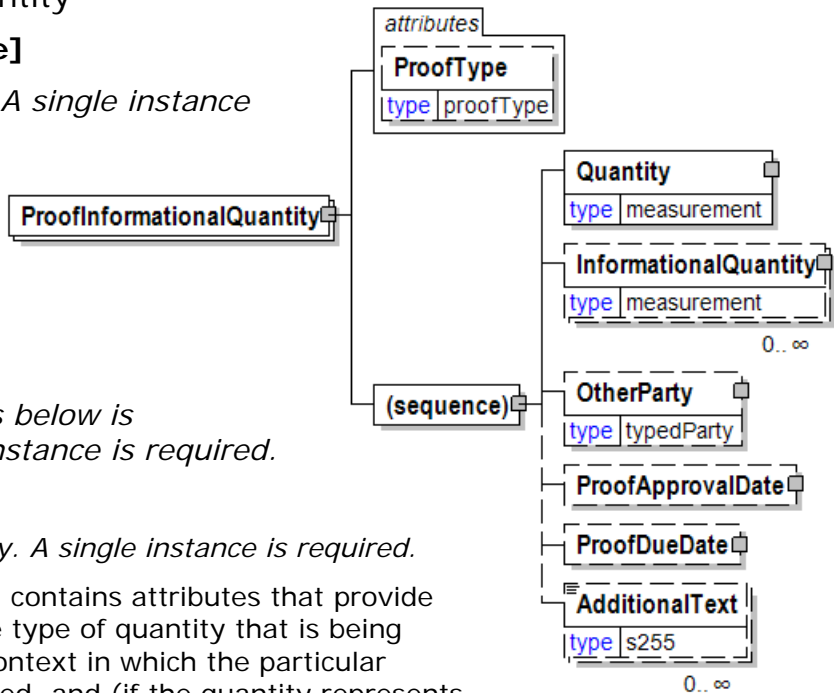

ProofType [attribute]

Proof Type

This item is restricted to the following list.

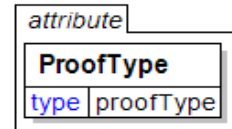

Blues

Usually inexpensive, photographic proof from negatives where all colors are shown in blue.

ColorKey

Cromalin

A versatile toner based proofing system patented by Dupont that offers the broadest variety of process, Pantone®, fluorescent, pastel and metallic colors that work in a positive film environment.

CustomCromalin

A customized version of the Dupont toner based proofing system.

DigitalProofs

A digital proof is a color prepress proofing method where a job is printed from the digital file.

Dylux

A DuPont Dylux® instant image proofing system that produces dry, instant image blueline proofs without processing.

FilmProofs

FoldedGathered

A folded, gathered assembly of prints.

InkDrawDown

When printing a PMS match color on a colored paper, an ink draw-down involves the substitution of opaque white in the ink formula, increasing covering qualities of the ink.

Iris

A large-format color printer from the Iris Graphics division of CreoScitex (www.creoscitex.com) that is used for digital proofing. Iris printers use a patented continuous ink jet technology to produce consistent, continuous-tone, photorealistic output on several varieties of paper, canvas, silk, linen and other low-fiber textiles. Iris prints are widely noted for their color accuracy and ability to match printing and proofing standards. They are also known for their low-cost consumables compared to other technologies.

MatchPrint

PressProofs

ReferenceCDCassette

Samples

T-Print

Other

PropertyAverageValue

Specifies an average value for a property for a number of items. The property is defined by the attribute PropertyType. The attribute MeasuringMethod and AssignedBy can be used to clarified details for a how a property is measured or calculated, e.g. Diameter for a sawlog can be measured "Under Bark" or "Over Bark". The attribute MeasuringMethodType defines how the value is created, e.g. measured automatically, calculated etc.

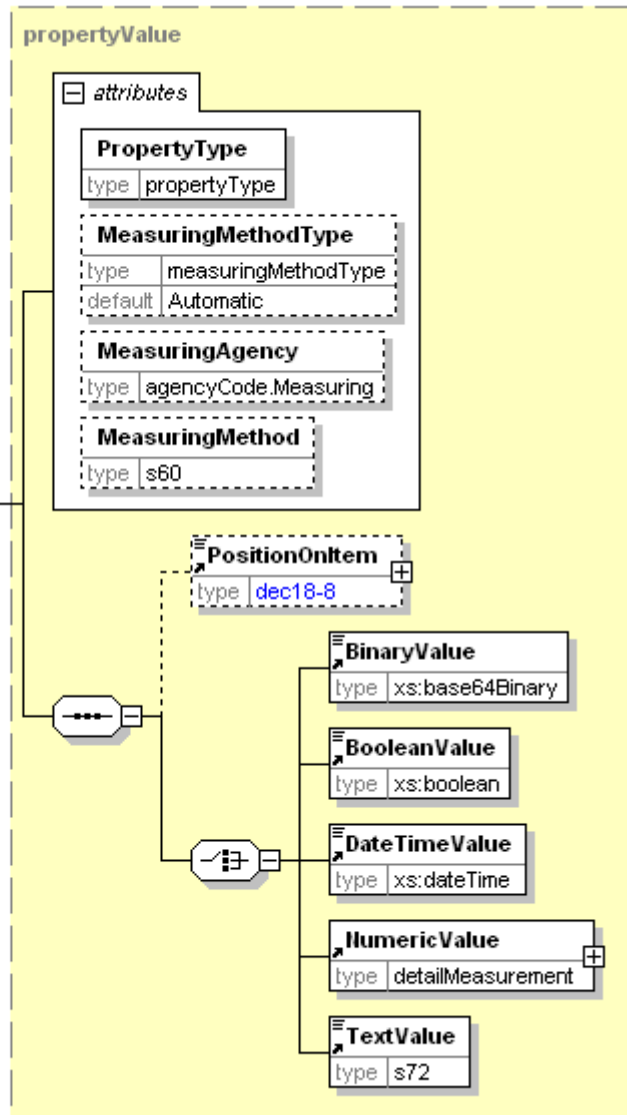
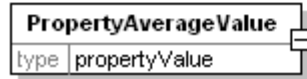

PropertyType [attribute]

PropertyType is mandatory. A single instance is required.

Defines the type of property for an item.

Refer to PropertyType definition for any enumerations.

MeasuringMethodType [attribute]

MeasuringMethodType is optional. A single instance might exist.

Specifies how a measurement value is created.

Refer to MeasuringMethodType definition for any enumerations.

MeasuringAgency [attribute]

MeasuringAgency is optional. A single instance might exist.

The agency defining measuring methods.

Refer to MeasuringAgency definition for any enumerations.

MeasuringMethod [attribute]

MeasuringMethod is optional. A single instance might exist.

The method used to determine how the item under consideration is measured. Measuring methods are defined by the measuring agency.

(sequence)

The sequence of items below is mandatory. A single instance is required.

PositionOnItem

PositionOnItem is optional. A single instance might exist.

Specifies a position on an item. The attribute PositionMeasuredFrom defines the reference point for the position

(choice)

Choice is mandatory. A single instance is required.

BinaryValue

BinaryValue is optional because of choice construct.

A value in base-64-encoded binary format.

BooleanValue

BooleanValue is optional because of choice construct.

A value in boolean format.

DateTimeValue

DateTimeValue is optional because of choice construct.

A Date and Time value in the standard W3C xs:dateTime format.

NumericValue

NumericValue is optional because of choice construct.

A grouping element for a numeric value and its statistical measures.

TextValue

TextValue is optional because of choice construct.

A value in text format.

PropertyType [attribute]

Defines the type of property for an item.

This item is restricted to the following list.

PropertyType	
type	propertyType

BarkClassCode

Classification of bark. A Text value.

BarkContent

The amount of bark content in an item. Often reported as a percentage. A Numeric value.

BarkThickness

The double bark thickness of an item, e.g. bark thickness of a log measured across the diameter of the log on two sides. A Numeric value.

BowDefectLength

The length of an item that can't be used because of an bow on the item. A Numeric value.

BowDiameterReduction

Reduction of the small end diameter of an item because a bow is effecting the usability of the item. A Numeric value.

BowHeight

Bow height of an item. E.g. Maximum distance between cross sectional centre of a log and a straight line between centres of each log end. A Numeric value.

BowLengthReduction

Reduction of the length of an item because a bow is effecting the usability of the item. A Numeric value.

DateProduction

Date and time when an item was produced. A DateTime value.

Diameter

Diameter of an item. A Numeric value.

DiameterClassCode

The category class for the diameter of an item. A Text value.

DiameterLargeEnd

Diameter at largest end of a item, often referred to as butt diameter. A Numeric value.

DiameterMid

Diameter at mid point of an item. A Numeric value.

DiameterReduction

Diameter reduction of an item, value to reduce from the items actual diameter. A Numeric value.

DiameterSmallEnd

Diameter at smallest end of an item, often referred to as top diameter. A Numeric value.

Dryness

Amount of dry solids content. Expressed as percentage. A Numeric value.

ForestRot

The amount of an items content of rot originating from growing trees. A Numeric value.

Height

Height of an item. A Numeric value.

Length

Length of an item. A Numeric value.

LengthClassCode

The category class for the length of an item. A Text value.

LengthReduction

Length reduction of an item, value to reduce from the items actual length. A Numeric value.

LoggingDamage

Defines damages on a Forest Wood product caused by logging. These

damages normally cause an adjustment of the product price. A Text value.

Moisture

Amount of moisture (water) in an item. It can be used for estimating of wood freshness. A Numeric value.

QualityClassCode

The category class for the quality of an item. A Text value.

SolidWoodPercentage

SolidWoodVolume expressed as a percentage of the measured volume of an item, e.g. a logpile. A Numeric value.

StorageRot

The amount of an items content of rot caused by storage. A Numeric value.

SurfaceWithoutBark

Surface of an item not covered by bark. Normally measured as percentage of the total surface area of the item. A Numeric value.

Taper

Taper of an item, the difference in diameter over a length interval. A Numeric value.

TreeAge

The age of a tree. A Numeric value.

TreeDiameterBreastHeight

Diameter at breast height (1.3 m from ground) of a tree. A Numeric value.

TreeHeight

Height of a tree from ground to the top of the tree. A Numeric value.

TreeLogOrder

Log number based on order of logs from the stump and to the small end of the tree. A Numeric value.

TreeSpeciesGroupCode

A code defining tree species or groups of tree species. A Text value.

Width

Width of an item. A Numeric value.

PropertyValue

Specifies a value for a property of an item. The property is defined by the attribute PropertyType. The attribute MeasuringMethod and AssignedBy can be used to clarified details for a how a property is measured or calculated, e.g. Diameter for a saw log can be measured "Under Bark" or "Over Bark". The attribute MeasuringMethodType defines how the value is created, e.g. measured automatically, calculated etc. The attribute IsAverageValue indicates if the value is an average value or not.

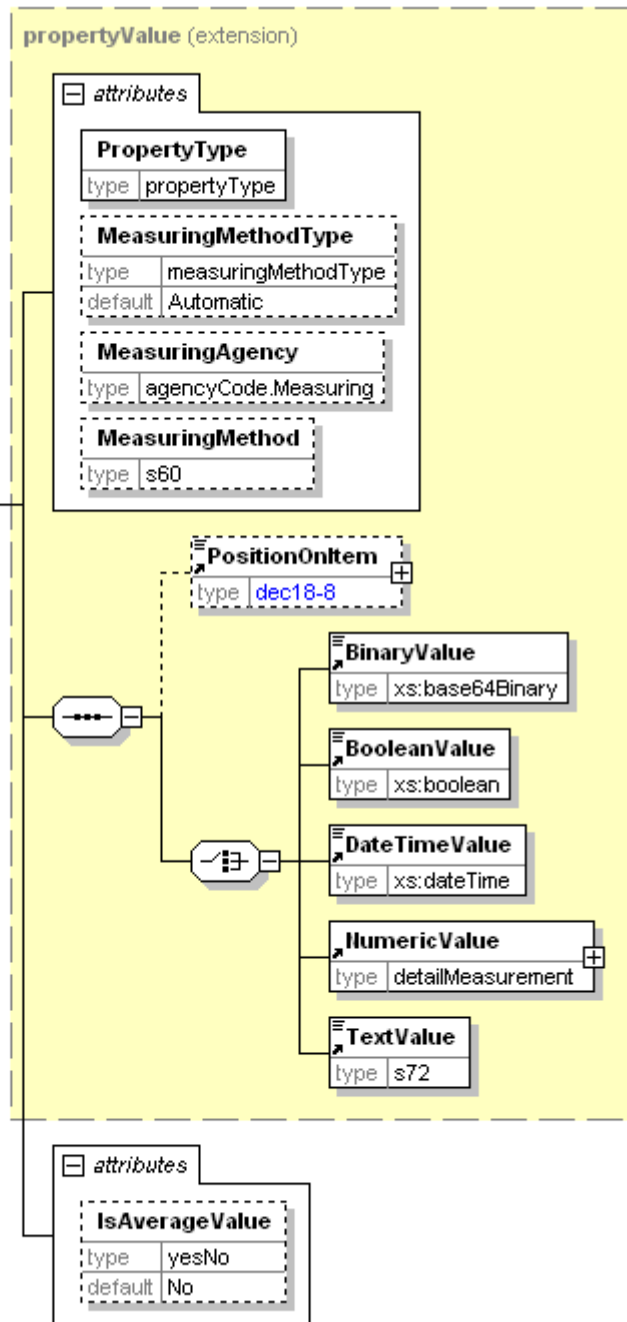

PropertyType [attribute]

PropertyType is mandatory. A single instance is required.

Defines the type of property for an item.

Refer to PropertyType definition for any enumerations.

MeasuringMethodType [attribute]

MeasuringMethodType is optional. A single instance might exist.

Specifies how a measurement value is created.

Refer to MeasuringMethodType definition for any enumerations.

MeasuringAgency [attribute]

MeasuringAgency is optional. A single instance might exist.

The agency defining measuring methods.

Refer to MeasuringAgency definition for any enumerations.

MeasuringMethod [attribute]

MeasuringMethod is optional. A single instance might exist.

The method used to determine how the item under consideration is measured. Measuring methods are defined by the measuring agency.

IsAverageValue [attribute]

IsAverageValue is optional. A single instance might exist.

Indicates if the value is an average value or not.

Refer to IsAverageValue definition for any enumerations.

(sequence)

The sequence of items below is mandatory. A single instance is required.

PositionOnItem

PositionOnItem is optional. A single instance might exist.

Specifies a position on an item. The attribute PositionMeasuredFrom defines the reference point for the position

(choice)

Choice is mandatory. A single instance is required.

BinaryValue

BinaryValue is optional because of choice construct.

A value in base-64-encoded binary format.

BooleanValue

BooleanValue is optional because of choice construct.

A value in boolean format.

DateTimeValue

DateTimeValue is optional because of choice construct.

A Date and Time value in the standard W3C xs:dateTime format.

NumericValue

NumericValue is optional because of choice construct.

A grouping element for a numeric value and its statistical measures.

TextValue

TextValue is optional because of choice construct.

A value in text format.

Pulp

A group item defining the characteristics of pulp that are not dependent on a particular conversion process.

(sequence)

The sequence of items below is mandatory. A single instance is required.

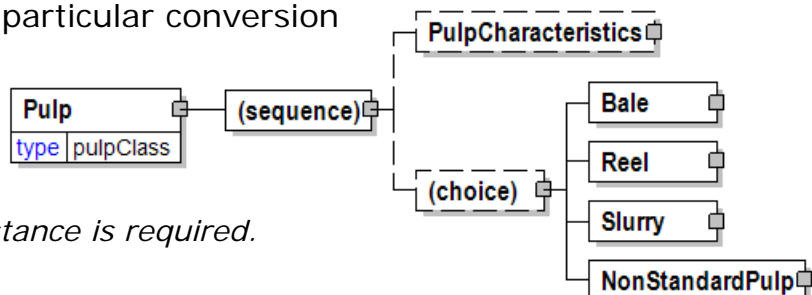

PulpCharacteristics

PulpCharacteristics is optional. A single instance might exist.

The physical and chemical characteristics of the pulp product regardless of the form that it is taking.

(choice)

[choice] is optional because of choice construct.

Bale

Bale is optional because of choice construct.

A single or rectangular grouping of product

Reel

Reel is optional because of choice construct.

A group item that contains the conversion and packaging characteristics of a reel.

Slurry

Slurry is optional because of choice construct.

Product that has moisture content high enough to prevent formation of a sheet, and which can be delivered in liquid form.

Examples:

Product that has moisture content high enough to prevent formation of a sheet, and which can be delivered in liquid form. Examples: Noodle pulp, is pumped into trucks as thick slurry, and then pumped directly into the hydropulper. It has the higher strength properties of never dried pulp.

Product that has moisture content high enough to prevent formation of a sheet, and which can be delivered in liquid form. Examples: Noodle pulp, is pumped into trucks as thick slurry, and then pumped directly into the hydropulper. It has the higher strength properties of never dried pulp. Liquid pulp, never dried pulp, often pumped directly, using a flow meter to measure the moisture and fibre content. Sold by weight of the fibre.

NonStandardPulp

NonStandardPulp is optional because of choice construct.

The characteristics of the form that pulp in a nonstandard presentation takes.

PulpCharacteristics

The physical and chemical characteristics of the pulp product regardless of the form that it is taking.

PulpingProcess [attribute]

PulpingProcess is optional. A single instance might exist.

Communicates the pulping method used to produce the pulp fibre

Refer to PulpingProcess definition for any enumerations.

BleachingProcess [attribute]

BleachingProcess is optional. A single instance might exist.

Communicates the type of bleaching process used to make the pulp fibre

Refer to BleachingProcess definition for any enumerations.

FibreSource [attribute]

FibreSource is optional. A single instance might exist.

Communicates the source of the pulp fibre

Refer to FibreSource definition for any enumerations.

(sequence)

The sequence of items below is mandatory. A single instance is required.

Ash

Ash is optional. Multiple instances might exist.

A group item used to communicate the ash content of the product according to a particular TestMethod.

BasisWeight

BasisWeight is optional. Multiple instances might exist.

The weight of the paper expressed as a mass for a given surface area. In countries using the metric system, the basis weight is expressed as the weight in grams of one sheet of paper that is one square meter in area—not dependent on basic sheet size. In countries using the imperial system, the weight is expressed in pounds for a given ProductBasisSizeType.

Brightness

Brightness is optional. Multiple instances might exist.

A measurement of the degree of light reflectivity of the product.

Burst

Burst is optional. Multiple instances might exist.

A group item used to communicate bursting strength target or test value according to a particular TestMethod.

BurstIndex

BurstIndex is optional. Multiple instances might exist.



The burst index.

ColourDetail

ColourDetail is optional. Multiple instances might exist.

A group item used to communicate details of colour according to the selected colour definition scheme.

Density

Density is optional. Multiple instances might exist.

A group item used to communicate density target or test value according to a particular TestMethod.

Dirt

Dirt is optional. Multiple instances might exist.

A group item used to communicate dirt content target or test value according to a particular TestMethod.

DrainageResistance

DrainageResistance is optional. Multiple instances might exist.

A group item used to communicate drainage resistance target or test value.

FibreLength

FibreLength is optional. Multiple instances might exist.

A group item used to communicate fibre length target or test value according to a particular TestMethod.

FibreClassification

FibreClassification is optional. Multiple instances might exist.

A group item used to communicate fibre classification according to the specified classification scheme.

Freeness

Freeness is optional. Multiple instances might exist.

Freeness

LightScattering

LightScattering is optional. Multiple instances might exist.

A group item used to communicate light scattering coefficients according to a particular TestMethod.

Moisture

Moisture is optional. Multiple instances might exist.

Desired percentage, or other indicator, of water in the product at the time of shipment.

Opacity

Opacity is optional. Multiple instances might exist.

A group item used to communicate opacity target or test value according to a particular TestMethod.

pH

pH is optional. Multiple instances might exist.

A group item used to communicate pH (degree of acidity versus basicity) target or

test value according to a particular TestMethod.

PostConsumerWaste

PostConsumerWaste is optional. Multiple instances might exist.

A group item used to communicate the target or test value percentage of post consumer waste fibre in the product according to a particular TestMethod.

PreConsumerWaste

PreConsumerWaste is optional. Multiple instances might exist.

A group item used to communicate the target or test value percentage of pre-consumer waste fibre in the product according to a particular TestMethod.

Recycled

Recycled is optional. Multiple instances might exist.

A group item used to communicate the target or test value total percentage of waste fibre in the product according to a particular TestMethod.

Tear

Tear is optional. Multiple instances might exist.

A group item used to communicate tearing resistance target or test value according to a particular TestMethod.

TearIndex

TearIndex is optional. Multiple instances might exist.

TearIndex

Tensile

Tensile is optional. Multiple instances might exist.

A group item used to communicate zero-span tensile strength target or test value according to a particular TestMethod.

TensileIndex

TensileIndex is optional. Multiple instances might exist.

Tensile Index

Viscosity

Viscosity is optional. Multiple instances might exist.

Viscosity

Whiteness

Whiteness is optional. Multiple instances might exist.

A group item used to communicate degree of whiteness target or test value according to a particular TestMethod.

AdditionalTest

AdditionalTest is optional. A single instance might exist.

AdditionalTest exists to enable the inclusion of a test that has not been identified by papiNet.org. It is always a single-instance element so it is very important that users, who come upon a test that papiNet.org has not identified, communicate the need for this test to us at www.papiNet.org.

PulpConcernCode

A group of codes that qualifies the defect or issue with a particular unit of pulp.

Agency [attribute]

Agency is mandatory. A single instance is required.

Describes the agency maintaining the list of codes. To be included in this list the agency must be a recognized standards body or industry organisation.

For the element that owns this attribute.

For another attribute in the list of attributes associated with the parent element.

Refer to Agency definition for any enumerations.

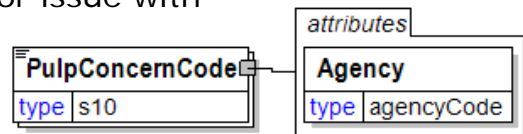

PulpConcernDescription

A narrative to correspond to the concern code.

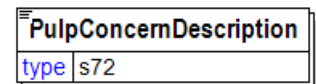

PulpConcerns

If the ConcernIndicatorType is "Y" for a pulp related product then a defect cause must be give.

MachineStoppage [attribute]

MachineStoppage is optional. A single instance might exist.

An indicator on whether the production had to be periodically stopped.

Refer to MachineStoppage definition for any enumerations.

(sequence)

The sequence of items below is mandatory. A single instance is required.

PulpConcernCode

PulpConcernCode is mandatory. One instance is required, multiple instances might exist.

A group of codes that qualifies the defect or issue with a particular unit of pulp.

PulpConcernDescription

PulpConcernDescription is optional. Multiple instances might exist.

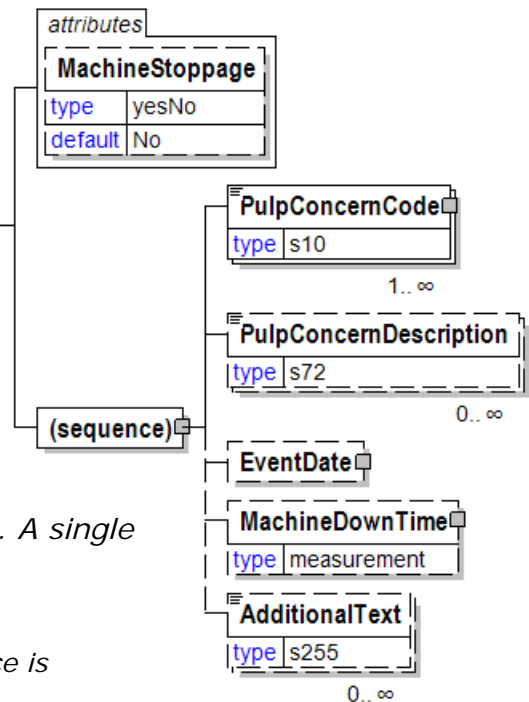

A narrative to correspond to the concern code.

EventDate

EventDate is optional. A single instance might exist.

The date the incident or delay on press was recorded.

MachineDownTime

MachineDownTime is optional. A single instance might exist.

The length of loss production time that a machine experienced due to malfunction regardless of cause.

AdditionalText

AdditionalText is optional. Multiple instances might exist.

A text field that is used to communicate information not previously defined or for special instructions. To be used only for circumstances not covered by specific elements.

PulpingProcess [attribute]

Communicates the pulping method used to produce the pulp fibre

This item is restricted to the following list.

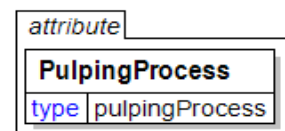

ChemicalPulp

In chemical pulping, wood is cooked in a digester at elevated pressure with a solution of the appropriate chemicals which dissolve the lignin and leave behind the cellulose.

ChemoThermoMechanicalPulp

Semi-chemical pulping process uses a combination of chemical, thermal and mechanical methods. The wood chips are partially cooked with chemicals, then heated, and the remainder of the pulping is accomplished mechanically.

DeinkedPulp

Pulp produced from deinked wastepaper, like old newsprint and old magazines.

RefinerGroundwood

Mechanical pulping process where the wood is pressed against a grinder which physically separates the fibers.

StoneGroundwood

The oldest of the large scale methods of pulping, dating back to the late 1840's is the groundwood process, in which debarked logs are forced against a huge revolving abrasive stone which shreds the fibres from the wood.

ThermoMechanical

This process, which reached commercial viability in the early 1970's, involves an initial stage in which wood chips, before entering a pressurized refiner, are softened by steam. This facilitates the separation of the cellulose and reduces damage to the individual fibres.

PulpUnitCharacteristics

A group element that contains information primarily of use for ordering.

(sequence)

The sequence of items below is mandatory. A single instance is required.

PackagingDescription

PackagingDescription is optional. A single instance might exist.

A text field element describing the packaging of a product.

Wrap

Wrap is optional. A single instance might exist.

A group item that organises wrapping detail information.

PalletCharacteristics

PalletCharacteristics is optional. A single instance might exist.

A group item that provides pallet detail information.

BalesPerUnit

BalesPerUnit is optional. A single instance might exist.

The number of bales included on the shipping, handling, or delivery unit.

LayersPerUnit

LayersPerUnit is optional. A single instance might exist.

The number of layers on the shipping, handling, or delivery unit. (This element uses pattern matching to ensure the appropriate format for latitude.)

LabelCharacteristics

LabelCharacteristics is optional. A single instance might exist.

A group item that organises the labeling information.

StencilCharacteristics

StencilCharacteristics is optional. Multiple instances might exist.

A group element specifying attributes of a stencil to be applied to an item, and optional text.

MaximumGrossWeight

MaximumGrossWeight is optional. A single instance might exist.

The maximum weight allowed including the pallet.

AdditionalText

AdditionalText is optional. Multiple instances might exist.

A text field that is used to communicate information not previously defined or for special instructions. To be used only for circumstances not covered by specific elements.

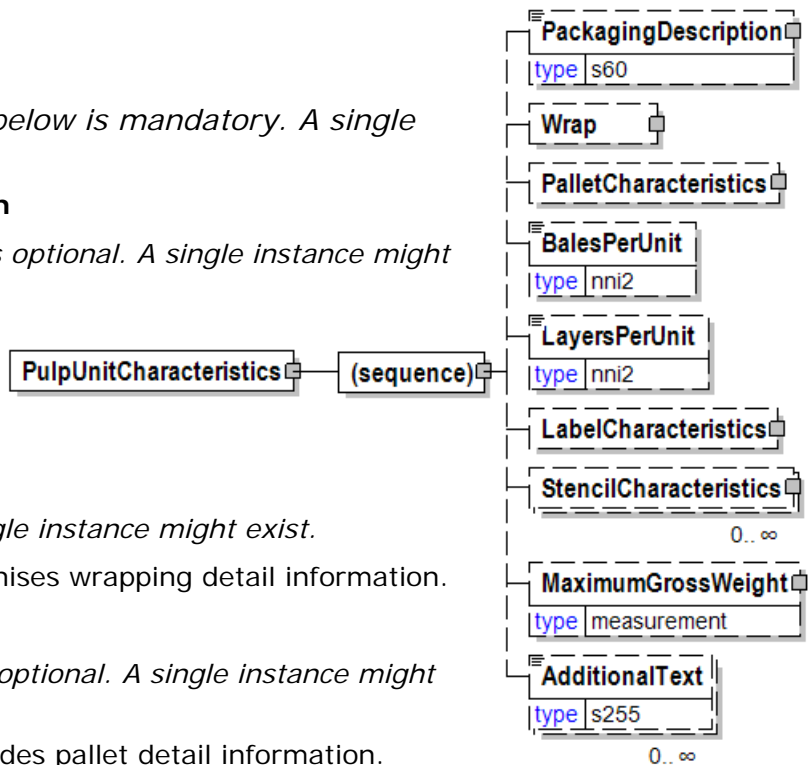

PunchedHoleDetails

A grouping element that will contain the configuration information for punched holes.

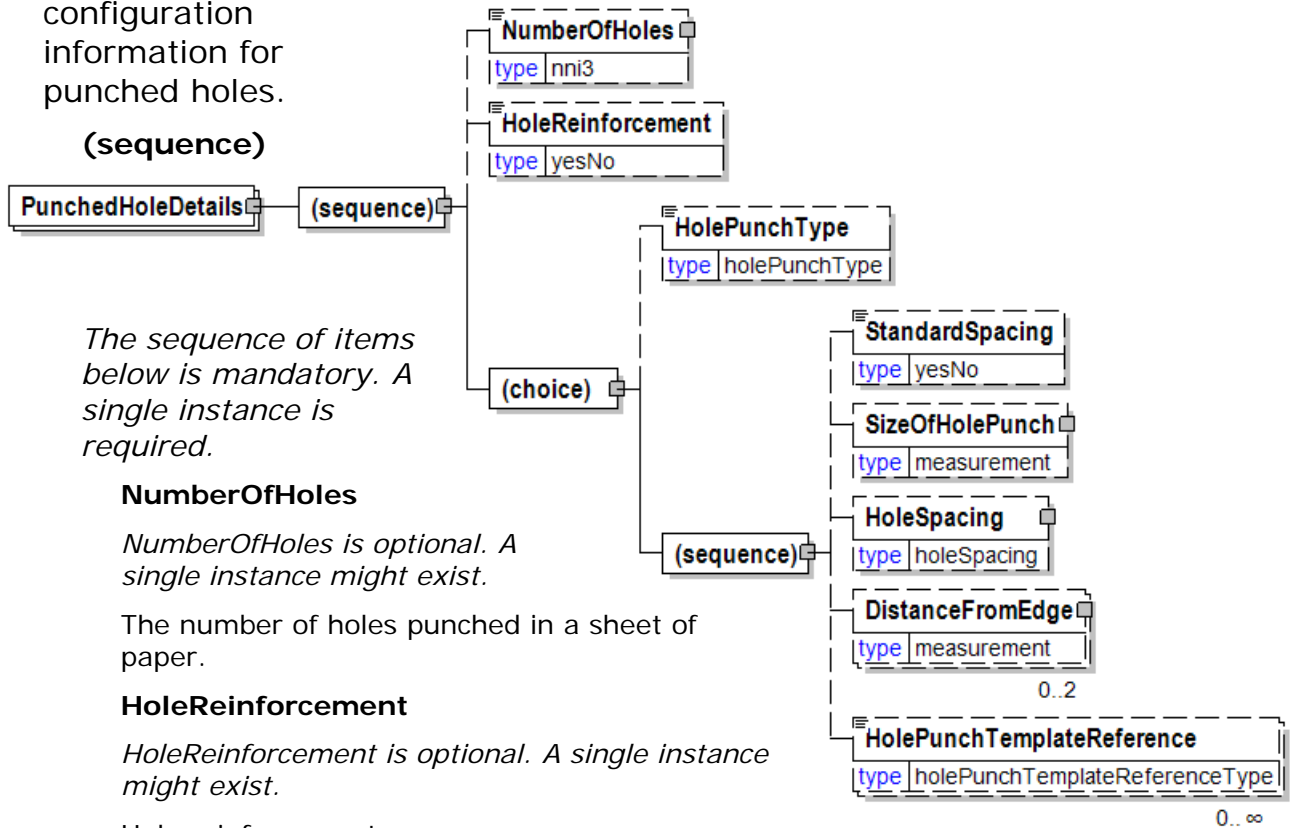

The sequence of items below is mandatory. A single instance is required.

NumberOfHoles

NumberOfHoles is optional. A single instance might exist.

The number of holes punched in a sheet of paper.

HoleReinforcement

HoleReinforcement is optional. A single instance might exist.

Hole reinforcement

Refer to HoleReinforcement definition for any enumerations.

(choice)

[choice] is optional because of choice construct.

HolePunchType

HolePunchType is optional because of choice construct.

Hole punch type.

Refer to HolePunchType definition for any enumerations.

(sequence)

The sequence of items below is mandatory. A single instance is required.

StandardSpacing

StandardSpacing is optional. A single instance might exist.

Is the spacing standard?

Refer to StandardSpacing definition for any enumerations.

SizeOfHolePunch

SizeOfHolePunch is optional. A single instance might exist.

A definition of the size and shape of the punched holes.

HoleSpacing

HoleSpacing is optional. A single instance might exist.

The HoleSpacing element is used to communicate the distance between holes.

DistanceFromEdge

DistanceFromEdge is optional.

The distance from the edge of the paper. This element is used to communicate where the hole is.

HolePunchTemplateReference

HolePunchTemplateReference is optional. Multiple instances might exist.

Hole punch template reference

PurchaseOrder

The PurchaseOrder element is the root element for the PurchaseOrder e-Document.

A buyer sends a PurchaseOrder e-Document to a supplier to initiate a trade transaction. This e-Document, which is a request for product, usually represents a firm commitment to buy. (For one type of PurchaseOrder, called a reservation order, the PurchaseOrder is not a firm commitment to buy).

PurchaseOrder

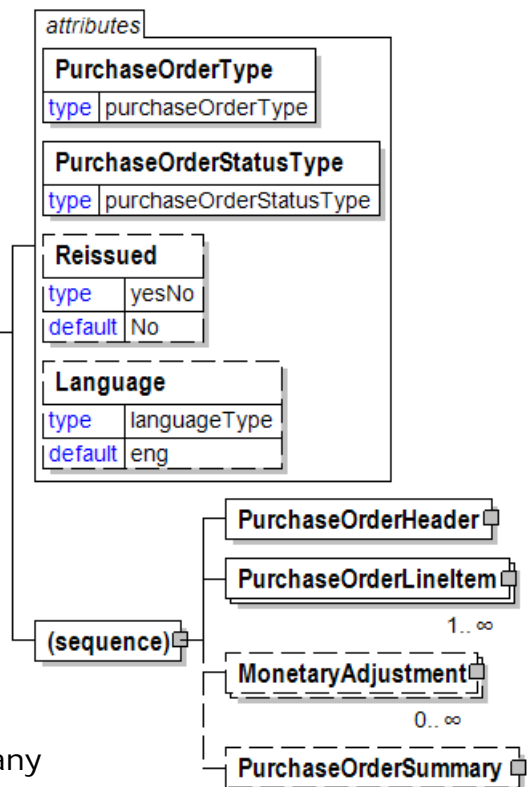

PurchaseOrderType [attribute]

PurchaseOrderType is mandatory. A single instance is required.

Defines the type of PurchaseOrder issued.

Refer to PurchaseOrderType definition for any enumerations.

PurchaseOrderStatusType [attribute]

PurchaseOrderStatusType is mandatory. A single instance is required.

Defines the status of the entire PurchaseOrder e-Document, in other words, at the root level

Refer to PurchaseOrderStatusType definition for any enumerations.

Reissued [attribute]

Reissued is optional. A single instance might exist.

Either "Yes" or "No".

Refer to Reissued definition for any enumerations.

Language [attribute]

Language is optional. A single instance might exist.

XML has embraced 2 and 3 digit language codes through the application of an addendum to the standard.

Refer to Language definition for any enumerations.

(sequence)

The sequence of items below is mandatory. A single instance is required.

PurchaseOrderHeader

PurchaseOrderHeader is mandatory. A single instance is required.

The header level of information for the PurchaseOrder containing information that relates to the entire PurchaseOrder.

PurchaseOrderLineItem

PurchaseOrderLineItem is mandatory. One instance is required, multiple instances might exist.

PurchaseOrderLineItem is a required, multiple instances element.

MonetaryAdjustment

MonetaryAdjustment is optional. Multiple instances might exist.

The element containing the information necessary for the understanding, calculation, and treatment of an adjustment to a currency amount. MonetaryAdjustment contains an attribute that indicates they type of adjustment being communicated.

PurchaseOrderSummary

PurchaseOrderSummary is optional. A single instance might exist.

PurchaseOrderSummary is required and single instance.

PurchaseOrderDetail

Multiple PurchaseOrderDetail instances are allowed.

(sequence)

The sequence of items below is mandatory. A single instance is required.

PurchaseOrderInformation

PurchaseOrderInformation is optional. A single instance might exist.

A group item containing information unique to this PurchaseOrder, which is provided by the buyer. PurchaseOrderInformation can be optional in the supply chain. Invoices are created without having a PurchaseOrder in Vendor Managed Inventory. Freight invoices also will not have a PurchaseOrder number.

PurchaseOrderLineNumber

PurchaseOrderLineNumber is optional. A single instance might exist.

The sequential number that uniquely identifies the PurchaseOrder line item.

Quantity

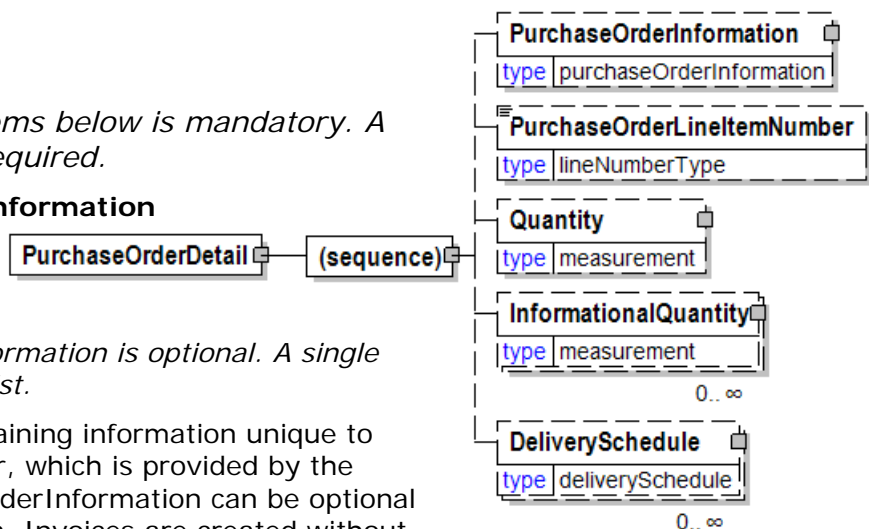

Quantity is optional. A single instance might exist.

The Quantity element contains attributes that provide information about the type of quantity that is being communicated, the context in which the particular quantity is to be viewed, and (if the quantity represents an adjustment) an adjustment type.

The Quantity element contains three child elements that enable you to communicate a range of values for the quantity and a target or actual value. It is at this level (Value, RangeMin, and RangeMax) that the unit of measure is specified. This permits the range to be specified in a different unit of measure than the target.

InformationalQuantity

InformationalQuantity is optional. Multiple instances might exist.

A quantity given in a valid UOM used for information purposes only (not for calculation). For example, an ordered quantity was 100 reels as opposed to the invoice quantity of 20,000 pounds.

DeliverySchedule

DeliverySchedule is optional. Multiple instances might exist.

A group item defining a series of DeliveryDateWindow(s) in which specified quantities must be delivered.

PurchaseOrderHeader

The header level of information for the PurchaseOrder containing information that relates to the entire PurchaseOrder.

PurchaseOrderHeaderStatusType [attribute]

PurchaseOrderHeaderStatusType is mandatory. A single instance is required.

Defines the status of the PurchaseOrder header

Refer to PurchaseOrderHeaderStatusType definition for any enumerations.

(sequence)

The sequence of items below is mandatory. A single instance is required.

PurchaseOrderInformation

PurchaseOrderInformation is mandatory. A single instance is required.

A group item containing information unique to this PurchaseOrder, which is provided by the buyer. PurchaseOrderInformation can be optional in the supply chain. Invoices are created without having a PurchaseOrder in Vendor Managed Inventory. Freight invoices also will not have a PurchaseOrder number.

TransactionHistoryNumber

TransactionHistoryNumber is optional. A single instance might exist.

A sequential number that keeps track of the version of a document being sent by the document originator except in the case where TransactionHistoryConfirmation is used, in which case the TransactionHistoryNumber refers to the trigger transaction for which the confirmation is being sent.

BuyerParty

BuyerParty is mandatory. A single instance is required.

The legal entity to which the product is sold. Also commonly referred to as the sold-to party or customer. If no OtherParty is defined as the Payer, the Buyer is the Payer.

BillToParty

BillToParty is optional. A single instance might exist.

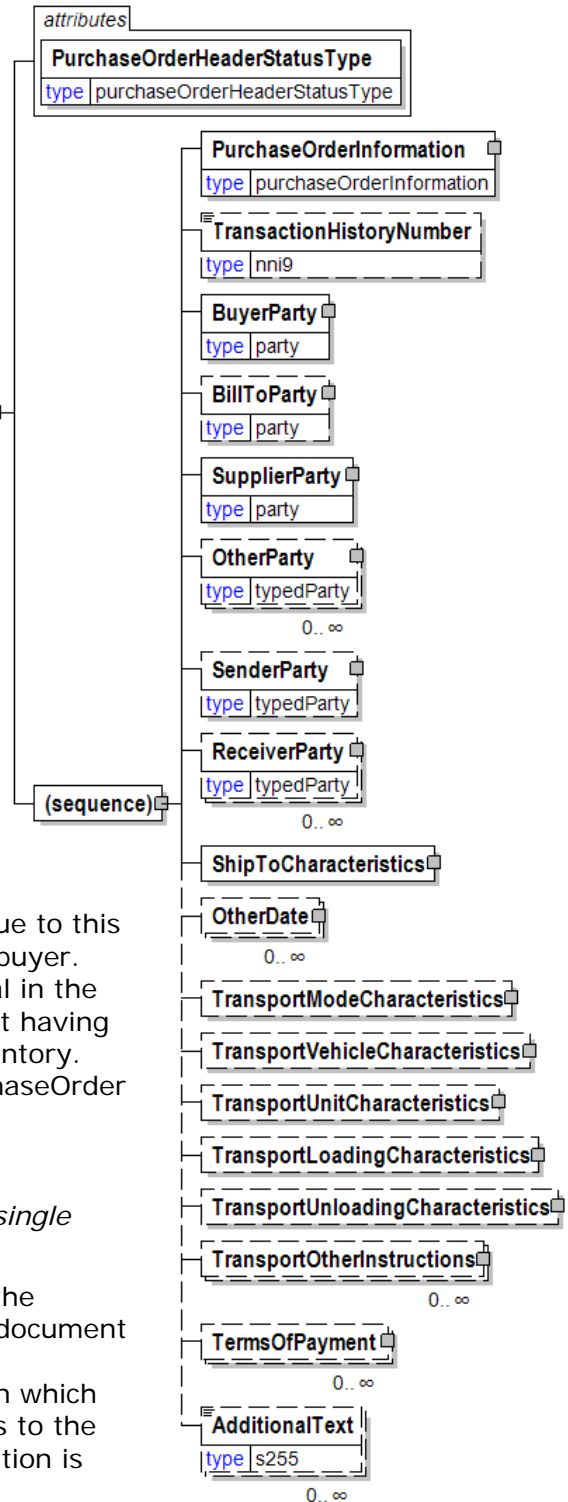

The address where the invoice is to be sent.

SupplierParty

SupplierParty is mandatory. A single instance is required.

The organisation or business entity responsible for providing the product. SupplierParty is also the seller of the product, if Seller is not specified as OtherParty = Seller.

OtherParty

OtherParty is optional. Multiple instances might exist.

An organisation or business entity other than those specifically detailed within a e-Document.

SenderParty

SenderParty is optional. A single instance might exist.

The business entity issuing the e-Document, the source of the document.

The entity responsible for the content. If the sender party has out sourced the message service to a third party the SenderParty is the issuer of the e-Document and not the party performing the transmission service of the electronic message.

ReceiverParty

ReceiverParty is optional. Multiple instances might exist.

The business entity for whom the e-Document is intended, the destination of the document.

The entity interested in the content. If the receiver party has outsourced the message service to a third party the ReceiverParty is the intended party for the e-Document and not the party performing the receiving service of the electronic message.

ShipToCharacteristics

ShipToCharacteristics is mandatory. A single instance is required.

A group item that provides information important for the Ship-To Party.

A group item that provides information important for the Ship-To Party. ShipToCharacteristics may be referenced at both the header and line item level. The reference at the header is required and acts as a default for the value at the line level, unless overridden at the line level.

OtherDate

OtherDate is optional. Multiple instances might exist.

A date that may not be specifically detailed within a document (example: print date at the PurchaseOrderLineItem).

TransportModeCharacteristics

TransportModeCharacteristics is optional. A single instance might exist.

A group item defining the primary mode of transport.

TransportVehicleCharacteristics

TransportVehicleCharacteristics is optional. A single instance might exist.

A group item defining the primary means of transporting the goods, such as a side port vessel. In some instances, the transport unit and vehicle are the same.

TransportUnitCharacteristics

TransportUnitCharacteristics is optional. A single instance might exist.

A group item defining and identifying the primary means of containing the goods. In some instances, the transport unit and vehicle are the same.

TransportLoadingCharacteristics

TransportLoadingCharacteristics is optional. A single instance might exist.

A group item defining how the transported items are to be loaded.

TransportUnloadingCharacteristics

TransportUnloadingCharacteristics is optional. A single instance might exist.

A group item defining how the transported items are to be unloaded.

TransportOtherInstructions

TransportOtherInstructions is optional. Multiple instances might exist.

A group item defining any other instructions for the transport not covered in the description of transport mode, vehicle, unit, and loading characteristics or defining an alternative description for the categories mentioned above.

TermsOfPayment

TermsOfPayment is optional. Multiple instances might exist.

A group item that contains agreed-to terms defining when, how, and under what conditions the payment is to be made.

When TermsOfPayment is optional; if omitted, TermsOfPayment is controlled through previous negotiation.

AdditionalText

AdditionalText is optional. Multiple instances might exist.

A text field that is used to communicate information not previously defined or for special instructions. To be used only for circumstances not covered by specific elements.

PurchaseOrderHeaderStatusType [attribute]

Defines the status of the PurchaseOrder header

This item is restricted to the following list.

Amended

The supplied information is changed.

Cancelled

The supplied information has been cancelled. Items that have been cancelled are not included in totals on the summary levels of the e-Document.

New

The supplied information is new and supplied for the first time.

NoAction

The supplied information has not been amended and thereby requires no action.

attribute

PurchaseOrderHeaderStatusType

type purchaseOrderHeaderStatusType

PurchaseOrderInformation

A group item containing information unique to this PurchaseOrder, which is provided by the buyer.

PurchaseOrderInformation can be optional in the supply chain.

Invoices are created without having a PurchaseOrder in Vendor

Managed

Inventory.

Freight

invoices also will not have a

PurchaseOrder number.

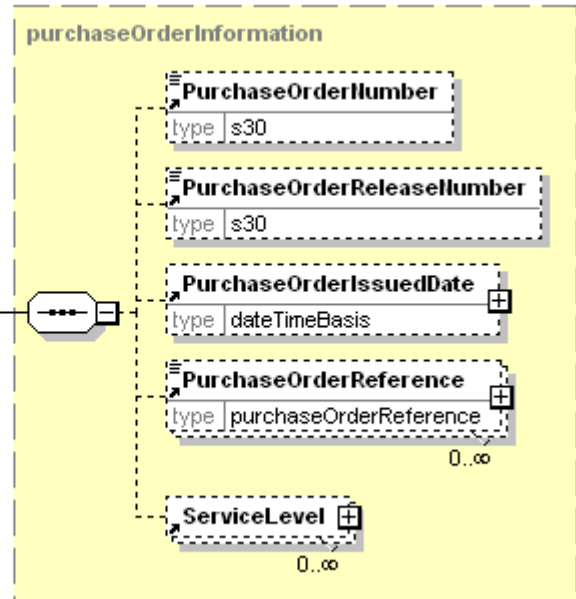
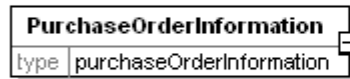

(sequence)

The sequence of items below is mandatory. A single instance is required.

PurchaseOrderNumber

PurchaseOrderNumber is optional. A single instance might exist.

The unique order identifier as designated by the customer.

PurchaseOrderReleaseNumber

PurchaseOrderReleaseNumber is optional. A single instance might exist.

The version or release of the PurchaseOrder.

PurchaseOrderIssuedDate

PurchaseOrderIssuedDate is optional. A single instance might exist.

The Date and Time on which the PurchaseOrder was issued within the buyer's system.

PurchaseOrderReference

PurchaseOrderReference is optional. Multiple instances might exist.

An item detailing relevant references (such as contract number) pertaining to the PurchaseOrder. The type of reference is identified by the PurchaseOrderReferenceType attribute.

ServiceLevel

ServiceLevel is optional. Multiple instances might exist.

A grouping element containing information about a service level. The service level can be specified in a Service Level Agreement (SLA) detailing requirements such as delivery, performance, pricing, quality, etc.

PurchaseOrderIssuedDate

The Date and Time on which the PurchaseOrder was issued within the buyer's system.

(sequence)

The sequence of items below is mandatory. A single instance is required.

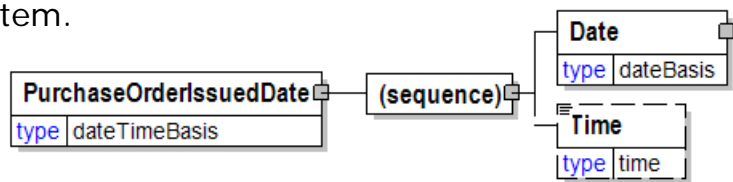

Date

Date is mandatory. A single instance is required.

A group element that contains the specification of Year, Month, and Day.

Time

Time is optional. A single instance might exist.

Times are treated in a standard XML fashion with a special case used to indicate a generalized "local" time. The standard XML approach to time is hh:mm:ss, hh:mm:ssZ, or hh:mm:ss±hh:mm.

hh:mm:ss±hh:mm is used to represent a time with a time zone. The time zone is communicated as the number of hours offset from the Universal Time Coordinate (UTC), a.k.a. Greenwich Mean Time.

hh:mm:ssZ indicates the time at Zulu (another name for UTC). Based on the convention described in the next bullet it will be important for users within UTC to use "Z" when communicating a time in their time zone to other users.

hh:mm:ss or hh:mm indicates in the XML standard the time at UTC however, within papiNet it is used to represent the applicable local time. Caution should be used when processing times of this nature as the papiNet approach may be in discord with other users of XML.

PurchaseOrderLineItem

PurchaseOrderLineItem is a required, multiple instances element.

PurchaseOrderLineItemStatusType [attribute]

PurchaseOrderLineItemStatusType is mandatory. A single instance is required.

Defines the status of the PurchaseOrder line item
Refer to PurchaseOrderLineItemStatusType definition for any enumerations.

PurchaseOrderLineItemDocumentStatus [attribute]

PurchaseOrderLineItemDocumentStatus is optional. A single instance might exist.

Defines the actual document status for the PurchaseOrderLineItem.

Refer to PurchaseOrderLineItemDocumentStatus definition for any enumerations.

Billable [attribute]

Billable is optional. A single instance might exist.
Either "Yes" or "No".

Refer to Billable definition for any enumerations.

(sequence)

The sequence of items below is mandatory. A single instance is required.

PurchaseOrderLineItemNumber

PurchaseOrderLineItemNumber is mandatory. A single instance is required.

The sequential number that uniquely identifies the PurchaseOrder line item.

PurchaseOrderReference

PurchaseOrderReference is optional. Multiple instances might exist.

An item detailing relevant references (such as contract number) pertaining to the PurchaseOrder. The type of reference is identified by the PurchaseOrderReferenceType attribute.

Product

Product is mandatory. A single instance is required.

Product is a group item defining the article and its characteristics. Product is used to specify product characteristics organized by ProductIdentifier, ProductDescription, and Classification. Book Manufacturing, Label Stock, Paper,

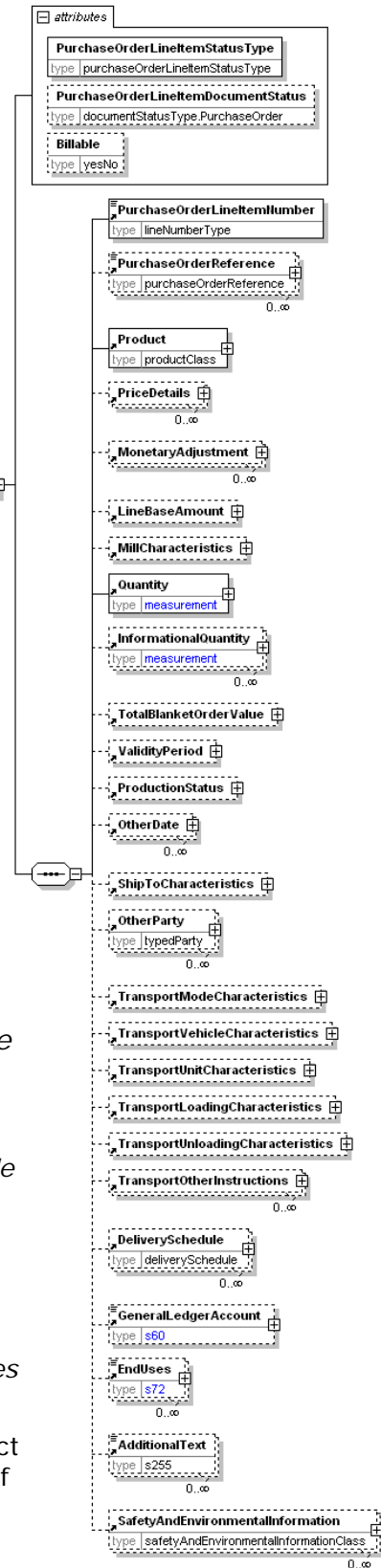

Pulp, Recovered Paper, Wood Products, and Virgin Fibre market segments have defined their product characteristics and conversion features for implementation in papiNet.

PriceDetails

PriceDetails is optional. Multiple instances might exist.

An element that groups together price information.

MonetaryAdjustment

MonetaryAdjustment is optional. Multiple instances might exist.

The element containing the information necessary for the understanding, calculation, and treatment of an adjustment to a currency amount. MonetaryAdjustment contains an attribute that indicates the type of adjustment being communicated.

LineBaseAmount

LineBaseAmount is optional. A single instance might exist.

For the particular e-Document being communicated the LineBaseAmount represents the quantity times the base unit price.

MillCharacteristics

MillCharacteristics is optional. A single instance might exist.

A group item defining the mill party and machine identifier where a product is or was produced.

Quantity

Quantity is mandatory. A single instance is required.

The Quantity element contains attributes that provide information about the type of quantity that is being communicated, the context in which the particular quantity is to be viewed, and (if the quantity represents an adjustment) an adjustment type.

The Quantity element contains three child elements that enable you to communicate a range of values for the quantity and a target or actual value. It is at this level (Value, RangeMin, and RangeMax) that the unit of measure is specified. This permits the range to be specified in a different unit of measure than the target.

InformationalQuantity

InformationalQuantity is optional. Multiple instances might exist.

A quantity given in a valid UOM used for information purposes only (not for calculation). For example, an ordered quantity was 100 reels as opposed to the invoice quantity of 20,000 pounds.

TotalBlanketOrderValue

TotalBlanketOrderValue is optional. A single instance might exist.

The authorized amount of the blanket PurchaseOrder.

ValidityPeriod

ValidityPeriod is optional. A single instance might exist.

The validity period for a specific item, e.g. the validity period for an e-Document.

ProductionStatus

ProductionStatus is optional. A single instance might exist.

A group item used to communicate the release of a delivery line number.

OtherDate

OtherDate is optional. Multiple instances might exist.

A date that may not be specifically detailed within a document (example: print date at the PurchaseOrderLineItem).

ShipToCharacteristics

ShipToCharacteristics is optional. A single instance might exist.

A group item that provides information important for the Ship-To Party.

A group item that provides information important for the Ship-To Party. ShipToCharacteristics may be referenced at both the header and line item level. The reference at the header is required and acts as a default for the value at the line level, unless overridden at the line level.

OtherParty

OtherParty is optional. Multiple instances might exist.

An organisation or business entity other than those specifically detailed within a e-Document.

TransportModeCharacteristics

TransportModeCharacteristics is optional. A single instance might exist.

A group item defining the primary mode of transport.

TransportVehicleCharacteristics

TransportVehicleCharacteristics is optional. A single instance might exist.

A group item defining the primary means of transporting the goods, such as a side port vessel. In some instances, the transport unit and vehicle are the same.

TransportUnitCharacteristics

TransportUnitCharacteristics is optional. A single instance might exist.

A group item defining and identifying the primary means of containing the goods. In some instances, the transport unit and vehicle are the same.

TransportLoadingCharacteristics

TransportLoadingCharacteristics is optional. A single instance might exist.

A group item defining how the transported items are to be loaded.

TransportUnloadingCharacteristics

TransportUnloadingCharacteristics is optional. A single instance might exist.

A group item defining how the transported items are to be unloaded.

TransportOtherInstructions

TransportOtherInstructions is optional. Multiple instances might exist.

A group item defining any other instructions for the transport not covered in the description of transport mode, vehicle, unit, and loading characteristics or defining an alternative description for the categories mentioned above.

DeliverySchedule

DeliverySchedule is optional. Multiple instances might exist.

A group item defining a series of DeliveryDateWindow(s) in which specified quantities must be delivered.

GeneralLedgerAccount

papiNet V2R31

GeneralLedgerAccount is optional. A single instance might exist.

The general ledger account to be referenced for the item.

EndUses

EndUses is optional. Multiple instances might exist.

A text element used to express in human readable form a list of applicable end uses for a product. Examples of end uses are:

Magazine
Book
Commercial print
etc

AdditionalText

AdditionalText is optional. Multiple instances might exist.

A text field that is used to communicate information not previously defined or for special instructions. To be used only for circumstances not covered by specific elements.

SafetyAndEnvironmentalInformation

SafetyAndEnvironmentalInformation is optional. Multiple instances might exist.

Name of certification type, if any, on the goods (For example, FSC, PEFC). SafetyAndEnvironmental needs a value or measurement to communicate the percentage of the product is certified (for example, 75% is certified by the indicated agency).

PurchaseOrderLineItemDocumentStatus [attribute]

Defines the actual document status for the PurchaseOrderLineItem.

This item is restricted to the following list.

<i>attribute</i>
PurchaseOrderLineItemDocumentStatus
<i>type</i> documentStatusType.PurchaseOrder

Cancelled

The supplied information of the document item is cancelled. Items that have been cancelled are not included in totals on the summary level of e- Documents.

Requested

The supplied information of the document item is ordered.

PurchaseOrderLineItemNumber

The sequential number that uniquely identifies the PurchaseOrder line item.

PurchaseOrderLineItemNumber
<i>type</i> lineNumberType

PurchaseOrderLineItemStatusType [attribute]

Defines the status of the PurchaseOrder line item

This item is restricted to the following list.

Amended

The supplied information is changed.

Cancelled

The supplied information has been cancelled. Items that have been cancelled are not included in totals on the summary levels of the e-Document.

New

The supplied information is new and supplied for the first time.

NoAction

The supplied information has not been amended and thereby requires no action.

attribute	
PurchaseOrderLineItemStatusType	
type	purchaseOrderLineItemStatusType

PurchaseOrderNumber

The unique order identifier as designated by the customer.

PurchaseOrderNumber	
type	s30

PurchaseOrderReference

An item detailing relevant references (such as contract number) pertaining to the PurchaseOrder. The type of reference is identified by the

PurchaseOrderReference	
type	purchaseOrderReference

attributes	
PurchaseOrderReferenceType	
type	referenceType
AssignedBy	
type	partyType

PurchaseOrderReferenceType attribute.

PurchaseOrderReferenceType [attribute]

PurchaseOrderReferenceType is mandatory. A single instance is required.

Provides a contextual explanation of the specific reference identifier. Many items are currently prefixed by "Buyer", "Forwarder", "Manufacturer", "Mill", "Seller", "Supplier", "Warehouse", or "Vendor". Check for an existing non-prefixed version and use the non-prefixed version instead. In the (yet to be announced release date) version 3.0 the prefixed versions will be removed. Instead the attribute @AssignedBy will communicate the information previously communicated in the prefix.

Refer to PurchaseOrderReferenceType definition for any enumerations.

AssignedBy [attribute]

AssignedBy is optional. A single instance might exist.

Identifies the type of party that has assigned the associated item, e.g. a

reference of type OrderNumber.

Refer to AssignedBy for any enumerations.

PurchaseOrderReferenceType [attribute]

Provides a contextual explanation of the specific reference identifier. Many items are currently prefixed by "Buyer", "Forwarder", "Manufacturer", "Mill", "Seller", "Supplier", "Warehouse", or "Vendor". Check for an existing non-prefixed version and use the non-prefixed version instead. In the (yet to be announced release date) version 3.0 the prefixed versions will be removed. Instead the attribute @AssignedBy will communicate the information previously communicated in the prefix.

Refer to the [referenceType](#) entry for the list of enumerations and their definitions.

attribute
PurchaseOrderReferenceType
type referenceType

PurchaseOrderReleaseNumber

The version or release of the PurchaseOrder.

PurchaseOrderReleaseNumber
type s30

PurchaseOrderStatusType [attribute]

Defines the status of the entire PurchaseOrder e-Document, in other words, at the root level

This item is restricted to the following list.

Amended

The supplied information is changed.

Cancelled

The supplied information has been cancelled. Items that have been cancelled are not included in totals on the summary levels of the e-Document.

Original

The supplied information is the first version of that information.

attribute
PurchaseOrderStatusType
type purchaseOrderStatusType

PurchaseOrderSummary

PurchaseOrderSummary is required and single instance

(sequence)

The sequence of items below is mandatory. A single instance is required.

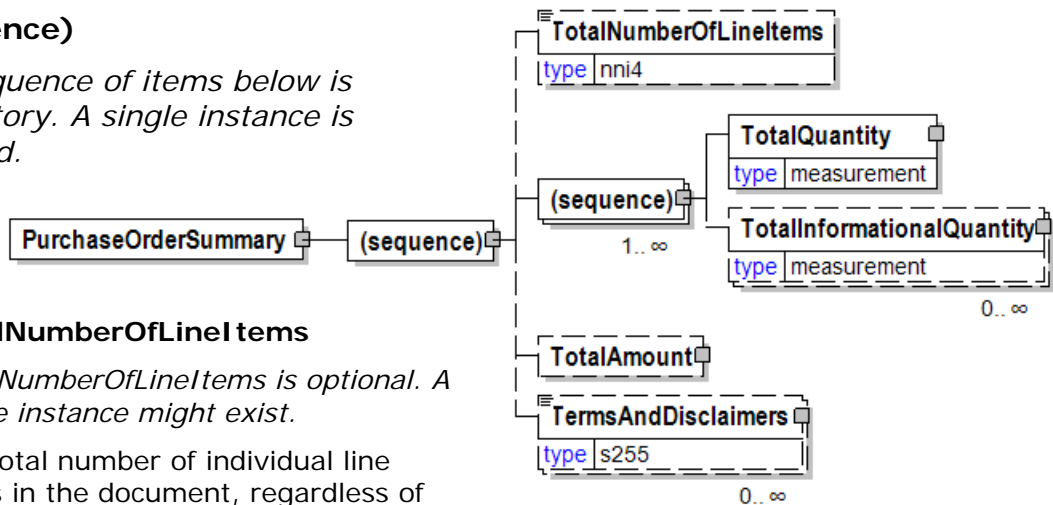

TotalNumberOfLineItems

TotalNumberOfLineItems is optional. A single instance might exist.

The total number of individual line items in the document, regardless of the status or type.

(sequence)

The sequence of items below is mandatory. One instance is required, multiple instances might exist.

TotalQuantity

TotalQuantity is mandatory. A single instance is required.

The total quantity of similar items in the e-Document. TotalQuantity is primarily used in the summary section of documents where it is repeatable to permit totaling for different units of measure.

TotalInformationalQuantity

TotalInformationalQuantity is optional. Multiple instances might exist.

A quantity that is used to communicate related information about the parent element. This element represents a total that is derived from individual line items.

TotalAmount

TotalAmount is optional. A single instance might exist.

The total amount including tax.

In e-Documents claiming payment this is the amount due for payment based on the terms of payment. Decimal rounding might be applied to this amount.

TermsAndDisclaimers

TermsAndDisclaimers is optional. Multiple instances might exist.

An element that contains legal information with an indication of what the Language is.

PurchaseOrderType [attribute]

Defines the type of PurchaseOrder issued.

This item is restricted to the following list.

BlanketOrder

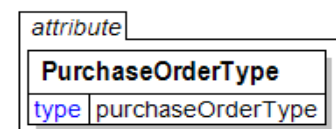

An order that communicates the same information as a StandardOrder but also indicates that the order may be completed over a period of time or, until a certain volume is achieved or, until a certain currency amount is spent.

ConfirmingOrder

A confirming order is used to electronically confirm an order that has not been placed electronically by the customer that is, it was placed using another means such as fax, phone or email.

ConsumptionOrder

A PurchaseOrder that is based upon consumption for a particular period of time or instance.

ReleaseOrder

A release order is used to release a product to be made. This type of order refers to a previous order or agreement, such as a reservation order, a contract, or a blanket order. A release number version which is an incremented number, is used in this type.

ReservationOrder

A reservation order is used to book a paper supplier's capacity for specific quantities of specific products, but it is not yet a firm commitment to buy. Consequently, all line items of a reservation order have a ProductionStatusType of NotFree. To release one or more PurchaseOrder line items of a reservation order, a buyer can use a standard order or a release order.

StandardOrder

A standard order is a regular one-time order. It defines quantities for one or more products to be purchased and may also define a delivery location and date. A standard order may reference a previous agreement (for example, a quotation, a contract, or a reservation order) for information.

TrialOrder

A trial order is used whenever a seller has agreed to have a buyer sample a product. The seller needs to process this order differently from other orders, because a trial order may include a product sold at a discounted rate or even provided for free. A trial order typically is for small quantities.

PurchaseOrderWood

The PurchaseOrderWood element is the root element for the PurchaseOrderWood e-Document.

A PurchaseOrderWood e-Document is set up between a buyer and a seller. In some cases an agent acts on behalf of the seller or the buyer when setting up the contract.

However, the contract is not valid until signed by the buyer and the seller. A PurchaseOrderWood may cover one delivery of merchandise on one occasion or cover a time period with several deliveries. This PurchaseOrderWood refers to a standardised contract form containing all legal details.

PurchaseOrderWood

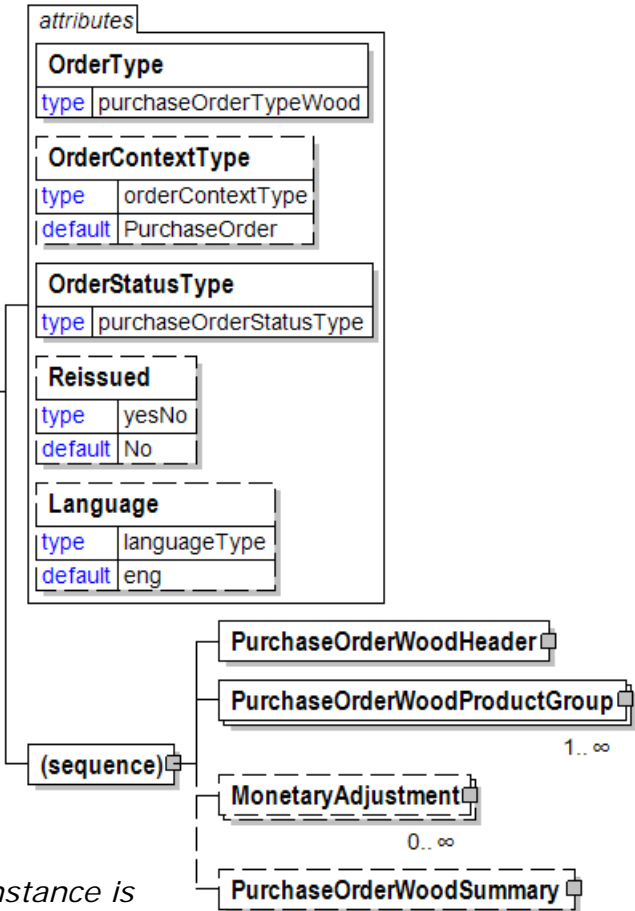

OrderType [attribute]

OrderType is mandatory. A single instance is required.

Defines the type of PurchaseOrder issued.

Refer to OrderType definition for any enumerations.

OrderContextType [attribute]

OrderContextType is optional. A single instance might exist.

Qualifies the source of the PurchaseOrder.

Refer to OrderContextType definition for any enumerations.

OrderStatusType [attribute]

OrderStatusType is mandatory. A single instance is required.

Defines the status of the entire PurchaseOrder e-Document, in other words, at the root level

Refer to OrderStatusType definition for any enumerations.

Reissued [attribute]

Reissued is optional. A single instance might exist.

Either "Yes" or "No".

Refer to Reissued definition for any enumerations.

Language [attribute]

Language is optional. A single instance might exist.

XML has embraced 2 and 3 digit language codes through the application of an addendum to the standard.

Refer to Language definition for any enumerations.

(sequence)

The sequence of items below is mandatory. A single instance is required.

PurchaseOrderWoodHeader

PurchaseOrderWoodHeader is mandatory. A single instance is required.

PurchaseOrderWood Header

PurchaseOrderWoodProductGroup

PurchaseOrderWoodProductGroup is mandatory. One instance is required, multiple instances might exist.

PurchaseOrderWoodProductGroup is a required, multiple instances element.

MonetaryAdjustment

MonetaryAdjustment is optional. Multiple instances might exist.

The element containing the information necessary for the understanding, calculation, and treatment of an adjustment to a currency amount.

MonetaryAdjustment contains an attribute that indicates the type of adjustment being communicated.

PurchaseOrderWoodSummary

PurchaseOrderWoodSummary is optional. A single instance might exist.

Summary section of PurchaseOrderWood for wood vertical.

PurchaseOrderWoodHeader

PurchaseOrderWood Header

OrderHeaderStatusType [attribute]

OrderHeaderStatusType is mandatory. A single instance is required.

Defines the status of the PurchaseOrder header

Refer to OrderHeaderStatusType definition for any enumerations.

(sequence)

The sequence of items below is mandatory. A single instance is required.

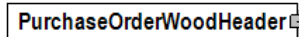

PurchaseOrderInformation

PurchaseOrderInformation is mandatory. A single instance is required.

A group item containing information unique to this PurchaseOrder, which is provided by the buyer. PurchaseOrderInformation can be optional in the supply chain. Invoices are created without having a PurchaseOrder in Vendor Managed Inventory. Freight invoices also will not have a PurchaseOrder number.

TransactionHistoryNumber

TransactionHistoryNumber is optional. A single instance might exist.

A sequential number that keeps track of the version of a document being sent by the document originator except in the case where TransactionHistoryConfirmation is used, in which case the TransactionHistoryNumber refers to the trigger transaction for which the confirmation is being sent.

OrderDocumentRequired

OrderDocumentRequired is optional. Multiple instances might exist.

Group element used to identify any external documents that need to be referenced and how many of those documents are required. Typically, used to identify hard copy documents.

This element will be deprecated in the next version of papiNet. Use the DocumentInformation element instead.

BuyerParty

BuyerParty is mandatory. A single instance is required.

The legal entity to which the product is sold. Also commonly referred to as the sold-to party or customer. If no OtherParty is defined as the Payer, the Buyer is the Payer.

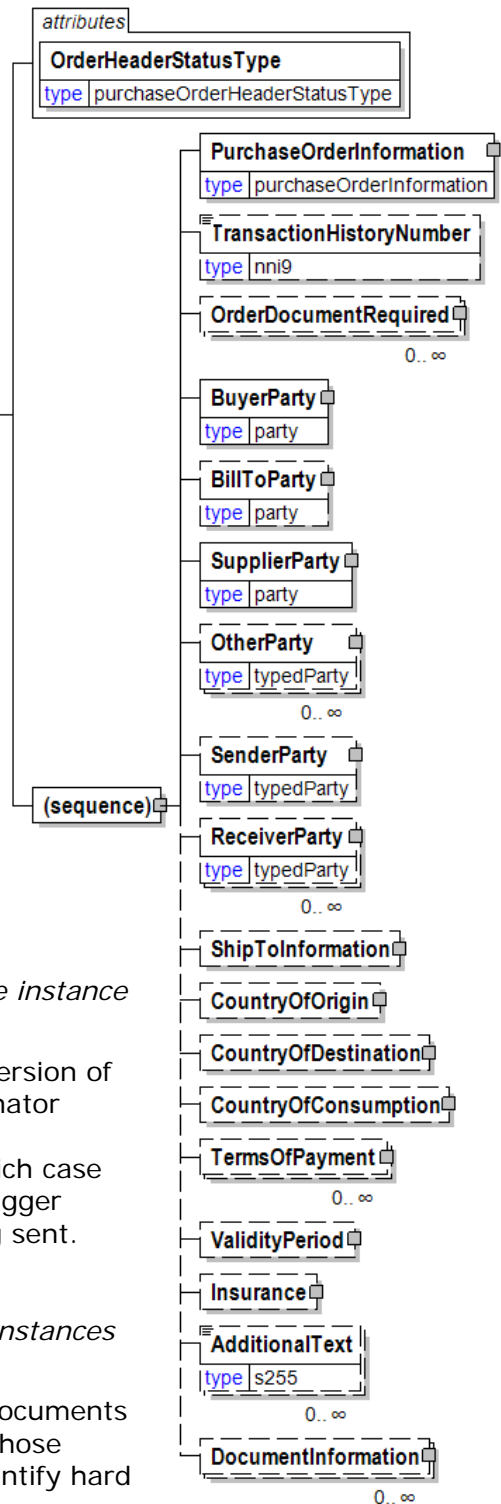

BillToParty

BillToParty is optional. A single instance might exist.

The address where the invoice is to be sent.

SupplierParty

SupplierParty is mandatory. A single instance is required.

The organisation or business entity responsible for providing the product.

SupplierParty is also the seller of the product, if Seller is not specified as OtherParty = Seller.

OtherParty

OtherParty is optional. Multiple instances might exist.

An organisation or business entity other than those specifically detailed within a e-Document.

SenderParty

SenderParty is optional. A single instance might exist.

The business entity issuing the e-Document, the source of the document.

The entity responsible for the content. If the sender party has out sourced the message service to a third party the SenderParty is the issuer of the e-Document and not the party performing the transmission service of the electronic message.

ReceiverParty

ReceiverParty is optional. Multiple instances might exist.

The business entity for whom the e-Document is intended, the destination of the document.

The entity interested in the content. If the receiver party has outsourced the message service to a third party the ReceiverParty is the intended party for the e-Document and not the party performing the receiving service of the electronic message.

ShipToInformation

ShipToInformation is optional. A single instance might exist.

Group element containing information about the ship to and delivery of a product.

CountryOfOrigin

CountryOfOrigin is optional. A single instance might exist.

The country of origin for the material.

CountryOfDestination

CountryOfDestination is optional. A single instance might exist.

The country where the goods will be, or were, shipped to.

CountryOfConsumption

CountryOfConsumption is optional. A single instance might exist.

The country of consumption for the material.

TermsOfPayment

TermsOfPayment is optional. Multiple instances might exist.

A group item that contains agreed-to terms defining when, how, and under what conditions the payment is to be made.

When TermsOfPayment is optional; if omitted, TermsOfPayment is controlled through previous negotiation.

ValidityPeriod

ValidityPeriod is optional. A single instance might exist.

The validity period for a specific item, e.g. the validity period for an e-Document.

Insurance

Insurance is optional. A single instance might exist.

Group element containing information about insurance

AdditionalText

AdditionalText is optional. Multiple instances might exist.

A text field that is used to communicate information not previously defined or for special instructions. To be used only for circumstances not covered by specific elements.

DocumentInformation

DocumentInformation is optional. Multiple instances might exist.

A group element containing a specification of required documents in the business process. Additional free text to be printed on documents can also be specified.

PurchaseOrderWoodLineItem

PurchaseOrderWood Line Item

OrderLineItemStatusType
[attribute]

OrderLineItemStatusType is mandatory. A single instance is required.

Defines the status of the PurchaseOrder line item

Refer to OrderLineItemStatusType definition for any enumerations.

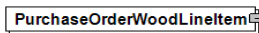

OrderLineItemDocumentStatus
[attribute]

OrderLineItemDocumentStatus is optional. A single instance might exist.

Defines the actual document status for the PurchaseOrderLineItem.

Refer to OrderLineItemDocumentStatus definition for any enumerations.

(sequence)

The sequence of items below is mandatory. A single instance is required.

PurchaseOrderLineItemNumber

PurchaseOrderLineItemNumber is mandatory. A single instance is required.

The sequential number that uniquely identifies the PurchaseOrder line item.

DocumentReferenceInformation

DocumentReferenceInformation is optional. Multiple instances might exist.

A group item containing reference information applicable to a document.

Product

Product is mandatory. A single instance is required.

Product is a group item defining the article and its characteristics. Product is used to specify product characteristics organized by ProductIdentifier, ProductDescription, and Classification. Book Manufacturing, Label Stock, Paper, Pulp, Recovered Paper, Wood Products, and Virgin Fibre market

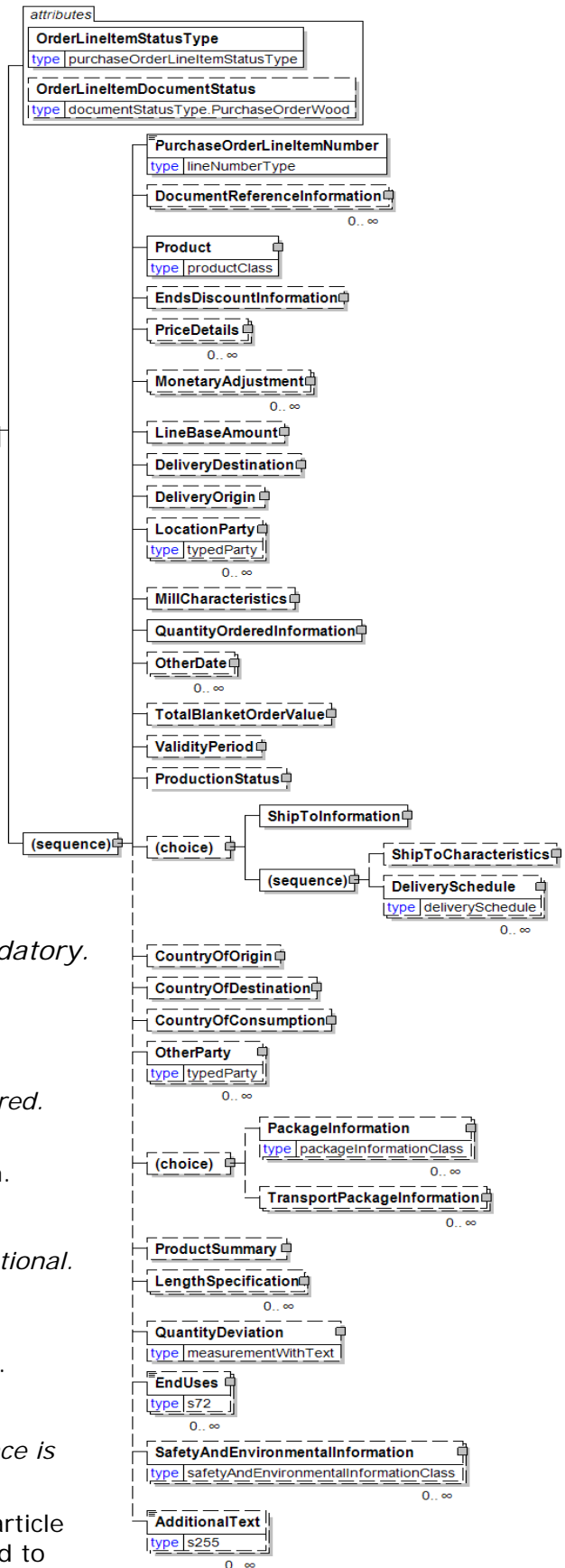

segments have defined their product characteristics and conversion features for implementation in papiNet.

EndsDiscountInformation

EndsDiscountInformation is optional. A single instance might exist.

Rule for calculating the ends discount, expressed by a code.

PriceDetails

PriceDetails is optional. Multiple instances might exist.

An element that groups together price information.

MonetaryAdjustment

MonetaryAdjustment is optional. Multiple instances might exist.

The element containing the information necessary for the understanding, calculation, and treatment of an adjustment to a currency amount. MonetaryAdjustment contains an attribute that indicates the type of adjustment being communicated.

LineBaseAmount

LineBaseAmount is optional. A single instance might exist.

For the particular e-Document being communicated the LineBaseAmount represents the quantity times the base unit price.

DeliveryDestination

DeliveryDestination is optional. A single instance might exist.

The DeliveryDestination specifies the end of one leg of the delivery. In order to comply with the US Trade Act of 2002 you would use this element with a LocationParty/@PartyType of Port.

DeliveryOrigin

DeliveryOrigin is optional. A single instance might exist.

A group item that represents the start of one leg in a route. Compare to DeliveryDestination.

The DeliveryOrigin specifies the start of one leg of the delivery.

In order to comply with the US Trade Act of 2002 you would use this element with a LocationParty/@PartyType of Port.

LocationParty

LocationParty is optional. Multiple instances might exist.

The organization or business entity where the business event took place or will take place.

MillCharacteristics

MillCharacteristics is optional. A single instance might exist.

A group item defining the mill party and machine identifier where a product is or was produced.

QuantityOrderedInformation

QuantityOrderedInformation is mandatory. A single instance is required.

Used to identify quantity. The construct provides via InformationalQuantity the ability to provide the Quantity in another UOM. Length is also provided to further specify the quantity.

OtherDate

OtherDate is optional. Multiple instances might exist.

A date that may not be specifically detailed within a document (example: print date at the PurchaseOrderLineItem).

TotalBlanketOrderValue

TotalBlanketOrderValue is optional. A single instance might exist.

The authorized amount of the blanket PurchaseOrder.

ValidityPeriod

ValidityPeriod is optional. A single instance might exist.

The validity period for a specific item, e.g. the validity period for an e-Document.

ProductionStatus

ProductionStatus is optional. A single instance might exist.

A group item used to communicate the release of a delivery line number.

(choice)

[choice] is optional because of choice construct.

ShipToInformation

ShipToInformation is optional because of choice construct.

Group element containing information about the ship to and delivery of a product.

(sequence)

The sequence of items below is mandatory. A single instance is required.

ShipToCharacteristics

ShipToCharacteristics is optional. A single instance might exist.

A group item that provides information important for the Ship-To Party.

A group item that provides information important for the Ship-To Party. ShipToCharacteristics may be referenced at both the header and line item level. The reference at the header is required and acts as a default for the value at the line level, unless overridden at the line level.

DeliverySchedule

DeliverySchedule is optional. Multiple instances might exist.

A group item defining a series of DeliveryDateWindow(s) in which specified quantities must be delivered.

CountryOfOrigin

CountryOfOrigin is optional. A single instance might exist.

The country of origin for the material.

CountryOfDestination

CountryOfDestination is optional. A single instance might exist.

The country where the goods will be, or were, shipped to.

CountryOfConsumption

CountryOfConsumption is optional. A single instance might exist.

The country of consumption for the material.

OtherParty

OtherParty is optional. Multiple instances might exist.

An organisation or business entity other than those specifically detailed within a e-Document.

(choice)

[choice] is optional because of choice construct.

PackageInformation

PackageInformation is optional because of choice construct.

The purpose of the PackageInformation structure is to clearly identify physical handling items that constitute the delivery.

PackageInformation is the highest level of product packaging it describes the shipping or warehousing unit.

If you are communicating a package, usually for logistics or transport purposes, you should include the PackageType, Identifier, ItemCount, and Quantity. (Note: you still have the ability to describe the item with one of the "named" items.)

If you are communicating one of the named Items there is no need to include PackageType, Identifier, ItemCount, and Quantity.

Since either of these two approaches can be used the entire contents of this element are optional even though the parent may be required. It is expected that you will fill in the appropriate details.

TransportPackageInformation

TransportPackageInformation is optional because of choice construct.

Information of a package used in transportation, can include several normal packages.

ProductSummary

ProductSummary is optional. A single instance might exist.

Group of elements to provide summary information on product level.

LengthSpecification

LengthSpecification is optional. Multiple instances might exist.

Length specification of the wood product.

QuantityDeviation

QuantityDeviation is optional. A single instance might exist.

To be deprecated in a future version. Use the Quantity element with a QuantityContext of "Deviation".

EndUses

EndUses is optional. Multiple instances might exist.

A text element used to express in human readable form a list of applicable end uses for a product. Examples of end uses are:

Magazine

Book

Commercial print

etc

SafetyAndEnvironmentalInformation

SafetyAndEnvironmentalInformation is optional. Multiple instances might exist.

Name of certification type, if any, on the goods (For example, FSC, PEFC). SafetyAndEnvironmental needs a value or measurement to communicate the percentage of the product is certified (for example, 75% is certified by the indicated agency).

AdditionalText

AdditionalText is optional. Multiple instances might exist.

A text field that is used to communicate information not previously defined or for special instructions. To be used only for circumstances not covered by specific elements.

PurchaseOrderWoodProductGroup

PurchaseOrderWoodProductGroup is a required, multiple instances element.

(sequence)

The

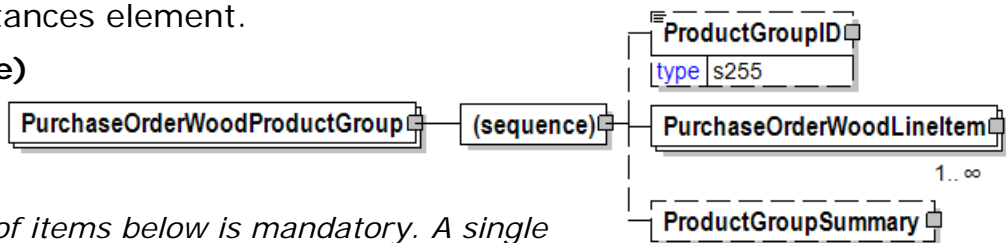

sequence of items below is mandatory. A single instance is required.

ProductGroupID

ProductGroupID is optional. A single instance might exist.

Possibility to group packages or Shipments. Example: Creating temporary group ID's for logistic reasons or lot number.

PurchaseOrderWoodLineItem

PurchaseOrderWoodLineItem is mandatory. One instance is required, multiple instances might exist.

PurchaseOrderWood Line Item

ProductGroupSummary

ProductGroupSummary is optional. A single instance might exist.

Group of elements to provide summary information on product level.

PurchaseOrderWoodSummary

Summary section of PurchaseOrderWood for wood vertical.

(sequence)

The sequence of items below is mandatory. A single instance is required.

TotalNumberOfLineItems

TotalNumberOfLineItems is optional. A single instance might exist.

The total number of individual line items in the document, regardless of the status or type.



(sequence)

The sequence of items below is optional. Multiple instances might exist.

TotalQuantity

TotalQuantity is mandatory. A single instance is required.

The total quantity of similar items in the e-Document. TotalQuantity is primarily used in the summary section of documents where it is repeatable to permit totaling for different units of measure.

TotalInformationalQuantity

TotalInformationalQuantity is optional. Multiple instances might exist.

A quantity that is used to communicate related information about the parent element. This element represents a total that is derived from individual line items.

ProductSummary

ProductSummary is optional. A single instance might exist.

Group of elements to provide summary information on product level.

LengthSpecification

LengthSpecification is optional. Multiple instances might exist.

Length specification of the wood product.

QuantityDeviation

QuantityDeviation is optional. A single instance might exist.

To be deprecated in a future version. Use the Quantity element with a QuantityContext of "Deviation".

TotalTaxAmount

TotalTaxAmount is optional. A single instance might exist.

The CurrencyValue of TotalTaxAmount contains the sum of all instances of

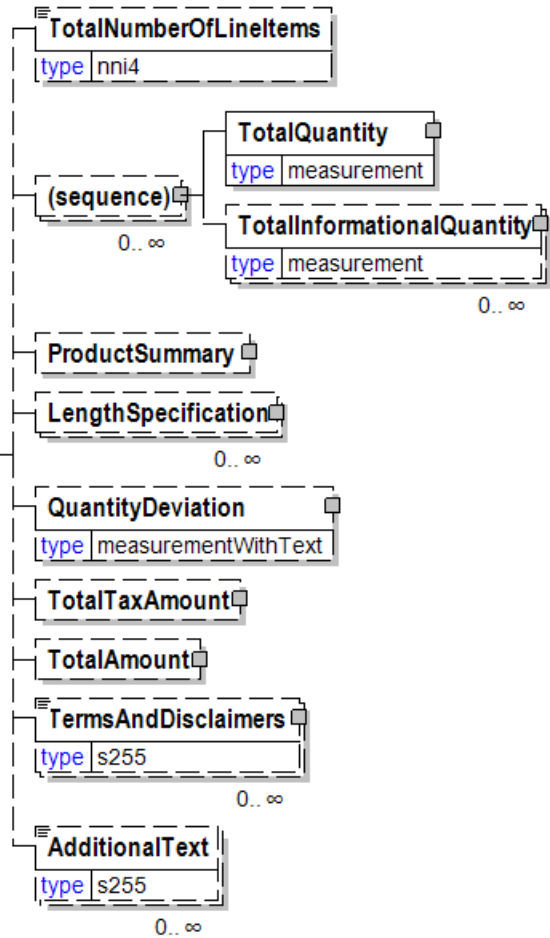

TaxAdjustment in the document. TotalTaxAmount contains the sum of all instances of the MonetaryAdjustmentAmount for tax adjustments.

TotalAmount

TotalAmount is optional. A single instance might exist.

The total amount including tax.

In e-Documents claiming payment this is the amount due for payment based on the terms of payment. Decimal rounding might be applied to this amount.

TermsAndDisclaimers

TermsAndDisclaimers is optional. Multiple instances might exist.

An element that contains legal information with an indication of what the Language is.

AdditionalText

AdditionalText is optional. Multiple instances might exist.

A text field that is used to communicate information not previously defined or for special instructions. To be used only for circumstances not covered by specific elements.

Quantity

The Quantity element contains attributes that provide information about the type of quantity that is being communicated, the context in which the particular quantity is to be viewed, and (if the quantity represents an adjustment) an adjustment type.

The Quantity element contains three child elements that enable you to communicate a range of values for the quantity and a target or actual value. It is at this level (Value, RangeMin, and RangeMax) that the unit of measure is specified. This permits the range to be specified in a different unit of measure than the target.

QuantityType [attribute]

QuantityType is mandatory. A single instance is required.

QuantityType communicates information about the type of quantity being communicated and how the receiver might use the information.

Refer to QuantityType definition for any enumerations.

QuantityTypeContext [attribute]

QuantityTypeContext is optional. A single instance might exist.

Provides the location in the value chain where the quantity is being reported.

Refer to QuantityTypeContext definition for any enumerations.

AdjustmentType [attribute]

AdjustmentType is optional. A single instance might exist.

Describes the type of adjustment associated with a quantity.

Refer to AdjustmentType definition for any enumerations.

MeasuringMethodType [attribute]

MeasuringMethodType is optional. A single instance might exist.

Specifies how a measurement value is created.

Refer to MeasuringMethodType definition for any enumerations.

MeasuringAgency [attribute]

MeasuringAgency is optional. A single instance might exist.

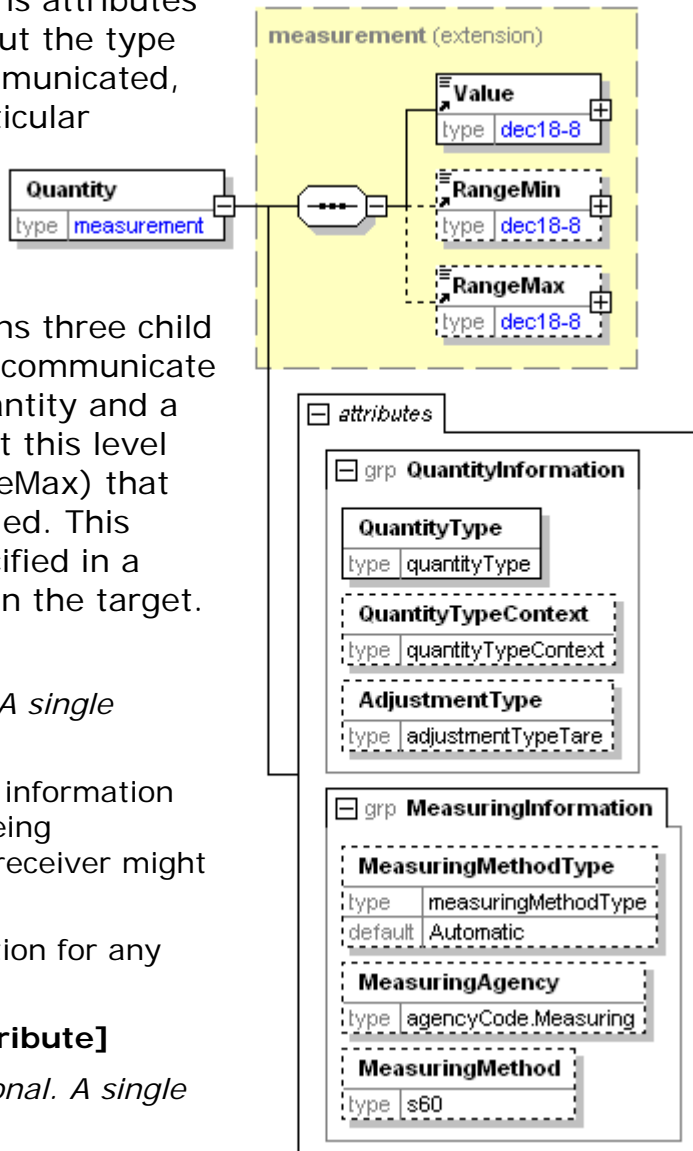

The agency defining measuring methods.

Refer to MeasuringAgency definition for any enumerations.

MeasuringMethod [attribute]

MeasuringMethod is optional. A single instance might exist.

The method used to determine how the item under consideration is measured. Measuring methods are defined by the measuring agency.

(sequence)

The sequence of items below is mandatory. A single instance is required.

Value

Value is mandatory. A single instance is required.

A numeric value expressed in the unit of measure (UOM).

RangeMin

RangeMin is optional. A single instance might exist.

The minimum value (lower boundary) allowed for the Measurement that is the parent of this element.

RangeMax

RangeMax is optional. A single instance might exist.

The maximum value (upper boundary) allowed for the Measurement that is the parent of this element. Some elements use the RangeMax element with an extended list of unit of measures. (Note: the red colour in the picture is an artifact of how the graphic was captured and should be disregarded.)

QuantityByProperty

A grouping element that contains specification of quantities per property value.

(sequence)

The sequence of items below is mandatory. A single instance is required.

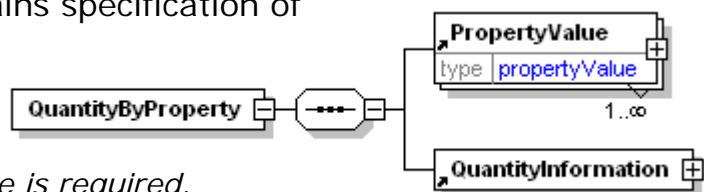

PropertyValue

PropertyValue is mandatory. Multiple instances might exist.

Specifies a value for a property of an item. The property is defined by the attribute PropertyType. The attribute MeasuringMethod and AssignedBy can be used to clarified details for a how a property is measured or calculated, e.g. Diameter for a saw log can be measured "Under Bark" or "Over Bark". The attribute MeasuringMethodType defines how the value is created, e.g. measured automatically, calculated etc. The attribute IsAverageValue indicates if the value is an average value or not.

QuantityInformation

QuantityInformation is mandatory. A single instance is required.

A group item containing information about quantity and informational quantity of similar items.

QuantityDeviation

To be deprecated in a future version. Use the Quantity element with a QuantityContext of "Deviation".

(sequence)

The sequence of items below is mandatory. A single instance is required.

Value

Value is mandatory. A single instance is required.

A numeric value expressed in the unit of measure (UOM).

RangeMin

RangeMin is optional. A single instance might exist.

The minimum value (lower boundary) allowed for the Measurement that is the parent of this element.

RangeMax

RangeMax is optional. A single instance might exist.

The maximum value (upper boundary) allowed for the Measurement that is the parent of this element. Some elements use the RangeMax element with an extended list of unit of measures. (Note: the red colour in the picture is an artifact of how the graphic was captured and should be disregarded.)

AdditionalText

AdditionalText is optional. A single instance might exist.

A text field that is used to communicate information not previously defined or for special instructions. To be used only for circumstances not covered by specific elements.

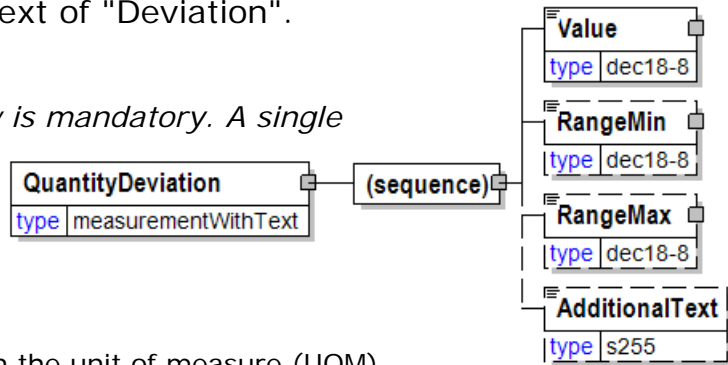

QuantityInformation

A group item containing information about quantity and informational quantity of similar items.

(sequence)

The sequence of items below is mandatory. A single instance is required.

Quantity

Quantity is mandatory. A single instance is required.

The Quantity element contains attributes that provide information about the type of quantity that is being communicated, the context in which the particular quantity is to be viewed, and (if the quantity represents an adjustment) an adjustment type.

The Quantity element contains three child elements that enable you to communicate a range of values for the quantity and a target or actual value. It is at this level (Value, RangeMin, and RangeMax) that the unit of measure is specified. This permits the range to be specified in a different unit of measure than the

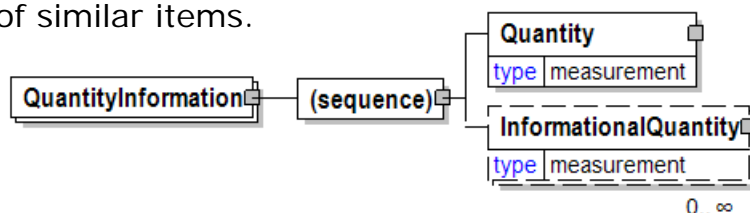

target.

InformationalQuantity

InformationalQuantity is optional. Multiple instances might exist.

A quantity given in a valid UOM used for information purposes only (not for calculation). For example, an ordered quantity was 100 reels as opposed to the invoice quantity of 20,000 pounds.

QuantityInUnit

Used to identify the number of items packed within this package unit.

(sequence)

The sequence of items below is mandatory. A single instance is required.

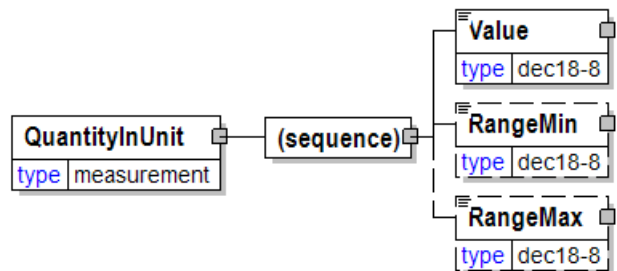

Value

Value is mandatory. A single instance is required.

A numeric value expressed in the unit of measure (UOM).

RangeMin

RangeMin is optional. A single instance might exist.

The minimum value (lower boundary) allowed for the Measurement that is the parent of this element.

RangeMax

RangeMax is optional. A single instance might exist.

The maximum value (upper boundary) allowed for the Measurement that is the parent of this element. Some elements use the RangeMax element with an extended list of unit of measures. (Note: the red colour in the picture is an artifact of how the graphic was captured and should be disregarded.)

QuantityOrderedInformation

Used to identify quantity. The construct provides via InformationalQuantity the ability to provide the Quantity in another UOM. Length is also provided to further specify the quantity.

(sequence)

The sequence of items below is mandatory. A single instance is required.

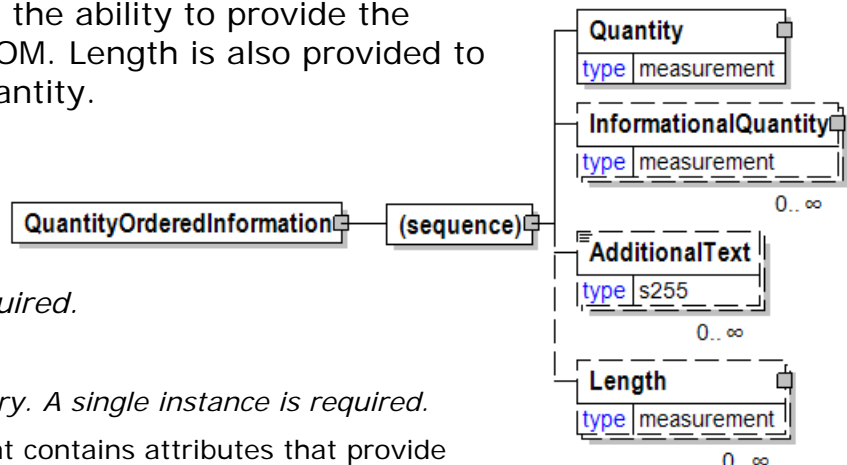

Quantity

Quantity is mandatory. A single instance is required.

The Quantity element contains attributes that provide information about the type of quantity that is being communicated, the context in which the particular

quantity is to be viewed, and (if the quantity represents an adjustment) an adjustment type.

The Quantity element contains three child elements that enable you to communicate a range of values for the quantity and a target or actual value. It is at this level (Value, RangeMin, and RangeMax) that the unit of measure is specified. This permits the range to be specified in a different unit of measure than the target.

InformationalQuantity

InformationalQuantity is optional. Multiple instances might exist.

A quantity given in a valid UOM used for information purposes only (not for calculation). For example, an ordered quantity was 100 reels as opposed to the invoice quantity of 20,000 pounds.

AdditionalText

AdditionalText is optional. Multiple instances might exist.

A text field that is used to communicate information not previously defined or for special instructions. To be used only for circumstances not covered by specific elements.

Length

Length is optional. Multiple instances might exist.

The length of the object.

QuantityType [attribute]

QuantityType communicates information about the type of quantity being communicated and how the receiver might use the information.

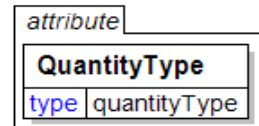

This item is restricted to the following list.

ActualVolume

Actual product space.

AirDryWeight

Contains a normal amount of moisture.

Area

A number that represents the length multiplied by the width is being communicated.

BoneDry

Contains insignificant moisture.

Count

The number of items.

Distance

The quantity being communicated is a distance.

GrossWeight

The weight including all packaging and furnishing. The gross weight of the

papiNet V2R31

deliveries is being used, includes tare weight.

Energy

The quantity represents energy content.

Length

The length of the object.

LogPileVolume

The volume of a pile of logs, including gaps.

NetWeight

The net weight of the product is being used, does not include tare weights. May include certain conversion components.

NetNetWeight

The net weight of the product without any packaging or conversion materials.

NominalWeight

A calculated weight that is derived from another measurement. For example, the length of paper multiplied by the specified basis weight could be used to derive a nominal weight.

Percent

The number being communicated is a percentage.

RunningLength

The length of the reel.

ShortLengthVolume

SolidWoodVolume

The volume of logs, stems, chips, etc. without bark and gaps.

TareWeight

The weight of the previously agreed to packaging and furnishing.

Time

The number being communicated represents an amount of time.

TippedLooseVolume

The volume of tipped loose content, including gaps. Often used as a quantity type for piles of chips, sawdust, etc.

Volume

WoodVolume

The volume of logs, stems, chips, etc. without gaps but including bark.

QuantityTypeContext [attribute]

Provides the location in the value chain where the quantity is being reported.

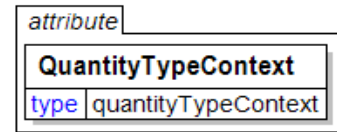

This item is restricted to the following list.

AgreedToClaimValue

A quantity that has been agreed to as a result of a claim.

Allocated

A quantity put aside, in general terms for a particular customer, process, or use. (Compare to "Reserved".)

AllowableSpoilage

Specifies the manufacturing spoilage quantity that the publisher, or other involved party, will allow.

Balance

A remaining quantity.

CalledOff

A quantity put aside to be sent to the customer on a call off.

Consumed

Consumed in manufacturing

Credited

A quantity for which a credit has been issued.

CutOff

A quantity that has been cut off.

Damaged

A quantity that has been damaged.

Delivered

Delivered to the ship-to location.

Destroyed

The product, for secure reasons, has been made unusable both for content and the actual product.

Deviation

Used to identify the deviation quantity accepted for this product.

Quantity deviation is partly an ancient/traditional thing in timber trade and refers more to sea transport than others. Quantity deviation can concern both line level quantities and total quantities. Total quantity deviation is meant to really restrict volumes to exceed ship's capacity.

Example Quantity deviations used for total quantities are:

CA./Max: for example, CA./max 1000 M3 = maximum quantity 1000 m3,
but can be -10 % less (so 900 - 1000 m3 in this case)

Min but Max: for example, min 45 max 50 m3 = volume to be between 45

and 50

Min/Max: for example, min/max 500 m³ = have to be roughly accurate 500 m³

CA: for example, CA 500 m³ = +-10 % (450 - 550 m³)

In some contracts, at the line level, it is said that product level variation can be +- 10% (at the same time we can have deviation for total quantity)

For example: You can have +-10 % volumes in line levels but total quantity must meet the following requirement - Min/Max 1000 m³.

Forecasted

A quantity that is predicted during follow-up of an existing plan. Not to be used for quantities that are derived from a planning process, please see Planned.

Freight

The quantity to be used for freight costing.

Handled

The quantity moved, e.g. in a warehouse, or otherwise handled in a logistics or material handling capacity.

Intransit

A quantity that is undergoing the transportation process and is (usually) not available for immediate use.

Invoiced

The number to be used when preparing the invoice.

Loaded

A quantity that is loaded on a transport vehicle but has not left. That is, not in-transit yet.

Measured

A quantity that has been measured by a Measuring Party.

OnHand

In available inventory at the storage location.

Ordered

A PurchaseOrder has been placed for the product.

Packed

A quantity that is prepared for storage or, transport or, some other state from which it has to be unpacked (work applied) in order to use it.

Planned

A quantity that is derived from a planning process. Not to be used for quantities predicted during follow-up of an existing plan, please see Forecasted.

Produced

The quantity added to stock through a manufacturing or conversion process.

Released

The quantity that has been authorized to be moved on to the next stage or phase in the manufacturing process or supply chain.

Reorder

A quantity that has been ordered.

ReorderPoint

A quantity on hand below which triggers a re-order.

Reserved

A quantity assigned to a specific customer order, job order, or delivery order. (Compare to "Allocated".)

Scrapped

Scrapped specifies that a product has been removed from inventory at the location where warehoused and has not been shipped to the owner.

Stored

The quantity refers to goods which have been stored in a warehouse, terminal etc.

Tested

A quantity that is analysed, e.g. the quantity of a random sample taken for measuring of product properties.

Transported

The quantity that is transported in logistics business.

Trimmed

A quantity that has been scheduled for production on a winder or a sheeter as part of the manufacturing process.

Unloaded

A quantity removed from a transport vehicle.

UnspecifiedDamage

Damage is being communicated in the element. In order to understand the type of damage the AdjustmentType will need to be considered.

ValueClaimed

A quantity that relates to the value claimed.

VendorSupplied

A quantity that is vendor supplied.

Wound

A quantity that has been placed in a reel form or otherwise put on a core.

Wrapped

A quantity that has been protectively covered in preparation for storage or shipment.

QuoteInCurrency

Indicates that the quote is to be provided in the currency specified.

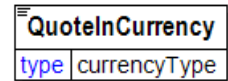

A three-character ISO 4217 currency code in capital letters. The ISO standard classification for currencies. Refer to the ISO standard for information about the choices for the attribute's enumerations.

RangeMax

The maximum value (upper boundary) allowed for the Measurement that is the parent of this element. Some elements use the RangeMax element with an extended list of unit of measures. (Note: the red colour in the picture is an artifact of how the graphic was captured and should be disregarded.)

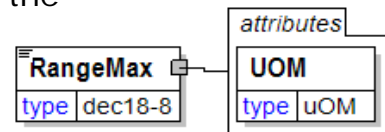

UOM [attribute]

UOM is mandatory. A single instance is required.

Defines the unit of measure for the value.

Refer to UOM definition for any enumerations.

RangeMin

The minimum value (lower boundary) allowed for the Measurement that is the parent of this element.

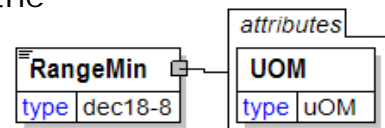

UOM [attribute]

UOM is mandatory. A single instance is required.

Defines the unit of measure for the value.

Refer to UOM definition for any enumerations.

RawMaterialSet

This identifier derived element indicates a grouping of raw materials that were used to manufacture the product.

IdentifierCodeType [attribute]

IdentifierCodeType is mandatory. A single instance is required.

Defines the type of product identifier used (for example, reel number, ream number, bar code). This code type specifies how to decode the identifier value.

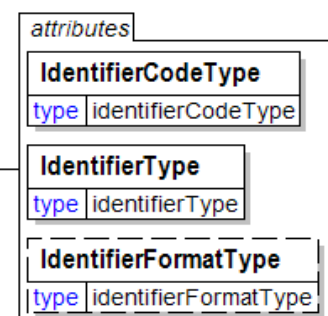
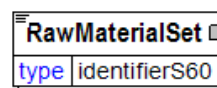

Refer to IdentifierCodeType definition for any enumerations.

IdentifierType [attribute]

IdentifierType is mandatory. A single instance is required.

This attribute specifies whether the Identifier is the primary way to identify the product or a secondary way. Only one of the given identifiers can be primary. In addition, this attribute also specifies the physical support used to code the identifier (for example, a Radio Frequency (RF) Tag).

Refer to IdentifierType definition for any enumerations.

IdentifierFormatType [attribute]

IdentifierFormatType is optional. A single instance might exist.

IdentifierFormatType defines the technical format used to make an IdentifierCodeType readable by technical devices or humans. The IdentifierCodeType specifies how to decode the identifier value

Refer to IdentifierFormatType definition for any enumerations.

ReamItem

A wrapped quantity of SheetItem(s).

(sequence)

The sequence of items below is mandatory. A single instance is required.

Identifier

Identifier is optional. Multiple instances might exist.

An Identifier is required for packages and items (pallets, reel packages, boxes, ream items, reel items, etc). The Identifier element contains the actual item identifier code. Identifier is repeatable so more than one identifier can be communicated. For example, the printed identifier on a label may be different from the barcode printed on the label.

ItemCount

ItemCount is mandatory. A single instance is required.

A count of the number of items (examples: a count of the number of boxes on a pallet or of reams in a box).

Quantity

Quantity is optional. A single instance might exist.

The Quantity element contains attributes that provide information about the type of quantity that is being communicated, the context in which the particular quantity is to be viewed, and (if the quantity represents an adjustment) an adjustment type.

The Quantity element contains three child elements that enable you to communicate a range of values for the quantity and a target or actual value. It is at

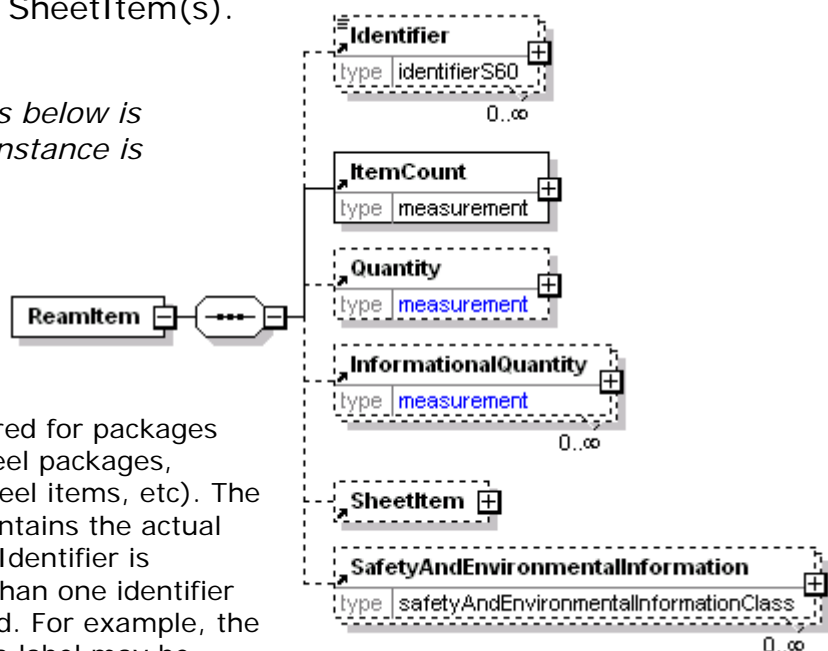

papiNet V2R31

this level (Value, RangeMin, and RangeMax) that the unit of measure is specified. This permits the range to be specified in a different unit of measure than the target.

InformationalQuantity

InformationalQuantity is optional. Multiple instances might exist.

A quantity given in a valid UOM used for information purposes only (not for calculation). For example, an ordered quantity was 100 reels as opposed to the invoice quantity of 20,000 pounds.

SheetItem

SheetItem is optional. A single instance might exist.

A group item consisting potentially of the date the sheets were converted into sheets and/or packaged or finished.

SafetyAndEnvironmentalInformation

SafetyAndEnvironmentalInformation is optional. Multiple instances might exist.

Name of certification type, if any, on the goods (For example, FSC, PEFC). SafetyAndEnvironmental needs a value or measurement to communicate the percentage of the product is certified (for example, 75% is certified by the indicated agency).

ReamType

The textual description of the method used to make up the reams..

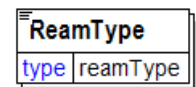

This item is restricted to the following list.

Any

Any ream type is acceptable

BoxedWithInnerReam

Boxed with inner ream

BoxedWithoutInnerReam

Boxed without inner ream

BulkPackedNonTabbed

Sheets are packed without ream wrapping and without sheet count markers.

BulkPackedTabbed

Sheets are packed without ream wrapping, but with sheet count markers at predefined intervals.

ReamWrapped

Sheets are packed ream wrapped

ReamWeight

The target weight of a ream of paper.

(sequence)

The sequence of items below is mandatory. A single instance is required.

Value

Value is mandatory. A single instance is required.

A numeric value expressed in the unit of measure (UOM).

RangeMin

RangeMin is optional. A single instance might exist.

The minimum value (lower boundary) allowed for the Measurement that is the parent of this element.

RangeMax

RangeMax is optional. A single instance might exist.

The maximum value (upper boundary) allowed for the Measurement that is the parent of this element. Some elements use the RangeMax element with an extended list of unit of measures. (Note: the red colour in the picture is an artifact of how the graphic was captured and should be disregarded.)

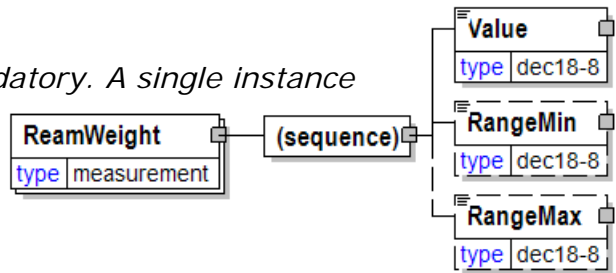

ReasonCode [attribute]

Free-form text providing the Reason Code for the item. An Agency attribute may exist at the same level as this attribute to provide an indication of the nature of the text.

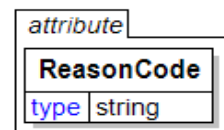

ReasonDescription

Text associated with a particular ReasonIdentifier

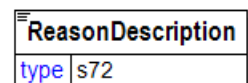

ReceiverParty

The business entity for whom the e-Document is intended, the destination of the document.

The entity interested in the content. If the receiver party has outsourced the message service to a third party the ReceiverParty is the intended party for the e-Document and not the party performing the receiving service of the electronic message.

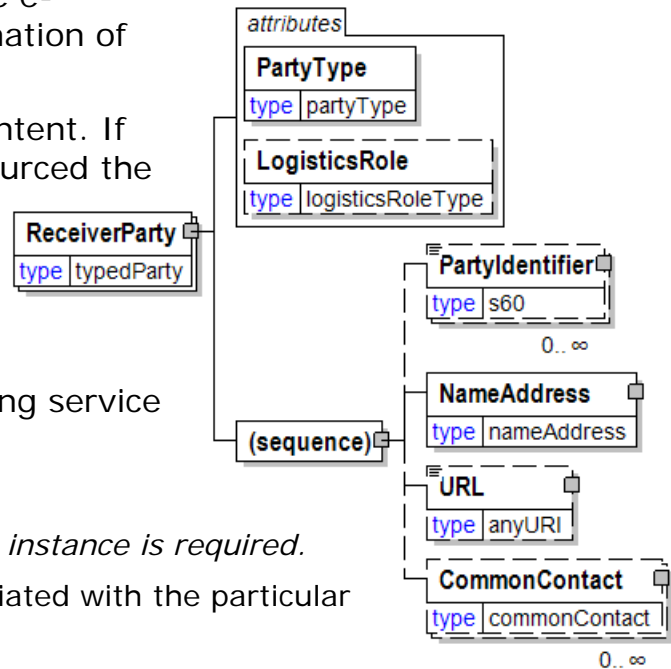

PartyType [attribute]

PartyType is mandatory. A single instance is required.

Identifies the business role associated with the particular party

Refer to PartyType definition for any enumerations.

LogisticsRole [attribute]

LogisticsRole is optional. A single instance might exist.

Communicates the nature of the logistics role, if any, the party plays in the transaction.

Refer to LogisticsRole definition for any enumerations.

(sequence)

The sequence of items below is mandatory. A single instance is required.

PartyIdentifier

PartyIdentifier is optional. Multiple instances might exist.

A unique identifier of a specific party. This element contains an attribute PartyIdentifierType that indicates the type of party.

NameAddress

NameAddress is mandatory. A single instance is required.

A group item containing name and address of an organisation or business entity.

URL

URL is optional. A single instance might exist.

Universal Resource Locator. While typically a web address you could use this field to hold an email address.

CommonContact

CommonContact is optional. Multiple instances might exist.

Identifies a specific individual associated with the party.

RecoveredPaper

A group item defining the characteristics of recycled fibre that are not dependent on a particular conversion process.

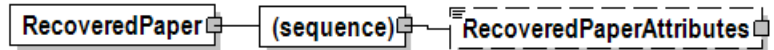

(sequence)

The sequence of items below is mandatory. A single instance is required.

RecoveredPaperAttributes

RecoveredPaperAttributes is optional. A single instance might exist.

The attributes of Recovered Paper.

RecoveredPaperAttributes

The attributes of Recovered Paper.

(sequence)

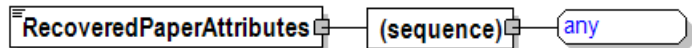

The sequence of items below is mandatory. A single instance is required.

[Any Type]

Any type of content is permitted at this point.

Recycled

A group item used to communicate the target or test value total percentage of waste fibre in the product according to a particular TestMethod.

TestMethod [attribute]

TestMethod is optional. A single instance might exist.

The method used to determine the results of the test under consideration.

TestAgency [attribute]

TestAgency is optional. A single instance might exist.

The agency that has set the parameters for the testing

Refer to TestAgency definition for any enumerations.

SampleType [attribute]

SampleType is optional. A single instance might exist.

Communicates how sampling was done to measure the product characteristics.

Refer to SampleType definition for any enumerations.

ResultSource [attribute]

ResultSource is optional. A single instance might exist.

Used to define the data source of the specified test

Refer to ResultSource definition for any enumerations.

(sequence)

The sequence of items below is mandatory. A single instance is required.

DetailValue

DetailValue is mandatory. A single instance is required.

A numeric value expressed in the unit of measure (UOM).

DetailRangeMin

DetailRangeMin is optional. A single instance might exist.

The minimum value (lower boundary) allowed for the DetailValue that is the parent of this element.

DetailRangeMax

DetailRangeMax is optional. A single instance might exist.

The maximum value (upper boundary) allowed for the DetailValue that is the parent of this element.

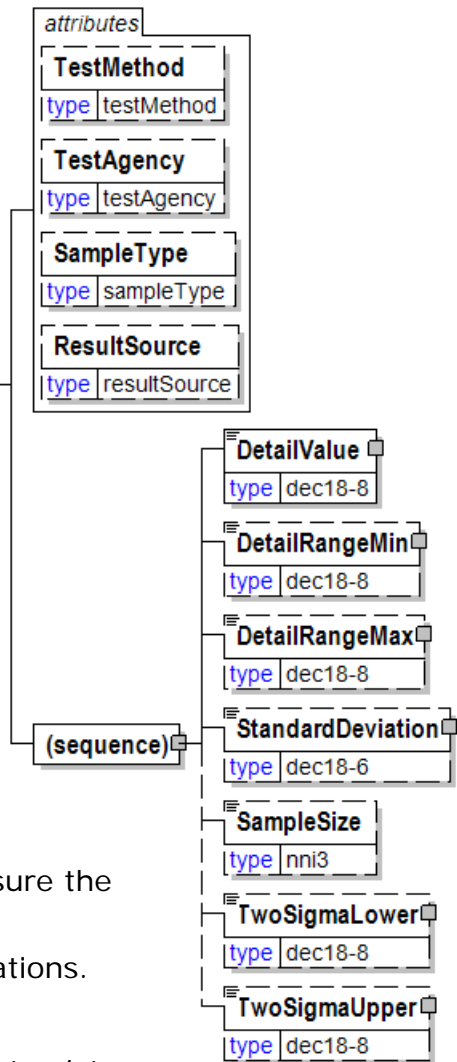
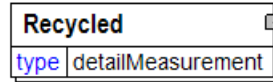

StandardDeviation

StandardDeviation is optional. A single instance might exist.

A statistic used as a measure of dispersion in a distribution.

SampleSize

SampleSize is optional. A single instance might exist.

The number of samples used to determine the product characteristic in question.

TwoSigmaLower

TwoSigmaLower is optional. A single instance might exist.

Two sigma (a measure of dispersion associated with standard deviation) on the lower side of the standard deviation.

TwoSigmaUpper

TwoSigmaUpper is optional. A single instance might exist.

Two sigma (a measure of dispersion associated with standard deviation) on the upper side of the standard deviation.

RecycledCharacteristics

RecycledCharacteristics groups together the concepts associated with recycled material.

RecycledRequired [attribute]

RecycledRequired is optional. A single instance might exist.

Indicates if Recycled Material is required

Refer to RecycledRequired definition for any enumerations.

(sequence)

The sequence of items below is mandatory. A single instance is required.

Recycled

Recycled is optional. A single instance might exist.

A group item used to communicate the target or test value total percentage of waste fibre in the product according to a particular TestMethod.

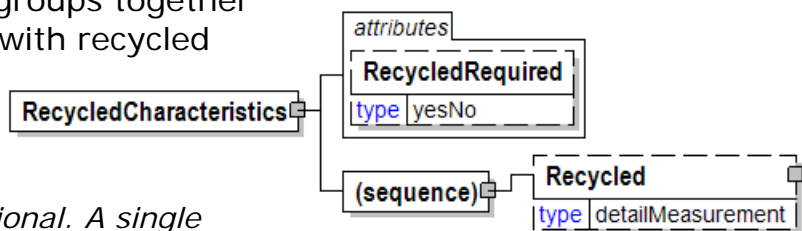

RecycledRequired [attribute]

Indicates if Recycled Material is required

This item is restricted to the following list.

Yes

No

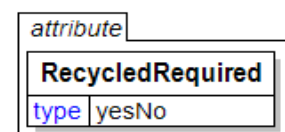

Red

The "Red" portion of the method of representing colour termed RGB.

(sequence)

The sequence of items below is mandatory. A single instance is required.

DetailValue

DetailValue is mandatory. A single instance is required.

A numeric value expressed in the unit of measure (UOM).

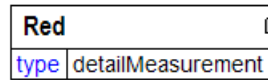

DetailRangeMin

DetailRangeMin is optional. A single instance might exist.

The minimum value (lower boundary) allowed for the DetailValue that is the parent of this element.

DetailRangeMax

DetailRangeMax is optional. A single instance might exist.

The maximum value (upper boundary) allowed for the DetailValue that is the parent of this element.

StandardDeviation

StandardDeviation is optional. A single instance might exist.

A statistic used as a measure of dispersion in a distribution.

SampleSize

SampleSize is optional. A single instance might exist.

The number of samples used to determine the product characteristic in question.

TwoSigmaLower

TwoSigmaLower is optional. A single instance might exist.

Two sigma (a measure of dispersion associated with standard deviation) on the lower side of the standard deviation.

TwoSigmaUpper

TwoSigmaUpper is optional. A single instance might exist.

Two sigma (a measure of dispersion associated with standard deviation) on the upper side of the standard deviation.

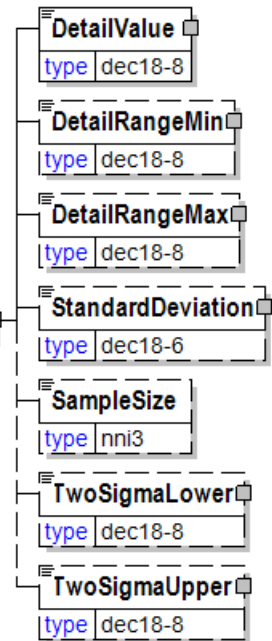

Reel

A group item that contains the conversion and packaging characteristics of a reel.

(sequence)

The sequence of items below is mandatory. A single instance is required.

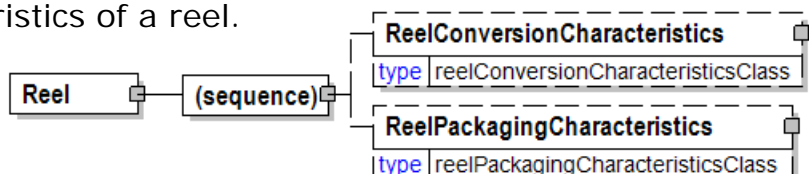

ReelConversionCharacteristics

ReelConversionCharacteristics is optional. A single instance might exist.

A group item that lists the conversion elements describing how a reel is converted from a tambour.

ReelPackagingCharacteristics

ReelPackagingCharacteristics is optional. A single instance might exist.

A group item that lists the packaging elements describing how a reel should be packed.

ReelArm

The reel arm number.

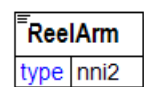

ReelBreakDiameter

The diameter of a reel at which the web break occurred. This is measured from the core to outside diameter.

(sequence)

The sequence of items below is mandatory. A single instance is required.

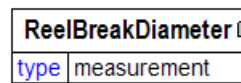

(sequence)

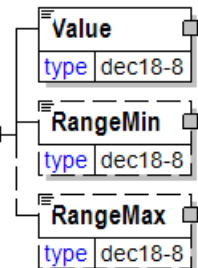

Value

Value is mandatory. A single instance is required.

A numeric value expressed in the unit of measure (UOM).

RangeMin

RangeMin is optional. A single instance might exist.

The minimum value (lower boundary) allowed for the Measurement that is the parent of this element.

RangeMax

RangeMax is optional. A single instance might exist.

The maximum value (upper boundary) allowed for the Measurement that is the parent of this element. Some elements use the RangeMax element with an extended list of unit of measures. (Note: the red colour in the picture is an artifact of how the graphic was captured and should be disregarded.)

ReelConversionCharacteristics

A group item that lists the conversion elements describing how a reel is converted from a tambour.

(sequence)

The sequence of items below is mandatory. A single instance is required.

ConversionCode

ConversionCode is optional. A single instance might exist.

A code, as assigned by an Agency, used to identify a group of conversion characteristics.

WindingDirection

WindingDirection is optional. A single instance might exist.

An element that indicates how the material is wound on the reel.

Refer to

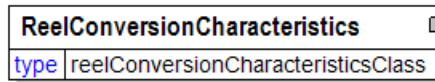

WindingDirection definition for any enumerations.

MakeTo

MakeTo is optional. A single instance might exist.

Indicates upon which constraint production should be based on (length or diameter). Specifies the basis of the finished diameter of a reel, either a Diameter specification or a Length of paper specification

Refer to MakeTo definition for any enumerations.

ReelWidth

ReelWidth is optional. Multiple instances might exist.

The width of reel from edge to edge excluding packaging.

ReelDiameter

ReelDiameter is optional. Multiple instances might exist.

The diameter measurement of reel excluding packaging.

ReelLength

ReelLength is optional. Multiple instances might exist.

The total length of the paper on the reel.

TargetProductWeight

TargetProductWeight is optional. A single instance might exist.

The desired weight of the finished product.

CoreCharacteristics

CoreCharacteristics is optional. Multiple instances might exist.

A group item that details information used to fully define a core.

Embossing

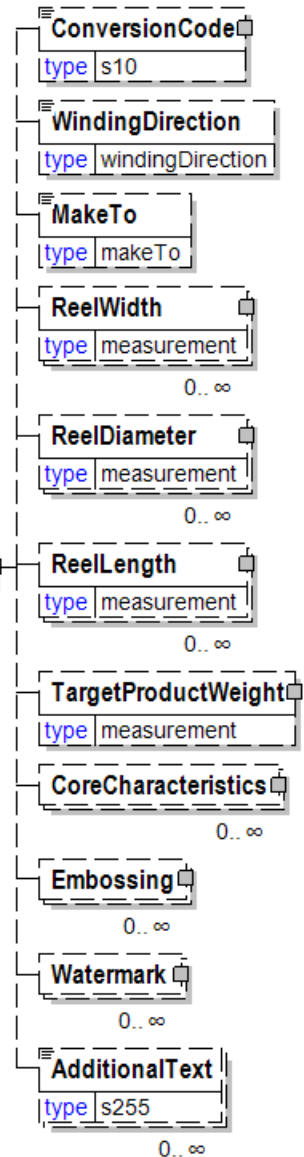

Embossing is optional. Multiple instances might exist.

Embossing requirements for sheets and reels. Embossing involves a physical deformation of the paper surface as part of the conversion process. Embossing is applied either in-line (directly after the paper machine) or off-line. Refer to the attribute FinishType for additional information.

Watermark

Watermark is optional. Multiple instances might exist.

Watermark information

AdditionalText

AdditionalText is optional. Multiple instances might exist.

A text field that is used to communicate information not previously defined or for special instructions. To be used only for circumstances not covered by specific elements.

ReelDiameter

The diameter measurement of reel excluding packaging.

(sequence)

The sequence of items below is mandatory. A single instance is required.

Value

Value is mandatory. A single instance is required.

A numeric value expressed in the unit of measure (UOM).

RangeMin

RangeMin is optional. A single instance might exist.

The minimum value (lower boundary) allowed for the Measurement that is the parent of this element.

RangeMax

RangeMax is optional. A single instance might exist.

The maximum value (upper boundary) allowed for the Measurement that is the parent of this element. Some elements use the RangeMax element with an extended list of unit of measures. (Note: the red colour in the picture is an artifact of how the graphic was captured and should be disregarded.)

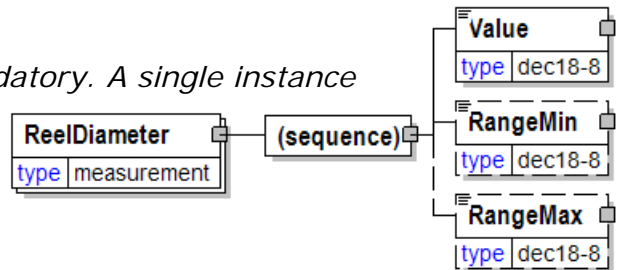

ReelItem

A group item representing details of an actual (as opposed to specified) reel. One or several reels can be contained in a package.

(sequence)

The sequence of items below is mandatory. A single instance is required.

Identifier

Identifier is mandatory. One instance is required, multiple instances might exist.

An Identifier is required for packages and items (pallets, reel packages, boxes, ream items, reel items, etc). The Identifier element contains the actual item identifier code. Identifier is repeatable so more than one identifier can be communicated. For example, the printed identifier on a label may be different from the barcode printed on the label.

(sequence)

The sequence of items below is optional. A single instance might exist.

PartyIdentifier

PartyIdentifier is mandatory. One instance is required, multiple instances might exist.

A unique identifier of a specific party. This element contains an attribute PartyIdentifierType that indicates the type of party.

MachineID

MachineID is optional. A single instance might exist.

An identifier assigned to the particular machine being referenced. For example, a machine could be a paper machine, an off-line coater, a sheeter, or a printing press. The particular machine being referenced will be determined by the business event being supported.

DeliveryMessageReelCharacteristics

DeliveryMessageReelCharacteristics is optional. A single instance might exist.

A group item for actual measurement and manufacturing characteristics. DeliveryMessageReelCharacteristics is intended to indicate the actual measurements that apply to a reel.

InventoryClass

InventoryClass is optional. A single instance might exist.

A group item containing information about status of inventory and goods items.

MillOrderNumber

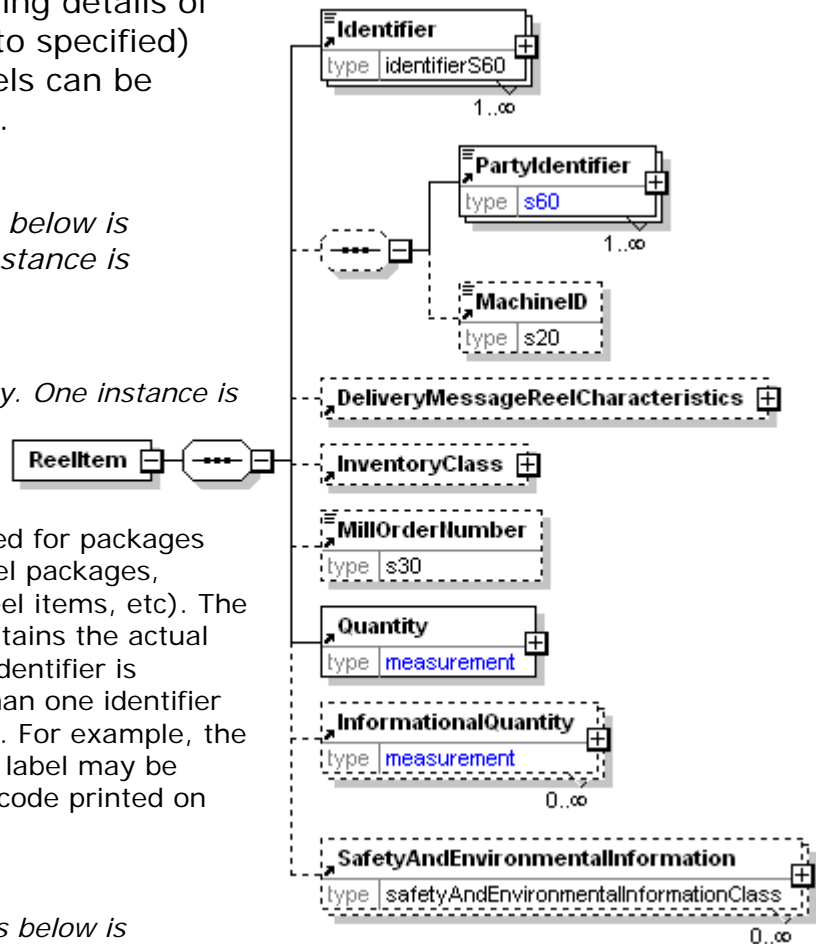

papiNet V2R31

MillOrderNumber is optional. A single instance might exist.

The manufacturing order number the mill uses.

Quantity

Quantity is mandatory. A single instance is required.

The Quantity element contains attributes that provide information about the type of quantity that is being communicated, the context in which the particular quantity is to be viewed, and (if the quantity represents an adjustment) an adjustment type.

The Quantity element contains three child elements that enable you to communicate a range of values for the quantity and a target or actual value. It is at this level (Value, RangeMin, and RangeMax) that the unit of measure is specified. This permits the range to be specified in a different unit of measure than the target.

InformationalQuantity

InformationalQuantity is optional. Multiple instances might exist.

A quantity given in a valid UOM used for information purposes only (not for calculation). For example, an ordered quantity was 100 reels as opposed to the invoice quantity of 20,000 pounds.

SafetyAndEnvironmentalInformation

SafetyAndEnvironmentalInformation is optional. Multiple instances might exist.

Name of certification type, if any, on the goods (For example, FSC, PEFC). SafetyAndEnvironmental needs a value or measurement to communicate the percentage of the product is certified (for example, 75% is certified by the indicated agency).

ReelLength

The total length of the paper on the reel.

(sequence)

The sequence of items below is mandatory. A single instance is required.

Value

Value is mandatory. A single instance is required.

A numeric value expressed in the unit of measure (UOM).

RangeMin

RangeMin is optional. A single instance might exist.

The minimum value (lower boundary) allowed for the Measurement that is the parent of this element.

RangeMax

RangeMax is optional. A single instance might exist.

The maximum value (upper boundary) allowed for the Measurement that is the parent of this element. Some elements use the RangeMax element with an extended list of unit of measures. (Note: the red colour in the picture is an artifact of how the graphic was captured and should be disregarded.)

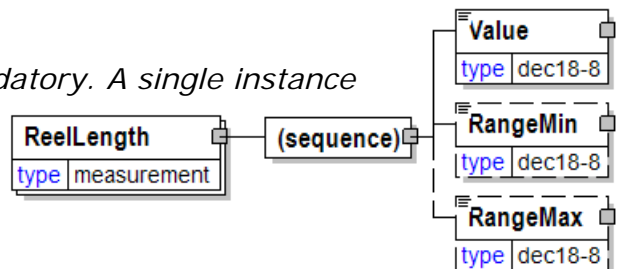

ReelPackagingCharacteristics

A group item that lists the packaging elements describing how a reel should be packed.

ActionType [attribute]

ActionType is optional. A single instance might exist.

Used to trigger an action concerning the element to which it refers.

Refer to ActionType definition for any

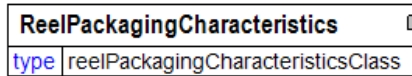

enumerations.

(sequence)

The sequence of items below is mandatory. A single instance is required.

PackagingCode

PackagingCode is optional. A single instance might exist.

PackagingCode is a code describing the packaging of the product.

PackagingDescription

PackagingDescription is optional. A single instance might exist.

A text field element describing the packaging of a product.

ReelsPerPack

ReelsPerPack is optional. A single instance might exist.

The number of reels within a package.

Wrap

Wrap is optional. Multiple instances might exist.

A group item that organises wrapping detail information.

EndCaps

EndCaps is optional. Multiple instances might exist.

A cover to protect the ends of the reel, usually circle shaped and made from Kraft paper or plywood.

CorePlugs

CorePlugs is optional. Multiple instances might exist.

An element that indicates if plugs are to be inserted into the ends of the core. Core plugs can be made of various materials and are used to protect the core ends.

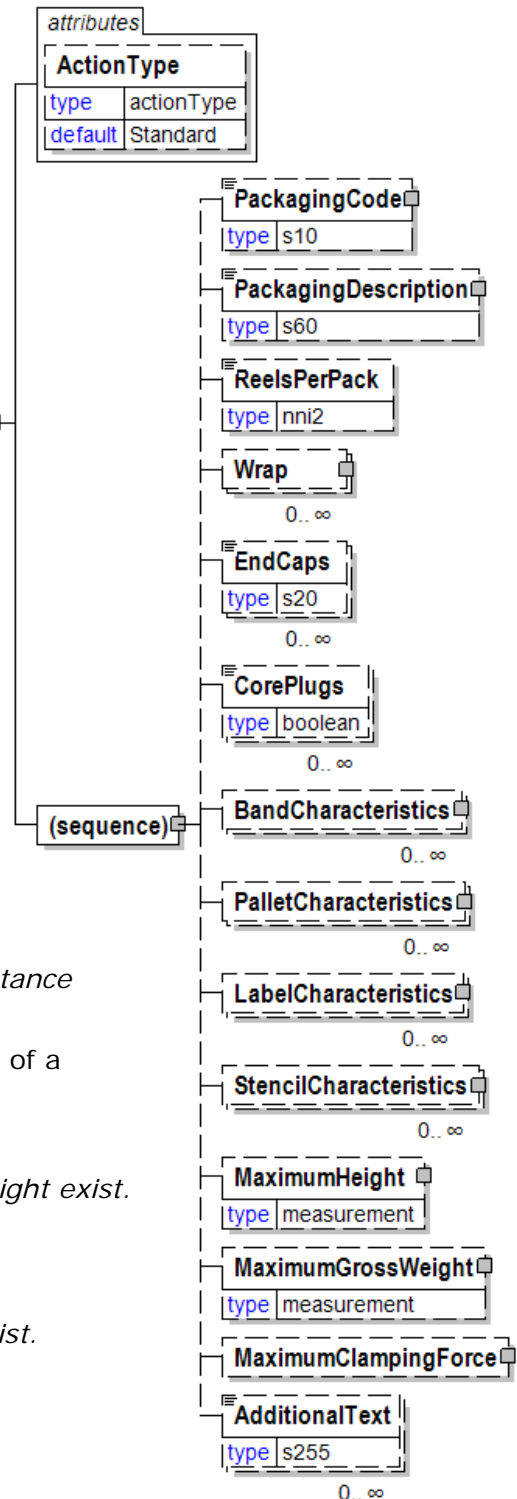

papiNet V2R31

Note: A conversion error took place between Version 1.0 of papiNet and Version 2.0 of papiNet and this item was inadvertently converted from true/false (1.0) to nni1 (2.0). this item has been reinstated to a boolean value. However, please note that for reasons of backward compatibility it is highly recommended that you use the 1/0 approach to communicating true or false where 1 = true and 0 = false. Our apologies for any issues.

BandCharacteristics

BandCharacteristics is optional. Multiple instances might exist.

A group item that organises the packaging band detail information.

PalletCharacteristics

PalletCharacteristics is optional. Multiple instances might exist.

A group item that provides pallet detail information.

LabelCharacteristics

LabelCharacteristics is optional. Multiple instances might exist.

A group item that organises the labeling information.

StencilCharacteristics

StencilCharacteristics is optional. Multiple instances might exist.

A group element specifying attributes of a stencil to be applied to an item, and optional text.

MaximumHeight

MaximumHeight is optional. A single instance might exist.

The maximum height allowed including the pallet.

MaximumGrossWeight

MaximumGrossWeight is optional. A single instance might exist.

The maximum weight allowed including the pallet.

MaximumClampingForce

MaximumClampingForce is optional. A single instance might exist.

Specifies maximum clamp force allowed during handling of an item.

AdditionalText

AdditionalText is optional. Multiple instances might exist.

A text field that is used to communicate information not previously defined or for special instructions. To be used only for circumstances not covered by specific elements.

ReelsPerPack

The number of reels within a package.

ReelsPerPack	
type	nni2

ReelStandUnit

The reelstand unit number.

ReelStandUnit	
type	s10

ReelWidth

The width of reel from edge to edge excluding packaging.

(sequence)

The sequence of items below is mandatory. A single instance is required.

Value

Value is mandatory. A single instance is required.

A numeric value expressed in the unit of measure (UOM).

RangeMin

RangeMin is optional. A single instance might exist.

The minimum value (lower boundary) allowed for the Measurement that is the parent of this element.

RangeMax

RangeMax is optional. A single instance might exist.

The maximum value (upper boundary) allowed for the Measurement that is the parent of this element. Some elements use the RangeMax element with an extended list of unit of measures. (Note: the red colour in the picture is an artifact of how the graphic was captured and should be disregarded.)

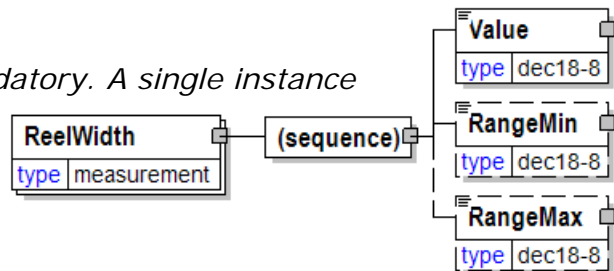

referenceType [simple type]

This entry provides the definitions for the named reference types that papiNet provides. As there are 45+ of them and they all have the same enumerations and definition, presenting a single entry serves to save space. The standard definition for all reference types and their enumerations follows.

Provides a contextual explanation of the specific reference identifier. Many items are currently prefixed by "Buyer", "Forwarder", "Manufacturer", "Mill", "Seller", "Supplier", "Warehouse", or "Vendor". Check for an existing non-prefixed version and use the non-prefixed version instead. In the (yet to be announced release date) version 3.0 the prefixed versions will be removed. Instead the attribute @AssignedBy will communicate the information previously communicated in the prefix.

This item is restricted to the following list.

AccountNumber

The unique reference number given to a financial account of the party involved in the transaction.

AudioVideoSelectionNumber

Unique number given to every audio master. Used by duplicators and replicators.

Author

Name of the author of the product or book.

BarCodedSerialNumber

The serial number in bar code form.

BillAndHoldInvoiceNumber

The invoice number used in a bill and hold arrangement.

BillOfLadingMark

Assigning party's reference mark on each package used for logistic purposes (a mark which is painted to packages just to make handling easier). Not to be confused with Bill of Lading Number.

BillOfLadingNumber

The unique reference number given to a bill of lading document given to the carrier transporting the product; the bill of lading is a legal document that lists all the products that are being transported.

BindingStyleType

BindingStyleType indicates the method used to hold the pages of the issue together. Examples are Saddle Stitch (staple through the middle fold) and Perfect Bound (glue).

BookLanguage

The language of the text of the book.

BookingNumber

The reference number used for the booking of logistics services.

BudgetCenter

An internal cost-centre identifier.

BuyerBudgetCenter

To be removed in a future version. Refer to "BudgetCenter" for the definition and use the attribute "AssignedBy" for buyer.

BuyerClaimNumber

To be removed in a future version. Refer to "ClaimNumber" for the definition and use the attribute "AssignedBy" for buyer.

BuyerDivisionIdentifier

To be removed in a future version. Refer to "DivisionIdentifier" for the definition and use the attribute "AssignedBy" for buyer.

BuyerImprint

To be removed in a future version. Refer to "Imprint" for the definition and use the attribute "AssignedBy" for buyer.

BuyerJobNumber

To be removed in a future version. Refer to "JobNumber" for the definition and use the attribute "AssignedBy" for buyer.

BuyerRetailPrice

To be removed in a future version. Refer to "RetailPrice" for the definition and use the attribute "AssignedBy" for buyer.

CallOffConfirmationLineItemNumber

The specific line item number for the CallOff confirmation.

CallOffConfirmationNumber

The unique reference number given to a CallOff confirmation.

CallOffLineItemNumber

The specific line item number for the CallOff.

CallOffNumber

The unique reference number given to a CallOff. The CallOff number of a previously sent CallOff can be referenced. For example, a seller can refer to a CallOff number in a DeliveryMessage.

CallOffReferenceNumber

A general informational reference (either textual or numeric) given to a CallOff. The CallOff reference number of a previously sent CallOff can be indicated. For example, a seller can refer to a CallOff reference number in a DeliveryMessage.

CatalogueReferenceNumber

A unique reference for a catalogue

CIMNumber

The unique reference number given to an international freight document for rail transport.

CMRNumber

The unique reference number given to an international freight document for road transport.

CoLoadingNumber

A reference to the identifier for the CoLoading communication.

ComplaintNumber

The reference number associated with a complaint.

ComplaintLineItemNumber

ComplaintResponseNumber

The reference number associated with a ComplaintResponse.

ComplaintResponseLineItemNumber

ConsigneeOrderNumber

To be removed in a future version. Refer to "OrderNumber" for the definition and use the attribute "AssignedBy" for consignee.

ContainerReference

The reference number of the container.

ContentLanguage

ContractLineNumber

A particular line number of a contract. Note: To reference a contract line number, the seller or buyer must include a clear reference to the corresponding contract elsewhere in the document.

ContractNumber

The unique reference number given to a mutual commercial/trading agreement between a buyer and a seller. The agreement can cover a quote, a bid, a contract, pricing, invoicing, and/or payment terms.

ConvertingReportNumber

An identifier used to communicate which converting report is being referred to.

Copyright

The year of publication copyright.

CorrelationReferenceNumber

A reference number used for grouping of related e-Documents or related items within e-Documents, e.g. invoice line items.

CreditAuthorizationNumber

The number of the credit authorization.

CreditDebitNoteNumber

To be removed in version V3R00. Use either CreditNoteNumber or DebitNoteNumber.

CreditNoteNumber

The number of the referenced Credit Note.

CustomerBookingNumber

To be removed in a future version. Refer to "BookingNumber" for the definition and use the attribute "AssignedBy" for customer.

CustomerJobNumber

To be removed in a future version. Refer to "JobNumber" for the definition and use the attribute "AssignedBy" for customer.

CustomerJobTitle

To be removed in a future version. Refer to "JobTitle" for the definition and use the attribute "AssignedBy" for customer.

CustomerOrderNumber

To be removed in a future version. Refer to "OrderNumber" for the definition and use the attribute "AssignedBy" for customer.

CustomerReferenceNumber

To be removed in a future version. Refer to "ReferenceNumber" for the definition and use the attribute "AssignedBy" for customer.

CustomerSpecificationNumber

To be removed in a future version. Refer to "SpecificationReferenceNumber" for the definition and use the attribute "AssignedBy" for customer.

DebitNoteNumber

The number of the referenced Debit Note.

DeliveryBookingNumber

A number use to schedule deliveries at their site.

DeliveryInstructionNumber

The unique identifier given to a DeliveryInstruction.

DeliveryInstructionSequenceNumber

The unique reference number given to a DeliveryInstruction sequence (line item).

DeliveryInstructionSequenceLineNumber

A sequential number that uniquely identifies the line item of a DeliveryInstructionSequence.

DeliveryLocation

The location to which product is to be delivered.

DeliveryMessageNumber

The identifier of the DeliveryMessage e-Document.

DeliveryMessageLineItemNumber**DeliveryNumber**

Alternate delivery number when the party uses secondary documents to manage their own system.

DepartmentIdentifier

A major division of a business.

DespatchInformationNumber**DespatchInstructionNumber**

The unique reference number of the despatch instruction document. For example the despatch instructions sent from the mill to the warehouse.

DivisionIdentifier

The internal division identifier for the party.

DropOffNumber

The identifier for the stop or location that the delivery vehicle will make.

Edition

Identifies the version of the product for which copies were printed and published at one time; For example in book manufacturing values might be 1st, 2nd, etc

EditionState

List of state abbreviations. The term "National" may also be used.

EditionSubject

Identifies the subject matter of the book.

EditionSubjectNumber

Number defined by the BISAC to codify the subject matter of the book.

EducationSubject

Identifies the subject matter of a text book (such as Math, Science, etc.).

EndCallOffDate

The last date that a call off can be placed.

FlightNumber

The reference number given to a flight number.

FormID

Identifies the Form that the reference is associated with.

FormLowFolio

An additional identifier of a Form.

FormPages

The number of pages associated with a Form's Delivery (Pages on a Signature).

FormType

Type of printed signature.

For book manufacturing, examples are: web, sheet, folded and gathered signature.

For magazine publishing examples are: Advance, Cover, or Current.

Advance denotes those pages other than Cover and Current. They are usually advertisements and other pages that are less subject to change and can be printed further in advance of the issue date.

Cover denotes the cover pages of the issue.

Current denotes those pages that are more subject to edit changes and are therefore printed closer to the issue date.

ForwarderReference

To be removed in a future version. Refer to "ReferenceNumber" for the definition and use the attribute "AssignedBy" for forwarder.

FromPurchaseOrderNumber

The PurchaseOrder that is used as the source of information.

FromSalesOrderNumber

The sales order that is used as the source of information.

FSCNumber

A certificate registration code for a site that has been certified in accordance with the requirements of the Forest Stewardship Council A.C. for delivering of FSC certified products. This number would also be communicated in the LicenceNumber element of the SafetyAndEnvironmentalInformation.

GeneralAgreement

The particular standard industry contract is being used to indicate incoterms agreements, arbitration rules, chartering, insurance, payment & freight, claims, etc.

GoodsInBillOfLadingNumber

The unique reference number given to a bill of lading number for a transport which delivered goods into a location.

GoodsInDeliveryNumber

The unique reference number given to a delivery number for a transport which delivered goods into a location.

GoodsInTransportUnitIdentifier

The reference number given to a unit identifier for a transport which delivered goods into a location.

GoodsInTransportVehicleIdentifier

The reference number given to a vehicle identifier for a transport which delivered goods into a location.

GoodsReceiptNumber

The number of the GoodsReceipt transaction that is being referred to.

GoodsReceiptLineItemNumber

The line item number of the GoodsReceipt transaction that is being referred to.

Imprint

Identifies the imprint to which this product belongs. When communicating the "publisher's imprint" use an assigned by of "Buyer".

IndentOrderNumber

A unique reference number given to an order, which is to be delivered directly to the buyer's own customer (typically a paper merchant). The reference value is passed from the buyer to the seller and the information content is meaningful only to the buyer.

InitialShipmentAdviceNumber

The unique reference number given to an initial shipment advice. The number of a previously sent initial shipment advice can be referenced. For example, a seller can refer to an initial shipment advice number in a DeliveryMmessage.

IntraStatNumber

The unique reference number given to product groups by the international authority Intrastat for statistical purposes. This number must be on the invoice when importing or exporting goods.

InventoryChangeLineItemNumber

An identifier for the InventoryChangeLineItem.

InventoryChangeNumber

The identifier for the InventoryChange.

InventoryDispositionInstructionsNumber

The unique reference number given to an InventoryDispositionInstructions.

InventoryDispositionInstructionsLineNumber

The sequential reference number given to the inventory disposition line number.

InventoryStatusLineItemNumber

An identifier that allows for unique identification of the InventoryStatusLineItem.

InventoryStatusNumber

An identifier that allows for unique identification of the InventoryStatus e-Document.

InvoiceNumber

The number associated with the Invoice.

ISBN10

10 digit ISBN code without dashes

ISBN10Dash

10 digit ISBN code with dashes

ISBN13

13 digit ISBN code.

ISBN13Dash

A 13 character ISBN with dashes; example of ISBN-13 with dashes: 978-1-873671-00-0.

ISODocumentReference

A unique ISO 9002 / 9001 document identifier.

IssueEvent

A task, or other type of event, related to the creation of an issue of a publication.

JobNumber

An identifier for a step in the production, publication, or manufacturing process. Usually a job has as its scope the amount of work performed by a defined resource (person or equipment).

JobTitle

A name of a specific job or task to which the forecast data is to apply, along with location and item.

LoadPlanNumber

A reference number given to a general unique load plan number generated in the planning phase before any physical loads exist.

LoadReleaseNumber

The identifier for the Load Release.

LoadTenderNumber

The identifier for the LoadTender b-e-Document.

LoadTenderResponseNumber**LoadingInstructionNumber**

The unique reference number given to the loading instruction.

LoadingInstructionSequenceNumber

A sequential number that uniquely identifies the sequence of a LoadingInstruction.

LoadingInstructionSequenceLineNumber

A sequential number that uniquely identifies the sequence of a LoadingInstruction.

LoadingOrderNumber

The identifier for the Loading Order.

LoadingOrderLineNumber

The line item number of the Loading Order.

LotIdentifier

A unique code used to identify a grouping of product with one set of quality statistics common to all members of that group. Synonym: Lot Number

MagazineCode

A code used to identify a magazine.

ManufacturerMaterialSafetyDataSheetNumber

To be removed in a future version. Refer to "MaterialSafetyDataSheet" for the definition and use the attribute "AssignedBy" for producer (manufacturer).

MarketType

Mass Market, Picture Books, Trade, Education, etc.

MarketplaceReferenceNumber

To be removed in a future version. Refer to "ReferenceNumber" for the definition and use the attribute "AssignedBy" for marketplace.

MasterBillOfLading

The unique reference number given to a master bill of lading document, which contains multiple bills of lading. This is a legal document given to the carrier that transports the goods to multiple customers, each of which then receive a unique bill of lading document.

MasterContractNumber

Contract number that is broader in terms of doing business between partners which for the book industry may, or may not include pricing.

MasterISBN10

Refers to the ISBN10 of a product where the product being ordered is a part

MasterISBN13

Refers to the ISBN13 of a product where the product being ordered is a part

MasterPurchaseOrder

Refers to a Buyer's PurchaseOrder Number under which separate purchase orders are generated but the master PO will never be sent to the supplier.

MaterialSafetyDataSheetNumber

A U.S. document describing the safety, environmental and physical issues, if any, for a product.

MeasuringInstructionNumber

The unique identifier of a Measuring Instruction.

MeasuringNumber

The unique identifier given to a measurement.

MeasuringTicketNumber

The unique identifier of a MeasuringTicket.

MeasuringTicketSequenceNumber

A sequential number that uniquely identifies the sequence of a MeasuringTicket.

MeasuringTicketSequenceLineItemNumber

A sequential number that uniquely identifies the line item of a MeasuringTicket sequence.

MillOrderLineItemNumber

To be removed in a future version. Refer to "OrderLineItemNumber" for the definition and use the attribute "AssignedBy" for mill.

MillOrderNumber

To be removed in a future version. Refer to "OrderNumber" for the definition and use the attribute "AssignedBy" for mill.

MillSalesOfficeNumber

To be removed in a future version. Refer to "SalesOfficeNumber" for the definition and use the attribute "AssignedBy" for mill.

MovementReferenceNumber

Movement Reference Number is given by European customs authorities. This is the reference number of the goods shipment in all European custom systems. This reference number is AssignedBy "Customs". For more information please see <http://europa.eu>

NonconformanceReportNumber

The number assigned to a non-conformance report.

OrderConfirmationNumber

The number of the OrderConfirmation that is used to identify the transaction, or portion of the transaction.

OrderConfirmationLineItemNumber

The line item on the OrderConfirmation (identified by the

OrderConfirmationNumber).

OrderNumber

The number of the order that is used to identify the transaction, or portion of the transaction.

OrderLineItemNumber

The line item on the Order (identified by OrderNumber).

OrderPartyReferenceNumber

To be removed in a future version. Refer to "ReferenceNumber" for the definition and use the attribute "AssignedBy" of "OrderParty".

OriginalComplaintResponseNumber

Reference number of the original ComplaintResponse.

OriginalDeliveryNumber

The unique reference number given to a DeliveryMessage number sent previously that has been replaced in the meantime.

OriginalGoodsReceiptNumber

The original unique identifier of the GoodsReceipt that is to be replaced.

OriginalInvoiceNumber

To be removed in version V3R00. Use InvoiceNumber.

OriginalProductQualityMessageNumber

The unique reference number given to a ProductQuality document sent previously that has been replaced in the meantime.

OriginalPurchaseOrderNumber

The unique reference number given to a PurchaseOrder document sent previously that has been replaced (through amendment or cancellation) in the meantime.

OriginalSalesOrderNumber

The unique reference number given to a sales order previously communicated that has been replaced (through amendment or cancellation) in the meantime.

OriginalScaleTicketNumber

The unique reference number given to the original ScaleTicket.

OriginalUsageNumber

The unique reference number given to a Usage e-Document previously sent that has been replaced (through amendment or cancellation) in the meantime.

PackageMark

A mark applied to packages. The package mark is mainly used for logistics purposes by grouping of packages together and making handling and storing easier.

PackageNumber

The unique reference number given to a manufacturer's product packaging designation.

PackageSpecificationNumber

The reference number given to a set of packing specifications.

PackageSpecificationLineNumber

The reference number given to one line of a set of packing specifications.

PageCount

Number of text pages in the book or component.

PageCountTotal

Total number of pages including inserts.

PaymentReferenceNumber

Payment reference number is used when paying the invoice. It associates the payment to the right invoice in an electronic payment scenario.

PEFCNumber

A certificate registration code for a site that has been certified in accordance with the requirements of the Programme for the Endorsement of Forest Certification. This number would also be communicated in the LicenceNumber element of the SafetyAndEnvironmentalInformation.

PickUpNumber

Indicates the route number for the pick-up location for a transport order.

PlanningMessageNumber

The unique reference number to a Planning e-Document that includes estimated volumes for the product being called off.

PopulationNumber

A reference number identifying a group of clearly-defined items with similar characteristics. Currently used by Forest Wood Supply for statistical Calculation adjustments.

PrepContentName

Name of the document or file that contains the content for the associated book or component

PriceContractNumber

Contract number that is specific to pricing.

PriceQuoteNumber

Quote number that is specific to pricing.

PriceList

The number used to identify the price list.

PrintingCode

Identifies the book as a New Boo, Reprint, New Adoption, etc.

PrintingNumber

A reference to the sequential print run number.

PriorPurchaseOrderNumber

The preceding PurchaseOrder number.

ProductOriginIdentifier

A reference number identifying the origin of the product. It is typically used as a tracking reference.

ProFormalInvoiceNumber

The identification number for the Pro Forma Invoice.

ProNumber

A (Progressively) sequential numbering system used to identify logistics bills. Referred to, in Europe, as Verification Number.

Example: ANC5376559

ProfitCenter

Profit center identifier

ProgramID

Identifies that the item is associated with a series. In the book manufacturing industry examples would be, "Science Series 2007, "Math Series 2009".

PromotionNumber

The sales promotion number.

PubName

The publication name.

PubNumber

The publication number.

PublisherReferenceNumber

PupilsTeachers

Description of the pupils/teachers edition specific to educational book products.

PurchaseOrderCorrelationID

Contains a reference value which is used to identify a group of purchase orders for products that are priced based on being manufactured together because of common components.

PurchaseOrderNumber

The unique reference number given to a PurchaseOrder. The PurchaseOrder number of a previously sent order can be referenced. For example, a seller can refer to a PurchaseOrder number in an Invoice.

PurchaseOrderLineItemCorrelationID

Contains a reference value which is used to identify a group of PurchaseOrder Line Items that refer to the same product.

PurchaseOrderLineItemNumber

A sequential number that uniquely identifies the PurchaseOrder line item.

PurchaseOrderReleaseNumber

The version or release of the PurchaseOrder.

QualityReportNumber

A number that uniquely identifies a quality report.

RandomSampleNumber

The unique identifier of a random sample.

ReferenceNumber

An informational reference (either textual or numeric) for which the owner or source is specified in the "@AssignedBy" attribute

ReleaseNumber

The unique identifier (either textual or numeric) given to the release of a reservation order, a contract, or a blanket order.

RetailPrice

Cover price of the finished product.

RFQLineItemNumber

The number used to identify the RFQ line item.

RFQNumber

The identifier of the RFQ. Usually provided when opening a PurchaseOrder that is derived from a request for quote (RFQ).

RunNumber

The unique reference number given to a paper-manufacturing slot on the mill production line (for example, paper machine or sheet cutter). Paper for several orders is manufactured in one run before resetting the machines for new manufacturing results.

SalesOfficeNumber

The number used to identify the sales office.

SalesOrderLineItemNumber

A number that uniquely identifies the sales order line item.

SalesOrderNumber

The unique reference number given to a sales order.

ScaleTicketNumber

The identifier for the ScaleTicket.

SchoolGrade

Grade level indicator of the book product, specific to educational text books such as grade 3. (K=Kindergarten, 1 through 12, CO=College)

SchoolGradeLevel

Further definition of the Grade level of the book product, specific to educational text books such as grade 3 level A.

SellersInvoiceNumber

To be removed in a future version. Refer to "InvoiceNumber" for the definition

and use the attribute "AssignedBy" for seller.

ServiceNumber

The product number for the service.

ShipmentStatusNumber

The unique identifier for the ShipmentStatus e-Document.

ShippingInstructionsLineItemNumber

Line number reference of the shipping instruction for book shipments.

ShippingInstructionsNumber

Sequential number of the shipping instruction.

SimplifiedCustomsNumber

A number that identifies the applicable simplified customs arrangement.

SpecificationNumber

The unique reference number given to a Specification.

SpecificationReferenceNumber

The assigning party's reference number for the specification. (The version number of the BookSpecification.)

SpecificationVersion

The identifier for the version of the specification.

StanForDForwardedProductionNumber

The identifier of the forwarded production file in the StanForD standard used by forest machines.

StanForDHarvestedProductionNumber

The identifier of the harvested production file in the StanForD standard used by forest machines.

StanForDHarvestingQualityControlNumber

The identifier of the harvesting quality control file in the StanForD standard used by forest machines.

StockOrderLineItemNumber

A number that uniquely identifies the line item of a Stock Order. The Stock Order is identified by the StockOrderNumber.

StockOrderNumber

The unique reference number given to an order, which is to be delivered to the buyer's designated stock location (typically a paper merchant). The reference value is passed from the buyer to the supplier and the information content is meaningful only to the buyer.

SupplierCallOffNumber

To be removed in a future version. Refer to "CallOffNumber" for the definition and use the attribute "AssignedBy" for supplier.

SupplierClaimNumber

To be removed in a future version. Refer to "ClaimNumber" for the definition and use the attribute "AssignedBy" for supplier.

SupplierJobNumber

To be removed in a future version. Refer to "JobNumber" for the definition and use the attribute "AssignedBy" for supplier.

SupplierReferenceNumber

To be removed in a future version. Refer to "ReferenceNumber" for the definition and use the attribute "AssignedBy" for supplier.

SupplierVoyageNumber

To be removed in a future version. Refer to "VoyageNumber" for the definition and use the attribute "AssignedBy" for supplier.

T2L

TimeTableNumber

The reference number given to a timetable.

Title

Proper title of a book product.

TitleAlias

Alternate title description for book products, usually for security purposes.

ToPurchaseOrderNumber

The destination of purchase order information.

TrackingNumber

TrackingNumber is a logistics identifier assigned to a shipment.

TransactionID

Unique system-wide identifier for a business transaction used as a source for creation of the papiNet e-Document.

TransportUnitIdentifier

The reference number given to a transport unit. The transport unit is the portion of the vehicle that is holds the goods.

TransportVehicleIdentifier

The reference number given to a vehicle used for transport.

UniversalProductIdentifier

Unique identifier for the book, component of a book product, and many other products.

UsageNumber

The number used to identify the Usage activity being referred to.

UsageLineItemNumber

The line item number used to identify the Usage activity being referred to.

VendorReferenceNumber

To be removed in a future version. Refer to "ReferenceNumber" for the

definition and use the attribute "AssignedBy" for seller.

VesselShipNotice

VoucherNumber

The unique reference number given to a document serving as evidence for some claimed transaction, e.g. as the receipt or expenditure of money.

VoyageNumber

The assigning party's unique reference number (own internal code) given to a voyage. This may or may not be the port authority's number.

WarehouseDeliveryNumber

To be removed in a future version. Refer to "DeliveryNumber" for the definition and use the attribute "AssignedBy" for warehouse.

WaybillIdentifier

Identifies the document that acknowledges receipt of the goods being shipped and specifying the terms of delivery.

Other

Used for any other reference that is not covered by this attribute list.

Reissued [attribute]

Either "Yes" or "No".

This item is restricted to the following list.

Yes

No

attribute
Reissued
type yesNo

RelativeLocation [attribute]

The relative position in the end-item where the component is to be placed.

attribute
RelativeLocation
type s60

RemitToParty

A group item containing details of the party to whom payment will be made. The RemitToParty contains all information related to remittance.

LogisticsRole [attribute]

LogisticsRole is optional. A single instance might exist.

Communicates the nature of the logistics role, if any, the party plays in the transaction.

Refer to LogisticsRole definition for any enumerations.

(sequence)

The sequence of items below is mandatory. A single instance is required.

PartyIdentifier

PartyIdentifier is optional. Multiple instances might exist.

A unique identifier of a specific party. This element contains an attribute PartyIdentifierType that indicates the type of party.

NameAddress

NameAddress is mandatory. A single instance is required.

A group item containing name and address of an organisation or business entity.

URL

URL is optional. A single instance might exist.

Universal Resource Locator. While typically a web address you could use this field to hold an email address.

CommonContact

CommonContact is optional. Multiple instances might exist.

Identifies a specific individual associated with the party.

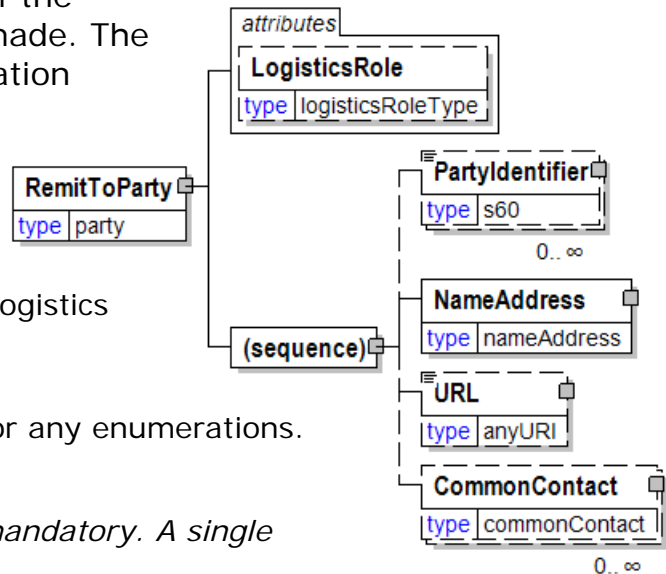

RequestedAction

The element that enables the party making the complaint (i.e. SenderParty) to specify what they want done regarding the Complaint (send a credit, send disposition instructions, etc.)

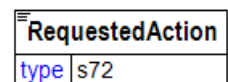

RequestingParty

The party requesting the information.

PartyType [attribute]

PartyType is mandatory. A single instance is required.

Identifies the business role associated with the particular party

Refer to PartyType definition for any enumerations.

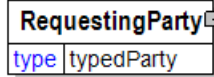

LogisticsRole [attribute]

LogisticsRole is optional. A single instance might exist.

Communicates the nature of the logistics role, if any, the party plays in the transaction.

Refer to LogisticsRole definition for any enumerations.

(sequence)

The sequence of items below is mandatory. A single instance is required.

PartyIdentifier

PartyIdentifier is optional. Multiple instances might exist.

A unique identifier of a specific party. This element contains an attribute PartyIdentifierType that indicates the type of party.

NameAddress

NameAddress is mandatory. A single instance is required.

A group item containing name and address of an organisation or business entity.

URL

URL is optional. A single instance might exist.

Universal Resource Locator. While typically a web address you could use this field to hold an email address.

CommonContact

CommonContact is optional. Multiple instances might exist.

Identifies a specific individual associated with the party.

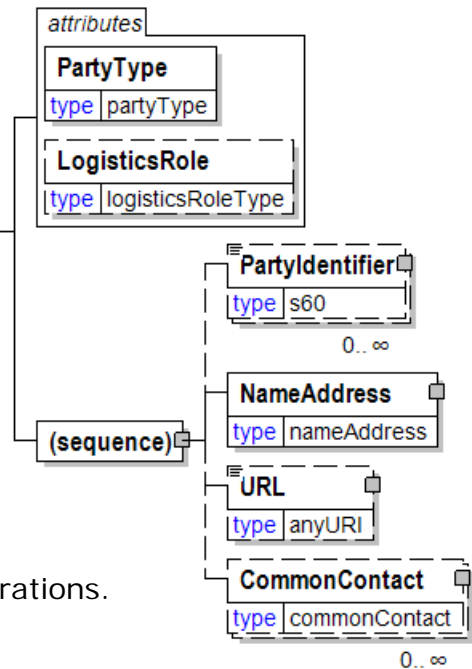

RequestNumber

A unique tracking number specifically identifying the InfoRequest e-Document to the originator. The tracking number is returned with the "information", the answer, to help match the answer to the request.

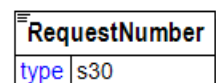

Resistance

A group item used to communicate air resistance target or test value according to a particular TestMethod.

TestMethod [attribute]

TestMethod is optional. A single instance might exist.

The method used to determine the results of the test under consideration.

TestAgency [attribute]

TestAgency is optional. A single instance might exist.

The agency that has set the parameters for the testing

Refer to TestAgency definition for any enumerations.

SampleType [attribute]

SampleType is optional. A single instance might exist.

Communicates how sampling was done to measure the product characteristics.

Refer to SampleType definition for any enumerations.

ResultSource [attribute]

ResultSource is optional. A single instance might exist.

Used to define the data source of the specified test

Refer to ResultSource definition for any enumerations.

(sequence)

The sequence of items below is mandatory. A single instance is required.

DetailValue

DetailValue is mandatory. A single instance is required.

A numeric value expressed in the unit of measure (UOM).

DetailRangeMin

DetailRangeMin is optional. A single instance might exist.

The minimum value (lower boundary) allowed for the DetailValue that is the parent of this element.

DetailRangeMax

DetailRangeMax is optional. A single instance might exist.

The maximum value (upper boundary) allowed for the DetailValue that is the parent of this element.

StandardDeviation

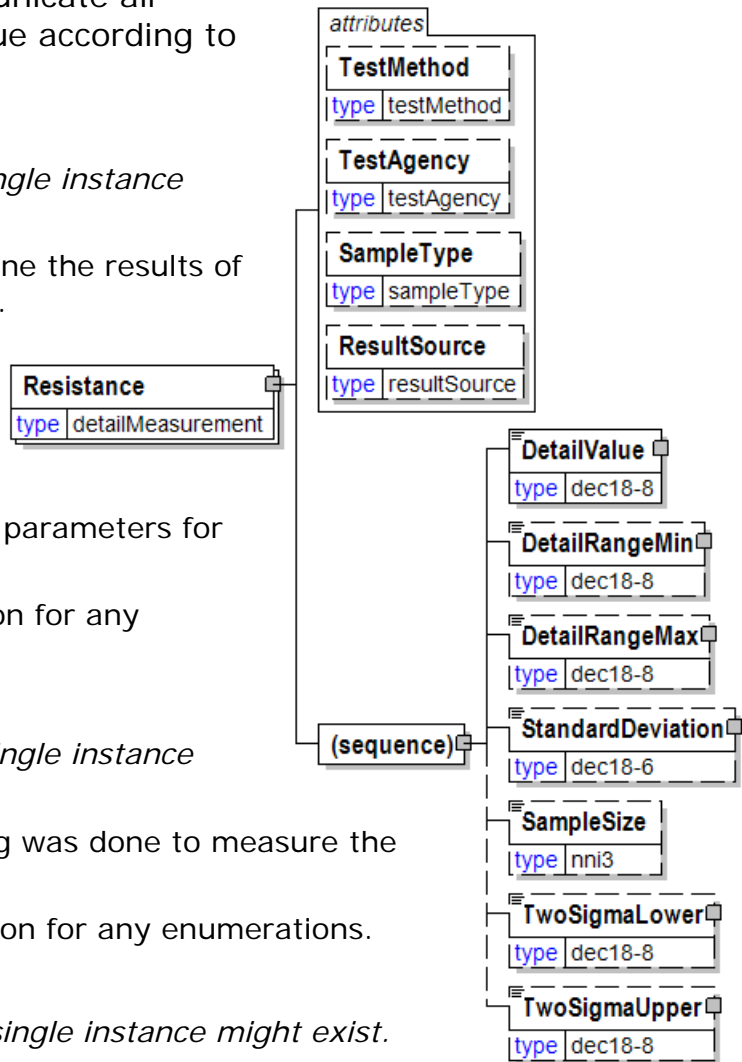

papiNet V2R31

StandardDeviation is optional. A single instance might exist.

A statistic used as a measure of dispersion in a distribution.

SampleSize

SampleSize is optional. A single instance might exist.

The number of samples used to determine the product characteristic in question.

TwoSigmaLower

TwoSigmaLower is optional. A single instance might exist.

Two sigma (a measure of dispersion associated with standard deviation) on the lower side of the standard deviation.

TwoSigmaUpper

TwoSigmaUpper is optional. A single instance might exist.

Two sigma (a measure of dispersion associated with standard deviation) on the upper side of the standard deviation.

RespondByDate

The date that a response to the query if required.

(sequence)

The sequence of items below is mandatory. A single instance is required.

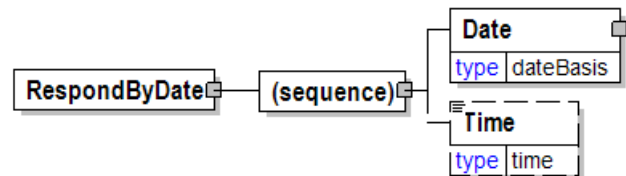

Date

Date is mandatory. A single instance is required.

A group element that contains the specification of Year, Month, and Day.

Time

Time is optional. A single instance might exist.

Times are treated in a standard XML fashion with a special case used to indicate a generalized "local" time. The standard XML approach to time is hh:mm:ss, hh:mm:ssZ, or hh:mm:ss±hh:mm.

hh:mm:ss±hh:mm is used to represent a time with a time zone. The time zone is communicated as the number of hours offset from the Universal Time Coordinate (UTC), a.k.a. Greenwich Mean Time.

hh:mm:ssZ indicates the time at Zulu (another name for UTC). Based on the convention described in the next bullet it will be important for users within UTC to use "Z" when communicating a time in their time zone to other users.

hh:mm:ss or hh:mm indicates in the XML standard the time at UTC however, within papiNet it is used to represent the applicable local time. Caution should be used when processing times of this nature as the papiNet approach may be in discord with other users of XML.

RespondToParty

The party the document should be responded to.

PartyType [attribute]

PartyType is mandatory. A single instance is required.

Identifies the business role associated with the particular party

Refer to PartyType definition for any enumerations.

LogisticsRole [attribute]

LogisticsRole is optional. A single instance might exist.

Communicates the nature of the logistics role, if any, the party plays in the transaction.

Refer to LogisticsRole definition for any enumerations.

(sequence)

The sequence of items below is mandatory. A single instance is required.

PartyIdentifier

PartyIdentifier is optional. Multiple instances might exist.

A unique identifier of a specific party. This element contains an attribute PartyIdentifierType that indicates the type of party.

NameAddress

NameAddress is mandatory. A single instance is required.

A group item containing name and address of an organisation or business entity.

URL

URL is optional. A single instance might exist.

Universal Resource Locator. While typically a web address you could use this field to hold an email address.

CommonContact

CommonContact is optional. Multiple instances might exist.

Identifies a specific individual associated with the party.

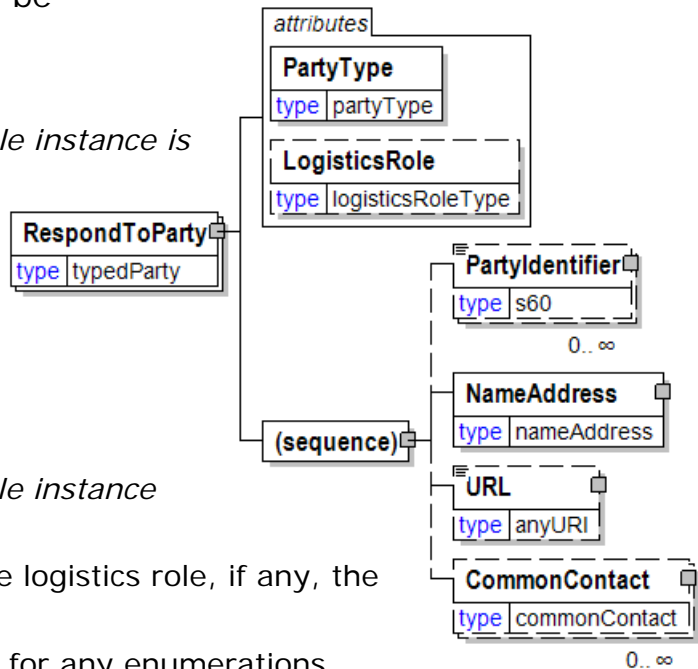

ResultSource [attribute]

Used to define the data source of the specified test

This item is restricted to the following list.

AutoLab

The data that gave rise to the value reported for this test came from an automated laboratory testing device.

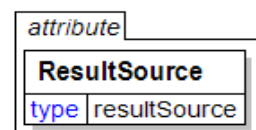

Calculated

ManualLab

The data that gave rise to the value reported for this test came from a manually performed laboratory test.

OnMachine

The data that gave rise to the value reported for this test came from an on-machine scanning device.

Predicted

The value indicated for this test is a target value and not the result of performing a paper test

ReturnReason

A group item containing the reason for the Return

ReturnType [attribute]

ReturnType is optional. A single instance might exist.

Specifies the type of return.

This item is restricted to the following list:

ReturnFromBuyer

Product was returned from the Buyer

ReturnFromShipper

Product was returned from the Shipper

ReturnFromThirdParty

Product was returned from an end user

(sequence)

The sequence of items below is mandatory. A single instance is required.

ReturnReasonCode

ReturnReasonCode is optional. A single instance might exist.

A code for quickly communicating the type of Return Reason. The Agency responsible for the code is associated with the element.

ReturnReasonDescription

ReturnReasonDescription is optional. Multiple instances might exist.

A text field element describing the reason for the Return.

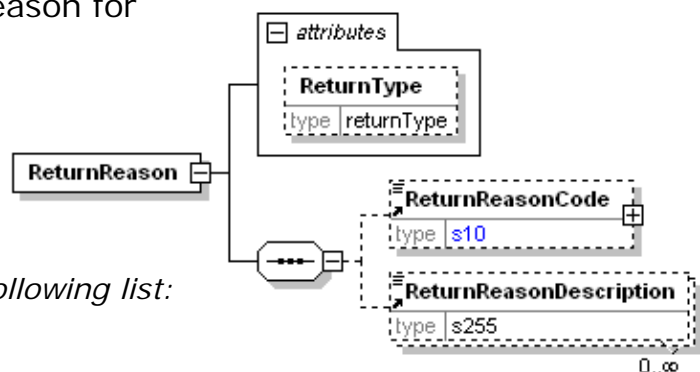

ReturnReasonCode

A code for quickly communicating the type of Return Reason. The Agency responsible for the code is associated with the element.

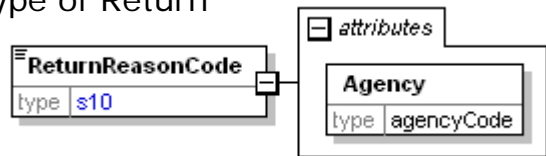

Agency [attribute]

Agency is mandatory. A single instance is required.

Describes the agency maintaining the list of codes. To be included in this list the agency must be a recognized standards body or industry organisation.

For the element that owns this attribute.

For another attribute in the list of attributes associated with the parent element.

Refer to Agency definition for any enumerations.

ReturnReasonDescription

A text field element describing the reason for the Return.

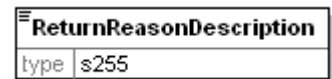

ReturnType [attribute]

Specifies the type of return.

This item is restricted to the following list.

ReturnFromBuyer

Product was returned from the Buyer

ReturnFromShipper

Product was returned from the Shipper

ReturnFromThirdParty

Product was returned from an end user

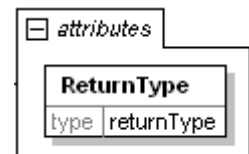

RewoundIndicator [attribute]

Is the date being communicated the the rewind date (Yes) or the date of original winding (No)?

This item is restricted to the following list.

Yes

No

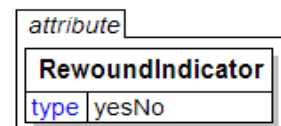

RFQ

The RFQ element is the root element for the RFQ e-Document.

A buyer sends an RFQ e-Document to a supplier to initiate a request for quotation. This e-Document, which is a request for product information, represents a request for the supplier to provide a quotation for product availability, shipping, and price.

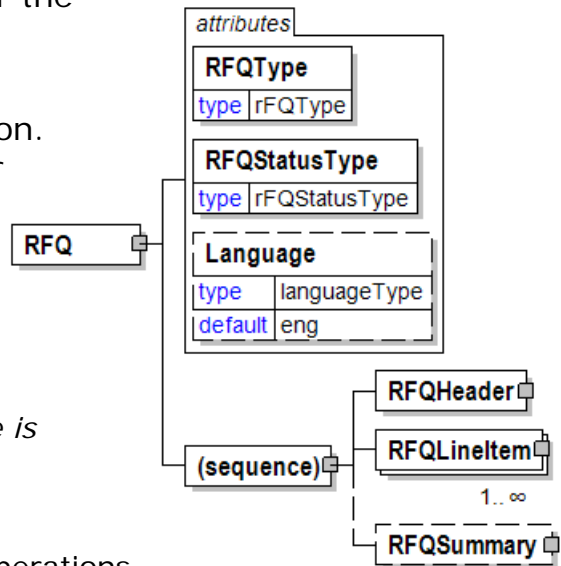

RFQType [attribute]

RFQType is mandatory. A single instance is required.

Defines the type of RFQ issued.

Refer to RFQType definition for any enumerations.

RFQStatusType [attribute]

RFQStatusType is mandatory. A single instance is required.

This attribute acts as a flag indicating what processing may be required.

Refer to RFQStatusType definition for any enumerations.

Language [attribute]

Language is optional. A single instance might exist.

XML has embraced 2 and 3 digit language codes through the application of an addendum to the standard.

Refer to Language definition for any enumerations.

(sequence)

The sequence of items below is mandatory. A single instance is required.

RFQHeader

RFQHeader is mandatory. A single instance is required.

A group item containing information applicable to the entire RFQ e-Document.

RFQLineItem

RFQLineItem is mandatory. One instance is required, multiple instances might exist.

The repetitive detail for the RFQ e-Document.

RFQSummary

RFQSummary is optional. A single instance might exist.

Summary information that applies to the RFQ e-Document.

RFQHeader

A group item containing information applicable to the entire RFQ e-Document.

RFQHeaderStatusType [attribute]

RFQHeaderStatusType is mandatory. A single instance is required.

Defines the status of the RFQ header

Refer to RFQHeaderStatusType definition for any enumerations.

(sequence)

The sequence of items below is mandatory. A single instance is required.

RFQInformation

RFQInformation is mandatory. A single instance is required.

A group item containing information unique to this RFQ which is provided by the buyer.

TransactionHistoryNumber

TransactionHistoryNumber is optional. A single instance might exist.

A sequential number that keeps track of the version of a document being sent by the document originator except in the case where TransactionHistoryConfirmation is used, in which case the TransactionHistoryNumber refers to the trigger transaction for which the confirmation is being sent.

BuyerParty

BuyerParty is mandatory. A single instance is required.

The legal entity to which the product is sold. Also commonly referred to as the sold-to party or customer. If no OtherParty is defined as the Payer, the Buyer is the Payer.

BillToParty

BillToParty is optional. A single instance might exist.

The address where the invoice is to be sent.

SupplierParty

SupplierParty is mandatory. A single instance is required.

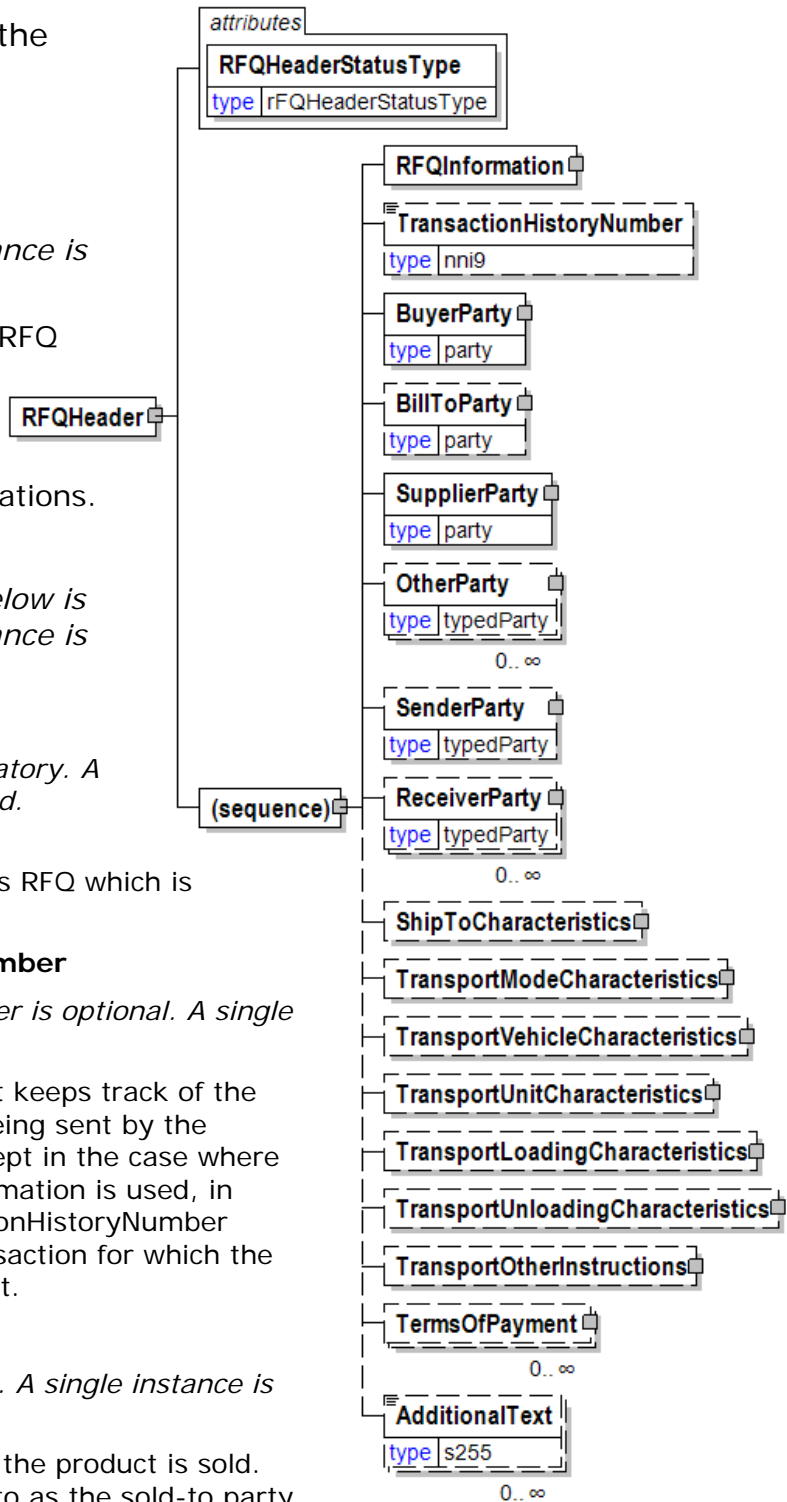

The organisation or business entity responsible for providing the product. SupplierParty is also the seller of the product, if Seller is not specified as OtherParty = Seller.

OtherParty

OtherParty is optional. Multiple instances might exist.

An organisation or business entity other than those specifically detailed within a e-Document.

SenderParty

SenderParty is optional. A single instance might exist.

The business entity issuing the e-Document, the source of the document.

The entity responsible for the content. If the sender party has out sourced the message service to a third party the SenderParty is the issuer of the e-Document and not the party performing the transmission service of the electronic message.

ReceiverParty

ReceiverParty is optional. Multiple instances might exist.

The business entity for whom the e-Document is intended, the destination of the document.

The entity interested in the content. If the receiver party has outsourced the message service to a third party the ReceiverParty is the intended party for the e-Document and not the party performing the receiving service of the electronic message.

ShipToCharacteristics

ShipToCharacteristics is optional. A single instance might exist.

A group item that provides information important for the Ship-To Party.

A group item that provides information important for the Ship-To Party. ShipToCharacteristics may be referenced at both the header and line item level. The reference at the header is required and acts as a default for the value at the line level, unless overridden at the line level.

TransportModeCharacteristics

TransportModeCharacteristics is optional. A single instance might exist.

A group item defining the primary mode of transport.

TransportVehicleCharacteristics

TransportVehicleCharacteristics is optional. A single instance might exist.

A group item defining the primary means of transporting the goods, such as a side port vessel. In some instances, the transport unit and vehicle are the same.

TransportUnitCharacteristics

TransportUnitCharacteristics is optional. A single instance might exist.

A group item defining and identifying the primary means of containing the goods. In some instances, the transport unit and vehicle are the same.

TransportLoadingCharacteristics

TransportLoadingCharacteristics is optional. A single instance might exist.

A group item defining how the transported items are to be loaded.

TransportUnloadingCharacteristics

TransportUnloadingCharacteristics is optional. A single instance might exist.

A group item defining how the transported items are to be unloaded.

TransportOtherInstructions

TransportOtherInstructions is optional. A single instance might exist.

A group item defining any other instructions for the transport not covered in the description of transport mode, vehicle, unit, and loading characteristics or defining an alternative description for the categories mentioned above.

TermsOfPayment

TermsOfPayment is optional. Multiple instances might exist.

A group item that contains agreed-to terms defining when, how, and under what conditions the payment is to be made.

When TermsOfPayment is optional; if omitted, TermsOfPayment is controlled through previous negotiation.

AdditionalText

AdditionalText is optional. Multiple instances might exist.

A text field that is used to communicate information not previously defined or for special instructions. To be used only for circumstances not covered by specific elements.

RFQHeaderStatusType [attribute]

Defines the status of the RFQ header

This item is restricted to the following list.

Accepted

The supplied information is accepted.

Amended

The supplied information is changed.

Cancelled

The supplied information has been cancelled. Items that have been cancelled are not included in totals on the summary levels of the e-Document.

New

The supplied information is new and supplied for the first time.

NoAction

The supplied information has not been amended and thereby requires no action.



RFQInformation

A group item containing information unique to this RFQ which is provided by the buyer.

(sequence)

The sequence of items below is mandatory. A single instance is required.

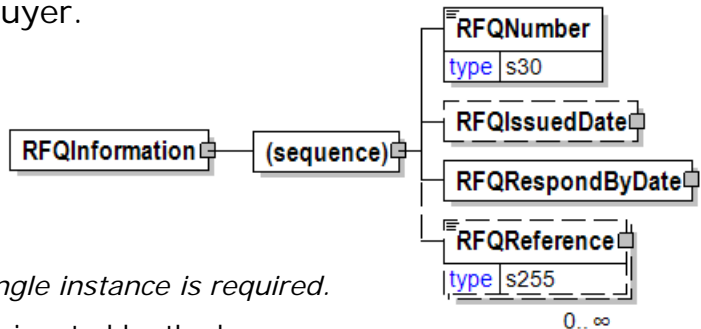

RFQNumber

RFQNumber is mandatory. A single instance is required.

The unique RFQ identifier as designated by the buyer.

RFQIssuedDate

RFQIssuedDate is optional. A single instance might exist.

The Date and Time the RFQ was issued.

RFQRespondByDate

RFQRespondByDate is mandatory. A single instance is required.

The Date and Time by which a response needs to be received by the RFQ issuer.

RFQReference

RFQReference is optional. Multiple instances might exist.

A repeatable element that details the relevant references (such as contract number) pertaining to the RFQ. The RFQReference is defined by RFQReferenceType.

RFQIssuedDate

The Date and Time the RFQ was issued.

(sequence)

The sequence of items below is mandatory. A single instance is required.

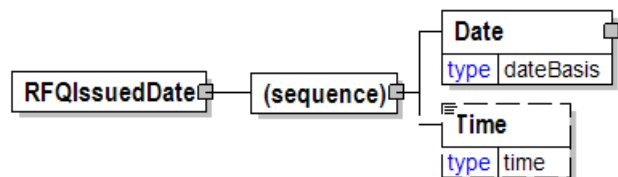

Date

Date is mandatory. A single instance is required.

A group element that contains the specification of Year, Month, and Day.

Time

Time is optional. A single instance might exist.

Times are treated in a standard XML fashion with a special case used to indicate a generalized "local" time. The standard XML approach to time is hh:mm:ss, hh:mm:ssZ, or hh:mm:ss±hh:mm.

hh:mm:ss±hh:mm is used to represent a time with a time zone. The time zone is communicated as the number of hours offset from the Universal Time Coordinate (UTC), a.k.a. Greenwich Mean Time.

hh:mm:ssZ indicates the time at Zulu (another name for UTC). Based on the convention described in the next bullet it will be important for users within UTC to use "Z" when communicating a time in their time zone to other users.

hh:mm:ss or hh:mm indicates in the XML standard the time at UTC however, within papiNet it is used to represent the applicable local time. Caution should be used when processing times of this nature as the papiNet approach may be in discord with other users of XML.

RFQLineItem

The repetitive detail for the RFQ e-Document.

RFQLineItemStatusType [attribute]

RFQLineItemStatusType is mandatory. A single instance is required.

Defines the status of the RFQ line item

Refer to RFQLineItemStatusType definition for any enumerations.

RFQLineItemDocumentStatus [attribute]

RFQLineItemDocumentStatus is optional. A single instance might exist.

Defines the actual document status for the RFQLineItem.

Refer to RFQLineItemDocumentStatus definition for any enumerations.

(sequence)

The sequence of items below is mandatory. A single instance is required.

RFQLineItemNumber

RFQLineItemNumber is mandatory. A single instance is required.

A sequential number that uniquely identifies the RFQ line item.

RFQReference

RFQReference is optional. Multiple instances might exist.

A repeatable element that details the relevant references (such as contract number) pertaining to the RFQ. The RFQReference is defined by RFQReferenceType.

Product

Product is mandatory. A single instance is required.

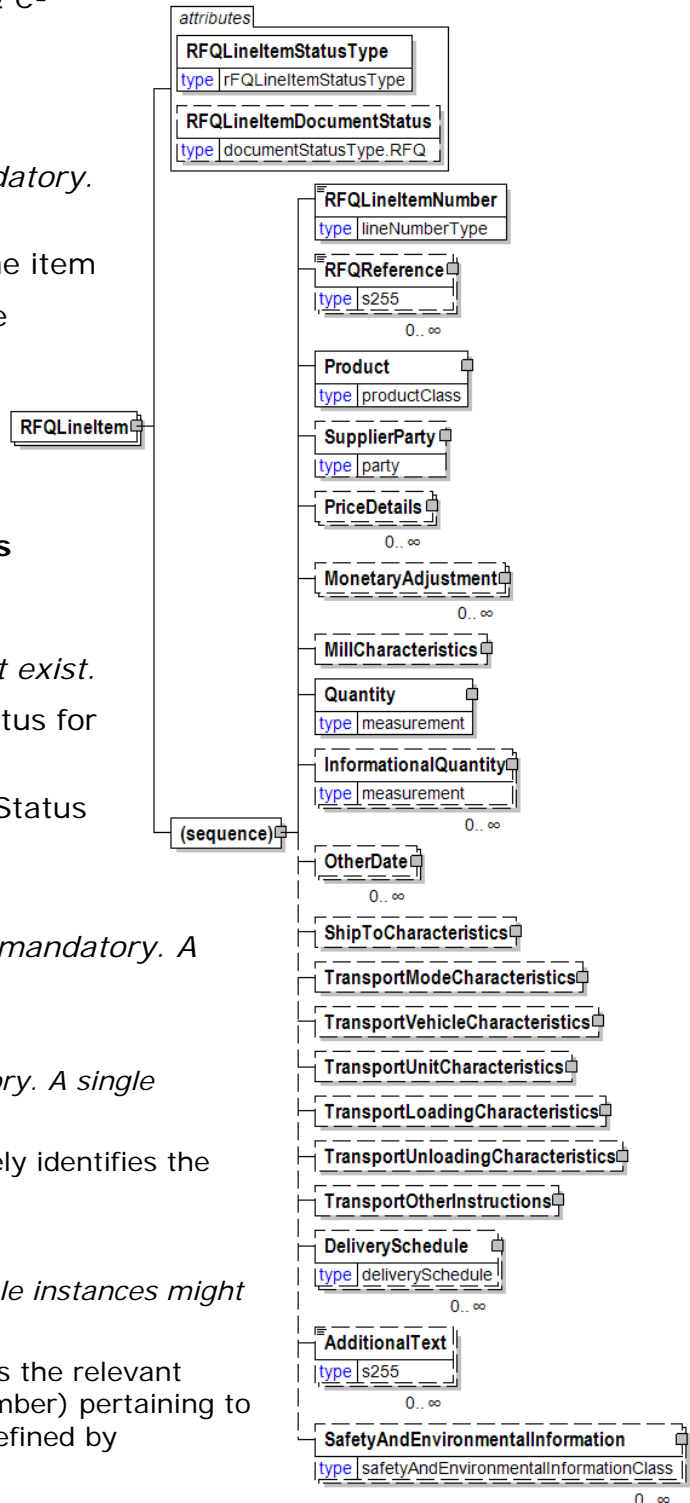

papiNet V2R31

Product is a group item defining the article and its characteristics. Product is used to specify product characteristics organized by ProductIdentifier, ProductDescription, and Classification. Book Manufacturing, Label Stock, Paper, Pulp, Recovered Paper, Wood Products, and Virgin Fibre market segments have defined their product characteristics and conversion features for implementation in papiNet.

SupplierParty

SupplierParty is optional. A single instance might exist.

The organisation or business entity responsible for providing the product. SupplierParty is also the seller of the product, if Seller is not specified as OtherParty = Seller.

PriceDetails

PriceDetails is optional. Multiple instances might exist.

An element that groups together price information.

MonetaryAdjustment

MonetaryAdjustment is optional. Multiple instances might exist.

The element containing the information necessary for the understanding, calculation, and treatment of an adjustment to a currency amount. MonetaryAdjustment contains an attribute that indicates the type of adjustment being communicated.

MillCharacteristics

MillCharacteristics is optional. A single instance might exist.

A group item defining the mill party and machine identifier where a product is or was produced.

Quantity

Quantity is mandatory. A single instance is required.

The Quantity element contains attributes that provide information about the type of quantity that is being communicated, the context in which the particular quantity is to be viewed, and (if the quantity represents an adjustment) an adjustment type.

The Quantity element contains three child elements that enable you to communicate a range of values for the quantity and a target or actual value. It is at this level (Value, RangeMin, and RangeMax) that the unit of measure is specified. This permits the range to be specified in a different unit of measure than the target.

InformationalQuantity

InformationalQuantity is optional. Multiple instances might exist.

A quantity given in a valid UOM used for information purposes only (not for calculation). For example, an ordered quantity was 100 reels as opposed to the invoice quantity of 20,000 pounds.

OtherDate

OtherDate is optional. Multiple instances might exist.

A date that may not be specifically detailed within a document (example: print date at the PurchaseOrderLineItem).

ShipToCharacteristics

ShipToCharacteristics is optional. A single instance might exist.

A group item that provides information important for the Ship-To Party.

A group item that provides information important for the Ship-To Party. ShipToCharacteristics may be referenced at both the header and line item level. The reference at the header is required and acts as a default for the value at the line level, unless overridden at the line level.

TransportModeCharacteristics

TransportModeCharacteristics is optional. A single instance might exist.

A group item defining the primary mode of transport.

TransportVehicleCharacteristics

TransportVehicleCharacteristics is optional. A single instance might exist.

A group item defining the primary means of transporting the goods, such as a side port vessel. In some instances, the transport unit and vehicle are the same.

TransportUnitCharacteristics

TransportUnitCharacteristics is optional. A single instance might exist.

A group item defining and identifying the primary means of containing the goods. In some instances, the transport unit and vehicle are the same.

TransportLoadingCharacteristics

TransportLoadingCharacteristics is optional. A single instance might exist.

A group item defining how the transported items are to be loaded.

TransportUnloadingCharacteristics

TransportUnloadingCharacteristics is optional. A single instance might exist.

A group item defining how the transported items are to be unloaded.

TransportOtherInstructions

TransportOtherInstructions is optional. A single instance might exist.

A group item defining any other instructions for the transport not covered in the description of transport mode, vehicle, unit, and loading characteristics or defining an alternative description for the categories mentioned above.

DeliverySchedule

DeliverySchedule is optional. Multiple instances might exist.

A group item defining a series of DeliveryDateWindow(s) in which specified quantities must be delivered.

AdditionalText

AdditionalText is optional. Multiple instances might exist.

A text field that is used to communicate information not previously defined or for special instructions. To be used only for circumstances not covered by specific elements.

SafetyAndEnvironmentalInformation

SafetyAndEnvironmentalInformation is optional. Multiple instances might exist.

Name of certification type, if any, on the goods (For example, FSC, PEFC). SafetyAndEnvironmental needs a value or measurement to communicate the percentage of the product is certified (for example, 75% is certified by the indicated agency).

RFQLineItemDocumentStatus [attribute]

Defines the actual document status for the RFQLineItem.

This item is restricted to the following list.

Cancelled

The supplied information of the document item is cancelled. Items that have been cancelled are not included in totals on the summary level of e-Documents.

Requested

The supplied information of the document item is ordered.

attribute	
RFQLineItemDocumentStatus	
type	documentStatusType.RFQ

RFQLineItemNumber

A sequential number that uniquely identifies the RFQ line item.

RFQLineItemNumber	
type	lineNumberType

RFQLineItemStatusType [attribute]

Defines the status of the RFQ line item

This item is restricted to the following list.

Accepted

The supplied information is accepted.

Amended

The supplied information is changed.

Cancelled

The supplied information has been cancelled. Items that have been cancelled are not included in totals on the summary levels of the e-Document.

New

The supplied information is new and supplied for the first time.

NoAction

The supplied information has not been amended and thereby requires no action.

attribute	
RFQLineItemStatusType	
type	rFQLineItemStatusType

RFQNumber

The unique RFQ identifier as designated by the buyer.

RFQNumber	
type	s30

RFQReference

A repeatable element that details the relevant references (such as contract number) pertaining to the RFQ. The RFQReference is defined by RFQReferenceType.

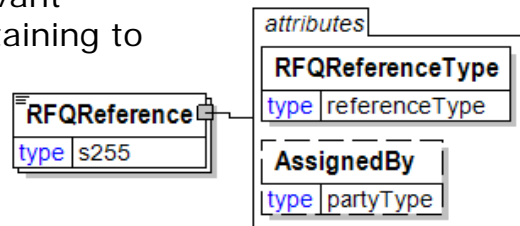

RFQReferenceType [attribute]

RFQReferenceType is mandatory. A single instance is required.

Provides a contextual explanation of the specific reference identifier. Many items are currently prefixed by "Buyer", "Forwarder", "Manufacturer", "Mill", "Seller", "Supplier", "Warehouse", or "Vendor". Check for an existing non-prefixed version and use the non-prefixed version instead. In the (yet to be announced release date) version 3.0 the prefixed versions will be removed. Instead the attribute @AssignedBy will communicate the information previously communicated in the prefix.

Refer to RFQReferenceType definition for any enumerations.

AssignedBy [attribute]

AssignedBy is optional. A single instance might exist.

Identifies the type of party that has assigned the associated item, e.g. a reference of type OrderNumber.

Refer to AssignedBy for any enumerations.

RFQReferenceType [attribute]

Provides a contextual explanation of the specific reference identifier. Many items are currently prefixed by "Buyer", "Forwarder", "Manufacturer", "Mill", "Seller", "Supplier", "Warehouse", or "Vendor". Check for an existing non-prefixed version and use the non-prefixed version instead. In the (yet to be announced release date) version 3.0 the prefixed versions will be removed. Instead the attribute @AssignedBy will communicate the information previously communicated in the prefix.

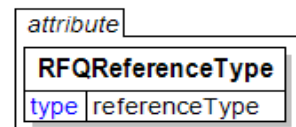

Refer to the [referenceType](#) entry for the list of enumerations and their definitions.

RFQRespondByDate

The Date and Time by which a response needs to be received by the RFQ issuer.

(sequence)

The sequence of items below is mandatory. A single instance is required.

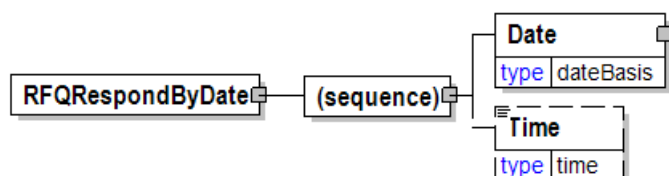

papiNet V2R31

Date

Date is mandatory. A single instance is required.

A group element that contains the specification of Year, Month, and Day.

Time

Time is optional. A single instance might exist.

Times are treated in a standard XML fashion with a special case used to indicate a generalized "local" time. The standard XML approach to time is hh:mm:ss, hh:mm:ssZ, or hh:mm:ss±hh:mm.

hh:mm:ss±hh:mm is used to represent a time with a time zone. The time zone is communicated as the number of hours offset from the Universal Time Coordinate (UTC), a.k.a. Greenwich Mean Time.

hh:mm:ssZ indicates the time at Zulu (another name for UTC). Based on the convention described in the next bullet it will be important for users within UTC to use "Z" when communicating a time in their time zone to other users.

hh:mm:ss or hh:mm indicates in the XML standard the time at UTC however, within papiNet it is used to represent the applicable local time. Caution should be used when processing times of this nature as the papiNet approach may be in discord with other users of XML.

RFQResponse

The RFQResponse element is the root element for the RFQResponse e-Document.

A supplier sends an RFQResponse e-Document to a buyer as a response to an RFQ e-Document from the buyer. The e-Document specifies a quotation for product availability, shipping, and price.

RFQResponse

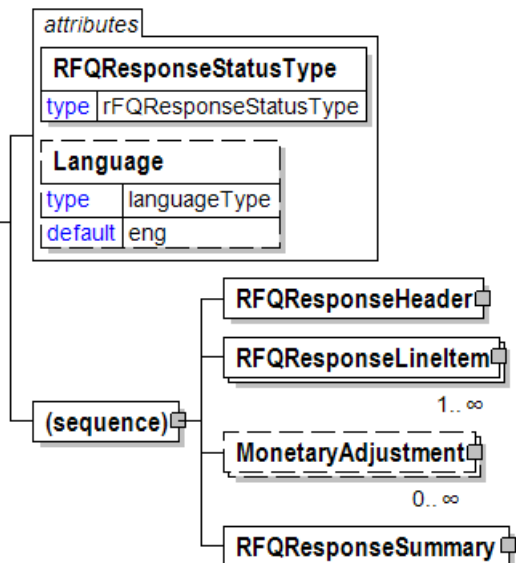

RFQResponseStatusType [attribute]

RFQResponseStatusType is mandatory. A single instance is required.

This attribute acts as a flag indicating what processing may be required.

Refer to RFQResponseStatusType definition for any enumerations.

Language [attribute]

Language is optional. A single instance might exist.

XML has embraced 2 and 3 digit language codes through the application of an addendum to the standard.

Refer to Language definition for any enumerations.

(sequence)

The sequence of items below is mandatory. A single instance is required.

RFQResponseHeader

RFQResponseHeader is mandatory. A single instance is required.

Information that pertains to the entire RFQResponse.

RFQResponseLineItem

RFQResponseLineItem is mandatory. One instance is required, multiple instances might exist.

A group element that contains the response details provided by the party responding to the RFQ.

MonetaryAdjustment

MonetaryAdjustment is optional. Multiple instances might exist.

The element containing the information necessary for the understanding, calculation, and treatment of an adjustment to a currency amount. MonetaryAdjustment contains an attribute that indicates the type of adjustment being communicated.

RFQResponseSummary

RFQResponseSummary is mandatory. A single instance is required.

A group element that contains information that summarizes the contents of the RFQResponse.

RFQResponseHeader

Information that pertains to the entire RFQResponse.

RFQResponseHeaderStatusType [attribute]

RFQResponseHeaderStatusType is mandatory. A single instance is required.

Defines the status of the RFQ header

Refer to

RFQResponseHeader

RFQResponseHeaderStatusType definition for any enumerations.

(sequence)

The sequence of items below is mandatory. A single instance is required.

RFQResponseHeaderStatusTypeText

RFQResponseHeaderStatusTypeText is optional. A single instance might exist.

A text field that may provide detail explaining the status of the RFQResponse.

When an RFQ is rejected, the reason for the rejection must be specified in this field.

RFQResponseNumber

RFQResponseNumber is optional. A single instance might exist.

The identifying number of the RFQResponse.

RFQResponseIssuedDate

RFQResponseIssuedDate is mandatory. A single instance is required.

The Date and Time when the response to the RFQResponse was issued.

RFQInformation

RFQInformation is mandatory. A single instance is required.

A group item containing information unique to this RFQ which is provided by the buyer.

TransactionHistoryNumber

TransactionHistoryNumber is optional. A single instance might exist.

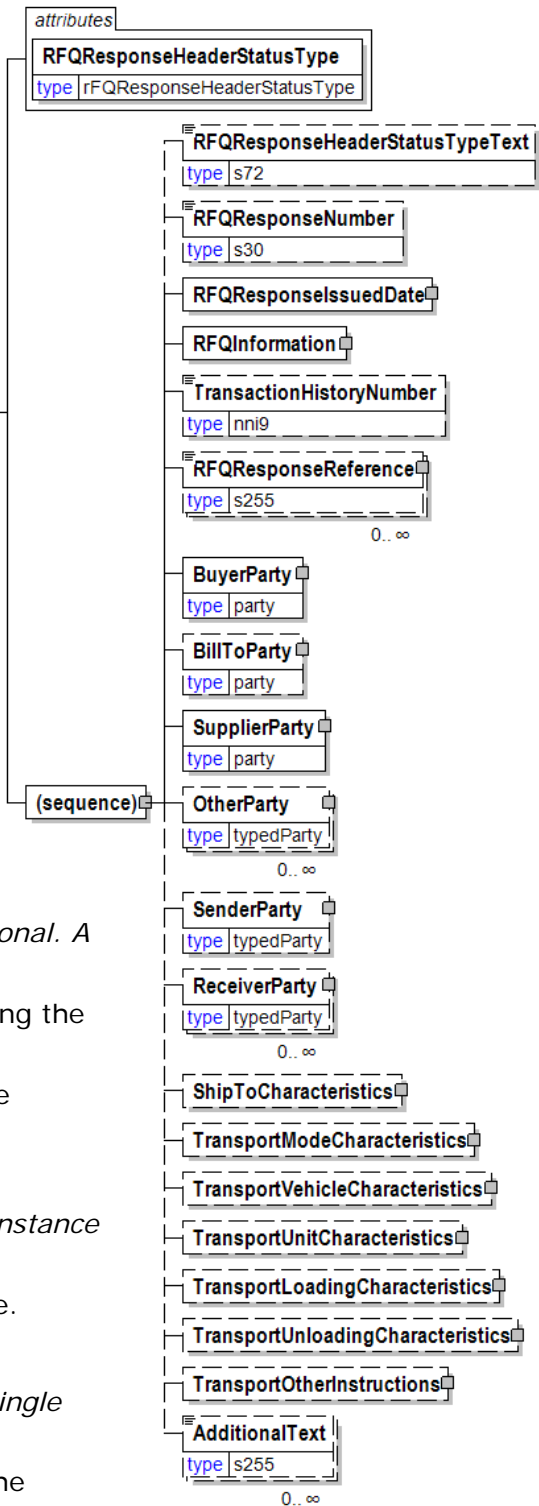

A sequential number that keeps track of the version of a document being sent by the document originator except in the case where TransactionHistoryConfirmation is used, in which case the TransactionHistoryNumber refers to the trigger transaction for which the confirmation is being sent.

RFQResponseReference

RFQResponseReference is optional. Multiple instances might exist.

An element that details the relevant references (such as contract number) pertaining to the RFQResponse. RFQResponseReferenceType indicates what type of reference is being communicated.

BuyerParty

BuyerParty is mandatory. A single instance is required.

The legal entity to which the product is sold. Also commonly referred to as the sold-to party or customer. If no OtherParty is defined as the Payer, the Buyer is the Payer.

BillToParty

BillToParty is optional. A single instance might exist.

The address where the invoice is to be sent.

SupplierParty

SupplierParty is mandatory. A single instance is required.

The organisation or business entity responsible for providing the product. SupplierParty is also the seller of the product, if Seller is not specified as OtherParty = Seller.

OtherParty

OtherParty is optional. Multiple instances might exist.

An organisation or business entity other than those specifically detailed within a e-Document.

SenderParty

SenderParty is optional. A single instance might exist.

The business entity issuing the e-Document, the source of the document.

The entity responsible for the content. If the sender party has out sourced the message service to a third party the SenderParty is the issuer of the e-Document and not the party performing the transmission service of the electronic message.

ReceiverParty

ReceiverParty is optional. Multiple instances might exist.

The business entity for whom the e-Document is intended, the destination of the document.

The entity interested in the content. If the receiver party has outsourced the message service to a third party the ReceiverParty is the intended party for the e-Document and not the party performing the receiving service of the electronic message.

ShipToCharacteristics

ShipToCharacteristics is optional. A single instance might exist.

A group item that provides information important for the Ship-To Party.

A group item that provides information important for the Ship-To

papiNet V2R31

Party.ShipToCharacteristics may be referenced at both the header and line item level. The reference at the header is required and acts as a default for the value at the line level, unless overridden at the line level.

TransportModeCharacteristics

TransportModeCharacteristics is optional. A single instance might exist.

A group item defining the primary mode of transport.

TransportVehicleCharacteristics

TransportVehicleCharacteristics is optional. A single instance might exist.

A group item defining the primary means of transporting the goods, such as a side port vessel. In some instances, the transport unit and vehicle are the same.

TransportUnitCharacteristics

TransportUnitCharacteristics is optional. A single instance might exist.

A group item defining and identifying the primary means of containing the goods. In some instances, the transport unit and vehicle are the same.

TransportLoadingCharacteristics

TransportLoadingCharacteristics is optional. A single instance might exist.

A group item defining how the transported items are to be loaded.

TransportUnloadingCharacteristics

TransportUnloadingCharacteristics is optional. A single instance might exist.

A group item defining how the transported items are to be unloaded.

TransportOtherInstructions

TransportOtherInstructions is optional. A single instance might exist.

A group item defining any other instructions for the transport not covered in the description of transport mode, vehicle, unit, and loading characteristics or defining an alternative description for the categories mentioned above.

AdditionalText

AdditionalText is optional. Multiple instances might exist.

A text field that is used to communicate information not previously defined or for special instructions. To be used only for circumstances not covered by specific elements.

RFQResponseHeaderStatusType [attribute]

Defines the status of the RFQ header

This item is restricted to the following list.

Accepted

The supplied information is accepted.

Amended

The supplied information is changed

Counterproposal

The sender is presenting a different proposal.

NoAction

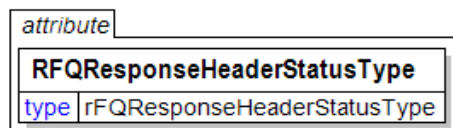

The supplied information has not been amended and thereby requires no action.

Pending

The supplied information is not complete and will be updated later.

Rejected

The supplied information is rejected.

RFQResponseHeaderStatusTypeText

A text field that may provide detail explaining the status of the RFQResponse.

When an RFQ is rejected, the reason for the rejection must be specified in this field.

RFQResponseHeaderStatusTypeText	
type	s72

RFQResponseIssuedDate

The Date and Time when the response to the RFQResponse was issued.

(sequence)

The sequence of items below is mandatory. A single instance is required.

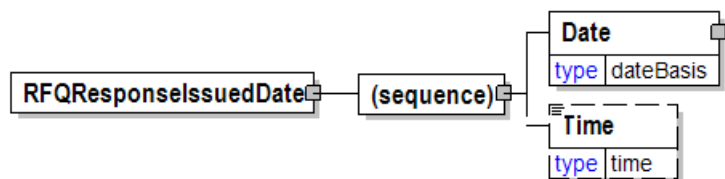

Date

Date is mandatory. A single instance is required.

A group element that contains the specification of Year, Month, and Day.

Time

Time is optional. A single instance might exist.

Times are treated in a standard XML fashion with a special case used to indicate a generalized "local" time. The standard XML approach to time is hh:mm:ss, hh:mm:ssZ, or hh:mm:ss±hh:mm.

hh:mm:ss±hh:mm is used to represent a time with a time zone. The time zone is communicated as the number of hours offset from the Universal Time Coordinate (UTC), a.k.a. Greenwich Mean Time.

hh:mm:ssZ indicates the time at Zulu (another name for UTC). Based on the convention described in the next bullet it will be important for users within UTC to use "Z" when communicating a time in their time zone to other users.

hh:mm:ss or hh:mm indicates in the XML standard the time at UTC however, within papiNet it is used to represent the applicable local time. Caution should be used when processing times of this nature as the papiNet approach may be in discord with other users of XML.

RFQResponseLineItem

A group element that contains the response details provided by the party responding to the RFQ.

RFQResponseLineItemStatusType [attribute]

RFQResponseLineItemStatusType is mandatory. A single instance is required.

RFQResponse Line Item Status Type

Refer to RFQResponseLineItemStatusType definition for any enumerations.

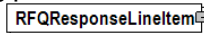

RFQResponseLineItemDocumentStatus [attribute]

RFQResponseLineItemDocumentStatus is optional. A single instance might exist.

Defines the actual document status for the RFQResponseLineItem.

Refer to RFQResponseLineItemDocumentStatus definition for any enumerations.

(sequence)

The sequence of items below is mandatory. A single instance is required.

RFQResponseLineItemStatusTypeText

RFQResponseLineItemStatusTypeText is optional. A single instance might exist.

A text field that may provide detail explaining the status of the RFQResponseLineItem.

When an RFQLineItem is rejected, the reason for the rejection must be specified in this field.

RFQResponseValidityDate

RFQResponseValidityDate is mandatory. A single instance is required.

The Date and Time within which a response to the RFQ is valid.

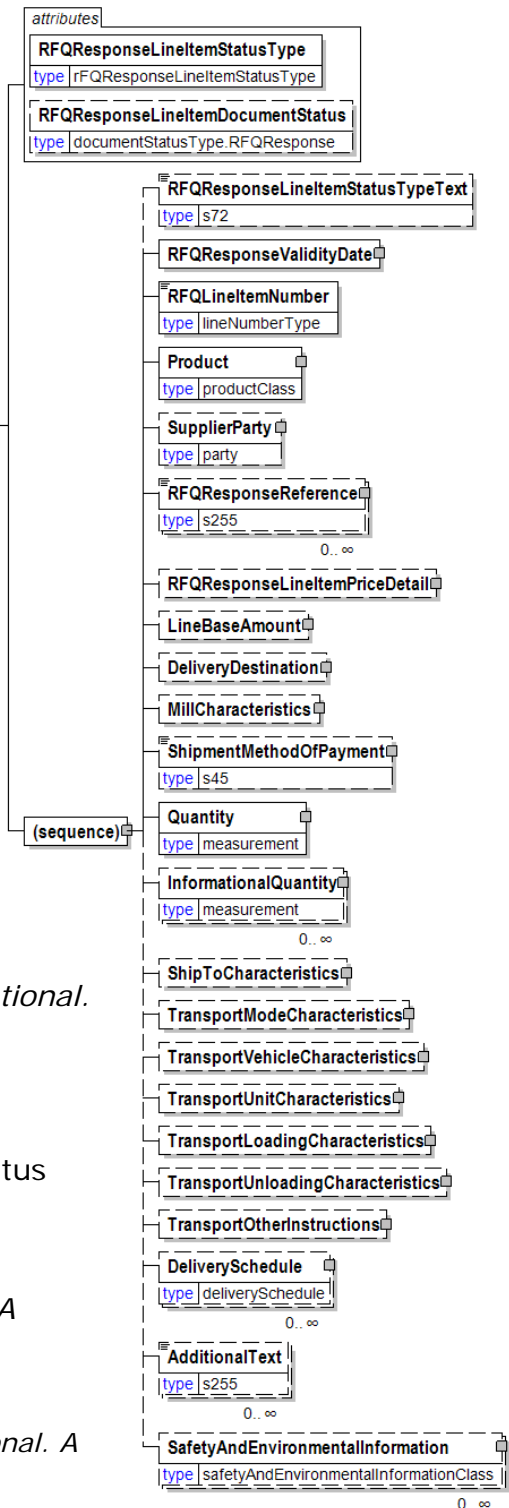

RFQLineItemNumber

RFQLineItemNumber is mandatory. A single instance is required.

A sequential number that uniquely identifies the RFQ line item.

Product

Product is mandatory. A single instance is required.

Product is a group item defining the article and its characteristics. Product is used to specify product characteristics organized by ProductIdentifier, ProductDescription, and Classification. Book Manufacturing, Label Stock, Paper, Pulp, Recovered Paper, Wood Products, and Virgin Fibre market segments have defined their product characteristics and conversion features for implementation in papiNet.

SupplierParty

SupplierParty is optional. A single instance might exist.

The organisation or business entity responsible for providing the product. SupplierParty is also the seller of the product, if Seller is not specified as OtherParty = Seller.

RFQResponseReference

RFQResponseReference is optional. Multiple instances might exist.

An element that details the relevant references (such as contract number) pertaining to the RFQResponse. RFQResponseReferenceType indicates what type of reference is being communicated.

RFQResponseLineItemPriceDetail

RFQResponseLineItemPriceDetail is optional. A single instance might exist.

The pricing information associated with the response to an RFQ.

LineBaseAmount

LineBaseAmount is optional. A single instance might exist.

For the particular e-Document being communicated the LineBaseAmount represents the quantity times the base unit price.

DeliveryDestination

DeliveryDestination is optional. A single instance might exist.

The DeliveryDestination specifies the end of one leg of the delivery. In order to comply with the US Trade Act of 2002 you would use this element with a LocationParty/@PartyType of Port.

MillCharacteristics

MillCharacteristics is optional. A single instance might exist.

A group item defining the mill party and machine identifier where a product is or was produced.

ShipmentMethodOfPayment

ShipmentMethodOfPayment is optional. A single instance might exist.

An element communicating responsibility of freight payment and when transfer of ownership will occur.

Quantity

Quantity is mandatory. A single instance is required.

The Quantity element contains attributes that provide information about the type of

quantity that is being communicated, the context in which the particular quantity is to be viewed, and (if the quantity represents an adjustment) an adjustment type.

The Quantity element contains three child elements that enable you to communicate a range of values for the quantity and a target or actual value. It is at this level (Value, RangeMin, and RangeMax) that the unit of measure is specified. This permits the range to be specified in a different unit of measure than the target.

InformationalQuantity

InformationalQuantity is optional. Multiple instances might exist.

A quantity given in a valid UOM used for information purposes only (not for calculation). For example, an ordered quantity was 100 reels as opposed to the invoice quantity of 20,000 pounds.

ShipToCharacteristics

ShipToCharacteristics is optional. A single instance might exist.

A group item that provides information important for the Ship-To Party.

A group item that provides information important for the Ship-To Party. ShipToCharacteristics may be referenced at both the header and line item level. The reference at the header is required and acts as a default for the value at the line level, unless overridden at the line level.

TransportModeCharacteristics

TransportModeCharacteristics is optional. A single instance might exist.

A group item defining the primary mode of transport.

TransportVehicleCharacteristics

TransportVehicleCharacteristics is optional. A single instance might exist.

A group item defining the primary means of transporting the goods, such as a side port vessel. In some instances, the transport unit and vehicle are the same.

TransportUnitCharacteristics

TransportUnitCharacteristics is optional. A single instance might exist.

A group item defining and identifying the primary means of containing the goods. In some instances, the transport unit and vehicle are the same.

TransportLoadingCharacteristics

TransportLoadingCharacteristics is optional. A single instance might exist.

A group item defining how the transported items are to be loaded.

TransportUnloadingCharacteristics

TransportUnloadingCharacteristics is optional. A single instance might exist.

A group item defining how the transported items are to be unloaded.

TransportOtherInstructions

TransportOtherInstructions is optional. A single instance might exist.

A group item defining any other instructions for the transport not covered in the description of transport mode, vehicle, unit, and loading characteristics or defining an alternative description for the categories mentioned above.

DeliverySchedule

DeliverySchedule is optional. Multiple instances might exist.

A group item defining a series of DeliveryDateWindow(s) in which specified

quantities must be delivered.

AdditionalText

AdditionalText is optional. Multiple instances might exist.

A text field that is used to communicate information not previously defined or for special instructions. To be used only for circumstances not covered by specific elements.

SafetyAndEnvironmentalInformation

SafetyAndEnvironmentalInformation is optional. Multiple instances might exist.

Name of certification type, if any, on the goods (For example, FSC, PEFC). SafetyAndEnvironmental needs a value or measurement to communicate the percentage of the product is certified (for example, 75% is certified by the indicated agency).

RFQResponseLineItemDocumentStatus [attribute]

Defines the actual document status for the RFQResponseLineItem.

This item is restricted to the following list.

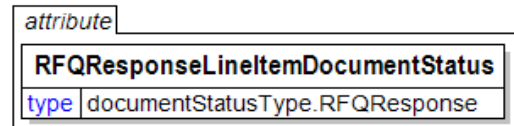

Cancelled

The supplied information of the document item is cancelled. Items that have been cancelled are not included in totals on the summary level of e-Documents.

Confirmed

The supplied information of the document item is agreed. If a requested change or cancellation of an existing document item can not be accepted, then the earlier agreed information of the document item will be re-confirmed.

Pending

The supplied information of the document item is being investigated.

Rejected

The supplied information of the document item can not be accepted. The document item is new or not earlier confirmed.

RFQResponseLineItemPriceDetail

The pricing information associated with the response to an RFQ.

(sequence)

The sequence of items below is mandatory. A single instance is required.

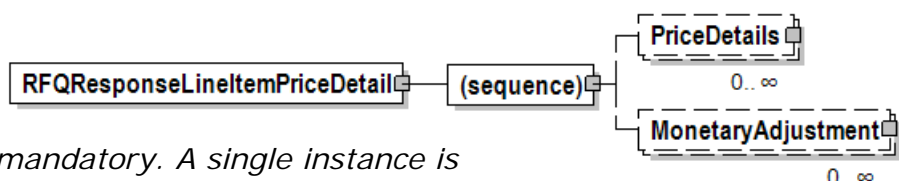

PriceDetails

PriceDetails is optional. Multiple instances might exist.

An element that groups together price information.

MonetaryAdjustment

MonetaryAdjustment is optional. Multiple instances might exist.

The element containing the information necessary for the understanding, calculation, and treatment of an adjustment to a currency amount.

MonetaryAdjustment contains an attribute that indicates the type of adjustment being communicated.

RFQResponseLineItemStatusType [attribute]

RFQResponse Line Item Status Type

This item is restricted to the following list.

Accepted

The supplied information is accepted.

Amended

The supplied information is changed.

Counterproposal

The sender is presenting a different proposal.

NoAction

The supplied information has not been amended and thereby requires no action.

Pending

The supplied information is not complete and will be updated later.

Rejected

The supplied information is rejected.

attribute
RFQResponseLineItemStatusType
type rFQResponseLineItemStatusType

RFQResponseLineItemStatusTypeText

A text field that may provide detail explaining the status of the RFQResponseLineItem.

When an RFQLineItem is rejected, the reason for the rejection must be specified in this field.

RFQResponseLineItemStatusTypeText
type s72

RFQResponseNumber

The identifying number of the RFQResponse.

RFQResponseNumber
type s30

RFQResponseReference

An element that details the relevant references (such as contract number) pertaining to the RFQResponse.

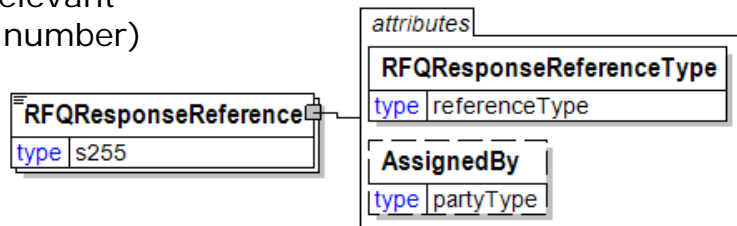

RFQResponseReferenceType indicates what type of reference is being communicated.

RFQResponseReferenceType [attribute]

RFQResponseReferenceType is mandatory. A single instance is required.

Provides a contextual explanation of the specific reference identifier. Many items are currently prefixed by "Buyer", "Forwarder", "Manufacturer", "Mill", "Seller", "Supplier", "Warehouse", or "Vendor". Check for an existing non-prefixed version and use the non-prefixed version instead. In the (yet to be announced release date) version 3.0 the prefixed versions will be removed. Instead the attribute @AssignedBy will communicate the information previously communicated in the prefix.

Refer to RFQResponseReferenceType definition for any enumerations.

AssignedBy [attribute]

AssignedBy is optional. A single instance might exist.

Identifies the type of party that has assigned the associated item, e.g. a reference of type OrderNumber.

Refer to AssignedBy for any enumerations.

RFQResponseReferenceType [attribute]

Provides a contextual explanation of the specific reference identifier. Many items are currently prefixed by "Buyer", "Forwarder", "Manufacturer", "Mill", "Seller", "Supplier", "Warehouse", or "Vendor". Check for an existing non-prefixed version and use the non-prefixed version instead. In the (yet to be announced release date) version 3.0 the prefixed versions will be removed. Instead the attribute @AssignedBy will communicate the information previously communicated in the prefix.

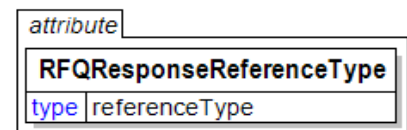

Refer to the [referenceType](#) entry for the list of enumerations and their definitions.

RFQResponseStatusType [attribute]

This attribute acts as a flag indicating what processing may be required.

This item is restricted to the following list.



Accepted

The supplied information is accepted.

Amended

The supplied information is changed.

Cancelled

The supplied information has been cancelled. Items that have been cancelled are not included in totals on the summary levels of the e-Document.

Counterproposal

The sender is presenting a different proposal.

Rejected

The supplied information is rejected.

RFQResponseSummary

A group element that contains information that summarizes the contents of the RFQResponse.

(sequence)

The sequence of items below is mandatory. A single instance is required.

TotalNumberOfLineItems

TotalNumberOfLineItems is optional. A single instance might exist.

The total number of individual line items in the document, regardless of the status or type.

(sequence)

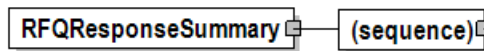

The sequence of items below is mandatory. One instance is required, multiple instances might exist.

TotalQuantity

TotalQuantity is mandatory. A single instance is required.

The total quantity of similar items in the e-Document. TotalQuantity is primarily used in the summary section of documents where it is repeatable to permit totaling for different units of measure.

TotalInformationalQuantity

TotalInformationalQuantity is optional. Multiple instances might exist.

A quantity that is used to communicate related information about the parent element. This element represents a total that is derived from individual line items.

LineItemSubTotal

LineItemSubTotal is optional. A single instance might exist.

The total amount of all e-Document LineBaseAmount(s) line items without any monetary adjustments that may occur after the e-Document line items.

TotalAdjustments

TotalAdjustments is optional. A single instance might exist.

The CurrencyValue of TotalAdjustments contains the total of all MonetaryAdjustmentAmount for all instances of PriceAdjustment and FlatAmountAdjustment in the document (it excludes TaxAdjustments).

TotalTaxAmount

TotalTaxAmount is optional. A single instance might exist.

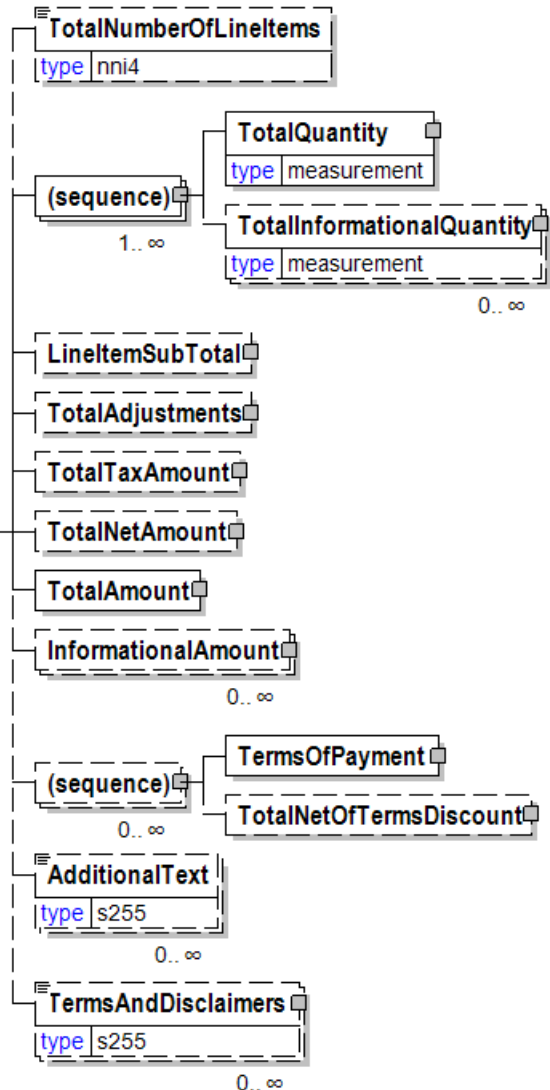

The CurrencyValue of TotalTaxAmount contains the sum of all instances of TaxAdjustment in the document. TotalTaxAmount contains the sum of all instances of the MonetaryAdjustmentAmount for tax adjustments.

TotalNetAmount

TotalNetAmount is optional. A single instance might exist.

A field containing total amount excluding tax. For example, in the Invoice TotalNetAmount is equal to the sum of LineItemSubTotal plus TotalAdjustments. TotalNetAmount encapsulates CurrencyValue.

TotalAmount

TotalAmount is mandatory. A single instance is required.

The total amount including tax.

In e-Documents claiming payment this is the amount due for payment based on the terms of payment. Decimal rounding might be applied to this amount.

InformationalAmount

InformationalAmount is optional. Multiple instances might exist.

A monetary amount used for information purposes only (not for calculation). For example, the invoice price adjustment subtotal is expressed in sterling pounds, and the buyer wants this information expressed in U.S. dollars.

CreditDebitNote and Invoice - The TaxAmount is displayed in the currency that is applicable throughout the e-Document. When a TaxAmount needs to be displayed in a different national currency, this field is used.

(sequence)

The sequence of items below is optional. Multiple instances might exist.

TermsOfPayment

TermsOfPayment is mandatory. A single instance is required.

A group item that contains agreed-to terms defining when, how, and under what conditions the payment is to be made.

When TermsOfPayment is optional; if omitted, TermsOfPayment is controlled through previous negotiation.

TotalNetOfTermsDiscount

TotalNetOfTermsDiscount is optional. A single instance might exist.

The components of the amount to be paid if prompt payment discount terms are met, including the amount that is subject to the payment terms discount, the discount amount, and the amount due after prompt payment discount.

AdditionalText

AdditionalText is optional. Multiple instances might exist.

A text field that is used to communicate information not previously defined or for special instructions. To be used only for circumstances not covered by specific elements.

TermsAndDisclaimers

TermsAndDisclaimers is optional. Multiple instances might exist.

An element that contains legal information with an indication of what the Language is.

RFQResponseValidityDate

The Date and Time within which a response to the RFQ is valid.

(sequence)

The sequence of items below is mandatory. A single instance is required.

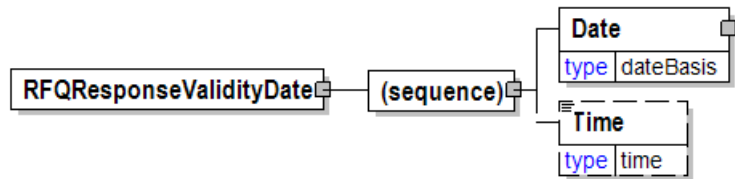

Date

Date is mandatory. A single instance is required.

A group element that contains the specification of Year, Month, and Day.

Time

Time is optional. A single instance might exist.

Times are treated in a standard XML fashion with a special case used to indicate a generalized "local" time. The standard XML approach to time is hh:mm:ss, hh:mm:ssZ, or hh:mm:ss±hh:mm.

hh:mm:ss±hh:mm is used to represent a time with a time zone. The time zone is communicated as the number of hours offset from the Universal Time Coordinate (UTC), a.k.a. Greenwich Mean Time.

hh:mm:ssZ indicates the time at Zulu (another name for UTC). Based on the convention described in the next bullet it will be important for users within UTC to use "Z" when communicating a time in their time zone to other users.

hh:mm:ss or hh:mm indicates in the XML standard the time at UTC however, within papiNet it is used to represent the applicable local time. Caution should be used when processing times of this nature as the papiNet approach may be in discord with other users of XML.

RFQStatusType [attribute]

This attribute acts as a flag indicating what processing may be required.

This item is restricted to the following list.

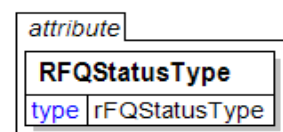

Amended

The supplied information is changed.

Cancelled

The supplied information has been cancelled. Items that have been cancelled are not included in totals on the summary levels of the e-Document.

Original

The supplied information is the first version of that information.

RFQSummary

Summary information that applies to the RFQ e-Document.

(sequence)

The sequence of items below is mandatory. A single instance is required.

TotalNumberOfLineItems

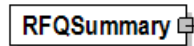

TotalNumberOfLineItems is optional. A single instance might exist.

The total number of individual line items in the document, regardless of the status or type.

(sequence)

The sequence of items below is mandatory. One instance is required, multiple instances might exist.

TotalQuantity

TotalQuantity is mandatory. A single instance is required.

The total quantity of similar items in the e-Document. TotalQuantity is primarily used in the summary section of documents where it is repeatable to permit totaling for different units of measure.

InformationalQuantity

InformationalQuantity is optional. Multiple instances might exist.

A quantity given in a valid UOM used for information purposes only (not for calculation). For example, an ordered quantity was 100 reels as opposed to the invoice quantity of 20,000 pounds.

TotalAmount

TotalAmount is optional. A single instance might exist.

The total amount including tax.

In e-Documents claiming payment this is the amount due for payment based on the terms of payment. Decimal rounding might be applied to this amount.

TermsAndDisclaimers

TermsAndDisclaimers is optional. Multiple instances might exist.

An element that contains legal information with an indication of what the Language is.

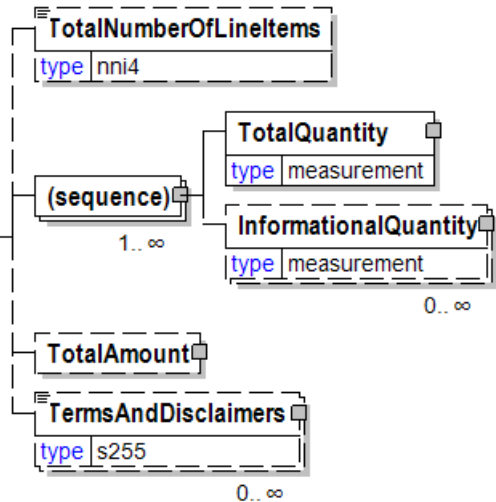

RFQType [attribute]

Defines the type of RFQ issued.

This item is restricted to the following list.

StandardRFQ

The only type of RFQ.

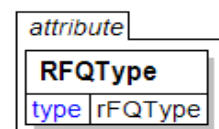

RGB

A definition of colour using the RGB protocol.

TestMethod [attribute]

TestMethod is optional. A single instance might exist.

The method used to determine the results of the test under consideration.

TestAgency [attribute]

TestAgency is optional. A single instance might exist.

The agency that has set the parameters for the testing

Refer to TestAgency definition for any enumerations.

SampleType [attribute]

SampleType is optional. A single instance might exist.

Communicates how sampling was done to measure the product characteristics.

Refer to SampleType definition for any enumerations.

ResultSource [attribute]

ResultSource is optional. A single instance might exist.

Used to define the data source of the specified test

Refer to ResultSource definition for any enumerations.

(sequence)

The sequence of items below is mandatory. A single instance is required.

Red

Red is mandatory. A single instance is required.

The "Red" portion of the method of representing colour termed RGB.

Green

Green is mandatory. A single instance is required.

The "Green" portion of the method of representing colour termed RGB

Blue

Blue is mandatory. A single instance is required.

The "Blue" portion of the method of representing colour termed RGB.

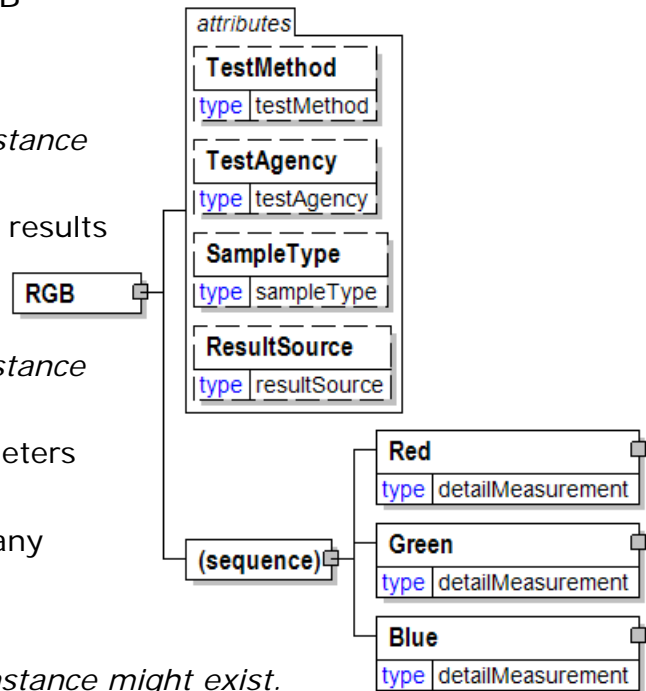

Ribbon

Ribbon information.

(sequence)

The sequence of items below is mandatory. A single instance is required.

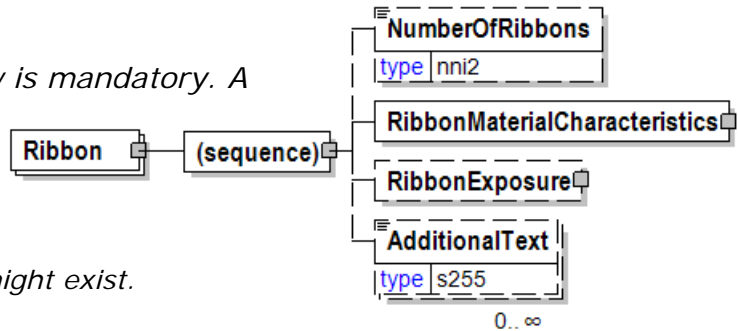

NumberOfRibbons

NumberOfRibbons is optional. A single instance might exist.

The number of ribbons.

RibbonMaterialCharacteristics

RibbonMaterialCharacteristics is mandatory. A single instance is required.

Ribbon material characteristics.

RibbonExposure

RibbonExposure is optional. A single instance might exist.

Ribbon exposure

AdditionalText

AdditionalText is optional. Multiple instances might exist.

A text field that is used to communicate information not previously defined or for special instructions. To be used only for circumstances not covered by specific elements.

RibbonExposure

Ribbon exposure

(sequence)

The sequence of items below is mandatory. A single instance is required.

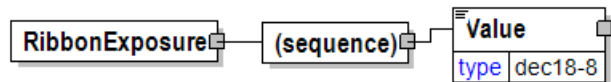

Value

Value is mandatory. A single instance is required.

A numeric value expressed in the unit of measure (UOM).

RibbonFacingType [attribute]

The type of ribbon facing

This item is restricted to the following list.

Double

Single

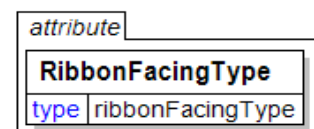

RibbonMaterialCharacteristics

Ribbon material characteristics.

RibbonFacingType [attribute]

RibbonFacingType is optional. A single instance might exist.

The type of ribbon facing

Refer to RibbonFacingType definition for any enumerations.

(sequence)

The sequence of items below is mandatory. A single instance is required.

BindingMaterialCharacteristics

BindingMaterialCharacteristics is mandatory. A single instance is required.

Binding Material Characteristics

Width

Width is optional. A single instance might exist.

The width of the object.

AdditionalText

AdditionalText is optional. Multiple instances might exist.

A text field that is used to communicate information not previously defined or for special instructions. To be used only for circumstances not covered by specific elements.

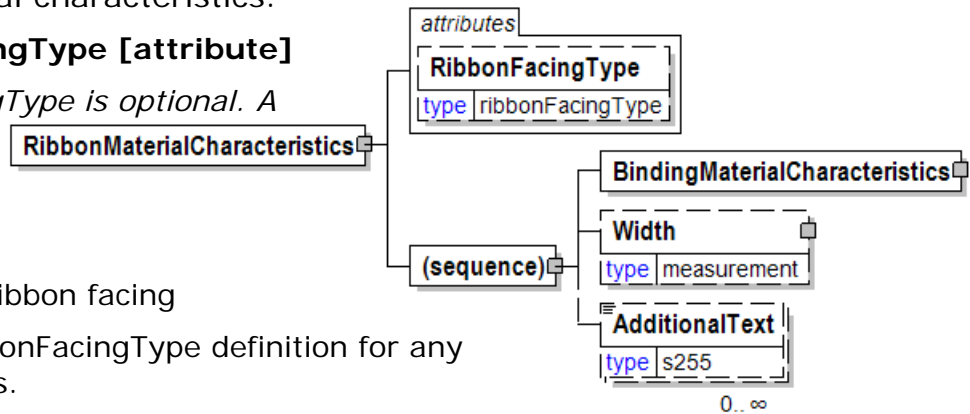

RingCrush

Ring Crush

TestMethod [attribute]

TestMethod is optional. A single instance might exist.

The method used to determine the results of the test under consideration.

TestAgency [attribute]

TestAgency is optional. A single instance might exist.

The agency that has set the parameters for the testing

Refer to TestAgency definition for any enumerations.

SampleType [attribute]

SampleType is optional. A single instance might exist.

Communicates how sampling was done to measure the product characteristics.

Refer to SampleType definition for any enumerations.

ResultSource [attribute]

ResultSource is optional. A single instance might exist.

Used to define the data source of the specified test

Refer to ResultSource definition for any enumerations.

(sequence)

The sequence of items below is mandatory. A single instance is required.

DetailValue

DetailValue is mandatory. A single instance is required.

A numeric value expressed in the unit of measure (UOM).

DetailRangeMin

DetailRangeMin is optional. A single instance might exist.

The minimum value (lower boundary) allowed for the DetailValue that is the parent of this element.

DetailRangeMax

DetailRangeMax is optional. A single instance might exist.

The maximum value (upper boundary) allowed for the DetailValue that is the parent of this element.

StandardDeviation

StandardDeviation is optional. A single instance might exist.

A statistic used as a measure of dispersion in a distribution.

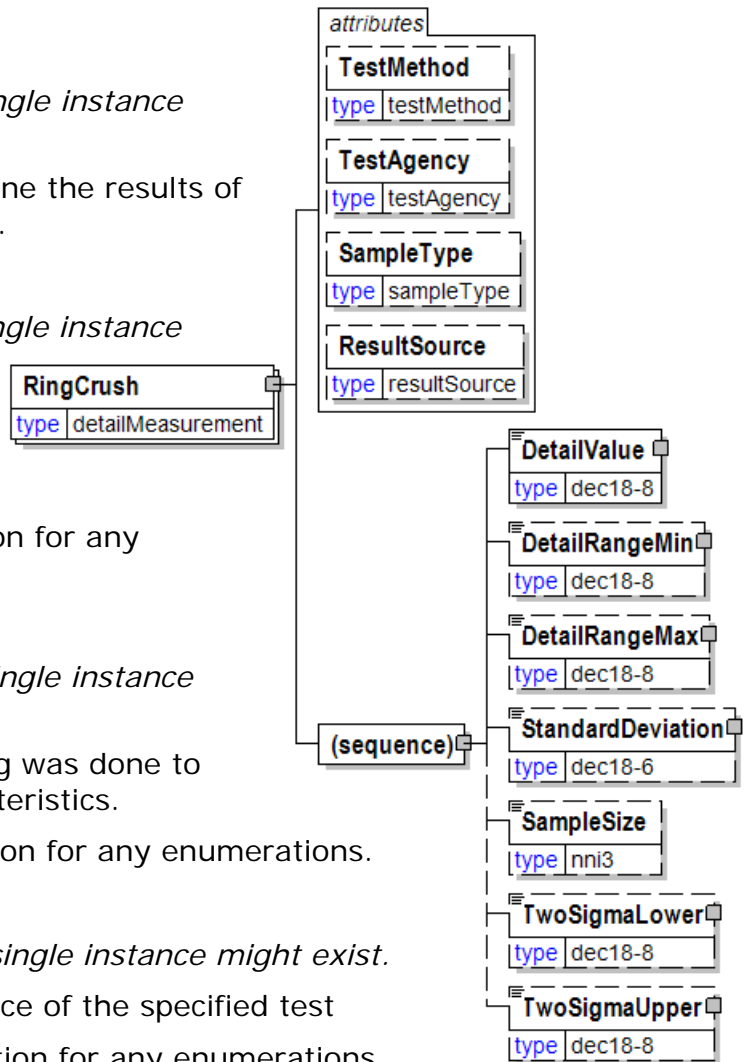

SampleSize

SampleSize is optional. A single instance might exist.

The number of samples used to determine the product characteristic in question.

TwoSigmaLower

TwoSigmaLower is optional. A single instance might exist.

Two sigma (a measure of dispersion associated with standard deviation) on the lower side of the standard deviation.

TwoSigmaUpper

TwoSigmaUpper is optional. A single instance might exist.

Two sigma (a measure of dispersion associated with standard deviation) on the upper side of the standard deviation.

RoadAccessibilityType [attribute]

Defines the largest vehicle and transport unit combination that can access the road according to the road curving, bends, hills and slopes.

This item is restricted to the following list.



Trailer

Road is accessible for a truck with trailer.

DrawBarCombination

Road is accessible for a drawbar combination.

DrawBarCombinationWithAdjustableBogie

Road is accessible for a drawbar combination with trailer equipped with adjustable bogie.

RigidLorry

Road is accessible for shorter vehicles that is, a rigid lorry without trailer.

RoadAvailability

Defines when in the year or season the road is available.

This item is restricted to the following list.



AllYear

Road is available all year for all kind of traffic.

NotInHeavyRain

Road is not available for trucks in heavy rain periods.

NotInSevereThawing

Road is not available for trucks in severe soil frost thawing.

NotInWinter

Road is not available in winter season. Only available in spring, summer and autumn season.

InWinter

Road is available for trucks only in winter season. In the Nordic region it is common with ice-roads over lakes etc in the winter season.

RoadBearingCapacity

The capacity for the road to bear a load without being damaged.

RoadBearingCapacityType [attribute]

RoadBearingCapacityType is optional. A single instance might exist.

Type of burden restriction for the road that is specified by RoadBearingCapacity.

Refer to RoadBearingCapacityType definition for any enumerations.

(sequence)

The sequence of items below is mandatory. A single instance is required.

Value

Value is mandatory. A single instance is required.

A numeric value expressed in the unit of measure (UOM).

RangeMin

RangeMin is optional. A single instance might exist.

The minimum value (lower boundary) allowed for the Measurement that is the parent of this element.

RangeMax

RangeMax is optional. A single instance might exist.

The maximum value (upper boundary) allowed for the Measurement that is the parent of this element. Some elements use the RangeMax element with an extended list of unit of measures. (Note: the red colour in the picture is an artifact of how the graphic was captured and should be disregarded.)

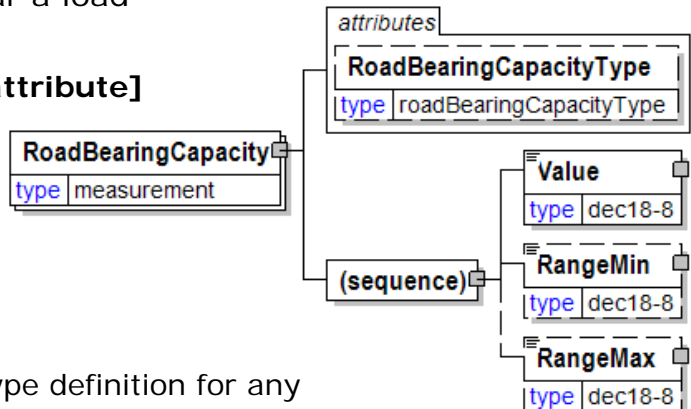

RoadBearingCapacityType [attribute]

Type of burden restriction for the road that is specified by RoadBearingCapacity.

This item is restricted to the following list.

BogieLoad

Maximum load for a bogie (tandem axles).

SingleAxleLoad

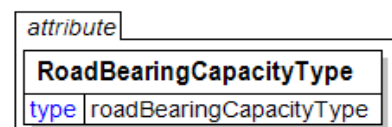

Maximum axle load.

TripleAxleLoad

Maximum load for a triple axle.

TotalVehicleLoad

Maximum total load (gross weight) for a vehicle.

RoadCharacteristics

A grouping element containing items describing characteristics specific for a road.

RoadOwnerType [attribute]

RoadOwnerType is optional. A single instance might exist.

Defines the ownership for the road.

Refer to RoadOwnerType definition for any enumerations.

RoadKeeperType [attribute]

RoadKeeperType is optional. A single instance might exist.

Defines the party responsible for the maintenance of the road.

Refer to RoadKeeperType definition for any enumerations.

RoadAccessibilityType [attribute]

RoadAccessibilityType is optional. A single instance might exist.

Defines the largest vehicle and transport unit combination that can access the road according to the road curving, bends, hills and slopes.

Refer to RoadAccessibilityType definition for any enumerations.

RoadTurningPossibilityType [attribute]

RoadTurningPossibilityType is optional. A single instance might exist.

Defines what kind of vehicle that can turn around.

Refer to RoadTurningPossibilityType definition for any enumerations.

RoadTurningPointType [attribute]

RoadTurningPointType is optional. A single instance might exist.

Defines the shape of the turning point.

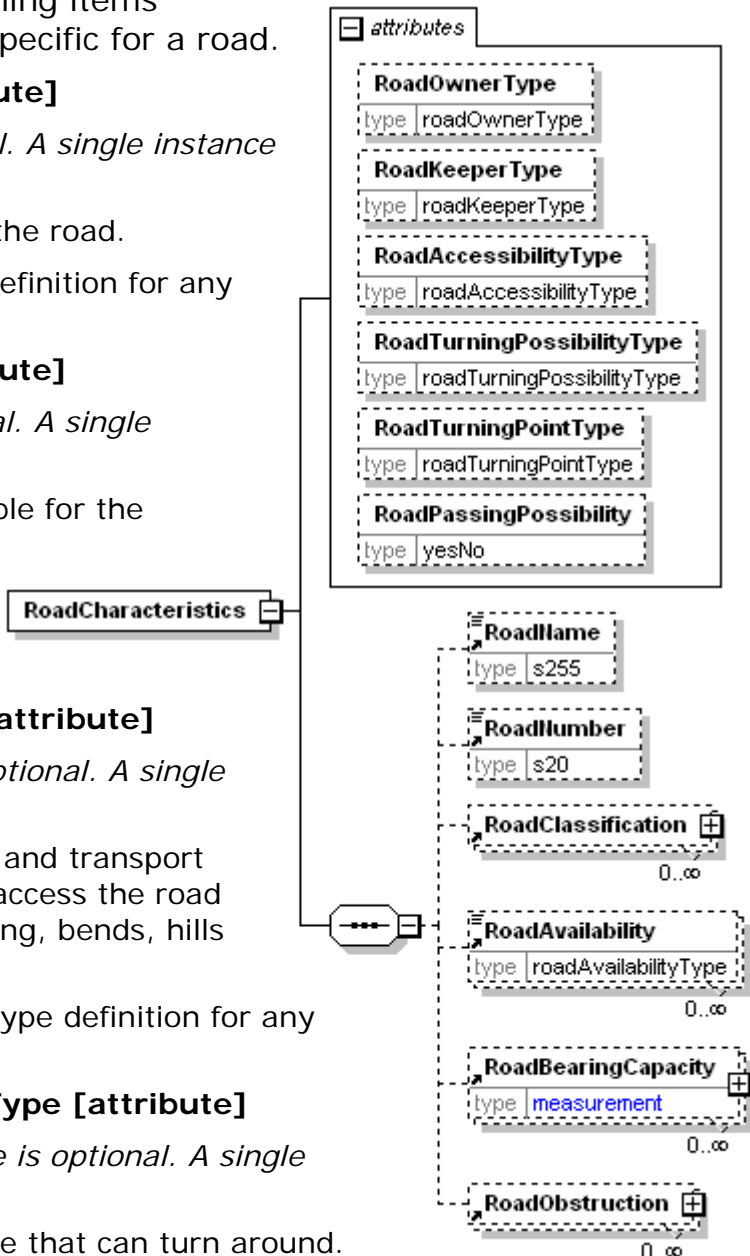

Refer to RoadTurningPointType definition for any enumerations.

RoadPassingPossibility [attribute]

RoadPassingPossibility is optional. A single instance might exist.

Defines if it is possible for two vehicles to pass each other on the road.

Refer to RoadPassingPossibility definition for any enumerations.

(sequence)

The sequence of items below is mandatory. A single instance is required.

RoadName

RoadName is optional. A single instance might exist.

Defines the name of the road.

RoadNumber

RoadNumber is optional. A single instance might exist.

Defines the official number of the road.

RoadClassification

RoadClassification is optional. Multiple instances might exist.

Grouping element for items describing how roads are classified.

RoadAvailability

RoadAvailability is optional. Multiple instances might exist.

Defines when in the year or season the road is available.

Refer to RoadAvailability definition for any enumerations.

RoadBearingCapacity

RoadBearingCapacity is optional. Multiple instances might exist.

The capacity for the road to bear a load without being damaged.

RoadObstruction

RoadObstruction is optional. Multiple instances might exist.

A grouping element containing items describing details for an obstruction on a road. If a MapPoint or MapCoordinates are specified then it marks the start point of the obstruction

RoadClassification

Grouping element for items describing how roads are classified.

(sequence)

The sequence of items below is mandatory. A single instance is required.

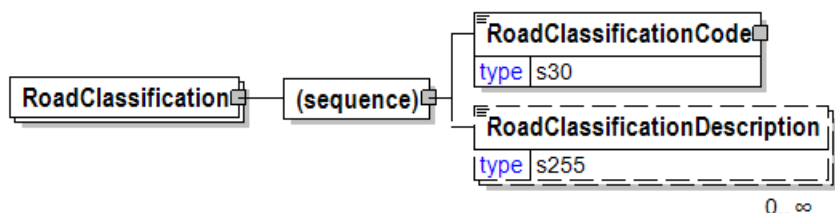

RoadClassificationCode

RoadClassificationCode is mandatory. A single instance is required.

Classification code for the road. Code is assigned by agency.

RoadClassificationDescription

RoadClassificationDescription is optional. Multiple instances might exist.

Description of the road classification.

RoadClassificationCode

Classification code for the road. Code is assigned by agency.

Agency [attribute]

Agency is mandatory. A single instance is required.

Describes the agency maintaining the list of codes. To be included in this list the agency must be a recognized standards body or industry organisation.

For the element that owns this attribute.

For another attribute in the list of attributes associated with the parent element.

Refer to Agency definition for any enumerations.

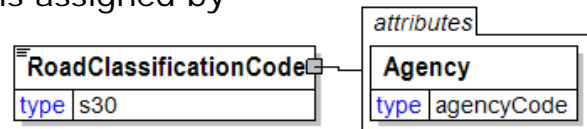

RoadClassificationDescription

Description of the road classification.

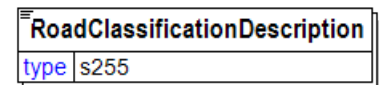

RoadKeeperType [attribute]

Defines the party responsible for the maintenance of the road.

This item is restricted to the following list.

Public

Private



RoadName

Defines the name of the road.

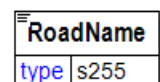

RoadNumber

Defines the official number of the road.

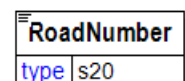

RoadObstruction

A grouping element containing items describing details for an obstruction on a road. If a MapPoint or MapCoordinates are specified then it marks the start point of the obstruction.

RoadObstructionType [attribute]

RoadObstructionType is required. A single instance must exist.

Defines the type of hazard or obstruction on a road.

(sequence)

The sequence of items below is mandatory. A single instance is required.

MapPointName

MapPointName is optional. A single instance might exist.

A unique name for a point on a map. It is also normally the name of the corresponding waypoint in a GPS.

MapPointComment

MapPointComment is optional. Multiple instances might exist.

A descriptive text for a point on a map. It is also normally shown in a GPS as a comment for the corresponding waypoint.

MapCoordinates

MapCoordinates is optional. Multiple instances might exist.

A group item defining and containing position coordinates of a location.

RoadSlopePercent

RoadSlopePercent is optional. A single instance may exist.

Specifies the gradient in percent for a road. A positive value indicates an uphill slope and a negative value a downhill slope

RoadBearingCapacity

RoadBearingCapacity is optional. Multiple instances might exist.

The capacity for the road to bear a load without being damaged.

Length

Length is optional. A single instance might exist.

The length of the object

Width

Width is optional. A single instance might exist.

The width of the object

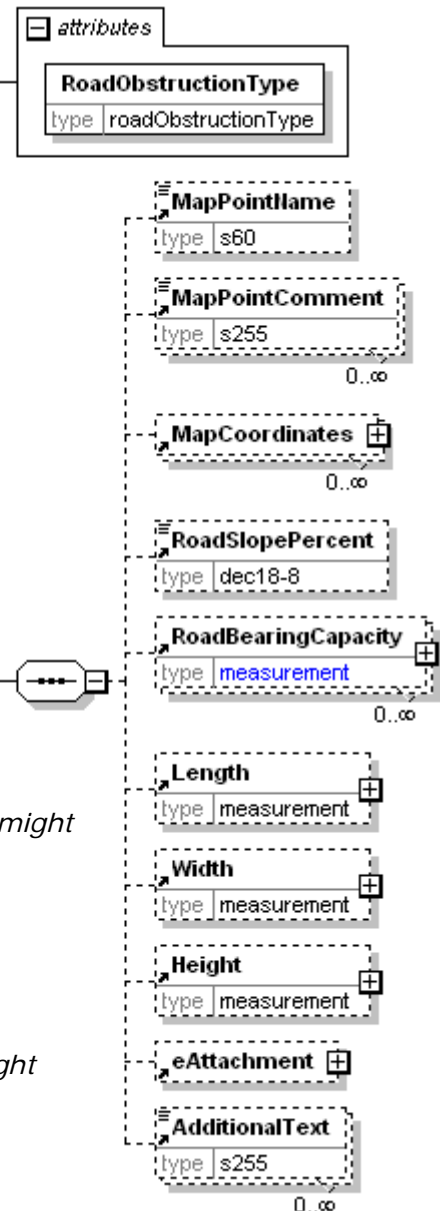
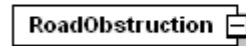

Height

Height is optional. A single instance might exist.

The height of the object.

eAttachment

eAttachment is optional. A single instance might exist.

eAttachment enables the sender to provide information about attachments to the document.

Note: An element "e-Attachment" also exists. papiNet will no longer use hyphens in our element and attribute names as this causes issues with BizTalk.

AdditionalText

AdditionalText is optional. Multiple instances might exist.

A text field that is used to communicate information not previously defined or for special instructions. To be used only for circumstances not covered by specific elements.

RoadObstructionType [attribute]

Defines the type of hazard or obstruction on a road.

This item is restricted to the following list.

Bridge

A bridge, e.g. for crossing over a river. A bridge might be restricted by width and bearing capacity.

Ferry

A ferry crossing with restrictions along a road. Typically restricted by width and bearing capacity.

Passage

A section or crossing with restrictions along a road. Typically restricted by width.

RoadWorks

Repairs to a road forming a hazard or obstruction to traffic.

Slope

A section of a road with a gradient forming obstruction to traffic

UnderPass

A section of a road that passes under another road, railway line, etc. Typically restricted by height and width.



RoadOwnerType [attribute]

Defines the ownership for the road.

This item is restricted to the following list.

Public

Private



RoadPassingPossibility [attribute]

Defines if it is possible for two vehicles to pass each other on the road.

This item is restricted to the following list.

Yes

No

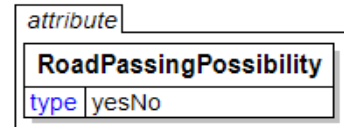

RoadSlopePercent

Specifies the gradient in percent for a road. A positive value indicates an uphill slope and a negative value a downhill slope.



RoadTurningPointType [attribute]

Defines the shape of the turning point.

This item is restricted to the following list.

Circle

Circle shaped turning place.

T-crossing

T-cross shaped intersection.

X-crossing

X-shaped intersection.



RoadTurningPossibilityType [attribute]

Defines what kind of vehicle that can turn around.

This item is restricted to the following list.

DrawBarCombination

Turning possibility for a drawbar combination.

DrawBarCombinationWithAdjustableBogie

Turning possibility for a drawbar combination with trailer equipped with adjustable bogie.

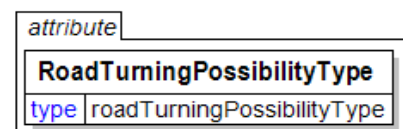

NoTurningPossibility

There is no turning possibility, the truck has to go in reverse direction when returning.

RigidLorry

Turning possibility for a rigid lorry without trailer.

ThroughAccessNoTurning

There is a through access but no turning possibility.

Trailer

Turning possibility for a truck with trailer.

Roof

Defines parts and complete roofing systems.

(sequence)

The sequence of items below is mandatory. A single instance is required.

(choice)

[choice] is optional because of choice construct.

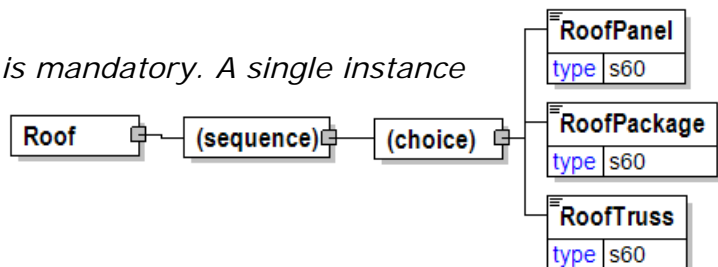

RoofPanel

RoofPanel is optional because of choice construct.

Describes the roofing surface.

RoofPackage

RoofPackage is optional because of choice construct.

Roof package

RoofTruss

RoofTruss is optional because of choice construct.

Describes the supporting material under roofing surface.

RoofingSidingDeckingFencing

A grouping element that contains the timber/lumber products that are used in roofing, siding, decking, or fencing.

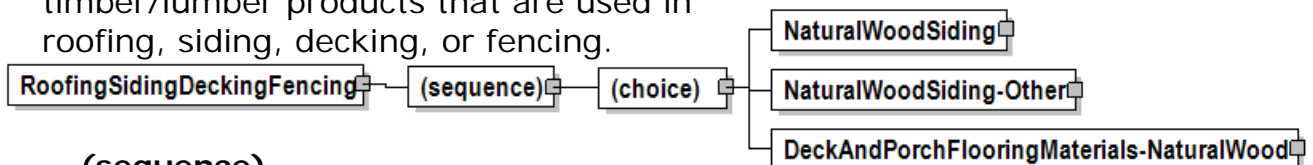

(sequence)

The sequence of items below is mandatory. A single instance is required.

(choice)

[choice] is optional because of choice construct.

NaturalWoodSiding

NaturalWoodSiding is optional because of choice construct.

Natural wood siding

NaturalWoodSiding-Other

NaturalWoodSiding-Other is optional because of choice construct.

Natural Wood Siding - Other

DeckAndPorchFlooringMaterials-NaturalWood

DeckAndPorchFlooringMaterials-NaturalWood is optional because of choice construct.

Deck and porch flooring materials that are used in natural wood products.

RoofPackage

Roof package

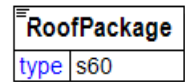

RoofPanel

Describes the roofing surface.

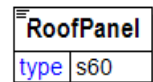

RoofTruss

Describes the supporting material under roofing surface.

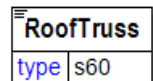

Roughness

A group item used to communicate surface roughness target or test value according to a particular TestMethod.

TestMethod [attribute]

TestMethod is optional. A single instance might exist.

The method used to determine the results of the test under consideration.

TestAgency [attribute]

TestAgency is optional. A single instance might exist.

The agency that has set the parameters for the testing

Refer to TestAgency definition for any enumerations.

SampleType [attribute]

SampleType is optional. A single instance might exist.

Communicates how sampling was done to measure the product characteristics.

Refer to SampleType definition for any enumerations.

ResultSource [attribute]

ResultSource is optional. A single instance might exist.

Used to define the data source of the specified test

Refer to ResultSource definition for any enumerations.

(sequence)

The sequence of items below is mandatory. A single instance is required.

DetailValue

DetailValue is mandatory. A single instance is required.

A numeric value expressed in the unit of measure (UOM).

DetailRangeMin

DetailRangeMin is optional. A single instance might exist.

The minimum value (lower boundary) allowed for the DetailValue that is the parent of this element.

DetailRangeMax

DetailRangeMax is optional. A single instance might exist.

The maximum value (upper boundary) allowed for the DetailValue that is the parent of this element.

StandardDeviation

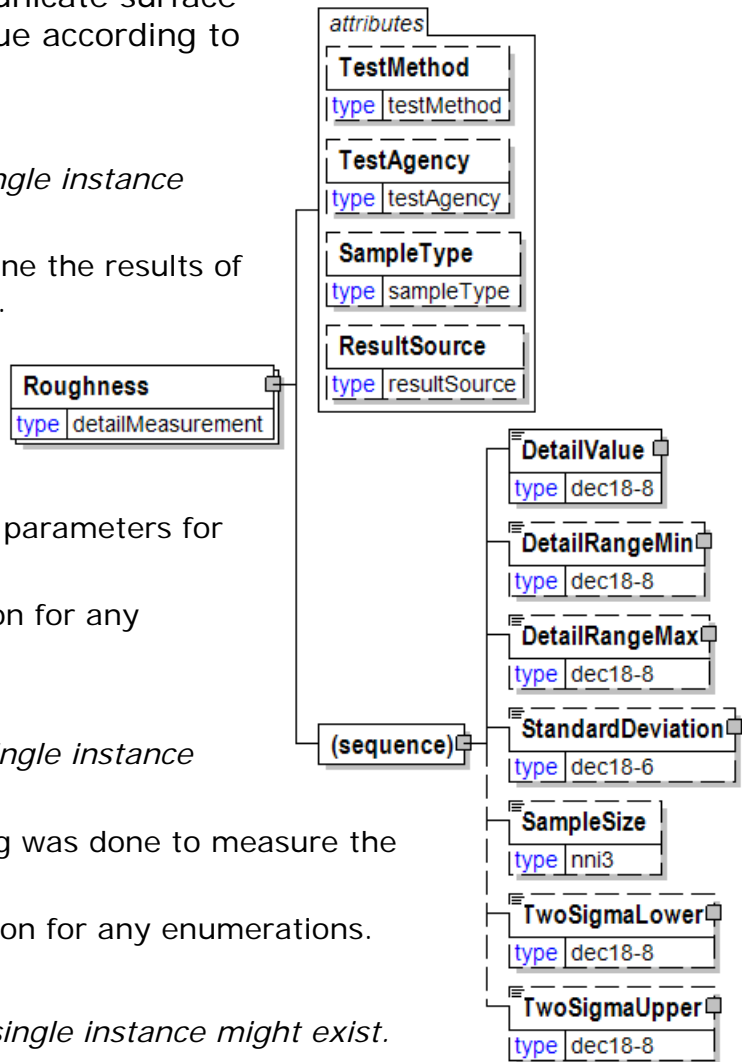

papiNet V2R31

StandardDeviation is optional. A single instance might exist.

A statistic used as a measure of dispersion in a distribution.

SampleSize

SampleSize is optional. A single instance might exist.

The number of samples used to determine the product characteristic in question.

TwoSigmaLower

TwoSigmaLower is optional. A single instance might exist.

Two sigma (a measure of dispersion associated with standard deviation) on the lower side of the standard deviation.

TwoSigmaUpper

TwoSigmaUpper is optional. A single instance might exist.

Two sigma (a measure of dispersion associated with standard deviation) on the upper side of the standard deviation.

RoundCornered [attribute]

Is the item round cornered?

This item is restricted to the following list.

Yes

No

attribute
RoundCornered
type yesNo

Route

Route defines directions and characteristics for how to transport goods between two locations. A route starts at delivery origin or at the supplypoint belonging to the delivery origin.

RouteType [attribute]

RouteType is mandatory. A single instance is required.

Defines type of start and end points for the route.

Refer to RouteType definition for any enumerations.

(sequence)

The sequence of items below is mandatory. A single instance is required.

RouteName

RouteName is mandatory. A single instance is required.

A unique name of a route. It is also normally the name of the route in a GPS.

RouteComment

RouteComment is optional. Multiple instances might exist.

A descriptive text for a route. It is also normally shown in a GPS as a route comment.

SupplyPoint

SupplyPoint is optional. A two instance might exist.

Grouping element that contains items describing a supply point. A SupplyPoint belongs to a LocationParty, e.g. in a DeliveryOrigin or DeliveryDestination, and describes where goods are stored and can be loaded or unloaded. A SupplyPoint can for example be a loading or unloading gate at a warehouse or a road side landing at a logging area in the forest.

MapPoint

MapPoint is optional. Multiple instances might exist.

A grouping element for items describing a point on a map. A mappoint is normally named waypoint in a GPS.

RouteLength

RouteLength is optional. A single instance might exist.

The length for the route.

RouteDefinition

RouteDefinition is optional. A single instance might exist.

List of waypoints describing the route.

eAttachment

eAttachment is optional. A single instance might exist.

eAttachment enables the sender to provide information about attachments to the document.

Note: An element "e-Attachment" also exists. papiNet will no longer use hyphens in our element and attribute names as this casues issues with BizTalk.

RouteLeg

RouteLeg is optional. Multiple instances might exist.

A grouping element contains items describing the route leg. A route leg is a part of a route. A route leg has its own characteristics.

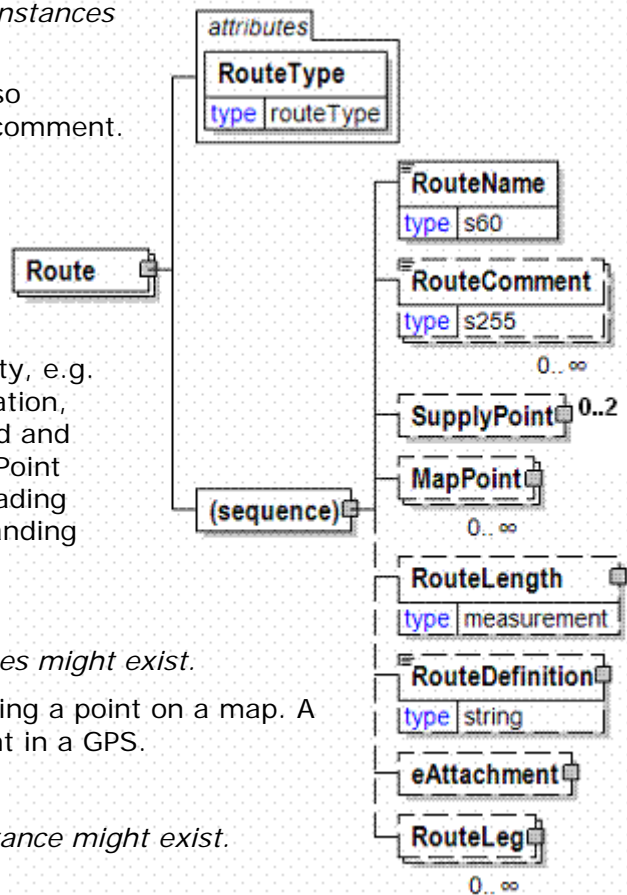

RouteComment

A descriptive text for a route. It is also normally shown in a GPS as a route comment.

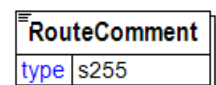

RouteDefinition

List of waypoints describing the route.

RouteDefinitionFormat [attribute]

RouteDefinitionFormat is mandatory. A single instance is required.

The format of the RouteDefinition.

Refer to RouteDefinitionFormat definition for any enumerations.

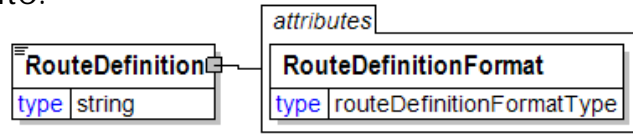

RouteDefinitionFormat [attribute]

The format of the RouteDefinition.

This item is restricted to the following list.

gpx

GPX (the GPS Exchange Format) is a light-weight XML data format for the interchange of GPS data (waypoints, routes, and tracks) between applications and Web services on the Internet.

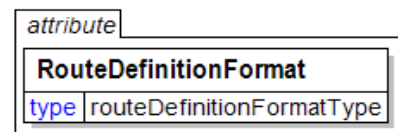

RouteLeg

A grouping element contains items describing the route leg. A route leg is a part of a route. A route leg has its own characteristics.

(sequence)

The sequence of items below is mandatory. A single instance is required.

RouteLegNumber

RouteLegNumber is mandatory. A single instance is required.

A sequential number for the legs of the route.

RouteLegName

RouteLegName is optional. A single instance might exist.

A unique name for a route leg.

OtherParty

OtherParty is optional. Multiple instances might exist.

An organisation or business entity other than those specifically detailed within a e-Document.

MapPoint

MapPoint is optional. Multiple instances might exist.

A grouping element for items describing a point on a map. A mappoint is normally named waypoint in a GPS.

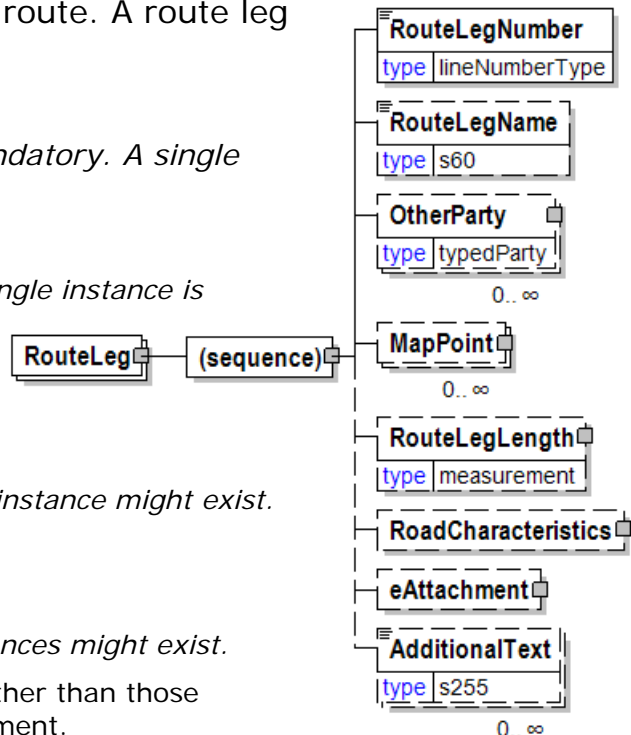

RouteLegLength

RouteLegLength is optional. A single instance might exist.

The length for the route leg.

RoadCharacteristics

RoadCharacteristics is optional. A single instance might exist.

A grouping element containing items describing characteristics specific for a road.

eAttachment

eAttachment is optional. A single instance might exist.

eAttachment enables the sender to provide information about attachments to the document.

Note: An element "e-Attachment" also exists. papiNet will no longer use hyphens in our element and attribute names as this causes issues with BizTalk.

AdditionalText

AdditionalText is optional. Multiple instances might exist.

A text field that is used to communicate information not previously defined or for special instructions. To be used only for circumstances not covered by specific elements.

RouteLegLength

The length for the route leg.

(sequence)

The sequence of items below is mandatory. A single instance is required.

Value

Value is mandatory. A single instance is required.

A numeric value expressed in the unit of measure (UOM).

RangeMin

RangeMin is optional. A single instance might exist.

The minimum value (lower boundary) allowed for the Measurement that is the parent of this element.

RangeMax

RangeMax is optional. A single instance might exist.

The maximum value (upper boundary) allowed for the Measurement that is the parent of this element. Some elements use the RangeMax element with an extended list of unit of measures. (Note: the red colour in the picture is an artifact of how the graphic was captured and should be disregarded.)

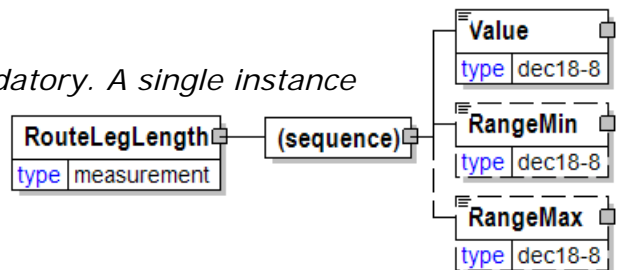

RouteLegName

A unique name for a route leg.

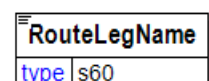

RouteLegNumber

A sequential number for the legs of the route.

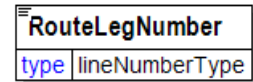

RouteLength

The length for the route.

(sequence)

The sequence of items below is mandatory. A single instance is required.

Value

Value is mandatory. A single instance is required.

A numeric value expressed in the unit of measure (UOM).

RangeMin

RangeMin is optional. A single instance might exist.

The minimum value (lower boundary) allowed for the Measurement that is the parent of this element.

RangeMax

RangeMax is optional. A single instance might exist.

The maximum value (upper boundary) allowed for the Measurement that is the parent of this element. Some elements use the RangeMax element with an extended list of unit of measures. (Note: the red colour in the picture is an artifact of how the graphic was captured and should be disregarded.)

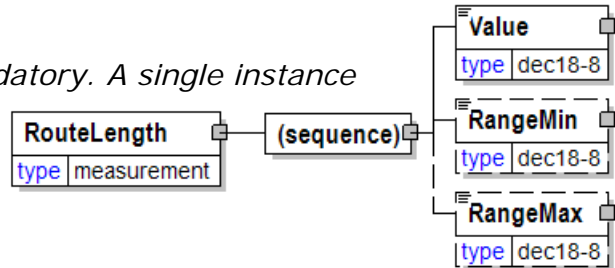

RouteName

A unique name of a route. It is also normally the name of the route in a GPS.

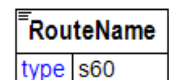

RouteType [attribute]

Defines type of start and end points for the route.

This item is restricted to the following list.

DeliveryOriginToDeliveryDestination

The route is specified from a delivery origin to a delivery destination.

DeliveryOriginToMainIntersection

The route is specified from a delivery origin to a main road intersection.

MainIntersectionToDeliveryDestination

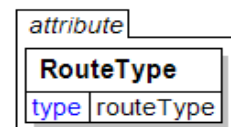

The route is specified from a main road intersection to a delivery destination.

SupplyPointToDeliveryDestination

The route is specified from a supply point within a delivery origin to a delivery destination.

SupplyPointToMainIntersection

The route is specified from a supply point within a delivery origin to a main road intersection.

RowsPerUnit

The number of rows of items, are to be placed/packaged within the unit. Usually used to identify the standard number of rows in a standard packaging unit of the product.

RowsPerUnit	
type	nonNegativeInteger

RunnabilityIndex

A group item used to communicate the calculated run-ability index target or test value.

TestMethod [attribute]

TestMethod is optional. A single instance might exist.

The method used to determine the results of the test under consideration.

TestAgency [attribute]

TestAgency is optional. A single instance might exist.

The agency that has set the parameters for the testing

Refer to TestAgency definition for any enumerations.

SampleType [attribute]

SampleType is optional. A single instance might exist.

Communicates how sampling was done to measure the product characteristics.

Refer to SampleType definition for any enumerations.

ResultSource [attribute]

ResultSource is optional. A single instance might exist.

Used to define the data source of the specified test

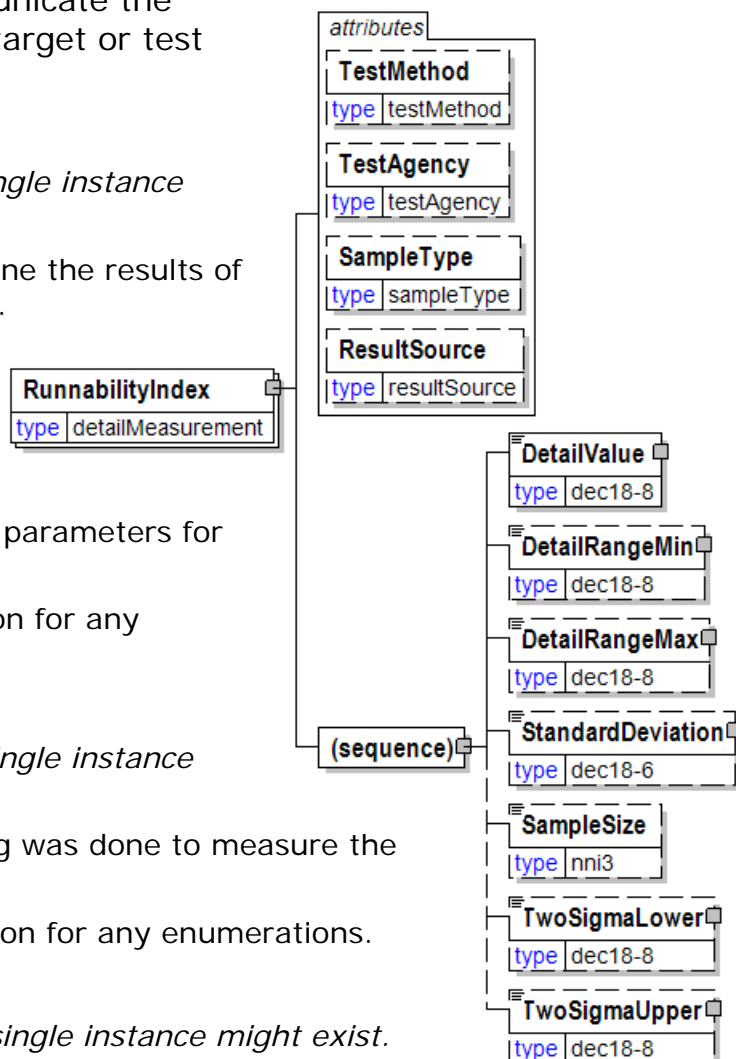

papiNet V2R31

Refer to ResultSource definition for any enumerations.

(sequence)

The sequence of items below is mandatory. A single instance is required.

DetailValue

DetailValue is mandatory. A single instance is required.

A numeric value expressed in the unit of measure (UOM).

DetailRangeMin

DetailRangeMin is optional. A single instance might exist.

The minimum value (lower boundary) allowed for the DetailValue that is the parent of this element.

DetailRangeMax

DetailRangeMax is optional. A single instance might exist.

The maximum value (upper boundary) allowed for the DetailValue that is the parent of this element.

StandardDeviation

StandardDeviation is optional. A single instance might exist.

A statistic used as a measure of dispersion in a distribution.

SampleSize

SampleSize is optional. A single instance might exist.

The number of samples used to determine the product characteristic in question.

TwoSigmaLower

TwoSigmaLower is optional. A single instance might exist.

Two sigma (a measure of dispersion associated with standard deviation) on the lower side of the standard deviation.

TwoSigmaUpper

TwoSigmaUpper is optional. A single instance might exist.

Two sigma (a measure of dispersion associated with standard deviation) on the upper side of the standard deviation.

SafetyAndEnvironmentalCertification

Safety and Environmental Certification

(sequence)

The sequence of items below is mandatory. A single instance is required.

Value

Value is mandatory. A single instance is required.

A numeric value expressed in the unit of measure (UOM).

RangeMin

RangeMin is optional. A single instance might exist.

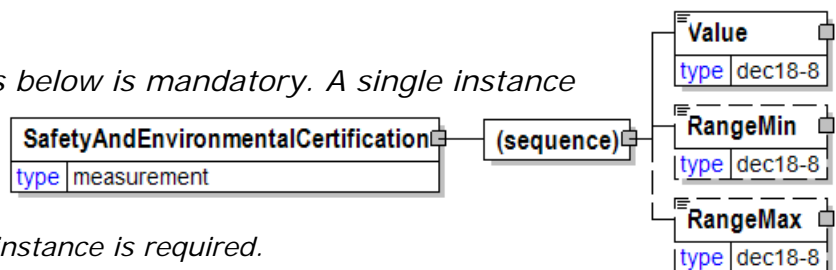

The minimum value (lower boundary) allowed for the Measurement that is the parent of this element.

RangeMax

RangeMax is optional. A single instance might exist.

The maximum value (upper boundary) allowed for the Measurement that is the parent of this element. Some elements use the RangeMax element with an extended list of unit of measures. (Note: the red colour in the picture is an artifact of how the graphic was captured and should be disregarded.)

SafetyAndEnvironmentalInformation

Name of certification type, if any, on the goods (For example, FSC, PEFC). SafetyAndEnvironmental needs a value or measurement



to communicate the percentage of the product is certified (for example, 75% is certified by the indicated agency).



SafetyAndEnvironmentalType [attribute]

SafetyAndEnvironmentalType is mandatory. A single instance is required.

The type of safety and environmental information being communicated. Defines any additional information relating to safety and/or environmental matters.

Refer to SafetyAndEnvironmentalType definition for any enumerations.

Agency [attribute]

Agency is mandatory. A single instance is required.

Describes the agency maintaining the list of codes. To be included in this list the agency must be a recognized standards body or industry organisation.

For the element that owns this attribute.

For another attribute in the list of attributes associated with the parent element.

Refer to Agency definition for any enumerations.

(sequence)

The sequence of items below is mandatory. A single instance is required.

LicenceNumber

LicenceNumber is optional. A single instance might exist.

Licence number.

Note: the spelling of this element conforms to papiNet's use of UK English.

ChainOfCustody

ChainOfCustody is optional. A single instance might exist.

The chain of custody.

SafetyAndEnvironmentalCertification

SafetyAndEnvironmentalCertification is optional. A single instance might exist.

Safety and Environmental Certification

AdditionalText

AdditionalText is optional. Multiple instances might exist.

A text field that is used to communicate information not previously defined or for special instructions. To be used only for circumstances not covered by specific elements.

SafetyAndEnvironmentalType [attribute]

The type of safety and environmental information being communicated. Defines any additional information relating to safety and/or environmental matters.



This item is restricted to the following list.

Agricultural

Biodegradable

Certified

Chemical

CSA

Canadian Standards Authority

Energy

FlamabilityReactivity

FSC

To be deprecated in a future version use FSCMixed, FSCPure, or FSCRecycled.

FSC100%

FSC-certified virgin material originating in FSC-certified forests or plantations that has not been mixed with material of another material category throughout the supply chain. FSC 100% products are eligible to be used in FSC 100% or FSC Mix product groups.

(Forest Stewardship Council, <http://www.fsc.org>).

FSCControlledWood

Material originating in non FSC-certified forests or plantations supplied with an FSC claim by a supplier which has been assessed by an FSC-accredited

papiNet V2R31

certification body for conformity with FSC Chain of Custody and/or FSC Controlled Wood requirements (FSC-STD-40-005 or FSC-STD-30-010). (Forest Stewardship Council, <http://www.fsc.org>).

FSCMix_x%

FSC-certified virgin material based on input from FSC-certified, controlled and/or reclaimed sources, and supplied with a percentage claim. FSC Mix material is only eligible to be used in FSC Mix product groups. (Forest Stewardship Council, <http://www.fsc.org>)

FSCMixCredit

FSC-certified virgin material based on input from FSC-certified, controlled and/or reclaimed sources, and supplied with a credit claim. FSC Mix material is only eligible to be used in FSC Mix product groups. (Forest Stewardship Council, <http://www.fsc.org>)

FSCMixed

Material contains a mixture of Forest Stewardship Council (FSC) certified material, reclaimed (recycled) material and/or controlled wood. It has been processed by an FSC chain of custody certified company, and has been identified as FSC Mixed.

For more information about the Forest Stewardship Council, visit www.fsc.org.

FSCPure

Material is 100% FSC material from a Forest Stewardship Council (FSC) certified forest. It has been sold and/or processed by an FSC chain of custody certified company, and has been identified as FSC Pure.

For more information about the Forest Stewardship Council, visit <http://www.fsc.org>.

FSCRecycled

This Forest Stewardship Council (FSC) product group contains 100% post-consumer reclaimed. Post-consumer reclaimed material includes wood and/or wood fiber that has been reclaimed from a product after that product has been used for its intended end-use purpose by individuals or businesses.

For more information about the Forest Stewardship Council, visit www.fsc.org.

FSCRecycled_x%

FSC-certified reclaimed material based on exclusive input from reclaimed sources, and supplied with a percentage claim. FSC Recycled material or products are eligible to be used in FSC Mix or FSC Recycled product groups. (Forest Stewardship Council, <http://www.fsc.org>)

FSCRecycledCredit

FSC-certified reclaimed material based on exclusive input from reclaimed sources, and supplied with a credit claim. FSC Recycled material or products are eligible to be used in FSC Mix or FSC Recycled product groups. (Forest Stewardship Council, <http://www.fsc.org>)

HazardousMaterial

MaterialSafetyData

MTCC

papiNet V2R31

Malaysian Timber Certification Council

PEFC

Program for the Endorsement of Forest Certification

Recycled

SFI

Sustainable Forestry Initiative

TransportationSafetyAlert

X%_PEFCcertified

The claim "x % PEFC certified" shall be used when communicating the content of PEFC certified material.

Programme for the Endorsement of Forest Certification, <http://www.pefc.org>).

SalesOfficeParty

This named party represents the sales office involved in the business transaction. This party is only used in the communication of OrderStatus otherwise it is handled via OtherParty.

LogisticsRole [attribute]

LogisticsRole is optional. A single instance might exist.

Communicates the nature of the logistics role, if any, the party plays in the transaction.

Refer to LogisticsRole definition for any enumerations.

(sequence)

The sequence of items below is mandatory. A single instance is required.

PartyIdentifier

PartyIdentifier is optional. Multiple instances might exist.

A unique identifier of a specific party. This element contains an attribute PartyIdentifierType that indicates the type of party.

NameAddress

NameAddress is mandatory. A single instance is required.

A group item containing name and address of an organisation or business entity.

URL

URL is optional. A single instance might exist.

Universal Resource Locator. While typically a web address you could use this field to hold an email address.

CommonContact

CommonContact is optional. Multiple instances might exist.

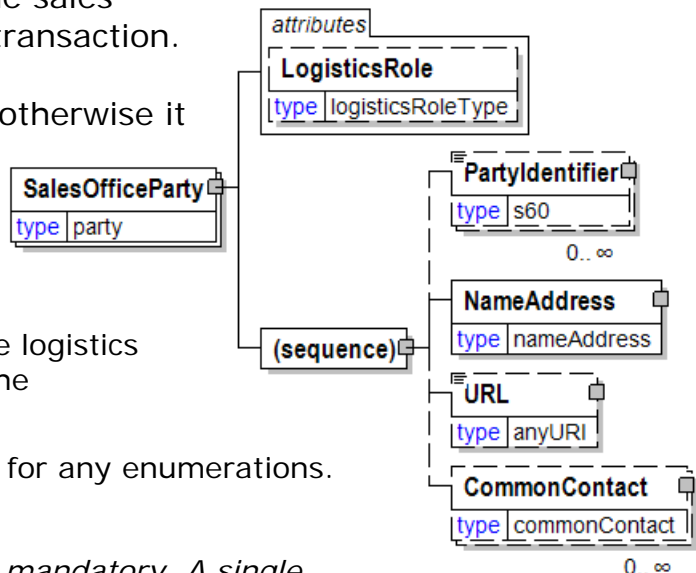

papiNet V2R31

Identifies a specific individual associated with the party.

SampleSize

The number of samples used to determine the product characteristic in question.

SampleSize
type nni3

SampleType [attribute]

Communicates how sampling was done to measure the product characteristics.

This item is restricted to the following list.

attribute
SampleType
type sampleType

Average

The measurement represents an average for the associated property.

Bottom

The measurement was obtained from the bottom of the paper sample.

CDAverage

The measurement represents the average of values in the cross-machine direction.

CDBottom

The measurement represents the average of tests taken in the cross-machine direction on the bottom of the paper sample.

CDTop

The measurement represents the average of tests taken in the cross-machine direction on the top of the paper sample.

MDAverage

The measurement represents the average of values in the machine direction.

MDBottom

The measurement represents the average of tests taken in the machine direction on the bottom of the paper sample.

MDTop

The measurement represents the average of tests taken in the machine direction on the top of the paper sample.

Target

When communicating specifications a target value is communicated.

Top

The measurement was obtained from the top of the paper sample

Saturation

Measure of colour Saturation in the HSB method of communicating colour.

(sequence)

The sequence of items below is mandatory. A single instance is required.

DetailValue

DetailValue is mandatory. A single instance is required.

A numeric value expressed in the unit of measure (UOM).

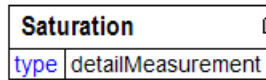

(sequence)

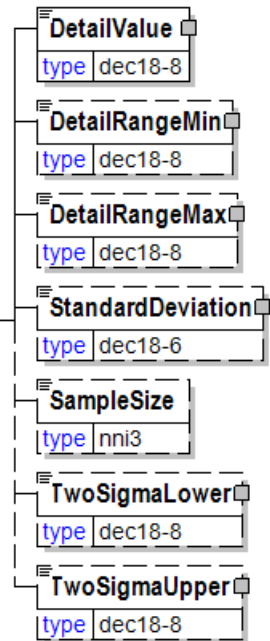

DetailRangeMin

DetailRangeMin is optional. A single instance might exist.

The minimum value (lower boundary) allowed for the DetailValue that is the parent of this element.

DetailRangeMax

DetailRangeMax is optional. A single instance might exist.

The maximum value (upper boundary) allowed for the DetailValue that is the parent of this element.

StandardDeviation

StandardDeviation is optional. A single instance might exist.

A statistic used as a measure of dispersion in a distribution.

SampleSize

SampleSize is optional. A single instance might exist.

The number of samples used to determine the product characteristic in question.

TwoSigmaLower

TwoSigmaLower is optional. A single instance might exist.

Two sigma (a measure of dispersion associated with standard deviation) on the lower side of the standard deviation.

TwoSigmaUpper

TwoSigmaUpper is optional. A single instance might exist.

Two sigma (a measure of dispersion associated with standard deviation) on the upper side of the standard deviation.

Sawdust

Used to report sawdust content in chips as a detail measurement.

TestMethod [attribute]

TestMethod is optional. A single instance might exist.

The method used to determine the results of the test under consideration.

TestAgency [attribute]

TestAgency is optional. A single instance might exist.

The agency that has set the parameters for the testing

Refer to TestAgency definition for any enumerations.

SampleType [attribute]

SampleType is optional. A single instance might exist.

Communicates how sampling was done to measure the product characteristics.

Refer to SampleType definition for any enumerations.

ResultSource [attribute]

ResultSource is optional. A single instance might exist.

Used to define the data source of the specified test

Refer to ResultSource definition for any enumerations.

(sequence)

The sequence of items below is mandatory. A single instance is required.

DetailValue

DetailValue is mandatory. A single instance is required.

A numeric value expressed in the unit of measure (UOM).

DetailRangeMin

DetailRangeMin is optional. A single instance might exist.

The minimum value (lower boundary) allowed for the DetailValue that is the parent of this element.

DetailRangeMax

DetailRangeMax is optional. A single instance might exist.

The maximum value (upper boundary) allowed for the DetailValue that is the parent of this element.

StandardDeviation

StandardDeviation is optional. A single instance might exist.

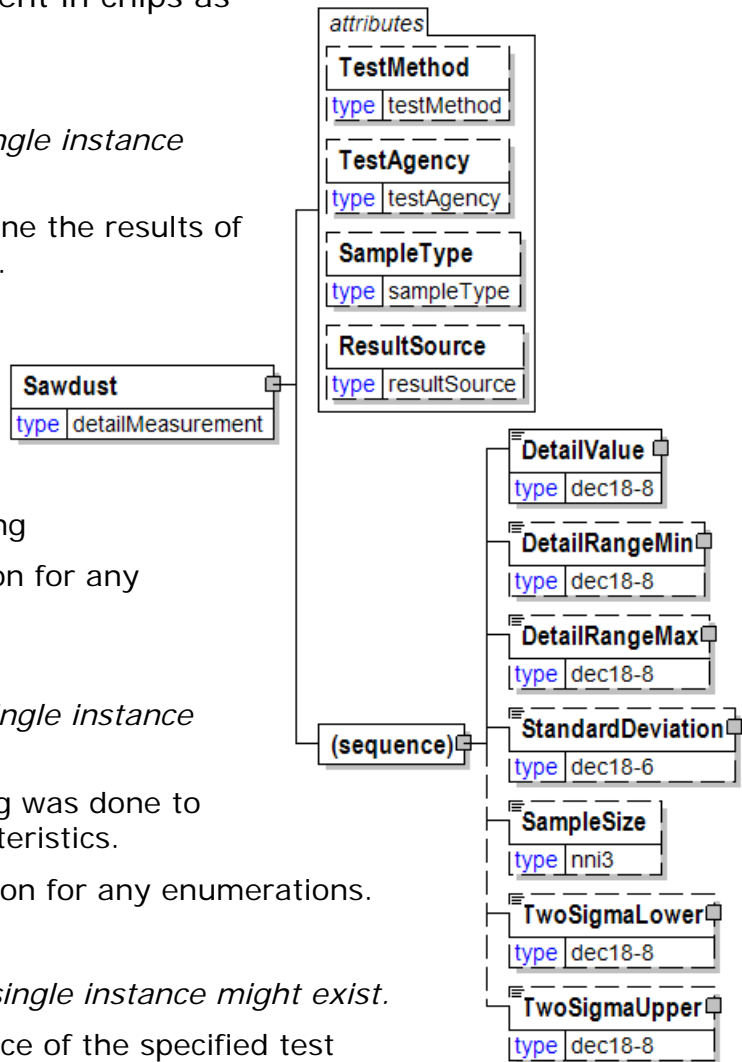

A statistic used as a measure of dispersion in a distribution.

SampleSize

SampleSize is optional. A single instance might exist.

The number of samples used to determine the product characteristic in question.

TwoSigmaLower

TwoSigmaLower is optional. A single instance might exist.

Two sigma (a measure of dispersion associated with standard deviation) on the lower side of the standard deviation.

TwoSigmaUpper

TwoSigmaUpper is optional. A single instance might exist.

Two sigma (a measure of dispersion associated with standard deviation) on the upper side of the standard deviation.

ScaleHouseID

Unique identifier for the specific scale house.

ScaleHouseID
type s60

ScaleHouseIn

Used to identify scale weight received into a yard, the scale house id, name, and scaler name.

(sequence)

The sequence of items below is mandatory. A single instance is required.

ScaleHouseID

ScaleHouseID is optional. A single instance might exist.

Unique identifier for the specific scale house.

ScaleHouseName

ScaleHouseName is optional. A single instance might exist.

Name assigned to the scale house.

ScalerID

ScalerID is optional. A single instance might exist.

Unique identifier for the person staffing the scale house. Might be an employee number.

ScalerName

ScalerName is optional. A single instance might exist.

Name of the person staffing the scale house.

Quantity

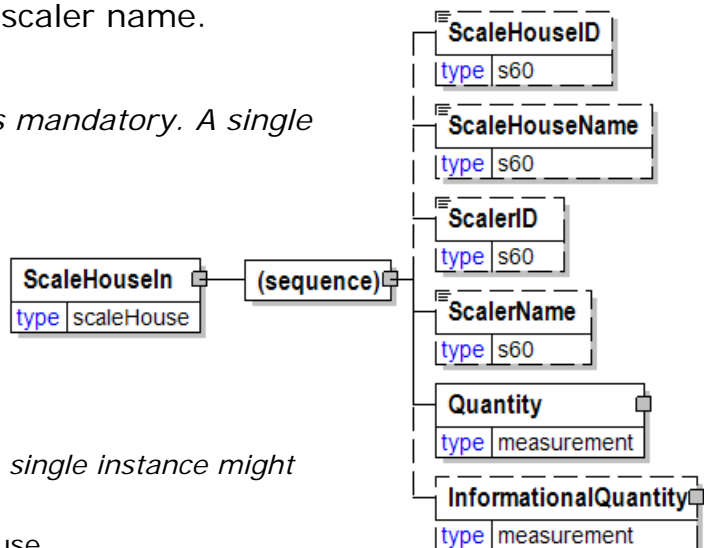

Quantity is mandatory. A single instance is required.

The Quantity element contains attributes that provide information about the type of quantity that is being communicated, the context in which the particular quantity is to be viewed, and (if the quantity represents an adjustment) an adjustment type.

The Quantity element contains three child elements that enable you to communicate a range of values for the quantity and a target or actual value. It is at this level (Value, RangeMin, and RangeMax) that the unit of measure is specified. This permits the range to be specified in a different unit of measure than the target.

InformationalQuantity

InformationalQuantity is optional. A single instance might exist.

A quantity given in a valid UOM used for information purposes only (not for calculation). For example, an ordered quantity was 100 reels as opposed to the invoice quantity of 20,000 pounds.

ScaleHouseInfo

Scale house information.

(sequence)

The sequence of items below is mandatory. A single instance is required.

ScaleHouseIn

ScaleHouseIn is optional. A single instance might exist.

Used to identify scale weight received into a yard, the scale house id, name, and scaler name.

ScaleHouseOut

ScaleHouseOut is optional. A single instance might exist.

Used to identify scale weight departing a yard, the scale house id, name, and scaler name.

ScaleHouseTicketNumber

ScaleHouseTicketNumber is optional. A single instance might exist.

The ticket number issued by the scale house. Does not have to be unique.

ArrivalDate

ArrivalDate is optional. A single instance might exist.

The date of arrival.

DepartureDate

DepartureDate is optional. A single instance might exist.

The required or actual date of departure.

Quantity

Quantity is mandatory. A single instance is required.

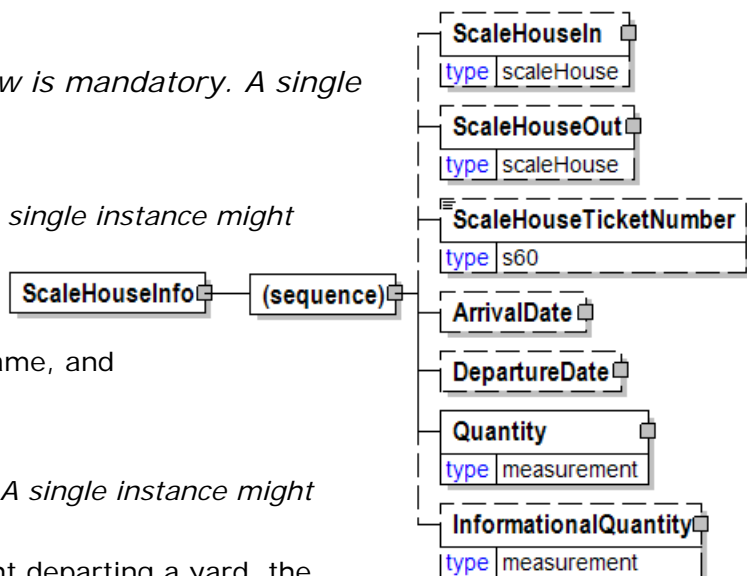

papiNet V2R31

The Quantity element contains attributes that provide information about the type of quantity that is being communicated, the context in which the particular quantity is to be viewed, and (if the quantity represents an adjustment) an adjustment type.

The Quantity element contains three child elements that enable you to communicate a range of values for the quantity and a target or actual value. It is at this level (Value, RangeMin, and RangeMax) that the unit of measure is specified. This permits the range to be specified in a different unit of measure than the target.

InformationalQuantity

InformationalQuantity is optional. A single instance might exist.

A quantity given in a valid UOM used for information purposes only (not for calculation). For example, an ordered quantity was 100 reels as opposed to the invoice quantity of 20,000 pounds.

ScaleHouseName

Name assigned to the scale house.

ScaleHouseName
type s60

ScaleHouseOut

Used to identify scale weight departing a yard, the scale house id, name, and scaler name.

(sequence)

The sequence of items below is mandatory. A single instance is required.

ScaleHouseID

ScaleHouseID is optional. A single instance might exist.

Unique identifier for the specific scale house.

ScaleHouseName

ScaleHouseName is optional. A single instance might exist.

Name assigned to the scale house.

ScalerID

ScalerID is optional. A single instance might exist.

Unique identifier for the person staffing the scale house. Might be an employee number.

ScalerName

ScalerName is optional. A single instance might exist.

Name of the person staffing the scale house.

Quantity

Quantity is mandatory. A single instance is required.

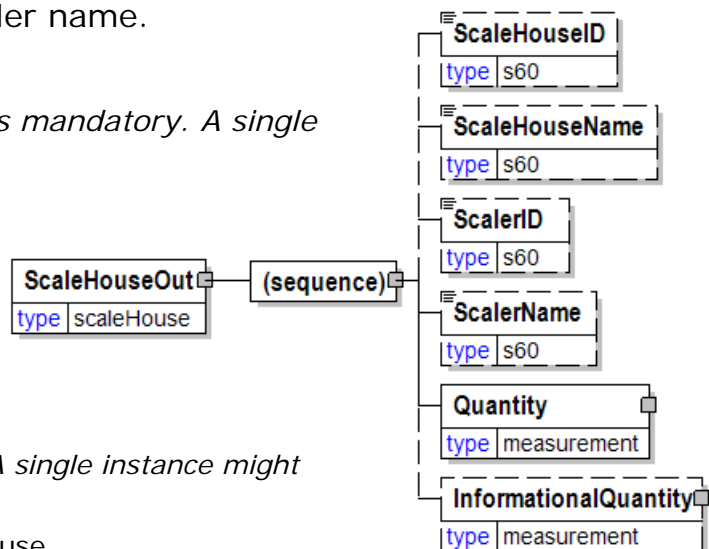

papiNet V2R31

The Quantity element contains attributes that provide information about the type of quantity that is being communicated, the context in which the particular quantity is to be viewed, and (if the quantity represents an adjustment) an adjustment type.

The Quantity element contains three child elements that enable you to communicate a range of values for the quantity and a target or actual value. It is at this level (Value, RangeMin, and RangeMax) that the unit of measure is specified. This permits the range to be specified in a different unit of measure than the target.

InformationalQuantity

InformationalQuantity is optional. A single instance might exist.

A quantity given in a valid UOM used for information purposes only (not for calculation). For example, an ordered quantity was 100 reels as opposed to the invoice quantity of 20,000 pounds.

ScaleHouseTicketNumber

The ticket number issued by the scale house. Does not have to be unique.

ScaleHouseTicketNumber	
type	s60

ScalerID

Unique identifier for the person staffing the scale house. Might be an employee number.

ScalerID	
type	s60

ScalerName

Name of the person staffing the scale house.

ScalerName	
type	s60

ScaleTicket

The ScaleTicket element is the root element for the ScaleTicket e-Document.

The ScaleTicket e-Document provides wood or fibre suppliers with a means to electronically incorporate scale system receiving data into their accounting systems from buying entities' back office systems.

ScaleTicketStatusType [attribute]

ScaleTicketStatusType is mandatory. A single instance is required.

ScaleTicket Status Type

Refer to ScaleTicketStatusType definition for any enumerations.

ScaleTicketAcceptance [attribute]

ScaleTicketAcceptance is mandatory. A single instance is required.

Defines the state of the goods received as compared to the DeliveryMessage specifications. The enumeration list is the list of choices that apply to the GoodsReceipt header and line item.

Refer to ScaleTicketAcceptance definition for any enumerations.

ScaleTicketRejectedType [attribute]

ScaleTicketRejectedType is optional. A single instance might exist.

ScaleTicketRejectedType

Refer to ScaleTicketRejectedType definition for any enumerations.

Reissued [attribute]

Reissued is optional. A single instance might exist.

Either "Yes" or "No".

Refer to Reissued definition for any enumerations.

Language [attribute]

Language is optional. A single instance might exist.

XML has embraced 2 and 3 digit language codes through the application of an addendum to the standard.

Refer to Language definition for any enumerations.

(sequence)

The sequence of items below is mandatory. A single instance is required.

ScaleTicketHeader

ScaleTicketHeader is mandatory. A single instance is required.

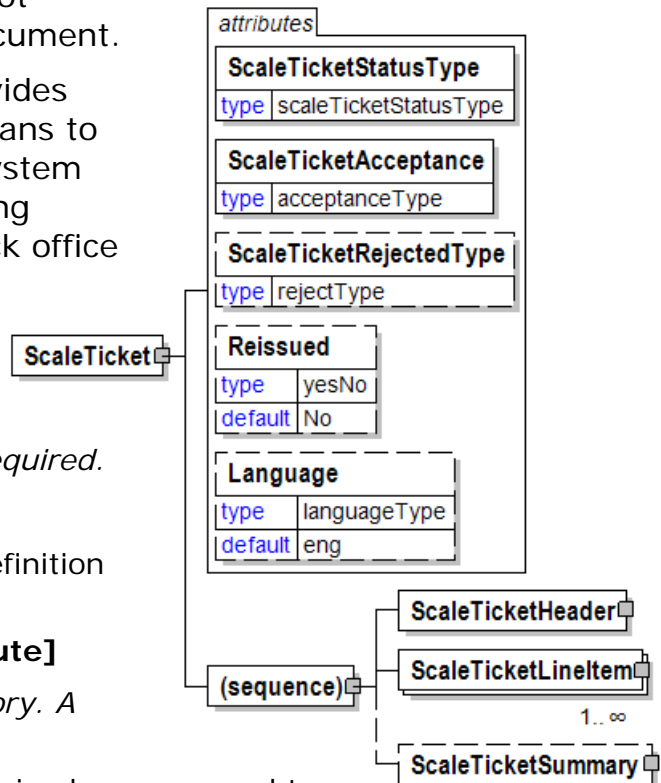

Information that is common for the ScaleTicket e-Document.

ScaleTicketLineItem

ScaleTicketLineItem is mandatory. One instance is required, multiple instances might exist.

The details for each item reported on a ScaleTicket e-Document.

ScaleTicketSummary

ScaleTicketSummary is optional. A single instance might exist.

Summary information for the ScaleTicket e-Document.

ScaleTicketAcceptance [attribute]

Defines the state of the goods received as compared to the DeliveryMessage specifications. The enumeration list is the list of choices that apply to the GoodsReceipt header and line item.

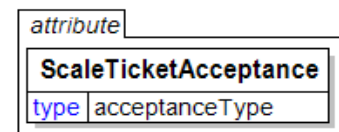

This item is restricted to the following list.

GoodsReceivedAsIs

The delivered goods were received without inspection, or checking of the goods for damage, or accuracy against the DeliveryMessage.

GoodsReceivedAsSpecified

Received goods agree completely with all DeliveryMessage specifications for all lines including item identifiers and item weights. There is no transit damage.

GoodsReceivedCancelled

Received goods notification is being cancelled. This value is only used when the GoodsReceiptStatusType is "Cancelled".

GoodsReceivedRejected

Received goods agree completely with all DeliveryMessage specifications for all lines including item identifiers and item weights; but there has been transit damage resulting in rejection of all goods.

GoodsReceivedWithDamage

Received goods agree completely with all DeliveryMessage specifications for all lines including item identifiers and item weights; but there has been transit damage of some items. All transit damages must be specified.

GoodsReceivedWithVariance

Received goods do not agree completely with the DeliveryMessage specifications. For those items at variance, actual received item identifiers and item weights must be specified.

Additionally, used with the VarianceType of "NotReceived" to indicate items that was on the DeliveryMessage but not in the Delivery as received.

GoodsReceivedWithVarianceAndDamage

Received goods do not agree completely with all DeliveryMessage specifications for all lines including item identifiers and item weights and there has been transit damage of some items. For those items at variance or with

transit damage, actual received item identifiers, item weights, and transit damages must be specified.

ScaleTicketHeader

Information that is common for the ScaleTicket e-Document.

(sequence)

The sequence of items below is mandatory. A single instance is required.

ScaleTicketNumber

ScaleTicketNumber is mandatory. A single instance is required.

Unique identifier for the ScaleTicket e-Document.

TransactionHistoryNumber

TransactionHistoryNumber is mandatory. A single instance is required.

A sequential number that keeps track of the version of a document being sent by the document originator except in the case where TransactionHistoryConfirmation is used, in which case the

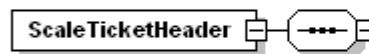

TransactionHistoryNumber refers to the trigger transaction for which the confirmation is being sent.

ScaleTicketIssueDate

ScaleTicketIssueDate is mandatory. A single instance is required.

The date and time when the ScaleTicket was issued.

ScaleTicketReference

ScaleTicketReference is optional. Multiple instances might exist.

An element that details the relevant references pertaining to the ScaleTicket.

Identifies the previous unique document ID that this document replaces, if applicable.

Mandatory if Purpose = Replace.

ScaleHouseInfo

ScaleHouseInfo is mandatory. A single instance is required.

Scale house information.

BuyerParty

BuyerParty is mandatory. A single instance is required.

The legal entity to which the product is sold. Also commonly referred to as the sold-

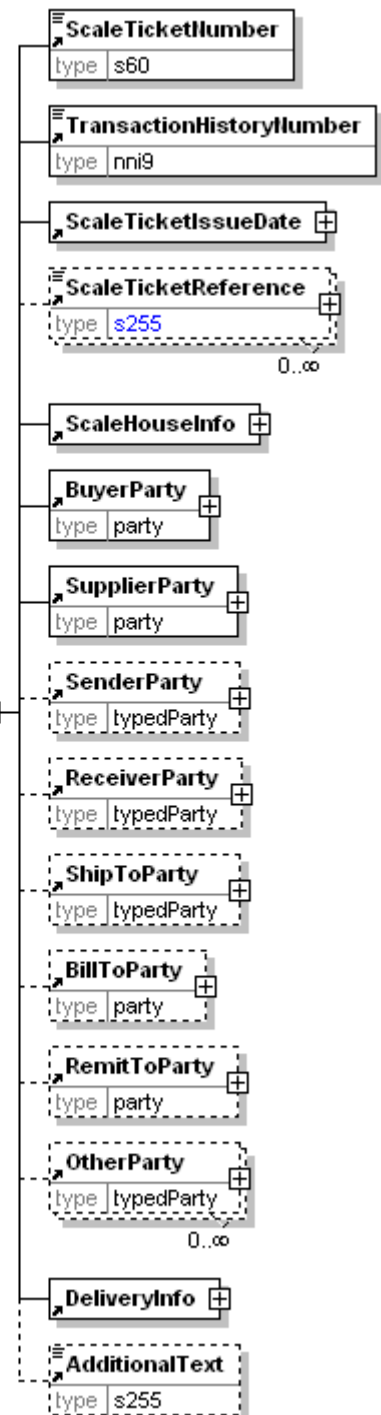

to party or customer. If no OtherParty is defined as the Payer, the Buyer is the Payer.

SupplierParty

SupplierParty is mandatory. A single instance is required.

The organisation or business entity responsible for providing the product. SupplierParty is also the seller of the product, if Seller is not specified as OtherParty = Seller.

SenderParty

SenderParty is optional. A single instance might exist.

The business entity issuing the e-Document, the source of the document.

The entity responsible for the content. If the sender party has out sourced the message service to a third party the SenderParty is the issuer of the e-Document and not the party performing the transmission service of the electronic message.

ReceiverParty

ReceiverParty is optional. A single instance might exist.

The business entity for whom the e-Document is intended, the destination of the document.

The entity interested in the content. If the receiver party has outsourced the message service to a third party the ReceiverParty is the intended party for the e-Document and not the party performing the receiving service of the electronic message.

ShipToParty

ShipToParty is optional. A single instance might exist.

The name and/or address to which the goods should be delivered with the party type indicated by the PartyType attribute.

BillToParty

BillToParty is optional. A single instance might exist.

The address where the invoice is to be sent.

RemitToParty

RemitToParty is optional. A single instance might exist.

A group item containing details of the party to whom payment will be made. The RemitToParty contains all information related to remittance.

OtherParty

OtherParty is optional. Multiple instances might exist.

An organisation or business entity other than those specifically detailed within a e-Document.

DeliveryInfo

DeliveryInfo is mandatory. A single instance is required.

Information about the delivery.

AdditionalText

AdditionalText is optional. A single instance might exist.

A text field that is used to communicate information not previously defined or for special instructions. To be used only for circumstances not covered by specific

elements.

ScaleTicketIssueDate

The date and time when the ScaleTicket was issued.

(sequence)

The sequence of items below is mandatory. A single instance is required.

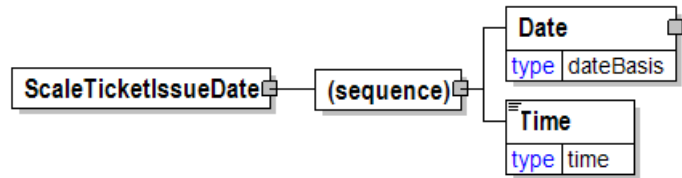

Date

Date is mandatory. A single instance is required.

A group element that contains the specification of Year, Month, and Day.

Time

Time is mandatory. A single instance is required.

Times are treated in a standard XML fashion with a special case used to indicate a generalized "local" time. The standard XML approach to time is hh:mm:ss, hh:mm:ssZ, or hh:mm:ss±hh:mm.

hh:mm:ss±hh:mm is used to represent a time with a time zone. The time zone is communicated as the number of hours offset from the Universal Time Coordinate (UTC), a.k.a. Greenwich Mean Time.

hh:mm:ssZ indicates the time at Zulu (another name for UTC). Based on the convention described in the next bullet it will be important for users within UTC to use "Z" when communicating a time in their time zone to other users.

hh:mm:ss or hh:mm indicates in the XML standard the time at UTC however, within papiNet it is used to represent the applicable local time. Caution should be used when processing times of this nature as the papiNet approach may be in discord with other users of XML.

ScaleTicketLineItem

The details for each item reported on a ScaleTicket e-Document.

ScaleTicketAcceptance [attribute]

ScaleTicketAcceptance is mandatory. A single instance is required.

Defines the state of the goods received as compared to the DeliveryMessage specifications. The enumeration list is the list of choices that apply to the GoodsReceipt header and line item.

Refer to ScaleTicketAcceptance definition for any enumerations.

ScaleTicketRejectedType [attribute]

ScaleTicketRejectedType is optional. A single instance might exist.

ScaleTicketRejectedType

Refer to ScaleTicketRejectedType definition for any enumerations.

(sequence)

The sequence of items below is mandatory. A single instance is required.

ScaleTicketLineNumber

ScaleTicketLineNumber is mandatory. A single instance is required.

ScaleTicket Line Number

Product

Product is mandatory. A single instance is required.

Product is a group item defining the article and its characteristics. Product is used to specify product characteristics organized by ProductIdentifier, ProductDescription, and Classification. Book Manufacturing, Label Stock, Paper, Pulp, Recovered Paper, Wood Products, and Virgin Fibre market segments have defined their product characteristics and conversion features for implementation in papiNet.

Quantity

Quantity is mandatory. A single instance is required.

The Quantity element contains attributes that provide information about the type of quantity that is being communicated, the context in which the particular quantity is to be viewed, and (if the quantity represents an adjustment) an adjustment type.

The Quantity element contains three child elements that enable you to communicate a range of values for the quantity and a target or actual value. It is at this level (Value, RangeMin, and RangeMax) that the unit of measure is specified. This permits the range to be specified in a different unit of measure than the target.

InformationalQuantity

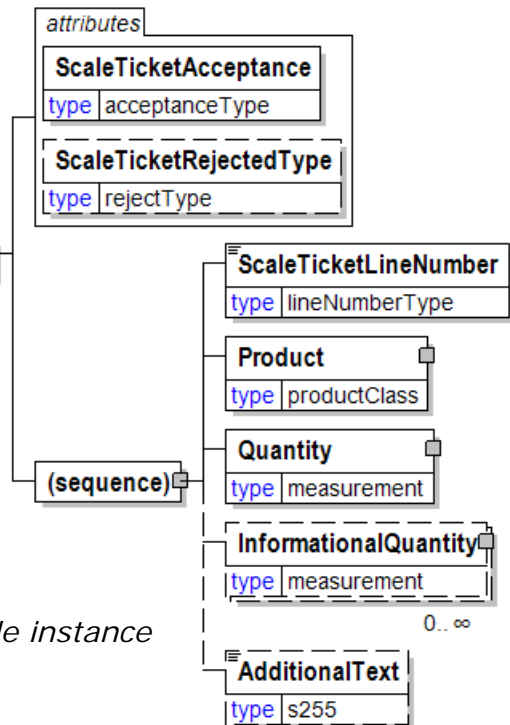

papiNet V2R31

InformationalQuantity is optional. Multiple instances might exist.

A quantity given in a valid UOM used for information purposes only (not for calculation). For example, an ordered quantity was 100 reels as opposed to the invoice quantity of 20,000 pounds.

AdditionalText

AdditionalText is optional. A single instance might exist.

A text field that is used to communicate information not previously defined or for special instructions. To be used only for circumstances not covered by specific elements.

ScaleTicketLineNumber

ScaleTicket Line Number

ScaleTicketLineNumber
type lineNumberType

ScaleTicketNumber

Unique identifier for the ScaleTicket e-Document.

ScaleTicketNumber
type s60

ScaleTicketReference

An element that details the relevant references pertaining to the ScaleTicket.

Identifies the previous unique document ID that this document replaces, if applicable.

ScaleTicketReference
type s255

attributes
ScaleTicketReferenceType
type referenceType
AssignedBy
type partyType

Mandatory if Purpose = Replace.

ScaleTicketReferenceType [attribute]

ScaleTicketReferenceType is mandatory. A single instance is required.

ScaleTicketReferenceType indicates what type of reference is being communicated.

ScaleTicketReferenceType indicates what type of reference is being communicated. Many items are currently prefixed by "Buyer", "Customer", "Seller", and/or "Supplier". Check for an existing non-prefixed version and use the non-prefixed version instead. In the (yet to be announced release date) version 3.0 the prefixed versions will be removed. Instead the attribute @AssignedBy will communicate the information previously communicated in the prefix.

Refer to ScaleTicketReferenceType definition for any enumerations.

AssignedBy [attribute]

AssignedBy is optional. A single instance might exist.

Identifies the type of party that has assigned the associated item, e.g. a reference of type OrderNumber.

Refer to AssignedBy definition for any enumerations.

ScaleTicketReferenceType [attribute]

ScaleTicketReferenceType indicates what type of reference is being communicated.

ScaleTicketReferenceType indicates what type of reference is being communicated. Many items are currently prefixed by "Buyer", "Customer", "Seller", and/or "Supplier". Check for an existing non-prefixed version and use the non-prefixed version instead. In the (yet to be announced release date) version 3.0 the prefixed versions will be removed. Instead the attribute @AssignedBy will communicate the information previously communicated in the prefix.

Refer to the [referenceType](#) entry for the list of enumerations and their definitions.

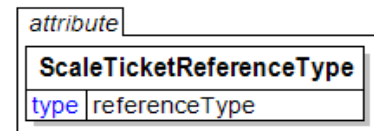

ScaleTicketRejectedType [attribute]

ScaleTicketRejectedType

This item is restricted to the following list.

ExcessiveTransitDamage

The item(s) is/are damaged beyond acceptable use during transit.

ProductQuality

The delivery did not match the quality of the product ordered or requested.

TooEarly

The delivery has occurred prior to the agreed delivery date/time. For example, there is insufficient storage at the delivered time.

TooLate

The delivery has occurred after the agreed delivery date/time. For example, delivered after press date.

UnableToUnload

The delivered items cannot be unloaded. For example, damaged vehicle doors, load has shifted during transportation, or ShipTo requires reels to be palletised but they are delivered on the vehicle floor.

WrongBarCode

The barcode used to identify the product is incorrect.

WrongBasisWeight

The basis weight of the product is not what was ordered.

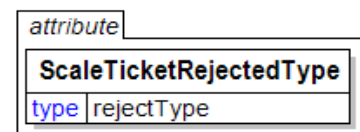

WrongDeliveryLocation

The product was delivered to the wrong location.

WrongDiameter

The diameter delivered is unusable. For example, a physical limitation on a reel stand is exceeded.

WrongLabel

The delivered item has incorrect or missing information, or incorrect label stock that would prevent its use. For example, insufficient peel-off barcode labels.

WrongProduct

The delivered item was not the product ordered or requested.

WrongReelWidth

The width of the reel is incorrect.

WrongVehicleType

The items have been delivered in a vehicle that cannot be unloaded at the ShipTo facility. For example, the ShipTo requires side unloading vehicles, but the delivery vehicle can only be unloaded from the rear.

WrongWrap

The delivered item is wrapped in material that will prevent its use. For example, a hole is not present in the end cap for vacuum lifting.

ScaleTicketStatusType [attribute]

ScaleTicket Status Type

This item is restricted to the following list.

Amended

The supplied information is changed.

Cancelled

The supplied information has been cancelled. Items that have been cancelled are not included in totals on the summary levels of the e-Document.

Original

The supplied information is the first version of that information.

Replaced

The supplied information is replacing earlier supplied information. The receiver should revalidate the information in their system based upon the entire information received.

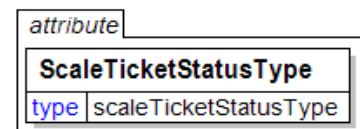

ScaleTicketSummary

Summary information for the ScaleTicket e-Document.

(sequence)

The sequence of items below is mandatory. A single instance is

required.

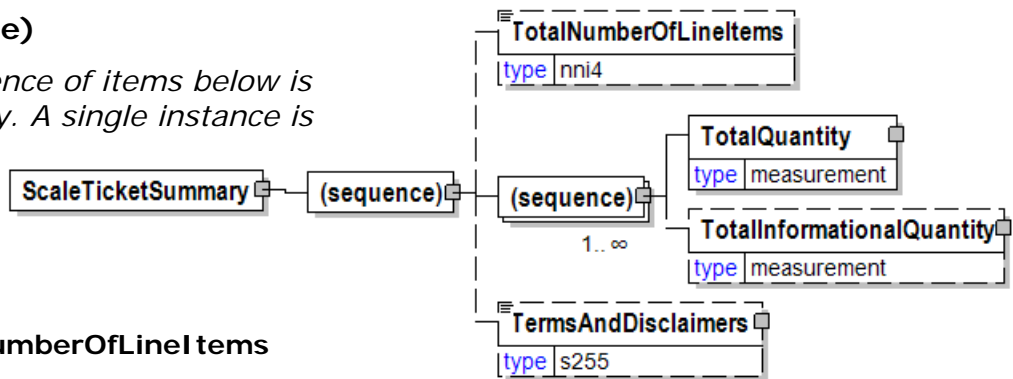

TotalNumberOfLineItems

TotalNumberOfLineItems is optional. A single instance might exist.

The total number of individual line items in the document, regardless of the status or type.

(sequence)

The sequence of items below is mandatory. One instance is required, multiple instances might exist.

TotalQuantity

TotalQuantity is mandatory. A single instance is required.

The total quantity of similar items in the e-Document. TotalQuantity is primarily used in the summary section of documents where it is repeatable to permit totaling for different units of measure.

TotalInformationalQuantity

TotalInformationalQuantity is optional. A single instance might exist.

A quantity that is used to communicate related information about the parent element. This element represents a total that is derived from individual line items.

TermsAndDisclaimers

TermsAndDisclaimers is optional. A single instance might exist.

An element that contains legal information with an indication of what the Language is.

Scored [attribute]

Is this item scored?

This item is restricted to the following list.

Yes

No

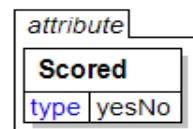

Screened [attribute]

Either "Yes" or "No".

This item is restricted to the following list.

Yes

No

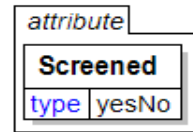

Seasoning

Describes drying/ moisture control method.

SeasoningType [attribute]

SeasoningType is optional. A single instance might exist.

Seasoning type, the classification and methodology of seasoning applied to the product.

Refer to SeasoningType definition for any enumerations.

(sequence)

The sequence of items below is mandatory. A single instance is required.

AdditionalText

AdditionalText is optional. A single instance might exist.

A text field that is used to communicate information not previously defined or for special instructions. To be used only for circumstances not covered by specific elements.

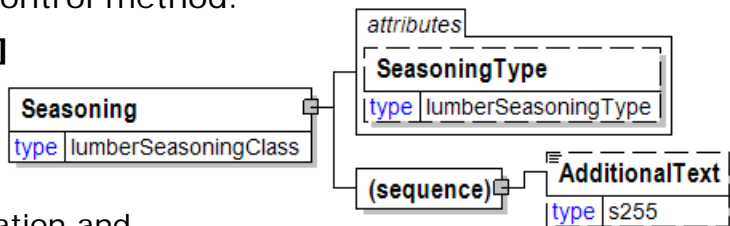

SeasoningType [attribute]

Seasoning type, the classification and methodology of seasoning applied to the product.

This item is restricted to the following list.

Dry

Air dried lumber that is not surfaced ... i.e. rough lumber.

Green

Not dried by any method.

KD

Kiln dried.

KDAT

Kiln dried after treatment... i.e. chemically treated, then redried.

PAD

Partially air dried. In practice, doesn't mean much, since you don't know how dry. Most commonly used on boards

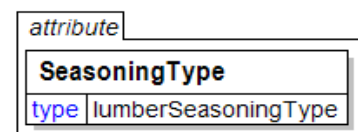

ShippingDry

Dried sufficiently to enable shipment without any deterioration in condition.

SurfacedDry

Surfaced-dry, meaning the product was dried (manner unspecified) and then surfaced (i.e. planed). Level of dryness is understood to be as required by the grading standard for the species in question. Generally it means the product was air dried to the standard, but it could have been kiln dried.

SurfacedGreen

Surfaced while still green.

Secure [attribute]

This attribute indicates that the product requires a secure manufacturing plant. For example when manufacturing ACT booklets and other testing products.

This item is restricted to the following list.

Yes

No

attribute	
Secure	
type	yesNo
default	No

SenderParty

The business entity issuing the e-Document, the source of the document.

The entity responsible for the content. If the sender party has out sourced the message service to a third party the SenderParty is the issuer of the e-Document and not the party performing the transmission service of the electronic message.

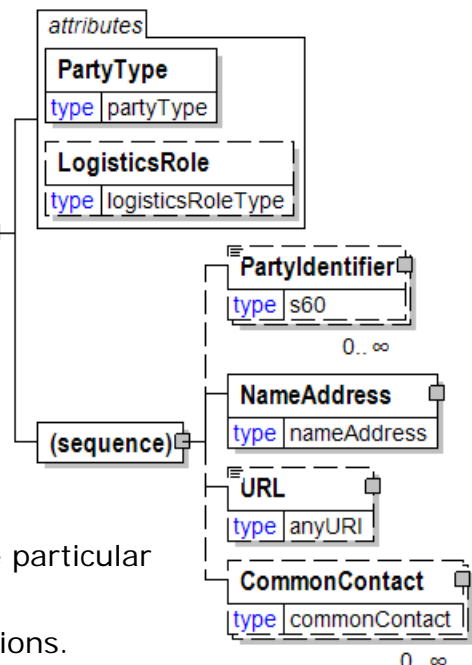
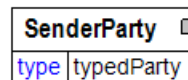

PartyType [attribute]

PartyType is mandatory. A single instance is required.

Identifies the business role associated with the particular party

Refer to PartyType definition for any enumerations.

LogisticsRole [attribute]

LogisticsRole is optional. A single instance might exist.

Communicates the nature of the logistics role, if any, the party plays in the transaction.

Refer to LogisticsRole definition for any enumerations.

(sequence)

The sequence of items below is mandatory. A single instance is required.

PartyIdentifier

PartyIdentifier is optional. Multiple instances might exist.

A unique identifier of a specific party. This element contains an attribute PartyIdentifierType that indicates the type of party.

NameAddress

NameAddress is mandatory. A single instance is required.

A group item containing name and address of an organisation or business entity.

URL

URL is optional. A single instance might exist.

Universal Resource Locator. While typically a web address you could use this field to hold an email address.

CommonContact

CommonContact is optional. Multiple instances might exist.

Identifies a specific individual associated with the party.

SenderProductAttributesDescription

An element containing free text used to describe the set of products sent in the ProductAttributes.

Language [attribute]

Language is optional. A single instance might exist.

SenderProductAttributesDescription	
type	s72

attributes	
Language	
type	languageType
default	eng

XML has embraced 2 and 3 digit language codes through the application of an addendum to the standard.

Refer to Language definition for any enumerations.

SenderProductAttributesIdentifier

A unique identifier assigned to the combination of products, properties, and ReceivingParty that makes this list of ProductAttributes unique from the SendingParty's point of view. Subsequent ProductAttributes with updates will use this same identifier.

SenderProductAttributesIdentifier	
type	s30

SenderProductAttributesName

The name given to the set of products sent in the ProductAttributes e-Document.

SenderProductAttributesName	
type	s45

SequenceNumber

SequenceNumber	
type	nni2

ServiceLevel

A grouping element containing information about a service level. The service level can be specified in a Service Level Agreement (SLA) detailing requirements such as delivery, performance, pricing, quality, etc.

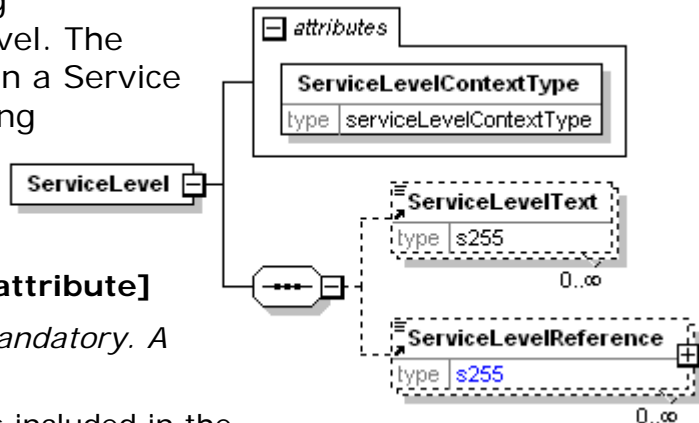

ServiceLevelContextType [attribute]

ServiceLevelContextType is mandatory. A single instance is required.

Indicates the nature of what is included in the service level.

Refer to ServiceLevelContextType definition for any enumerations.

(sequence)

The sequence of items below is mandatory. A single instance is required.

ServiceLevelText

ServiceLevelText is optional. Multiple instances might exist.

Text that is describing the service level.

ServiceLevelReference

ServiceLevelReference is optional. Multiple instances might exist.

An element detailing relevant references pertaining to the ServiceLevel. The type of reference is identified by the attributes ServiceLevelReferenceType and AssignedBy.

ServiceLevelContextType [attribute]

Indicates the nature of what is included in the service level.

This item is restricted to the following list.

Delivery

The service level is given for deliveries.

Production

The service level is given for production.



ServiceLevelReference

An element detailing relevant references pertaining to the ServiceLevel. The type of reference is identified by the attributes

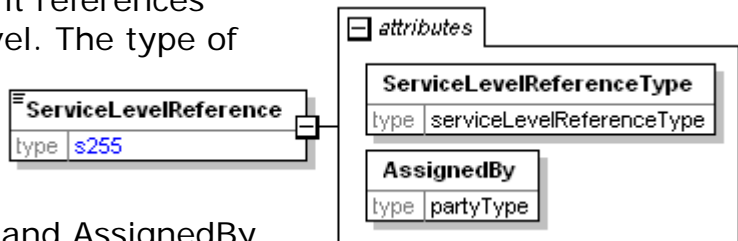

ServiceLevelReferenceType and AssignedBy.

ServiceLevelReferenceType [attribute]

ServiceLevelReferenceType is mandatory. A single instance is required.

Provides a contextual explanation of the specific reference identifier.

Refer to ServiceLevelReferenceType definition for any enumerations.

AssignedBy [attribute]

AssignedBy is mandatory. A single instance is required.

Identifies the type of party that has assigned the associated item, e.g. a reference of type OrderNumber.

Refer to AssignedBy for any enumerations.

ServiceLevelReferenceType [attribute]

Provides a contextual explanation of the specific reference identifier.

This item is restricted to the following list.

DeliveryChargeAccountNumber

Account Number to which the delivery charges are billed.

ServiceLevelAgreementNumber

The unique identifier given to a service level agreement.



ServiceLevelText

Text that is describing the service level.

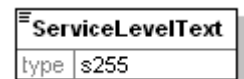

ShapeOfHole [attribute]

The shape of the hole

This item is restricted to the following list.

Elongated

The shape of the hole is elongated.

Oval

The shape of the hole is ovular.

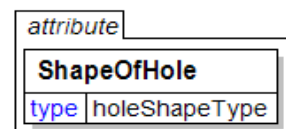

Round

The shape of the hole is round.

Square

The shape of the hole is square.

Other

The shape of the hole is other.

SetNumber

The part of the radius of the Tambour that constitutes the reel.

SetNumber	
type	nni2

SetPosition

The position of the reel in relation to the reels cut across the Tambour.

SetPosition	
type	nni2

ShapeOfHole [attribute]

The shape of the hole

This item is restricted to the following list.

Elongated

The shape of the hole is elongated.

Oval

The shape of the hole is ovular.

Round

The shape of the hole is round.

Square

The shape of the hole is square.

Other

The shape of the hole is other.

attribute	
ShapeOfHole	
type	holeShapeType

Sheet

A group item that contains the conversion and packaging characteristics for sheets.

(sequence)

The sequence of items below is mandatory. A single

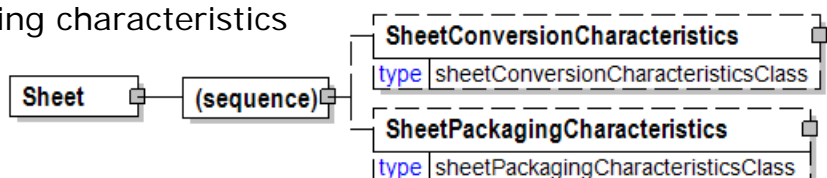

instance is required.

SheetConversionCharacteristics

SheetConversionCharacteristics is optional. A single instance might exist.

A group item that lists the conversion elements describing how a sheets are converted from a tambour.

SheetPackagingCharacteristics

SheetPackagingCharacteristics is optional. A single instance might exist.

A group item that contains elements relative to the sheet packaging.

SheetConcern

If the ConcernIndicatorType is "Y" then a defect cause must be given.

SheetConcernType [attribute]

SheetConcernType is optional. A single instance might exist.

Sheet Concern Type

Refer to SheetConcernType definition for any enumerations.

(sequence)

The sequence of items below is mandatory. A single instance is required.

SheetConcernCode

SheetConcernCode is optional. A single instance might exist.

Code used to identify problem with the sheet.

SheetConcernDescription

SheetConcernDescription is optional. A single instance might exist.

Description used to narrate the problem with the sheet.

AdditionalText

AdditionalText is optional. Multiple instances might exist.

A text field that is used to communicate information not previously defined or for special instructions. To be used only for circumstances not covered by specific elements.

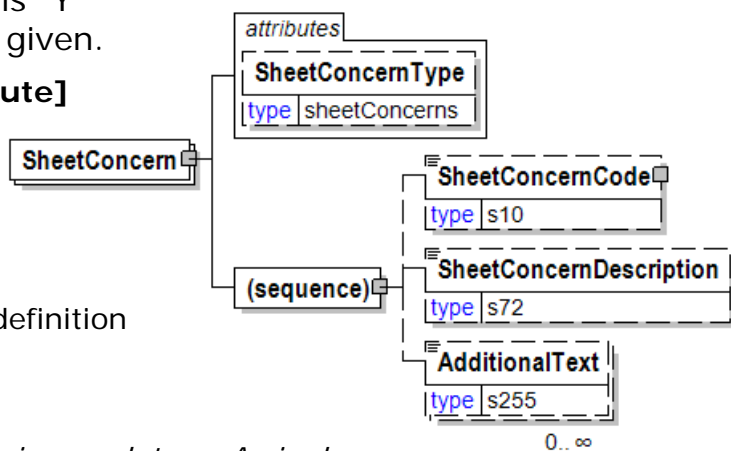

SheetConcernCode

Code used to identify problem with the sheet.

Agency [attribute]

Agency is mandatory. A single instance is required.

Describes the agency maintaining the list of codes. To be included in this list

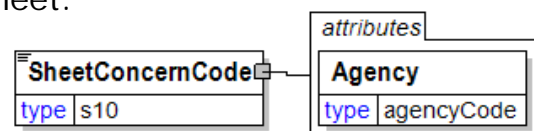

the agency must be a recognized standards body or industry organisation.

For the element that owns this attribute.

For another attribute in the list of attributes associated with the parent element.

Refer to Agency definition for any enumerations.

SheetConcernDescription

Description used to narrate the problem with the sheet.

SheetConcernDescription	
type	s72

SheetConcernType [attribute]

Sheet Concern Type

This item is restricted to the following list.

BladeOrApplicatorRollStreaks

BowedEdges

CaliperVariation

CoatedBladeScratch

CoatingStreaks

ColouredFibres

Curling

CutterWrinkles

Dirt

DyeStreaks

FeltMarks

Mottle

Other

OutOfSquareOrSize

ShadeVariation

SheetRelatedProblems

SlimeHole

SlimeSpot

StaticElectricity

Stretching

SurfaceDefectsOther

TightEdges

WavyEdges

attribute
SheetConcernType
type sheetConcerns

WireHole

WrinklesOther

SheetConversionCharacteristics

A group item that lists the conversion elements describing how a sheets are converted from a tambour.

(sequence)

The sequence of items below is mandatory. A single instance is required.

ConversionCode

ConversionCode is optional. A single instance might exist.

A code, as assigned by an Agency, used to identify a group of conversion characteristics.

GrainDirection

GrainDirection is optional. A single instance might exist.

Defines the primary orientation/alignment (Long or Short) of the cellulose fibres in a sheet or web of paper, which results from the flow of fibres in a water suspension during the papermaking process.

Refer to GrainDirection definition for any enumerations.

WindingDirection

WindingDirection is optional. A single instance might exist.

An element that indicates how the material is wound on the reel.

Refer to WindingDirection definition for any enumerations.

SheetSize

SheetSize is optional. Multiple instances might exist.

A group item that contains elements relative to the sheet size.

TargetProductWeight

TargetProductWeight is optional. A single instance might exist.

The desired weight of the finished product.

PunchedHoleDetails

PunchedHoleDetails is optional. Multiple instances might exist.

A grouping element that will contain the configuration information for punched holes.

CuttingDetails

CuttingDetails is optional. Multiple instances might exist.

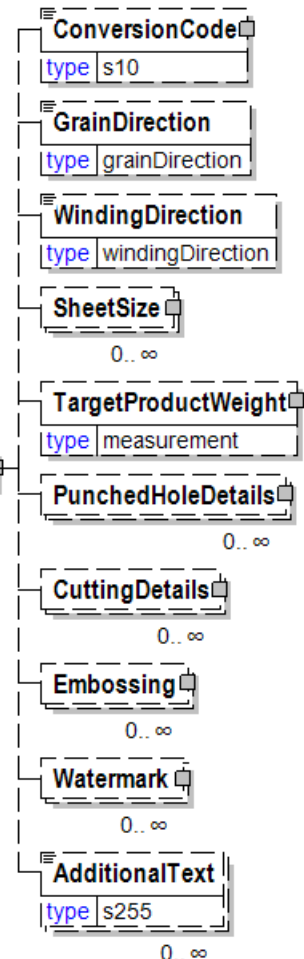

Cutting Details provides information on how to cut the sheet.

Embossing

Embossing is optional. Multiple instances might exist.

Embossing requirements for sheets and reels. Embossing involves a physical deformation of the paper surface as part of the conversion process. Embossing is applied either in-line (directly after the paper machine) or off-line. Refer to the attribute FinishType for additional information.

Watermark

Watermark is optional. Multiple instances might exist.

Watermark information

AdditionalText

AdditionalText is optional. Multiple instances might exist.

A text field that is used to communicate information not previously defined or for special instructions. To be used only for circumstances not covered by specific elements.

SheetCount

A group item that contains information relative to the number of sheets per packaging type.

SheetCountMethodType [attribute]

SheetCountMethodType is optional. A single instance might exist.

Defines the method used to count the sheets.

Refer to SheetCountMethodType definition for any enumerations.

(sequence)

The sequence of items below is mandatory. A single instance is required.

PerCarton

PerCarton is optional. A single instance might exist.

A field indicating the number of sheets per carton.

PerReam

PerReam is optional. A single instance might exist.

A field indicating the number of sheets per ream.

PerPallet

PerPallet is optional. A single instance might exist.

A field indicating the number of sheets on the pallet.

PerTab

PerTab is optional. A single instance might exist.

A field indicating the number of sheets per tab marking.

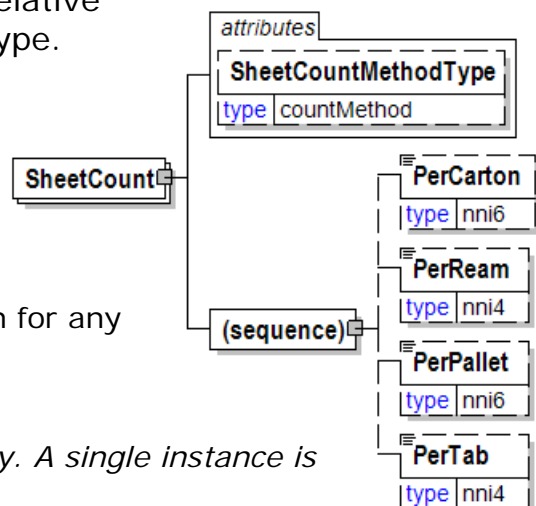

SheetCountMethodType [attribute]

Defines the method used to count the sheets.

This item is restricted to the following list.

Counter

Sheets will be counted using a counter at the cutter.

Laser

Sheets will be counted using a laser scanner.

NominalGrammage

The number of sheets will be calculated using the nominal grammage and the actual weight of the sheets.

attribute	
SheetCountMethodType	
type	countMethod

SheeterConcerns

SheeterConcerns is a group element that provides information about an event on a sheeter.

MachineStoppage [attribute]

MachineStoppage is optional. A single instance might exist.

An indicator on whether the production had to be periodically stopped.

Refer to MachineStoppage definition for any enumerations.

(sequence)

The sequence of items below is mandatory. A single instance is required.

SheetConcern

SheetConcern is mandatory. One instance is required, multiple instances might exist.

If the ConcernIndicatorType is "Y" then a defect cause must be given.

EventDate

EventDate is optional. A single instance might exist.

The date the incident or delay on press was recorded.

PositionInSheet

PositionInSheet is optional. A single instance might exist.

Location in the sheet where the defect was identified.

MachineLocation

MachineLocation is optional. A single instance might exist.

A unique and defined area in the operating machine. On a printing press it would

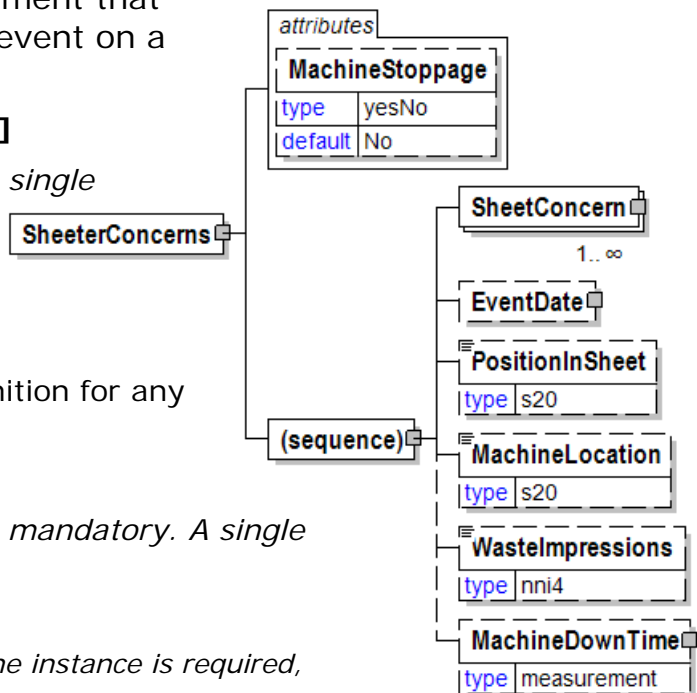

papiNet V2R31

include areas such as: "Splicer", "Infeed", "Print Unit", "folder", "Silcone coater". Also see PressBreakLocation.

WasteImpressions

WasteImpressions is optional. A single instance might exist.

The number of bad revolutions produced on a printing unit.

MachineDownTime

MachineDownTime is optional. A single instance might exist.

The length of loss production time that a machine experienced due to malfunction regardless of cause.

SheeterConditions

Identifies the environmental conditions when the sheet was printed on.

(sequence)

The sequence of items below is mandatory. A single instance is required.

Humidity

Humidity is optional. Multiple instances might exist.

Humidity

AmbientTemperature

AmbientTemperature is optional. Multiple instances might exist.

The temperature of the surrounding environment.

MachineSpeed

MachineSpeed is optional. Multiple instances might exist.

The rate at which the machine is, was, or should be running.

Tension

Tension is optional. Multiple instances might exist.

Tension of the web on the printing press.

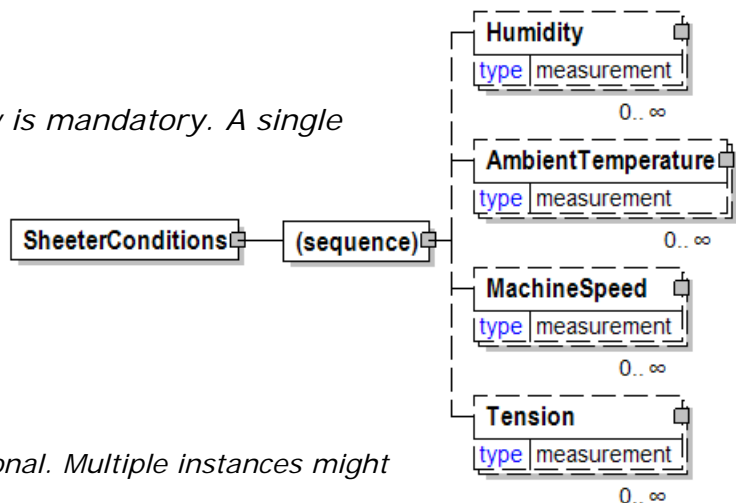

SheetItem

A group item consisting potentially of the date the sheets were converted into sheets and/or packaged or finished.

(sequence)

The sequence of items below is mandatory. A single instance is required.

DateSheeted

DateSheeted is optional. A single instance might exist.

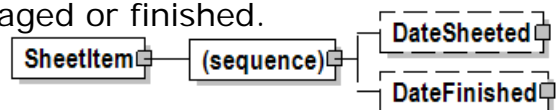

papiNet V2R31

The Date and optionally the Time that the paper was sheeted.

DateFinished

DateFinished is optional. A single instance might exist.

The Date and optionally the Time that an item was finished. For example, this could be the wrapping date for a reel or ream or the date the sheet(s) were packaged in preparation for shipment

SheetPackagingCharacteristics

A group item that contains elements relative to the sheet packaging.

ActionType [attribute]

ActionType is optional. A single instance might exist.

Used to trigger an action concerning the element to which it refers.

Refer to ActionType definition for any enumerations.

(sequence)

The sequence of items below is mandatory. A single instance is required.

PackagingCode

PackagingCode is optional. Multiple instances might exist.

PackagingCode is a code describing the packaging of the product.

PackagingDescription

PackagingDescription is optional. Multiple instances might exist.

A text field element describing the packaging of a product.

ReamType

ReamType is optional. Multiple instances might exist.

The textual description of the method used to make up the reams..

Refer to ReamType definition for any enumerations.

ReamWeight

ReamWeight is optional. Multiple instances might exist.

The target weight of a ream of paper.

MWeight

MWeight is optional. Multiple instances might exist.

The weight of 1000 sheets.

SheetCount

SheetCount is optional. Multiple instances might exist.

A group item that contains information relative to the number of sheets per packaging type.

UnitsPerCarton

UnitsPerCarton is optional. Multiple instances might exist.

The number of units per box.

Wrap

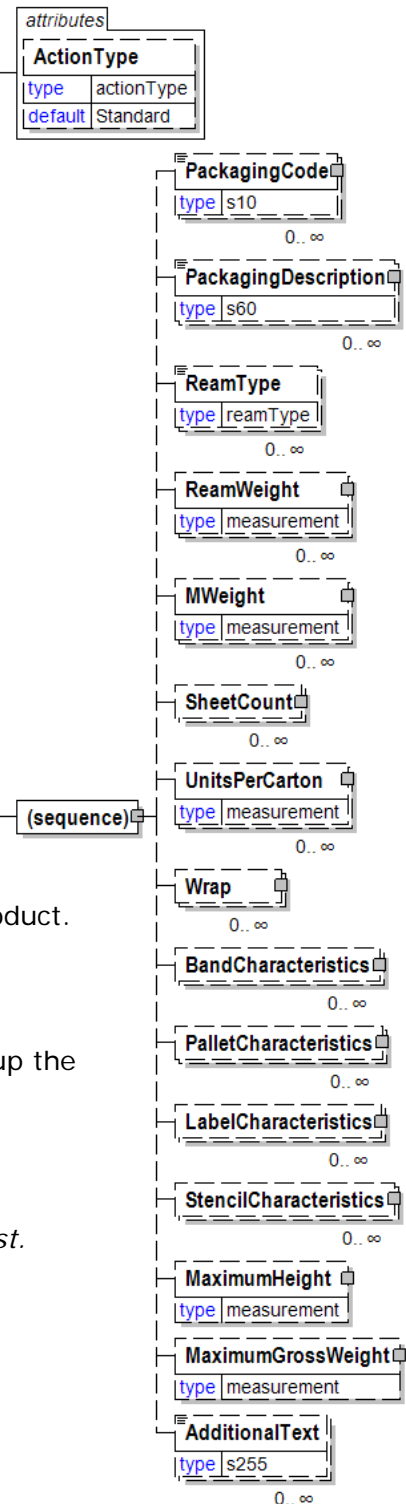
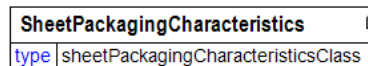

papiNet V2R31

Wrap is optional. Multiple instances might exist.

A group item that organises wrapping detail information.

BandCharacteristics

BandCharacteristics is optional. Multiple instances might exist.

A group item that organises the packaging band detail information.

PalletCharacteristics

PalletCharacteristics is optional. Multiple instances might exist.

A group item that provides pallet detail information.

LabelCharacteristics

LabelCharacteristics is optional. Multiple instances might exist.

A group item that organises the labeling information.

StencilCharacteristics

StencilCharacteristics is optional. Multiple instances might exist.

A group element specifying attributes of a stencil to be applied to an item, and optional text.

MaximumHeight

MaximumHeight is optional. A single instance might exist.

The maximum height allowed including the pallet.

MaximumGrossWeight

MaximumGrossWeight is optional. A single instance might exist.

The maximum weight allowed including the pallet.

AdditionalText

AdditionalText is optional. Multiple instances might exist.

A text field that is used to communicate information not previously defined or for special instructions. To be used only for circumstances not covered by specific elements.

SheetSize

A group item that contains elements relative to the sheet size.

(choice)

[choice] is optional because of choice construct.

(sequence)

The sequence of items below is mandatory. A single instance is required.

Length

Length is mandatory. A single instance is required.

The length of the object.

Width

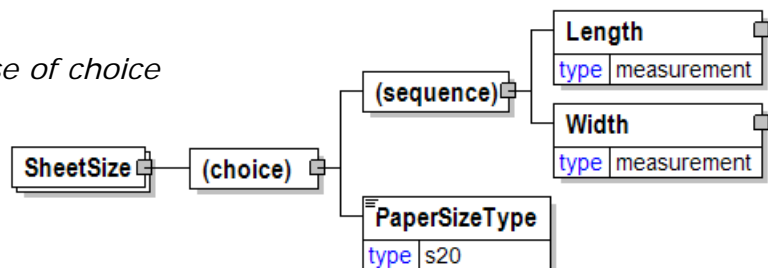

papiNet V2R31

Width is mandatory. A single instance is required.

The width of the object.

PaperSizeType

PaperSizeType is optional because of choice construct.

A field that defines the sheet size using the DIN standard (DINA4, DINA3, and so on).

ShellColour

Shell colour

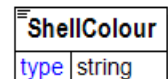

ShellType [attribute]

The type of shell

This item is restricted to the following list.

SonicWeld

FiveScrew

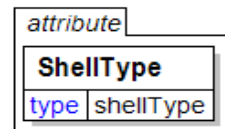

ShipFromCharacteristics

A group item that provides information pertaining to the Ship-From Party.

ShipFromCharacteristics may be referenced at both the header and line item level. The reference at the header, if it exists, acts as a default for the value at the line level, unless overridden at the line level.

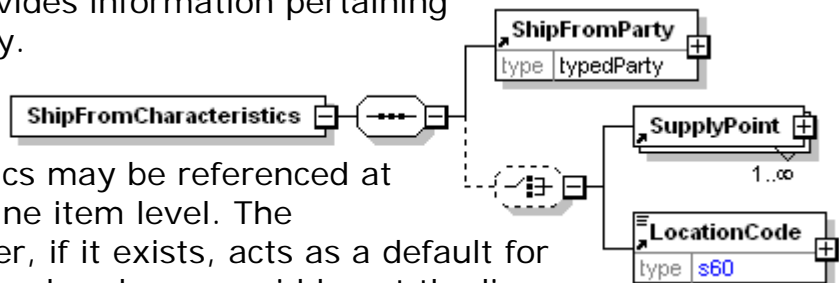

(sequence)

The sequence of items below is mandatory. A single instance is required.

ShipFromParty

ShipFromParty is mandatory. A single instance is required.

The name and/or address from which the goods will be delivered with the party type indicated by the PartyType attribute.

(choice)

[choice] is optional because of choice construct.

SupplyPoint

SupplyPoint is optional because of choice construct.

Grouping element that contains items describing a supply point. A SupplyPoint belongs to a LocationParty, e.g. in a DeliveryOrigin or DeliveryDestination, and

describes where goods are stored and can be loaded or unloaded. A SupplyPoint can for example be a loading or unloading gate at a warehouse or a road side landing at a logging area in the forest.

LocationCode

LocationCode is optional because of choice construct.

A code used to identify a specific physical location within a site identified by a party, e.g. a loading station in a warehouse or an unloading station at a printer site.

LocationCode will be deprecated in a future version. Use SupplyPoint instead of LocationCode.

ShipFromParty

The name and/or address from which the goods will be delivered with the party type indicated by the PartyType attribute.

PartyType [attribute]

PartyType is mandatory. A single instance is required.

Identifies the business role associated with the particular party

Refer to PartyType definition for any enumerations.

LogisticsRole [attribute]

LogisticsRole is optional. A single instance might exist.

Communicates the nature of the logistics role, if any, the party plays in the transaction.

Refer to LogisticsRole definition for any enumerations.

(sequence)

The sequence of items below is mandatory. A single instance is required.

PartyIdentifier

PartyIdentifier is optional. Multiple instances might exist.

A unique identifier of a specific party. This element contains an attribute PartyIdentifierType that indicates the type of party.

NameAddress

NameAddress is mandatory. A single instance is required.

A group item containing name and address of an organisation or business entity.

URL

URL is optional. A single instance might exist.

Universal Resource Locator. While typically a web address you could use this field to hold an email address.

CommonContact

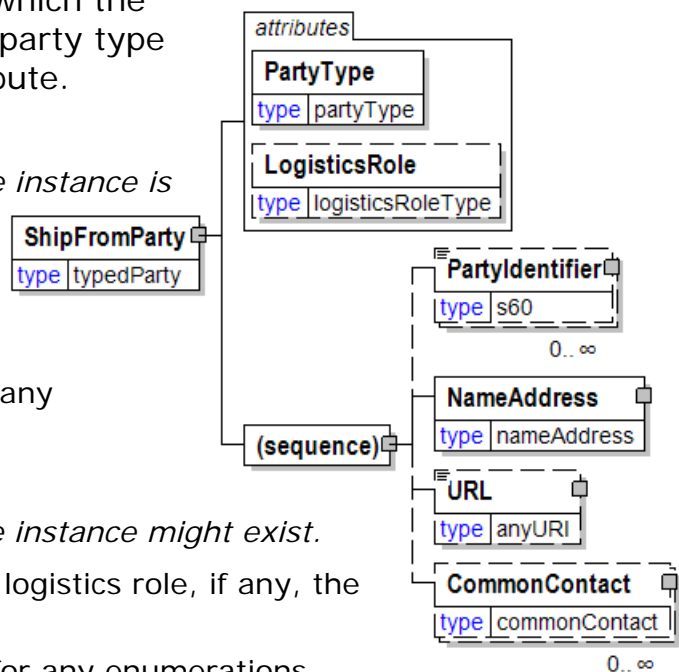

CommonContact is optional. Multiple instances might exist.

Identifies a specific individual associated with the party.

ShipmentComplete [attribute]

Either "Yes" or "No".

This item is restricted to the following list.

Yes

No

attribute	
ShipmentComplete	
type	yesNo
default	No

ShipmentDetails

A group element containing information that relates to the shipment details for the line item.

ShipmentDetailsType [attribute]

ShipmentDetailsType is mandatory. A single instance is required.

Provides information about the shipment's status

Refer to ShipmentDetailsType definition for any enumerations.

(sequence)

The sequence of items below is mandatory. A single instance is required.

ShipToParty

ShipToParty is mandatory. A single instance is required.

The name and/or address to which the goods should be delivered with the party type indicated by the PartyType attribute.

Quantity

Quantity is mandatory. A single instance is required.

The Quantity element contains attributes that provide information about the type of quantity that is being communicated, the context in which the particular quantity is to be viewed, and (if the quantity represents an adjustment) an adjustment type.

The Quantity element contains three child elements that enable you to communicate a range of values for the quantity and a target or actual value. It is at this level (Value, RangeMin, and RangeMax) that the unit of measure is specified. This permits the range to be specified in a different unit of measure than the target.

InformationalQuantity

InformationalQuantity is optional. Multiple instances might exist.

A quantity given in a valid UOM used for information purposes only (not for

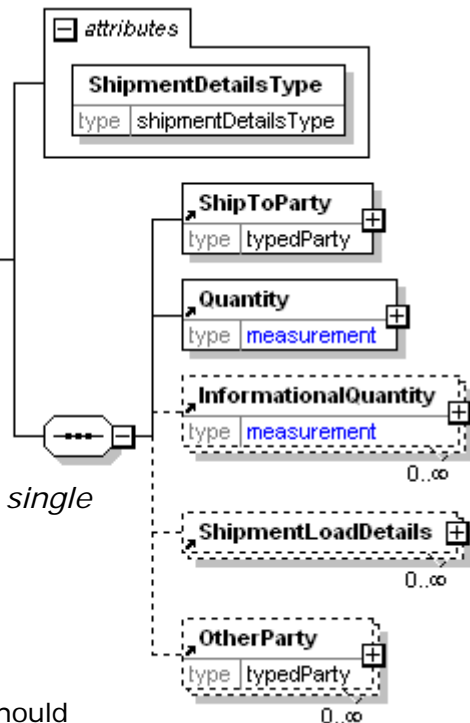
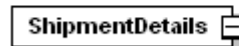

calculation). For example, an ordered quantity was 100 reels as opposed to the invoice quantity of 20,000 pounds.

ShipmentLoadDetails

ShipmentLoadDetails is optional. Multiple instances might exist.

A group element that containing information that relates to the shipment load details for the line item. Carrier and transport information may be detailed.

OtherParty

OtherParty is optional. Multiple instances might exist.

An organisation or business entity other than those specifically detailed within a e-Document.

ShipmentDetailsType [attribute]

Provides information about the shipment's status

This item is restricted to the following list.

Forecast

The shipment has not yet taken place

Shipment

The shipment has taken place.



ShipmentEventDate

Date of the event.

(sequence)

The sequence of items below is mandatory. A single instance is required.

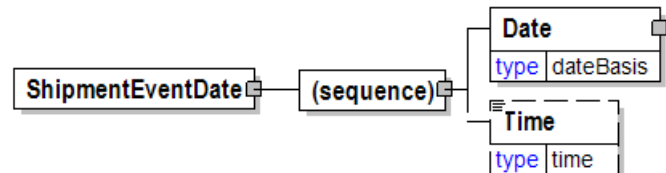

Date

Date is mandatory. A single instance is required.

A group element that contains the specification of Year, Month, and Day.

Time

Time is optional. A single instance might exist.

Times are treated in a standard XML fashion with a special case used to indicate a generalized "local" time. The standard XML approach to time is hh:mm:ss, hh:mm:ssZ, or hh:mm:ss±hh:mm.

hh:mm:ss±hh:mm is used to represent a time with a time zone. The time zone is communicated as the number of hours offset from the Universal Time Coordinate (UTC), a.k.a. Greenwich Mean Time.

hh:mm:ssZ indicates the time at Zulu (another name for UTC). Based on the convention described in the next bullet it will be important for users within UTC to use "Z" when communicating a time in their time zone to other users.

hh:mm:ss or hh:mm indicates in the XML standard the time at UTC however, within papiNet it is used to represent the applicable local time. Caution should be used when processing times of this nature as the papiNet approach may be

in discord with other users of XML.

ShipmentEventDuration

The length of time for the shipment event being described.

ShipmentEventDuration	
type	duration

The lexical representation for duration is the [ISO 8601] extended format PnYn MnDTnH nMnS, where nY represents the number of years, nM the number of months, nD the number of days, 'T' is the date/time separator, nH the number of hours, nM the number of minutes and nS the number of seconds. The number of seconds can include decimal digits to arbitrary precision. E.g. 25 hours = PT25H, 1 day and 34 minutes = P1DT23M.

ShipmentEventIdentifier

Text to identify the Shipment Event. The Carrier should report the latest status available to the requestor.

ShipmentEventType [attribute]

ShipmentEventType is mandatory. A single instance is required.

Indicates the type of event.

Refer to ShipmentEventType definition for any enumerations.

AssignedBy [attribute]

AssignedBy is mandatory. A single instance is required.

Identifies the type of party that has assigned the associated item, e.g. a reference of type OrderNumber.

Refer to AssignedBy definition for any enumerations.

ShipmentEventQualifierType [attribute]

ShipmentEventQualifierType is optional. A single instance might exist.

Provides additional details related to the general shipment event.

Refer to ShipmentEventQualifierType definition for any enumerations.

ShipmentEventIdentifier	
type	s30

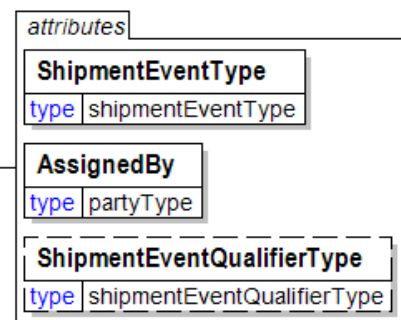

ShipmentEventInformation

A grouping element that contains the items that describe the shipment event and status situation

(sequence)

The sequence of items below is mandatory. A single instance is required.

ShipmentEventIdentifier

ShipmentEventIdentifier is mandatory. A single instance is required.

Text to identify the Shipment Event. The Carrier should report the latest status available to the requestor.

ShipmentEventDate

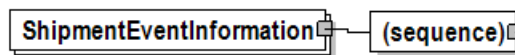

ShipmentEventDate is mandatory. A single instance is required.

Date of the event.

ShipmentStatusIdentifier

ShipmentStatusIdentifier is mandatory. A single instance is required.

Text to identify the status of the event.

ShipmentEventReference

ShipmentEventReference is optional. Multiple instances might exist.

An item detailing relevant references pertaining to the shipment event information. The type of reference is identified by the ShipmentEventReferenceType attribute.

ShipmentStatusDescription

ShipmentStatusDescription is optional. Multiple instances might exist.

Text field that may further describe the event's status in detail.

ShipmentStatusDate

ShipmentStatusDate is optional. A single instance might exist.

Date of the status of the event.

ShipmentEventDuration

ShipmentEventDuration is optional. A single instance might exist.

The length of time for the shipment event being described.

The lexical representation for duration is the [ISO 8601] extended format PnYn MnDTnH nMnS, where nY represents the number of years, nM the number of months, nD the number of days, 'T' is the date/time separator, nH the number of hours, nM the number of minutes and nS the number of seconds. The number of seconds can include decimal digits to arbitrary precision. E.g. 25 hours = PT25H, 1 day and 34 minutes = P1DT23M.

DeliveryDateWindow

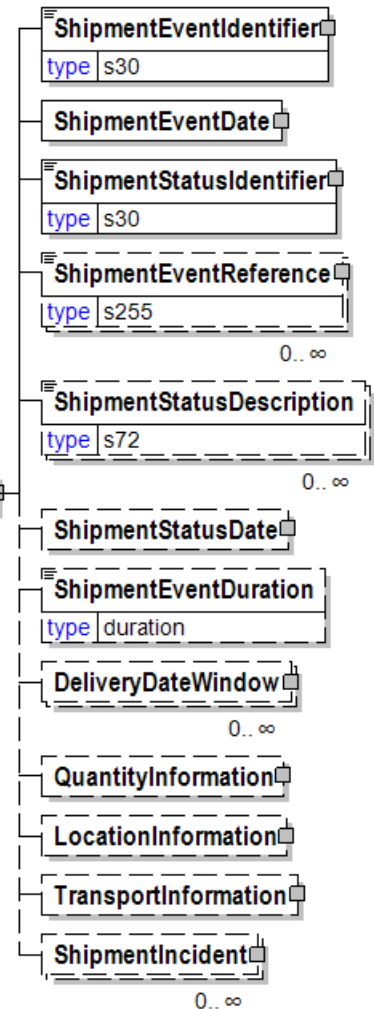

DeliveryDateWindow is optional. Multiple instances might exist.

A group item defining the date/time interval for delivery to take place. An element which may contain the estimated date for which delivery is expected. This date is not absolute.

QuantityInformation

QuantityInformation is optional. A single instance might exist.

A group item containing information about quantity and informational quantity of similar items.

LocationInformation

LocationInformation is optional. A single instance might exist.

A grouping element describing the location of the shipment.

TransportInformation

TransportInformation is optional. A single instance might exist.

A grouping element for transport information.

ShipmentIncident

ShipmentIncident is optional. Multiple instances might exist.

A grouping element that contains information about the shipment incident.

ShipmentEventQualifierType [attribute]

Provides additional details related to the general shipment event.

This item is restricted to the following list.

Scheduled

The event has been scheduled.

Arrived

The vehicle has arrived.

Started

The event has started.

Completed

The event has ended.

Departed

The vehicle has departed.

DocumentationCompleted

Documentation has been completed.



ShipmentEventReference

An item detailing relevant references pertaining to the shipment event information. The type of reference is identified by the

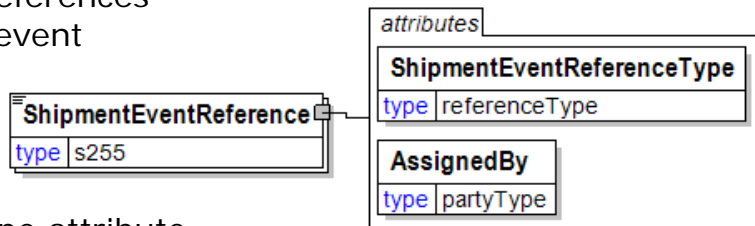

ShipmentEventReferenceType attribute.

ShipmentEventReferenceType [attribute]

ShipmentEventReferenceType is mandatory. A single instance is required.

ShipmentEventReferenceType provides a contextual explanation of the specific reference identifier. Many items are currently prefixed by "Buyer", "Customer", "Seller", and/or "Supplier". Check for an existing non-prefixed version and use the non-prefixed version instead. In the (yet to be announced release date) version 3.0 the prefixed versions will be removed. Instead the attribute @AssignedBy will communicate the information previously communicated in the prefix.

Refer to ShipmentEventReferenceType definition for any enumerations.

AssignedBy [attribute]

AssignedBy is optional. A single instance might exist.

Identifies the type of party that has assigned the associated item, e.g. a reference of type OrderNumber.

Refer to AssignedBy for any enumerations.

ShipmentEventReferenceType [attribute]

ShipmentEventReferenceType provides a contextual explanation of the specific reference identifier. Many items are currently prefixed by "Buyer", "Customer", "Seller", and/or "Supplier". Check for an existing non-prefixed version and use the non-prefixed version instead. In the (yet to be announced release date) version 3.0 the prefixed versions will be removed. Instead the attribute @AssignedBy will communicate the information previously communicated in the prefix.

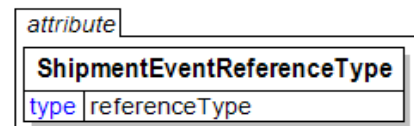

Refer to the [referenceType](#) entry for the list of enumerations and their definitions.

ShipmentEventType [attribute]

Indicates the type of event.

This item is restricted to the following list.

Loading



Unloading

ShipmentID

The ShipmentID may be a Bill of Lading Marking, which is customer's reference mark on each package used for logistic purposes. Should not be mixed up with Bill of Lading number. Another example of ShipmentID is grouping by a ContainerID.

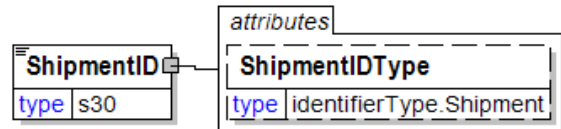

ShipmentIDType [attribute]

ShipmentIDType is optional. A single instance might exist.

Shipment ID Type

Refer to ShipmentIDType definition for any enumerations.

ShipmentIDType [attribute]

Shipment ID Type

This item is restricted to the following list.

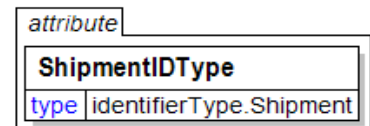

BillOfLadingMark

Assigning party's reference mark on each package used for logistic purposes (a mark which is painted to packages just to make handling easier). Not to be confused with Bill of Lading Number.

ContainerID

Container ID.

LotIdentifier

A unique code used to identify a grouping of product with one set of quality statistics common to all members of that group. Synonym: Lot Number

ShipmentIncident

A grouping element that contains information about the shipment incident.

(sequence)

The sequence of

items below is mandatory. A single instance is required.

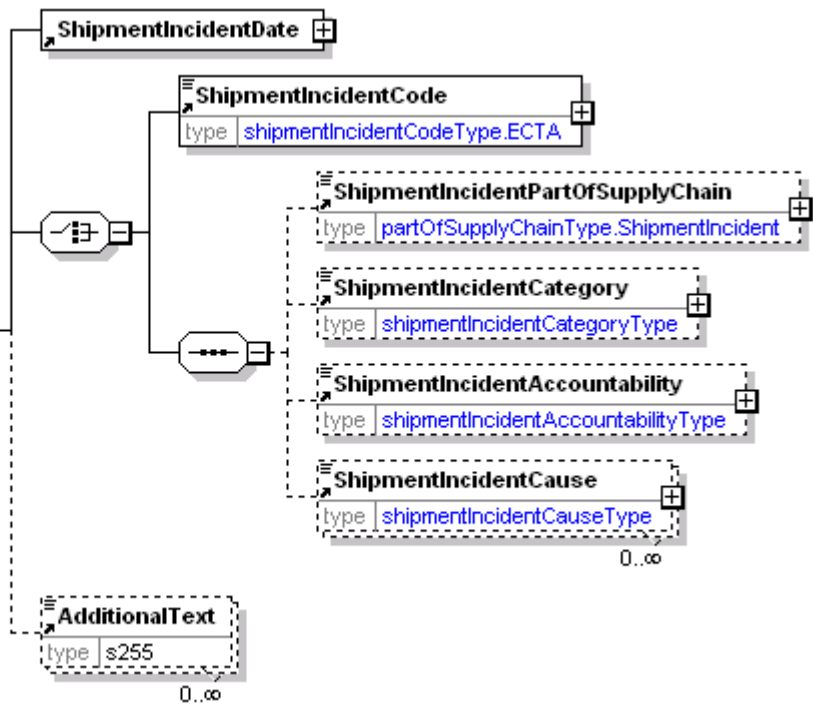

ShipmentIncidentDate

ShipmentIncidentDate is mandatory. A single instance is required.

The date of the shipment incident being reported.

(choice)

[choice] is optional because of choice construct.

ShipmentIncidentCode

ShipmentIncidentCode is optional because of choice construct.

The ECTA-EPCA-CEFIC codes for shipment incidents. This element is validated (via patterns) to ensure that only valid codes are entered. Refer to www.ecta.be for more information.

(sequence)

The sequence of items is optional because of choice construct.

ShipmentIncidentPartOfSupplyChain

ShipmentIncidentPartOfSupplyChain is optional. A single instance might exist.

The ECTA-EPCA-CEFIC codes for the part of the supply chain within which the shipment incident occurred. Refer to www.ecta.be for more information.

Refer to ShipmentIncidentPartOfSupplyChain definition for any enumerations.

ShipmentIncidentCategory

ShipmentIncidentCategory is optional. A single instance might exist.

The ECTA-EPCA-CEFIC codes for shipment incident categorization. Refer to www.ecta.be for more information.

Refer to ShipmentIncidentCategory definition for any enumerations.

ShipmentIncidentAccountability

ShipmentIncidentAccountability is optional. A single instance might exist.

The ECTA-EPCA-CEFIC codes for shipment incident accountability. Refer to

www.ecta.be for more information.

Refer to ShipmentIncidentAccountability definition for any enumerations.

ShipmentIncidentCause

ShipmentIncidentCause is optional. Multiple instances might exist.

The ECTA-EPCA-CEFIC codes for shipment incident cause. Refer to www.ecta.be for more information.

Refer to ShipmentIncidentCause definition for any enumerations.

AdditionalText

AdditionalText is optional. Multiple instances might exist.

A text field that is used to communicate information not previously defined or for special instructions. To be used only for circumstances not covered by specific elements.

ShipmentIncidentAccountability

The ECTA-EPCA-CEFIC codes for shipment incident accountability. Refer to www.ecta.be for more information.

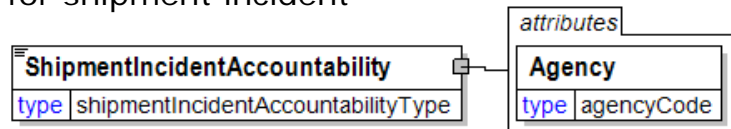

This item is restricted to the following list.

Haulier

Final Customer

(There is a space between these words.)

Supplier

Force Majeure

Events beyond the control of anyone. (There is a space between these words.)

Agency [attribute]

Agency is mandatory. A single instance is required.

Describes the agency maintaining the list of codes. To be included in this list the agency must be a recognized standards body or industry organisation.

For the element that owns this attribute.

For another attribute in the list of attributes associated with the parent element.

Refer to Agency definition for any enumerations.

ShipmentIncidentCategory

The ECTA-EPCA-CEFIC codes for shipment incident categorization. Refer to www.ecta.be for more information.

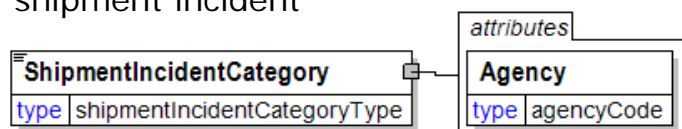

This item is restricted to the following list.

DateAndTime

Corresponds to the "Date & Time" ECTA-EPCA-CEFIC option.

Equipment

Product

Packaging

Documentation

Safety

Behaviour

Agency [attribute]

Agency is mandatory. A single instance is required.

Describes the agency maintaining the list of codes. To be included in this list the agency must be a recognized standards body or industry organisation.

For the element that owns this attribute.

For another attribute in the list of attributes associated with the parent element.

Refer to Agency definition for any enumerations.

ShipmentIncidentCause

The ECTA-EPCA-CEFIC codes for shipment incident cause. Refer to www.ecta.be for more information.

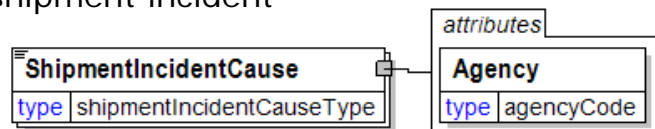

This item is restricted to the following list.

Human Error

(There is a space between words.)

Communication/Information/Instructions/Instructions/Failure

Documents Failure

(There is a space between words.)

Breakdown of equipment

(There is a space between words.)

Product or packaging damage

(There is a space between words.)

Wrong equipment

(There is a space between words.)

Non-availability

Rush order

(There is a space between words.)

Accident

Theft and Vandalism

(There is a space between words.)

Unsafe conditions

(There is a space between words.)

Upon request

(There is a space between words.)

Third party

(There is a space between words.)

Excessive customs clearance

(There is a space between words.)

Traffic

Strike

Weather

Agency [attribute]

Agency is mandatory. A single instance is required.

Describes the agency maintaining the list of codes. To be included in this list the agency must be a recognized standards body or industry organisation.

For the element that owns this attribute.

For another attribute in the list of attributes associated with the parent element.

Refer to Agency definition for any enumerations.

ShipmentIncidentCode

The ECTA-EPCA-CEFIC codes for shipment incidents.

This element is validated (via patterns) to ensure that only valid codes are entered. Refer to www.ecta.be for more information.

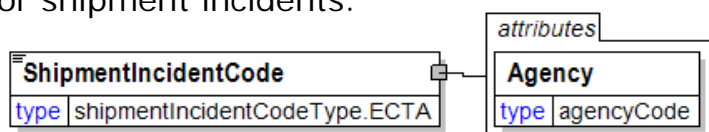

Agency [attribute]

Agency is mandatory. A single instance is required.

Describes the agency maintaining the list of codes. To be included in this list the agency must be a recognized standards body or industry organisation.

For the element that owns this attribute.

For another attribute in the list of attributes associated with the parent element.

Refer to Agency definition for any enumerations.

ShipmentIncidentDate

The date of the shipment incident being reported.

(sequence)

The sequence of items below is mandatory. A single instance is required.

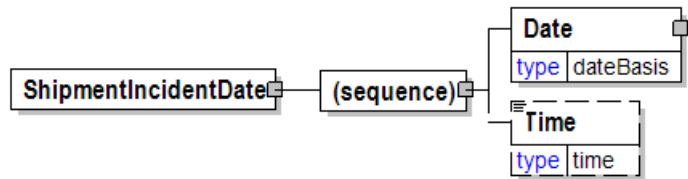

Date

Date is mandatory. A single instance is required.

A group element that contains the specification of Year, Month, and Day.

Time

Time is optional. A single instance might exist.

Times are treated in a standard XML fashion with a special case used to indicate a generalized "local" time. The standard XML approach to time is hh:mm:ss, hh:mm:ssZ, or hh:mm:ss±hh:mm.

hh:mm:ss±hh:mm is used to represent a time with a time zone. The time zone is communicated as the number of hours offset from the Universal Time Coordinate (UTC), a.k.a. Greenwich Mean Time.

hh:mm:ssZ indicates the time at Zulu (another name for UTC). Based on the convention described in the next bullet it will be important for users within UTC to use "Z" when communicating a time in their time zone to other users.

hh:mm:ss or hh:mm indicates in the XML standard the time at UTC however, within papiNet it is used to represent the applicable local time. Caution should be used when processing times of this nature as the papiNet approach may be in discord with other users of XML.

ShipmentIncidentPartOfSupplyChain

The ECTA-EPCA-CEFIC codes for the part of the supply chain within which the shipment incident occurred. Refer to www.ecta.be for more information.



This item is restricted to the following list.

Delivery

Loading

Agency [attribute]

Agency is mandatory. A single instance is required.

Describes the agency maintaining the list of codes. To be included in this list the agency must be a recognized standards body or industry organisation.

For the element that owns this attribute.

For another attribute in the list of attributes associated with the parent element.

Refer to Agency definition for any enumerations.

ShipmentLoadDetails

A group element that containing information that relates to the shipment load details for the line item. Carrier and transport information may be detailed.

(sequence)

The sequence of items below is mandatory. A single instance is required.

DeliveryMessageNumber

DeliveryMessageNumber is optional. A single instance might exist.

A unique delivery identifier assigned to each DeliveryMessage as agreed between the trading partners.

DeliveryMessageReference

DeliveryMessageReference is optional. Multiple

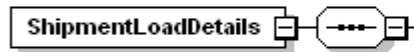

instances might exist.

An element that identifies the relevant references pertaining to the DeliveryMessage, identified by DeliveryMessageReferenceType.

CarrierParty

CarrierParty is optional. A single instance might exist.

The party performing the transport of the product from the pickup location to the ship-to location; could be a hauler.

(sequence)

The sequence of items below is optional. A single instance might exist.

SupplierOrderNumber

SupplierOrderNumber is mandatory. A single instance is required.

The number of the supplier order.

SupplierOrderLineItemNumber

SupplierOrderLineItemNumber is optional. A single instance might exist.

The number of the line item on the supplier order.

LocationParty

LocationParty is optional. Two instances might exist.

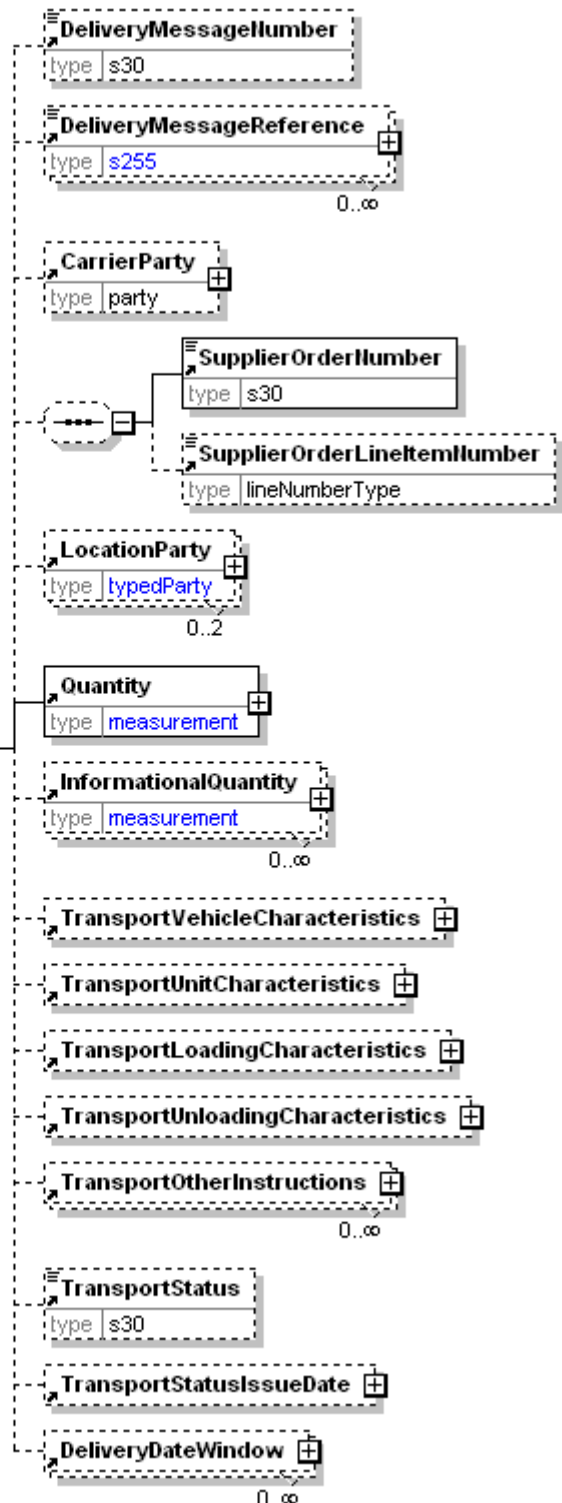

The organization or business entity where the business event took place or will take place.

Quantity

Quantity is mandatory. A single instance is required.

The Quantity element contains attributes that provide information about the type of quantity that is being communicated, the context in which the particular quantity is to be viewed, and (if the quantity represents an adjustment) an adjustment type.

The Quantity element contains three child elements that enable you to communicate a range of values for the quantity and a target or actual value. It is at this level (Value, RangeMin, and RangeMax) that the unit of measure is specified. This permits the range to be specified in a different unit of measure than the target.

InformationalQuantity

InformationalQuantity is optional. Multiple instances might exist.

A quantity given in a valid UOM used for information purposes only (not for calculation). For example, an ordered quantity was 100 reels as opposed to the invoice quantity of 20,000 pounds.

TransportVehicleCharacteristics

TransportVehicleCharacteristics is optional. A single instance might exist.

A group item defining the primary means of transporting the goods, such as a side port vessel. In some instances, the transport unit and vehicle are the same.

TransportUnitCharacteristics

TransportUnitCharacteristics is optional. A single instance might exist.

A group item defining and identifying the primary means of containing the goods. In some instances, the transport unit and vehicle are the same.

TransportLoadingCharacteristics

TransportLoadingCharacteristics is optional. A single instance might exist.

A group item defining how the transported items are to be loaded.

TransportUnloadingCharacteristics

TransportUnloadingCharacteristics is optional. A single instance might exist.

A group item defining how the transported items are to be unloaded.

TransportOtherInstructions

TransportOtherInstructions is optional. Multiple instances might exist.

A group item defining any other instructions for the transport not covered in the description of transport mode, vehicle, unit, and loading characteristics or defining an alternative description for the categories mentioned above.

TransportStatus

TransportStatus is optional. A single instance might exist.

Text element used to communicate the current status of the shipment actually being transported to the recipient. This element could indicate the tracking status that the transport company issues. Alternatively, it could be the vendor's internal tracking status of the shipment.

TransportStatusIssueDate

TransportStatusIssueDate is optional. A single instance might exist.

The Date and Time the transport status is issued.

DeliveryDateWindow

DeliveryDateWindow is optional. Multiple instances might exist.

A group item defining the date/time interval for delivery to take place. An element which may contain the estimated date for which delivery is expected. This date is not absolute.

ShipmentMethodOfPayment

An element communicating responsibility of freight payment and when transfer of ownership will occur.

LocationQualifier [attribute]

*LocationQualifier is optional.
A single instance might exist.*

An attribute of the shipment method of payment describing the location to which the delivery terms refer. This location determines where and when the goods ownership is transferred from the seller to the buyer.

Refer to LocationQualifier definition for any enumerations.

Method [attribute]

Method is optional. A single instance might exist.

An attribute of the shipment method of payment, which defines the responsibilities of buyers and sellers for delivery under a sales contract.

It especially determines the obligations of the seller and the buyer regarding the payment of the freight costs.

Refer to Method definition for any enumerations.

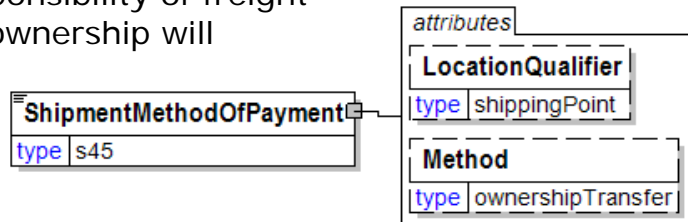

ShipmentStatus

The ShipmentStatus element is the root element for the ShipmentStatus e-Document.

The ShipmentStatus e-Document is sent to communicate the status of a shipment or consignment with references to other documents. Typically, a ShipmentStatus e-Document is sent from the forwarder or carrier to the consignor / forwarder.

Language [attribute]

Language is optional. A single instance might exist.

XML has embraced 2 and 3 digit language codes through the application of an addendum to the standard.

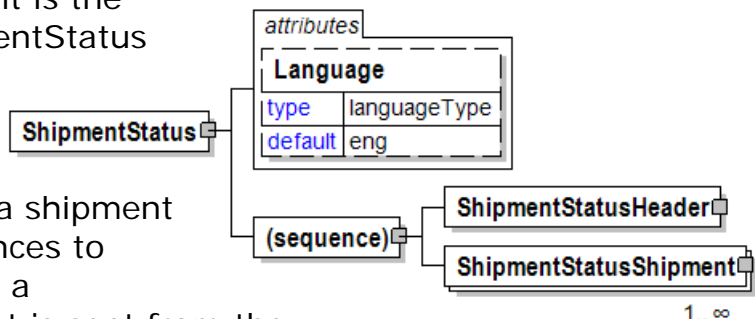

papiNet V2R31

Refer to Language definition for any enumerations.

(sequence)

The sequence of items below is mandatory. A single instance is required.

ShipmentStatusHeader

ShipmentStatusHeader is mandatory. A single instance is required.

The ShipmentStatusHeader contains information common to the entire ShipmentStatus e-Document.

ShipmentStatusShipment

ShipmentStatusShipment is mandatory. One instance is required, multiple instances might exist.

The shipment or consignment details that are being communicated.

ShipmentStatusDate

Date of the status of the event.

(sequence)

The sequence of items below is mandatory. A single instance is required.

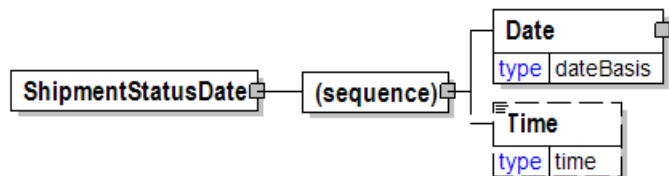

Date

Date is mandatory. A single instance is required.

A group element that contains the specification of Year, Month, and Day.

Time

Time is optional. A single instance might exist.

Times are treated in a standard XML fashion with a special case used to indicate a generalized "local" time. The standard XML approach to time is hh:mm:ss, hh:mm:ssZ, or hh:mm:ss±hh:mm.

hh:mm:ss±hh:mm is used to represent a time with a time zone. The time zone is communicated as the number of hours offset from the Universal Time Coordinate (UTC), a.k.a. Greenwich Mean Time.

hh:mm:ssZ indicates the time at Zulu (another name for UTC). Based on the convention described in the next bullet it will be important for users within UTC to use "Z" when communicating a time in their time zone to other users.

hh:mm:ss or hh:mm indicates in the XML standard the time at UTC however, within papiNet it is used to represent the applicable local time. Caution should be used when processing times of this nature as the papiNet approach may be in discord with other users of XML.

ShipmentStatusDescription

Text field that may further describe the event's status in detail.

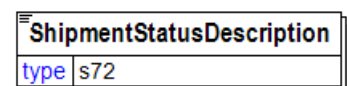

ShipmentStatusHeader

The ShipmentStatusHeader contains information common to the entire ShipmentStatus e-Document.

(sequence)

The sequence of items below is mandatory. A single instance is required.

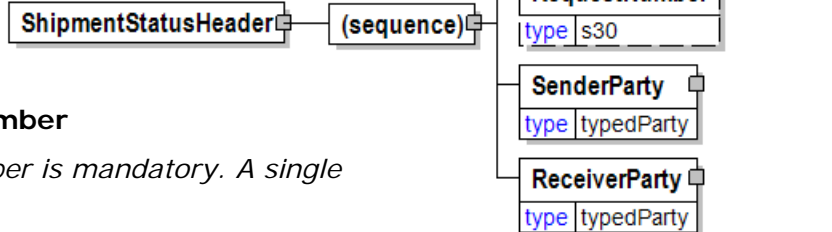

ShipmentStatusNumber

ShipmentStatusNumber is mandatory. A single instance is required.

Reference number assigned to the e-Document by the issuer.

ShipmentStatusIssueDate

ShipmentStatusIssueDate is mandatory. A single instance is required.

The date and optional time when the ShipmentStatus e-Document was issued.

RequestNumber

RequestNumber is optional. A single instance might exist.

A unique tracking number specifically identifying the InfoRequest e-Document to the originator. The tracking number is returned with the "information", the answer, to help match the answer to the request.

SenderParty

SenderParty is mandatory. A single instance is required.

The business entity issuing the e-Document, the source of the document.

The entity responsible for the content. If the sender party has out sourced the message service to a third party the SenderParty is the issuer of the e-Document and not the party performing the transmission service of the electronic message.

ReceiverParty

ReceiverParty is mandatory. A single instance is required.

The business entity for whom the e-Document is intended, the destination of the document.

The entity interested in the content. If the receiver party has outsourced the message service to a third party the ReceiverParty is the intended party for the e-Document and not the party performing the receiving service of the electronic message.

ShipmentStatusIdentifier

Text to identify the status of the event.

ShipmentStatusType [attribute]

ShipmentStatusType is mandatory. A single instance is required.

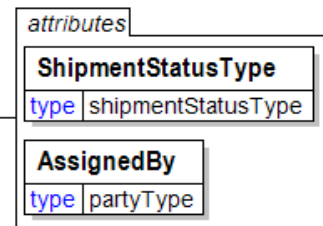
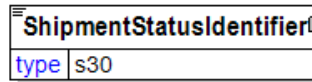

Identifies the status of the shipment being reported.

Refer to ShipmentStatusType definition for any enumerations.

AssignedBy [attribute]

AssignedBy is mandatory. A single instance is required.

Identifies the type of party that has assigned the associated item, e.g. a reference of type OrderNumber.

Refer to AssignedBy definition for any enumerations.

ShipmentStatusIssueDate

The date and optional time when the ShipmentStatus e-Document was issued.

(sequence)

The sequence of items below is mandatory. A single instance is required.

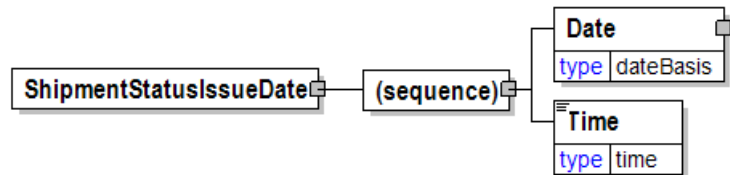

Date

Date is mandatory. A single instance is required.

A group element that contains the specification of Year, Month, and Day.

Time

Time is mandatory. A single instance is required.

Times are treated in a standard XML fashion with a special case used to indicate a generalized "local" time. The standard XML approach to time is hh:mm:ss, hh:mm:ssZ, or hh:mm:ss±hh:mm.

hh:mm:ss±hh:mm is used to represent a time with a time zone. The time zone is communicated as the number of hours offset from the Universal Time Coordinate (UTC), a.k.a. Greenwich Mean Time.

hh:mm:ssZ indicates the time at Zulu (another name for UTC). Based on the convention described in the next bullet it will be important for users within UTC to use "Z" when communicating a time in their time zone to other users.

hh:mm:ss or hh:mm indicates in the XML standard the time at UTC however, within papiNet it is used to represent the applicable local time. Caution should be used when processing times of this nature as the papiNet approach may be in discord with other users of XML.

ShipmentStatusNumber

The unique identifier for the ShipmentStatus e-Document.

ShipmentStatusNumber	
type	s30

ShipmentStatusReference

An item detailing relevant references pertaining to the ShipmentStatus information. The type of reference is identified by the

ShipmentStatusReference	
type	s255

attributes	
ShipmentStatusReferenceType	
type	referenceType
AssignedBy	
type	partyType

ShipmentStatusReferenceType attribute.

ShipmentStatusReferenceType [attribute]

ShipmentStatusReferenceType is mandatory. A single instance is required.

Provides a contextual explanation of the specific reference identifier. Many items are currently prefixed by "Buyer", "Forwarder", "Manufacturer", "Mill", "Seller", "Supplier", "Warehouse", or "Vendor". Check for an existing non-prefixed version and use the non-prefixed version instead. In the (yet to be announced release date) version 3.0 the prefixed versions will be removed. Instead the attribute @AssignedBy will communicate the information previously communicated in the prefix.

Refer to ShipmentStatusReferenceType definition for any enumerations.

AssignedBy [attribute]

AssignedBy is optional. A single instance might exist.

Identifies the type of party that has assigned the associated item, e.g. a reference of type OrderNumber.

Refer to AssignedBy for any enumerations.

ShipmentStatusReferenceType [attribute]

Provides a contextual explanation of the specific reference identifier. Many items are currently prefixed by "Buyer", "Forwarder", "Manufacturer", "Mill", "Seller", "Supplier", "Warehouse", or "Vendor". Check for an existing non-prefixed version and use the non-prefixed version instead. In the (yet to be announced release date) version 3.0 the prefixed versions will be removed. Instead the attribute @AssignedBy will communicate the information previously communicated in the prefix.

attribute	
ShipmentStatusReferenceType	
type	referenceType

Refer to the [referenceType](#) entry for the list of enumerations and their definitions.

ShipmentStatusRequestDetail

A grouping element that provides the parameters to be used when responding with a ShipmentStatus e-Document.

(sequence)

The sequence of items below is mandatory. A single instance is required.

SupplierParty

SupplierParty is optional. Multiple instances might exist.

The organisation or business entity responsible for providing the product. SupplierParty is also the seller of the

product, if Seller is not specified as OtherParty = Seller.

BuyerParty

BuyerParty is optional. Multiple instances might exist.

The legal entity to which the product is sold. Also commonly referred to as the sold-to party or customer. If no OtherParty is defined as the Payer, the Buyer is the Payer.

ShipToParty

ShipToParty is optional. Multiple instances might exist.

The name and/or address to which the goods should be delivered with the party type indicated by the PartyType attribute.

ForwarderParty

ForwarderParty is optional. Multiple instances might exist.

The trading partner involved in the forwarding of the shipment.

CarrierParty

CarrierParty is optional. Multiple instances might exist.

The party performing the transport of the product from the pickup location to the ship-to location; could be a hauler.

OtherParty

OtherParty is optional. Multiple instances might exist.

An organisation or business entity other than those specifically detailed within a e-Document.

ShipmentStatusSearchReference

ShipmentStatusSearchReference is mandatory. One instance is required, multiple instances might exist.

Used to specify a transport-related item that is used, as a parameter, when providing shipment status information.

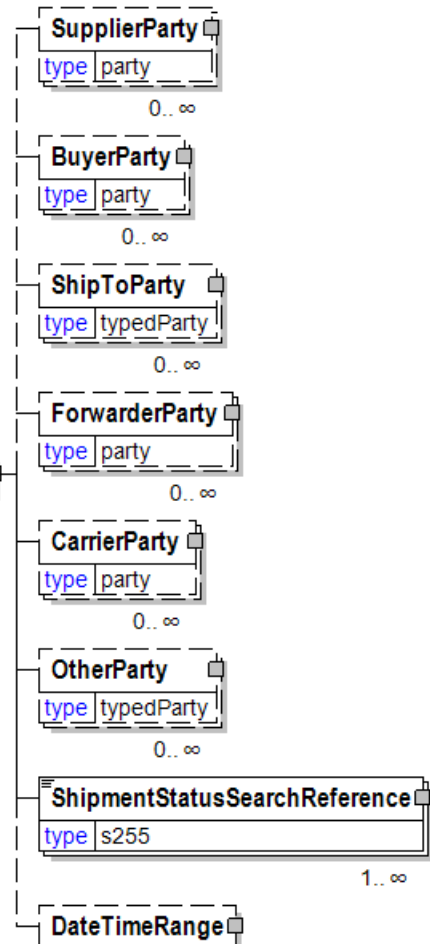

DateTimeRange

DateTimeRange is optional. A single instance might exist.

Specifies a date and/or time range.

ShipmentStatusSearchReference

Used to specify a transport-related item that is used, as a parameter, when providing shipment status information.

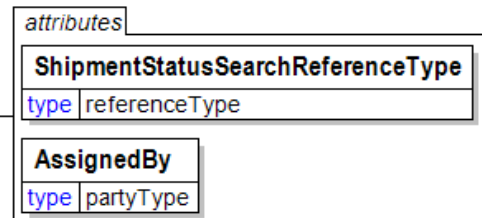
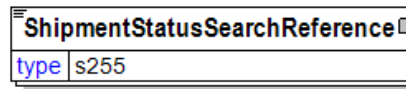

ShipmentStatusSearchReferenceType [attribute]

ShipmentStatusSearchReferenceType is mandatory. A single instance is required.

Provides a contextual explanation of the specific reference identifier. Many items are currently prefixed by "Buyer", "Forwarder", "Manufacturer", "Mill", "Seller", "Supplier", "Warehouse", or "Vendor". Check for an existing non-prefixed version and use the non-prefixed version instead. In the (yet to be announced release date) version 3.0 the prefixed versions will be removed. Instead the attribute @AssignedBy will communicate the information previously communicated in the prefix.

Refer to ShipmentStatusSearchReferenceType definition for any enumerations.

AssignedBy [attribute]

AssignedBy is optional. A single instance might exist.

Identifies the type of party that has assigned the associated item, e.g. a reference of type OrderNumber.

Refer to AssignedBy for any enumerations.

ShipmentStatusSearchReferenceType [attribute]

Provides a contextual explanation of the specific reference identifier. Many items are currently prefixed by "Buyer", "Forwarder", "Manufacturer", "Mill", "Seller", "Supplier", "Warehouse", or "Vendor". Check for an existing non-prefixed version and use the non-prefixed version instead. In the (yet to be announced release date) version 3.0 the prefixed versions will be removed. Instead the attribute

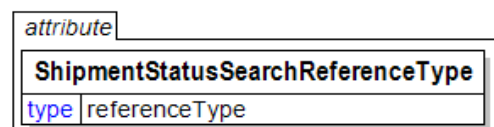

@AssignedBy will communicate the information previously communicated in the prefix.

Refer to the [referenceType](#) entry for the list of enumerations and their definitions.

ShipmentStatusShipment

The shipment or consignment details that are being communicated.

LegStageType [attribute]

LegStageType is optional. A single instance might exist.

Refer to LegStageType definition for any enumerations.

ShipmentComplete [attribute]

ShipmentComplete is optional. A single instance might exist.

Either "Yes" or "No".

Refer to ShipmentComplete definition for any enumerations.

(sequence)

The sequence of items below is mandatory. A single instance is required.

ShipmentStatusReference

ShipmentStatusReference is mandatory. One instance is required, multiple instances might exist.

An item detailing relevant references pertaining to the ShipmentStatus information. The type of reference is identified by the ShipmentStatusReferenceType attribute.

TimePeriod

TimePeriod is optional. A single instance might exist.

The TimePeriod element is used to communicate a duration period of time as indicated in PeriodType.

ShipmentEventInformation

ShipmentEventInformation is mandatory. One instance is required, multiple instances might exist.

A grouping element that contains the items that describe the shipment event and

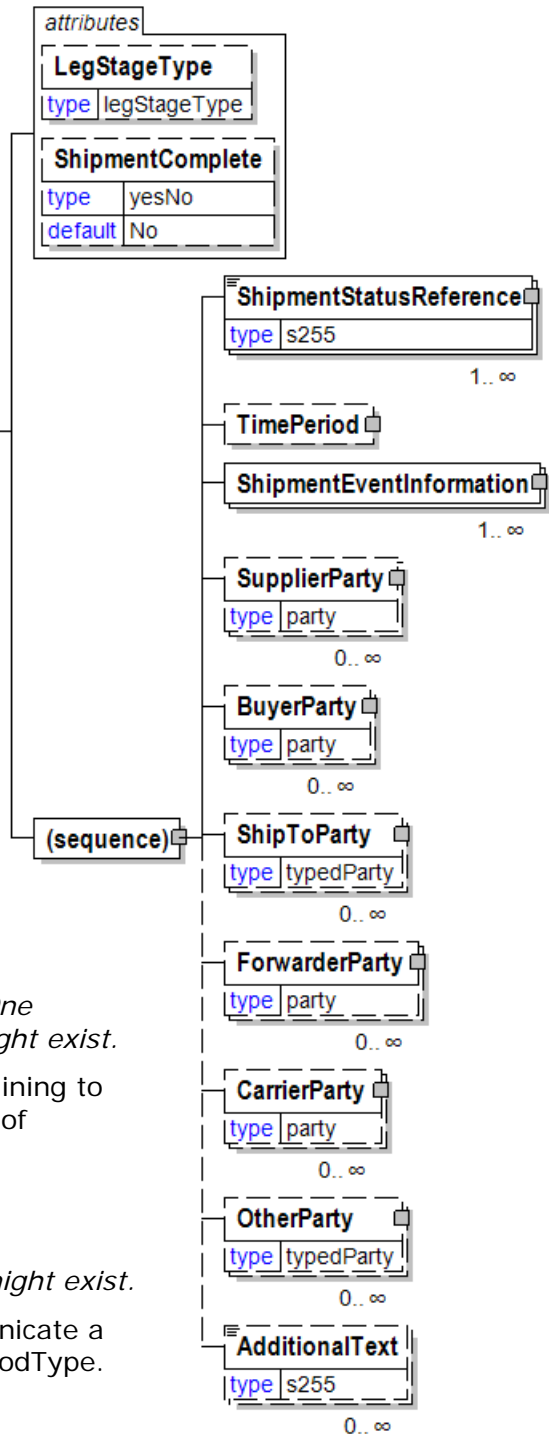

status situation

SupplierParty

SupplierParty is optional. Multiple instances might exist.

The organisation or business entity responsible for providing the product. SupplierParty is also the seller of the product, if Seller is not specified as OtherParty = Seller.

BuyerParty

BuyerParty is optional. Multiple instances might exist.

The legal entity to which the product is sold. Also commonly referred to as the sold-to party or customer. If no OtherParty is defined as the Payer, the Buyer is the Payer.

ShipToParty

ShipToParty is optional. Multiple instances might exist.

The name and/or address to which the goods should be delivered with the party type indicated by the PartyType attribute.

ForwarderParty

ForwarderParty is optional. Multiple instances might exist.

The trading partner involved in the forwarding of the shipment.

CarrierParty

CarrierParty is optional. Multiple instances might exist.

The party performing the transport of the product from the pickup location to the ship-to location; could be a hauler.

OtherParty

OtherParty is optional. Multiple instances might exist.

An organisation or business entity other than those specifically detailed within a e-Document.

AdditionalText

AdditionalText is optional. Multiple instances might exist.

A text field that is used to communicate information not previously defined or for special instructions. To be used only for circumstances not covered by specific elements.

ShipmentStatusType [attribute]

Identifies the status of the shipment being reported.

This item is restricted to the following list.

OnTime

The shipment is on-time.

Early

The shipment is before planned schedule.

Delayed

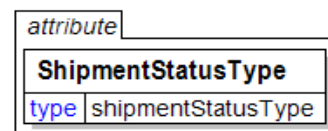

The shipment has been delayed.

Cancelled

The shipment was cancelled. Do not deliver this product.

Rejected

The shipment has been rejected.

Unspecified

When a status is required to be communicated but none is available.

ShipmentSummary

Summary information for an entire shipment

(sequence)

The sequence of items below is mandatory. A single instance is required.

TotalQuantity

TotalQuantity is optional. A single instance might exist.

The total quantity of similar items in the e-Document. TotalQuantity is primarily used in the summary section of documents where it is repeatable to permit totaling for different units of measure.

TotalInformationalQuantity

TotalInformationalQuantity is optional. Multiple instances might exist.

A quantity that is used to communicate related information about the parent element. This element represents a total that is derived from individual line items.

ProductSummary

ProductSummary is optional. A single instance might exist.

Group of elements to provide summary information on product level.

LengthSpecification

LengthSpecification is optional. Multiple instances might exist.

Length specification of the wood product.

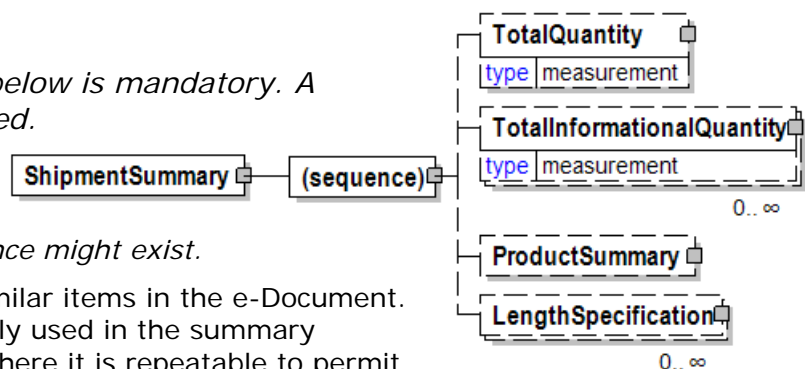

ShippingInstructions

The ShippingInstructions element is the root element for the ShippingInstructions e-Document.

The ShippingInstructions e-Document communicates delivery information for product(s) supported by a PurchaseOrder.

ShippingInstructions

ShippingInstructionsType [attribute]

ShippingInstructionsType is mandatory. A single instance is required.

ShippingInstructionType defines the type of shipping instruction

Refer to ShippingInstructionsType definition for any enumerations.

ShippingInstructionsStatusType [attribute]

ShippingInstructionsStatusType is mandatory. A single instance is required.

ShippingInstructions Status Type

Refer to ShippingInstructionsStatusType definition for any enumerations.

IsThirdPartyAdvice [attribute]

IsThirdPartyAdvice is optional. A single instance might exist.

An advice to a third party of a ShippingInstructions.

Refer to IsThirdPartyAdvice definition for any enumerations.

IsThirdPartyShipment [attribute]

IsThirdPartyAdvice is optional. A single instance might exist.

Shipment request to a party other than the party that ordered the product from the supplier.

Either "Yes" or "No".

Reissued [attribute]

Reissued is optional. A single instance might exist.

Either "Yes" or "No".

Refer to Reissued definition for any enumerations.

Language [attribute]

Language is optional. A single instance might exist.

XML has embraced 2 and 3 digit language codes through the application of an addendum to the standard.

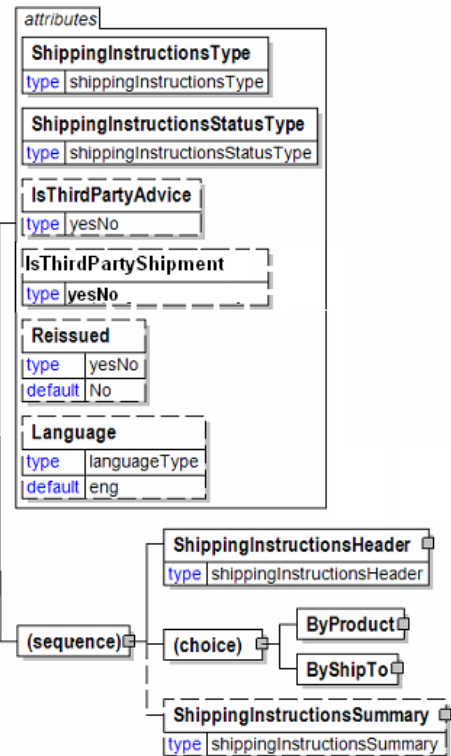

Refer to Language definition for any enumerations.

(sequence)

The sequence of items below is mandatory. A single instance is required.

ShippingInstructionsHeader

ShippingInstructionsHeader is mandatory. A single instance is required.

Information common to all items in a ShippingInstructions e-Document.

(choice)

[choice] is optional because of choice construct.

ByProduct

ByProduct is optional because of choice construct.

Identification takes place by product.

ByShipTo

ByShipTo is optional because of choice construct.

ByShipTo

ShippingInstructionsSummary

ShippingInstructionsSummary is optional. A single instance might exist.

Summary information for the ShippingInstructions e-Document.

ShippingInstructionsConfirmationIssuedDate

The date on which the shipping instruction confirmation was issued.

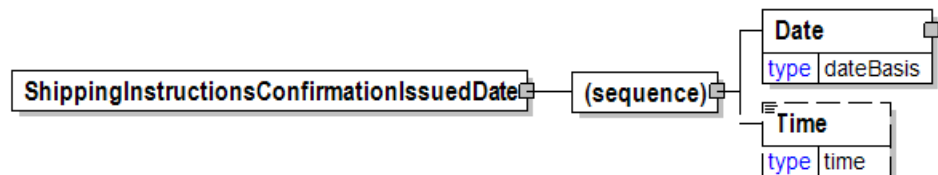

(sequence)

The sequence of items below is mandatory. A single instance is required.

Date

Date is mandatory. A single instance is required.

A group element that contains the specification of Year, Month, and Day.

Time

Time is optional. A single instance might exist.

Times are treated in a standard XML fashion with a special case used to indicate a generalized "local" time. The standard XML approach to time is hh:mm:ss, hh:mm:ssZ, or hh:mm:ss±hh:mm.

hh:mm:ss±hh:mm is used to represent a time with a time zone. The time zone is communicated as the number of hours offset from the Universal Time Coordinate (UTC), a.k.a. Greenwich Mean Time.

hh:mm:ssZ indicates the time at Zulu (another name for UTC). Based on the convention described in the next bullet it will be important for users within UTC to use "Z" when communicating a time in their time zone to other users.

hh:mm:ss or hh:mm indicates in the XML standard the time at UTC however,

within papiNet it is used to represent the applicable local time. Caution should be used when processing times of this nature as the papiNet approach may be in discord with other users of XML.

ShippingInstructionsHeader

Information common to all items in a ShippingInstructions e-Document.

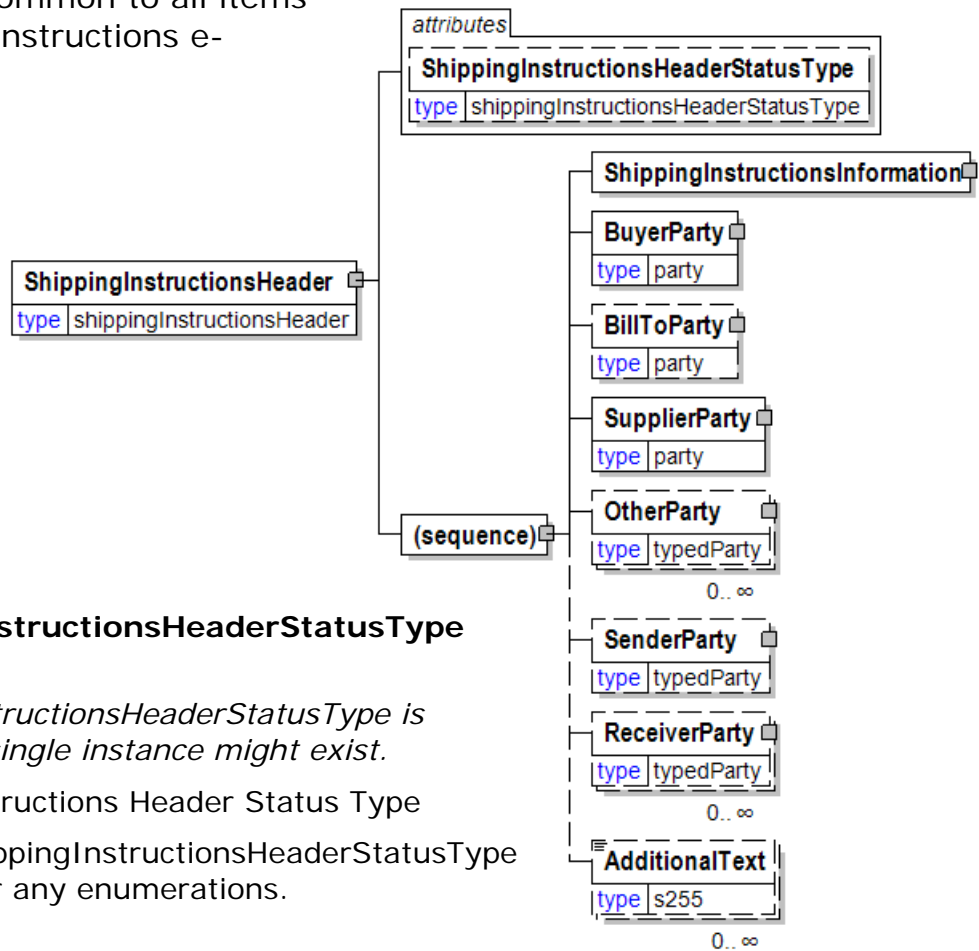

ShippingInstructionsHeaderStatusType [attribute]

ShippingInstructionsHeaderStatusType is optional. A single instance might exist.

ShippingInstructions Header Status Type

Refer to ShippingInstructionsHeaderStatusType definition for any enumerations.

(sequence)

The sequence of items below is mandatory. A single instance is required.

ShippingInstructionsInformation

ShippingInstructionsInformation is mandatory. A single instance is required.

A group item containing information unique to this ShippingInstructions and reference information used to identify the product to be shipped

BuyerParty

BuyerParty is mandatory. A single instance is required.

The legal entity to which the product is sold. Also commonly referred to as the sold-to party or customer. If no OtherParty is defined as the Payer, the Buyer is the Payer.

BillToParty

BillToParty is optional. A single instance might exist.

The address where the invoice is to be sent.

SupplierParty

papiNet V2R31

SupplierParty is mandatory. A single instance is required.

The organisation or business entity responsible for providing the product. SupplierParty is also the seller of the product, if Seller is not specified as OtherParty = Seller.

OtherParty

OtherParty is optional. Multiple instances might exist.

An organisation or business entity other than those specifically detailed within a e-Document.

SenderParty

SenderParty is optional. A single instance might exist.

The business entity issuing the e-Document, the source of the document.

The entity responsible for the content. If the sender party has out sourced the message service to a third party the SenderParty is the issuer of the e-Document and not the party performing the transmission service of the electronic message.

ReceiverParty

ReceiverParty is optional. Multiple instances might exist.

The business entity for whom the e-Document is intended, the destination of the document.

The entity interested in the content. If the receiver party has outsourced the message service to a third party the ReceiverParty is the intended party for the e-Document and not the party performing the receiving service of the electronic message.

AdditionalText

AdditionalText is optional. Multiple instances might exist.

A text field that is used to communicate information not previously defined or for special instructions. To be used only for circumstances not covered by specific elements.

ShippingInstructionsHeaderStatusType [attribute]

ShippingInstructions Header Status Type

This item is restricted to the following list.

attribute
ShippingInstructionsHeaderStatusType
type shippingInstructionsHeaderStatusType

Accepted

The supplied information is accepted.

Amended

The supplied information is changed.

NoAction

The supplied information has not been amended and thereby requires no action.

Original

The supplied information is the first version of that information.

Rejected

The supplied information is rejected.

ShippingInstructionsInformation

A group item containing information unique to this ShippingInstructions and reference information used to identify the product to be shipped

(sequence)

The sequence of items below is

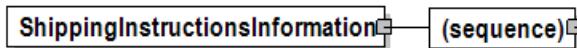

mandatory. A single instance is required.

ShippingInstructionsNumber

ShippingInstructionsNumber is mandatory. A single instance is required.

The unique shipping instruction.

ShippingInstructionsIssuedDate

ShippingInstructionsIssuedDate is mandatory. A single instance is required.

The date on which the shipping instruction was issued.

ShippingInstructionsConfirmationIssuedDate

ShippingInstructionsConfirmationIssuedDate is optional. A single instance might exist.

The date on which the shipping instruction confirmation was issued.

TransactionHistoryNumber

TransactionHistoryNumber is optional. A single instance might exist.

A sequential number that keeps track of the version of a document being sent by the document originator except in the case where TransactionHistoryConfirmation is used, in which case the TransactionHistoryNumber refers to the trigger transaction for which the confirmation is being sent.

TransactionHistoryConfirmationNumber

TransactionHistoryConfirmationNumber is optional. A single instance might exist.

A sequential number that indicates the version of the confirmation document being sent.

ShippingInstructionsReference

ShippingInstructionsReference is optional. Multiple instances might exist.

A group item detailing relevant references (such as ISBN) pertaining to the ShippingInstructions and/or product being shipped.

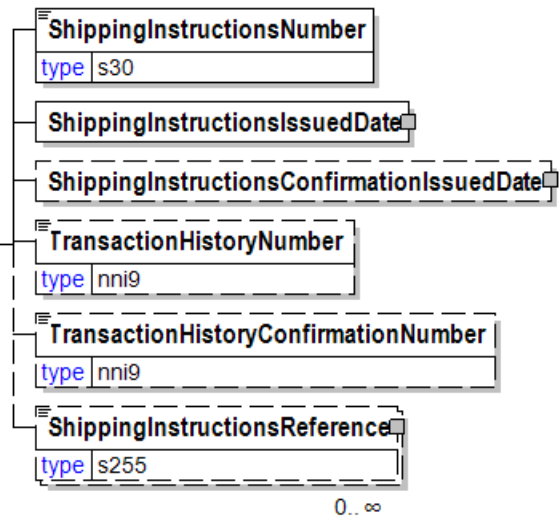

ShippingInstructionsIssuedDate

The date on which the shipping instruction was issued.

(sequence)

The sequence of items below is mandatory. A single instance is required.

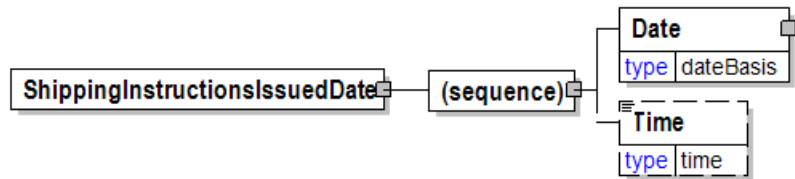

Date

Date is mandatory. A single instance is required.

A group element that contains the specification of Year, Month, and Day.

Time

Time is optional. A single instance might exist.

Times are treated in a standard XML fashion with a special case used to indicate a generalized "local" time. The standard XML approach to time is hh:mm:ss, hh:mm:ssZ, or hh:mm:ss±hh:mm.

hh:mm:ss±hh:mm is used to represent a time with a time zone. The time zone is communicated as the number of hours offset from the Universal Time Coordinate (UTC), a.k.a. Greenwich Mean Time.

hh:mm:ssZ indicates the time at Zulu (another name for UTC). Based on the convention described in the next bullet it will be important for users within UTC to use "Z" when communicating a time in their time zone to other users.

hh:mm:ss or hh:mm indicates in the XML standard the time at UTC however, within papiNet it is used to represent the applicable local time. Caution should be used when processing times of this nature as the papiNet approach may be in discord with other users of XML.

ShippingInstructionsLineItemByProduct

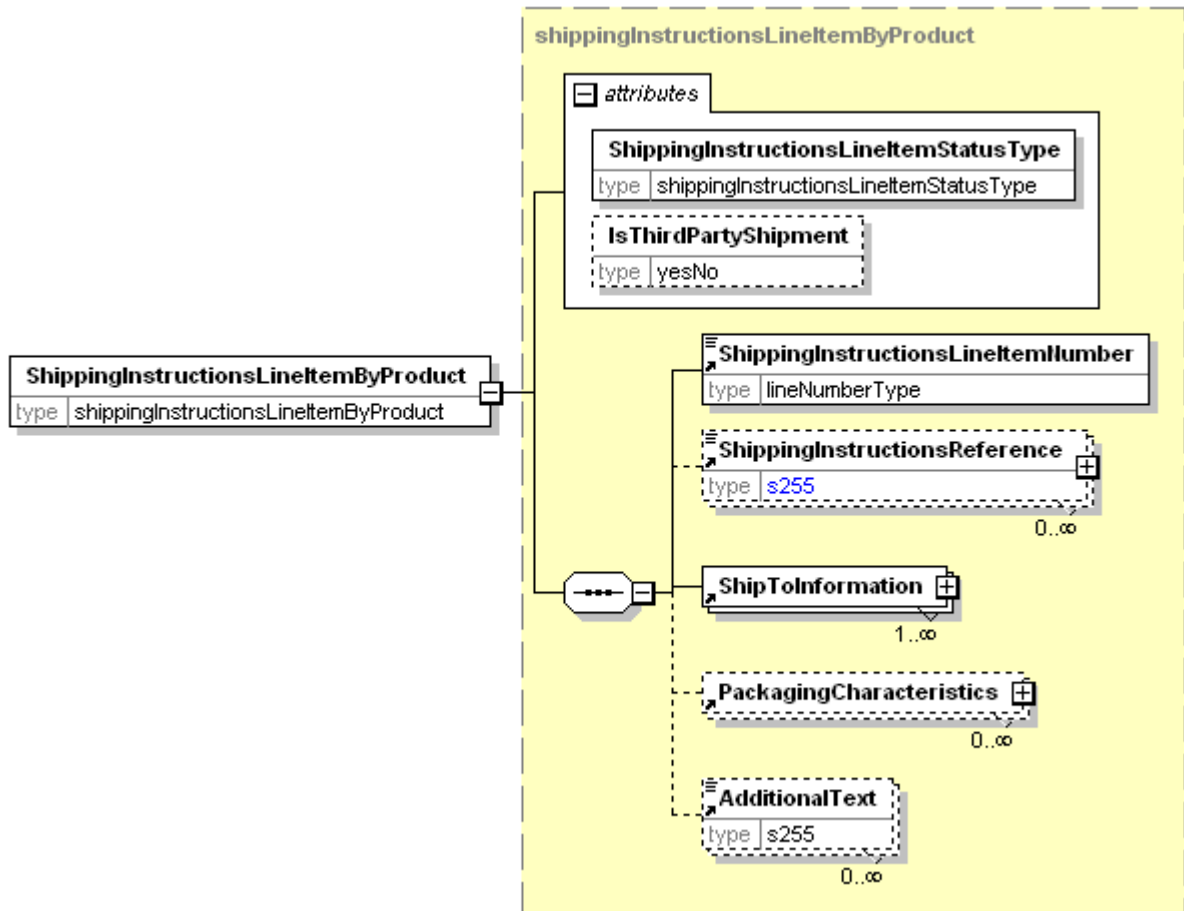

ShippingInstructionsLineItemByProduct

ShippingInstructionsLineItemStatusType [attribute]

ShippingInstructionsLineItemStatusType is mandatory. A single instance is required.

ShippingInstructions Line Item Status Type

Refer to ShippingInstructionsLineItemStatusType definition for any enumerations.

IsThirdPartyShipment [attribute]

IsThirdPartyAdvice is optional. A single instance might exist.

Shipment request to a party other than the party that ordered the product from the supplier.

Either "Yes" or "No".

(sequence)

The sequence of items below is mandatory. A single instance is required.

ShippingInstructionsLineItemNumber

ShippingInstructionsLineItemNumber is mandatory. A single instance is required.

The sequential number that uniquely identifies the ShippingInstructions line item.

ShippingInstructionsReference

papiNet V2R31

ShippingInstructionsReference is optional. Multiple instances might exist.

A group item detailing relevant references (such as ISBN) pertaining to the ShippingInstructions and/or product being shipped.

ShipToInformation

ShipToInformation is mandatory. One instance is required, multiple instances might exist.

Group element containing information about the ship to and delivery of a product.

PackagingCharacteristics

PackagingCharacteristics is optional. Multiple instances might exist.

An element containing carton or pallet packing information.

PackagingCharacteristics can either have the BoxCharacteristics or PalletPackagingCharacteristics element not both.

AdditionalText

AdditionalText is optional. Multiple instances might exist.

A text field that is used to communicate information not previously defined or for special instructions. To be used only for circumstances not covered by specific elements.

ShippingInstructionsLineItemByShipTo

ShippingInstructions
Line Item By Ship To

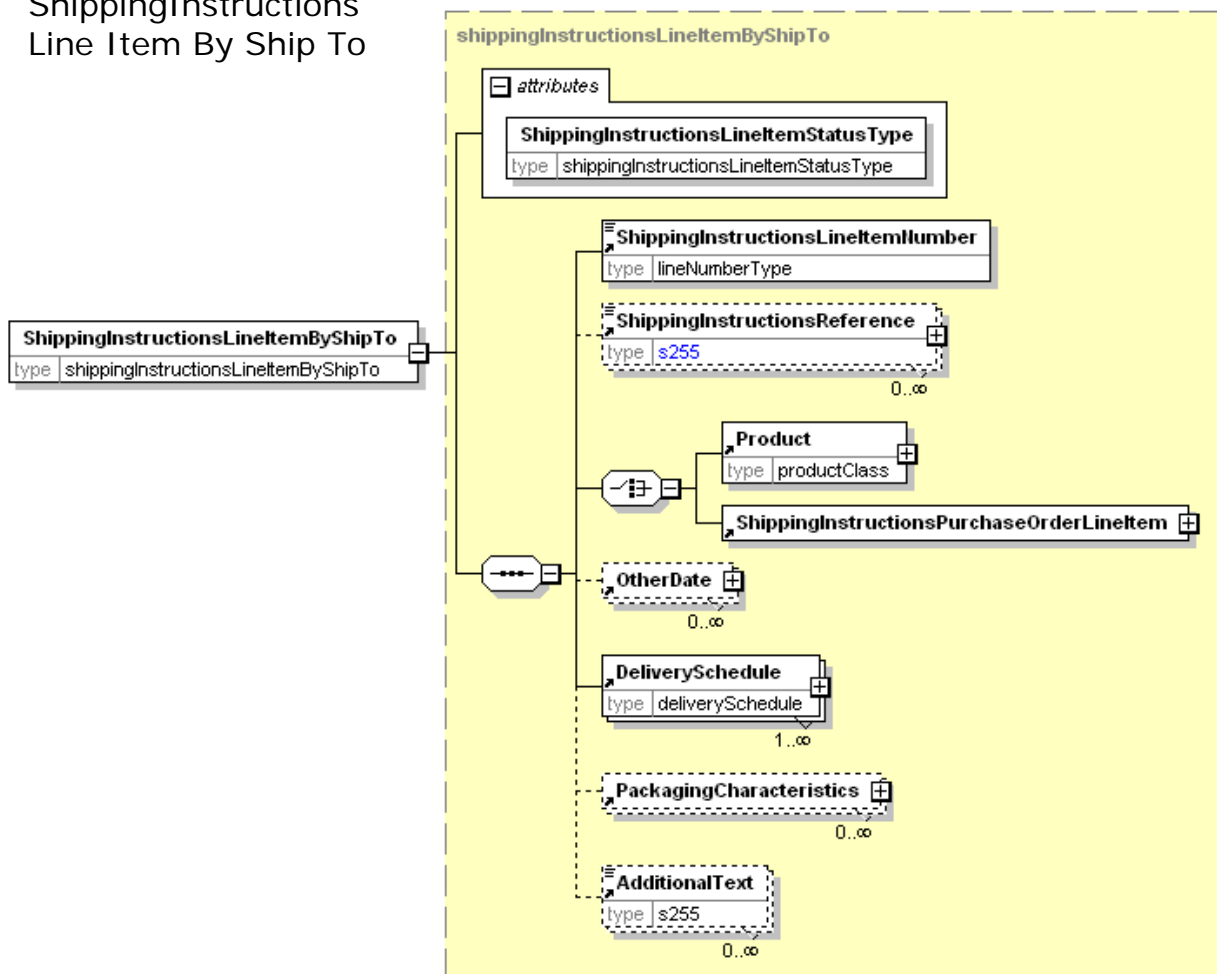

ShippingInstructionsLineItemStatusType [attribute]

ShippingInstructionsLineItemStatusType is mandatory. A single instance is required.

ShippingInstructions Line Item Status Type

Refer to ShippingInstructionsLineItemStatusType definition for any enumerations.

(sequence)

The sequence of items below is mandatory. A single instance is required.

ShippingInstructionsLineItemNumber

ShippingInstructionsLineItemNumber is mandatory. A single instance is required.

The sequential number that uniquely identifies the ShippingInstructions line item.

ShippingInstructionsReference

ShippingInstructionsReference is optional. Multiple instances might exist.

A group item detailing relevant references (such as ISBN) pertaining to the ShippingInstructions and/or product being shipped.

(choice)

[choice] is optional because of choice construct.

Product

Product is optional because of choice construct.

Product is a group item defining the article and its characteristics. Product is used to specify product characteristics organized by ProductIdentifier, ProductDescription, and Classification. Book Manufacturing, Label Stock, Paper, Pulp, Recovered Paper, Wood Products, and Virgin Fibre market segments have defined their product characteristics and conversion features for implementation in papiNet.

ShippingInstructionsPurchaseOrderLineItem

ShippingInstructionsPurchaseOrderLineItem is optional because of choice construct.

PurchaseOrder line item information for PurchaseOrder being referenced in ShippingInstructions.

OtherDate

OtherDate is optional. Multiple instances might exist

A date that may not be specifically detailed within a document (example: print date at the PurchaseOrderLineItem).

DeliverySchedule

DeliverySchedule is mandatory. One instance is required, Multiple instances might exist.

A group item defining a series of DeliveryDateWindow(s) in which specified quantities must be delivered.

PackagingCharacteristics

PackagingCharacteristics is optional. Multiple instances might exist.

An element containing carton or pallet packing information. PackagingCharacteristics can either have the BoxCharacteristics or PalletPackagingCharacteristics element not both.

AdditionalText

AdditionalText is optional. Multiple instances might exist.

A text field that is used to communicate information not previously defined or for special instructions. To be used only for circumstances not covered by specific elements.

ShippingInstructionsLineItemNumber

The sequential number that uniquely identifies the ShippingInstructions line item.

ShippingInstructionsLineItemNumber	
type	lineNumberType

ShippingInstructionsLineItemStatusType [attribute]

ShippingInstructions Line Item Status Type

This item is restricted to the following list.

attribute	ShippingInstructionsLineItemStatusType	
type	shippingInstructionsLineItemStatusType	

Accepted

The supplied information is accepted.

Amended

The supplied information is changed.

Cancelled

The supplied information has been cancelled. Items that have been cancelled are not included in totals on the summary levels of the e-Document.

NoAction

The supplied information has not been amended and thereby requires no action.

Original

The supplied information is the first version of that information.

Pending

The supplied information is not complete and will be updated later.

Rejected

The supplied information is rejected.

ShippingInstructionsNumber

The unique shipping instruction.

ShippingInstructionsNumber	
type	s30

ShippingInstructionsPurchaseOrderLineItem

PurchaseOrder line item information for PurchaseOrder being referenced in ShippingInstructions.

(sequence)

The sequence of items below is mandatory. A

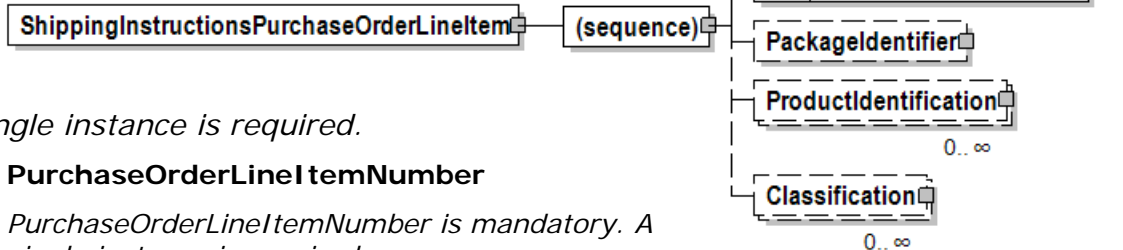

single instance is required.

PurchaseOrderLineItemNumber

PurchaseOrderLineItemNumber is mandatory. A single instance is required.

The sequential number that uniquely identifies the PurchaseOrder line item.

PurchaseOrderInformation

PurchaseOrderInformation is mandatory. A single instance is required.

A group item containing information unique to this PurchaseOrder, which is provided by the buyer. PurchaseOrderInformation can be optional in the supply chain. Invoices are created without having a PurchaseOrder in Vendor Managed Inventory. Freight invoices also will not have a PurchaseOrder number.

PackageIdentifier

PackageIdentifier is optional. A single instance might exist.

The identifier of the productpackage (such as reel ID or pallet ID) that is used along with the PurchaseOrderLineItemNumber to call off the product.

ProductIdentification

ProductIdentification is optional. Multiple instances might exist.

A grouping element designed to communicate product identification related to the parent element that contains this item.

Classification

Classification is optional. Multiple instances might exist.

A group item that details the product classification according to a particular organization's scheme. An item across multiple classifications would still be recognized as the same item. Examples of some product classifications are: Containerboard, Pulp-Dissolving, or Newsprint.

ShippingInstructionsReference

A group item detailing relevant references (such as ISBN) pertaining to the

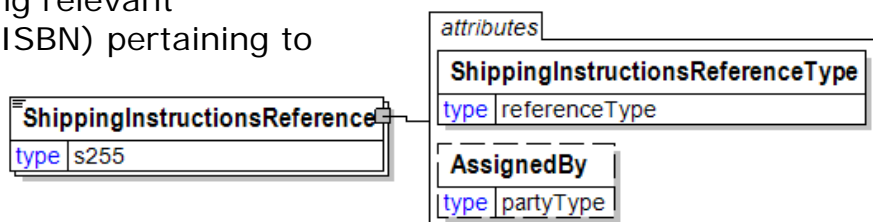

ShippingInstructions and/or product

being shipped.

ShippingInstructionsReferenceType [attribute]

ShippingInstructionsReferenceType is mandatory. A single instance is required.

Provides a contextual explanation of the specific reference identifier. Many items are currently prefixed by "Buyer", "Forwarder", "Manufacturer", "Mill", "Seller", "Supplier", "Warehouse", or "Vendor". Check for an existing non-prefixed version and use the non-prefixed version instead. In the (yet to be announced release date) version 3.0 the prefixed versions will be removed. Instead the attribute @AssignedBy will communicate the information previously communicated in the prefix.

Refer to ShippingInstructionsReferenceType definition for any enumerations.

AssignedBy [attribute]

AssignedBy is optional. A single instance might exist.

Identifies the type of party that has assigned the associated item, e.g. a reference of type OrderNumber.

Refer to AssignedBy for any enumerations.

ShippingInstructionsReferenceType [attribute]

Provides a contextual explanation of the specific reference identifier. Many items are currently prefixed by "Buyer", "Forwarder", "Manufacturer", "Mill", "Seller", "Supplier", "Warehouse", or "Vendor". Check for an existing non-prefixed version and use the non-prefixed version instead. In the (yet to be announced release date) version 3.0 the prefixed versions will be removed. Instead the attribute @AssignedBy will communicate the information previously communicated in the prefix.

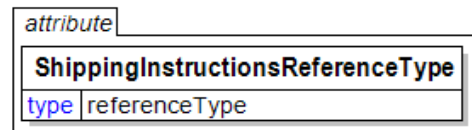

Refer to the [referenceType](#) entry for the list of enumerations and their definitions.

ShippingInstructionsRequestDetail

A grouping element that provides the parameters to be used when responding with a ShippingInstructions e-Document.

(sequence)

The sequence of items below is mandatory. A single instance is required.

SupplierParty

SupplierParty is optional. Multiple instances might exist.

The organisation or business entity responsible for providing the product. SupplierParty is also the seller of the product, if Seller is not specified as OtherParty = Seller.

BuyerParty

BuyerParty is optional. Multiple instances might exist.

The legal entity to which the product is sold. Also commonly referred to as the sold-to party or customer. If no OtherParty is defined as the Payer, the Buyer is the Payer.

ShipToParty

ShipToParty is optional. Multiple instances might exist.

The name and/or address to which the goods should be delivered with the party type indicated by the PartyType attribute.

ForwarderParty

ForwarderParty is optional. Multiple instances might exist.

The trading partner involved in the forwarding of the shipment.

CarrierParty

CarrierParty is optional. Multiple instances might exist.

The party performing the transport of the product from the pickup location to the ship-to location; could be a hauler.

OtherParty

OtherParty is optional. Multiple instances might exist.

An organisation or business entity other than those specifically detailed within a e-Document.

ByPurchaseOrder

ByPurchaseOrder is mandatory. One instance is required, multiple instances might exist.

Selection criteria for communicating purchase order information.

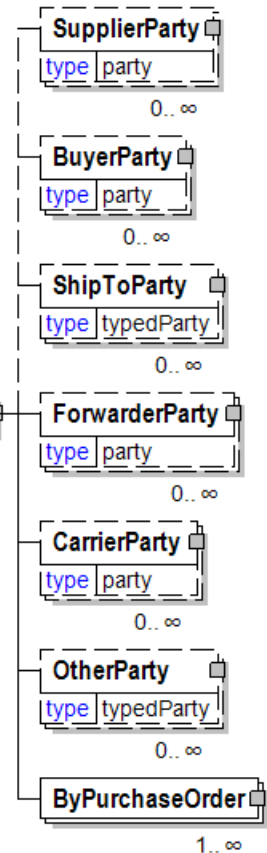

ShippingInstructionsStatusType [attribute]

ShippingInstructions Status Type

This item is restricted to the following list.



Accepted

The supplied information is accepted.

Amended

The supplied information is changed

Cancelled

The supplied information has been cancelled. Items that have been cancelled are not included in totals on the summary levels of the e-Document.

Original

The supplied information is the first version of that information.

Rejected

The supplied information is rejected.

ShippingInstructionsSummary

Summary information for the ShippingInstructions e-Document.

(sequence)

The sequence of items below is mandatory. A single instance is required.

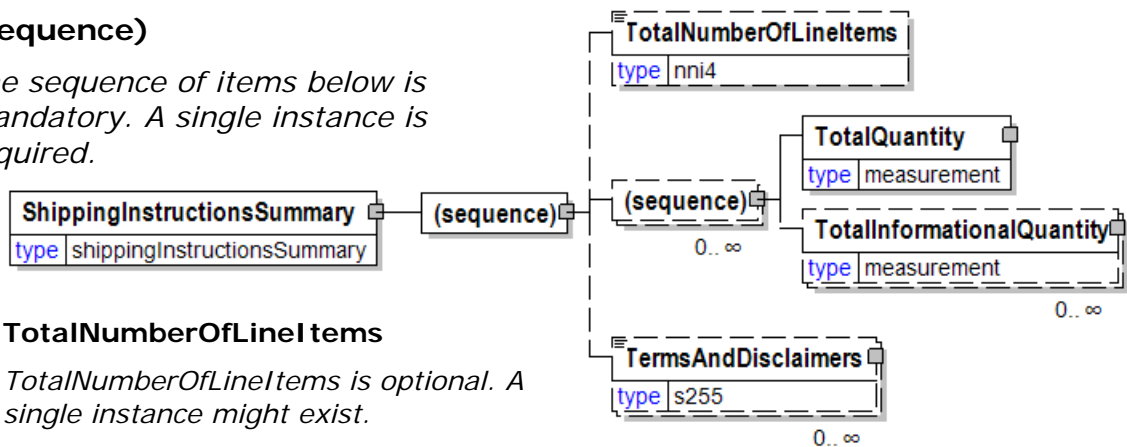

TotalNumberOfLineItems

TotalNumberOfLineItems is optional. A single instance might exist.

The total number of individual line items in the document, regardless of the status or type.

(sequence)

The sequence of items below is optional. Multiple instances might exist.

TotalQuantity

TotalQuantity is mandatory. A single instance is required.

The total quantity of similar items in the e-Document. TotalQuantity is primarily used in the summary section of documents where it is repeatable to permit totaling for different units of measure.

TotalInformationalQuantity

TotalInformationalQuantity is optional. Multiple instances might exist.

A quantity that is used to communicate related information about the parent element. This element represents a total that is derived from individual line items.

TermsAndDisclaimers

TermsAndDisclaimers is optional. Multiple instances might exist.

An element that contains legal information with an indication of what the Language is.

ShippingInstructionsType [attribute]

ShippingInstructionType defines the type of shipping instruction.

This item is restricted to the following list.

ShippingInstructionsConfirmation

Confirmation of the Shipping Instruction.

ShippingInstructionsDistribution

Shipping Instruction serves as a billable order for shipping product that was produced under a previous manufacturing order.

ShippingInstructionsPackaging

To be deprecated in a future version. Guidance will be given to trading partners not to use this enumeration.

ShippingInstructionsRouting

Shipping instructions issued in conjunction with a PurchaseOrder for shipping the product.

ShippingMark

A shipping mark identifies the producer and quality on the end side of the product. Not to be mixed with company code/logo or other product marking.

ShippingMark
type s20

ShipToCharacteristics

A group item that provides information important for the Ship-To Party.

A group item that provides information important for the Ship-To Party. ShipToCharacteristics may be referenced at both the header and line item level.

The reference at the header is required and acts as a default for the value at the line level, unless overridden at the line level.

(sequence)

The sequence of items below is mandatory. A single instance is required.

ShipToParty

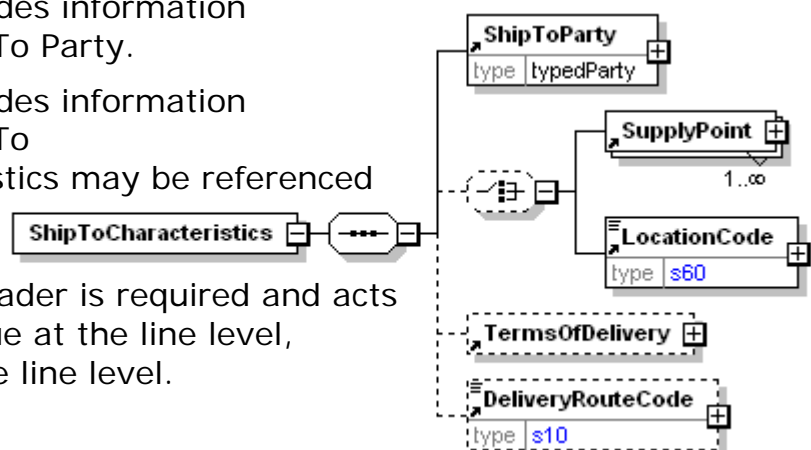

ShipToParty is mandatory. A single instance is required.

The name and/or address to which the goods should be delivered with the party type indicated by the PartyType attribute.

(choice)

[choice] is optional because of choice construct.

SupplyPoint

SupplyPoint is optional because of choice construct.

Grouping element that contains items describing a supply point. A SupplyPoint belongs to a LocationParty, e.g. in a DeliveryOrigin or DeliveryDestination, and describes where goods are stored and can be loaded or unloaded. A SupplyPoint can for example be a loading or unloading gate at a warehouse or a road side landing at a logging area in the forest.

LocationCode

LocationCode is optional because of choice construct.

A code used to identify a specific physical location within a site identified by a party, e.g. a loading station in a warehouse or an unloading station at a printer site.

LocationCode will be deprecated in a future version. Use SupplyPoint instead of LocationCode.

TermsOfDelivery

TermsOfDelivery is optional. A single instance might exist.

A group item defining the terms under which the delivery of goods will take place. These terms determine when and under what conditions the transfer of ownership will occur. Generally speaking, the Incoterms are primarily used in Europe, whereas the ShipmentMethodOfPayment is primarily used in North America.

DeliveryRouteCode

DeliveryRouteCode is optional. A single instance might exist.

A code representing the delivery route as indicated by the Agency.

ShipToInformation

Group element containing information about the ship to and delivery of a product.

(sequence)

The sequence of items

below is mandatory. A single instance is required.

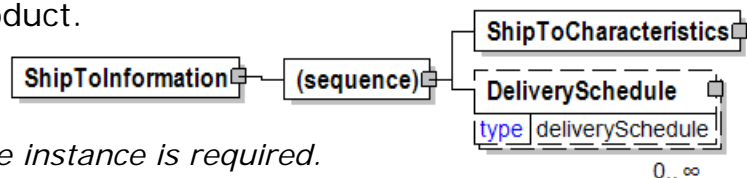

ShipToCharacteristics

ShipToCharacteristics is mandatory. A single instance is required.

A group item that provides information important for the Ship-To Party.

A group item that provides information important for the Ship-To Party. ShipToCharacteristics may be referenced at both the header and line item level. The reference at the header is required and acts as a default for the value at the line level, unless overridden at the line level.

DeliverySchedule

DeliverySchedule is optional. Multiple instances might exist.

A group item defining a series of DeliveryDateWindow(s) in which specified quantities must be delivered.

ShipToParty

The name and/or address to which the goods should be delivered with the party type indicated by the PartyType attribute.

PartyType [attribute]

PartyType is mandatory. A single instance is required.

Identifies the business role associated with the particular party

Refer to PartyType definition for any enumerations.

LogisticsRole [attribute]

LogisticsRole is optional. A single instance might exist.

Communicates the nature of the logistics role, if any, the party plays in the transaction.

Refer to LogisticsRole definition for any enumerations.

(sequence)

The sequence of items below is mandatory. A single instance is required.

PartyIdentifier

PartyIdentifier is optional. Multiple instances might exist.

A unique identifier of a specific party. This element contains an attribute PartyIdentifierType that indicates the type of party.

NameAddress

NameAddress is mandatory. A single instance is required.

A group item containing name and address of an organisation or business entity.

URL

URL is optional. A single instance might exist.

Universal Resource Locator. While typically a web address you could use this field to hold an email address.

CommonContact

CommonContact is optional. Multiple instances might exist.

Identifies a specific individual associated with the party.

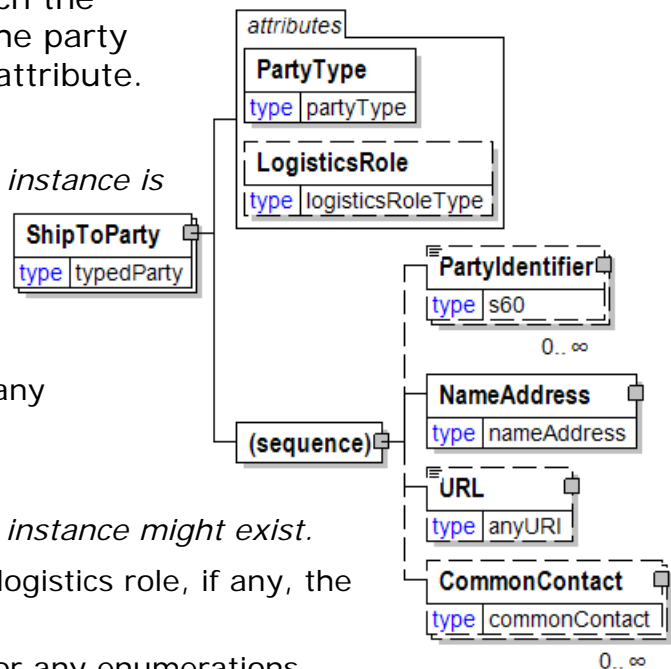

ShowThrough

Show through

TestMethod [attribute]

TestMethod is optional. A single instance might exist.

The method used to determine the results of the test under consideration.

TestAgency [attribute]

TestAgency is optional. A single instance might exist.

The agency that has set the parameters for the testing

Refer to TestAgency definition for any enumerations.

SampleType [attribute]

SampleType is optional. A single instance might exist.

Communicates how sampling was done to measure the product characteristics.

Refer to SampleType definition for any enumerations.

ResultSource [attribute]

ResultSource is optional. A single instance might exist.

Used to define the data source of the specified test

Refer to ResultSource definition for any enumerations.

(sequence)

The sequence of items below is mandatory. A single instance is required.

DetailValue

DetailValue is mandatory. A single instance is required.

A numeric value expressed in the unit of measure (UOM).

DetailRangeMin

DetailRangeMin is optional. A single instance might exist.

The minimum value (lower boundary) allowed for the DetailValue that is the parent of this element.

DetailRangeMax

DetailRangeMax is optional. A single instance might exist.

The maximum value (upper boundary) allowed for the DetailValue that is the parent of this element.

StandardDeviation

StandardDeviation is optional. A single instance might exist.

A statistic used as a measure of dispersion in a distribution.

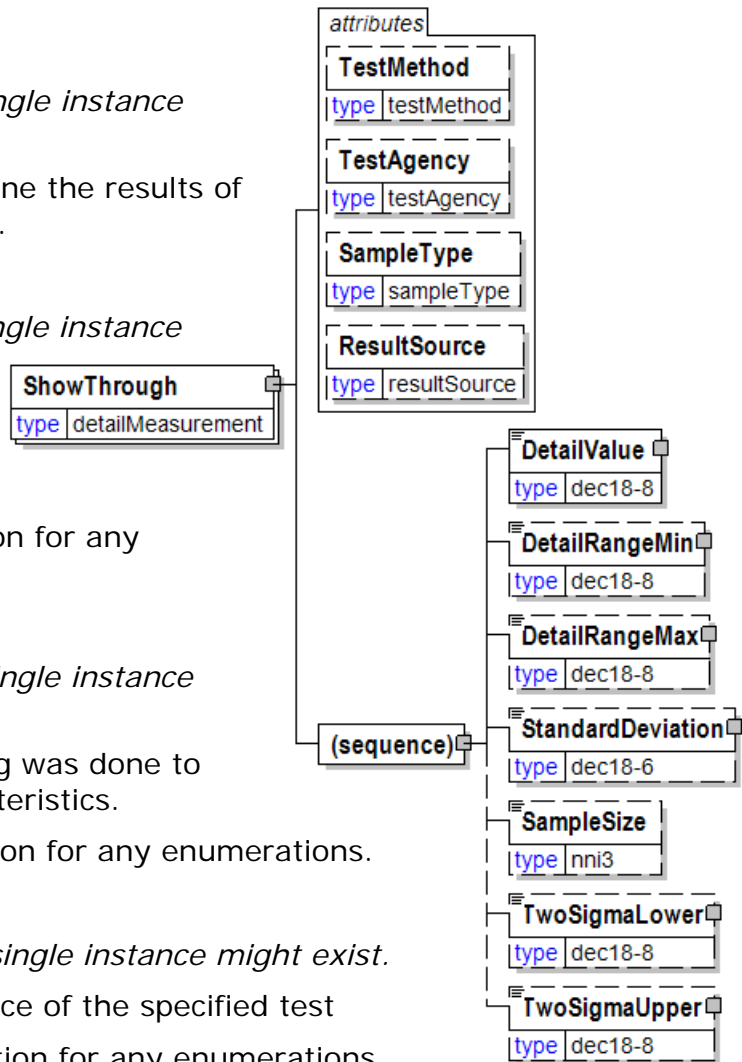

SampleSize

SampleSize is optional. A single instance might exist.

The number of samples used to determine the product characteristic in question.

TwoSigmaLower

TwoSigmaLower is optional. A single instance might exist.

Two sigma (a measure of dispersion associated with standard deviation) on the lower side of the standard deviation.

TwoSigmaUpper

TwoSigmaUpper is optional. A single instance might exist.

Two sigma (a measure of dispersion associated with standard deviation) on the upper side of the standard deviation.

Side

The structure defines the features of a panel's side. An attribute of side element indicates which side (either top or bottom) the child elements refer to.

TopSide [attribute]

TopSide is optional. A single instance might exist.

Either "Yes" or "No".

Refer to TopSide definition for any enumerations.

(sequence)

The sequence of items below is mandatory. A single instance is required.

Surface

Surface is optional. A single instance might exist.

PlywoodPlyGrade

PlywoodPlyGrade is optional. A single instance might exist.

Defines the grade of one ply, used with Agency to specify the grading agency.

Embossing

Embossing is optional. A single instance might exist.

Embossing requirements for sheets and reels. Embossing involves a physical deformation of the paper surface as part of the conversion process. Embossing is applied either in-line (directly after the paper machine) or off-line. Refer to the attribute FinishType for additional information.

PlywoodMachining

PlywoodMachining is optional. A single instance might exist.

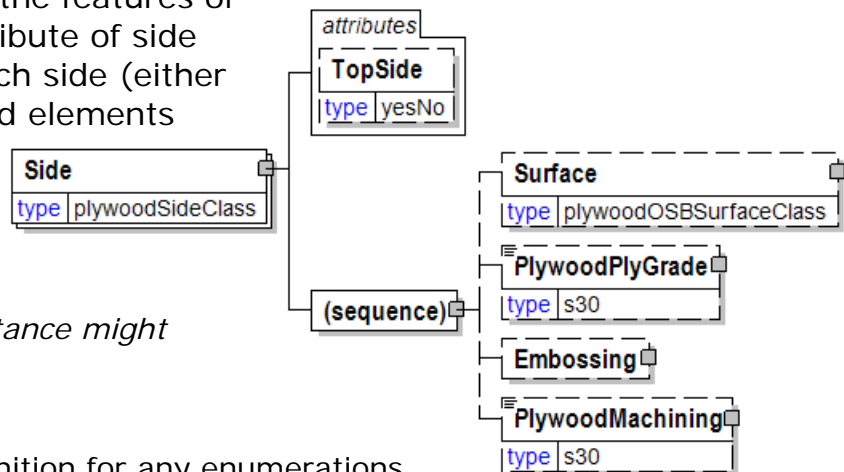

papiNet V2R31

PlywoodMachining defines the machining made to the panel (for example, grooving).

SideOneTime

The time for side one.

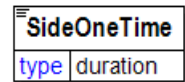

SideTwoTime

The time for side two.

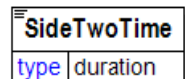

SignatureID

Signature ID

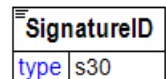

Signatures

Signatures.

(sequence)

The sequence of items below is mandatory. A single instance is required.

PagesPerSignature

PagesPerSignature is mandatory. A single instance is required.

Pages per signature

NumberOfSignatures

NumberOfSignatures is mandatory. A single instance is required.

The number of signatures.

SignatureID

SignatureID is optional. A single instance might exist.

Signature ID

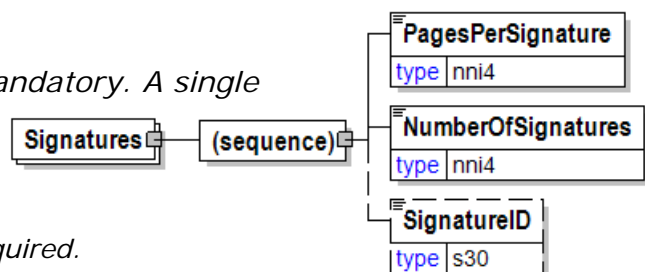

SingleWidthReel

Single width reel information.

(sequence)

The sequence

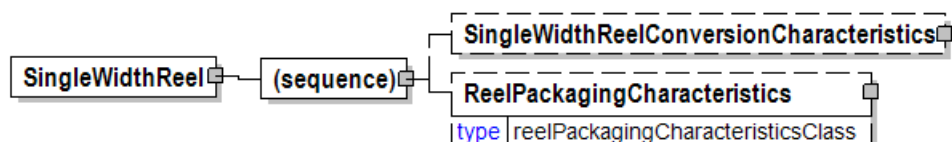

of items below is mandatory. A single instance is required.

SingleWidthReelConversionCharacteristics

SingleWidthReelConversionCharacteristics is optional. A single instance might exist.

The conversion characteristics associated with a single width reel.

ReelPackagingCharacteristics

ReelPackagingCharacteristics is optional. A single instance might exist.

A group item that lists the packaging elements describing how a reel should be packed.

SingleWidthReelConversionCharacteristics

The conversion characteristics associated with a single width reel.

(sequence)

The sequence of items below is mandatory. A single instance is required.

WindingDirection

WindingDirection is optional. A single instance might exist.

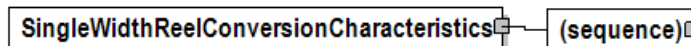

An element that indicates how the material is wound on the reel.

Refer to WindingDirection definition for any enumerations.

TrimmedOrderType

TrimmedOrderType is optional. A single instance might exist.

Trimmed Order Type

Refer to TrimmedOrderType definition for any enumerations.

ReelWidth

ReelWidth is optional. A single instance might exist.

The width of reel from edge to edge excluding packaging.

ReelDiameter

ReelDiameter is optional. A single instance might exist.

The diameter measurement of reel excluding packaging.

ReelLength

ReelLength is optional. A single instance might exist.

The total length of the paper on the reel.

CoreCharacteristics

CoreCharacteristics is optional. A single instance might exist.

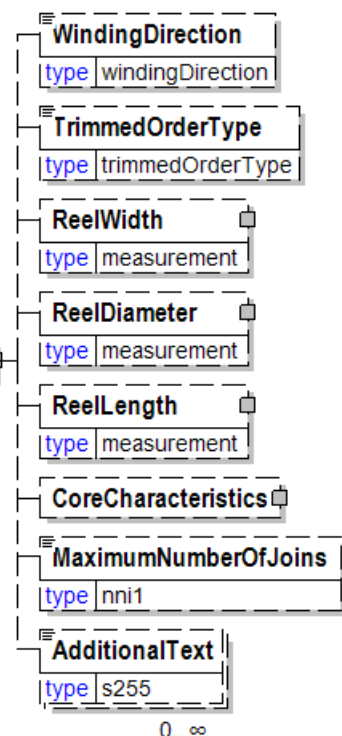

0..∞

A group item that details information used to fully define a core.

MaximumNumberOfJoins

MaximumNumberOfJoins is optional. A single instance might exist.

The maximum number of joins requested (permitted). Permits customers to indicate join-free reels.

AdditionalText

AdditionalText is optional. Multiple instances might exist.

A text field that is used to communicate information not previously defined or for special instructions. To be used only for circumstances not covered by specific elements.

SizeOfHolePunch

A definition of the size and shape of the punched holes.

ShapeOfHole [attribute]

ShapeOfHole is optional. A single instance might exist.

The shape of the hole

Refer to ShapeOfHole definition for any enumerations.

(sequence)

The sequence of items below is mandatory. A single instance is required.

Value

Value is mandatory. A single instance is required.

A numeric value expressed in the unit of measure (UOM).

RangeMin

RangeMin is optional. A single instance might exist.

The minimum value (lower boundary) allowed for the Measurement that is the parent of this element.

RangeMax

RangeMax is optional. A single instance might exist.

The maximum value (upper boundary) allowed for the Measurement that is the parent of this element. Some elements use the RangeMax element with an extended list of unit of measures. (Note: the red colour in the picture is an artifact of how the graphic was captured and should be disregarded.)

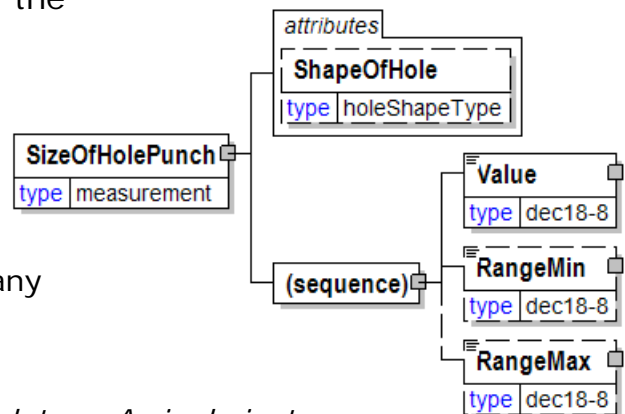

Sizing

A group item used to communicate size test of paper by ink resistance target or test value.

TestMethod [attribute]

TestMethod is optional. A single instance might exist.

The method used to determine the results of the test under consideration.

TestAgency [attribute]

TestAgency is optional. A single instance might exist.

The agency that has set the parameters for the testing

Refer to TestAgency definition for any enumerations.

SampleType [attribute]

SampleType is optional. A single instance might exist.

Communicates how sampling was done to measure the product characteristics.

Refer to SampleType definition for any enumerations.

ResultSource [attribute]

ResultSource is optional. A single instance might exist.

Used to define the data source of the specified test

Refer to ResultSource definition for any enumerations.

(sequence)

The sequence of items below is mandatory. A single instance is required.

DetailValue

DetailValue is mandatory. A single instance is required.

A numeric value expressed in the unit of measure (UOM).

DetailRangeMin

DetailRangeMin is optional. A single instance might exist.

The minimum value (lower boundary) allowed for the DetailValue that is the parent of this element.

DetailRangeMax

DetailRangeMax is optional. A single instance might exist.

The maximum value (upper boundary) allowed for the DetailValue that is the parent of this element.

StandardDeviation

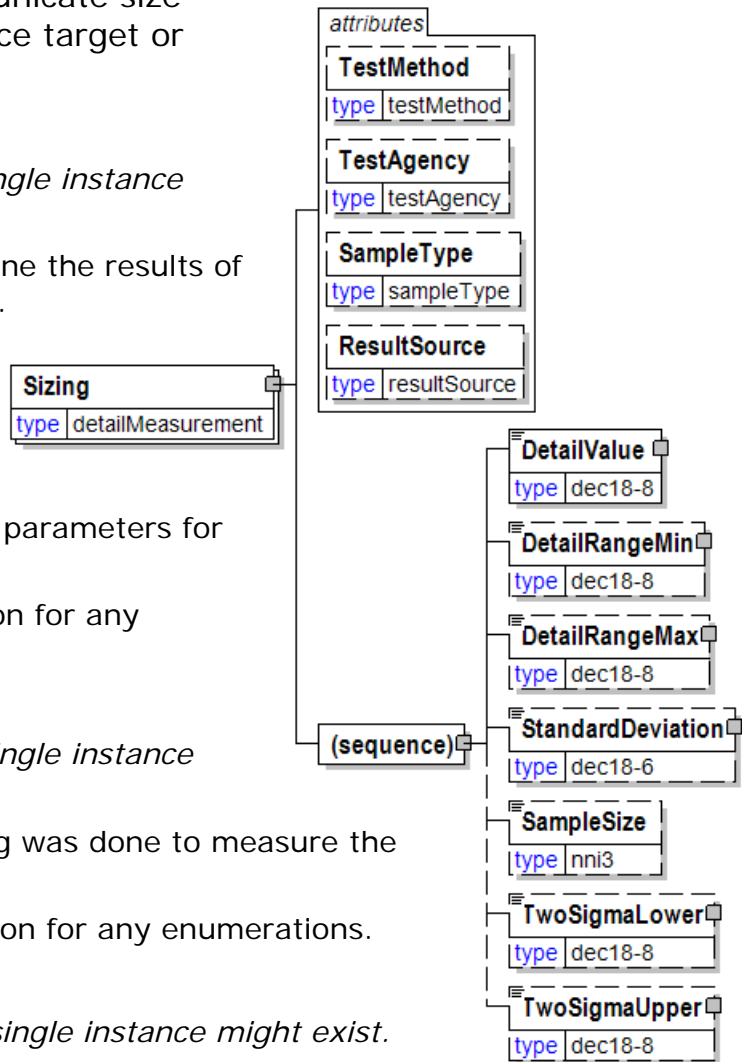

StandardDeviation is optional. A single instance might exist.

A statistic used as a measure of dispersion in a distribution.

SampleSize

SampleSize is optional. A single instance might exist.

The number of samples used to determine the product characteristic in question.

TwoSigmaLower

TwoSigmaLower is optional. A single instance might exist.

Two sigma (a measure of dispersion associated with standard deviation) on the lower side of the standard deviation.

TwoSigmaUpper

TwoSigmaUpper is optional. A single instance might exist.

Two sigma (a measure of dispersion associated with standard deviation) on the upper side of the standard deviation.

Sleeve

Sleeve.

SpineLabel [attribute]

SpineLabel is mandatory. A single instance is required.

The sleeve spine label.

(sequence)

The sequence of items below is mandatory. A single instance is required.

SleeveInsertType

SleeveInsertType is optional. A single instance might exist.

Sleeve insert type, examples are:

Sleeve insert type, examples are: bind-in sleeves that are actually bound-in with the pages of the booksleeves that adhere to the inside of the cover or a pagesleeves that are packaged/shrinkwrapped on the outside of the book. This enumeration is currently a free-form string of characters.

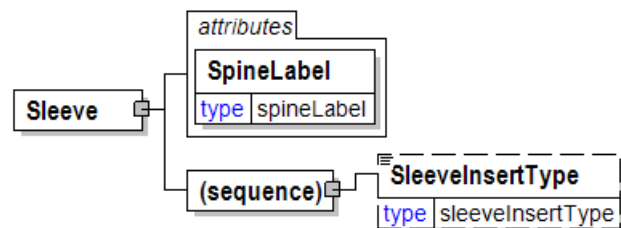

SleeveInsertType

Sleeve insert type, examples are:

Sleeve insert type, examples are: bind-in sleeves that are actually bound-in with the pages of the booksleeves that adhere to the inside of the cover or a pagesleeves that are packaged/shrinkwrapped on the outside of the book. This enumeration is currently a free-form string of characters.

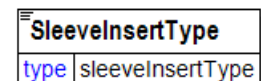

Slide

Slide

SlideMountNumbering [attribute]

SlideMountNumbering is optional. A single instance might exist.

Is the slide mount numbered.

Refer to SlideMountNumbering definition for any enumerations.

SlideMountCaptions [attribute]

SlideMountCaptions is optional. A single instance might exist.

Is the slide mount captioned?

Refer to SlideMountCaptions definition for any enumerations.

(sequence)

The sequence of items below is mandatory. A single instance is required.

SequenceNumber

SequenceNumber is optional. A single instance might exist.

Width

Width is optional. A single instance might exist.

The width of the object.

Length

Length is optional. A single instance might exist.

The length of the object.

NumberOfColours

NumberOfColours is optional. A single instance might exist.

The number of colours

ColourSpecs

ColourSpecs is optional. A single instance might exist.

Colour specs

SlideMountDescription

SlideMountDescription is optional. A single instance might exist.

Slide mount description

SlideMountMaterial

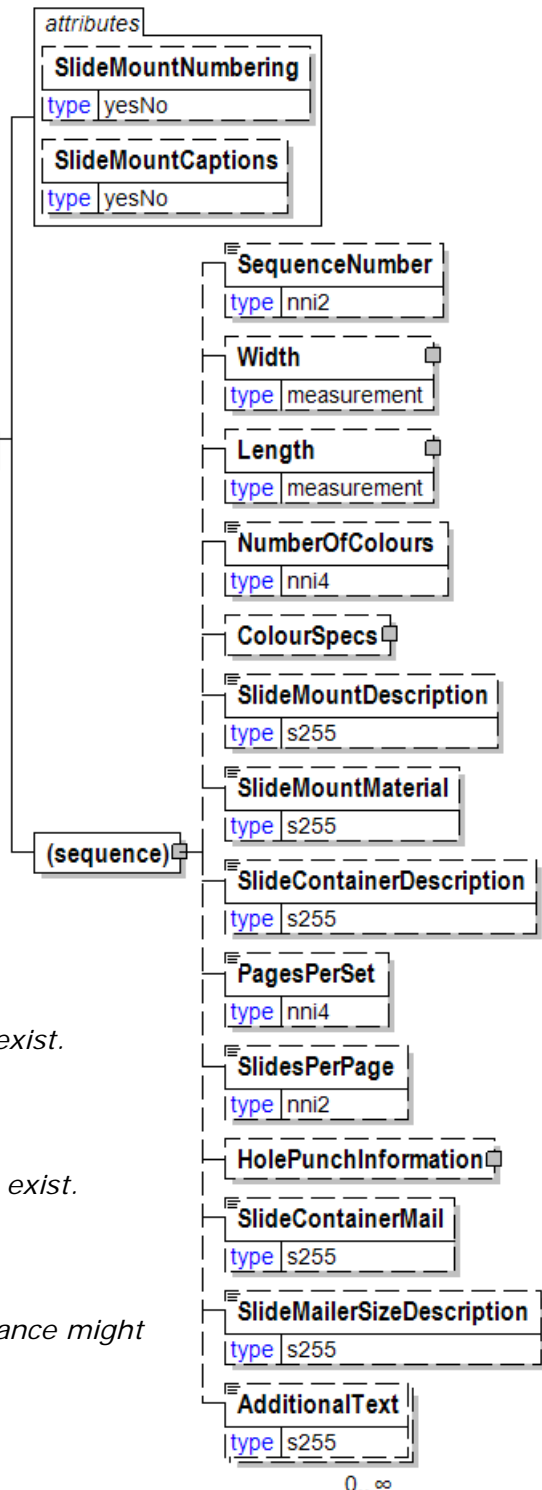

papiNet V2R31

SlideMountMaterial is optional. A single instance might exist.

Slide mount material

SlideContainerDescription

SlideContainerDescription is optional. A single instance might exist.

Slide container description

PagesPerSet

PagesPerSet is optional. A single instance might exist.

Pages per Set

SlidesPerPage

SlidesPerPage is optional. A single instance might exist.

Slides per page

HolePunchInformation

HolePunchInformation is optional. A single instance might exist.

Hole Punch Information.

SlideContainerMail

SlideContainerMail is optional. A single instance might exist.

Slide container for mail.

SlideMailerSizeDescription

SlideMailerSizeDescription is optional. A single instance might exist.

Slide mailer size description

AdditionalText

AdditionalText is optional. Multiple instances might exist.

A text field that is used to communicate information not previously defined or for special instructions. To be used only for circumstances not covered by specific elements.

SlideContainerDescription

Slide container description

SlideContainerDescription	
type	s255

SlideContainerMail

Slide container for mail.

SlideContainerMail	
type	s255

SlideMailerSizeDescription

Slide mailer size description

SlideMailerSizeDescription	
type	s255

SlideMountCaptions [attribute]

Is the slide mount captioned?

This item is restricted to the following list.

Yes

No

attribute
SlideMountCaptions
type yesNo

SlideMountDescription

Slide mount description

SlideMountDescription
type s255

SlideMountMaterial

Slide mount material

SlideMountMaterial
type s255

SlideMountNumbering [attribute]

Is the slide mount numbered.

This item is restricted to the following list.

Yes

No

attribute
SlideMountNumbering
type yesNo

SlidesPerPage

Slides per page

SlidesPerPage
type nni2

SlitReel

The SlitReel element represents the elements associated with reel that has been slit into multiple reels.

(sequence)

The sequence of items below is mandatory. A single instance is required.

DeliveryIndicator

DeliveryIndicator is optional. A single instance might exist.

Indicates if delivery should take place or not.

Refer to DeliveryIndicator definition for any enumerations.

SlitReelLineNumber

SlitReelLineNumber is mandatory. A single instance is required.

The slit reel line number

SlitReelWidth

SlitReelWidth is mandatory. A single instance is required.

Slit Reel Width

(choice)

[choice] is optional because of choice construct.

SlitReelOrderQuantity

SlitReelOrderQuantity is optional because of choice construct.

Slit reel order quantity

SlitReelsInSet

SlitReelsInSet is optional because of choice construct.

The number of slit reels in the set.

SlitReelReference

SlitReelReference is optional. Multiple instances might exist.

Communicates miscellaneous information about the slit reel.

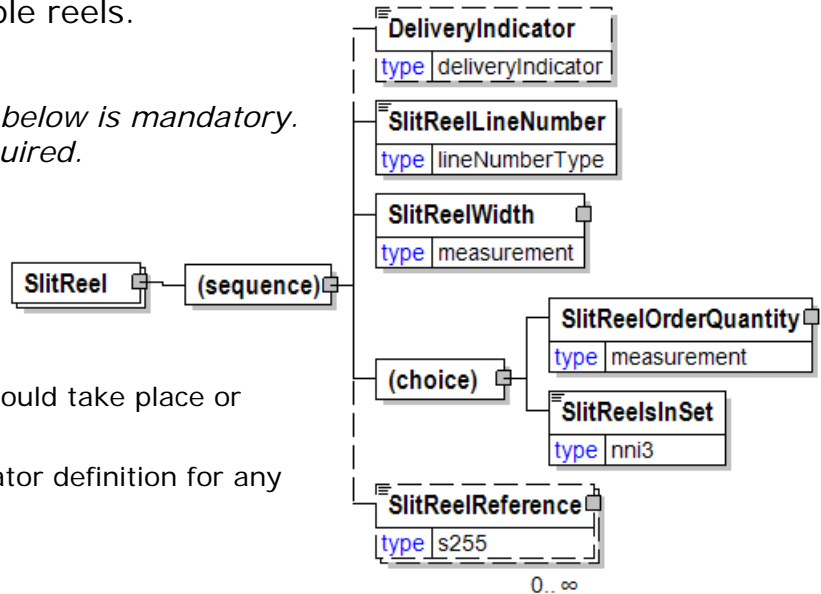

SlitReelLineNumber

The slit reel line number

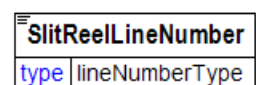

SlitReelOrderQuantity

Slit reel order quantity

QuantityType [attribute]

QuantityType is mandatory. A single instance is required.

QuantityType communicates information about the type of quantity being communicated and how the receiver might use the information.

Refer to QuantityType definition for any enumerations.

QuantityTypeContext [attribute]

QuantityTypeContext is optional. A single instance might exist.

Provides the location in the value chain where the quantity is being reported.

Refer to QuantityTypeContext definition for any enumerations.

AdjustmentType [attribute]

AdjustmentType is optional. A single instance might exist.

Describes the type of adjustment associated with a quantity.

Refer to AdjustmentType definition for any enumerations.

(sequence)

The sequence of items below is mandatory. A single instance is required.

Value

Value is mandatory. A single instance is required.

A numeric value expressed in the unit of measure (UOM).

RangeMin

RangeMin is optional. A single instance might exist.

The minimum value (lower boundary) allowed for the Measurement that is the parent of this element.

RangeMax

RangeMax is optional. A single instance might exist.

The maximum value (upper boundary) allowed for the Measurement that is the parent of this element. Some elements use the RangeMax element with an extended list of unit of measures. (Note: the red colour in the picture is an artifact of how the graphic was captured and should be disregarded.)

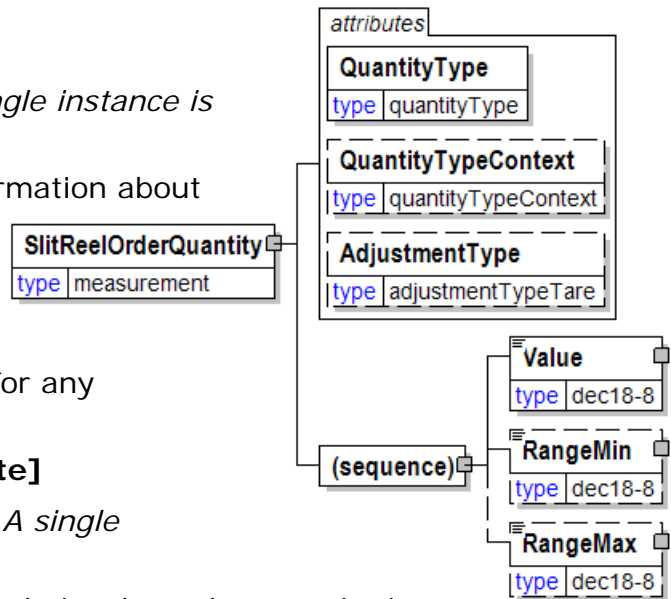

SlitReelReference

Communicates miscellaneous information about the slit reel.

SlitReelReferenceType [attribute]

SlitReelReferenceType is mandatory. A single instance is required.

Provides a contextual explanation of the specific reference identifier. Many items are currently prefixed by "Buyer", "Forwarder", "Manufacturer", "Mill", "Seller", "Supplier", "Warehouse", or "Vendor". Check for an existing non-prefixed version and use the non-prefixed version instead. In the (yet to be announced release date) version 3.0 the prefixed versions will be removed. Instead the attribute @AssignedBy will communicate the information previously communicated in the prefix.

Refer to SlitReelReferenceType definition for any enumerations.

AssignedBy [attribute]

AssignedBy is optional. A single instance might exist.

Identifies the type of party that has assigned the associated item, e.g. a reference of type OrderNumber.

Refer to AssignedBy for any enumerations.

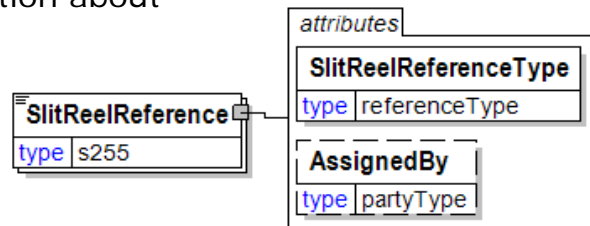

SlitReelReferenceType [attribute]

Provides a contextual explanation of the specific reference identifier. Many items are currently prefixed by "Buyer", "Forwarder", "Manufacturer", "Mill", "Seller", "Supplier", "Warehouse", or "Vendor". Check for an existing non-prefixed version and use the non-prefixed version instead. In the (yet to be announced release date) version 3.0 the prefixed versions will be removed. Instead the attribute @AssignedBy will communicate the information previously communicated in the prefix.

Refer to the [referenceType](#) entry for the list of enumerations and their definitions.

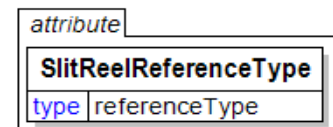

SlitReelsInSet

The number of slit reels in the set.

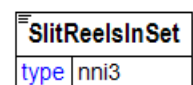

SlitReelWidth

Slit Reel Width

(sequence)

The sequence of items below is mandatory. A single instance is required.

Value

Value is mandatory. A single instance is required.

A numeric value expressed in the unit of measure (UOM).

RangeMin

RangeMin is optional. A single instance might exist.

The minimum value (lower boundary) allowed for the Measurement that is the parent of this element.

RangeMax

RangeMax is optional. A single instance might exist.

The maximum value (upper boundary) allowed for the Measurement that is the parent of this element. Some elements use the RangeMax element with an extended list of unit of measures. (Note: the red colour in the picture is an artifact of how the graphic was captured and should be disregarded.)

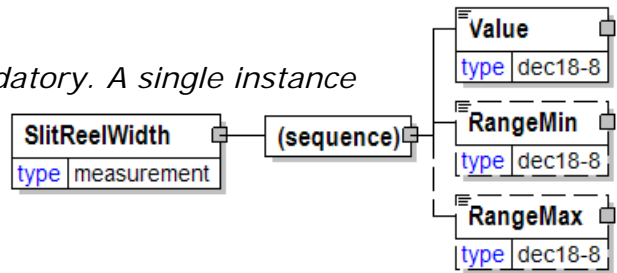

Slurry

Product that has moisture content high enough to prevent formation of a sheet, and which can be delivered in liquid form.

Examples:

Product that has moisture

content high enough to prevent formation of a sheet, and which can be delivered in liquid form.

Examples: Noodle pulp, is pumped into trucks as thick slurry, and then pumped directly into the hydropulper. It has the higher strength properties of never dried pulp.

Product that has moisture content high enough to prevent formation of a sheet, and which can be delivered in liquid form. Examples: Noodle pulp, is pumped into trucks as thick slurry, and then pumped directly into the hydropulper. It has the higher strength properties of never dried pulp. Liquid pulp, never dried pulp, often pumped directly, using a flow meter to measure the moisture and fibre content. Sold by weight of the fibre.

(sequence)

The sequence of items below is mandatory. A single instance is required.

TargetSolidsContent

TargetSolidsContent is mandatory. A single instance is required.

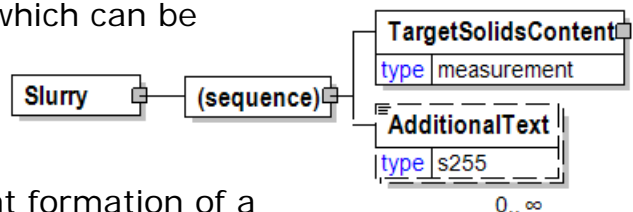

The target amount of solids for the slurry being produced.

AdditionalText

AdditionalText is optional. Multiple instances might exist.

A text field that is used to communicate information not previously defined or for special instructions. To be used only for circumstances not covered by specific elements.

SmallEndDiameter

Reports the log crown end diameter as a measurement.

(sequence)

The sequence of items below is mandatory. A single instance is required.

Value

Value is mandatory. A single instance is required.

A numeric value expressed in the unit of measure (UOM).

RangeMin

RangeMin is optional. A single instance might exist.

The minimum value (lower boundary) allowed for the Measurement that is the parent of this element.

RangeMax

RangeMax is optional. A single instance might exist.

The maximum value (upper boundary) allowed for the Measurement that is the parent of this element. Some elements use the RangeMax element with an extended list of unit of measures. (Note: the red colour in the picture is an artifact of how the graphic was captured and should be disregarded.)

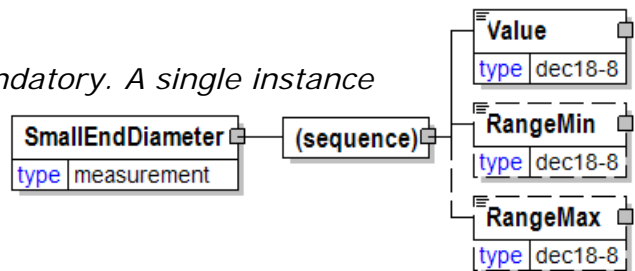

Smoothness

A group item used to communicate surface smoothness target or test value according to a particular TestMethod.

TestMethod [attribute]

TestMethod is optional. A single instance might exist.

The method used to determine the results of the test under consideration.

TestAgency [attribute]

TestAgency is optional. A single instance might exist.

The agency that has set the parameters for the testing

Refer to TestAgency definition for any enumerations.

SampleType [attribute]

SampleType is optional. A single instance might exist.

Communicates how sampling was done to measure the product characteristics.

Refer to SampleType definition for any enumerations.

ResultSource [attribute]

ResultSource is optional. A single instance might exist.

Used to define the data source of the specified test

Refer to ResultSource definition for any enumerations.

(sequence)

The sequence of items below is mandatory. A single instance is required.

DetailValue

DetailValue is mandatory. A single instance is required.

A numeric value expressed in the unit of measure (UOM).

DetailRangeMin

DetailRangeMin is optional. A single instance might exist.

The minimum value (lower boundary) allowed for the DetailValue that is the parent of this element.

DetailRangeMax

DetailRangeMax is optional. A single instance might exist.

The maximum value (upper boundary) allowed for the DetailValue that is the parent of this element.

StandardDeviation

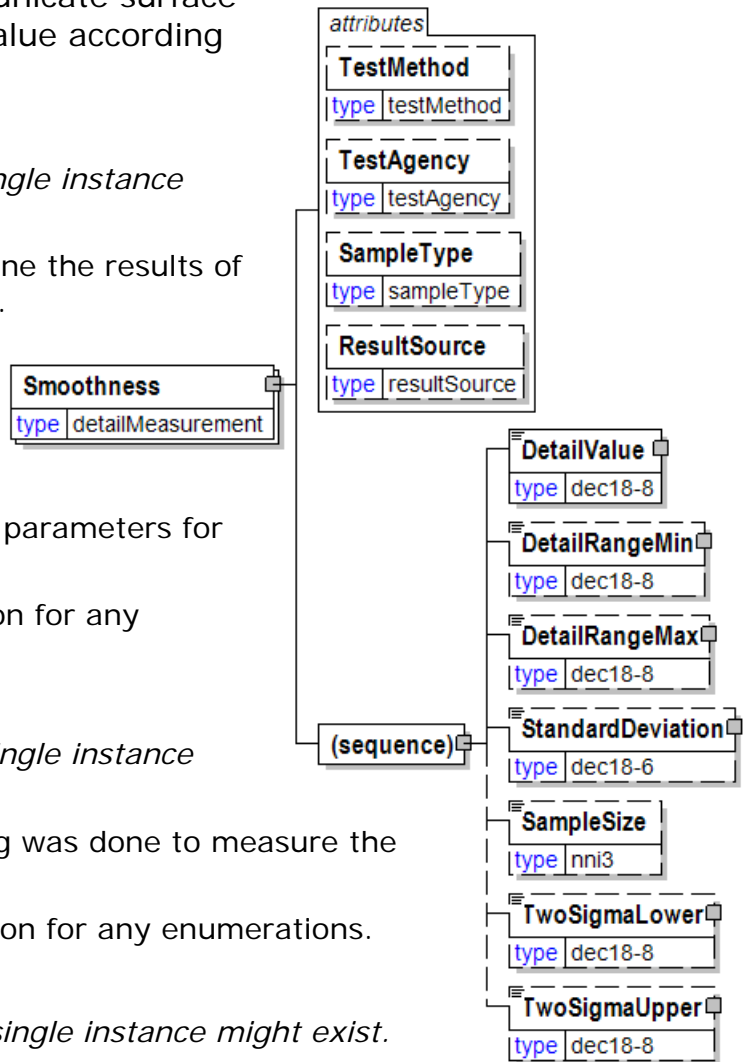

papiNet V2R31

StandardDeviation is optional. A single instance might exist.

A statistic used as a measure of dispersion in a distribution.

SampleSize

SampleSize is optional. A single instance might exist.

The number of samples used to determine the product characteristic in question.

TwoSigmaLower

TwoSigmaLower is optional. A single instance might exist.

Two sigma (a measure of dispersion associated with standard deviation) on the lower side of the standard deviation.

TwoSigmaUpper

TwoSigmaUpper is optional. A single instance might exist.

Two sigma (a measure of dispersion associated with standard deviation) on the upper side of the standard deviation.

SoftwoodLumber

Product structure for solid wood products made of softwood

(sequence)

The sequence of items below is mandatory. A single instance is required.

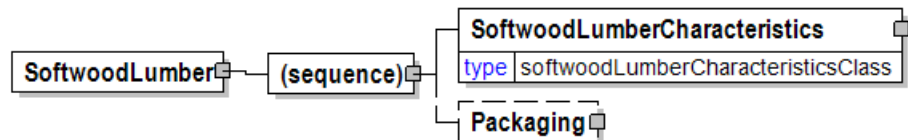

SoftwoodLumberCharacteristics

SoftwoodLumberCharacteristics is mandatory. A single instance is required.

A group item that organises the softwood lumber –product information.

Packaging

Packaging is optional. A single instance might exist.

Type of a package that includes individual products.

SoftwoodLumberCharacteristics

A group item that organises the softwood lumber – product information.

(sequence)

The sequence of items below is mandatory. A single instance is required.

LumberSpecies

LumberSpecies is mandatory. One instance is required, multiple instances might exist.

Specifies the raw material species.

LumberGrade

LumberGrade is mandatory. A single instance is required.

Defines quality characteristics achieved by selecting pieces based on a grading rule.

Length

Length is optional.

The length of the object.

Width

Width is optional.

The width of the object.

Thickness

Thickness is optional.

Physical dimension of a product. The approach for thickness used in the timber/lumber related constructs.

Seasoning

Seasoning is optional. A single instance might exist.

Describes drying/ moisture control method.

MoistureContent

MoistureContent is optional. A single instance might exist.

Defines the moisture content percentage of the product.

HeatTreatment

HeatTreatment is optional. A single instance might exist.

Defines the heat treatment method.

ManufacturingProcess

ManufacturingProcess is optional. Multiple instances might exist.

Defines the different machining and processes made for the product.

PatternProfile

PatternProfile is optional. A single instance might exist.

Defines the pattern used in machining the product.

Trim



Trim is optional. A single instance might exist.

Trim

Joining

Joining is optional. A single instance might exist.

Defines the method used to join pieces of wood.

PressureTreatment

PressureTreatment is optional. A single instance might exist.

Method and parameter values of pressure treatment.

FireTreatment

FireTreatment is optional. A single instance might exist.

Fire treatment

OtherTreatment

OtherTreatment is optional. A single instance might exist.

Other treatment

GradeStamp

GradeStamp is optional. A single instance might exist.

Grade stamp information

ExLog

ExLog is optional. A single instance might exist.

Describes the cutting pattern of the log.

ClassIdentifier

ClassIdentifier is optional. Multiple instances might exist.

Standard used for product identification.

Weight

Weight is optional. A single instance might exist.

The weight of the item.

LabelCharacteristics

LabelCharacteristics is optional. A single instance might exist.

A group item that organises the labeling information.

StencilCharacteristics

StencilCharacteristics is optional. A single instance might exist.

A group element specifying attributes of a stencil to be applied to an item, and optional text.

Wrap

Wrap is optional. A single instance might exist.

A group item that organises wrapping detail information.

SafetyAndEnvironmentalInformation

SafetyAndEnvironmentalInformation is optional. Multiple instances might exist.

Name of certification type, if any, on the goods (For example, FSC, PEFC).
SafetyAndEnvironmental needs a value or measurement to communicate the

percentage of the product is certified (for example, 75% is certified by the indicated agency).

AdditionalText

AdditionalText is optional. Multiple instances might exist.

A text field that is used to communicate information not previously defined or for special instructions. To be used only for circumstances not covered by specific elements.

LengthCutDescription

LengthCutDescription is optional. A single instance might exist.

Length Cut Description

ShippingMark

ShippingMark is optional. A single instance might exist.

A shipping mark identifies the producer and quality on the end side of the product. Not to be mixed with company code/logo or other product marking.

SoftwoodPlywood

Characteristics of wood panelling products.

(sequence)

The sequence of items below is mandatory. A single instance is required.

PlywoodOSBGrade

PlywoodOSBGrade is mandatory. A single instance is required.

Defines the grade of plywood, OSB product

Thickness

Thickness is mandatory.

Physical dimension of a product.

Width

Width is mandatory.

The width of the object.

Length

Length is mandatory.

The length of the object.

PlywoodOSBSpecies

PlywoodOSBSpecies is optional. Multiple instances might exist.

Defines the raw material species of plywood, OSB product.

Refer to PlywoodOSBSpecies definition for any enumerations.

PlyNumber

PlyNumber is optional. A single instance might exist.

Product attributes can be detailed for each ply. If product attributes are defined for the plies this element defines the ply that these product attributes apply to.

Surface

Surface is optional. A single instance might exist.

Overlay

Overlay is optional.

Overlay

GlueExposure

GlueExposure is optional. A single instance might exist.

Refer to GlueExposure definition for any enumerations.

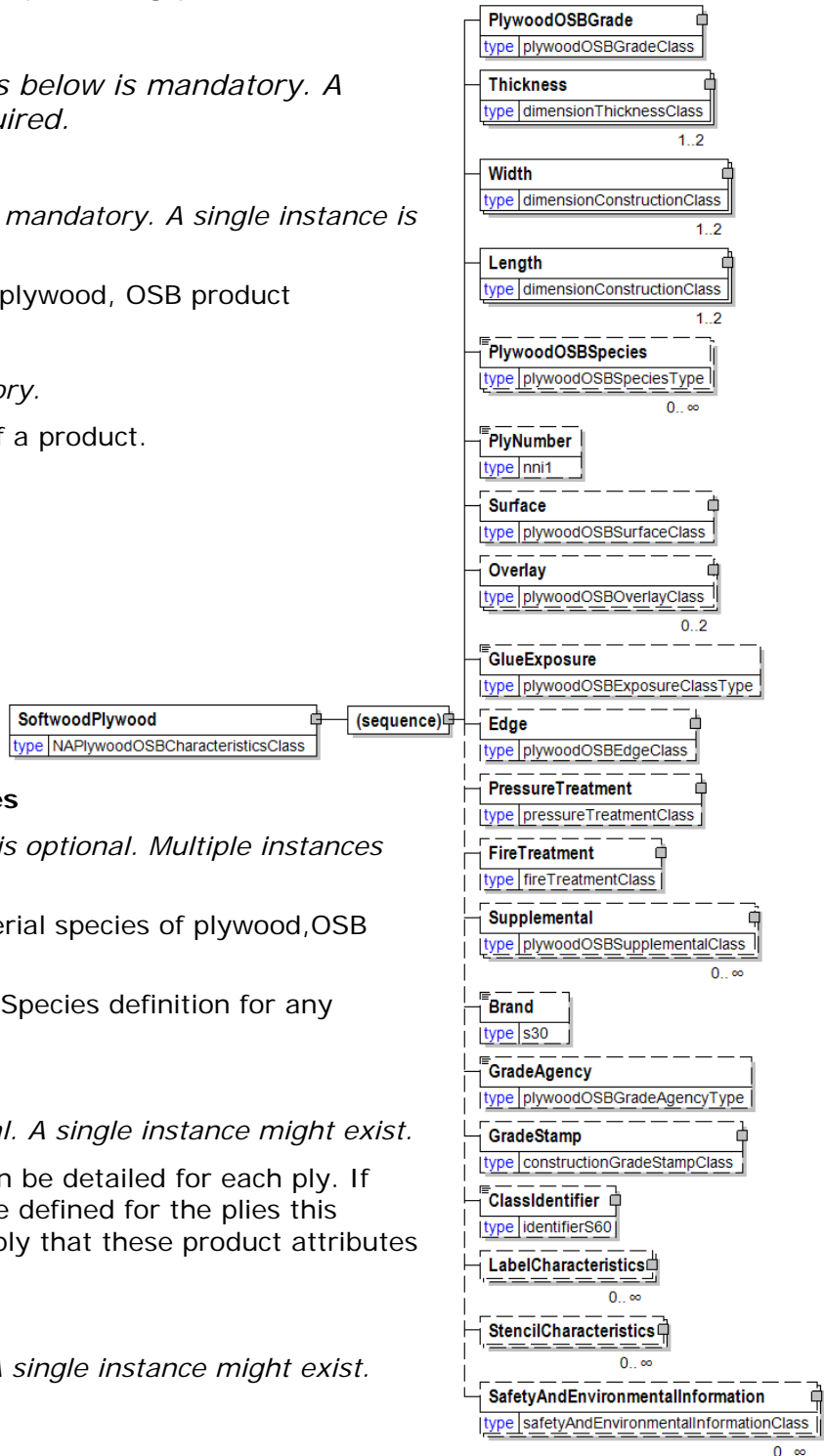

Edge

Edge is optional. A single instance might exist.

Describes the finishing of the edge of the board.

PressureTreatment

PressureTreatment is optional. A single instance might exist.

Method and parameter values of pressure treatment.

FireTreatment

FireTreatment is optional. A single instance might exist.

Fire treatment

Supplemental

Supplemental is optional. Multiple instances might exist.

Supplemental

Brand

Brand is optional. A single instance might exist.

Specifies a brand or trade name of wrapping material to be used when wrapping the product.

GradeAgency

GradeAgency is optional. A single instance might exist.

North American structural panel grading agencies. Defines the governing organisation of the grading scheme employed.

Note: There is a GradeAgency attribute, as well.

Refer to GradeAgency definition for any enumerations.

GradeStamp

GradeStamp is optional. A single instance might exist.

Grade stamp information

ClassIdentifier

ClassIdentifier is optional. A single instance might exist.

Standard used for product identification.

LabelCharacteristics

LabelCharacteristics is optional. Multiple instances might exist.

A group item that organises the labeling information.

StencilCharacteristics

StencilCharacteristics is optional. Multiple instances might exist.

A group element specifying attributes of a stencil to be applied to an item, and optional text.

SafetyAndEnvironmentalInformation

SafetyAndEnvironmentalInformation is optional. Multiple instances might exist.

Name of certification type, if any, on the goods (For example, FSC, PEFC). SafetyAndEnvironmental needs a value or measurement to communicate the percentage of the product is certified (for example, 75% is certified by the indicated agency).

SpanRating

Span Rating according to NIST standards and indicated on grade stamp.

This item is restricted to the following list.

- 16oc**
- 20oc**
- 24oc**
- 32oc**
- 48oc**
- 20/0**
- 24/0**
- 24/16**
- 32/16**
- 40/20**
- 48/24**
- 54/32**
- 60/32**
- 60/48**

SpanRating	
type	plywoodOSBSpanRatingType

SpecAssembly

SpecAssembly contains assemblies that are used in the manufacturing of books.

SpecAssemblyType [attribute]

SpecAssemblyType is optional. A single instance might exist.

Indicator that identifies the part of the book product for which the assembly information is being specified.

Refer to SpecAssemblyType definition for any enumerations

(sequence)

The sequence of items below is mandatory. A single instance is required.

ProductIdentifier

ProductIdentifier is mandatory. A single instance is required.

Used to communicate the code of the article, in a variety of formats designated by the type.

ProductDescription

ProductDescription is optional. Multiple instances might exist.

An element used to communicate a human readable description of the product in the language specified by the Language attribute.

BillOfMaterials

BillOfMaterials is optional. A single instance might exist.

A specification of the components and other items that are used to produced the item in question.

Height

Height is optional. A single instance might exist.

The height of the object.

Length

Length is optional. A single instance might exist.

The length of the object.

Width

Width is optional. A single instance might exist.

The width of the object.

AssemblyInstructions

AssemblyInstructions is optional. Multiple instances might exist.

Instructions for assembly.

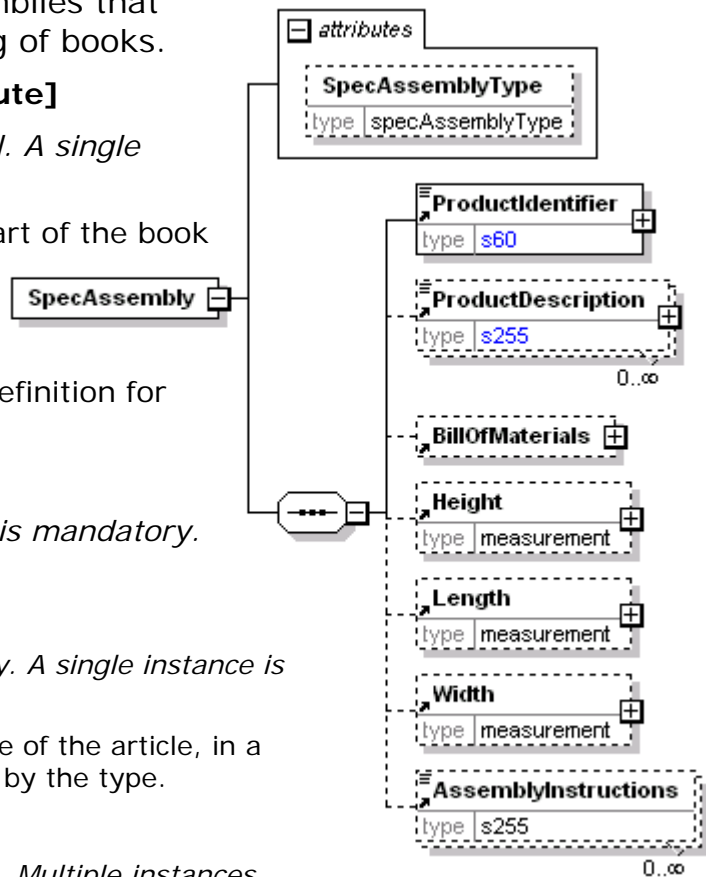

SpecAssemblyType [attribute]

Indicator that identifies the part of the book product for which the assembly information is being specified.

This item is restricted to the following list.

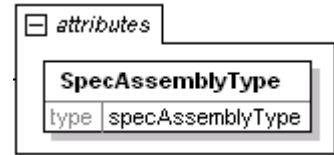

Component

Part or section of the book product.

FinishedGoods

Goods that have completed the manufacturing process but have not yet been sold or distributed to the end user.

SpecBinding

SpecBinding describes the binding process.

BindingType [attribute]

BindingType is optional. A single instance might exist.

Identifies the primary binding category of the book.

Refer to BindingType definition for any enumerations.

BindingStyleType [attribute]

BindingStyleType is optional. A single instance might exist.

Indicates the style of binding used.

Refer to BindingStyleType definition for any enumerations.

BindingCoverScoring [attribute]

BindingCoverScoring is optional. A single instance might exist.

Indicates if scoring of the front cover close to the spine allowing the cover to easily stay open is required.

Refer to BindingCoverScoring definition for any enumerations.

BindingReinforcement [attribute]

BindingReinforcement is optional. A single instance might exist.

Specifies if spine reinforcement materials are included in the binding operation.

Refer to BindingReinforcement definition for any enumerations.

BindingBackStyleType [attribute]

BindingBackStyleType is optional. A single instance might exist.

Specifies that the book cover is either attached or detached from the spine.

Refer to BindingBackStyleType definition for any enumerations.

BindingRibbon [attribute]

BindingRibbon is optional. A single instance might exist.

Specifies if a ribbon (bookmark) is to be included in

SpecBinding

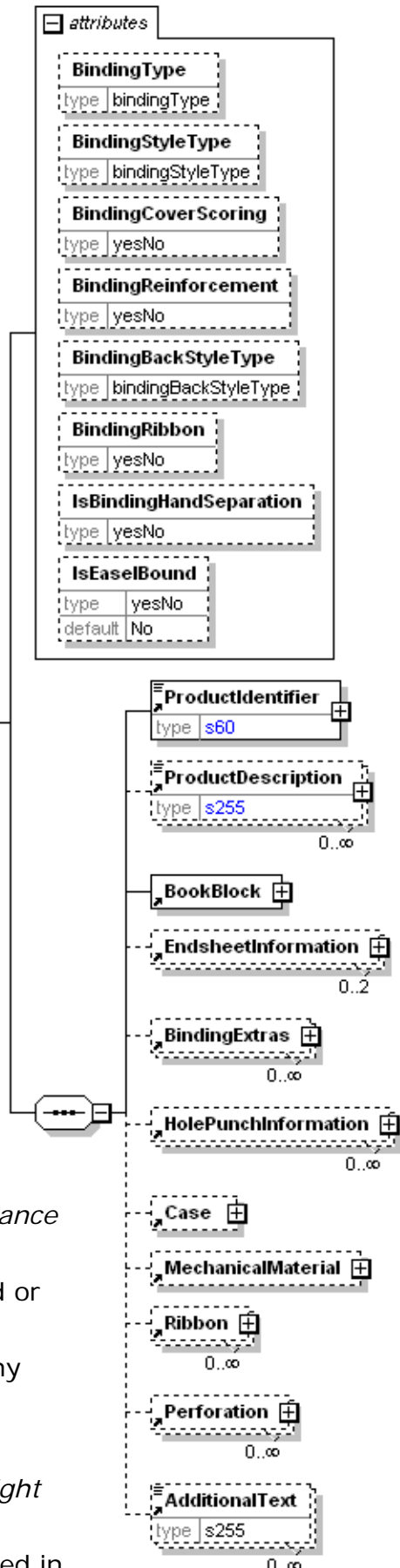

the binding.

Refer to BindingRibbon definition for any enumerations.

IsBindingHandSeparation [attribute]

IsBindingHandSeparation is optional. A single instance might exist.

Indicates if there is hand separation required or not for books with odd page counts.

Refer to IsBindingHandSeparation definition for any enumerations.

IsEaselBound [attribute]

IsEaselBound is optional. A single instance might exist.

Specifies if the binding is at the top of the pages or not rather than on the side which changes the pagination of the pages.

Refer to IsEaselBound definition for any enumerations.

(sequence)

The sequence of items below is mandatory. A single instance is required.

ProductIdentifier

ProductIdentifier is mandatory. A single instance is required.

Used to communicate the code of the article, in a variety of formats designated by the type.

ProductDescription

ProductDescription is optional. Multiple instances might exist.

An element used to communicate a human readable description of the product in the language specified by the Language attribute.

BookBlock

BookBlock is mandatory. A single instance is required.

The text block plus the endpapers and other materials added by the binder before cover is applied.

EndsheetInformation

EndsheetInformation is optional.

End sheet information.

BindingExtras

BindingExtras is optional. Multiple instances might exist.

Binding extras

HolePunchInformation

HolePunchInformation is optional and repeatable. Multiple instances might exist.

Hole Punch Information.

Case

Case is optional. A single instance might exist.

Case information

MechanicalMaterial

MechanicalMaterial is optional. A single instance might exist.

Mechanical material information

Ribbon

Ribbon is optional. Multiple instances might exist.

Ribbon information.

Perforation

Perforation is optional and repeatable. Multiple instances might exist.

Perforation information.

AdditionalText

AdditionalText is optional. Multiple instances might exist.

A text field that is used to communicate information not previously defined or for special instructions. To be used only for circumstances not covered by specific elements.

SpecComponent

Group element used to identify all the necessary component information for this BookSpecification.

Each occurrence of this construct identifies a single component.

(sequence)

The sequence of items below is mandatory. A single instance is required.

ProductIdentifier

ProductIdentifier is mandatory. A single instance is required.

Used to communicate the code of the article, in a variety of formats designated by the type.

ProductDescription



ProductDescription is optional. Multiple instances might exist.

An element used to communicate a human readable description of the product in the language specified by the Language attribute.

(sequence)

The sequence of items below is mandatory. One instance is required, multiple instances might exist.

Classification

Classification is mandatory. A single instance is required.

A group item that details the product classification according to a particular organization's scheme. An item across multiple classifications would still be recognized as the same item. Examples of some product classifications are: Containerboard, Pulp-Dissolving, or Newsprint.

SubClassification

SubClassification is optional. Multiple instances might exist.

SubClassification provides additional classification information.

BookClassification

BookClassification is optional. Multiple instances might exist.

Category under which the product or a component within the product is classified.

NumberPerProduct

NumberPerProduct is optional. A single instance might exist.

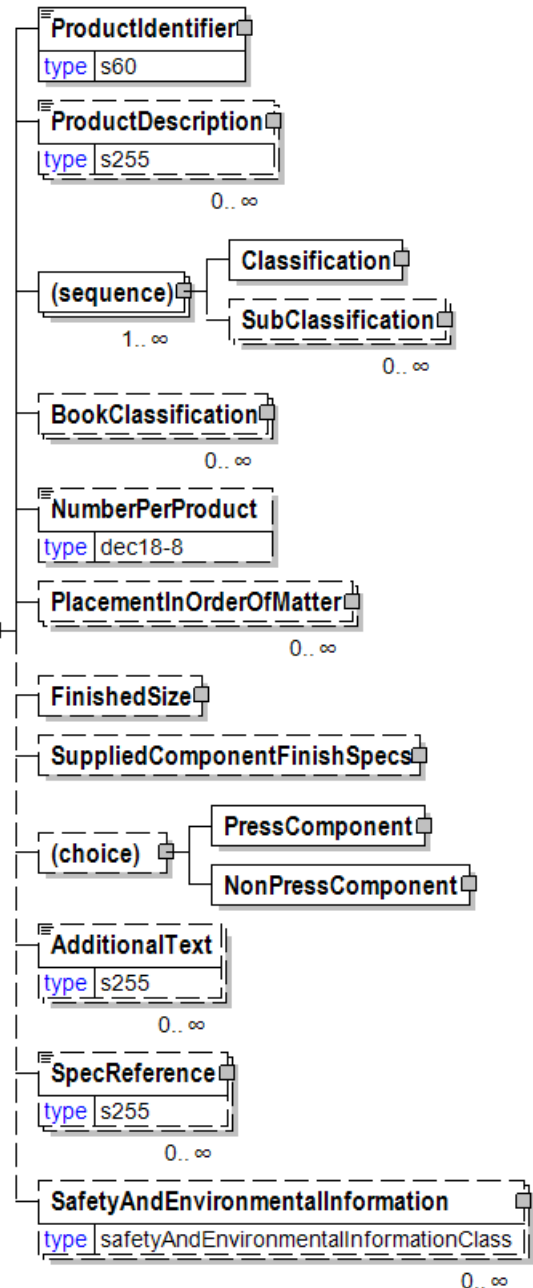

The number of components or items per assembly or constructed product

PlacementInOrderOfMatter

PlacementInOrderOfMatter is optional. Multiple instances might exist.

Element used to identify where the component is to be placed amongst other components when assembling a book.

FinishedSize

FinishedSize is optional. A single instance might exist.

Finished size

SuppliedComponentFinishSpecs

SuppliedComponentFinishSpecs is optional. A single instance might exist.

Supplied Component Finish Specs

(choice)

[choice] is optional because of choice construct.

PressComponent

PressComponent is optional because of choice construct.

Press Component.

NonPressComponent

NonPressComponent is optional because of choice construct.

Non-press component.

AdditionalText

AdditionalText is optional. Multiple instances might exist.

A text field that is used to communicate information not previously defined or for special instructions. To be used only for circumstances not covered by specific elements.

SpecReference

SpecReference is optional. Multiple instances might exist.

Used to identify any external or associated documents, identifiers, etc.

SafetyAndEnvironmentalInformation

SafetyAndEnvironmentalInformation is optional. Multiple instances might exist.

Name of certification type, if any, on the goods (For example, FSC, PEFC). SafetyAndEnvironmental needs a value or measurement to communicate the percentage of the product is certified (for example, 75% is certified by the indicated agency).

SpecGeneral

Spec General

(sequence)

The sequence of items below is mandatory. A single instance is required.

SpecInformation

SpecInformation is mandatory. A single instance is required.

Construct is used to uniquely identify this BookSpecification.

Note: ProductIdentifier, ProductDescription, and Classification removed in Version V2R30 and replaced with SpecificationNumber to more accurately reflect the business process.

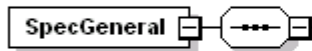

TransactionHistoryNumber

TransactionHistoryNumber is optional. A single instance might exist.

A sequential number that keeps track of the version of a document being sent by the document originator except in the case where TransactionHistoryConfirmation is used, in which case the TransactionHistoryNumber refers to the trigger transaction for which the confirmation is being sent.

SenderParty

SenderParty is mandatory. A single instance is required.

The business entity issuing the e-Document, the source of the document.

The entity responsible for the content. If the sender party has out sourced the message service to a third party the SenderParty is the issuer of the e-Document and not the party performing the transmission service of the electronic message.

ReceiverParty

ReceiverParty is mandatory. A single instance is required.

The business entity for whom the e-Document is intended, the destination of the document.

The entity interested in the content. If the receiver party has outsourced the message service to a third party the ReceiverParty is the intended party for the e-Document and not the party performing the receiving service of the electronic message.

OtherParty

OtherParty is optional. Multiple instances might exist.

An organisation or business entity other than those specifically detailed within a e-Document.

TrimSize

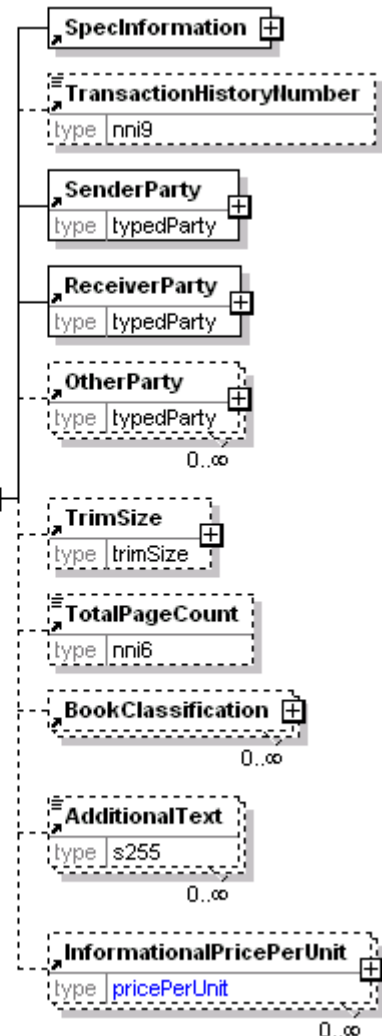

papiNet V2R31

TrimSize is optional. A single instance might exist.

Trim size.

TotalPageCount

TotalPageCount is optional. A single instance might exist.

Element used to communicate the book's approximate total number of pages within each unit of the book. Total page count is more or less a reference to the "size" of the book that the customer designates. For instance, they will refer to a book as 800 pages when in fact it is 792 actual text pages with 8 pages of various inserts. This value should not be used to drive any of the other values for the component parts, but may in fact be exactly equal to the number of pages in one of the components designated as "Text".

BookClassification

BookClassification is optional. Multiple instances might exist.

Category under which the product or a component within the product is classified.

AdditionalText

AdditionalText is optional. Multiple instances might exist.

A text field that is used to communicate information not previously defined or for special instructions. To be used only for circumstances not covered by specific elements.

InformationalPricePerUnit

InformationalPricePerUnit is optional. Multiple instances might exist.

A group item containing a currency value and a measurement value used convey a secondary PricePerUnit. For example, where PricePerUnit is dollars per ton. InformationalPricePerUnit could be dollars per kilogram.

SpecGroupingID

A value that will relate/link specifications together. For example, items that are usually manufactured with common components.

SpecGroupingID
type s60

SpeciesAgency [attribute]

Defines the governing organisation of the scheme employed in determining the species of the product.

This item is restricted to the following list.

ISO

International Organisation for Standardization.

prEN TC(1113-1)

Supplier

Supplier determined scheme.

attribute
SpeciesAgency
type lumberSpeciesAgencyType

SpeciesCode

Species Code

SpeciesCode	
type	s30

SpeciesOrigin [attribute]

The country of origin of the species employed in manufacture of the product.

This item is restricted to the following list.

attribute	
SpeciesOrigin	
type	lumberSpeciesOriginType

Africa
America
Austria
Bavaria
Brasil
Canada
Estonia
European
Finland
French
Germany
Indian
Latvia
Lithuania
Norway
Russia
Sweden
North
South
Eastern
Western
Coast
Inland
Other

SpeciesType [attribute]

Defines the species or mix of species comprising the product.

This item is restricted to the following list.

attribute	
SpeciesType	
type	lumberSpeciesType

- Afrormosia**
- Afzelia**
- Agba**
- AlaskanCedar**
- Alder**
- AlpineFir**
- AmabilisFir**
- Amapa**
- Andoung**
- Anegre**
- Antiaris**
- Ash**
- Aspen**
- AspenPolar**
- AustrianSpruce**
- Avodire**
- Ayan**
- Ayous/Ako**
- BalsamFir**
- BalsamPolar**
- Bamboo**
- Basswood**
- Beech**
- Birch**
- BirdseyeMaple**
- BlackCherry**
- BlackCottonwood**
- BlackGuarea**
- BlackSpruce**
- Bubinga**
- CaliforniaRedFir**
- CaribbeanPine**

Yes, it is Caribbean Pine.

CarolinaPine
Cedar
Ceiba
CembraPine
Cherry
Chestnut
CoastSpecies
Cypress
Danta
DouglasFir
Douka
EasternCottonwood
EasternHemlock
EasternSoftwoods
EasternSpruce
EasternWhiteCedar
EasternWhitePine
Elliotti
EngelmanSpruce
Eucalyptus
EuropeanLarch
Exotic
FigureSycamore
Fir
Frake
Framire
Gaboon
GrandFir
GreyElm
HardMaple
Hemlock
Hornbeam
IdahoWhitePine
Ilomba
Imbira
IncCedar
InlRedCedar

Ipe
Iroko
JackPine
Kaya
Koto
Larch
LarricioPine
Lauan
Limba
Locust
LodgepolePine
Mahogany
Macoré
Mansonia
Maple
MaritimePine
Meranti
Merbeau
MexicanPine
MixedSoftwood
MixedSYP
MixedTropicalHardwood
MntnHemlock
Niangon
NobelFir
NorwaySpruce
NorthernAspen
NorthernPine
NorthernSpecies
Oak
Okume
OliverAsh
Olon
Omu
OregonPine
Ozigo
PacificCoastHemlock

PacificSilverFir

Padauk

PaoAmarello

Pear

Pearwood

Pine

Plane

PlywoodComposite

Indicates that the product is made up of a group of species. It is a composite product (usually plywood).

PonderosaPine

PrtOrfCed

Poucouli

Purpleheart

Radiata

RadiataPine

RedCedar

RedElm

RedOak

RedPine

RedSpruce

RedWhitewood

Redwood

RioRosewood

Rosewood

SandPine

SantosRosewood

Sapelle

Satinwood

ScotsPine

SilkyOak

SitkaSpruce

SouthernPine

SouthernPondPine

SouthernSprucePine

SPF

Spruce

SugarPine
SwissPear
SwissStonePine
Sycamore
SYP
Taeda
Tamarack
Tauari
Teak
Tiama
Tineo
TropicalOliver
Utile
VirginiaPine
Walnut
Wenge
Wey
WesternCedars
WesternHemlock
WesternRedCedar
WesternWhitePine
WesternWhiteSpruce
WesternWoods
WhitebarkPine
WhiteFir
WhiteOak
WhiteSpruce
WhiteWood
YellowCedar
YellowCypress
YellowPoplar
Zebrano
Other

SpecificationNumber

Specification Number

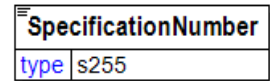

SpecInformation

Construct is used to uniquely identify this BookSpecification.

Note: ProductIdentifier, ProductDescription, and Classification removed in Version V2R30 and replaced with SpecificationNumber to more accurately reflect the business process.

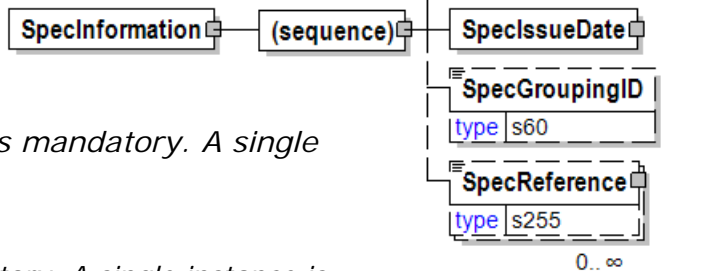

(sequence)

The sequence of items below is mandatory. A single instance is required.

SpecificationNumber

SpecificationNumber is mandatory. A single instance is required.

Specification Number

SpecVersion

SpecVersion is mandatory. A single instance is required.

The specification version

SpecIssueDate

SpecIssueDate is mandatory. A single instance is required.

Used to identify the issue date of this BookSpecification.

SpecGroupingID

SpecGroupingID is optional. A single instance might exist.

A value that will relate/link specifications together. For example, items that are usually manufactured with common components.

SpecReference

SpecReference is optional. Multiple instances might exist.

Used to identify any external or associated documents, identifiers, etc.

SpecIssueDate

Used to identify the issue date of this BookSpecification.

(sequence)

The sequence of items below is mandatory. A single instance is required.

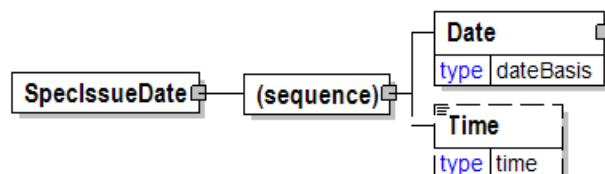

Date

Date is mandatory. A single instance is required.

A group element that contains the specification of Year, Month, and Day.

Time

Time is optional. A single instance might exist.

Times are treated in a standard XML fashion with a special case used to indicate a generalized "local" time. The standard XML approach to time is hh:mm:ss, hh:mm:ssZ, or hh:mm:ss±hh:mm.

hh:mm:ss±hh:mm is used to represent a time with a time zone. The time zone is communicated as the number of hours offset from the Universal Time Coordinate (UTC), a.k.a. Greenwich Mean Time.

hh:mm:ssZ indicates the time at Zulu (another name for UTC). Based on the convention described in the next bullet it will be important for users within UTC to use "Z" when communicating a time in their time zone to other users.

hh:mm:ss or hh:mm indicates in the XML standard the time at UTC however, within papiNet it is used to represent the applicable local time. Caution should be used when processing times of this nature as the papiNet approach may be in discord with other users of XML.

SpecPacking

SpecPacking defines the book packaging parameters.

IsBoxed [attribute]

IsBoxed is optional. A single instance might exist.

Refer to IsBoxed definition for any enumerations.

IsPalletized [attribute]

IsPalletized is optional. A single instance might exist.

The buyer's directions for how the item is to be palletized.

Refer to IsPalletized definition for any enumerations.

(sequence)

The sequence of items below is mandatory. A single instance is required.

ProductIdentifier

ProductIdentifier is mandatory. A single instance is required.

Used to communicate the code of the article, in a variety of formats designated by the type.

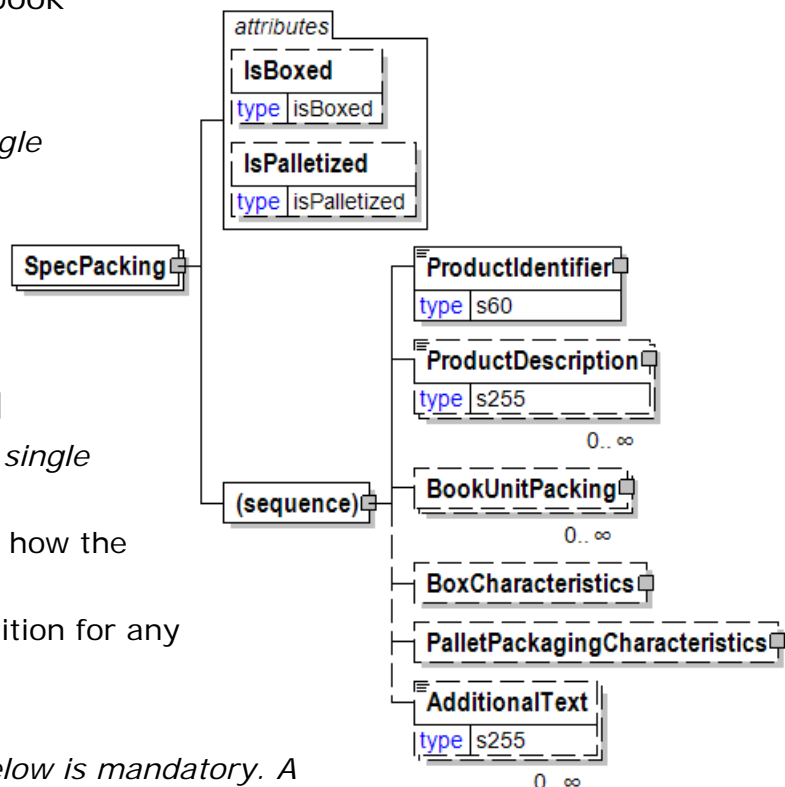

ProductDescription

ProductDescription is optional. Multiple instances might exist.

An element used to communicate a human readable description of the product in the language specified by the Language attribute.

BookUnitPacking

BookUnitPacking is optional. Multiple instances might exist.

Book unit packing information

BoxCharacteristics

BoxCharacteristics is optional. A single instance might exist.

BoxCharacteristics is a group element that contains information about the box (or carton)

PalletPackagingCharacteristics

PalletPackagingCharacteristics is optional. A single instance might exist.

PalletPackagingCharacteristics details the characteristics of the packaging for a pallet.

AdditionalText

AdditionalText is optional. Multiple instances might exist.

A text field that is used to communicate information not previously defined or for special instructions. To be used only for circumstances not covered by specific elements.

SpecReference

Used to identify any external or associated documents, identifiers, etc.

SpecReferenceType [attribute]

SpecReferenceType is mandatory. A single instance is required.

Provides a contextual explanation of the specific reference identifier. Many items are currently prefixed by "Buyer", "Forwarder", "Manufacturer", "Mill", "Seller", "Supplier", "Warehouse", or "Vendor". Check for an existing non-prefixed version and use the non-prefixed version instead. In the (yet to be announced release date) version 3.0 the prefixed versions will be removed. Instead the attribute @AssignedBy will communicate the information previously communicated in the prefix.

Refer to SpecReferenceType definition for any enumerations.

AssignedBy [attribute]

AssignedBy is optional. A single instance might exist.

Identifies the type of party that has assigned the associated item, e.g. a reference of type OrderNumber.

Refer to AssignedBy for any enumerations.

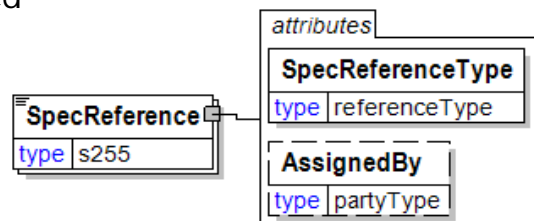

SpecReferenceType [attribute]

Provides a contextual explanation of the specific reference identifier. Many items are currently prefixed by "Buyer", "Forwarder", "Manufacturer", "Mill", "Seller", "Supplier", "Warehouse", or "Vendor". Check for an existing non-prefixed version and use the non-prefixed version instead. In the (yet to be announced release date) version 3.0 the prefixed versions will be removed. Instead the attribute @AssignedBy will communicate the information previously communicated in the prefix.

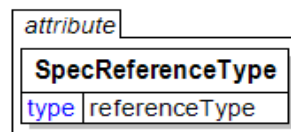

Refer to the [referenceType](#) entry for the list of enumerations and their definitions.

SpecStatusType [attribute]

Identifies the status of the entire BookSpecification e-Document (in other words, at the root level).

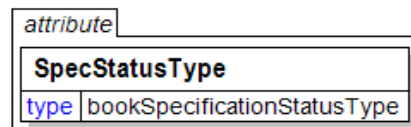

This item is restricted to the following list.

Amended

The supplied information is changed.

Cancelled

The supplied information has been cancelled. Items that have been cancelled are not included in totals on the summary levels of the e-Document.

Original

The supplied information is the first version of that information.

Replaced

The supplied information is replacing earlier supplied information. The receiver should revalidate the information in their system based upon the entire information received.

SpecType [attribute]

DefinitionUsed to identify what type of BookSpecification e-Document this transaction is.

This item is restricted to the following list.



SpecOrder

Used when the BookSpecification e-Document is intended for use with the PurchaseOrder transaction.

SpecRFQ

Used when the BookSpecification e-Document is intended for use with the Request for Quote (Estimate) transaction.

SupplierSpec

Will be removed in a future version. Recommended not to be used.
(Old definition: Used when the BookSpecification e-Document is intended for use by the Supplier only and is not generated by, or transmitted to the Buyer).

SpecVersion

The specification version

SpecVersion	
type	s40

SpeedType [attribute]

Speed Type

This item is restricted to the following list.

RampUp

RunSpeed

SlowDown

SpeedType	
type	machineSpeedType
default	RunSpeed

SpineLabel [attribute]

The sleeve spine label.

SpineLabel	
type	spineLabel

SpineLabel [attribute]

Is there a spine label?

This item is restricted to the following list.

Yes

No

SpineLabel	
type	yesNo

SpineSize

The height of the spine.

(sequence)

The sequence of items below is mandatory. A single instance is required.

Value

Value is mandatory. A single instance is required.

A numeric value expressed in the unit of measure (UOM).

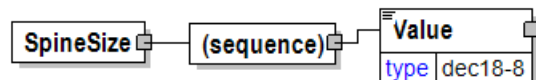

StackingMethod

A text field describing the pattern used when stacking of pallets.

StackingMethod	
type	s20

StacksPerPallet

The number of stacks on a pallet, where a stack is a vertical arrangement of items (looking down from above).

StacksPerPallet	
type	nni2

StandardDeviation

A statistic used as a measure of dispersion in a distribution.

UOM [attribute]

UOM is mandatory. A single instance is required.

Defines the unit of measure for the value.

Refer to UOM definition for any enumerations.

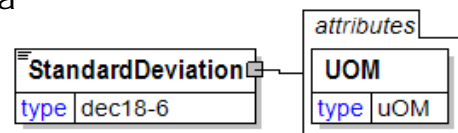

StandardSpacing

Is the spacing standard?

This item is restricted to the following list.

Yes

No

StandardSpacing	
type	yesNo

StartIdentifierRange

An element that identifies the starting item identifier in the range of items that contributed to the aggregated measurements for the range.

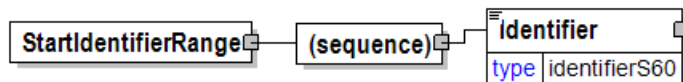

(sequence)

The sequence of items below is mandatory. A single instance is required.

Identifier

Identifier is mandatory. A single instance is required.

An Identifier is required for packages and items (pallets, reel packages, boxes, ream items, reel items, etc). The Identifier element contains the actual item identifier code. Identifier is repeatable so more than one identifier can be communicated. For example, the printed identifier on a label may be different from

the barcode printed on the label.

Statement

The Statement element is the root element for the Statement e-Document.

The Statement e-Document permits the manufacturer or supplier to report the current status of an invoice, or a list of invoices based upon specified criteria. The e-Document enables the sender to indicate payment status for the invoice.

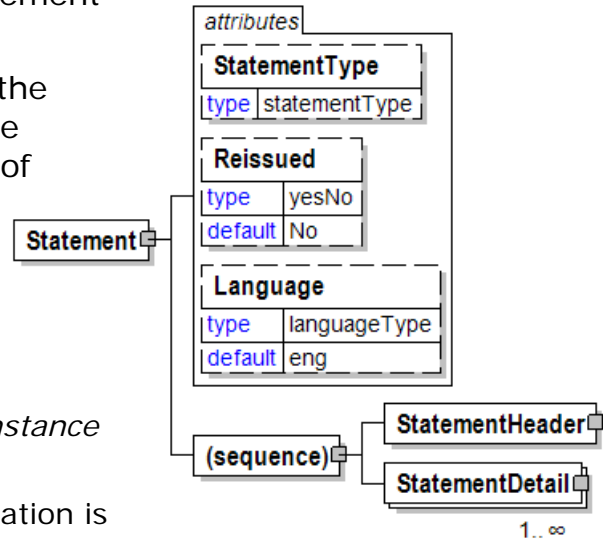

StatementType [attribute]

StatementType is optional. A single instance might exist.

Communicates how Statement information is filtered.

Refer to StatementType definition for any enumerations.

Reissued [attribute]

Reissued is optional. A single instance might exist.

Either "Yes" or "No".

Refer to Reissued definition for any enumerations.

Language [attribute]

Language is optional. A single instance might exist.

XML has embraced 2 and 3 digit language codes through the application of an addendum to the standard.

Refer to Language definition for any enumerations.

(sequence)

The sequence of items below is mandatory. A single instance is required.

StatementHeader

StatementHeader is mandatory. A single instance is required.

Information that applies to the entire Statement e-Document.

StatementDetail

StatementDetail is mandatory. One instance is required, multiple instances might exist.

The specifics of information being communicated in the Statement e-Document.

StatementDetail

The specifics of information being communicated in the Statement e-Document.

(sequence)

The sequence of items below is mandatory. A single instance is required.

InvoiceNumber

InvoiceNumber is mandatory. A single instance is required.

The identification number of the papiNet e-Document Invoice. This number uniquely identifies documents for all InvoiceType such as Invoice, DebitNote, CreditNote, Approximate, SelfBillingStatement etc.

InvoiceDate

InvoiceDate is mandatory. A single instance is required.

A date that is qualifying the invoicing period. This date often drives payment terms. Note that this date is not necessarily the same as the issue date of the invoice.

InvoiceReference

InvoiceReference is optional. Multiple instances might exist.

A group item detailing relevant references pertaining to the invoice e-Document. InvoiceReferenceType describes the content.

BillToParty

BillToParty is mandatory. A single instance is required.

The address where the invoice is to be sent.

SupplierParty

SupplierParty is mandatory. A single instance is required.

The organisation or business entity responsible for providing the product. SupplierParty is also the seller of the product, if Seller is not specified as OtherParty = Seller.

BuyerParty

BuyerParty is mandatory. A single instance is required.

The legal entity to which the product is sold. Also commonly referred to as the sold-to party or customer. If no OtherParty is defined as the Payer, the Buyer is the Payer.

RemitToParty

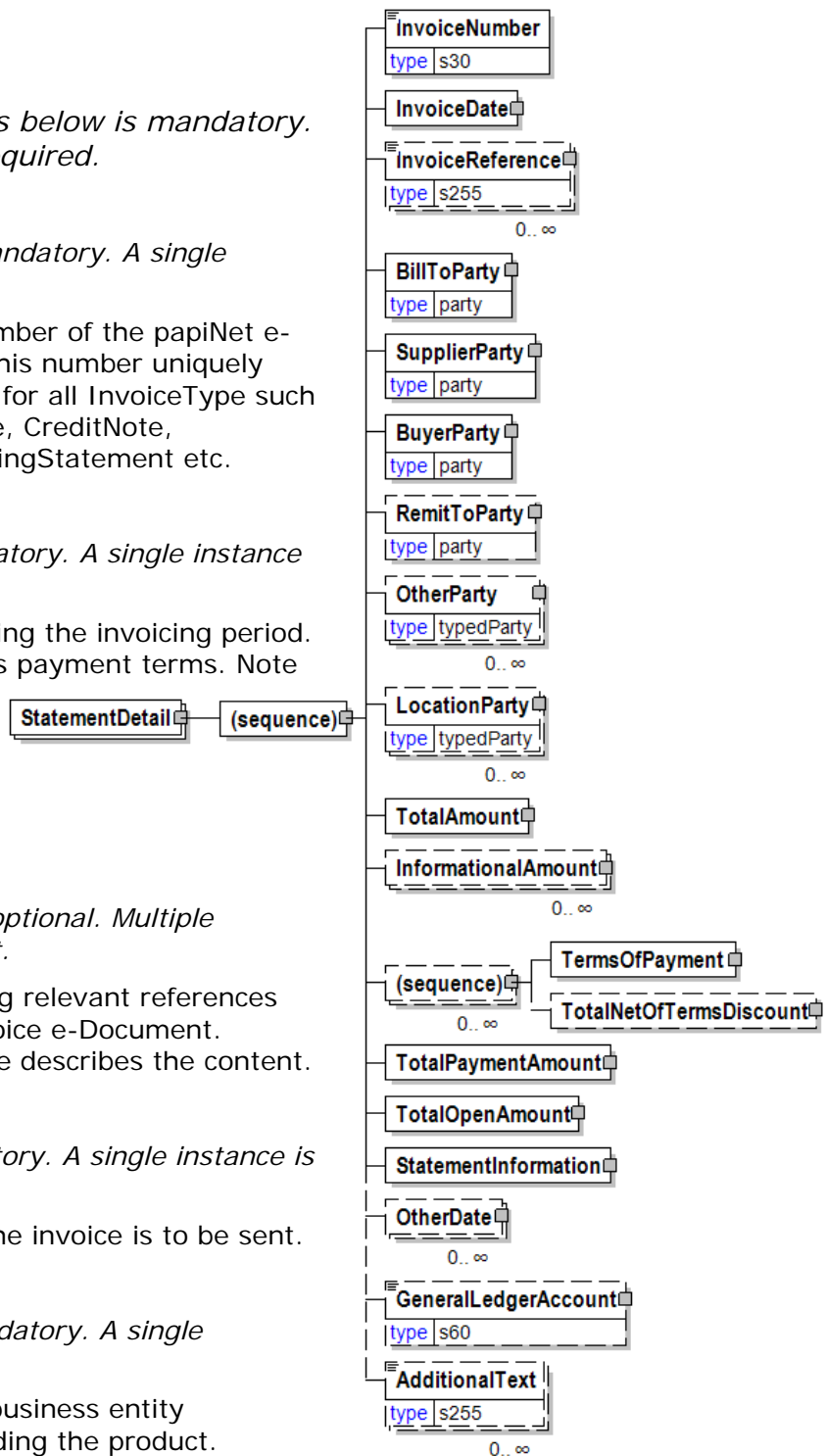

RemitToParty is optional. A single instance might exist.

A group item containing details of the party to whom payment will be made. The RemitToParty contains all information related to remittance.

OtherParty

OtherParty is optional. Multiple instances might exist.

An organisation or business entity other than those specifically detailed within a e-Document.

LocationParty

LocationParty is optional. Multiple instances might exist.

The organization or business entity where the business event took place or will take place.

TotalAmount

TotalAmount is mandatory. A single instance is required.

The total amount including tax.

In e-Documents claiming payment this is the amount due for payment based on the terms of payment. Decimal rounding might be applied to this amount.

InformationalAmount

InformationalAmount is optional. Multiple instances might exist.

A monetary amount used for information purposes only (not for calculation). For example, the invoice price adjustment subtotal is expressed in sterling pounds, and the buyer wants this information expressed in U.S. dollars.

CreditDebitNote and Invoice - The TaxAmount is displayed in the currency that is applicable throughout the e-Document. When a TaxAmount needs to be displayed in a different national currency, this field is used.

(sequence)

The sequence of items below is optional. Multiple instances might exist.

TermsOfPayment

TermsOfPayment is mandatory. A single instance is required.

A group item that contains agreed-to terms defining when, how, and under what conditions the payment is to be made.

When TermsOfPayment is optional; if omitted, TermsOfPayment is controlled through previous negotiation.

TotalNetOfTermsDiscount

TotalNetOfTermsDiscount is optional. A single instance might exist.

The components of the amount to be paid if prompt payment discount terms are met, including the amount that is subject to the payment terms discount, the discount amount, and the amount due after prompt payment discount.

TotalPaymentAmount

TotalPaymentAmount is mandatory. A single instance is required.

The amounts which were paid and booked against the original invoice.

TotalOpenAmount

TotalOpenAmount is mandatory. A single instance is required.

InvoiceAmount less the sum of all payment amounts, translated into one common

currency.

StatementInformation

StatementInformation is mandatory. A single instance is required.

Invoice information for the statement.

OtherDate

OtherDate is optional. Multiple instances might exist.

A date that may not be specifically detailed within a document (example: print date at the PurchaseOrderLineItem).

GeneralLedgerAccount

GeneralLedgerAccount is optional. A single instance might exist.

The general ledger account to be referenced for the item.

AdditionalText

AdditionalText is optional. Multiple instances might exist.

A text field that is used to communicate information not previously defined or for special instructions. To be used only for circumstances not covered by specific elements.

StatementHeader

Information that applies to the entire Statement e-Document.

(sequence)

The sequence of items below is mandatory. A single instance is required.

StatementNumber

StatementNumber is mandatory. A single instance is required.

A number used to identify the Statement.

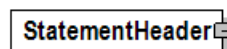

StatementResponseDate

StatementResponseDate is mandatory. A single instance is required.

RequestNumber

RequestNumber is optional. A single instance might exist.

A unique tracking number specifically identifying the InfoRequest e-Document to the originator. The tracking number is returned with the "information", the answer, to help match the answer to the request.

RequestingParty

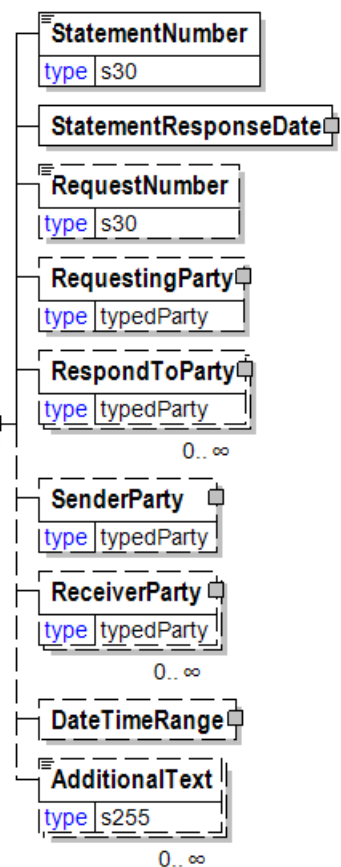

papiNet V2R31

RequestingParty is optional. A single instance might exist.

The party requesting the information.

RespondToParty

RespondToParty is optional. Multiple instances might exist.

The party the document should be responded to.

SenderParty

SenderParty is optional. A single instance might exist.

The business entity issuing the e-Document, the source of the document.

The entity responsible for the content. If the sender party has out sourced the message service to a third party the SenderParty is the issuer of the e-Document and not the party performing the transmission service of the electronic message.

ReceiverParty

ReceiverParty is optional. Multiple instances might exist.

The business entity for whom the e-Document is intended, the destination of the document.

The entity interested in the content. If the receiver party has outsourced the message service to a third party the ReceiverParty is the intended party for the e-Document and not the party performing the receiving service of the electronic message.

DateTimeRange

DateTimeRange is optional. A single instance might exist.

Specifies a date and/or time range.

AdditionalText

AdditionalText is optional. Multiple instances might exist.

A text field that is used to communicate information not previously defined or for special instructions. To be used only for circumstances not covered by specific elements.

StatementInformation

Invoice information for the Statement.

(sequence)

The sequence of items below is mandatory. A single instance is required.

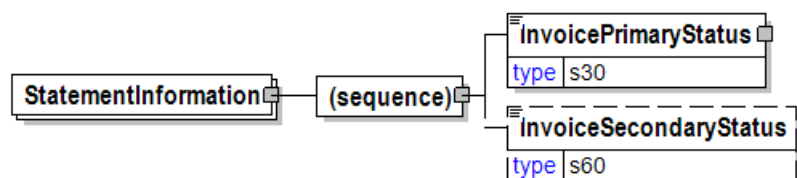

InvoicePrimaryStatus

InvoicePrimaryStatus is mandatory. A single instance is required.

The primary status of the invoice.

InvoiceSecondaryStatus

InvoiceSecondaryStatus is optional. A single instance might exist.

The secondary status of the invoice.

StatementNumber

A number used to identify the Statement.

StatementNumber	
type	s30

StatementRequestDetail

A grouping element that provides the parameters to be used when responding with a Statement e-Document.

StatementRequestType [attribute]

StatementRequestType is mandatory. A single instance is required.

Communicates how statement information is filtered.

Refer to StatementRequestType definition for any enumerations.

(sequence)

The sequence of items below is mandatory. A single instance is required.

SupplierParty

SupplierParty is optional. Multiple instances might exist.

The organisation or business entity responsible for providing the product. SupplierParty is also the seller of the product, if Seller is not specified as OtherParty = Seller.

BuyerParty

BuyerParty is optional. Multiple instances might exist.

The legal entity to which the product is sold. Also commonly referred to as the sold-to party or customer. If no OtherParty is defined as the Payer, the Buyer is the Payer.

ShipToParty

ShipToParty is optional. Multiple instances might exist.

The name and/or address to which the goods should be delivered with the party type indicated by the PartyType attribute.

ForwarderParty

ForwarderParty is optional. Multiple instances might exist.

The trading partner involved in the forwarding of the shipment.

StatementInformation

StatementInformation is optional. Multiple instances might exist.

Invoice information for the Statement.

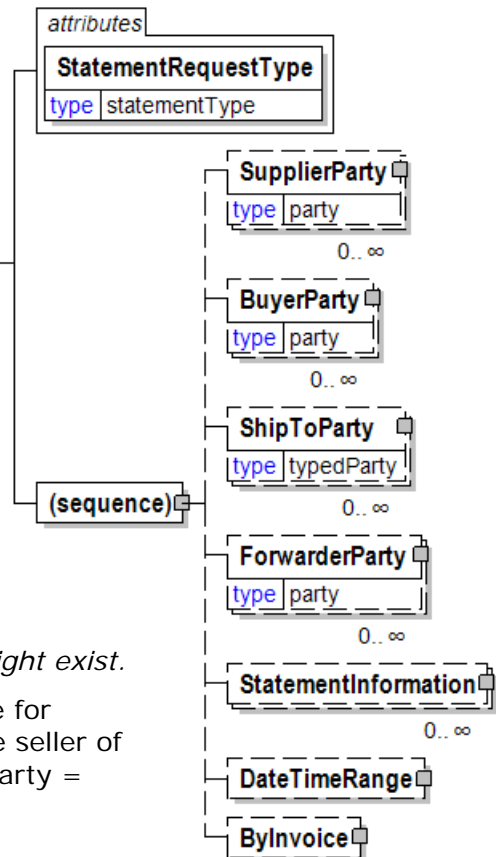

DateTimeRange

DateTimeRange is optional. A single instance might exist.

Specifies a date and/or time range.

ByInvoice

ByInvoice is optional. A single instance might exist.

Selection criteria for invoice information.

StatementRequestType [attribute]

Communicates how statement information is filtered.

This item is restricted to the following list.

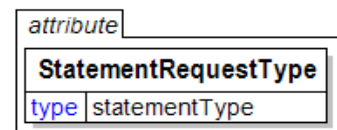

AllCreditsDebitsInvoices

ByCreditDebit

ByCreditDebit will be deprecated in a future version. Use AllCreditsDebitsInvoices instead.

ByInvoiceNumber

ByDebit

StatementResponseDate

(sequence)

The sequence of items below is mandatory. A single instance is required.

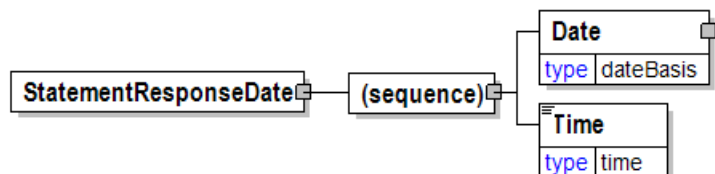

Date

Date is mandatory. A single instance is required.

A group element that contains the specification of Year, Month, and Day.

Time

Time is mandatory. A single instance is required.

Times are treated in a standard XML fashion with a special case used to indicate a generalized "local" time. The standard XML approach to time is hh:mm:ss, hh:mm:ssZ, or hh:mm:ss±hh:mm.

hh:mm:ss±hh:mm is used to represent a time with a time zone. The time zone is communicated as the number of hours offset from the Universal Time Coordinate (UTC), a.k.a. Greenwich Mean Time.

hh:mm:ssZ indicates the time at Zulu (another name for UTC). Based on the convention described in the next bullet it will be important for users within UTC to use "Z" when communicating a time in their time zone to other users.

hh:mm:ss or hh:mm indicates in the XML standard the time at UTC however, within papiNet it is used to represent the applicable local time. Caution should be used when processing times of this nature as the papiNet approach may be in discord with other users of XML.

StatementType [attribute]

Communicates how statement information is filtered.

This item is restricted to the following list.

AllCreditsDebitsInvoices

ByCreditDebit

ByCreditDebit will be deprecated in a future version. Use AllCreditsDebitsInvoices instead.

ByInvoiceNumber

ByDebit

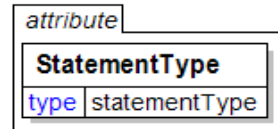

StateOrProvince

The political designation or boundary of a specific area of land.

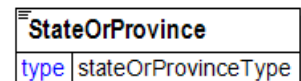

StateOrProvince [attribute]

The political designation or boundary of a specific area of land.



StatisticalGoodsInformation

A group item containing statistical information about handled or traded goods.

(sequence)

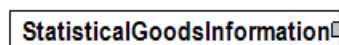

The sequence of items below is mandatory. A single instance is required.

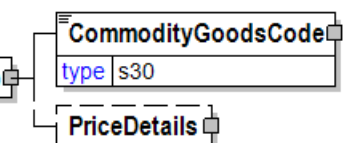

CommodityGoodsCode

CommodityGoodsCode is mandatory. A single instance is required.

A code defining the type of goods handled or traded. The Harmonized Commodity Description and Coding System (HS) of the Customs Cooperation Council (CCC) is used worldwide as a reference for classifications of external trade statistics and for customs tariffs.

PriceDetails

PriceDetails is optional. A single instance might exist.

An element that groups together price information.

Status [attribute]

Defines whether or not the electronic transaction successfully processed in the receiver ERP system.

This item is restricted to the following list.

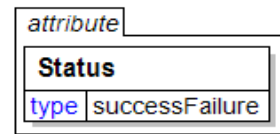

Success

Indicates that the electronic transaction successfully processed in the receiver ERP system.

Failure

Indicates that the electronic transaction failed to process in the receiver ERP system.

StatusAsOfDate

The specific Date and Time for which status is requested. This implies that all open transactions have closed for the date before the status is reported.

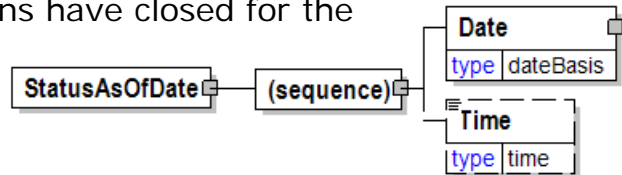

(sequence)

The sequence of items below is mandatory. A single instance is required.

Date

Date is mandatory. A single instance is required.

A group element that contains the specification of Year, Month, and Day.

Time

Time is optional. A single instance might exist.

Times are treated in a standard XML fashion with a special case used to indicate a generalized "local" time. The standard XML approach to time is hh:mm:ss, hh:mm:ssZ, or hh:mm:ss±hh:mm.

hh:mm:ss±hh:mm is used to represent a time with a time zone. The time zone is communicated as the number of hours offset from the Universal Time Coordinate (UTC), a.k.a. Greenwich Mean Time.

hh:mm:ssZ indicates the time at Zulu (another name for UTC). Based on the convention described in the next bullet it will be important for users within UTC to use "Z" when communicating a time in their time zone to other users.

hh:mm:ss or hh:mm indicates in the XML standard the time at UTC however, within papiNet it is used to represent the applicable local time. Caution should be used when processing times of this nature as the papiNet approach may be in discord with other users of XML.

StencilCharacteristics

A group element specifying attributes of a stencil to be applied to an item, and optional text.

StencilType [attribute]

StencilType is optional. A single instance might exist.

The type of stencil

Refer to StencilType definition for any enumerations.

StencilInkType [attribute]

StencilInkType is optional. A single instance might exist.

Specifies the characteristics of the ink to be used for the stencil

Refer to StencilInkType definition for any enumerations.

StencilLocation [attribute]

StencilLocation is optional. A single instance might exist.

Specifies the location of the stencil on the product

Refer to StencilLocation definition for any enumerations.

StencilFormat [attribute]

StencilFormat is optional. A single instance might exist.

Specifies how the information is to be presented in the stencil

Refer to StencilFormat definition for any enumerations.

StencilContent [attribute]

StencilContent is optional. A single instance might exist.

Specifies the information contained in the stencil.

Refer to StencilContent definition for any enumerations.

AssignedBy [attribute]

AssignedBy is optional. A single instance might exist.

Identifies the type of party that has assigned the associated item, e.g. a reference of type OrderNumber.

Refer to AssignedBy definition for any enumerations.

(sequence)

The sequence of items below is mandatory. A single instance is required.

StencilText

StencilText is optional. Multiple instances might exist.

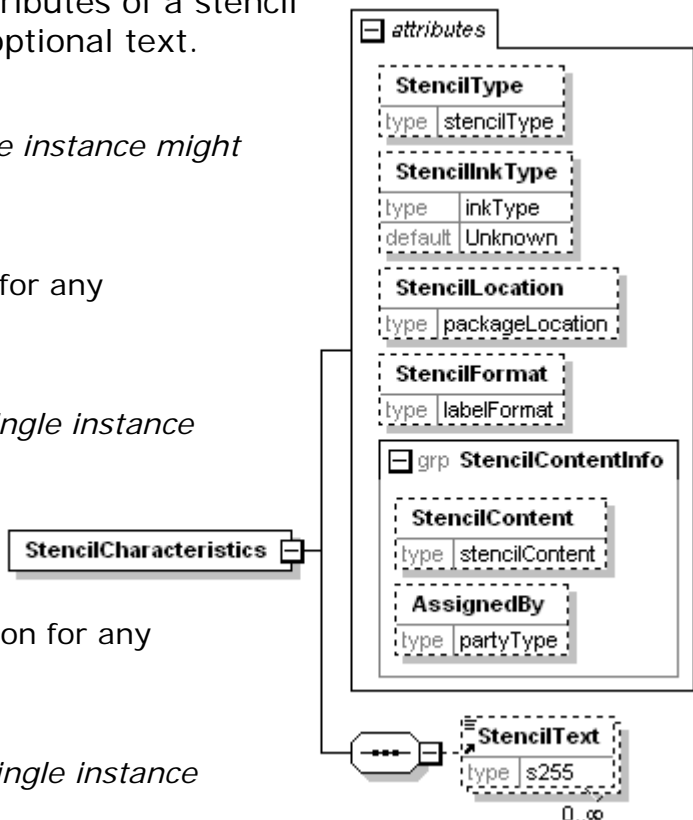

Plain text that is to be stenciled on the product. Used in conjunction with StencilContent = "PlainText".

StencilContent [attribute]

Specifies the information contained in the stencil.

This item is restricted to the following list.

attribute
StencilContent
type stencilContent

Author

Name of the author of the product or book

BasisWeight

The weight of the paper expressed as a mass for a given surface area.

BoxWeight

Weight of the filled box.

BrandName

A specific product brand name for which the owner or source is specified in the "@AssignedBy" attribute.

Copyright

The year of publication copyright.

Edition

Identifies the version of the product for which copies were printed and published at one time; For example in book manufacturing values might be 1st, 2nd, etc

ExportShipMark

An export shipment mark for identification.

GradeCode

A specific product code for which the owner or source is specified in the "@AssignedBy" attribute.

GradeName

A specific product name for which the owner or source is specified in the "@AssignedBy" attribute (for example, ImprovedNewsprint-45-1479).

Identifier

Identifier of the individual item.

ISBN10

10 digit ISBN code without dashes.

ISBN10Dash

10 digit ISBN code with dashes.

ISBN13

13 digit ISBN code.

ISBN13Dash

A 13 character ISBN with dashes.

LotIdentifier

A unique code used to identify a grouping of product with one set of quality statistics common to all members of that group. Synonym: Lot Number.

PartNumber

An equivalent to the Stock Keeping Unit (SKU) for which the owner or source is specified in the "@AssignedBy" attribute. In other words, this code fully defines the product.

PlainText

To be removed in a future version. Use instead "ReferenceNumber".

PrintingNumber

A reference to the sequential print run number.

ProductIdentifier

To be removed in a future version. Use instead specific product identifier types such as BrandName, GradeCode, GradeName and PartNumber.

ProfitCenter

Profit Center identifier.

PubName

The publication name.

PurchaseOrderNumber

The unique order identifier as designated by the customer.

PurchaseOrderReference

To be removed in a future version. Use instead "ReferenceNumber".

ReferenceNumber

An informational reference (either textual or numeric) for which the owner or source is specified in the "@AssignedBy" attribute

RetailPrice

Cover price of the finished product.

TambourID

The unique identifier of the jumbo reel (also called mother reel or Tambour).

Title

Proper title of a book product.

TitleAlias

Alternate title description for book products, usually for security purposes.

UnitsPerCarton

Number of units per box.

UniversalProductIdentifier

Unique identifier for the book, component of a book product, and many other products.

VendorBrandName

To be removed in a future version. Use instead "BrandName" and specify owner or source is in the "@AssignedBy" attribute with enumeration "Seller".

VendorGradeCode

To be removed in a future version. Use instead "GradeCode" and specify owner or source is in the "@AssignedBy" attribute with enumeration "Seller".

VendorGradeName

To be removed in a future version. Use instead "GradeName" and specify owner or source is in the "@AssignedBy" attribute with enumeration "Seller".

StencilFormat [attribute]

Specifies how the information is to be presented in the stencil

This item is restricted to the following list.

Barcode

The information requested is to be stenciled as a barcode

Text

The information requested is to be stenciled in plain text.

attribute	
StencilFormat	
type	labelFormat

StencilInkType [attribute]

Specifies the characteristics of the ink to be used for the stencil

This item is restricted to the following list.

EdibleNotWaterSoluble

The ink used is suitable for human consumption but will not dissolve in water.

EdibleWaterSoluble

The ink used is suitable for human consumption and is soluble in water.

InedibleNotWaterSoluble

The ink used is not suitable for human consumption and will not dissolve in water.

InedibleWaterSoluble

The ink used is not suitable for human consumption and is soluble in water.

Unknown

The characteristics of the ink used for the stencil are unknown.

attribute	
StencilInkType	
type	inkType
default	Unknown

StencilLocation [attribute]

Specifies the location of the stencil on the product

This item is restricted to the following list.

attribute	
StencilLocation	
type	packageLocation

End

The stencil is to be placed on the end of the product.
E.g. on the end of a pallet, box, bale or reel.

Top

The stencil is to be placed on the top of the product. E.g. on the top of a pallet, box, bale or reel.

Side

The stencil is to be placed on the side of the product. E.g. on the side of a pallet, box or bale.

UnwrappedReelBilge

The stencil is to be placed on the unwrapped (bare) reel bilge (side).

UnwrappedReelEnd

The stencil is to be placed on the unwrapped (bare) end of a reel.

WrappedReelBilge

The stencil is to be placed on the outside of the wrapper on a reel.

StencilText

Plain text that is to be stenciled on the product. Used in conjunction with StencilContent = "PlainText".

StencilText	
type	s255

StencilType [attribute]

The type of stencil

This item is restricted to the following list.

attribute	
StencilType	
type	stencilType

CutOut

The stencil is a cut out.

InkJet

The stencil is ink jetted.

Rubber

The stencil is made of rubber.

Stiffness

A group item used to communicate stiffness target or test value.

TestMethod [attribute]

TestMethod is optional. A single instance might exist.

The method used to determine the results of the test under consideration.

TestAgency [attribute]

TestAgency is optional. A single instance might exist.

The agency that has set the parameters for the testing

Refer to TestAgency definition for any enumerations.

SampleType [attribute]

SampleType is optional. A single instance might exist.

Communicates how sampling was done to measure the product characteristics.

Refer to SampleType definition for any enumerations.

ResultSource [attribute]

ResultSource is optional. A single instance might exist.

Used to define the data source of the specified test

Refer to ResultSource definition for any enumerations.

(sequence)

The sequence of items below is mandatory. A single instance is required.

DetailValue

DetailValue is mandatory. A single instance is required.

A numeric value expressed in the unit of measure (UOM).

DetailRangeMin

DetailRangeMin is optional. A single instance might exist.

The minimum value (lower boundary) allowed for the DetailValue that is the parent of this element.

DetailRangeMax

DetailRangeMax is optional. A single instance might exist.

The maximum value (upper boundary) allowed for the DetailValue that is the parent of this element.

StandardDeviation

StandardDeviation is optional. A single instance might exist.

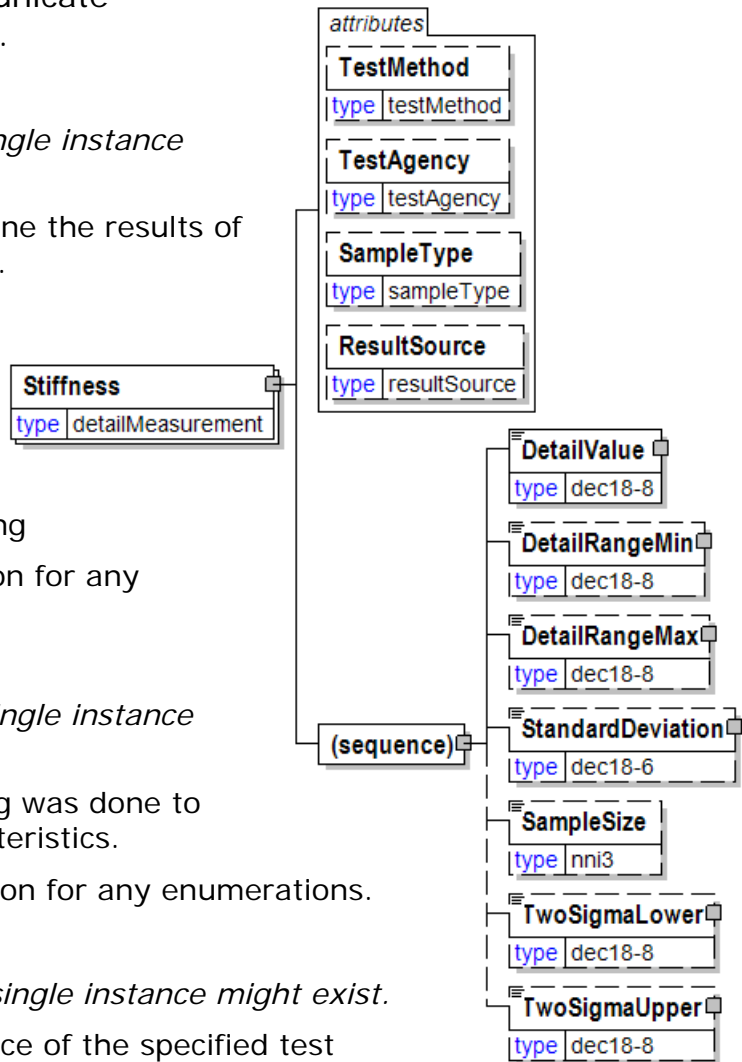

papiNet V2R31

A statistic used as a measure of dispersion in a distribution.

SampleSize

SampleSize is optional. A single instance might exist.

The number of samples used to determine the product characteristic in question.

TwoSigmaLower

TwoSigmaLower is optional. A single instance might exist.

Two sigma (a measure of dispersion associated with standard deviation) on the lower side of the standard deviation.

TwoSigmaUpper

TwoSigmaUpper is optional. A single instance might exist.

Two sigma (a measure of dispersion associated with standard deviation) on the upper side of the standard deviation.

StopOffInformation

Where is the shipment and how far to the next stop.

(sequence)

The sequence of items below is mandatory. A single instance is required.

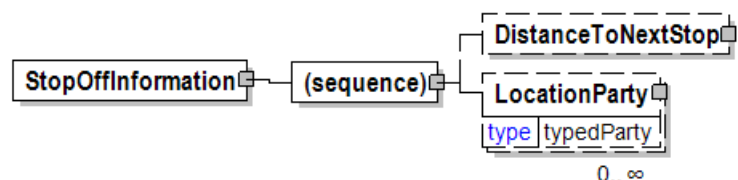

DistanceToNextStop

DistanceToNextStop is optional. A single instance might exist.

The distance to the next transportation node.

LocationParty

LocationParty is optional. Multiple instances might exist.

The organization or business entity where the business event took place or will take place.

StrengthGroup

As defined in the NIST standard, an additional classification of panel strength.

This item is restricted to the following list.

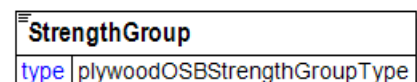

Class-I

Class-II

Group1

Group2

Group3

Group4

Struc-I

Decorative

Stretch

A group item used to communicate stretch target or test value.

TestMethod [attribute]

TestMethod is optional. A single instance might exist.

The method used to determine the results of the test under consideration.

TestAgency [attribute]

TestAgency is optional. A single instance might exist.

The agency that has set the parameters for the testing

Refer to TestAgency definition for any enumerations.

SampleType [attribute]

SampleType is optional. A single instance might exist.

Communicates how sampling was done to measure the product characteristics.

Refer to SampleType definition for any enumerations.

ResultSource [attribute]

ResultSource is optional. A single instance might exist.

Used to define the data source of the specified test

Refer to ResultSource definition for any enumerations.

(sequence)

The sequence of items below is mandatory. A single instance is required.

DetailValue

DetailValue is mandatory. A single instance is required.

A numeric value expressed in the unit of measure (UOM).

DetailRangeMin

DetailRangeMin is optional. A single instance might exist.

The minimum value (lower boundary) allowed for the DetailValue that is the parent of this element.

DetailRangeMax

DetailRangeMax is optional. A single instance might exist.

The maximum value (upper boundary) allowed for the DetailValue that is the parent of this element.

StandardDeviation

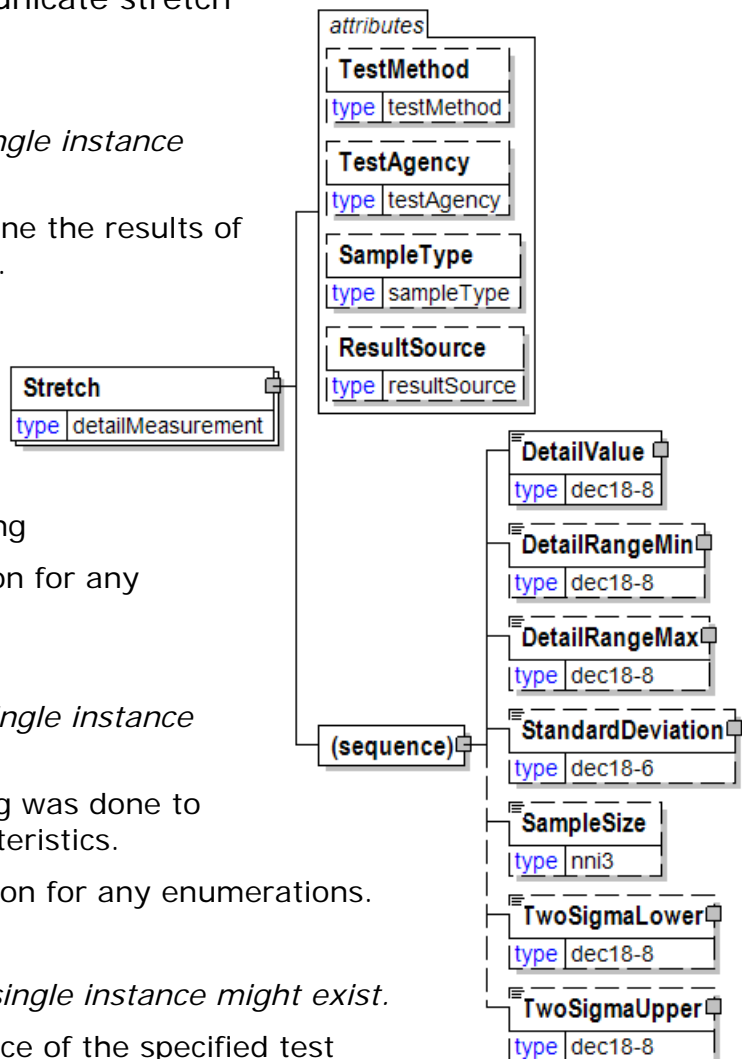

StandardDeviation is optional. A single instance might exist.

A statistic used as a measure of dispersion in a distribution.

SampleSize

SampleSize is optional. A single instance might exist.

The number of samples used to determine the product characteristic in question.

TwoSigmaLower

TwoSigmaLower is optional. A single instance might exist.

Two sigma (a measure of dispersion associated with standard deviation) on the lower side of the standard deviation.

TwoSigmaUpper

TwoSigmaUpper is optional. A single instance might exist.

Two sigma (a measure of dispersion associated with standard deviation) on the upper side of the standard deviation.

SubClassification

SubClassification provides additional classification information.

(sequence)

The sequence of items below is mandatory. A single instance is required.

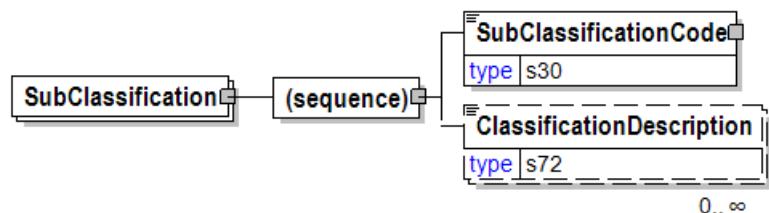

SubClassificationCode

SubClassificationCode is mandatory. A single instance is required.

Sub Classification Code

ClassificationDescription

ClassificationDescription is optional. Multiple instances might exist.

A free form description of the classification.

SubClassificationCode

Sub Classification Code

Agency [attribute]

Agency is mandatory. A single instance is required.

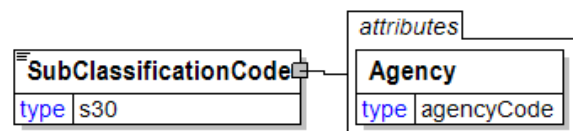

Describes the agency maintaining the list of codes. To be included in this list the agency must be a recognized standards body or industry organisation.

For the element that owns this attribute.

For another attribute in the list of attributes associated with the parent element.

Refer to Agency definition for any enumerations.

SupersType [attribute]

Supers Type

This item is restricted to the following list.

- Ribbed**
- Regular**

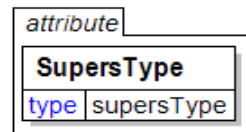

Supplemental

Supplemental

SupplementalSpecification [attribute]

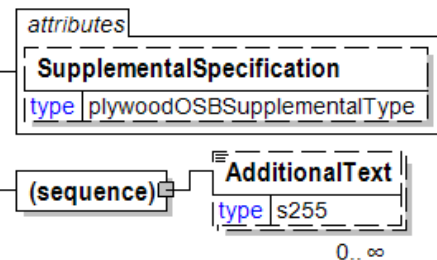
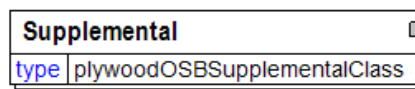

SupplementalSpecification is optional. A single instance might exist.

Supplemental specification

Refer to SupplementalSpecification definition for any enumerations.

(sequence)

The sequence of items below is mandatory. A single instance is required.

AdditionalText

AdditionalText is optional. Multiple instances might exist.

A text field that is used to communicate information not previously defined or for special instructions. To be used only for circumstances not covered by specific elements.

SupplementalSpecification [attribute]

Supplemental specification

This item is restricted to the following list.

- EdgeSealed**
- Overlay-1Side**
- Overlay-2Side**
- B-X-band**
- Plugged-X-Band**
- PluggedInnerPlies**
- Solid inner plies.

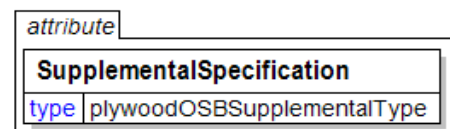

SuppliedComponentFinishSpecs

Supplied Component Finish Specs

(sequence)

The sequence of items below is mandatory. A single instance is required.

FinishSpecs

FinishSpecs is optional. A single instance might exist.

Finish specifications

FinishPrep

FinishPrep is optional. Multiple instances might exist.

Finish prep

AdditionalText

AdditionalText is optional. Multiple instances might exist.

A text field that is used to communicate information not previously defined or for special instructions. To be used only for circumstances not covered by specific elements.

Length

Length is optional. A single instance might exist.

The length of the object.

Width

Width is optional. A single instance might exist.

The width of the object.

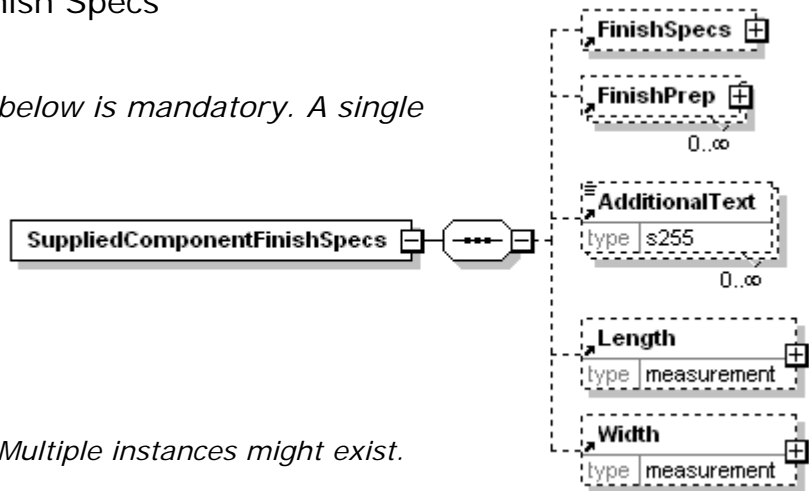

SuppliedComponentInformation

Information about components supplied by the publisher to the vendor i.e. paper supplied to the print vendor or jackets supplied to the bind vendor.

SuppliedComponentType [attribute]

SuppliedComponentType is

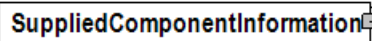

optional. A single instance might exist.

Supplied Component Type

Refer to SuppliedComponentType definition for any enumerations.

(sequence)

The sequence of items below is mandatory. A single instance is required.

SupplierParty

SupplierParty is mandatory. A single instance is required.

The organisation or business entity responsible for providing the product. SupplierParty is also the seller of the product, if Seller is not specified as OtherParty = Seller.

(sequence)

The sequence of items below is mandatory. One instance is required, multiple instances might exist.

ProductIdentifier

ProductIdentifier is mandatory. A single instance is required.

Used to communicate the code of the article, in a variety of formats designated by the type.

ProductDescription

ProductDescription is optional. Multiple instances might exist.

An element used to communicate a human readable description of the product in the language specified by the Language attribute.

Classification

Classification is optional. Multiple instances might exist.

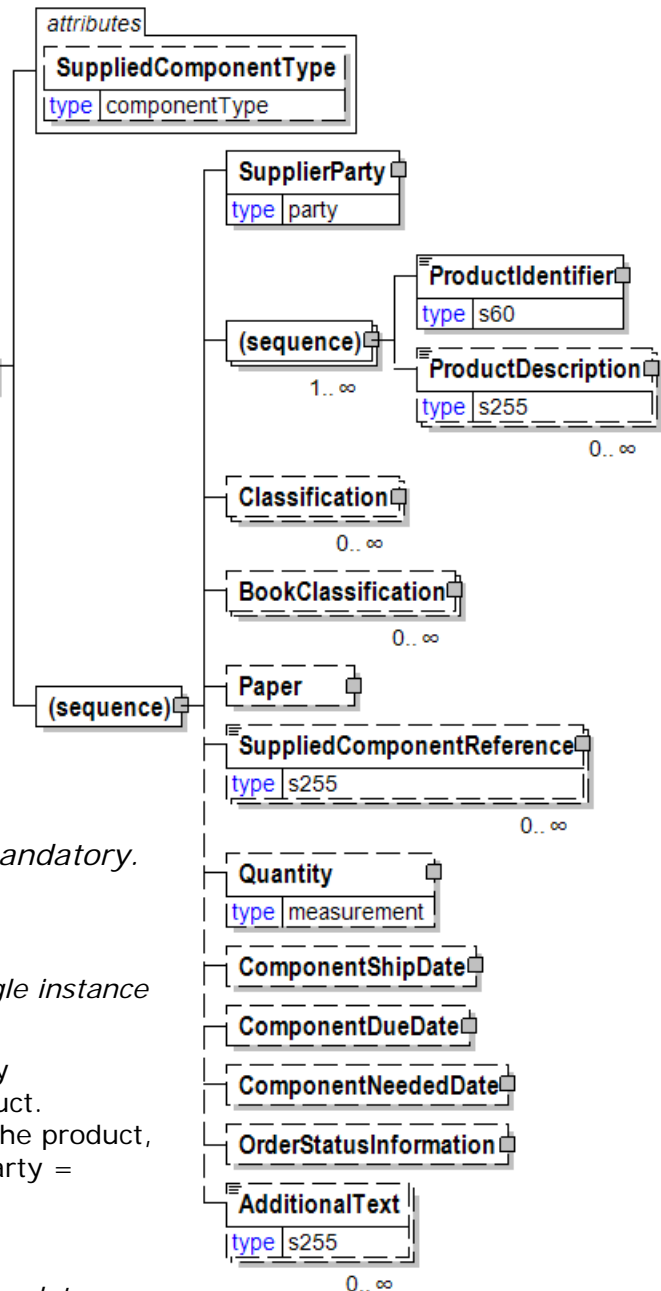

A group item that details the product classification according to a particular organization's scheme. An item across multiple classifications would still be recognized as the same item. Examples of some product classifications are: Containerboard, Pulp-Dissolving, or Newsprint.

BookClassification

BookClassification is optional. Multiple instances might exist.

Category under which the product or a component within the product is classified.

Paper

Paper is optional. A single instance might exist.

A group item defining the characteristics of the paper product.

SuppliedComponentReference

SuppliedComponentReference is optional. Multiple instances might exist.

Used to send component PurchaseOrder number for supplied components if they need to be returned on a invoice

Quantity

Quantity is optional. A single instance might exist.

The Quantity element contains attributes that provide information about the type of quantity that is being communicated, the context in which the particular quantity is to be viewed, and (if the quantity represents an adjustment) an adjustment type.

The Quantity element contains three child elements that enable you to communicate a range of values for the quantity and a target or actual value. It is at this level (Value, RangeMin, and RangeMax) that the unit of measure is specified. This permits the range to be specified in a different unit of measure than the target.

ComponentShipDate

ComponentShipDate is optional. A single instance might exist.

Date supplied component is expected to ship

ComponentDueDate

ComponentDueDate is optional. A single instance might exist.

Date supplied component is expected to arrive

ComponentNeededDate

ComponentNeededDate is optional. A single instance might exist.

Date the supplied component is needed by the vendor in order to make the due date of the ordered product.

OrderStatusInformation

OrderStatusInformation is optional. A single instance might exist.

A group element that stores two levels of order status codes.

AdditionalText

AdditionalText is optional. Multiple instances might exist.

A text field that is used to communicate information not previously defined or for special instructions. To be used only for circumstances not covered by specific elements.

SuppliedComponentReference

Used to send component PurchaseOrder number for supplied components if they need to be returned on a invoice

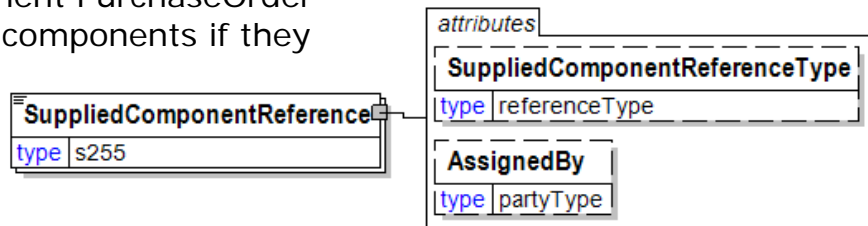

SuppliedComponentReferenceType [attribute]

SuppliedComponentReferenceType is optional. A single instance might exist.

SuppliedComponentReferenceType provides a contextual explanation of the specific reference identifier. Many items are currently prefixed by "Buyer", "Customer", "Seller", and/or "Supplier". Check for an existing non-prefixed version and use the non-prefixed version instead. In the (yet to be announced release date) version 3.0 the prefixed versions will be removed. Instead the attribute @AssignedBy will communicate the information previously communicated in the prefix.

Refer to SuppliedComponentReferenceType definition for any enumerations.

AssignedBy [attribute]

AssignedBy is optional. A single instance might exist.

Identifies the type of party that has assigned the associated item, e.g. a reference of type OrderNumber.

Refer to AssignedBy for any enumerations.

SuppliedComponentReferenceType [attribute]

SuppliedComponentReferenceType provides a contextual explanation of the specific reference identifier. Many items are currently prefixed by "Buyer", "Customer", "Seller", and/or "Supplier". Check for an existing non-prefixed version and use the non-prefixed version instead. In the (yet to be announced release date) version 3.0 the prefixed versions will be removed. Instead the attribute @AssignedBy will communicate the information previously communicated in the prefix.

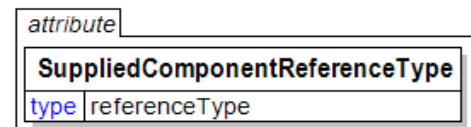

Refer to the [referenceType](#) entry for the list of enumerations and their definitions.

SuppliedComponentType [attribute]

Supplied Component Type

This item is restricted to the following list.

- Component**
- RawMaterial**

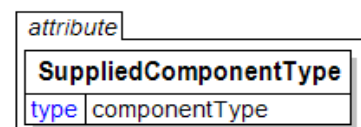

SupplierCustomsReference

Supplier Customs Reference

SupplierCustomsReferenceType [attribute]

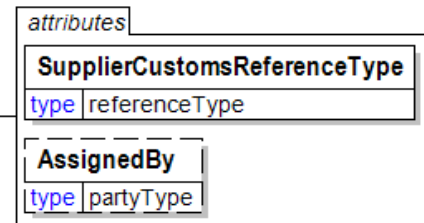
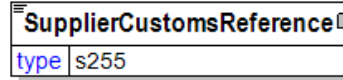

SupplierCustomsReferenceType is mandatory. A single instance is required.

Provides a contextual explanation of the specific reference identifier. Many items are currently prefixed by "Buyer", "Forwarder", "Manufacturer", "Mill", "Seller", "Supplier", "Warehouse", or "Vendor". Check for an existing non-prefixed version and use the non-prefixed version instead. In the (yet to be announced release date) version 3.0 the prefixed versions will be removed. Instead the attribute @AssignedBy will communicate the information previously communicated in the prefix.

Refer to SupplierCustomsReferenceType definition for any enumerations.

AssignedBy [attribute]

AssignedBy is optional. A single instance might exist.

Identifies the type of party that has assigned the associated item, e.g. a reference of type OrderNumber.

Refer to AssignedBy for any enumerations.

SupplierCustomsReferenceType [attribute]

Provides a contextual explanation of the specific reference identifier. Many items are currently prefixed by "Buyer", "Forwarder", "Manufacturer", "Mill", "Seller", "Supplier", "Warehouse", or "Vendor". Check for an

existing non-prefixed version and use the non-prefixed version instead. In the (yet to be announced release date) version 3.0 the prefixed versions will be removed. Instead the attribute @AssignedBy will communicate the information previously communicated in the prefix.

Refer to the [referenceType](#) entry for the list of enumerations and their definitions.

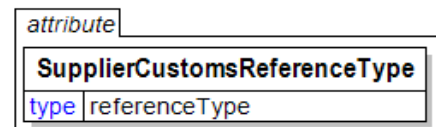

SupplierMarks

Supplier provided markings.

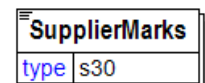

SupplierOrderLineItemNumber

The number of the line item on the supplier order.

SupplierOrderLineItemNumber	
type	lineNumberType

SupplierOrderNumber

The number of the supplier order.

SupplierOrderNumber	
type	s30

SupplierParty

The organisation or business entity responsible for providing the product. SupplierParty is also the seller of the product, if Seller is not specified as OtherParty = Seller.

LogisticsRole [attribute]

LogisticsRole is optional. A single instance might exist.

Communicates the nature of the logistics role, if any, the party plays in the transaction.

Refer to LogisticsRole definition for any enumerations.

(sequence)

The sequence of items below is mandatory. A single instance is required.

PartyIdentifier

PartyIdentifier is optional. Multiple instances might exist.

A unique identifier of a specific party. This element contains an attribute PartyIdentifierType that indicates the type of party.

NameAddress

NameAddress is mandatory. A single instance is required.

A group item containing name and address of an organisation or business entity.

URL

URL is optional. A single instance might exist.

Universal Resource Locator. While typically a web address you could use this field to hold an email address.

CommonContact

CommonContact is optional. Multiple instances might exist.

Identifies a specific individual associated with the party.

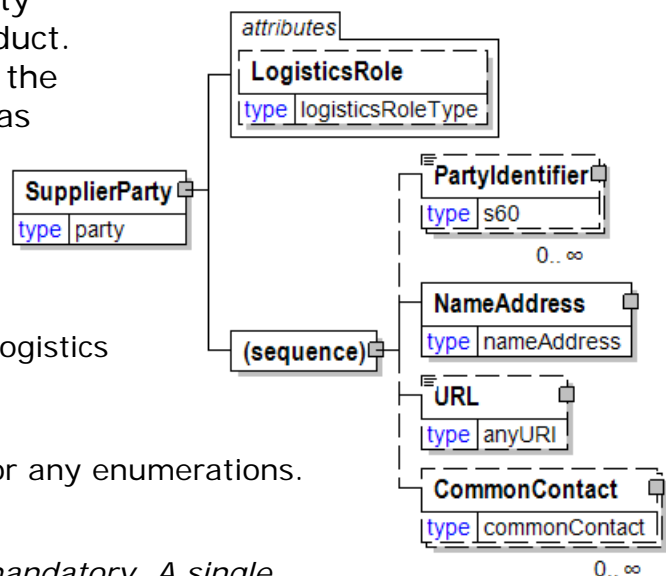

SupplyPoint

Grouping element that contains items describing a supply point. A SupplyPoint belongs to a LocationParty, e.g. in a DeliveryOrigin or DeliveryDestination, and describes where goods are stored and can be loaded or unloaded. A SupplyPoint can for example be a loading or unloading gate at a warehouse or a road side landing at a logging area in the forest.

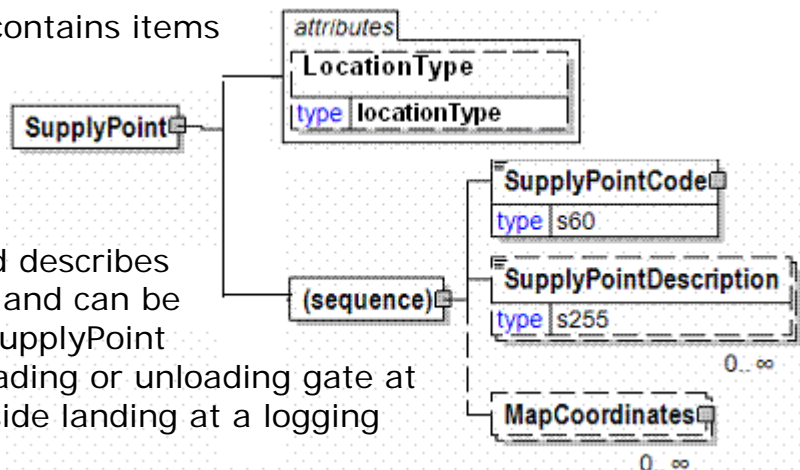

LocationType [attribute]

Defines type of location when context needs to be specified, e.g. when goods are moved from one location to a new location.

Refer to LocationType for any enumerations.

(sequence)

The sequence of items below is mandatory. A single instance is required.

SupplyPointCode

SupplyPointCode is mandatory. A single instance is required.

Identification of the supply point. A code used to identify a SupplyPoint belonging to a LocationParty.

SupplyPointDescription

SupplyPointDescription is optional. Multiple instances might exist.

A free form description of a SupplyPoint.

MapCoordinates

MapCoordinates is optional. Multiple instances might exist.

A group item defining and containing position co-ordinates of a location.

SupplyPointCode

Identification of the supply point. A code used to identify a SupplyPoint belonging to a LocationParty.

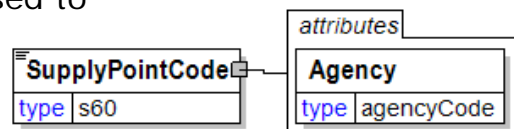

Agency [attribute]

Agency is mandatory. A single instance is required.

Describes the agency maintaining the list of codes. To be included in this list the agency must be a recognized standards body or industry organisation.

For the element that owns this attribute.

For another attribute in the list of attributes associated with the parent element.

Refer to Agency definition for any enumerations.

SupplyPointDescription

A free form description of a SupplyPoint.

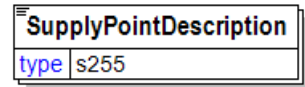

Surface

SurfaceType [attribute]

SurfaceType is optional. A single instance might exist.

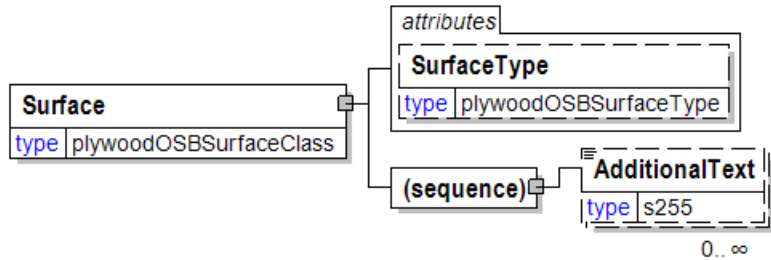

Refer to SurfaceType definition for any enumerations.

(sequence)

The sequence of items below is mandatory. A single instance is required.

AdditionalText

AdditionalText is optional. Multiple instances might exist.

A text field that is used to communicate information not previously defined or for special instructions. To be used only for circumstances not covered by specific elements.

SurfaceStrength

Surface Strength

TestMethod [attribute]

TestMethod is optional. A single instance might exist.

The method used to determine the results of the test under consideration.

TestAgency [attribute]

TestAgency is optional. A single instance might exist.

The agency that has set the parameters for the testing

Refer to TestAgency definition for any enumerations.

SampleType [attribute]

SampleType is optional. A single instance might exist.

Communicates how sampling was done to measure the product characteristics.

Refer to SampleType definition for any enumerations.

ResultSource [attribute]

ResultSource is optional. A single instance might exist.

Used to define the data source of the specified test

Refer to ResultSource definition for any enumerations.

(sequence)

The sequence of items below is mandatory. A single instance is required.

DetailValue

DetailValue is mandatory. A single instance is required.

A numeric value expressed in the unit of measure (UOM).

DetailRangeMin

DetailRangeMin is optional. A single instance might exist.

The minimum value (lower boundary) allowed for the DetailValue that is the parent of this element.

DetailRangeMax

DetailRangeMax is optional. A single instance might exist.

The maximum value (upper boundary) allowed for the DetailValue that is the parent of this element.

StandardDeviation

StandardDeviation is optional. A single instance might exist.

A statistic used as a measure of dispersion in a distribution.

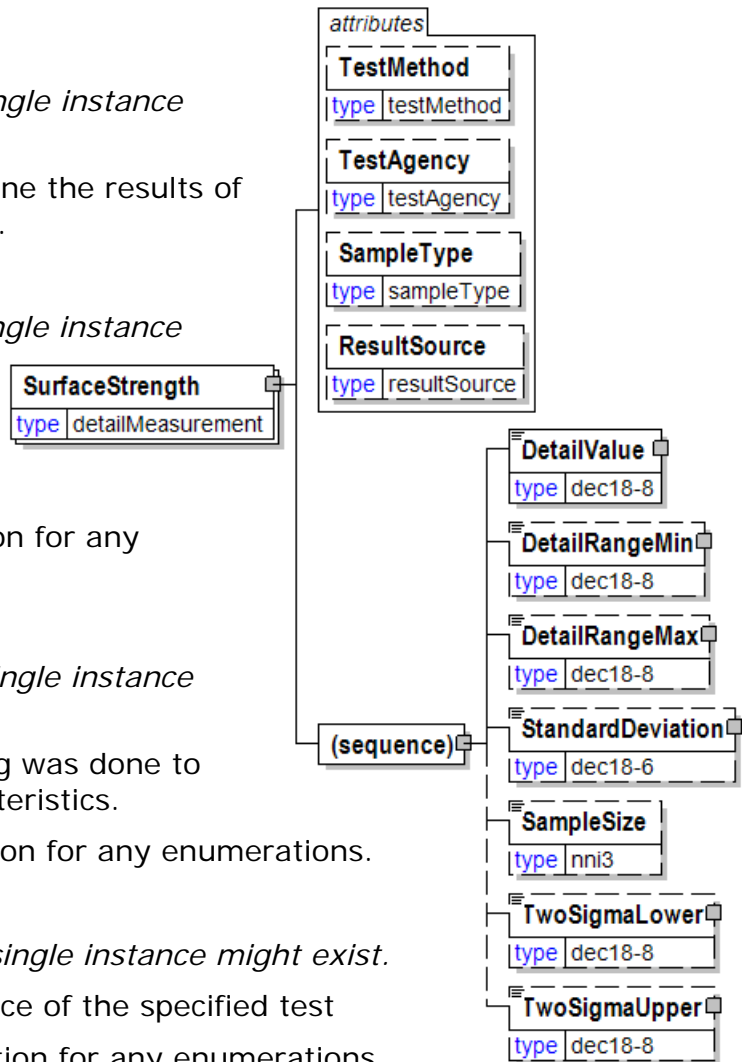

SampleSize

SampleSize is optional. A single instance might exist.

The number of samples used to determine the product characteristic in question.

TwoSigmaLower

TwoSigmaLower is optional. A single instance might exist.

Two sigma (a measure of dispersion associated with standard deviation) on the lower side of the standard deviation.

TwoSigmaUpper

TwoSigmaUpper is optional. A single instance might exist.

Two sigma (a measure of dispersion associated with standard deviation) on the upper side of the standard deviation.

SurfaceType [attribute]

This item is restricted to the following list.

Oiled

PluggedAndTouchSanded

Rough

RoughSawn

S1S

Side one sanded.

S2S

Side two sanded.

Sanded

ScratchSanded

Smooth

TouchSanded

Unsanded

attribute
SurfaceType
type plywoodOSBSurfaceType

Tabs [attribute]

The type of tabs

This item is restricted to the following list.

In

Out

None

attribute
Tabs
type tabs

TambourID

The unique identifier of the jumbo reel (also called mother reel or Tambour).

TambourID	
type	s20

TapeDescription

Tape description

TapeDescription	
type	string

TargetMoisture

The moisture target for the product being specified.

(sequence)

The sequence of items below is mandatory. A single instance is required.

Value

Value is mandatory. A single instance is required.

A numeric value expressed in the unit of measure (UOM).

RangeMin

RangeMin is optional. A single instance might exist.

The minimum value (lower boundary) allowed for the Measurement that is the parent of this element.

RangeMax

RangeMax is optional. A single instance might exist.

The maximum value (upper boundary) allowed for the Measurement that is the parent of this element. Some elements use the RangeMax element with an extended list of unit of measures. (Note: the red colour in the picture is an artifact of how the graphic was captured and should be disregarded.)

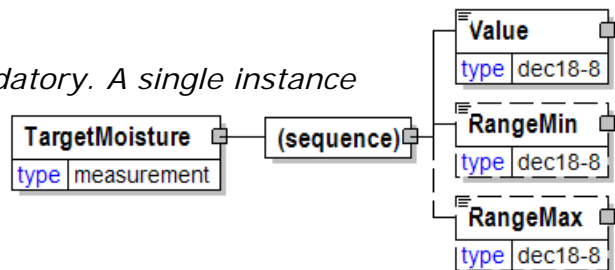

TargetProductWeight

The desired weight of the finished product.

(sequence)

The sequence of items below is mandatory. A single instance is required.

Value

Value is mandatory. A single instance is required.

A numeric value expressed in the unit of measure (UOM).

RangeMin

RangeMin is optional. A single instance might exist.

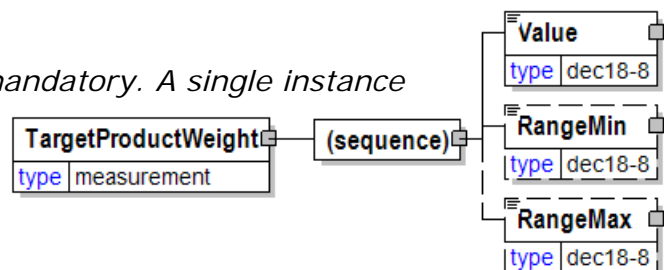

papiNet V2R31

The minimum value (lower boundary) allowed for the Measurement that is the parent of this element.

RangeMax

RangeMax is optional. A single instance might exist.

The maximum value (upper boundary) allowed for the Measurement that is the parent of this element. Some elements use the RangeMax element with an extended list of unit of measures. (Note: the red colour in the picture is an artifact of how the graphic was captured and should be disregarded.)

TargetSolidsContent

The target amount of solids for the slurry being produced.

(sequence)

The sequence of items below is mandatory. A single instance is required.

Value

Value is mandatory. A single instance is required.

A numeric value expressed in the unit of measure (UOM).

RangeMin

RangeMin is optional. A single instance might exist.

The minimum value (lower boundary) allowed for the Measurement that is the parent of this element.

RangeMax

RangeMax is optional. A single instance might exist.

The maximum value (upper boundary) allowed for the Measurement that is the parent of this element. Some elements use the RangeMax element with an extended list of unit of measures. (Note: the red colour in the picture is an artifact of how the graphic was captured and should be disregarded.)

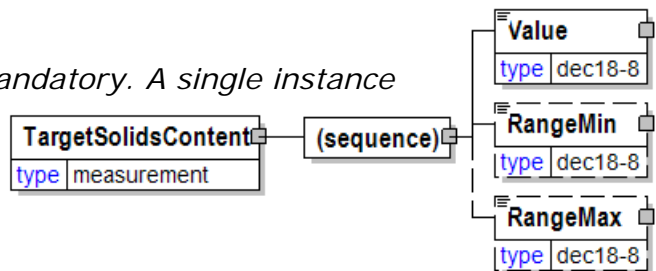

TaxAdjustment

This content element contains the necessary information to describe, calculate, and handle a tax adjustment.

TaxCategoryType [attribute]

TaxCategoryType is optional. A single instance might exist.

Used to indicate if the tax is applicable

Refer to TaxCategoryType definition for any enumerations.

TaxType [attribute]

TaxType is mandatory. A single instance is required.

Refer to TaxType definition for any enumerations.

(sequence)

The sequence of items below is mandatory. A single instance is required.

TaxPercent

TaxPercent is optional. A single instance might exist.

The fixed tax percentage to be applied according to specific tax regulations.

The fixed tax percentage to be applied according to specific tax regulations. If the TaxCategoryType is "Zero" and there is a non-zero value in this element, the e-Document can be rejected by the receiver.

TaxAmount

TaxAmount is optional. A single instance might exist.

The monetary amount expressed in the currency of the tax applied. For the MonetaryAdjustmentLine the TaxAmount is equal to the TaxPercent multiplied by the MonetaryAdjustmentStartAmount.

TaxLocation

TaxLocation is mandatory. A single instance is required.

The location used to determine the tax. Can be a country, state, province, or city. Depends on the tax type and on buyer or ship-to location.

InformationalAmount

InformationalAmount is optional. Multiple instances might exist.

A monetary amount used for information purposes only (not for calculation). For example, the invoice price adjustment subtotal is expressed in sterling pounds, and the buyer wants this information expressed in U.S. dollars.

CreditDebitNote and Invoice - The TaxAmount is displayed in the currency that is applicable throughout the e-Document. When a TaxAmount needs to be displayed in a different national currency, this field is used.

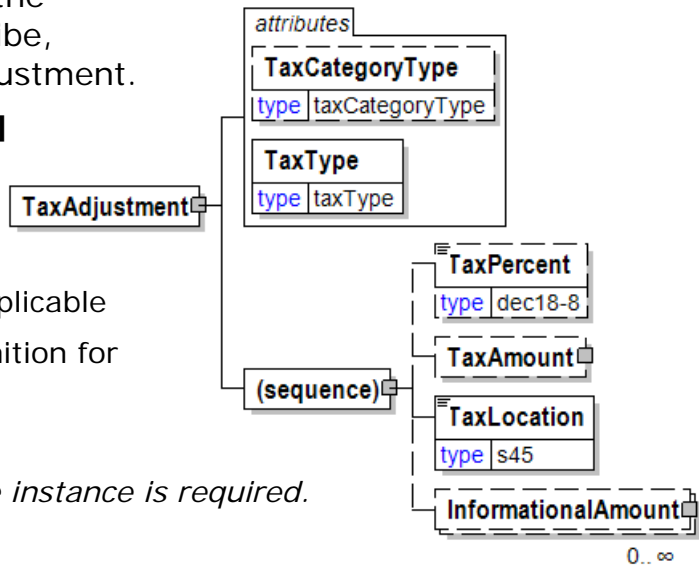

TaxAmount

The monetary amount expressed in the currency of the tax applied. For the MonetaryAdjustmentLine the TaxAmount is equal to the TaxPercent multiplied by the MonetaryAdjustmentStartAmount.

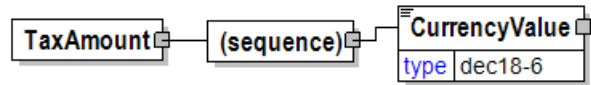

(sequence)

The sequence of items below is mandatory. A single instance is required.

CurrencyValue

CurrencyValue is mandatory. A single instance is required.

The amount in the referenced currency as defined by the CurrencyType attribute.

TaxCategoryType [attribute]

Used to indicate if the tax is applicable

This item is restricted to the following list.

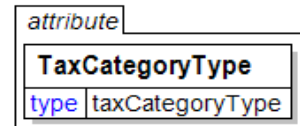

Exempt

Used when the party or product in question is tax exempt. For example, an item would not be taxed on the invoice because the buyer is tax exempt. Note: In this case, the TaxIdentifier of that party must be given in the PartyIdentifierType.

Standard

The tax is applicable in a standard manner.

Zero

The tax related to a specific product is zero. This tax exemption is country specific. For example, newspapers are tax free in Belgium.

Other

Used for any other tax category that is not covered by this list.

TaxLocation

The location used to determine the tax. Can be a country, state, province, or city. Depends on the tax type and on buyer or ship-to location.

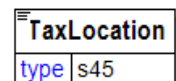

TaxPercent

The fixed tax percentage to be applied according to specific tax regulations.

The fixed tax percentage to be applied according to specific tax regulations. If the TaxCategoryType is "Zero" and there is a non-zero value in this element, the e-Document can be rejected by the

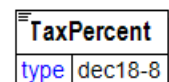

receiver.

TaxStatement

A group element for declaration of exception from normal charges of tax and the reason for tax exemption.

(sequence)

The sequence of items

below is mandatory. A single instance is required.

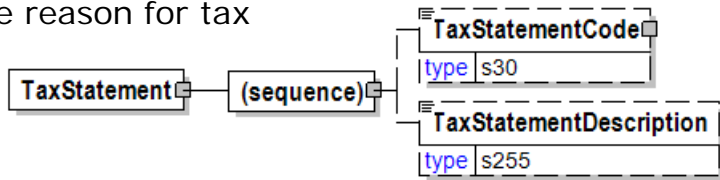

TaxStatementCode

TaxStatementCode is optional. A single instance might exist.

A code defining exception from normal charges of tax and the reason for tax exemption.

TaxStatementDescription

TaxStatementDescription is optional. A single instance might exist.

Free-form text used to define the reason for tax exemption.

TaxStatementCode

A code defining exception from normal charges of tax and the reason for tax exemption.

Agency [attribute]

Agency is mandatory. A single instance is required.

Describes the agency maintaining the list of codes. To be included in this list the agency must be a recognized standards body or industry organisation.

For the element that owns this attribute.

For another attribute in the list of attributes associated with the parent element.

Refer to Agency definition for any enumerations.

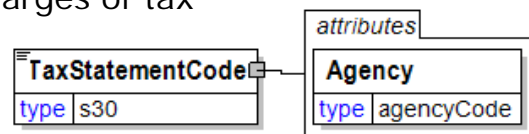

TaxStatementDescription

Free-form text used to define the reason for tax exemption.



TaxType [attribute]

This item is restricted to the following list.

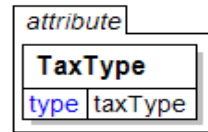

Federal

The federal government tax.

GST

The goods and services tax.

Harmonised

A group of taxes have been put together to form one tax rate. For example, Harmonised = provincial/state + federal.

Local

A local tax, such as a country-specific tax.

StateOrProvincial

The local government tax.

VAT

The value-added tax.

TEA

Tensile Energy Absorption.

TestMethod [attribute]

TestMethod is optional. A single instance might exist.

The method used to determine the results of the test under consideration.

TestAgency [attribute]

TestAgency is optional. A single instance might exist.

The agency that has set the parameters for the testing

Refer to TestAgency definition for any enumerations.

SampleType [attribute]

SampleType is optional. A single instance might exist.

Communicates how sampling was done to measure the product characteristics.

Refer to SampleType definition for any enumerations.

ResultSource [attribute]

ResultSource is optional. A single instance might exist.

Used to define the data source of the specified test

Refer to ResultSource definition for any enumerations.

(sequence)

The sequence of items below is mandatory. A single instance is required.

DetailValue

DetailValue is mandatory. A single instance is required.

A numeric value expressed in the unit of measure (UOM).

DetailRangeMin

DetailRangeMin is optional. A single instance might exist.

The minimum value (lower boundary) allowed for the DetailValue that is the parent of this element.

DetailRangeMax

DetailRangeMax is optional. A single instance might exist.

The maximum value (upper boundary) allowed for the DetailValue that is the parent of this element.

StandardDeviation

StandardDeviation is optional. A single instance might exist.

A statistic used as a measure of dispersion in a distribution.

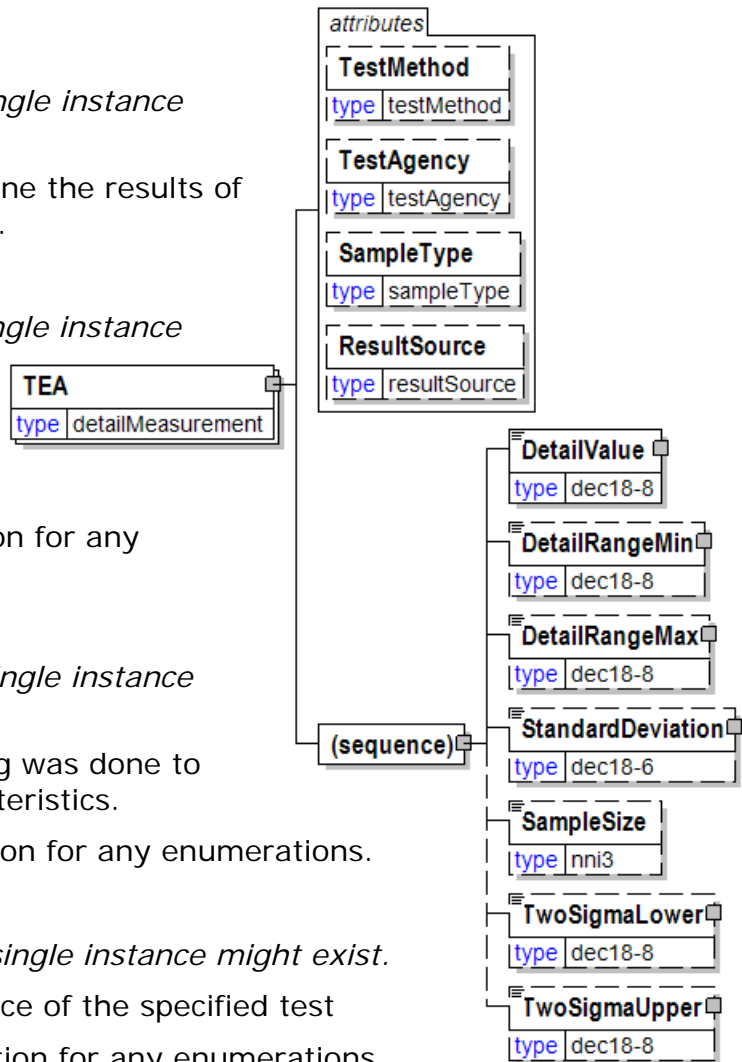

SampleSize

SampleSize is optional. A single instance might exist.

The number of samples used to determine the product characteristic in question.

TwoSigmaLower

TwoSigmaLower is optional. A single instance might exist.

Two sigma (a measure of dispersion associated with standard deviation) on the lower side of the standard deviation.

TwoSigmaUpper

TwoSigmaUpper is optional. A single instance might exist.

Two sigma (a measure of dispersion associated with standard deviation) on the upper side of the standard deviation.

Tear

A group item used to communicate tearing resistance target or test value according to a particular TestMethod.

TestMethod [attribute]

TestMethod is optional. A single instance might exist.

The method used to determine the results of the test under consideration.

TestAgency [attribute]

TestAgency is optional. A single instance might exist.

The agency that has set the parameters for the testing

Refer to TestAgency definition for any enumerations.

SampleType [attribute]

SampleType is optional. A single instance might exist.

Communicates how sampling was done to measure the product characteristics.

Refer to SampleType definition for any enumerations.

ResultSource [attribute]

ResultSource is optional. A single instance might exist.

Used to define the data source of the specified test

Refer to ResultSource definition for any enumerations.

(sequence)

The sequence of items below is mandatory. A single instance is required.

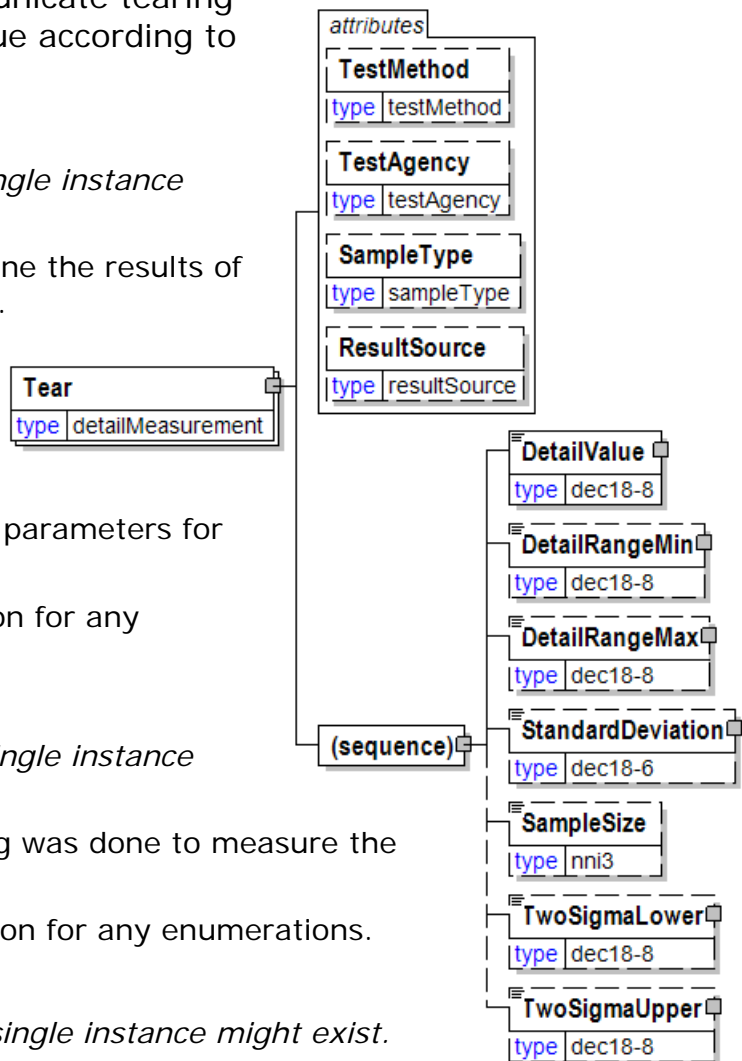

DetailValue

DetailValue is mandatory. A single instance is required.

A numeric value expressed in the unit of measure (UOM).

DetailRangeMin

DetailRangeMin is optional. A single instance might exist.

The minimum value (lower boundary) allowed for the DetailValue that is the parent of this element.

DetailRangeMax

DetailRangeMax is optional. A single instance might exist.

The maximum value (upper boundary) allowed for the DetailValue that is the parent of this element.

StandardDeviation

StandardDeviation is optional. A single instance might exist.

A statistic used as a measure of dispersion in a distribution.

SampleSize

SampleSize is optional. A single instance might exist.

The number of samples used to determine the product characteristic in question.

TwoSigmaLower

TwoSigmaLower is optional. A single instance might exist.

Two sigma (a measure of dispersion associated with standard deviation) on the lower side of the standard deviation.

TwoSigmaUpper

TwoSigmaUpper is optional. A single instance might exist.

Two sigma (a measure of dispersion associated with standard deviation) on the upper side of the standard deviation.

TearIndex

TearIndex

TestMethod [attribute]

TestMethod is optional. A single instance might exist.

The method used to determine the results of the test under consideration.

TestAgency [attribute]

TestAgency is optional. A single instance might exist.

The agency that has set the parameters for the testing

Refer to TestAgency definition for any enumerations.

SampleType [attribute]

SampleType is optional. A single instance might exist.

Communicates how sampling was done to measure the product characteristics.

Refer to SampleType definition for any enumerations.

ResultSource [attribute]

ResultSource is optional. A single instance might exist.

Used to define the data source of the specified test

Refer to ResultSource definition for any enumerations.

(sequence)

The sequence of items below is mandatory. A single instance is required.

DetailValue

DetailValue is mandatory. A single instance is required.

A numeric value expressed in the unit of measure (UOM).

DetailRangeMin

DetailRangeMin is optional. A single instance might exist.

The minimum value (lower boundary) allowed for the DetailValue that is the parent of this element.

DetailRangeMax

DetailRangeMax is optional. A single instance might exist.

The maximum value (upper boundary) allowed for the DetailValue that is the parent of this element.

StandardDeviation

StandardDeviation is optional. A single instance might exist.

A statistic used as a measure of dispersion in a distribution.

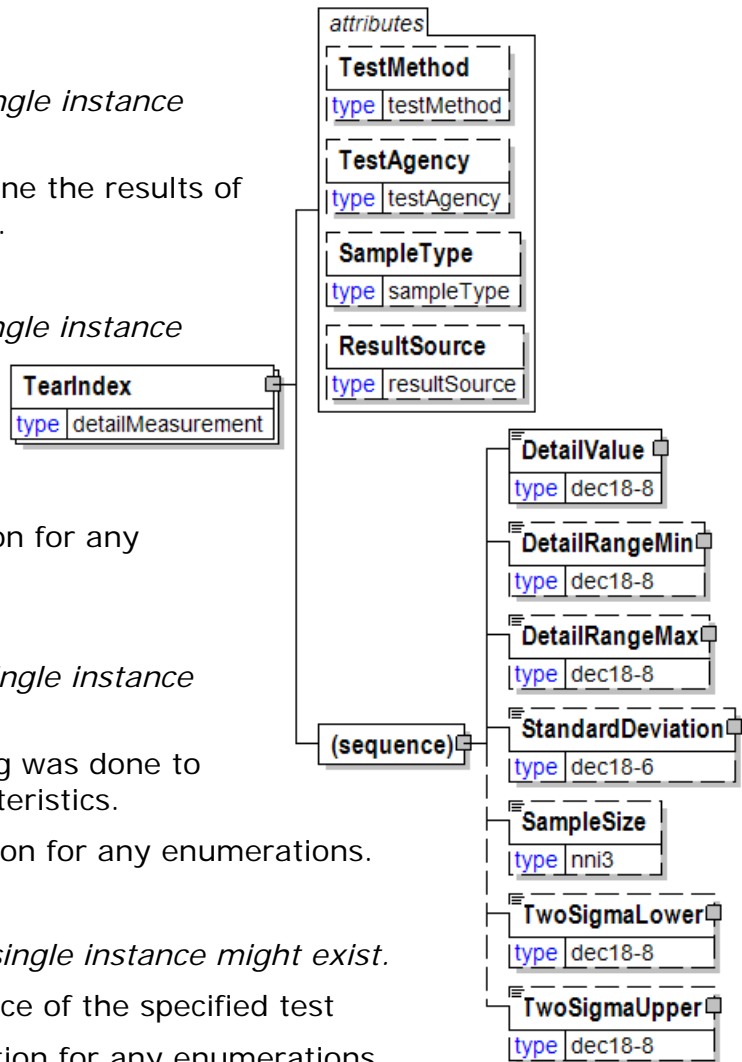

SampleSize

SampleSize is optional. A single instance might exist.

The number of samples used to determine the product characteristic in question.

TwoSigmaLower

TwoSigmaLower is optional. A single instance might exist.

Two sigma (a measure of dispersion associated with standard deviation) on the lower side of the standard deviation.

TwoSigmaUpper

TwoSigmaUpper is optional. A single instance might exist.

Two sigma (a measure of dispersion associated with standard deviation) on the upper side of the standard deviation.

TearStripType [attribute]

Tear Strip Type

This item is restricted to the following list.

Clear

The tear strip is clear.

Gold

The tear strip is gold coloured.

Red

The tear strip is red coloured.

Other

Another colour is used.

attribute
TearStripType
type tearStripType

Telephone

The business phone number of the individual associated with the ContactName.

Telephone
type phoneNumber

Tensile

A group item used to communicate zero-span tensile strength target or test value according to a particular TestMethod.

TestMethod [attribute]

TestMethod is optional. A single instance might exist.

The method used to determine the results of the test under consideration.

TestAgency [attribute]

TestAgency is optional. A single instance might exist.

The agency that has set the parameters for the testing

Refer to TestAgency definition for any enumerations.

SampleType [attribute]

SampleType is optional. A single instance might exist.

Communicates how sampling was done to measure the product characteristics.

Refer to SampleType definition for any enumerations.

ResultSource [attribute]

ResultSource is optional. A single instance might exist.

Used to define the data source of the specified test

Refer to ResultSource definition for any enumerations.

(sequence)

The sequence of items below is mandatory. A single instance is required.

DetailValue

DetailValue is mandatory. A single instance is required.

A numeric value expressed in the unit of measure (UOM).

DetailRangeMin

DetailRangeMin is optional. A single instance might exist.

The minimum value (lower boundary) allowed for the DetailValue that is the parent of this element.

DetailRangeMax

DetailRangeMax is optional. A single instance might exist.

The maximum value (upper boundary) allowed for the DetailValue that is the parent of this element.

StandardDeviation

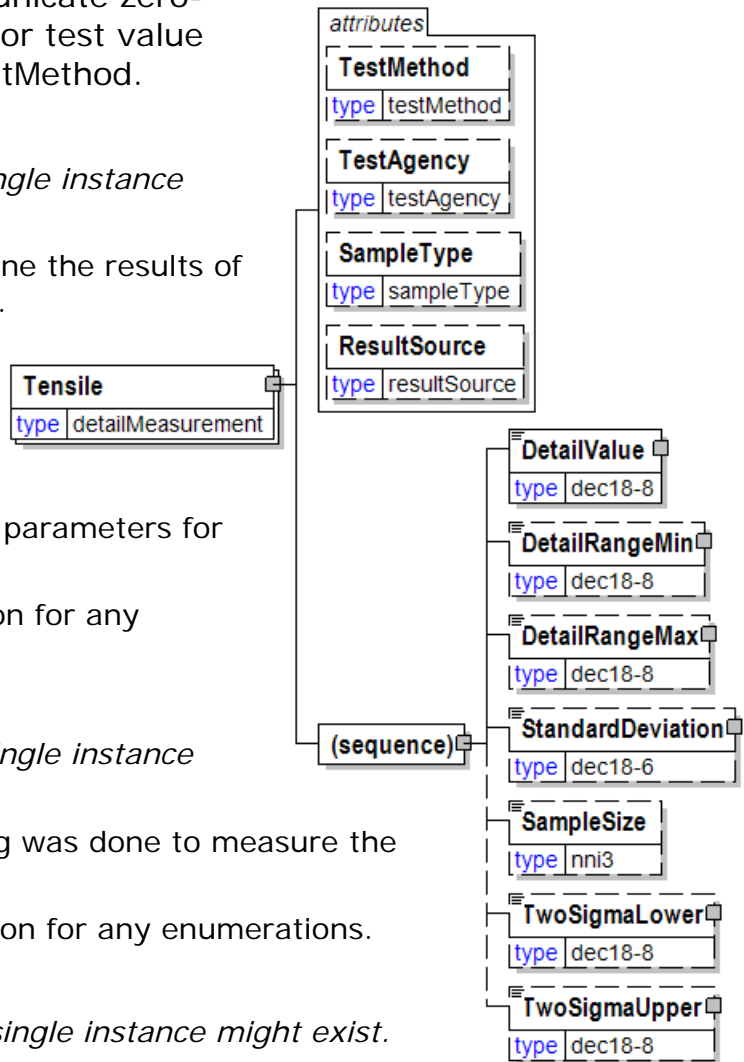

papiNet V2R31

StandardDeviation is optional. A single instance might exist.

A statistic used as a measure of dispersion in a distribution.

SampleSize

SampleSize is optional. A single instance might exist.

The number of samples used to determine the product characteristic in question.

TwoSigmaLower

TwoSigmaLower is optional. A single instance might exist.

Two sigma (a measure of dispersion associated with standard deviation) on the lower side of the standard deviation.

TwoSigmaUpper

TwoSigmaUpper is optional. A single instance might exist.

Two sigma (a measure of dispersion associated with standard deviation) on the upper side of the standard deviation.

TensileIndex

Tensile Index

TestMethod [attribute]

TestMethod is optional. A single instance might exist.

The method used to determine the results of the test under consideration.

TestAgency [attribute]

TestAgency is optional. A single instance might exist.

The agency that has set the parameters for the testing

Refer to TestAgency definition for any enumerations.

SampleType [attribute]

SampleType is optional. A single instance might exist.

Communicates how sampling was done to measure the product characteristics.

Refer to SampleType definition for any enumerations.

ResultSource [attribute]

ResultSource is optional. A single instance might exist.

Used to define the data source of the specified test

Refer to ResultSource definition for any enumerations.

(sequence)

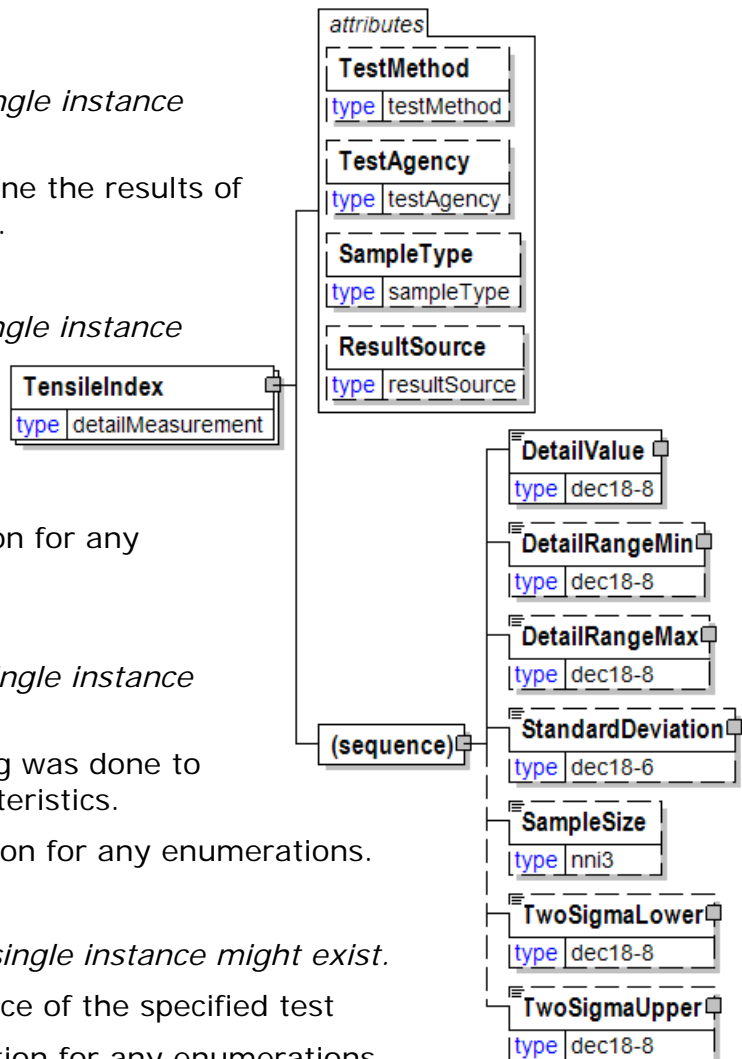

papiNet V2R31

The sequence of items below is mandatory. A single instance is required.

DetailValue

DetailValue is mandatory. A single instance is required.

A numeric value expressed in the unit of measure (UOM).

DetailRangeMin

DetailRangeMin is optional. A single instance might exist.

The minimum value (lower boundary) allowed for the DetailValue that is the parent of this element.

DetailRangeMax

DetailRangeMax is optional. A single instance might exist.

The maximum value (upper boundary) allowed for the DetailValue that is the parent of this element.

StandardDeviation

StandardDeviation is optional. A single instance might exist.

A statistic used as a measure of dispersion in a distribution.

SampleSize

SampleSize is optional. A single instance might exist.

The number of samples used to determine the product characteristic in question.

TwoSigmaLower

TwoSigmaLower is optional. A single instance might exist.

Two sigma (a measure of dispersion associated with standard deviation) on the lower side of the standard deviation.

TwoSigmaUpper

TwoSigmaUpper is optional. A single instance might exist.

Two sigma (a measure of dispersion associated with standard deviation) on the upper side of the standard deviation.

Tension

Tension of the web on the printing press.

(sequence)

The sequence of items below is mandatory. A single instance is required.

Value

Value is mandatory. A single instance is required.

A numeric value expressed in the unit of measure (UOM).

RangeMin

RangeMin is optional. A single instance might exist.

The minimum value (lower boundary) allowed for the Measurement that is the parent of this element.

RangeMax

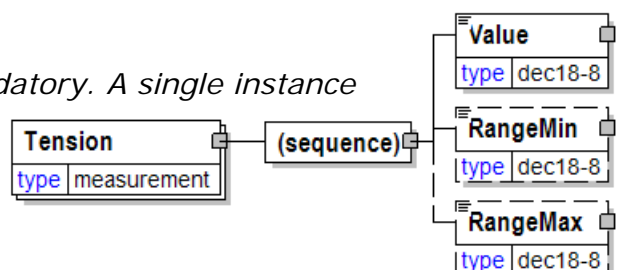

RangeMax is optional. A single instance might exist.

The maximum value (upper boundary) allowed for the Measurement that is the parent of this element. Some elements use the RangeMax element with an extended list of unit of measures. (Note: the red colour in the picture is an artifact of how the graphic was captured and should be disregarded.)

TermsAndDisclaimers

An element that contains legal information with an indication of what the Language is.

Language [attribute]

Language is optional. A single instance might exist.

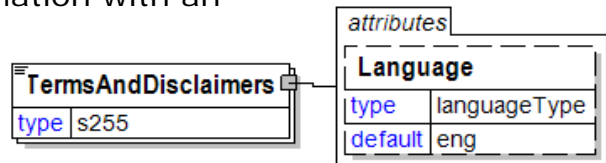

XML has embraced 2 and 3 digit language codes through the application of an addendum to the standard.

Refer to Language definition for any enumerations.

TermsBasisDate

The Date and Time on which the terms-of-payment calculations are based.

(sequence)

The sequence of items below is mandatory. A single instance is required.

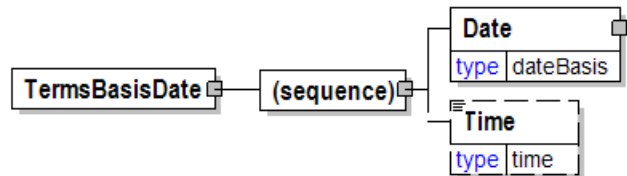

Date

Date is mandatory. A single instance is required.

A group element that contains the specification of Year, Month, and Day.

Time

Time is optional. A single instance might exist.

Times are treated in a standard XML fashion with a special case used to indicate a generalized "local" time. The standard XML approach to time is hh:mm:ss, hh:mm:ssZ, or hh:mm:ss±hh:mm.

hh:mm:ss±hh:mm is used to represent a time with a time zone. The time zone is communicated as the number of hours offset from the Universal Time Coordinate (UTC), a.k.a. Greenwich Mean Time.

hh:mm:ssZ indicates the time at Zulu (another name for UTC). Based on the convention described in the next bullet it will be important for users within UTC to use "Z" when communicating a time in their time zone to other users.

hh:mm:ss or hh:mm indicates in the XML standard the time at UTC however, within papiNet it is used to represent the applicable local time. Caution should be used when processing times of this nature as the papiNet approach may be in discord with other users of XML.

TermsBasisDateType [attribute]

Indicates what date is being used as the terms basis.

This item is restricted to the following list.

attribute	
TermsBasisDateType	
type	dateTypeTermsBasis

BillOfLadingDate

The date of the Bill of Lading.

DefferedOrInstallmentDate

The date of the installment.

DeliveryDate

The date the delivery was made or received.

DespatchDate

The date the delivery was initiated.

EndOfDeliveryMonth

The end of the month during which delivery took place.

EndOfDespatchMonth

The end of the month during which despatch took place.

EndOfInvoiceMonth

The end of the month during which invoicing took place.

EndOfMonth

The end of the month.

EstimatedTimeOfArrival

Terms are based on the estimated time of arrival that exists when the terms are defined.

EstimatedTimeOfDeparture

Terms are based on the estimated time of departure.

ExtendedDate

FixedDate

The terms specify a fixed date.

FollowingMonthDate

InstantDate

InvoiceDate

A date that is qualifying the invoicing period. This date often drives payment terms. Note that this date is not necessarily the same as the issue date of the invoice.

InvoiceReceiptDate

The date the invoice was received.

InvoiceTransmissionDate

The date the invoice was transmitted.

LetterOfCreditExpirationDate

The date the letter of credit expires.

NnDaysAfterEndOfMonthDate

The date a fixed number of days after the end of the month.

OrderConfirmationDate

The date the PurchaseOrder was confirmed with a status of "Accepted".

ProxDate

Proximo Date

PurchaseOrderDate

The date of the PurchaseOrder.

ReceivedDate

The date product was received.

ShipDate

The date product was shipped.

TermsDescription

A textual description of the terms of payment.

TermsDescription	
type	s255

TermsDiscountDaysDue

The number of days during which the customer is allowed to deduct cash discounts from the date of TermsBasisDate.

TermsDiscountDaysDue	
type	nni3

TermsDiscountDueDate

The latest Date and Time on which the terms discount is still applicable.

(sequence)

The sequence of items below is mandatory. A single instance is required.

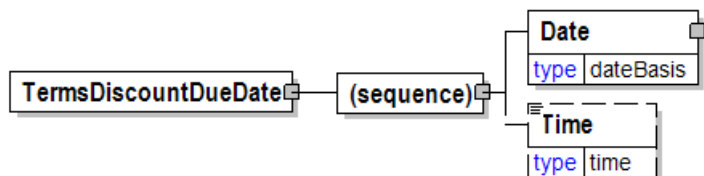

Date

Date is mandatory. A single instance is required.

A group element that contains the specification of Year, Month, and Day.

Time

Time is optional. A single instance might exist.

Times are treated in a standard XML fashion with a special case used to indicate a generalized "local" time. The standard XML approach to time is hh:mm:ss,

papiNet V2R31

hh:mm:ssZ, or hh:mm:ss±hh:mm.

hh:mm:ss±hh:mm is used to represent a time with a time zone. The time zone is communicated as the number of hours offset from the Universal Time Coordinate (UTC), a.k.a. Greenwich Mean Time.

hh:mm:ssZ indicates the time at Zulu (another name for UTC). Based on the convention described in the next bullet it will be important for users within UTC to use "Z" when communicating a time in their time zone to other users.

hh:mm:ss or hh:mm indicates in the XML standard the time at UTC however, within papiNet it is used to represent the applicable local time. Caution should be used when processing times of this nature as the papiNet approach may be in discord with other users of XML.

TermsDiscountPercent

The percentage taken away from the invoice line items; a result of the terms of payment.

(sequence)

The sequence of items below is mandatory. A single instance is required.

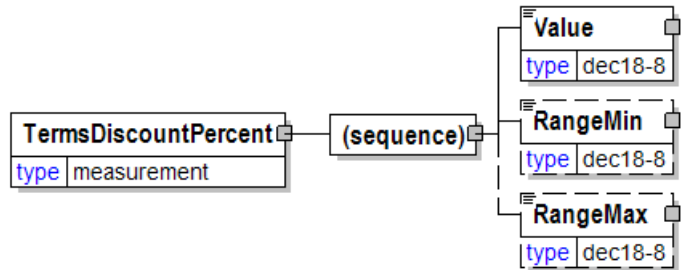

Value

Value is mandatory. A single instance is required.

A numeric value expressed in the unit of measure (UOM).

RangeMin

RangeMin is optional. A single instance might exist.

The minimum value (lower boundary) allowed for the Measurement that is the parent of this element.

RangeMax

RangeMax is optional. A single instance might exist.

The maximum value (upper boundary) allowed for the Measurement that is the parent of this element. Some elements use the RangeMax element with an extended list of unit of measures. (Note: the red colour in the picture is an artifact of how the graphic was captured and should be disregarded.)

TermsInformation

An element that contains the term related information.

(sequence)

The sequence of items below is mandatory. A single instance is required.

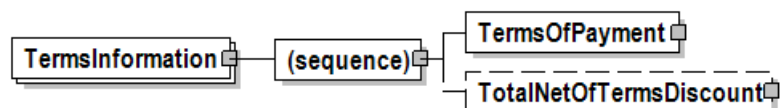

TermsOfPayment

TermsOfPayment is mandatory. A single instance is required.

A group item that contains agreed-to terms defining when, how, and under what

conditions the payment is to be made.

When TermsOfPayment is optional; if omitted, TermsOfPayment is controlled through previous negotiation.

TotalNetOfTermsDiscount

TotalNetOfTermsDiscount is optional. A single instance might exist.

The components of the amount to be paid if prompt payment discount terms are met, including the amount that is subject to the payment terms discount, the discount amount, and the amount due after prompt payment discount.

TermsInterestPenaltyPercent

The penalty associated with not meeting the terms discount parameters.

TermsInterestPenaltyPercent	
type	dec18-6

TermsNetDaysDue

The number of days until the full invoice amount is due on the seller's account without a discount applied.

TermsNetDaysDue	
type	nni3

TermsNetDueDate

The latest Date and Time on which the full invoice amount is due on the seller's account without a discount applied.

(sequence)

The sequence of items below is mandatory. A single instance is required.

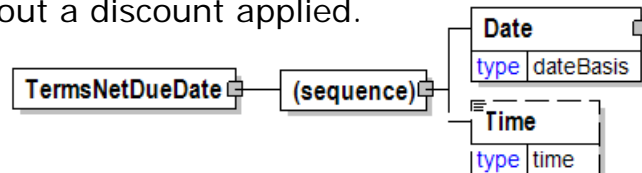

Date

Date is mandatory. A single instance is required.

A group element that contains the specification of Year, Month, and Day.

Time

Time is optional. A single instance might exist.

Times are treated in a standard XML fashion with a special case used to indicate a generalized "local" time. The standard XML approach to time is hh:mm:ss, hh:mm:ssZ, or hh:mm:ss±hh:mm.

hh:mm:ss±hh:mm is used to represent a time with a time zone. The time zone is communicated as the number of hours offset from the Universal Time Coordinate (UTC), a.k.a. Greenwich Mean Time.

hh:mm:ssZ indicates the time at Zulu (another name for UTC). Based on the convention described in the next bullet it will be important for users within UTC to use "Z" when communicating a time in their time zone to other users.

hh:mm:ss or hh:mm indicates in the XML standard the time at UTC however, within papiNet it is used to represent the applicable local time. Caution should be used when processing times of this nature as the papiNet approach may be

in discord with other users of XML.

TermsOfChartering

The terms of the vessel chartering. There are multiple types of TermsOfChartering that need to be specified. E.g.: Loading Terms and Unloading Terms

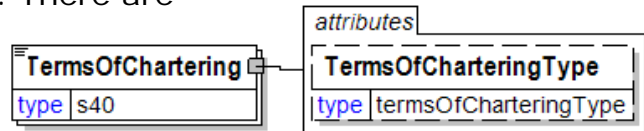

TermsOfCharteringType [attribute]

TermsOfCharteringType is optional. A single instance might exist.

Terms of chartering type.

Refer to TermsOfCharteringType definition for any enumerations.

TermsOfCharteringType [attribute]

Terms of chartering type.

This item is restricted to the following list.

Loading

The charter terms apply to loading.

Unloading

The charter terms apply to unloading.

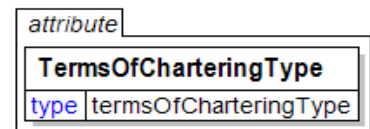

TermsOfDelivery

A group item defining the terms under which the delivery of goods will take place. These terms determine when and under what conditions the transfer of ownership will occur. Generally speaking, the Incoterms are primarily used in Europe, whereas the

ShipmentMethodOfPayment is primarily used in North America.

(sequence)

The sequence of items below is mandatory. A single instance is required.

(choice)

[choice] is optional because of choice construct.

IncotermsLocation

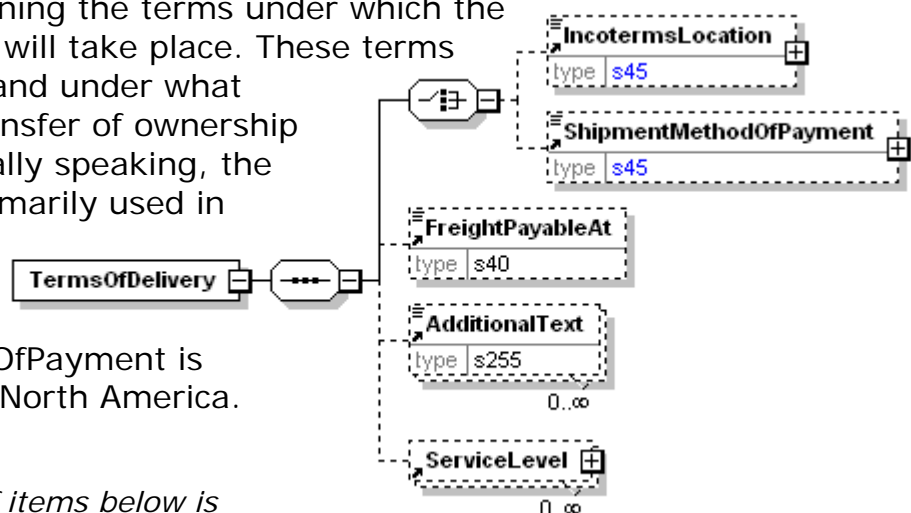

IncotermsLocation is optional because of choice construct.

Place linked to terms of delivery showing the place where goods are to be delivered.

ShipmentMethodOfPayment

ShipmentMethodOfPayment is optional because of choice construct.

An element communicating responsibility of freight payment and when transfer of ownership will occur.

FreightPayableAt

FreightPayableAt is optional. A single instance might exist.

The location at which freight charges are calculated.

AdditionalText

AdditionalText is optional. Multiple instances might exist.

A text field that is used to communicate information not previously defined or for special instructions. To be used only for circumstances not covered by specific elements.

ServiceLevel

ServiceLevel is optional. Multiple instances might exist.

A grouping element containing information about a service level. The service level can be specified in a Service Level Agreement (SLA) detailing requirements such as delivery, performance, pricing, quality, etc.

TermsOfPayment

A group item that contains agreed-to terms defining when, how, and under what conditions the payment is to be made.

When TermsOfPayment is optional; if omitted, TermsOfPayment is controlled through previous negotiation.

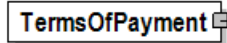

TermsBasisDateType [attribute]

TermsBasisDateType is optional. A single instance might exist.

Indicates what date is being used as the terms basis.

Refer to TermsBasisDateType definition for any enumerations.

(sequence)

The sequence of items below is mandatory. A single instance is required.

TermsOfPaymentCode

TermsOfPaymentCode is optional. A single instance might exist.

A code used as a shorthand representation for the TermsOfPayment. The Agency attribute is used to indicate the source of the code.

TermsDescription

TermsDescription is optional. A single instance might exist.

A textual description of the terms of payment.

TermsBasisDate

TermsBasisDate is optional. A single instance might exist.

The Date and Time on which the terms-of-payment calculations are based.

TermsDiscountPercent

TermsDiscountPercent is optional. A single instance might exist.

The percentage taken away from the invoice line items; a result of the terms of payment.

TermsDiscountDueDate

TermsDiscountDueDate is optional. A single instance might exist.

The latest Date and Time on which the terms discount is still applicable.

TermsDiscountDaysDue

TermsDiscountDaysDue is optional. A single instance might exist.

The number of days during which the customer is allowed to deduct cash discounts

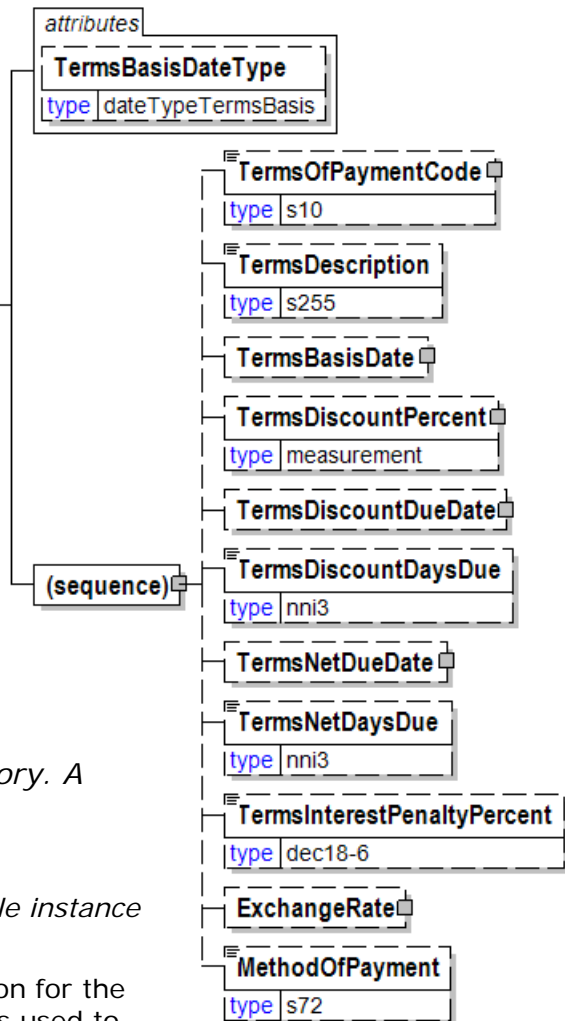

from the date of TermsBasisDate.

TermsNetDueDate

TermsNetDueDate is optional. A single instance might exist.

The latest Date and Time on which the full invoice amount is due on the seller's account without a discount applied.

TermsNetDaysDue

TermsNetDaysDue is optional. A single instance might exist.

The number of days until the full invoice amount is due on the seller's account without a discount applied.

TermsInterestPenaltyPercent

TermsInterestPenaltyPercent is optional. A single instance might exist.

The penalty associated with not meeting the terms discount parameters.

ExchangeRate

ExchangeRate is optional. A single instance might exist.

The exchange rate as of the date included in the element.

MethodOfPayment

MethodOfPayment is optional. A single instance might exist.

The manner in which payment is to be transmitted to the seller.

TermsOfPaymentCode

A code used as a shorthand representation for the TermsOfPayment. The Agency attribute is used to indicate the source of the code.

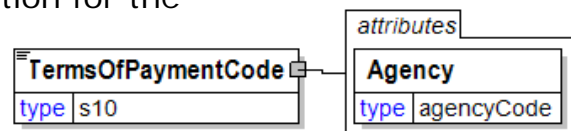

Agency [attribute]

Agency is mandatory. A single instance is required.

Describes the agency maintaining the list of codes. To be included in this list the agency must be a recognized standards body or industry organisation.

For the element that owns this attribute.

For another attribute in the list of attributes associated with the parent element.

Refer to Agency definition for any enumerations.

TestAgency [attribute]

The agency that has set the parameters for the testing
This item is restricted to the following list.

ASTM

American Society for Testing and Materials.

BS



British Standards.

CIE

Vienna-based Commission Internationale de l'Eclairage.

DuPont

DuPont.

EN

European standards organisation.

GE

General Electric

ImageXpert

ImageXpert.

ISO

International Organisation for Standardization.

NS-EN

Norwegian Standards, European Standards.

PAPTAC

Pulp and Paper Technical Association of Canada

SCAN-test

SFS-EN

SS-EN

TAPPI

Technical Association for the Pulp and Paper Industry

TestMethod [attribute]

The method used to determine the results of the test under consideration.

attribute
TestMethod
type testMethod

TextValue

A value in text format.

TextValue
type s72

Thickness

Physical dimension of a product.
The approach for thickness used in the timber/lumber related constructs.

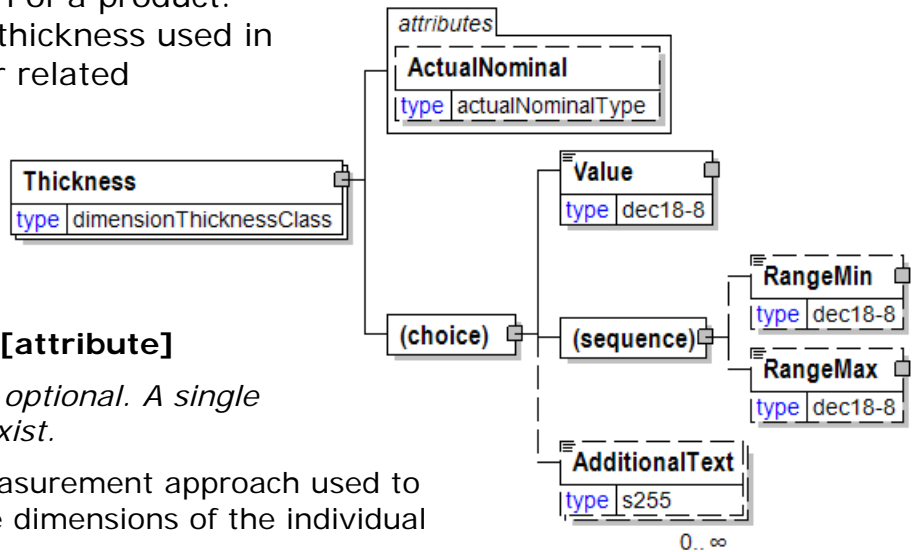

ActualNominal [attribute]

ActualNominal is optional. A single instance might exist.

Indicates the measurement approach used to communicate the dimensions of the individual pieces.

Refer to ActualNominal definition for any enumerations.

(choice)

[choice] is optional because of choice construct.

Value

Value is optional because of choice construct.

A numeric value expressed in the unit of measure (UOM).

(sequence)

The sequence of items below is mandatory. A single instance is required.

RangeMin

RangeMin is optional. A single instance might exist.

The minimum value (lower boundary) allowed for the Measurement that is the parent of this element.

RangeMax

RangeMax is optional. A single instance might exist.

The maximum value (upper boundary) allowed for the Measurement that is the parent of this element. Some elements use the RangeMax element with an extended list of unit of measures. (Note: the red colour in the picture is an artifact of how the graphic was captured and should be disregarded.)

AdditionalText

AdditionalText is optional because of choice construct.

A text field that is used to communicate information not previously defined or for special instructions. To be used only for circumstances not covered by specific elements.

Thickness

Physical dimension of a product.

(sequence)

The sequence of items below is mandatory. A single instance is required.

Value

Value is mandatory. A single instance is required.

A numeric value expressed in the unit of measure (UOM).

RangeMin

RangeMin is optional. A single instance might exist.

The minimum value (lower boundary) allowed for the Measurement that is the parent of this element.

RangeMax

RangeMax is optional. A single instance might exist.

The maximum value (upper boundary) allowed for the Measurement that is the parent of this element. Some elements use the RangeMax element with an extended list of unit of measures. (Note: the red colour in the picture is an artifact of how the graphic was captured and should be disregarded.)

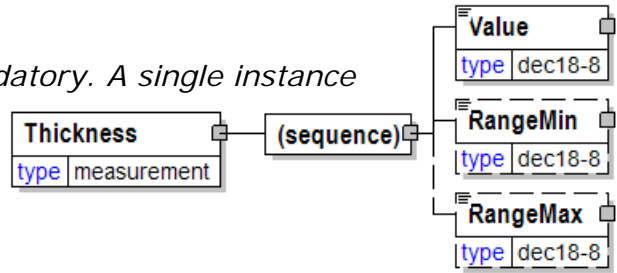

Thumb

Thumb.

Bleed [attribute]

Bleed is optional. A single instance might exist.

Specifies if the printing of an illustration, design, or text to the edge of the page.

Refer to Bleed definition for any enumerations.

(sequence)

The sequence of items below is mandatory. A single instance is required.

Value

Value is mandatory. A single instance is required.

A numeric value expressed in the unit of measure (UOM).

RangeMin

RangeMin is optional. A single instance might exist.

The minimum value (lower boundary) allowed for the Measurement that is the parent of this element.

RangeMax

RangeMax is optional. A single instance might exist.

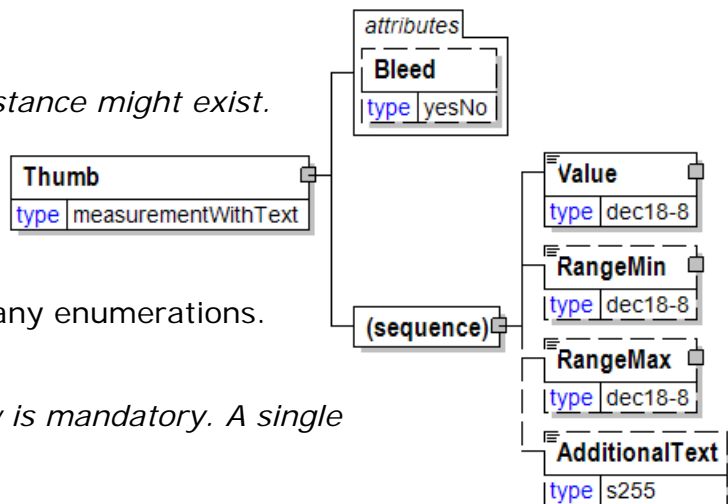

papiNet V2R31

The maximum value (upper boundary) allowed for the Measurement that is the parent of this element. Some elements use the RangeMax element with an extended list of unit of measures. (Note: the red colour in the picture is an artifact of how the graphic was captured and should be disregarded.)

AdditionalText

AdditionalText is optional. A single instance might exist.

A text field that is used to communicate information not previously defined or for special instructions. To be used only for circumstances not covered by specific elements.

TiersPerPallet

The number of tiers on the pallet, where a tier is a layer of items.

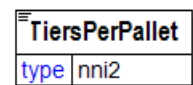

TimberCharacteristics

Timber characteristics

(sequence)

The sequence of items below is mandatory. A single instance is required.

LumberSpecies

LumberSpecies is mandatory. One instance is required, multiple instances might exist.

Specifies the raw material species.

Age

Age is optional. A single instance might exist.

Used to report the age of the wood.

Grade

Grade is optional. A single instance might exist.

Grade

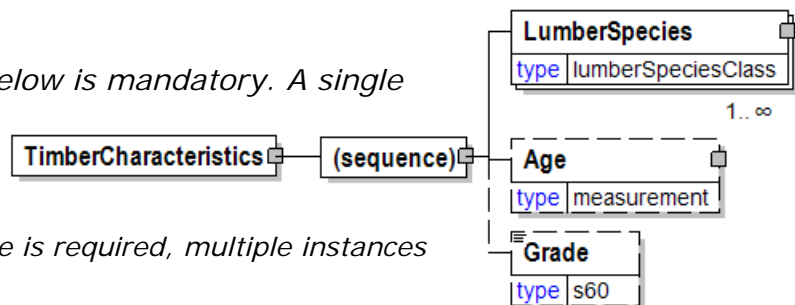

Time

Times are treated in a standard XML fashion with a special case used to indicate a generalized "local" time. The standard XML approach to time is hh:mm:ss, hh:mm:ssZ, or hh:mm:ss±hh:mm.

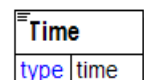

hh:mm:ss±hh:mm is used to represent a time with a time zone. The time zone is communicated as the number of hours offset from the Universal Time Coordinate (UTC), a.k.a. Greenwich Mean Time.

hh:mm:ssZ indicates the time at Zulu (another name for UTC). Based on the convention described in the next bullet it will be important for

users within UTC to use "Z" when communicating a time in their time zone to other users.

hh:mm:ss or hh:mm indicates in the XML standard the time at UTC however, within papiNet it is used to represent the applicable local time. Caution should be used when processing times of this nature as the papiNet approach may be in discord with other users of XML.

TimePeriod

The TimePeriod element is used to communicate a duration period of time as indicated in PeriodType.

PeriodType [attribute]

PeriodType is optional. A single instance might exist.

Duration of time

Refer to PeriodType definition for any enumerations.

(choice)

[choice] is optional because of choice construct.

(sequence)

The sequence of items below is mandatory. A single instance is required.

Date

Date is mandatory. A single instance is required.

A group element that contains the specification of Year, Month, and Day.

Time

Time is optional. A single instance might exist.

Times are treated in a standard XML fashion with a special case used to indicate a generalized "local" time. The standard XML approach to time is hh:mm:ss, hh:mm:ssZ, or hh:mm:ss±hh:mm.

hh:mm:ss±hh:mm is used to represent a time with a time zone. The time zone is communicated as the number of hours offset from the Universal Time Coordinate (UTC), a.k.a. Greenwich Mean Time.

hh:mm:ssZ indicates the time at Zulu (another name for UTC). Based on the convention described in the next bullet it will be important for users within UTC to use "Z" when communicating a time in their time zone to other users.

hh:mm:ss or hh:mm indicates in the XML standard the time at UTC however, within papiNet it is used to represent the applicable local time. Caution should be used when processing times of this nature as the papiNet approach may be in discord with other users of XML.

DateTimeRange

DateTimeRange is optional because of choice construct.

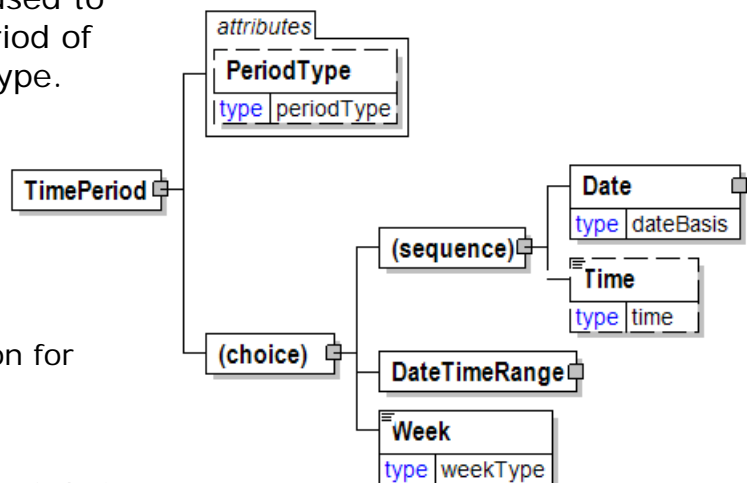

Specifies a date and/or time range.

Week

Week is optional because of choice construct.

A field defining the week number of the calendar year. ISO 8601 is used as the basis for this element, "Week 01 of a year is the first week that has the Thursday in this year, which is equivalent to the week that contains the fourth day of January."

TimeSlot

A period of time during which an activity can be scheduled.

(sequence)

The sequence of items below is mandatory. A single instance is required.

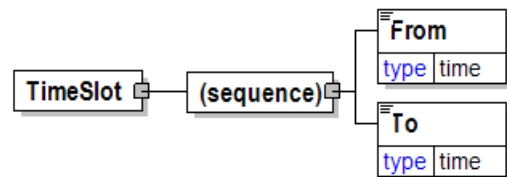

From

From is mandatory. A single instance is required.

The beginning point of a timeperiod.

To

To is mandatory. A single instance is required.

The ending point of a timeperiod.

TimeSlotAvailability [attribute]

Either "Yes" or "No".

This item is restricted to the following list.

Yes

No



TimeSlotInformation

Description of the beginning and end of a time slot and the contingencies it contains.

TimeSlotAvailability [attribute]

TimeSlotAvailability is mandatory. A single instance is required.

Either "Yes" or "No".

Refer to TimeSlotAvailability definition for any enumerations.

(sequence)

The sequence of items below is mandatory. A single instance is required.

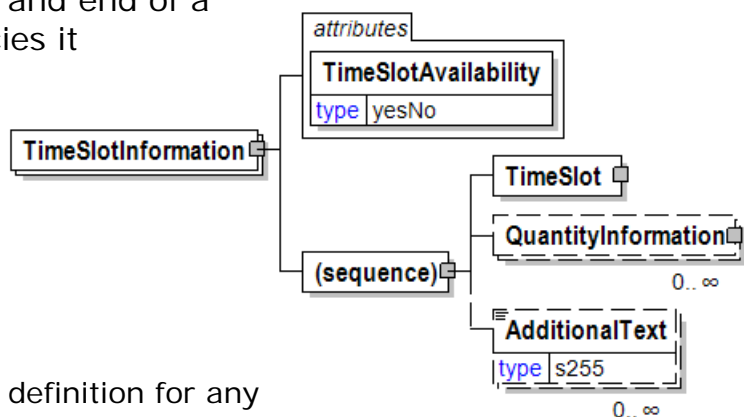

TimeSlot

TimeSlot is mandatory. A single instance is required.

A period of time during which an activity can be scheduled.

QuantityInformation

QuantityInformation is optional. Multiple instances might exist.

A group item containing information about quantity and informational quantity of similar items.

AdditionalText

AdditionalText is optional. Multiple instances might exist.

A text field that is used to communicate information not previously defined or for special instructions. To be used only for circumstances not covered by specific elements.

To

The ending point of a timeperiod.

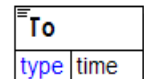

ToProduct

Defines to which product the item is downgraded.

(sequence)

The sequence of items below is mandatory. A single instance is required.

(sequence)

The sequence of items below is mandatory. One instance is required, multiple instances might exist.

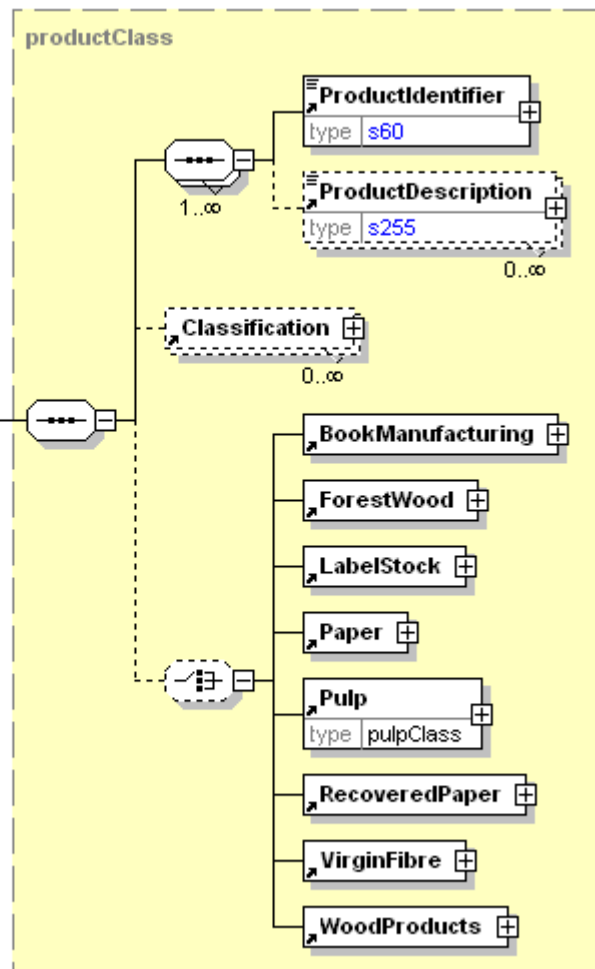
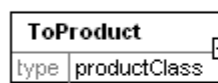

ProductIdentifier

ProductIdentifier is mandatory. A single instance is required.

Used to communicate the code of the article, in a variety of formats designated by the type.

ProductDescription

ProductDescription is optional. Multiple instances might exist.

An element used to communicate a human readable description of the product in the language

specified by the Language attribute.

Classification

Classification is optional. Multiple instances might exist.

A group item that details the product classification according to a particular organization's scheme. An item across multiple classifications would still be recognized as the same item. Examples of some product classifications are: Containerboard, Pulp-Dissolving, or Newsprint.

(choice)

[choice] is optional because of choice construct.

BookManufacturing

BookManufacturing is optional because of choice construct.

BookManufacturing is a group element that contains the elements that describe the book manufacturing process.

ForestWood

ForestWood is optional because of choice construct.

A grouping element with information about characteristics for Forest Wood products.

LabelStock

LabelStock is optional because of choice construct.

LabelStock contains the attributes and characteristics that define the label stock product.

Paper

Paper is optional because of choice construct.

A group item defining the characteristics of the paper product.

Pulp

Pulp is optional because of choice construct.

A group item defining the characteristics of pulp that are not dependent on a particular conversion process.

RecoveredPaper

RecoveredPaper is optional because of choice construct.

A group item defining the characteristics of recycled fibre that are not dependent on a particular conversion process.

VirginFibre

VirginFibre is optional because of choice construct.

Virgin Fibre

WoodProducts

WoodProducts is optional because of choice construct.

A grouping element for all wood products.

TopSide [attribute]

Either "Yes" or "No".

This item is restricted to the following list.

Yes

No

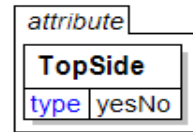

TotalAdjustments

The CurrencyValue of TotalAdjustments contains the total of all MonetaryAdjustmentAmount for all instances of PriceAdjustment and FlatAmountAdjustment in the document (it excludes TaxAdjustments).

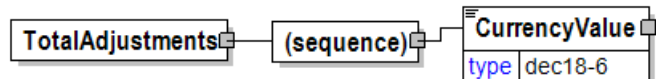

(sequence)

The sequence of items below is mandatory. A single instance is required.

CurrencyValue

CurrencyValue is mandatory. A single instance is required.

The amount in the referenced currency as defined by the CurrencyType attribute.

TotalAmount

The total amount including tax.

In e-Documents claiming payment this is the amount due for payment based on the terms of payment. Decimal rounding might be applied to this amount.

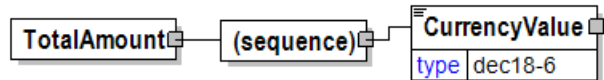

(sequence)

The sequence of items below is mandatory. A single instance is required.

CurrencyValue

CurrencyValue is mandatory. A single instance is required.

The amount in the referenced currency as defined by the CurrencyType attribute.

TotalBlanketOrderValue

The authorized amount of the blanket PurchaseOrder.

(sequence)

The sequence of items below is mandatory. A single instance is required.

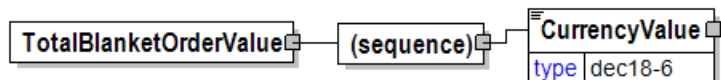

CurrencyValue

CurrencyValue is mandatory. A single instance is required.

The amount in the referenced currency as defined by the CurrencyType attribute.

TotalFASAmount

TotalFASAmount is the total Free Alongside Ship value.

(sequence)

The sequence of items below is mandatory. A single instance is required.

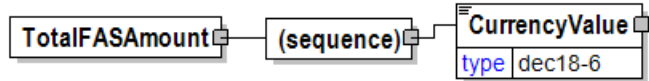

CurrencyValue

CurrencyValue is mandatory. A single instance is required.

The amount in the referenced currency as defined by the CurrencyType attribute.

TotalInformationalAmount

A monetary amount used for information purposes only (not for calculation). For example, the invoice price adjustment subtotal is expressed in sterling pounds, and the buyer wants this information expressed in U.S. dollars.

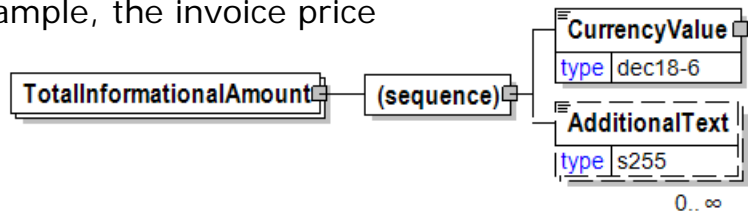

(sequence)

The sequence of items below is mandatory. A single instance is required.

CurrencyValue

CurrencyValue is mandatory. A single instance is required.

The amount in the referenced currency as defined by the CurrencyType attribute.

AdditionalText

AdditionalText is optional. Multiple instances might exist.

A text field that is used to communicate information not previously defined or for special instructions. To be used only for circumstances not covered by specific elements.

TotalInformationalQuantity

A quantity that is used to communicate related information about the parent element. This element represents a total that is derived from individual line items.

QuantityType [attribute]

QuantityType is mandatory. A single instance is required.

QuantityType communicates information about the type of quantity being communicated and how the receiver might use the information.

Refer to QuantityType definition for any enumerations.

QuantityTypeContext [attribute]

QuantityTypeContext is optional. A single instance might exist.

Provides the location in the value chain where the quantity is being reported.

Refer to QuantityTypeContext definition for any enumerations.

AdjustmentType [attribute]

AdjustmentType is optional. A single instance might exist.

Describes the type of adjustment associated with a quantity.

Refer to AdjustmentType definition for any enumerations.

MeasuringMethodType [attribute]

MeasuringMethodType is optional. A single instance might exist.

Specifies how a measurement value is created.

Refer to MeasuringMethodType definition for any enumerations.

MeasuringAgency [attribute]

MeasuringAgency is optional. A single instance might exist.

The agency defining measuring methods.

Refer to MeasuringAgency definition for any enumerations.

MeasuringMethod [attribute]

MeasuringMethod is optional. A single instance might exist.

The method used to determine how the item under consideration is measured. Measuring methods are defined by the measuring agency.

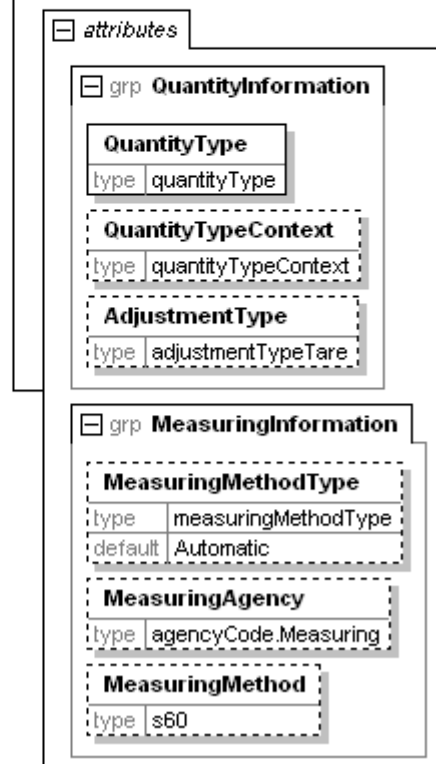
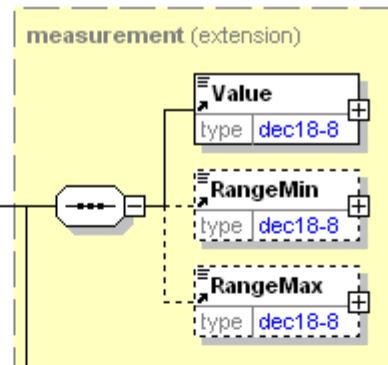

(sequence)

The sequence of items below is mandatory. A single instance is required.

Value

Value is mandatory. A single instance is required.

A numeric value expressed in the unit of measure (UOM).

RangeMin

RangeMin is optional. A single instance might exist.

The minimum value (lower boundary) allowed for the Measurement that is the parent of this element.

RangeMax

RangeMax is optional. A single instance might exist.

The maximum value (upper boundary) allowed for the Measurement that is the parent of this element. Some elements use the RangeMax element with an extended list of unit of measures. (Note: the red colour in the picture is an artifact of how the graphic was captured and should be disregarded.)

TotalNetAmount

A field containing total amount excluding tax. For example, in the Invoice TotalNetAmount is equal to the sum of LineItemSubTotal plus TotalAdjustments. TotalNetAmount encapsulates CurrencyValue.

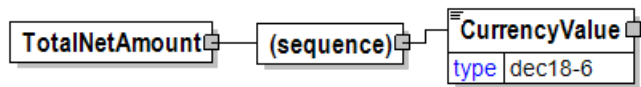

(sequence)

The sequence of items below is mandatory. A single instance is required.

CurrencyValue

CurrencyValue is mandatory. A single instance is required.

The amount in the referenced currency as defined by the CurrencyType attribute.

TotalNetOfTermsDiscount

The components of the amount to be paid if prompt payment discount terms are met, including the amount that is subject to the payment terms discount, the discount amount, and the amount due after prompt payment discount.

(sequence)

The sequence of items below is mandatory. A single instance is required.

AmountSubjectToTermsDiscount

AmountSubjectToTermsDiscount is mandatory. A single instance is required.

The amount against which prompt payment terms can be applied.

TotalTermsDiscountNetAmount

TotalTermsDiscountNetAmount is optional. A single instance might exist.

The total prompt payment discount amount excluding taxes.

TotalTermsDiscountNetAmountTax

TotalTermsDiscountNetAmountTax is optional. A single instance might exist.

Tax amount calculated for prompt payment discount amount

TotalTermsDiscountAmount

TotalTermsDiscountNetAmount is optional. A single instance might exist.

The total prompt payment discount amount including taxes.

TotalTermsDiscountNetAmountDue

TotalTermsDiscountNetAmountDue is optional. A single instance might exist.

The total amount due after prompt payment discount excluding taxes. Encapsulates CurrencyValue.

TotalTermsDiscountTaxAmount

TotalTermsDiscountTaxAmount is optional. A single instance might exist.

The total tax amount calculated after prompt payment discount.

TotalTermsDiscountAmountDue

TotalTermsDiscountAmountDue is mandatory. A single instance is required.

The total amount after prompt payment discount, includes the related taxes.

In e-Documents claiming payment this is the amount due for payment when prompt payment discount is used according to the terms of payment. Decimal rounding might be applied to this amount..

InformationalAmount

InformationalAmount is optional. Multiple instances might exist.

A monetary amount used for information purposes only (not for calculation). For example, the invoice price adjustment subtotal is expressed in sterling pounds, and the buyer wants this information expressed in U.S. dollars.

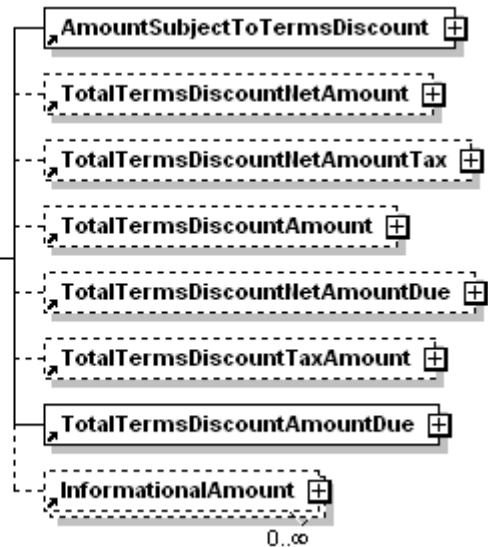

papiNet V2R31

CreditDebitNote and Invoice - The TaxAmount is displayed in the currency that is applicable throughout the e-Document. When a TaxAmount needs to be displayed in a different national currency, this field is used.

TotalNumberOfLineItems

The total number of individual line items in the document, regardless of the status or type.

TotalNumberOfLineItems	
type	nni4

TotalNumberOfPackingListItems

Total Number Of PackingList Items

TotalNumberOfPackingListItems	
type	nni3

TotalNumberOfPackingListPackingUnits

TotalNumberOfPackingListPackingUnits

TotalNumberOfPackingListPackingUnits	
type	nni3

TotalNumberOfSequences

The total number of sequences in the document.

TotalNumberOfSequences	
type	nni4

TotalNumberOfShipments

Total number of shipments referred to in a DeliveryMessage.

TotalNumberOfShipments	
type	nni4

TotalNumberOfUnits

The total number of units.

(sequence)

The sequence of items below is mandatory. A single instance is required.

Value

Value is mandatory. A single instance is required.

A numeric value expressed in the unit of measure (UOM).

RangeMin

RangeMin is optional. A single instance might exist.

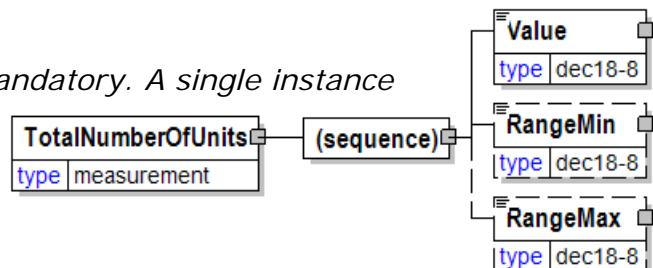

The minimum value (lower boundary) allowed for the Measurement that is the parent of this element.

RangeMax

RangeMax is optional. A single instance might exist.

The maximum value (upper boundary) allowed for the Measurement that is the parent of this element. Some elements use the RangeMax element with an extended list of unit of measures. (Note: the red colour in the picture is an artifact of how the graphic was captured and should be disregarded.)

TotalOldInformationalQuantity

A summary of the OldInformationQuantity in the document.

TotalOldInformationalQuantity uses the QuantityInformation attribute group and the Measurement group (element grouping).

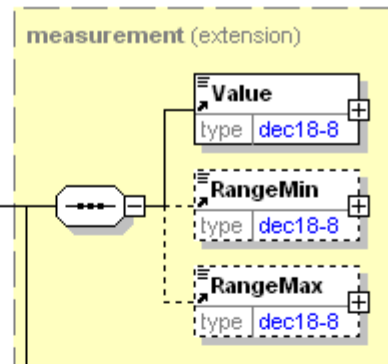

QuantityType [attribute]

QuantityType is mandatory. A single instance is required.

QuantityType communicates information about the type of quantity being communicated and how the receiver might use the information.

Refer to QuantityType definition for any enumerations.

QuantityTypeContext [attribute]

QuantityTypeContext is optional. A single instance might exist.

Provides the location in the value chain where the quantity is being reported.

Refer to QuantityTypeContext definition for any enumerations.

AdjustmentType [attribute]

AdjustmentType is optional. A single instance might exist.

Describes the type of adjustment associated with a quantity.

Refer to AdjustmentType definition for any enumerations.

MeasuringMethodType [attribute]

MeasuringMethodType is optional. A single instance might exist.

Specifies how a measurement value is created.

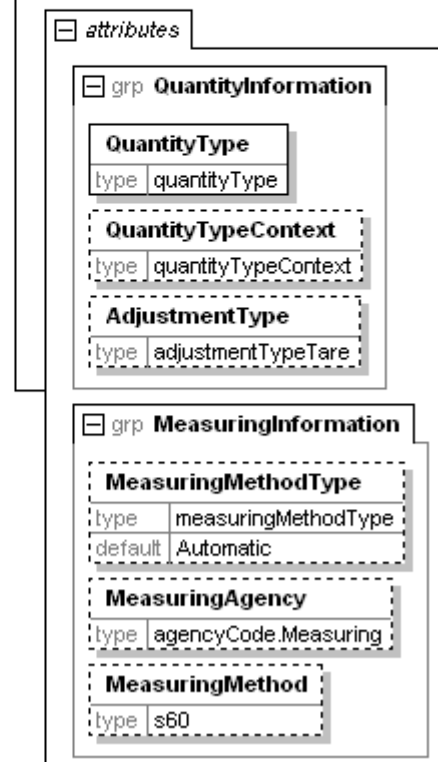

Refer to MeasuringMethodType definition for any enumerations.

MeasuringAgency [attribute]

MeasuringAgency is optional. A single instance might exist.

The agency defining measuring methods.

Refer to MeasuringAgency definition for any enumerations.

MeasuringMethod [attribute]

MeasuringMethod is optional. A single instance might exist.

The method used to determine how the item under consideration is measured. Measuring methods are defined by the measuring agency.

(sequence)

The sequence of items below is mandatory. A single instance is required.

Value

Value is mandatory. A single instance is required.

A numeric value expressed in the unit of measure (UOM).

RangeMin

RangeMin is optional. A single instance might exist.

The minimum value (lower boundary) allowed for the Measurement that is the parent of this element.

RangeMax

RangeMax is optional. A single instance might exist.

The maximum value (upper boundary) allowed for the Measurement that is the parent of this element. Some elements use the RangeMax element with an extended list of unit of measures. (Note: the red colour in the picture is an artifact of how the graphic was captured and should be disregarded.)

TotalOldQuantity

A summary of the OldQuantity in the document. TotalOldQuantity uses the QuantityInformation attribute group and the Measurement group (element grouping).

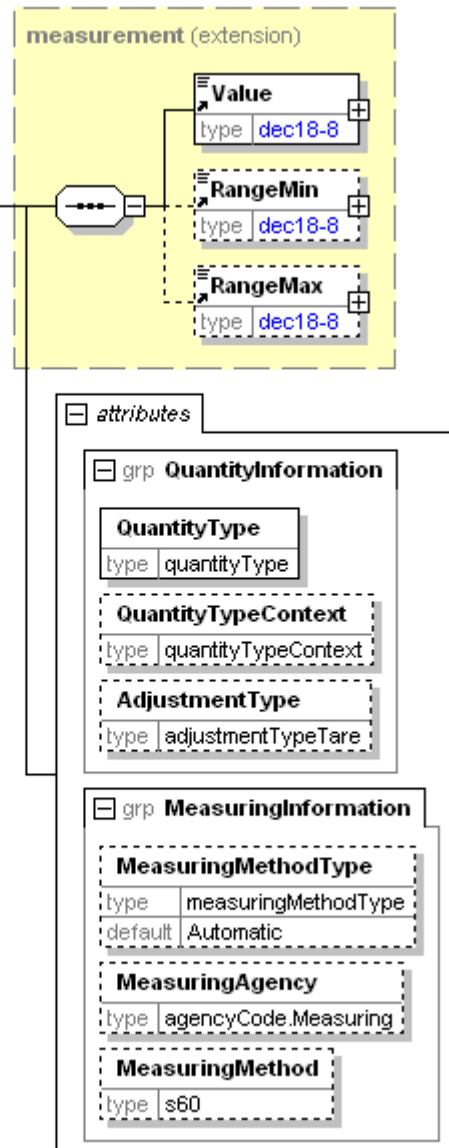

QuantityType [attribute]

QuantityType is mandatory. A single instance is required.

QuantityType communicates information about the type of quantity being communicated and how the receiver might use the information.

Refer to QuantityType definition for any enumerations.

QuantityTypeContext [attribute]

QuantityTypeContext is optional. A single instance might exist.

Provides the location in the value chain where the quantity is being reported.

Refer to QuantityTypeContext definition for any enumerations.

AdjustmentType [attribute]

AdjustmentType is optional. A single instance might exist.

Describes the type of adjustment associated with a quantity.

Refer to AdjustmentType definition for any enumerations.

MeasuringMethodType [attribute]

MeasuringMethodType is optional. A single instance might exist.

Specifies how a measurement value is created.

Refer to MeasuringMethodType definition for any enumerations.

MeasuringAgency [attribute]

MeasuringAgency is optional. A single instance might exist.

The agency defining measuring methods.

Refer to MeasuringAgency definition for any enumerations.

MeasuringMethod [attribute]

MeasuringMethod is optional. A single instance might exist.

The method used to determine how the item under consideration is measured. Measuring methods are defined by the measuring agency.

(sequence)

The sequence of items below is mandatory. A single instance is required.

Value

Value is mandatory. A single instance is required.

A numeric value expressed in the unit of measure (UOM).

RangeMin

RangeMin is optional. A single instance might exist.

The minimum value (lower boundary) allowed for the Measurement that is the parent of this element.

RangeMax

RangeMax is optional. A single instance might exist.

The maximum value (upper boundary) allowed for the Measurement that is the parent of this element. Some elements use the RangeMax element with an extended list of unit of measures. (Note: the red colour in the picture is an artifact of how the graphic was captured and should be disregarded.)

TotalOpenAmount

InvoiceAmount less the sum of all payment amounts, translated into one common currency.

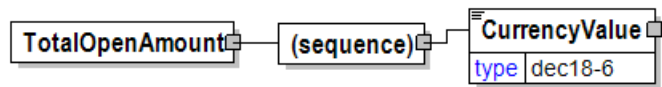

(sequence)

The sequence of items below is mandatory. A single instance is required.

CurrencyValue

CurrencyValue is mandatory. A single instance is required.

The amount in the referenced currency as defined by the CurrencyType attribute.

TotalPageCount

Element used to communicate the book's approximate total number of pages within each unit of the book. Total page count is more or less a reference to the "size" of the book that the customer designates. For instance, they will refer to a book as 800 pages when in fact it is 792 actual text pages with 8 pages of various inserts. This value should not be used to drive any of the other values for the component parts, but may in fact be exactly equal to the number of pages in one of the components designated as "Text".

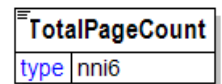

TotalPaymentAmount

The amounts which were paid and booked against the original invoice.

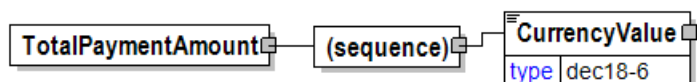

(sequence)

The sequence of items below is mandatory. A single

instance is required.

CurrencyValue

CurrencyValue is mandatory. A single instance is required.

The amount in the referenced currency as defined by the CurrencyType attribute.

TotalQuantity

The total quantity of similar items in the e-Document. TotalQuantity is primarily used in the summary section of documents where it is repeatable to permit totaling for different units of measure.

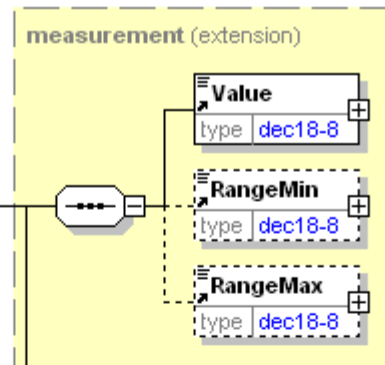
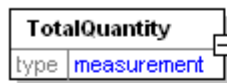

QuantityType [attribute]

QuantityType is mandatory. A single instance is required.

QuantityType communicates information about the type of quantity being communicated and how the receiver might use the information.

Refer to QuantityType definition for any enumerations.

QuantityTypeContext [attribute]

QuantityTypeContext is optional. A single instance might exist.

Provides the location in the value chain where the quantity is being reported.

Refer to QuantityTypeContext definition for any enumerations.

AdjustmentType [attribute]

AdjustmentType is optional. A single instance might exist.

Describes the type of adjustment associated with a quantity.

Refer to AdjustmentType definition for any enumerations.

MeasuringMethodType [attribute]

MeasuringMethodType is optional. A single instance might exist.

Specifies how a measurement value is created.

Refer to MeasuringMethodType definition for any enumerations.

MeasuringAgency [attribute]

MeasuringAgency is optional. A single instance might exist.

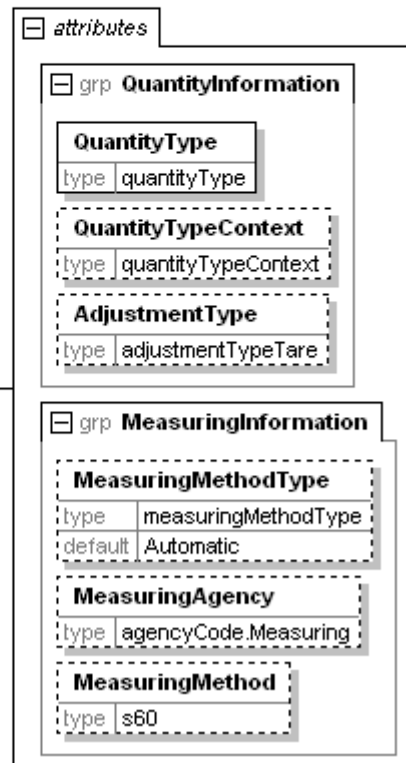

The agency defining measuring methods.

Refer to MeasuringAgency definition for any enumerations.

MeasuringMethod [attribute]

MeasuringMethod is optional. A single instance might exist.

The method used to determine how the item under consideration is measured. Measuring methods are defined by the measuring agency.

(sequence)

The sequence of items below is mandatory. A single instance is required.

Value

Value is mandatory. A single instance is required.

A numeric value expressed in the unit of measure (UOM).

RangeMin

RangeMin is optional. A single instance might exist.

The minimum value (lower boundary) allowed for the Measurement that is the parent of this element.

RangeMax

RangeMax is optional. A single instance might exist.

The maximum value (upper boundary) allowed for the Measurement that is the parent of this element. Some elements use the RangeMax element with an extended list of unit of measures. (Note: the red colour in the picture is an artifact of how the graphic was captured and should be disregarded.)

TotalQuantityInformation

A group item containing information about the total quantity and total informational quantity of similar items in the document.

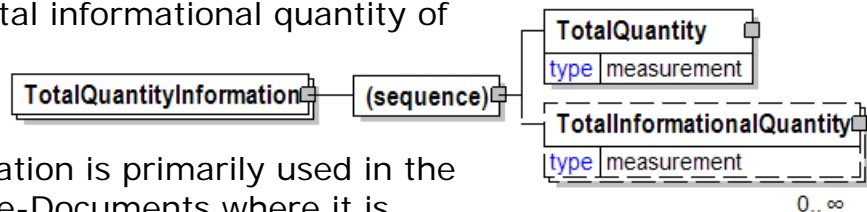

TotalQuantityInformation is primarily used in the summary section of e-Documents where it is repeatable to permit totalling for different units of measure.

(sequence)

The sequence of items below is mandatory. A single instance is required.

TotalQuantity

TotalQuantity is mandatory. A single instance is required.

The total quantity of similar items in the e-Documents where it is repeatable to permit totalling for different units of measure.

TotalInformationalQuantity

TotalInformationalQuantity is optional. Multiple instances might exist.

A quantity that is used to communicate related information about the parent

element. This element represents a total that is derived from individual line items.

TotalRunningLength

Summary value of amount measured in running meters, etc.

QuantityType [attribute]

QuantityType is mandatory. A single instance is required.

QuantityType communicates information about the type of quantity being communicated and how the receiver might use the information.

Refer to QuantityType definition for any enumerations.

QuantityTypeContext [attribute]

QuantityTypeContext is optional. A single instance might exist.

Provides the location in the value chain where the quantity is being reported.

Refer to QuantityTypeContext definition for any enumerations.

AdjustmentType [attribute]

AdjustmentType is optional. A single instance might exist.

Describes the type of adjustment associated with a quantity.

Refer to AdjustmentType definition for any enumerations.

(sequence)

The sequence of items below is mandatory. A single instance is required.

Value

Value is mandatory. A single instance is required.

A numeric value expressed in the unit of measure (UOM).

RangeMin

RangeMin is optional. A single instance might exist.

The minimum value (lower boundary) allowed for the Measurement that is the parent of this element.

RangeMax

RangeMax is optional. A single instance might exist.

The maximum value (upper boundary) allowed for the Measurement that is the parent of this element. Some elements use the RangeMax element with an extended list of unit of measures. (Note: the red colour in the picture is an artifact of how the graphic was captured and should be disregarded.)

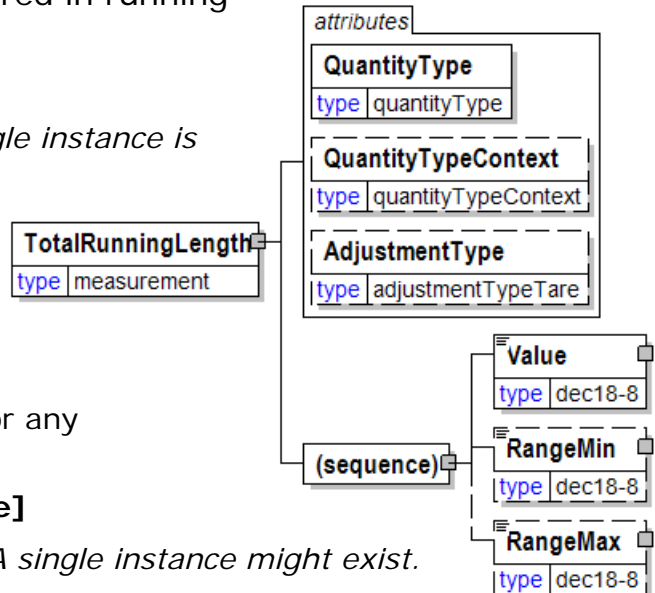

TotalSetNumbers

The total number of sets wound from the Tambour (in the radial direction). Tambour is also called jumbo reel or mother reel.

TotalSetNumbers	
type	nni4

TotalSetPositions

The total number of reels cut across the Tambour (in the width direction). Tambour is also called jumbo reel or mother reel.

TotalSetPositions	
type	nni4

TotalTaxAmount

The CurrencyValue of TotalTaxAmount contains the sum of all instances of TaxAdjustment in the document. TotalTaxAmount contains the sum of all instances of the MonetaryAdjustmentAmount for tax adjustments.

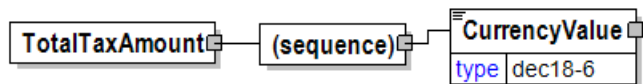

(sequence)

The sequence of items below is mandatory. A single instance is required.

CurrencyValue

CurrencyValue is mandatory. A single instance is required.

The amount in the referenced currency as defined by the CurrencyType attribute.

TotalTermsDiscountAmount

The total prompt payment discount amount including taxes.

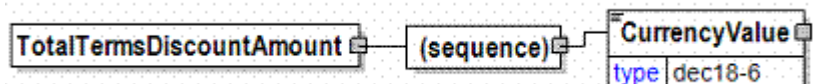

(sequence)

The sequence of items below is mandatory. A single instance is required.

CurrencyValue

CurrencyValue is mandatory. A single instance is required.

The amount in the referenced currency as defined by the CurrencyType attribute.

TotalTermsDiscountAmountDue

The total amount after prompt payment discount, includes the related taxes.

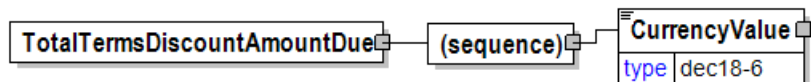

In e-Documents

claiming payment this is the amount due for payment when prompt payment discount is used according to the terms of payment. Decimal

rounding might be applied to this amount.

(sequence)

The sequence of items below is mandatory. A single instance is required.

CurrencyValue

CurrencyValue is mandatory. A single instance is required.

The amount in the referenced currency as defined by the CurrencyType attribute.

TotalTermsDiscountNetAmount

The total prompt payment discount amount excluding taxes.

(sequence)

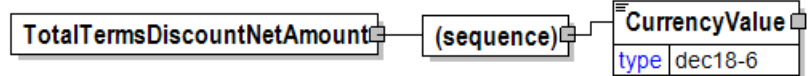

The sequence of items below is mandatory. A single instance is required.

CurrencyValue

CurrencyValue is mandatory. A single instance is required.

The amount in the referenced currency as defined by the CurrencyType attribute.

TotalTermsDiscountNetAmountDue

The total amount due after prompt payment discount excluding taxes.

Encapsulates CurrencyValue.

(sequence)

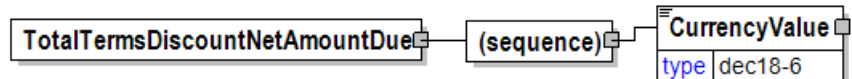

The sequence of items below is mandatory. A single instance is required.

CurrencyValue

CurrencyValue is mandatory. A single instance is required.

The amount in the referenced currency as defined by the CurrencyType attribute.

TotalTermsDiscountNetAmountTax

Tax amount calculated for prompt payment discount amount.

(sequence)

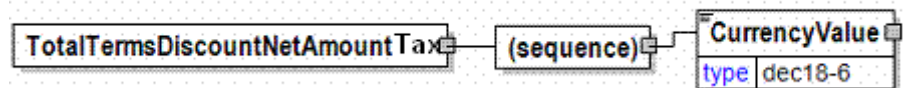

The sequence of items below is mandatory. A single instance is required.

CurrencyValue

CurrencyValue is mandatory. A single instance is required.

The amount in the referenced currency as defined by the CurrencyType attribute.

TotalTermsDiscountTaxAmount

The total tax amount calculated after prompt payment discount.

(sequence)

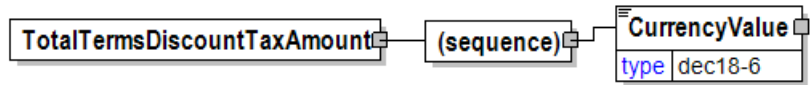

The sequence of items below is mandatory. A single instance is required.

CurrencyValue

CurrencyValue is mandatory. A single instance is required.

The amount in the referenced currency as defined by the CurrencyType attribute.

TotalTime

The total time.

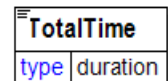

TrackingReferenceID

A grouping element that defines tracking references between items processed in the supply chain.

TrackingReferenceIDType [attribute]

TrackingReferenceIDType is mandatory. A single instance is required.

Defines the type of relationship the actual item has to other the tracked items.

Refer to TrackingReferenceIDType definition for any enumerations.

ItemType [attribute]

ItemType is mandatory. A single instance is required.

Indicates the form of the item being reported as being used. Many of the ItemType(s) indicated here have a corresponding named element equivalent, which is referenced here for definition purposes.

Refer to ItemType definition for any enumerations.

(sequence)

The sequence of items below is mandatory. A single instance is required.

Identifier

Identifier is mandatory. Multiple instances might exist.

An Identifier is required for packages and items (pallets, reel packages, boxes, ream items, reel items, etc). The Identifier element contains the actual item identifier code. Identifier is repeatable so more than one identifier can be communicated. For example, the printed identifier on a label may be different from the barcode printed on the label.

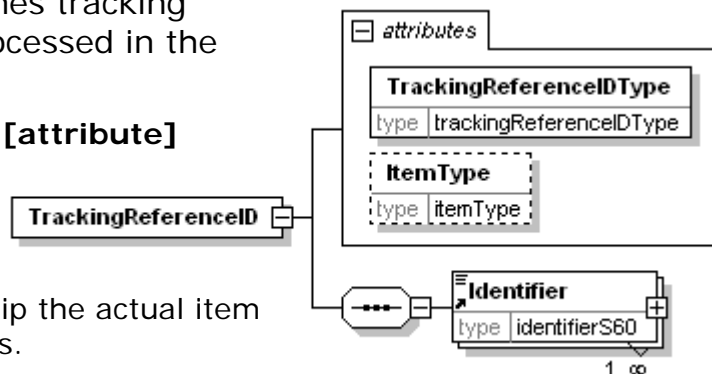

TrackingReferenceIDType [attribute]

Defines the type of relationship the actual item has to other the tracked items.

TrackingReferenceIDType	
type	trackingReferenceIDType

This item is restricted to the following list.

Child

This item is derived from the actual item. E.g. a board from a saw log.

Origin

The origin of the actual item. E.g. a logging area where a saw log was cut.

Parent

The actual item is derived from this item. E.g. a sawlog is cut from a stem.

TrackType [attribute]

The type of track

This item is restricted to the following list.

<i>attribute</i>	
TrackType	
type	trackType

Mono

Track type is monaural.

Stereo

Track type is stereophonic.

TradeRegion

A geographic area for product availability communication.

IsTradeRegionAvailable [attribute]

*IsTradeRegionAvailable is mandatory.
A single instance is required.*

Is the geographic area available or not.

Refer to IsTradeRegionAvailable definition for any enumerations.

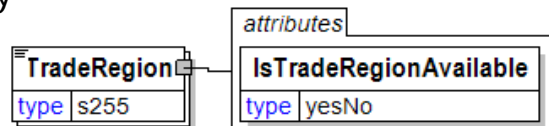

TransactionHistoryConfirmationNumber

A sequential number that indicates the version of the confirmation document being sent.

TransactionHistoryConfirmationNumber	
type	nni9

TransactionHistoryNumber

A sequential number that keeps track of the version of a document being sent by the document originator except in the case where TransactionHistoryConfirmation is used, in which case the TransactionHistoryNumber refers to the trigger transaction for which the confirmation is being sent.

TransactionHistoryNumber	
type	nni9

TransportationComment

Textual Commentary on Transportation for an entire GoodsReceipt.

(sequence)

The sequence of items below is mandatory. A single instance is required.

AdditionalText

AdditionalText is mandatory. A single instance is required.

A text field that is used to communicate information not previously defined or for special instructions. To be used only for circumstances not covered by specific elements.

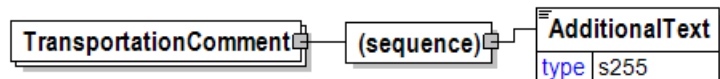

TransportContextType [attribute]

Provides information about the reason for the transport.

This item is restricted to the following list.

Normal (default)

The transport is a normal freight

Return

The transport is a return freight

attributes	
TransportContextType	
type	transportContextType
default	Normal

TransportDeckOption [attribute]

Allotment of a shipping lot that can be placed on the deck of a ship.

This item is restricted to the following list.

FullDeck

The full load can be placed on the deck of the transport vehicle (ship).

HalfDeck

Only half the load can be placed on the deck of the transport vehicle (ship).

OneThirdDeck

attribute	
TransportDeckOption	
type	deckType

Only one-third of the load can be placed on the deck of the transport vehicle (ship).

UnderDeck

The entire load must be placed under the deck of the transport vehicle (ship).

TransportInformation

A grouping element for transport information.

TransportContextType [attribute]

TransportContextType is optional. A single instance might exist.

Provides information about the reason for the transport.

Refer to



TransportContextType definition for any enumerations.

(sequence)

The sequence of items below is mandatory. A single instance is required.

TransportModeCharacteristics

TransportModeCharacteristics is optional. A single instance might exist.

A group item defining the primary mode of transport.

TransportVehicleCharacteristics

TransportVehicleCharacteristics is optional. A single instance might exist.

A group item defining the primary means of transporting the goods, such as a side port vessel. In some instances, the transport unit and vehicle are the same.

TransportUnitCharacteristics

TransportUnitCharacteristics is optional. Multiple instances might exist.

A group item defining and identifying the primary means of containing the goods. In some instances, the transport unit and vehicle are the same.

TransportLoadingCharacteristics

TransportLoadingCharacteristics is optional. Multiple instances might exist.

A group item defining how the transported items are to be loaded.

TransportUnloadingCharacteristics

TransportUnloadingCharacteristics is optional. Multiple instances might exist.

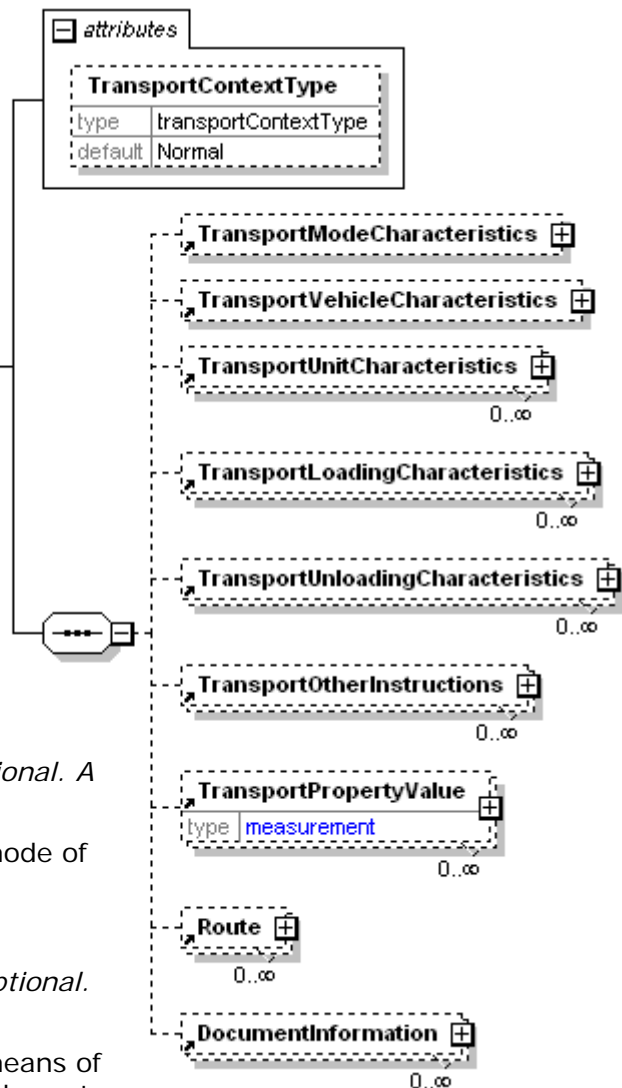

papiNet V2R31

A group item defining how the transported items are to be unloaded.

TransportOtherInstructions

TransportOtherInstructions is optional. Multiple instances might exist.

A group item defining any other instructions for the transport not covered in the description of transport mode, vehicle, unit, and loading characteristics or defining an alternative description for the categories mentioned above.

TransportPropertyValue

TransportPropertyValue is optional. Multiple instances might exist.

Specifies values for various properties for a transport.

Route

Route is optional. Multiple instances might exist.

Route defines directions and characteristics for how to transport goods between two locations. A route starts at delivery origin or at the supplypoint belonging to the delivery origin.

DocumentInformation

DocumentInformation is optional. Multiple instances might exist.

A group element containing a specification of required documents in the business process. Additional free text to be printed on documents can also be specified.

TransportInstructionCode

A code used to define any other transport instructions that are not covered in the description of transport mode, vehicle, unit, and loading characteristics or used alternatively to summarise in one unique code the above-mentioned categories.

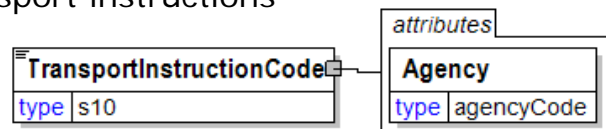

Agency [attribute]

Agency is mandatory. A single instance is required.

Describes the agency maintaining the list of codes. To be included in this list the agency must be a recognized standards body or industry organisation.

For the element that owns this attribute.

For another attribute in the list of attributes associated with the parent element.

Refer to Agency definition for any enumerations.

TransportInstructionText

A text field further describing the transport instructions.

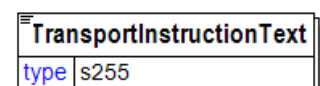

TransportInstructionType [attribute]

Indicates the type of instruction.

This item is restricted to the following list.

LegSpecific

The text is related to the delivery leg or entire delivery.

ProductSpecific

The text is related to the product being transported.



TransportLoadingCharacteristics

A group item defining how the transported items are to be loaded.

MixProductIndicator [attribute]

MixProductIndicator is optional. A single instance may occur.

Specifies whether a product can be mixed with other products on the same shipment.

Refer to MixProductIndicator definition for any enumerations.

TransportLoadingType [attribute]

TransportLoadingType is optional. A single instance might exist.

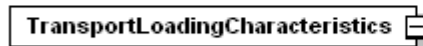

Defines the primary loading modes for the transport of the goods

Refer to TransportLoadingType definition for any enumerations.

TransportDeckOption [attribute]

TransportDeckOption is optional. A single instance might exist.

Allotment of a shipping lot that can be placed on the deck of a ship.

Refer to TransportDeckOption definition for any enumerations.

LoadingTolerance [attribute]

LoadingTolerance is optional. A single instance might exist.

Specifies tolerance type for load quantity. Tolerance values are given by RangeMin and RangeMax in Quantity.

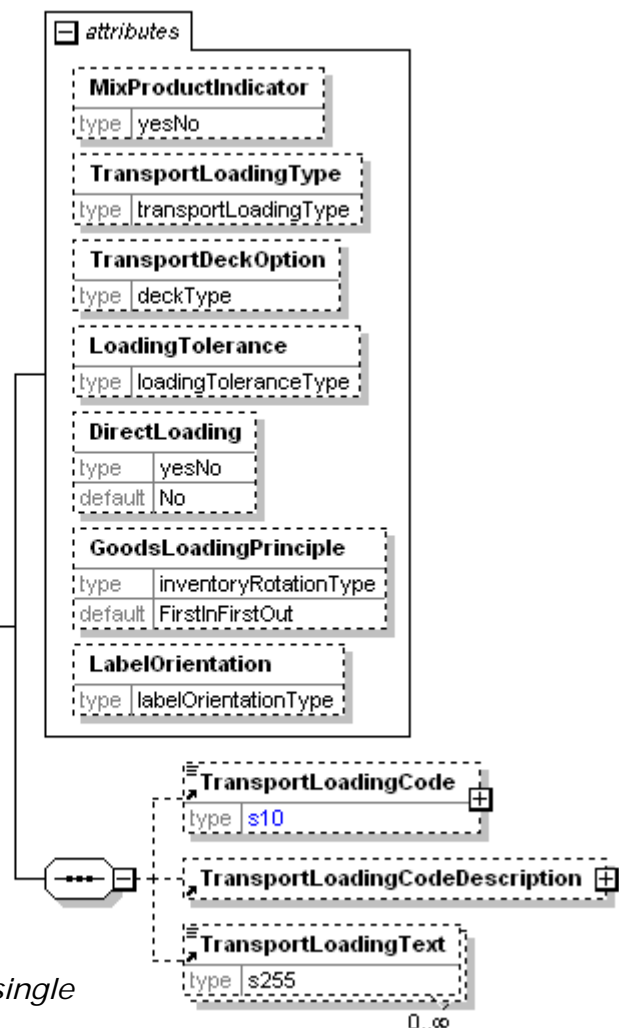

Refer to LoadingTolerance definition for any enumerations.

DirectLoading [attribute]

DirectLoading is optional. A single instance might exist.

Specifies if the transport unit should be loaded directly with goods received on another transport unit.

Refer to DirectLoading definition for any enumerations.

GoodsLoadingPrinciple [attribute]

GoodsLoadingPrinciple is optional. A single instance might exist.

Defines principles for how goods are picked from warehouse and loaded

Refer to GoodsLoadingPrinciple definition for any enumerations.

LabelOrientation [attribute]

LabelOrientation is optional. A single instance might exist.

Specifies label orientation for loaded goods seen in the transport direction of the goods carrier. It makes the label visible during unloading from a predetermined side.

Refer to LabelOrientation definition for any enumerations.

(sequence)

The sequence of items below is mandatory. A single instance is required.

TransportLoadingCode

TransportLoadingCode is optional. A single instance might exist.

A code defining how the transported items are to be loaded.

TransportLoadingCodeDescription

TransportLoadingCodeDescription is optional. A single instance might exist.

A group item describing the TransportLoadingCode. The document specifying how to load goods based on the TransportLoadingCode can be supplied in e-Attachment. TransportLoadingCode can be used as a Load Pattern identifier.

TransportLoadingText

TransportLoadingText is optional. Multiple instances might exist.

A text field further describing the transport loading instructions.

TransportLoadingCode

A code defining how the transported items are to be loaded.

Agency [attribute]

Agency is mandatory. A single instance is required.

Describes the agency maintaining the list of codes. To be included in this list the agency must be a recognized standards body or industry organisation.

For the element that owns this attribute.

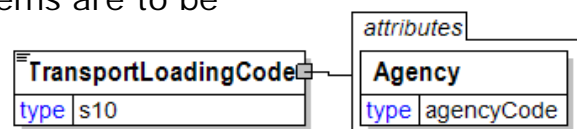

For another attribute in the list of attributes associated with the parent element.

Refer to Agency definition for any enumerations.

TransportLoadingCodeDescription

A group item describing the TransportLoadingCode. The document specifying how to load goods based on the

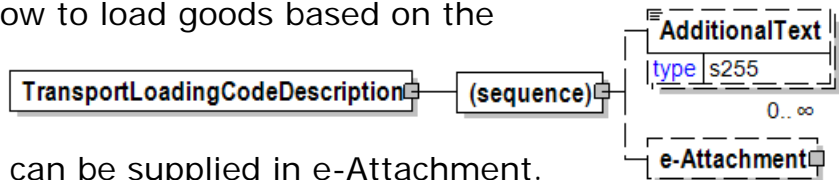

TransportLoadingCode can be supplied in e-Attachment. TransportLoadingCode can be used as a Load Pattern identifier.

(sequence)

The sequence of items below is mandatory. A single instance is required.

AdditionalText

AdditionalText is optional. Multiple instances might exist.

A text field that is used to communicate information not previously defined or for special instructions. To be used only for circumstances not covered by specific elements.

e-Attachment

e-Attachment is optional. A single instance might exist.

e-Attachment enables the sender to provide information about attachments to the document.

Note: BizTalk users may have problems in processing this element. See the papiNet FAQs (papiNet.org) for more information.

TransportLoadingText

A text field further describing the transport loading instructions.

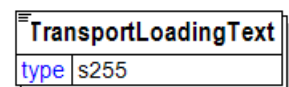

TransportLoadingType [attribute]

Defines the primary loading modes for the transport of the goods

This item is restricted to the following list.

ByLoadingCode

How to load the goods is specified via the element TransportLoadingCode. TransportLoadingCode can be used as a Load Pattern identifier. A separate document, that can be specified by element TransportLoadingCodeDescription, specifies the Load Pattern in all details.

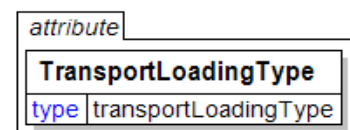

Lying

The goods, such as reels on the belly, have to be in a lying position during transport.

Standing

The goods, such as reels standing on end, have to be in a standing position during transport

StandingUpsideDown

The goods, such as reels standing on end but turned upside-down, have to be in a standing position during transport. Reels are turned upside-down to get the right unwinding direction at end user.

Other

Used for any other loading modes not covered by this list.

TransportModeCharacteristics

A group item defining the primary mode of transport.

TransportModeType [attribute]

TransportModeType is optional. A single instance might exist.

Defines the primary mode of transport for the goods

Refer to TransportModeType definition for any enumerations.

(sequence)

The sequence of items below is mandatory. A single instance is required.

TransportModeCode

TransportModeCode is optional. A single instance might exist.

A code defining the primary mode of transport.

TransportModeText

TransportModeText is optional. A single instance might exist.

A text field further describing the transport mode.

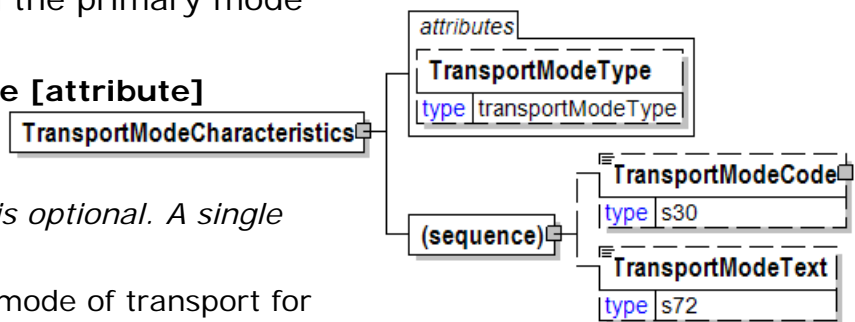

TransportModeCode

A code defining the primary mode of transport.

Agency [attribute]

Agency is mandatory. A single instance is required.

Describes the agency maintaining the list of codes. To be included in this list the agency must be a recognized standards body or industry organisation.

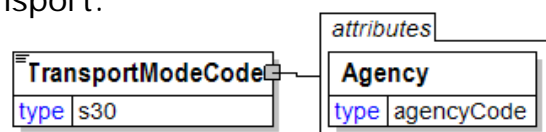

For the element that owns this attribute.

For another attribute in the list of attributes associated with the parent element.

Refer to Agency definition for any enumerations.

TransportModeText

A text field further describing the transport mode.

TransportModeText	
type	s72

TransportModeType [attribute]

Defines the primary mode of transport for the goods

This item is restricted to the following list.

attribute
TransportModeType
type transportModeType

Air

The goods will be transported by air.

InlandWaterway

The goods will be transported by inland waterway.

Intermodal

The movement of goods in one and the same transport unit, which uses successively two or more modes of transport without handling the goods themselves in changing modes. (Definition courtesy of the UN/ECE, the European Conference of Ministers of Transport [ECMT] and the European Commission [EC])

Mail

The goods will be sent by post.

Multimodal

The goods will be transported by two or more modes of transport. Handling of goods can occur in changing transport modes.

Rail

The goods will be transported by rail.

Road

The goods will be transported by road.

Sea

The goods will be transported by sea.

Other

Used for any other transport modes not covered by this list.

TransportOtherInstructions

A group item defining any other instructions for the transport not covered in the description of transport mode, vehicle, unit, and loading characteristics or defining an alternative description for the categories mentioned above.

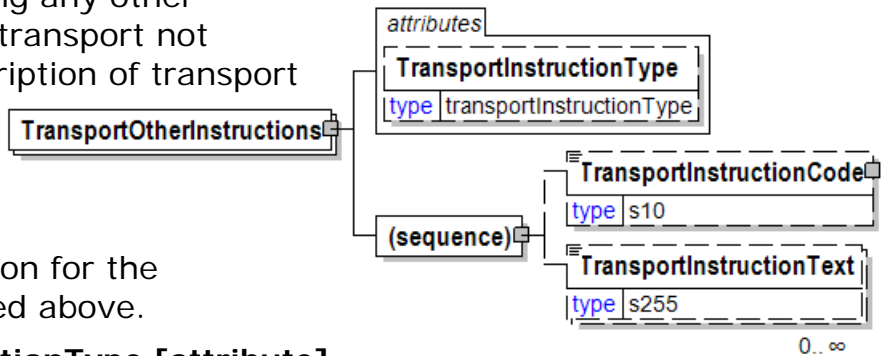

TransportInstructionType [attribute]

TransportInstructionType is optional. A single instance might exist.

Indicates the type of instruction.

Refer to TransportInstructionType definition for any enumerations.

(sequence)

The sequence of items below is mandatory. A single instance is required.

TransportInstructionCode

TransportInstructionCode is optional. A single instance might exist.

A code used to define any other transport instructions that are not covered in the description of transport mode, vehicle, unit, and loading characteristics or used alternatively to summarise in one unique code the above-mentioned categories.

TransportInstructionText

TransportInstructionText is optional. Multiple instances might exist.

A text field further describing the transport instructions.

TransportPackageInformation

Information of a package used in transportation, can include several normal packages.

PackageType [attribute]

PackageType is mandatory. A single instance is required.

Communicates the configuration of the item being reported.

Refer to PackageType definition for any enumerations.

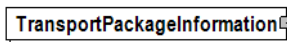

MixedProductPalletIndicator [attribute]

MixedProductPalletIndicator is optional. A single instance might exist.

Specifies whether a product can be mixed with other products on the same pallet

Refer to MixedProductPalletIndicator definition for any enumerations.

PackageLevel [attribute]

PackageLevel is optional. A single instance might exist.

An hierarchical numbering approach that communicates containerization and identity.

(sequence)

The sequence of items below is mandatory. A single instance is required.

Identifier

Identifier is mandatory. One instance is required, multiple instances might exist.

An Identifier is required for packages and items (pallets, reel packages, boxes, ream items, reel items, etc). The Identifier element contains the actual item identifier code. Identifier is repeatable so more than one identifier can be communicated. For example, the printed identifier on a label may be different from the barcode printed on the label.

RawMaterialSet

RawMaterialSet is optional. Multiple instances might exist.

This identifier derived element indicates a grouping of raw materials that were used to manufacture the product.

(sequence)

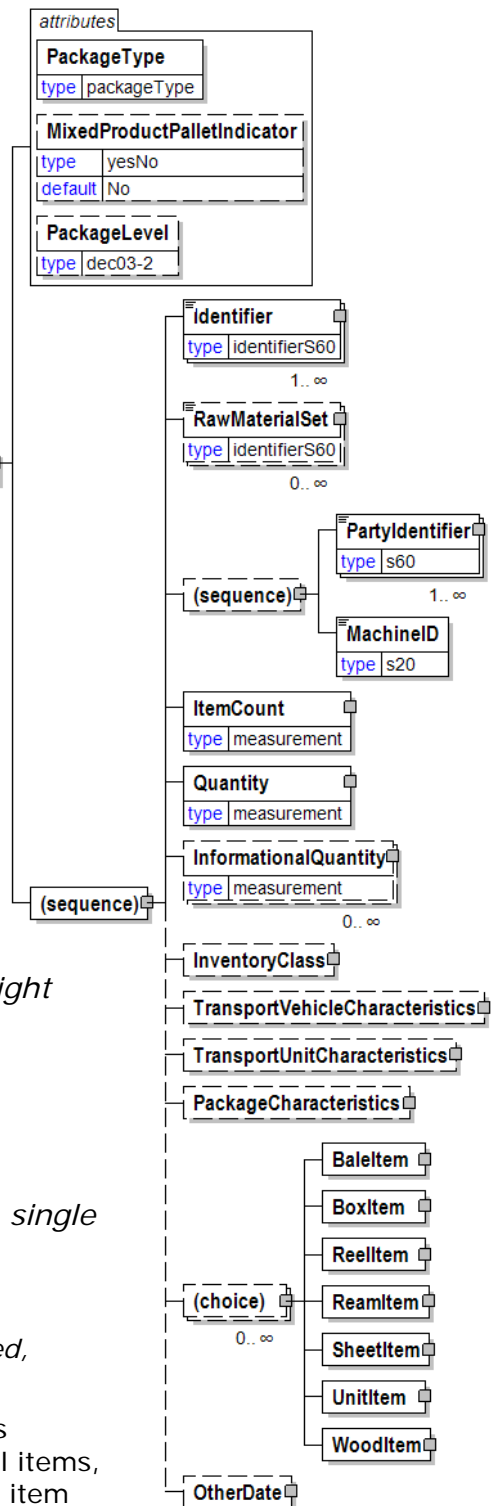

The sequence of items below is optional. A single instance might exist.

PartyIdentifier

PartyIdentifier is mandatory. One instance is required, multiple instances might exist.

A unique identifier of a specific party. This element contains an attribute PartyIdentifierType that indicates the type of party.

MachineID

MachineID is mandatory. A single instance is required.

An identifier assigned to the particular machine being referenced. For example, a machine could be a paper machine, an off-line coater, a sheeter, or a printing press. The particular machine being referenced will be determined by the business event being supported.

ItemCount

ItemCount is mandatory. A single instance is required.

A count of the number of items (examples: a count of the number of boxes on a pallet or of reams in a box).

Quantity

Quantity is mandatory. A single instance is required.

The Quantity element contains attributes that provide information about the type of quantity that is being communicated, the context in which the particular quantity is to be viewed, and (if the quantity represents an adjustment) an adjustment type.

The Quantity element contains three child elements that enable you to communicate a range of values for the quantity and a target or actual value. It is at this level (Value, RangeMin, and RangeMax) that the unit of measure is specified. This permits the range to be specified in a different unit of measure than the target.

InformationalQuantity

InformationalQuantity is optional. Multiple instances might exist.

A quantity given in a valid UOM used for information purposes only (not for calculation). For example, an ordered quantity was 100 reels as opposed to the invoice quantity of 20,000 pounds.

InventoryClass

InventoryClass is optional. A single instance might exist.

A group item containing information about status of inventory and goods items.

TransportVehicleCharacteristics

TransportVehicleCharacteristics is optional. A single instance might exist.

A group item defining the primary means of transporting the goods, such as a side port vessel. In some instances, the transport unit and vehicle are the same.

TransportUnitCharacteristics

TransportUnitCharacteristics is optional. A single instance might exist.

A group item defining and identifying the primary means of containing the goods. In some instances, the transport unit and vehicle are the same.

PackageCharacteristics

PackageCharacteristics is optional. A single instance might exist.

The package characteristics.

(choice)

[choice] is optional because of choice construct.

BaleItem

BaleItem is optional because of choice construct.

An individual bale included as part of a delivery.

BoxItem

BoxItem is optional because of choice construct.

A four-sided container for reams or sheet items. A pallet can contain zero or more boxes. The term Carton is a synonym for BoxItem. The term "Box" is used as constraint within the ItemType attribute of the UsageLineItemDetail to refer to a box that contains other boxes.

ReelItem

ReelItem is optional because of choice construct.

A group item representing details of an actual (as opposed to specified) reel. One or several reels can be contained in a package.

ReamItem

ReamItem is optional because of choice construct.

A wrapped quantity of SheetItem(s).

SheetItem

SheetItem is optional because of choice construct.

A group item consisting potentially of the date the sheets were converted into sheets and/or packaged or finished.

UnitItem

UnitItem is optional because of choice construct.

Unit Item.

WoodItem

WoodItem is optional because of choice construct.

Group element containing elements describing a wood industry product.

OtherDate

OtherDate is optional. A single instance might exist.

A date that may not be specifically detailed within a document (example: print date at the PurchaseOrderLineItem).

TransportPropertyType [attribute]

Defines the property specified for a transport.

This item is restricted to the following list.

DistanceWithLoad

Transported distance with a payload.

DistanceWithoutLoad



Transported distance without a payload.

LoadingTime

Time elapsed during loading.

LoadingWaitingTime

Time elapsed waiting for loading.

UnLoadingTime

Time elapsed during unloading.

UnLoadingWaitingTime

Time elapsed waiting for unloading.

TransportPropertyValue

Specifies values for various properties for a transport.

TransportPropertyType [attribute]

TransportPropertyType is mandatory. A single instance is required.

Defines the property specified for a transport.

Refer to TransportPropertyType definition for any enumerations.

(sequence)

The sequence of items below is mandatory. A single instance is required.

Value

Value is mandatory. A single instance is required.

A numeric value expressed in the unit of measure (UOM).

RangeMin

RangeMin is optional. A single instance might exist.

The minimum value (lower boundary) allowed for the Measurement that is the parent of this element.

RangeMax

RangeMax is optional. A single instance might exist.

The maximum value (upper boundary) allowed for the Measurement that is the parent of this element. Some elements use the RangeMax element with an extended list of unit of measures. (Note: the red colour in the picture is an artifact of how the graphic was captured and should be disregarded.)

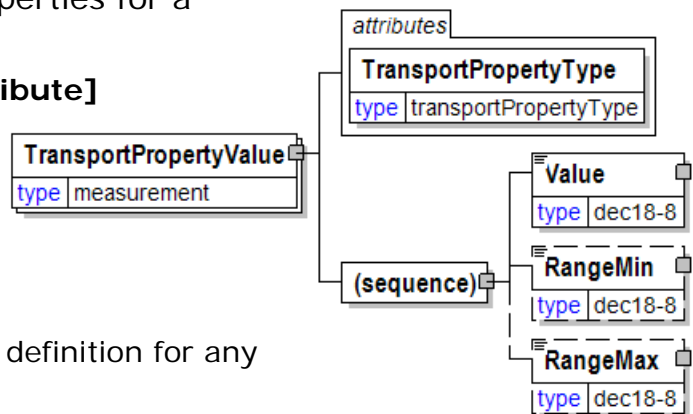

TransportStatus

Text element used to communicate the current status of the shipment actually being transported to the recipient. This element could indicate the tracking status that the transport company issues. Alternatively, it could be the vendor's internal tracking status of the shipment.

TransportStatus	
type	s30

TransportStatusIssueDate

The Date and Time the transport status is issued.

(sequence)

The sequence of items below is mandatory. A single instance is required.

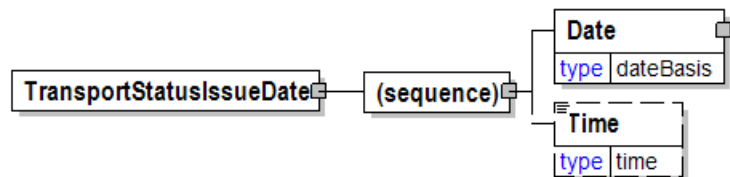

Date

Date is mandatory. A single instance is required.

A group element that contains the specification of Year, Month, and Day.

Time

Time is optional. A single instance might exist.

Times are treated in a standard XML fashion with a special case used to indicate a generalized "local" time. The standard XML approach to time is hh:mm:ss, hh:mm:ssZ, or hh:mm:ss±hh:mm.

hh:mm:ss±hh:mm is used to represent a time with a time zone. The time zone is communicated as the number of hours offset from the Universal Time Coordinate (UTC), a.k.a. Greenwich Mean Time.

hh:mm:ssZ indicates the time at Zulu (another name for UTC). Based on the convention described in the next bullet it will be important for users within UTC to use "Z" when communicating a time in their time zone to other users.

hh:mm:ss or hh:mm indicates in the XML standard the time at UTC however, within papiNet it is used to represent the applicable local time. Caution should be used when processing times of this nature as the papiNet approach may be in discord with other users of XML.

TransportUnitCharacteristics

A group item defining and identifying the primary means of containing the goods. In some instances, the transport unit and vehicle are the same.

TransportUnitType [attribute]

TransportUnitType is mandatory. A single instance is required.

Provides general information about the

transport unit, which is the unit containing the goods. Transport units only move using power from another source, the transport vehicle. Additional detail can be specified through a detail type.

Refer to TransportUnitType definition for any enumerations.

TransportUnitVariable [attribute]

TransportUnitVariable is optional. A single instance might exist.

Indicates if there is an attribute of the transport unit that can change (is variable).

Refer to TransportUnitVariable definition for any enumerations.

TransportUnitLevel [attribute]

TransportUnitLevel is optional. A single instance might exist.

The sequential number that uniquely identifies the level of stacked transport units. For example, on a train with wagons loaded with containers the transport unit levels would be wagon level 1 and container level 2.

(sequence)

The sequence of items below is mandatory. A single instance is required.

TransportUnitCode

TransportUnitCode is optional. A single instance might exist.

A code defining the primary means of containing the goods.

TransportUnitMeasurements

TransportUnitMeasurements is optional. Multiple instances might exist.

A group item containing the measurements (length, height, weight, and width) of the transport unit.

TransportUnitEquipment

TransportUnitEquipment is optional. Multiple instances might exist.

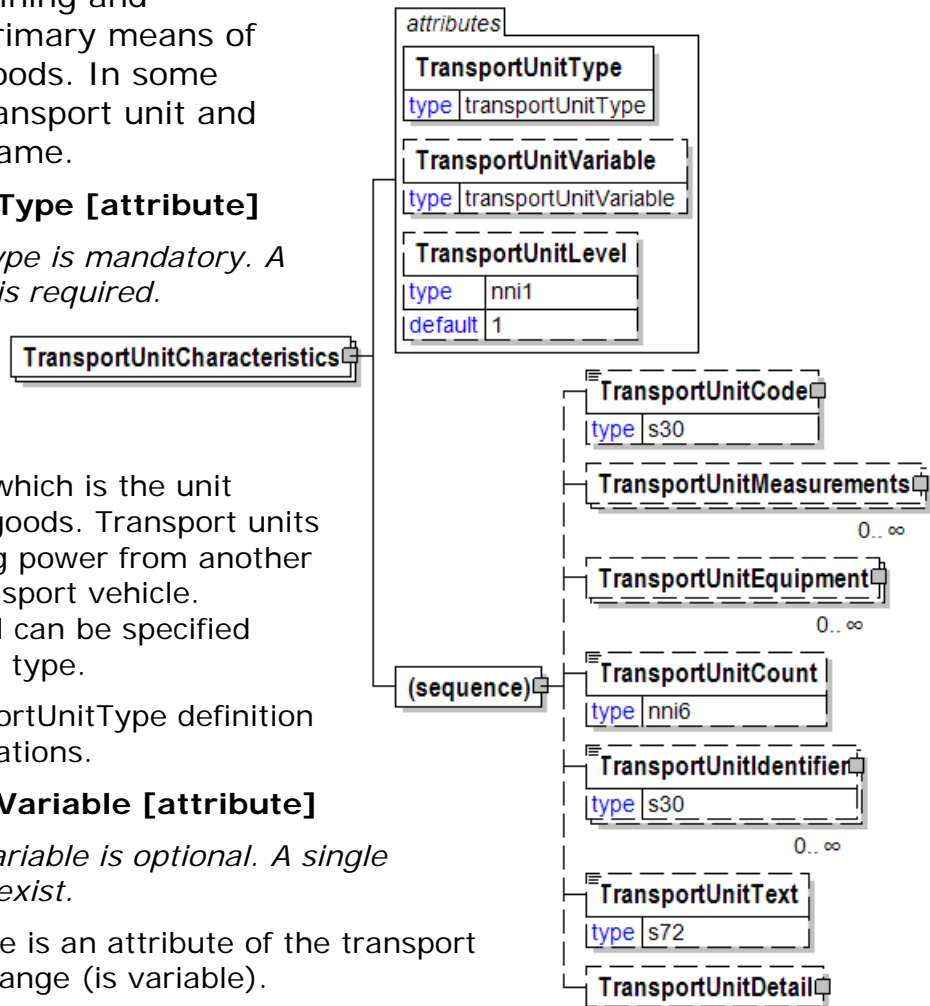

A group item defining extra equipment of the transport unit.

TransportUnitCount

TransportUnitCount is optional. A single instance might exist.

An item defining the number of units used to transport the goods.

TransportUnitIdentifier

TransportUnitIdentifier is optional. Multiple instances might exist.

The identifier of the transport unit, such as a container ID. It could be a license plate number if the transport unit is the vehicle at the same time. The type of identifier is indicated by the TransportUnitIdentifierType.

TransportUnitText

TransportUnitText is optional. A single instance might exist.

A text field further describing the transport unit.

TransportUnitDetail

TransportUnitDetail is optional. A single instance might exist.

A group item describing details for a transport unit.

TransportUnitCode

A code defining the primary means of containing the goods.

Agency [attribute]

Agency is mandatory. A single instance is required.

Describes the agency maintaining the list of codes. To be included in this list the agency must be a recognized standards body or industry organisation.

For the element that owns this attribute.

For another attribute in the list of attributes associated with the parent element.

Refer to Agency definition for any enumerations.

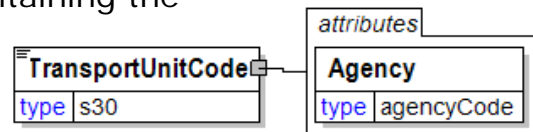

TransportUnitCount

An item defining the number of units used to transport the goods.

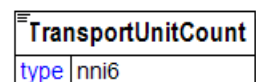

TransportUnitDetail

A group item describing details for a transport unit.

TransportUnitDetailType [attribute]

TransportUnitDetailType is optional. A single instance might exist.

Specifies detail type of a transport unit. If needed variants of a transport unit detail type can be specified by TransportUnitDetailCode in a Trading Partner Agreement as well as clarified in AdditionalText.

Refer to TransportUnitDetailType definition for any enumerations.

LoadOpeningSide [attribute]

LoadOpeningSide is optional. A single instance might exist.

Specifies opening sides on a transport unit for loading and unloading seen in the transport direction of the goods carrier

Refer to LoadOpeningSide definition for any enumerations.

(sequence)

The sequence of items below is mandatory. A single instance is required.

TransportUnitDetailCode

TransportUnitDetailCode is optional. A single instance might exist.

A code defining details of a transport unit.

AdditionalText

AdditionalText is optional. Multiple instances might exist.

A text field that is used to communicate information not previously defined or for special instructions. To be used only for circumstances not covered by specific elements.

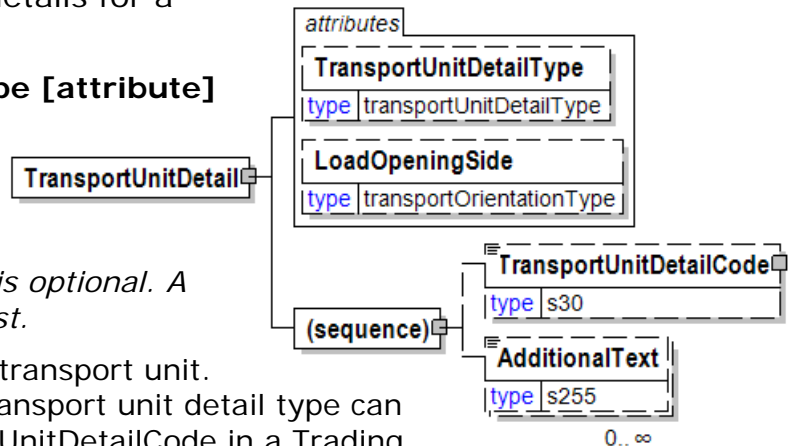

TransportUnitDetailCode

A code defining details of a transport unit.

Agency [attribute]

Agency is mandatory. A single instance is required.

Describes the agency maintaining the list of codes. To be included in this list the agency must be a recognized standards body or industry organisation.

For the element that owns this attribute.

For another attribute in the list of attributes associated with the parent element.



Refer to Agency definition for any enumerations.

TransportUnitDetailType [attribute]

Specifies detail type of a transport unit. If needed variants of a transport unit detail type can be specified by TransportUnitDetailCode in a Trading Partner Agreement as well as clarified in AdditionalText.

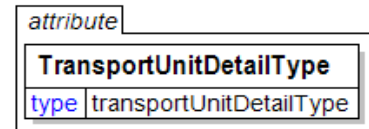

This item is restricted to the following list.

DryFreightContainer

The most widely used container for general cargo. It is available in 20 and 40 feet lengths. For high volume, low weight cargo, 9.5 foot high, 40 foot and 45 foot units are available giving an additional internal cubic capacity.

PlatformContainer

Container Platform Flats and Flatracks are primarily used for the containerisation of oversize, awkward and project cargoes that would otherwise be carried break bulk. These units are increasingly being used as temporary 'tweendecks' for the carriage of large, indivisible loads which are loaded separately on to a bed of flat-racks or platforms spread on top of a ship's hatch cover.

OpenSidesContainer

A container with loading and unloading via side and rear doors. It can also have a curtain side.

OpenTopContainer

A container with an open top that can be loaded via top side and rear doors. Covered by means of removable tilt. Open top containers are designed for the carriage of awkward, indivisible or oversize cargoes. The units offer increased versatility over standard boxes as they are designed for loading through both the top of the container and the rear doors. All units are equipped with a swinging cross-door beam header, which opens outwards to give unrestricted access through the door opening. The simplicity of loading and discharge and the full protection offered by a TIR approved tarpaulin provide a container that will ensure the safe passage of a broad range of cargoes.

OverheadContainer

A container with oversize measurements. Common types are "Open Top High Cube" and "Pallet Wide High Cube".

SwapBodyContainer

A container with foldable legs and transported on chassis. A SwapBody can easily be stored and swapped between different transport modes, usually road/rail. No handling equipment is needed. Swapbodies are designed for two-palletwide operations. The increased internal width of a swapbody unit allows two pallets (up to a maximum of 1200mm wide) to be loaded side by side.

BoxTrailer

Semi-railer completely closed only accessible with doors at rear end. The box

is often made of plywood.

CurtainsiderTrailer

Semi-Trailer with automatic or semi-automatic curtain that opens on the side. An other common used name is Tautliner.

DrawBarTrailer

A trailer with both front and rear axles usually towed by a lorry. It can be either covered or uncovered. A drawbar trailer carries the full load on its axles compared to a semi-trailer that only carries the half load on its rear axles. A semi-trailer can't move by itself because it only has wheels at the rear end.

GooseneckTrailer

Semi-Trailer with a stepdeck at the front end, i.e. not a flat platform. It can be both covered or uncovered.

HuckepackTrailer

Platform or Semi-Trailer with reinforcements and specially designed to be lifted on and off rail wagons. It makes it easy to mix transport modes for the transport unit from road to rail and vice versa. Synonym: StackTrain, Piggyback.

FlatbedTrailer

Semi-Trailer with an open flat platform.

SkeletalTrailer

A universal extensible skeletal chassis.

SkeletalContainerTrailer

A chassis designed to carry containers.

SkeletalDrawbarTrailer

A chassis with a drawbar.

SpecialTrailer

Semi-Trailer equipped with special features to load and unload goods. This type can have special designed floor to move goods without any external handling tools. Typical used names are CoilTrailer, Joloda, LoadMate, Rolamat, Selfloader and Walking floor. Dimensions on loading/unloading facilities, e.g. skates, may vary between makes. A CurtainSider with sliding roof is also typed as Special.

TerminalTrailer

Equipment which is not allowed on public roads and used for moving goods in terminals and warehouses. Normally these trailer types have no transport unit identifiers. Typical used names are Mafi, Platform and Roltrailer.

TiltTrailer

Semi-Trailer which can be closed by means of removable tilts.

BasketRailCar

A railcar with a demountable sub frame, fitted with devices for vertical handling, to allow the loading and unloading of semi-trailers or road vehicles.

ContainerRailCar

Open railcar designed to carry Containers, SwapBodies etc.

FlatRailCar

A railcar without roof or sides, or railcar without roof but with sides not higher than 60 cm, or swing-bolster railcar, of ordinary or special type. Railcars designed exclusively to carry containers, swap-bodies or goods vehicles are excluded.

HighSidedRailCar

A railcar with no roof and with rigid sides higher than 60 cm.

PocketRailCar

A railcar with a recessed pocket to accept the axle/wheel assembly of a semitrailer.

SpineRailCar

A rail railcar with a central chassis designed to carry a semi-trailer.

TransportUnitEquipment

A group item defining extra equipment of the transport unit.

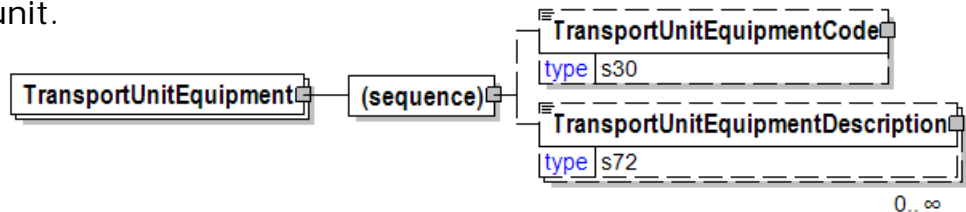

(sequence)

*The sequence of items below is mandatory.
A single instance is required.*

TransportUnitEquipmentCode

TransportUnitEquipmentCode is optional. A single instance might exist.

TransportUnitEquipmentCode is a code describing extra equipment of the transport unit.

TransportUnitEquipmentDescription

TransportUnitEquipmentDescription is optional. Multiple instances might exist.

A text field element describing the extra equipment of the transport unit.

TransportUnitEquipmentCode

TransportUnitEquipmentCode is a code describing extra equipment of the transport unit.

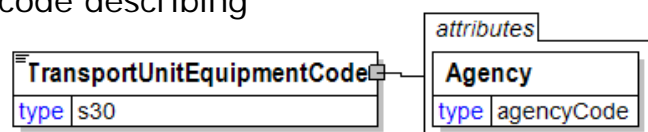

Agency [attribute]

Agency is mandatory. A single instance is required.

Describes the agency maintaining the list of codes. To be included in this list the agency must be a recognized standards body or industry organisation.

For the element that owns this attribute.

For another attribute in the list of attributes associated with the parent element.

Refer to Agency definition for any enumerations.

TransportUnitEquipmentDescription

A text field element describing the extra equipment of the transport unit.

Language [attribute]

Language is optional. A single instance might exist.

XML has embraced 2 and 3 digit language codes through the application of an addendum to the standard.

Refer to Language definition for any enumerations.



TransportUnitHeight

The height of the transport unit in a UOM (usually meters or feet).

(sequence)

The sequence of items below is mandatory. A single instance is required.

Value

Value is mandatory. A single instance is required.

A numeric value expressed in the unit of measure (UOM).

RangeMin

RangeMin is optional. A single instance might exist.

The minimum value (lower boundary) allowed for the Measurement that is the parent of this element.

RangeMax

RangeMax is optional. A single instance might exist.

The maximum value (upper boundary) allowed for the Measurement that is the parent of this element. Some elements use the RangeMax element with an extended list of unit of measures. (Note: the red colour in the picture is an artifact of how the graphic was captured and should be disregarded.)

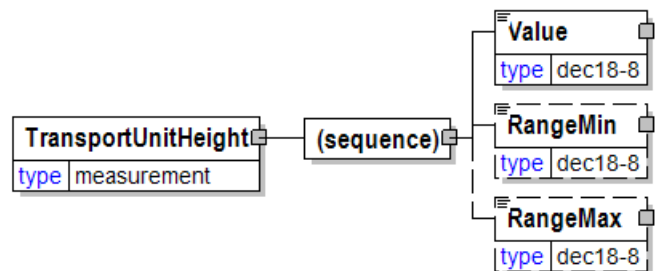

TransportUnitIdentifier

The identifier of the transport unit, such as a container ID. It could be a license plate number if the transport unit is the vehicle at the same time. The type of identifier is indicated by the TransportUnitIdentifierType.

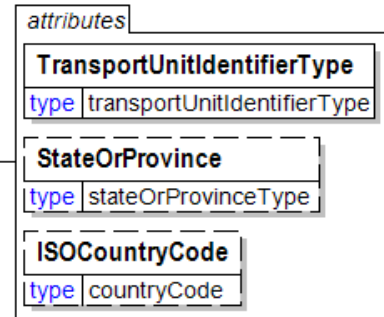
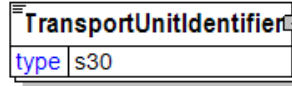

TransportUnitIdentifierType [attribute]

TransportUnitIdentifierType is mandatory. A single instance is required.

Provides a contextual definition for the value used to identify the transport unit.

Refer to TransportUnitIdentifierType definition for any enumerations.

StateOrProvince [attribute]

StateOrProvince is optional. A single instance might exist.

The political designation or boundary of a specific area of land.

ISOCountryCode [attribute]

ISOCountryCode is optional. A single instance might exist.

The valid list of ISO Country Codes.

Refer to ISOCountryCode definition for any enumerations.

TransportUnitIdentifierType [attribute]

Provides a contextual definition for the value used to identify the transport unit.

This item is restricted to the following list.

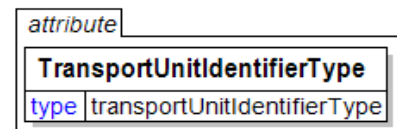

ContainerID

Defines a container identifier.

CassetteID

Defines a cassette identifier.

GlobalReturnableAssetIdentifier

A returnable asset is a reusable package or transport equipment of a certain value. The Global Returnable Asset Identifier (GRAI) provides for the unique identification of an asset; it utilizes a UCC assigned Company Prefix enabling a user to develop, assign and maintain a unique asset number for equipment, resources, supplies, etc. in order to track its location and/or user. The EAN.UCC identification number of a returnable asset (GRAI) is defined as a physical item with no reference to the contents. The EAN.UCC identification of a returnable asset (GRAI) enables tracking as well as recording of all relevant data.

RailCarID

A rail car identifier.

RFTag

The fixed built-in identifier of a RFID unit attached to a transport unit.

SealNumber

Identifies the seal that closes the transport unit.

SerialShippingContainerCode

The unique identification of logistics units is achieved in the EAN.UCC System by the use of the SSCC (Serial Shipping Container Code). The SSCC is an 18-digit numeric data structure. The uniqueness of the data structure is ensured through the use of the EAN.UCC Company Prefix, which is supplied by the UCC or another EAN Member Organization. This Company Prefix, when combined with the serial number that is assigned by the member company, acts as an identifier or "license plate" and provides access to information stored in computer files, which are transferred through electronic business transactions.

TrailerID

A trailer identifier. Note: This can be a licence plate number if the transport unit is the vehicle at the same time, or if the transport unit is a trailer with a licence plate number of its own. TrailerID is also used as identifier type for DrawBarCombination and RigidLorry.

WagonID

Will be removed in version v3r00. Use instead RailCarID

Other

Used for any other transport unit identifiers not covered by this list.

TransportUnitLength

The length of the transport unit in a valid UOM (usually meters or feet).

(sequence)

The sequence of items below is mandatory. A single instance is required.

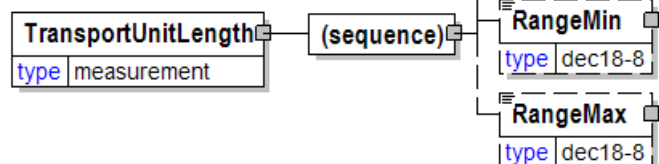

Value

Value is mandatory. A single instance is required.

A numeric value expressed in the unit of measure (UOM).

RangeMin

RangeMin is optional. A single instance might exist.

The minimum value (lower boundary) allowed for the Measurement that is the parent of this element.

RangeMax

RangeMax is optional. A single instance might exist.

The maximum value (upper boundary) allowed for the Measurement that is the parent of this element. Some elements use the RangeMax element with an

extended list of unit of measures. (Note: the red colour in the picture is an artifact of how the graphic was captured and should be disregarded.)

TransportUnitLevel [attribute]

The sequential number that uniquely identifies the level of stacked transport units. For example, on a train with wagons loaded with containers the transport unit levels would be wagon level 1 and container level 2.

attribute	
TransportUnitLevel	
type	nni1
default	1

TransportUnitMeasurements

A group item containing the measurements (length, height, weight, and width) of the transport unit.

AppliesTo [attribute]

AppliesTo is optional. A single instance might exist.

Specifies the type of item to which measurements apply to.

Refer to AppliesTo definition for any enumerations.

(sequence)

The sequence of items below is mandatory. A single instance is required.

TransportUnitLength

TransportUnitLength is optional. A single instance might exist.

The length of the transport unit in a valid UOM (usually meters or feet).

TransportUnitWidth

TransportUnitWidth is optional. A single instance might exist.

The width of the transport unit in a valid UOM (usually meters or feet).

TransportUnitHeight

TransportUnitHeight is optional. A single instance might exist.

The height of the transport unit in a UOM (usually meters or feet).

TransportUnitWeight

TransportUnitWeight is optional. A single instance might exist.

The weight of the transport unit in a valid UOM (usually tons, pounds, or kilograms).

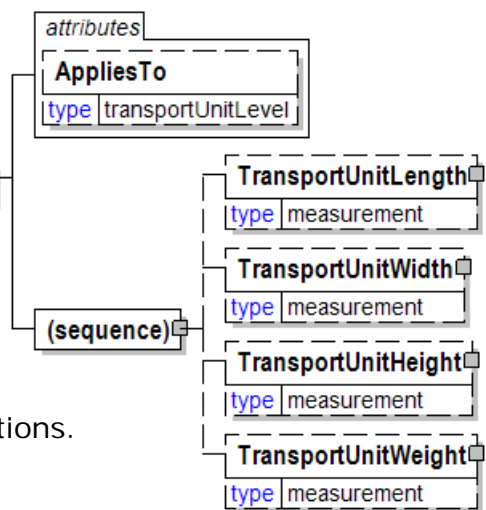

TransportUnitText

A text field further describing the transport unit.

TransportUnitText	
type	s72

TransportUnitType [attribute]

Provides general information about the transport unit, which is the unit containing the goods. Transport units only move using power from another source, the transport vehicle. Additional detail can be specified through a detail type.

attribute	TransportUnitType	
type	transportUnitType	

This item is restricted to the following list.

Barge

A flat, inland waterways transport unit, which is typically towed, one or many at the same time, by a towing vessel.

Cassette

A platform used for RORO vessels to roll-on and roll-off goods to be moved.

Container

A generic term for a box to carry goods, strong enough for repeated use, usually stackable and fitted with devices for transfer between modes. There are a number of different types of containers.

ConventionalVessel

To be removed in version v3r00. Select the best fit from the TransportUnitType list.

DrawBarCombination

A RigidLorry and a DrawBarTrailer combined together and handled as one transport unit. It is typically used in Scandinavian countries.

Flatbed

To be removed in version v3r00. See detail types.

FlatCar

To be removed in version v3r00. See detail types.

RailCar

A rail-based, covered mode of transport. Synonym: Rail Wagon.

RigidLorry

Carries goods in a body mounted to the chassis of a truck. It can be covered or uncovered. Synonym: Straight Truck.

StackTrain

To be removed in v3r00. See detail types.

SwapBodies

To be removed in v3r00. See detail types.

Trailer

A road trailer usually pulled by a truck.

Wagon

To be removed in v3r00. Use instead transport unit "RailCar" and detail types of railcars.

Other

Used for any other transport units not covered by this list. To be removed in version v3r00.

TransportUnitVariable [attribute]

Indicates if there is an attribute of the transport unit that can change (is variable).

This item is restricted to the following list.

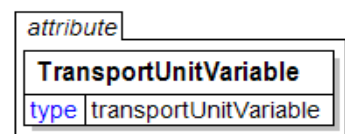

CubicCapacity

DeckOption

Height

Length

RailcarDoorSize

WeightCarryingCapacity

TransportUnitWeight

The weight of the transport unit in a valid UOM (usually tons, pounds, or kilograms).

(sequence)

The sequence of items below is mandatory. A single instance is required.

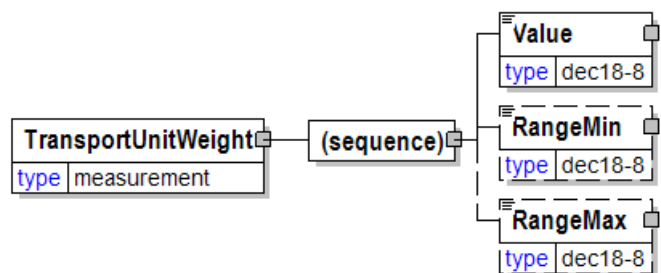

Value

Value is mandatory. A single instance is required.

A numeric value expressed in the unit of measure (UOM).

RangeMin

RangeMin is optional. A single instance might exist.

The minimum value (lower boundary) allowed for the Measurement that is the parent of this element.

RangeMax

RangeMax is optional. A single instance might exist.

The maximum value (upper boundary) allowed for the Measurement that is the parent of this element. Some elements use the RangeMax element with an extended list of unit of measures. (Note: the red colour in the picture is an artifact of how the graphic was captured and should be disregarded.)

TransportUnitWidth

The width of the transport unit in a valid UOM (usually meters or feet).

(sequence)

The sequence of items below is mandatory. A single instance is required.

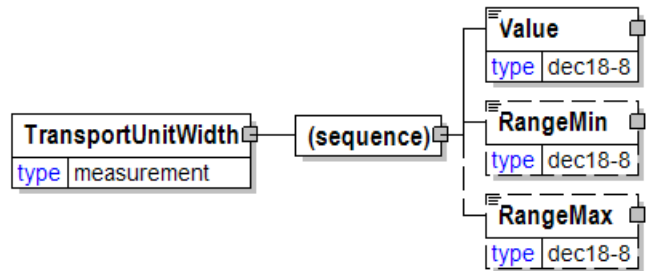

Value

Value is mandatory. A single instance is required.

A numeric value expressed in the unit of measure (UOM).

RangeMin

RangeMin is optional. A single instance might exist.

The minimum value (lower boundary) allowed for the Measurement that is the parent of this element.

RangeMax

RangeMax is optional. A single instance might exist.

The maximum value (upper boundary) allowed for the Measurement that is the parent of this element. Some elements use the RangeMax element with an extended list of unit of measures. (Note: the red colour in the picture is an artifact of how the graphic was captured and should be disregarded.)

TransportUnloadingCharacteristics

A group item defining how the transported items are to be unloaded.

TransportUnloadingType [attribute]

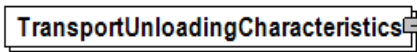

TransportUnloadingType is optional. A single instance might exist.

Defines the primary unloading modes for the transport of the goods

Refer to TransportUnloadingType definition for any enumerations.

DirectUnloading [attribute]

DirectUnloading is optional. A single instance might exist.

Specifies if the transport unit should be unloaded directly on to a new transport unit. Certain transport units, e.g. cassettes, can be stored in warehouses a short period waiting for direct unloading.

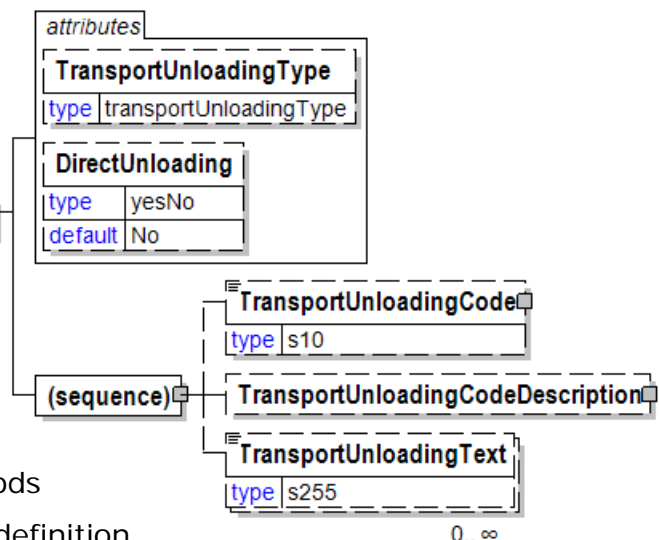

Refer to DirectUnloading definition for any enumerations.

(sequence)

The sequence of items below is mandatory. A single instance is required.

TransportUnloadingCode

TransportUnloadingCode is optional. A single instance might exist.

A code defining how the transported items are to be unloaded.

TransportUnloadingCodeDescription

TransportUnloadingCodeDescription is optional. A single instance might exist.

A group item describing the TransportUnloadingCode. The document specifying how to unload goods based on the TransportUnloadingCode can be supplied in e-Attachment.

TransportUnloadingText

TransportUnloadingText is optional. Multiple instances might exist.

A text field further describing the transport unloading instructions.

TransportUnloadingCode

A code defining how the transported items are to be unloaded.

Agency [attribute]

Agency is mandatory. A single instance is required.

Describes the agency maintaining the list of codes. To be included in this list the agency must be a recognized standards body or industry organisation.

For the element that owns this attribute.

For another attribute in the list of attributes associated with the parent element.

Refer to Agency definition for any enumerations.

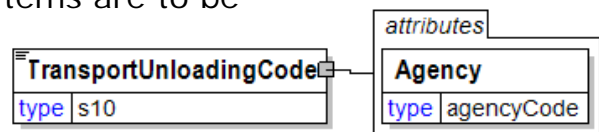

TransportUnloadingCodeDescription

A group item describing the TransportUnloadingCode. The document specifying how to unload goods based on the

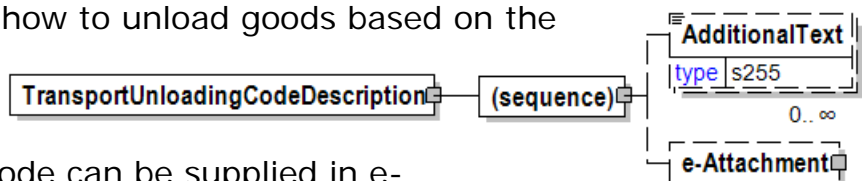

TransportUnloadingCode can be supplied in e-Attachment.

(sequence)

The sequence of items below is mandatory. A single instance is required.

AdditionalText

AdditionalText is optional. Multiple instances might exist.

A text field that is used to communicate information not previously defined or for special instructions. To be used only for circumstances not covered by specific elements.

e-Attachment

e-Attachment is optional. A single instance might exist.

e-Attachment enables the sender to provide information about attachments to the document.

Note: BizTalk users may have problems in processing this element. See the papiNet FAQs (papiNet.org) for more information.

TransportUnloadingText

A text field further describing the transport unloading instructions.

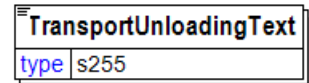

TransportUnloadingType [attribute]

Defines the primary unloading modes for the transport of the goods

This item is restricted to the following list.

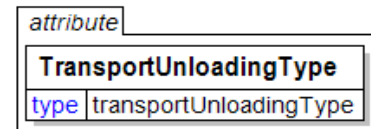

ByUnloadingCode

How to unload the goods is specified via the element TransportUnloadingCode. TransportUnloadingCode can be used as a Load Pattern identifier. A separate document, that can be specified by element TransportUnloadingCodeDescription, specifies the Load Pattern in all details

Lying

The goods, such as reels on the belly, have to be in a lying position after unloading.

Standing

The goods, such as reels standing on end, have to be in a standing position after unloading.

StandingUpsideDown

The goods, such as reels standing on end but turned upside-down in a standing position after unloading. Reels are turned upside-down to get the right unwinding direction at end user.

Other

Used for any other loading modes not covered by this list.

TransportVehicleCharacteristics

A group item defining the primary means of transporting the goods, such as a side port vessel. In some instances, the transport unit and vehicle are the same.

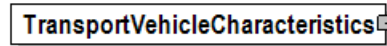

TransportVehicleType [attribute]

TransportVehicleType is optional. A single instance might exist.

Provides details on the transport vehicle. A transport vehicle has its own power and can be used to pull, carry, or tow a transport unit loaded with goods.

Refer to TransportVehicleType definition for any enumerations.

(sequence)

The sequence of items below is mandatory. A single instance is required.

TransportVehicleCode

TransportVehicleCode is optional. A single instance might exist.

A code defining the primary means of transporting the goods.

TransportVehicleMeasurements

TransportVehicleMeasurements is optional. A single instance might exist.

A group item containing the measurements (length, height, weight, and width) of the transport vehicle.

TransportVehicleEquipment

TransportVehicleEquipment is optional. Multiple instances might exist.

A group item defining extra equipment of the transport vehicle.

TransportVehicleCount

TransportVehicleCount is optional. A single instance might exist.

The number of vehicles used to transport the goods.

TransportVehicleIdentifier

TransportVehicleIdentifier is optional. Multiple instances might exist.

The identifier of the transport vehicle (license plate number, voyage number, or vessel name). TransportVehicleIdentifier contains the TransportVehicleIdentifierType attribute.

TransportVehicleText

TransportVehicleText is optional. A single instance might exist.

A text field further describing the transport vehicle.

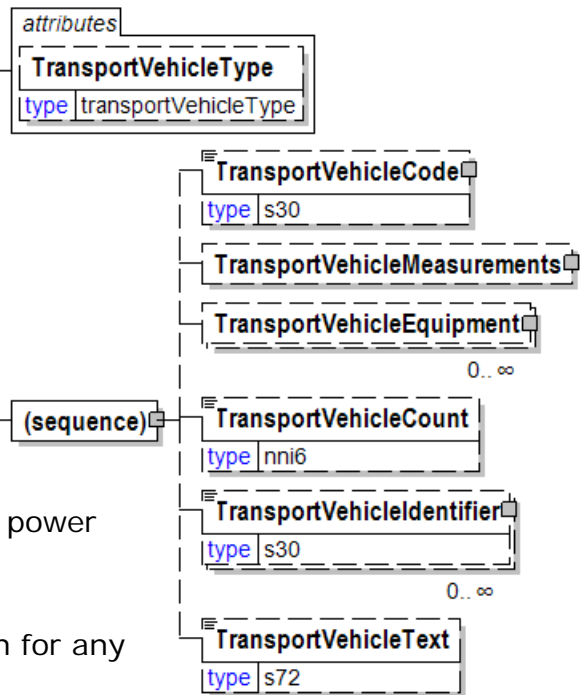

TransportVehicleCode

A code defining the primary means of transporting the goods.

Agency [attribute]

Agency is mandatory. A single instance is required.

Describes the agency maintaining the list of codes. To be included in this list the agency must be a recognized standards body or industry organisation.

For the element that owns this attribute.

For another attribute in the list of attributes associated with the parent element.

Refer to Agency definition for any enumerations.

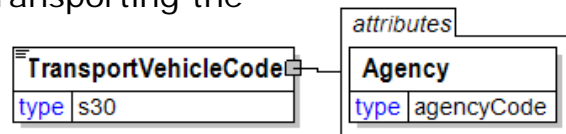

TransportVehicleCount

The number of vehicles used to transport the goods.

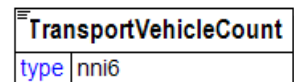

TransportVehicleEquipment

A group item defining extra equipment of the transport vehicle.

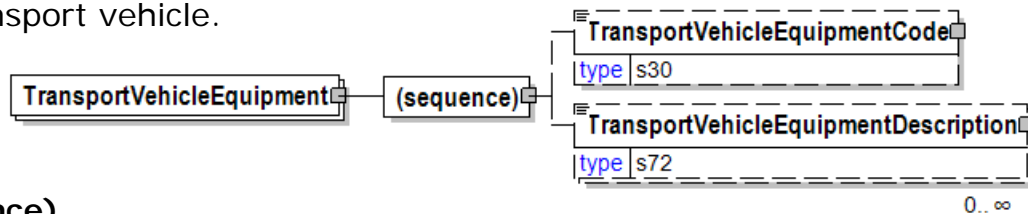

(sequence)

The sequence of items below is mandatory. A single instance is required.

TransportVehicleEquipmentCode

TransportVehicleEquipmentCode is optional. A single instance might exist.

TransportVehicleEquipmentCode is a code describing extra equipment of the transport vehicle.

TransportVehicleEquipmentDescription

TransportVehicleEquipmentDescription is optional. Multiple instances might exist.

A text field element describing the extra equipment of the transport vehicle.

TransportVehicleEquipmentCode

TransportVehicleEquipmentCode is a code describing extra equipment of the transport vehicle.

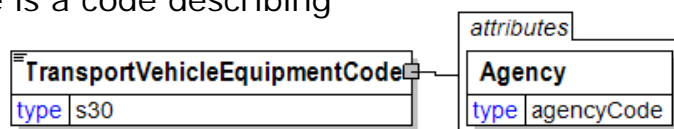

Agency [attribute]

Agency is mandatory. A single instance is required.

Describes the agency maintaining the list of codes. To be included in this list the agency must be a recognized standards body or industry organisation.

For the element that owns this attribute.

For another attribute in the list of attributes associated with the parent element.

Refer to Agency definition for any enumerations.

TransportVehicleEquipmentDescription

A text field element describing the extra equipment of the transport vehicle.

Language [attribute]

Language is optional. A single instance might exist.

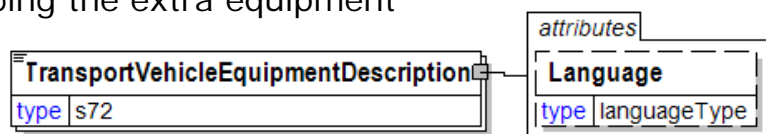

XML has embraced 2 and 3 digit language codes through the application of an addendum to the standard.

Refer to Language definition for any enumerations.

TransportVehicleHeight

The number of vehicles used to transport the goods.

(sequence)

The sequence of items below is mandatory. A single instance is required.

Value

Value is mandatory. A single instance is required.

A numeric value expressed in the unit of measure (UOM).

RangeMin

RangeMin is optional. A single instance might exist.

The minimum value (lower boundary) allowed for the Measurement that is the parent of this element.

RangeMax

RangeMax is optional. A single instance might exist.

The maximum value (upper boundary) allowed for the Measurement that is the parent of this element. Some elements use the RangeMax element with an extended list of unit of measures. (Note: the red colour in the picture is an artifact of how the graphic was captured and should be disregarded.)

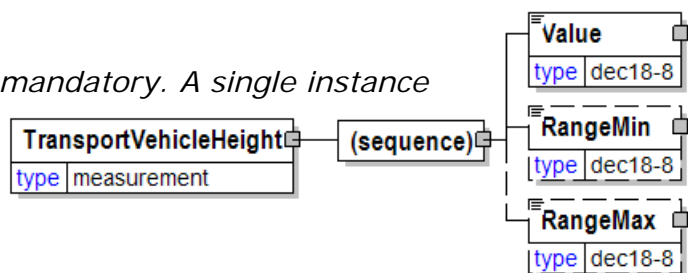

TransportVehicleIdentifier

The identifier of the transport vehicle (license plate number, voyage number, or vessel name). TransportVehicleIdentifier contains the TransportVehicleIdentifierType attribute.

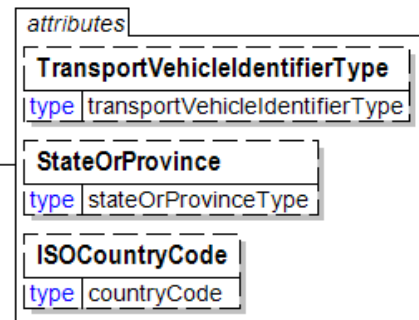
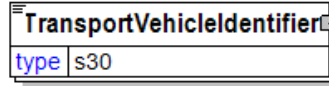

TransportVehicleIdentifierType [attribute]

TransportVehicleIdentifierType is optional. A single instance might exist.

Provides a contextual definition for the value used to identify the transport vehicle.

Refer to TransportVehicleIdentifierType definition for any enumerations.

StateOrProvince [attribute]

StateOrProvince is optional. A single instance might exist.

The political designation or boundary of a specific area of land.

ISOCountryCode [attribute]

ISOCountryCode is optional. A single instance might exist.

The valid list of ISO Country Codes.

Refer to ISOCountryCode definition for any enumerations.

TransportVehicleIdentifierType [attribute]

Provides a contextual definition for the value used to identify the transport vehicle.

This item is restricted to the following list.

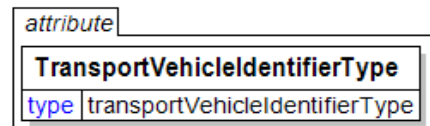

FlightNumber

A flight number.

GlobalReturnableAssetIdentifier

To be removed in v3r00.

IMONumber

An identifier type for a Vessel

LicencePlateNumber

A licence plate number.

RadioCallSign

An identifier type for a Vessel

RFTag

The fixed built-in identifier of a RFID unit attached to transport vehicle.

SerialisedShippingContainerCode

To be removed in v3r00.

StandardCarrierAlphaCode

The code used to identify the carrier by the applicable governing body.

TrainNumber

The official identifier assigned by the railways to this particular train movement.

VesselName

The registered name of the vessel.

VoyageNumber

The official identifier assigned for the voyage, usually by port authorities. Also known as Unique Voyage Identifier, UVI.

Other

Used for any other transport vehicle identifiers not covered by this list.

TransportVehicleLength

The length of the transport vehicle in a valid UOM (usually meters or feet).

(sequence)

The sequence of items below is mandatory. A single instance is required.

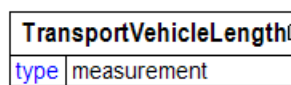

Value

Value is mandatory. A single instance is required.

A numeric value expressed in the unit of measure (UOM).

RangeMin

RangeMin is optional. A single instance might exist.

The minimum value (lower boundary) allowed for the Measurement that is the parent of this element.

RangeMax

RangeMax is optional. A single instance might exist.

The maximum value (upper boundary) allowed for the Measurement that is the parent of this element. Some elements use the RangeMax element with an extended list of unit of measures. (Note: the red colour in the picture is an artifact of how the graphic was captured and should be disregarded.)

TransportVehicleMeasurements

A group item containing the measurements (length, height, weight, and width) of the transport vehicle.

(sequence)

The sequence of items below is mandatory. A single instance is required.

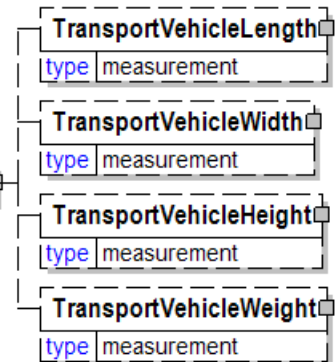
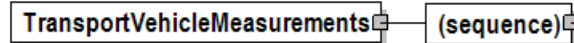

TransportVehicleLength

TransportVehicleLength is optional. A single instance might exist.

The length of the transport vehicle in a valid UOM (usually meters or feet).

TransportVehicleWidth

TransportVehicleWidth is optional. A single instance might exist.

The width of the transport vehicle in a valid UOM (usually meters or feet).

TransportVehicleHeight

TransportVehicleHeight is optional. A single instance might exist.

The number of vehicles used to transport the goods.

TransportVehicleWeight

TransportVehicleWeight is optional. A single instance might exist.

The weight of the transport vehicle in a valid UOM (usually tons, pounds, or kilograms).

TransportVehicleText

A text field further describing the transport vehicle.

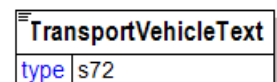

TransportVehicleType [attribute]

Provides details on the transport vehicle. A transport vehicle has its own power and can be used to pull, carry, or tow a transport unit loaded with goods.

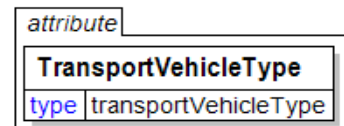

This item is restricted to the following list.

Barge

A flat, inland waterways vessel.

ContainerVessel

A vessel for sea transports designed to carry containers.

ConventionalVessel

A vessel for sea transports, loaded/unloaded by LOLO (lift-on/lift-off method).

RollOnOffShip

A vessel for sea transport, loaded/unloaded by RORO (roll-on/roll-off method).

SidePortVessel

A vessel for sea transport, loaded/unloaded through side ports in the vessel side.

Train

A rail-based vehicle for towing of railcars.

Truck

A road vehicle for carrying, pulling or towing of transport units. Other used names are Tractor and Lorry.

TruckTrailer

To be removed in Version v3r00. Use Truck instead.

Other

Used for any other transport vehicles not covered by this list.

TransportVehicleWeight

The weight of the transport vehicle in a valid UOM (usually tons, pounds, or kilograms).

(sequence)

The sequence of items below is mandatory. A single instance is required.

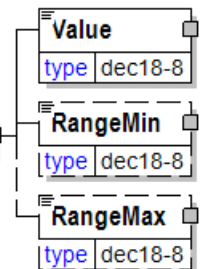
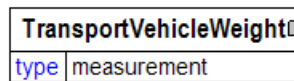

Value

Value is mandatory. A single instance is required.

A numeric value expressed in the unit of measure (UOM).

RangeMin

RangeMin is optional. A single instance might exist.

The minimum value (lower boundary) allowed for the Measurement that is the parent of this element.

RangeMax

RangeMax is optional. A single instance might exist.

The maximum value (upper boundary) allowed for the Measurement that is the parent of this element. Some elements use the RangeMax element with an extended list of unit of measures. (Note: the red colour in the picture is an artifact of how the graphic was captured and should be disregarded.)

TransportVehicleWidth

The width of the transport vehicle in a valid UOM (usually meters or feet).

(sequence)

The sequence of items below is mandatory. A single instance is required.

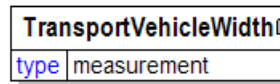

(sequence)

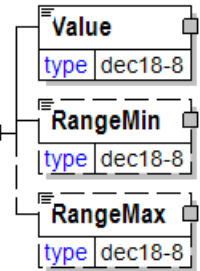

Value

Value is mandatory. A single instance is required.

A numeric value expressed in the unit of measure (UOM).

RangeMin

RangeMin is optional. A single instance might exist.

The minimum value (lower boundary) allowed for the Measurement that is the parent of this element.

RangeMax

RangeMax is optional. A single instance might exist.

The maximum value (upper boundary) allowed for the Measurement that is the parent of this element. Some elements use the RangeMax element with an extended list of unit of measures. (Note: the red colour in the picture is an artifact of how the graphic was captured and should be disregarded.)

TrayColourType [attribute]

The type of tray colour.

This item is restricted to the following list.

Clear

The tray colour is clear.

Coloured

Frosted

Graphite

StandardGray/Brown

The tray colour is standard gray or brown.

White

The tray colour is white.

Other

Another colour is used.

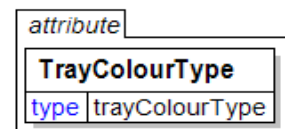

TreeSpeciesGroup

A grouping element that details information used for describing tree species.

(sequence)

The sequence of items below is mandatory. A single instance is required.

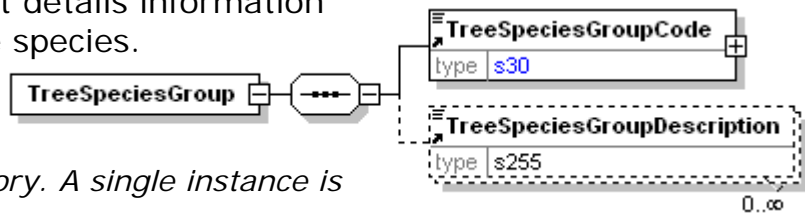

TreeSpeciesGroupCode

TreeSpeciesGroupCode is mandatory. A single instance is required.

A code defining tree species or groups of tree species.

TreeSpeciesGroupDescription

TreeSpeciesGroupDescription is optional. Multiple instances might exist.

A text description of the tree species group.

TreeSpeciesGroupCode

A code defining tree species or groups of tree species.

Agency [attribute]

Agency is mandatory. A single instance is required.

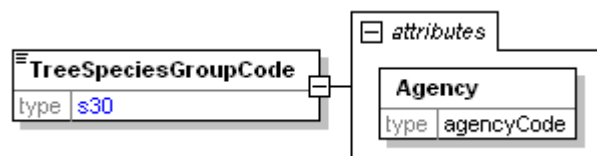

Describes the agency maintaining the list of codes. To be included in this list the agency must be a recognized standards body or industry organisation.

For the element that owns this attribute.

- For another attribute in the list of attributes associated with the parent element.

Refer to Agency definition for any enumerations.

TreeSpeciesGroupDescription

A text description of the tree species group.

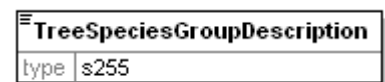

Trim

Trim

TrimType [attribute]

TrimType is optional. A single instance might exist.

Trim type

Refer to TrimType definition for any enumerations.

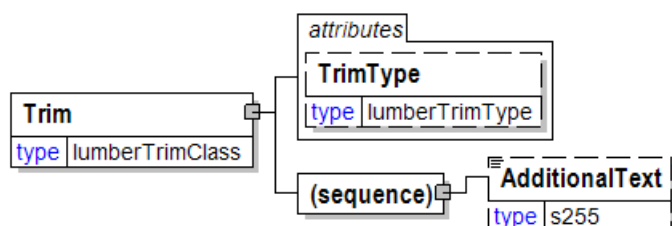

(sequence)

The sequence of items below is mandatory. A single instance is required.

AdditionalText

AdditionalText is optional. A single instance might exist.

A text field that is used to communicate information not previously defined or for special instructions. To be used only for circumstances not covered by specific elements.

TrimmedOrderType

Trimmed Order Type

This item is restricted to the following list.

TrimmedOrderType
type trimmedOrderType

Explicit

Implicit

TrimmedReel

Trimmed reel

(sequence)

The sequence of items below is mandatory. A single instance is required.

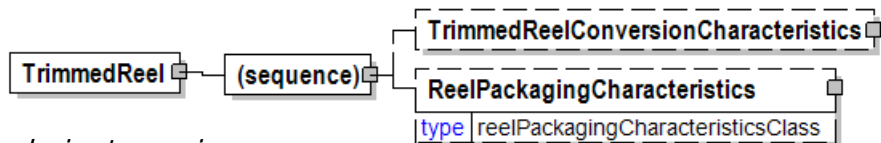

TrimmedReelConversionCharacteristics

TrimmedReelConversionCharacteristics is optional. A single instance might exist.

Conversion characteristics associated with a trimmed reel.

ReelPackagingCharacteristics

ReelPackagingCharacteristics is optional. A single instance might exist.

A group item that lists the packaging elements describing how a reel should be packed.

TrimmedReelConversionCharacteristics

Conversion characteristics associated with a trimmed reel.

(sequence)

The sequence of items below is mandatory. A single instance is required.

WindingDirection

WindingDirection is optional. A single instance might exist.

An element that indicates how the material is wound on the reel.

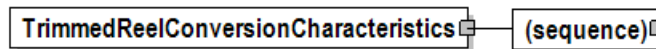

Refer to WindingDirection definition for any enumerations.

TrimmedOrderType

TrimmedOrderType is optional. A single instance might exist.

Trimmed Order Type

Refer to TrimmedOrderType definition for any enumerations.

MasterReelWidth

MasterReelWidth is optional. A single instance might exist.

The master reel width.

ReelDiameter

ReelDiameter is optional. A single instance might exist.

The diameter measurement of reel excluding packaging.

ReelLength

ReelLength is optional. A single instance might exist.

The total length of the paper on the reel.

MaximumOffcut

MaximumOffcut is optional. A single instance might exist.

Maximum off cut.

CoreCharacteristics

CoreCharacteristics is optional. A single instance might exist.

A group item that details information used to fully define a core.

MaximumNumberOfJoins

MaximumNumberOfJoins is optional. A single instance might exist.

The maximum number of joins requested (permitted). Permits customers to indicate join-free reels.

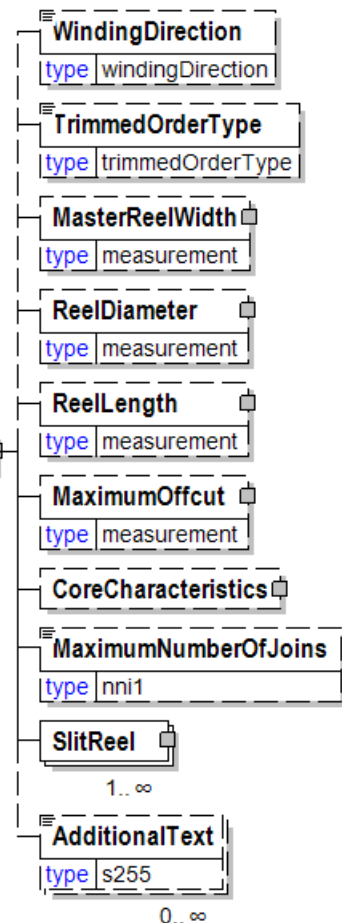

SlitReel

SlitReel is mandatory. One instance is required, multiple instances might exist.

The SlitReel element represents the elements associated with reel that has been slit into multiple reels.

AdditionalText

AdditionalText is optional. Multiple instances might exist.

A text field that is used to communicate information not previously defined or for special instructions. To be used only for circumstances not covered by specific elements.

TrimSize

Trim size.

(sequence)

The sequence of items below is mandatory. A single instance is required.

Length

Length is mandatory. A single instance is required.

The length of the object.

Width

Width is mandatory. A single instance is required.

The width of the object.

BookBlockBulk

BookBlockBulk is optional. A single instance might exist.

Measurement of the thickness of the book block.

SpineSize

SpineSize is optional. A single instance might exist.

The height of the spine.

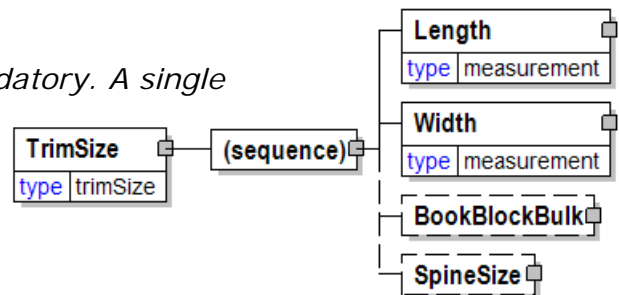

TrimType [attribute]

Trim type

This item is restricted to the following list.

DET

PET

SquareEndTrim

Other

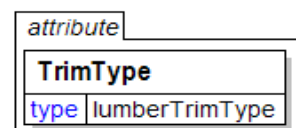

TwoSigmaLower

Two sigma (a measure of dispersion associated with standard deviation) on the lower side of the standard deviation.

UOM [attribute]

UOM is mandatory. A single instance is required.

Defines the unit of measure for the value.

Refer to UOM definition for any enumerations.

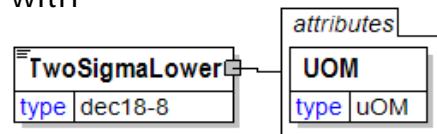

TwoSigmaUpper

Two sigma (a measure of dispersion associated with standard deviation) on the upper side of the standard deviation.

UOM [attribute]

UOM is mandatory. A single instance is required.

Defines the unit of measure for the value.

Refer to UOM definition for any enumerations.

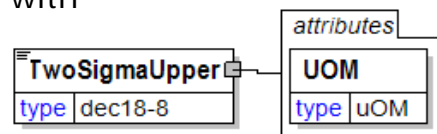

UnCompletedMeasurement [attribute]

Indicates if the measuring of an item is uncompleted, i.e. if some measurement values are missing.

This item is restricted to the following list.

Yes

No

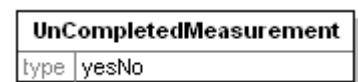

UnevenSpacing

Uneven Spacing

(sequence)

The sequence of items below is mandatory. A single instance is required.

[Any Type]

Any type of content is permitted at this point.

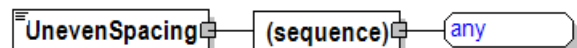

UnitCharacteristics

Unit characteristics.

(sequence)

The sequence of items below is mandatory. A single instance is required.

Height

Height is optional. A single instance might exist.

The height of the object.

Thickness

Thickness is optional. A single instance might exist.

Physical dimension of a product.

Width

Width is optional. A single instance might exist.

The width of the object.

Weight

Weight is optional. A single instance might exist.

The weight of the item.

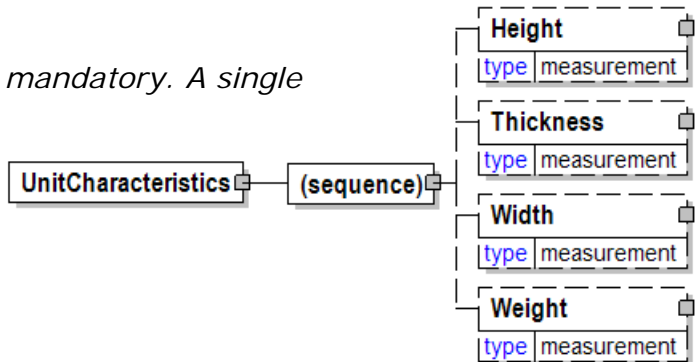

UnitDimension

Unit Dimension

(sequence)

The sequence of items below is mandatory. A single instance is required.

Length

Length is optional. A single instance might exist.

The following approach is used in the timber/lumber related constructs.

Width

Width is optional. A single instance might exist.

The approach for width used in the timber/lumber related constructs.

Height

Height is optional. A single instance might exist.

The height of the object. (Used in wood/timber items.)

PiecesPerRow

PiecesPerRow is optional. A single instance might exist.

This element details the number of pieces or individual items that are to be

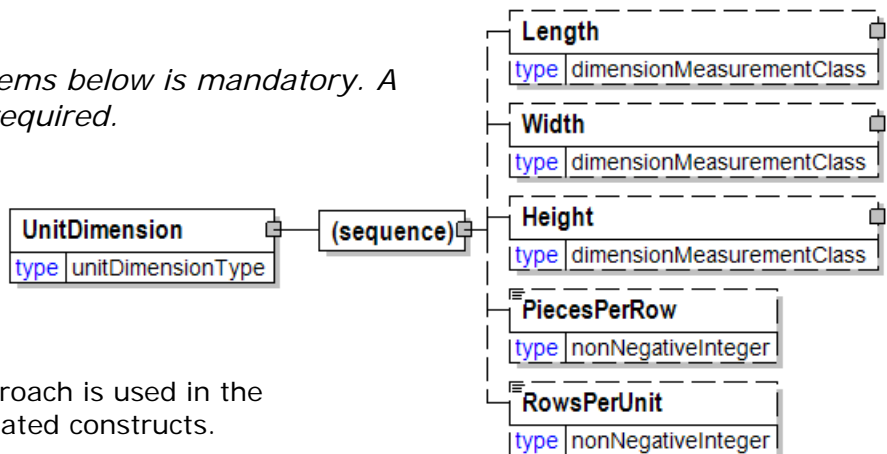

placed/packaged in a row within the unit. Usually used to identify the standard number of pieces in a standard packaging unit of the product.

RowsPerUnit

RowsPerUnit is optional. A single instance might exist.

The number of rows of items, are to be placed/packaged within the unit. Usually used to identify the standard number of rows in a standard packaging unit of the product.

UnitItem

Unit Item.

(sequence)

The sequence of items below is mandatory. A single instance is required.

Identifier

Identifier is optional. Multiple instances might exist.

An Identifier is required for packages and items (pallets, reel packages, boxes, ream items, reel items, etc). The Identifier element contains the actual item identifier code. Identifier is repeatable so more than one identifier can be communicated. For example, the printed identifier on a label may be different from the barcode printed on the label.

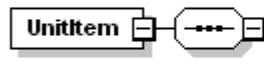

Product

Product is optional. A single instance might exist.

Product is a group item defining the article and its characteristics. Product is used to specify product characteristics organized by ProductIdentifier, ProductDescription, and Classification. Book Manufacturing, Label Stock, Paper, Pulp, Recovered Paper, Wood Products, and Virgin Fibre market segments have defined their product characteristics and conversion features for implementation in papiNet.

UnitCharacteristics

UnitCharacteristics is optional. A single instance might exist.

Unit characteristics.

Quantity

Quantity is optional. A single instance might exist.

The Quantity element contains attributes that provide information about the type of quantity that is being communicated, the context in which the particular quantity is to be viewed, and (if the quantity represents an adjustment) an adjustment type.

The Quantity element contains three child elements that enable you to

communicate a range of values for the quantity and a target or actual value. It is at this level (Value, RangeMin, and RangeMax) that the unit of measure is specified. This permits the range to be specified in a different unit of measure than the target.

InformationalQuantity

InformationalQuantity is optional. Multiple instances might exist.

A quantity given in a valid UOM used for information purposes only (not for calculation). For example, an ordered quantity was 100 reels as opposed to the invoice quantity of 20,000 pounds.

UnitReference

UnitReference is optional. Multiple instances might exist.

An element detailing relevant references pertaining to the Unit. The type of reference is identified by the attributes UnitReferenceType and AssignedBy.

OtherDate

OtherDate is optional. Multiple instances might exist.

A date that may not be specifically detailed within a document (example: print date at the PurchaseOrderLineItem).

SafetyAndEnvironmentalInformation

SafetyAndEnvironmentalInformation is optional. Multiple instances might exist.

Name of certification type, if any, on the goods (For example, FSC, PEFC). SafetyAndEnvironmental needs a value or measurement to communicate the percentage of the product is certified (for example, 75% is certified by the indicated agency).

UnitReference

An element detailing relevant references pertaining to the Unit. The type of reference is identified by the attributes UnitReferenceType and AssignedBy.

UnitReferenceType [attribute]

UnitReferenceType is mandatory. A single instance is required.

Provides a contextual explanation of the specific reference identifier. Many items are currently prefixed by "Buyer", "Forwarder", "Manufacturer", "Mill", "Seller", "Supplier", "Warehouse", or "Vendor". Check for an existing non-prefixed version and use the non-prefixed version instead. In the (yet to be announced release date) version 3.0 the prefixed versions will be removed. Instead the attribute @AssignedBy will communicate the information previously communicated in the prefix.

Refer to UnitReferenceType definition for any enumerations.

AssignedBy [attribute]

AssignedBy is mandatory. A single instance is required.

Identifies the type of party that has assigned the associated item, e.g. a reference of type OrderNumber.

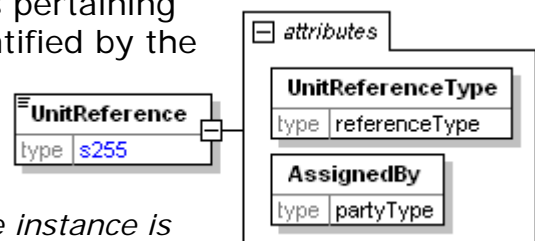

Refer to AssignedBy for any enumerations.

UnitReferenceType [attribute]

Provides a contextual explanation of the specific reference identifier. Many items are currently prefixed by "Buyer", "Forwarder", "Manufacturer", "Mill", "Seller", "Supplier", "Warehouse" or "Vendor". Check for an existing non-prefixed version and use the non-prefixed version instead. In the (yet to be announced release date) version 3.0 the prefixed versions will be removed. Instead the attribute AssignedBy will communicate the information previously communicated in the prefix.

UnitReferenceType	
type	referenceType

Refer to the [referenceType](#) entry for the list of enumerations and their definitions.

UnitsPerCarton

The number of units per box.

(sequence)

The sequence of items below is mandatory. A single instance is required.

Value

Value is mandatory. A single instance is required.

A numeric value expressed in the unit of measure (UOM).

RangeMin

RangeMin is optional. A single instance might exist.

The minimum value (lower boundary) allowed for the Measurement that is the parent of this element.

RangeMax

RangeMax is optional. A single instance might exist.

The maximum value (upper boundary) allowed for the Measurement that is the parent of this element. Some elements use the RangeMax element with an extended list of unit of measures. (Note: the red colour in the picture is an artifact of how the graphic was captured and should be disregarded.)

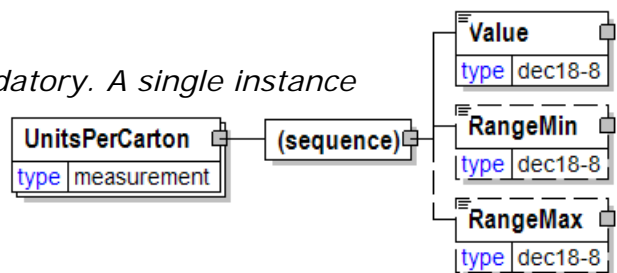

UOM [attribute]

Defines the unit of measure for the value.

This item is restricted to the following list.

AirDryMetricTonne

A unit of measure that identifies the product as 1000 kilograms of product that has been calculated based on an accepted standard representing the contents to be 90% fibre and 10% moisture and adjusted

attribute	
UOM	
type	uOM

using a moisture percentage test. The AirDryMetricTonne is calculated as $GrossWeight \times (100 - moisture\% / 90)$

AirDryPercent

The percentage measured at the time of production using the air dry industry standard (90% fibre, 10% moisture) therefore, $102 \text{ AirDryPercent} = 102 \text{ AirDryPercent} / 100 * 90\% = 91.8\%$ fibres.

AirDryShortTon

A unit of measure that identifies the product as 2000 pounds of product that has been calculated based on an accepted standard representing the contents to be 90% fibre and 10% moisture and further adjusted using a moisture percentage test. The AirDryShortTon is calculated as $GrossWeight \times (100 - moisture\% / 90)$

Bale

The measurement value is a count of bales. A single or rectangular grouping of product

BoardFoot

The measurement value is expressed in board feet.

BookUnit

A copy of a book.

Box

The measurement value is a count of boxes.

Bundle

The measurement value is a count of bundles.

C-Size

Celsius

The measurement value is in Celsius temperature degrees.

Centimeter

The measurement value is expressed in centimetres.

CentimeterPerSecond

Centimeter per second

Cord

One cord of wood equals 128 cubic feet, or a pile of wood 4 feet high, 4 feet thick and 8 feet long.

CubicCentimeterPerGram

Cubic centimeter per gram

CubicCentimeterPerSecond

Cubic centimeter per second

CubicFoot

The measurement value is expressed in cubic feet.

CubicInchesPerSecond

Cubic inches per second

CubicMeter

The measurement value is expressed in cubic meter.

CubicMeterKilometer

The value is expressed as a volume in CubicMeter times a distance in Kilometer, e.g. the unit price for transporting one cubicmeter of wood one kilometer.

CubicMeterPerKilogram

Cubic meter per kilogram

Cubit

The English cubit is 18 inches long (46 cm).

Day

The duration of time equal to 24 hours.

Decimeter**Degree**

Degree

DegreesSchopperRiegler

Degree Schopper Riegler

DotsPerInch

An indication of image resolution.

Envelope

An envelope.

Fahrenheit

Fahrenheit

Foot

The measurement value is expressed in feet.

Gallon

The measurement value is in gallons.

Gauge

A unit of measure for diameter and thickness, e.g. for a wire or flat pieces such as sheet metal, thin plastic and film stock.

Gram

The measurement value is expressed in grams.

GramCentimeter**GramForce****GramPerCubicCentimeter****GramPerMeter**

GramsPerSquareMeter

The measurement value is expressed in grams per square meter (g/m²).

Hectare

The measurement value is expressed in hectares (10000 square meters).

Hour

The measurement value is expressed in hours.

HundredBoardFeet**HundredLinealFeet****HundredPound**

The measurement value is expressed in hundreds of pounds or hundredweight.

HundredSquareFeet**ImpressionCount**

The measurement is in number of printed impressions.

Inch

The measurement value is expressed in inches.

JoulePerSquareMeter**Kilogram**

The measurement value is expressed in kilograms.

KilogramForcePerSquareCentimeter**KilogramForcePerCentimeter****KilogramPerCubicMeter****KilogramPerSquareMeter****KilogramsPerDay**

The measurement value is expressed in kilograms per day.

KilogramsPerWeek

The measurement value is expressed in kilograms per week.

Kilometer

The measurement value is expressed in kilometres.

KiloNewton**KiloNewtonPerMeter****KiloPascal****KiloWattHour**

The measurement value is expressed in kilowatt hours (KWh)

KnownBreaks

Known breaks

Layer

papiNet V2R31

The measurement value is a count of layers (for example, the number of boxes per layer on a pallet).

Leaves

Leaves

LinearFoot

The measurement value is expressed in linear feet.

LinesPerInch

Lines Per Inch

Litre

The measurement value is expressed in litres.

Load

The measurement value is a count of shipment loads.

Log

A cut portion of a stem.

LogPile

A pile of logs (a virtual type of package).

LooseVolumeItem

A unit containing loose volume products (during transports) (a type of virtual package).

MagazineUnit

A copy of a magazine.

Megabyte

A unit of information equal to 1,048,576 bytes or 1024 kilobytes.

MegaWattHour

The measurement value is expressed in mega watt hours (MWh).

Meter

The measurement value is expressed in meters.

MeterPerSecond

The measurement value is in meters per second.

MetricTon

The measurement value is expressed in metric tons (in other words, in 1000-kilogram units).

MetricTonKilometer

The value is expressed as a weight in MetricTon times a distance in Kilometer, e.g. the unit price for transporting one metric ton of wood one kilometer.

MetricTonsPerDay

The measurement value is expressed in metric tons per day.

MetricTonsPerHour

papiNet V2R31

The measurement value is expressed in metric tons per hour.

MetricTonsPerWeek

The measurement value is expressed in metric tons per week.

MicroMeterPerPascalSecond

Micron

The measurement is expressed as the number of one-millionths of a meter.

MilliLitersPerMinute

Millimeter

The measurement value is expressed in millimetres.

MillimeterPerMeter

The measurement value is expressed in millimeter per meter.

MilliNewton

One thousandth of a Newton.

MilliNewtonMeter

MilliNewtonSquareMeterPerGram

Minute

The measurement value is expressed in minutes.

Month

The measurement value is expressed in months.

NanoMeter

Newton

The measurement value is expressed in the unit of force needed to accelerate a mass of one kilogram one meter per second per second.

NewtonMeterPerGram

None

There is no unit of measure. The value is scalar.

Package

The measurement value is a count of packages (for example, the number of reel packages in a shipment). 32 double-wrapped reels would equal 16 packages.

Page

The measurement value is expressed in number of pages.

PagesPerForm

The measurement value is expressed in number of pages per form.

PagesPerImpression

The measurement value is expressed in number of pages per printed impression.

PagesPerInch

papiNet V2R31

The measurement value is a count of the number of pages per inch.

PalletUnit

The measurement value is a count of pallets.

PartsPerMillion

The measurement value is expressed in parts per million.

Percentage

The measurement being communicated is a percentage.

PerThousand

The measurement value is expressed in parts per thousand.

pH

A measurement of acidity.

Picas

The measurement value is expressed in picas.

Piece

The measurement value is number of pieces.

PixelsPerInch

The measurement value is expressed in pixels per inch.

Pound

The measurement value is expressed in pounds.

PoundForce

PoundPerCubicFoot

The measurement value is expressed in pounds per cubic foot.

PoundPerSixInchDiameter

The measurement value is expressed in pounds per six inch diameter.

PoundPerSquareInch

The measurement value is expressed in pounds per square inch.

PoundsPerDay

The measurement value is expressed in pounds per day.

PoundsPerHour

The measurement value is expressed in pounds per hour.

PoundsPerWeek

The measurement value is expressed in pounds per week.

PulpUnit

The measurement is related to the packaging characteristic or material handling equipment for the pulp.

Ream

The measurement value is a count of reams.

Reel

The measurement value is a count of reels.

Set

The measurement value is a count of sets.

Sheet

The measurement value is a count of sheets.

ShortTon

The measurement value is expressed in short tons.

ShortTonsPerDay

The measurement value is expressed in short tons per day.

ShortTonsPerHour

The measurement value is expressed in short tons per hour.

ShortTonsPerWeek

The measurement value is expressed short tons per week.

Signature

The measurement value is the number of print signatures.

Skid

The measurement value is a count of skids.

SquareFeet

The measurement value is expressed in square feet.

SquareInch

The measurement value is expressed in square inches.

SquareMeter

The measurement value is expressed in square meters.

SquareMeterPerKilogram**TenKilometer**

The measurement value is expressed in units of 10 kilometers, a.k.a. Swedish mile or Norwegian mile.

ThousandBoardFeet

The measurement value is expressed in thousand board feet.

ThousandLinealFeet

The measurement value is expressed in thousand lineal feet.

ThousandPieces

The measurement value is expressed in thousand of pieces.

ThousandSquareCentimeters

The measurement value is expressed in thousand square centimeters.

ThousandSquareFeet

papiNet V2R31

The measurement value is expressed in thousand square feet.

ThousandSquareInch

The measurement value is expressed in thousand square inches.

Ton

To be deprecated in version 3.0 (no date determined). Use instead MetricTon or ShortTon.

TonsPerHour

To be deprecated in version 3.0 (no date determined). Use instead MetricTonsPerHour or ShortTonsPerHour.

Unit

The measurement value is expressed in individual units (pieces or eaches.

UnknownBreaks

The number of paper breaks, on a printing machine, that are due to unknown causes.

Week

The measurement value is expressed in weeks.

Yard

The measurement value is expressed in yards.

Year

The measurement value is expressed in number of years.

URL

Universal Resource Locator. While typically a web address you could use this field to hold an email address.

URLContext [attribute]

URLContext is optional. A single instance might exist.

The purpose of the URL.

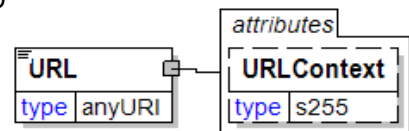

URLContext [attribute]

The purpose of the URL.

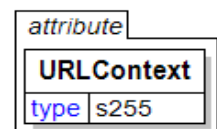

Usage

The Usage element is the root element for the Usage e-Document.

The Usage e-Document is used to notify a supplier or buyer that material has been consumed within the end user's manufacturing process.

UsageStatusType [attribute]

UsageStatusType is mandatory. A single instance is required.

Identifies the status of the entire Usage e-Document

Refer to UsageStatusType definition for any enumerations.

Reissued [attribute]

Reissued is optional. A single instance might exist.

Either "Yes" or "No".

Refer to Reissued definition for any enumerations.

Language [attribute]

Language is optional. A single instance might exist.

XML has embraced 2 and 3 digit language codes through the application of an addendum to the standard.

Refer to Language definition for any enumerations.

(sequence)

The sequence of items below is mandatory. A single instance is required.

UsageHeader

UsageHeader is mandatory. A single instance is required.

Information that is common to the entire Usage e-Document.

UsageLineItem

UsageLineItem is mandatory. One instance is required, multiple instances might exist.

The details of the Usage e-Document.

UsageSummary

UsageSummary is optional. A single instance might exist.

The root element of the Usage e-Document.

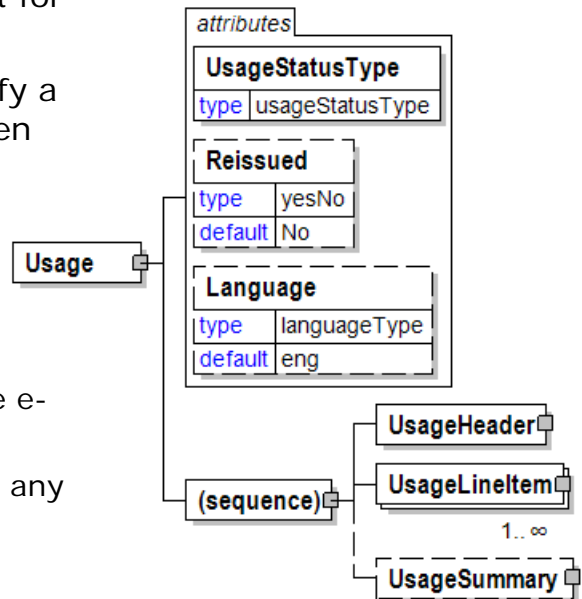

UsageHeader

Information that is common to the entire Usage e-Document.

(sequence)

The sequence of items below is mandatory. A single instance is required.

UsageNumber

UsageNumber is mandatory. A single instance is required.

Unique identifier assigned to each Usage document as agreed by the trading partners.

UsageHeaderReference

UsageHeaderReference is optional. Multiple instances might exist.

An element that details relevant references to the Usage Header. The content of the UsageHeaderReference is identified by the UsageReferenceType attribute.

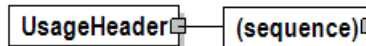

UsageIssuedDate

UsageIssuedDate is mandatory. A single instance is required.

Identifies the Date and Time when the Usage information has been reported.

TransactionHistoryNumber

TransactionHistoryNumber is optional. A single instance might exist.

A sequential number that keeps track of the version of a document being sent by the document originator except in the case where TransactionHistoryConfirmation is used, in which case the TransactionHistoryNumber refers to the trigger transaction for which the confirmation is being sent.

TimePeriod

TimePeriod is optional. A single instance might exist.

The TimePeriod element is used to communicate a duration period of time as indicated in PeriodType.

EndUserParty

EndUserParty is mandatory. A single instance is required.

The party using, consuming, or converting the product. For example, a printer using paper reels for a print job for a publisher. The final ShipTo destination for a product is normally to the end user's facilities.

SupplierParty

SupplierParty is optional. A single instance might exist.

The organisation or business entity responsible for providing the product.

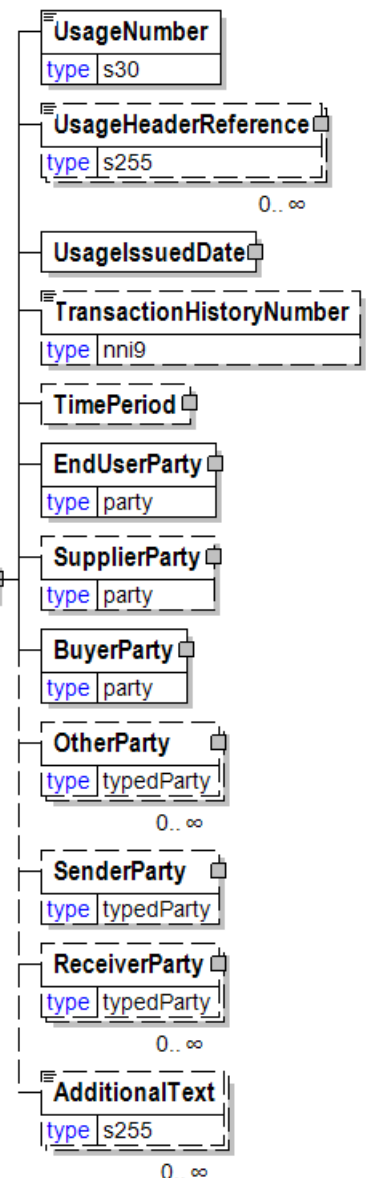

SupplierParty is also the seller of the product, if Seller is not specified as OtherParty = Seller.

BuyerParty

BuyerParty is mandatory. A single instance is required.

The legal entity to which the product is sold. Also commonly referred to as the sold-to party or customer. If no OtherParty is defined as the Payer, the Buyer is the Payer.

OtherParty

OtherParty is optional. Multiple instances might exist.

An organisation or business entity other than those specifically detailed within a e-Document.

SenderParty

SenderParty is optional. A single instance might exist.

The business entity issuing the e-Document, the source of the document.

The entity responsible for the content. If the sender party has out sourced the message service to a third party the SenderParty is the issuer of the e-Document and not the party performing the transmission service of the electronic message.

ReceiverParty

ReceiverParty is optional. Multiple instances might exist.

The business entity for whom the e-Document is intended, the destination of the document.

The entity interested in the content. If the receiver party has outsourced the message service to a third party the ReceiverParty is the intended party for the e-Document and not the party performing the receiving service of the electronic message.

AdditionalText

AdditionalText is optional. Multiple instances might exist.

A text field that is used to communicate information not previously defined or for special instructions. To be used only for circumstances not covered by specific elements.

UsageHeaderReference

An element that details relevant references to the Usage Header. The content of the UsageHeaderReference is identified by the UsageReferenceType attribute.

UsageReferenceType [attribute]

UsageReferenceType is mandatory. A single instance is required.

Provides a contextual explanation of the specific reference identifier. Many items are currently prefixed by "Buyer", "Forwarder", "Manufacturer", "Mill", "Seller", "Supplier", "Warehouse", or "Vendor". Check for an existing non-prefixed version and use the non-prefixed version instead. In the (yet to be

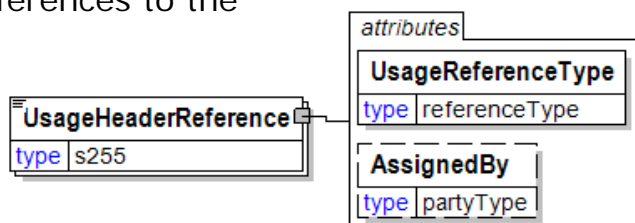

announced release date) version 3.0 the prefixed versions will be removed. Instead the attribute @AssignedBy will communicate the information previously communicated in the prefix.

Refer to UsageReferenceType definition for any enumerations.

AssignedBy [attribute]

AssignedBy is optional. A single instance might exist.

Identifies the type of party that has assigned the associated item, e.g. a reference of type OrderNumber.

Refer to AssignedBy for any enumerations.

UsageIssuedDate

Identifies the Date and Time when the Usage information has been reported.

(sequence)

The sequence of items below is mandatory. A single instance is required.

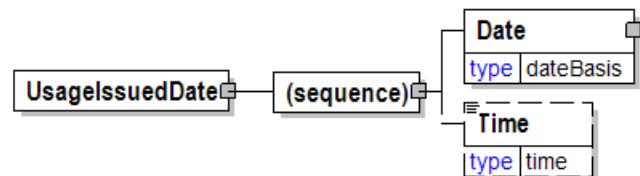

Date

Date is mandatory. A single instance is required.

A group element that contains the specification of Year, Month, and Day.

Time

Time is optional. A single instance might exist.

Times are treated in a standard XML fashion with a special case used to indicate a generalized "local" time. The standard XML approach to time is hh:mm:ss, hh:mm:ssZ, or hh:mm:ss±hh:mm.

hh:mm:ss±hh:mm is used to represent a time with a time zone. The time zone is communicated as the number of hours offset from the Universal Time Coordinate (UTC), a.k.a. Greenwich Mean Time.

hh:mm:ssZ indicates the time at Zulu (another name for UTC). Based on the convention described in the next bullet it will be important for users within UTC to use "Z" when communicating a time in their time zone to other users.

hh:mm:ss or hh:mm indicates in the XML standard the time at UTC however, within papiNet it is used to represent the applicable local time. Caution should be used when processing times of this nature as the papiNet approach may be in discord with other users of XML.

UsageLineItem

The details of the Usage e-Document.

(sequence)

The sequence of items below is mandatory. A single instance is required.

UsageLineItemNumber

UsageLineItemNumber is mandatory. A single instance is required.

A sequential number that uniquely identifies the Usage line item.



UsageReference

UsageReference is optional. Multiple instances might exist.

A repeatable element that details relevant references pertaining to the Usage. The content of the UsageReference is identified by UsageReferenceType.

LocationParty

LocationParty is optional. A single instance might exist.

The organization or business entity where the business event took place or will take place.

WasteQuantity

WasteQuantity is optional. Multiple instances might exist.

The quantity of product wasted.

WebBreaks

WebBreaks is optional. Multiple instances might exist.

The number of web breaks.

(choice)

[choice] is optional because of choice construct.

AggregatedUsageLineItem

AggregatedUsageLineItem is optional because of choice construct.

A group item that summarises item usage at the Product level or at the Product plus PurchaseOrder level. Details concerning the individual items used are not included.

ItemisedUsageLineItem

ItemisedUsageLineItem is optional because of choice construct.

A group item containing information that relates to an itemized amount of usage.

AdditionalText

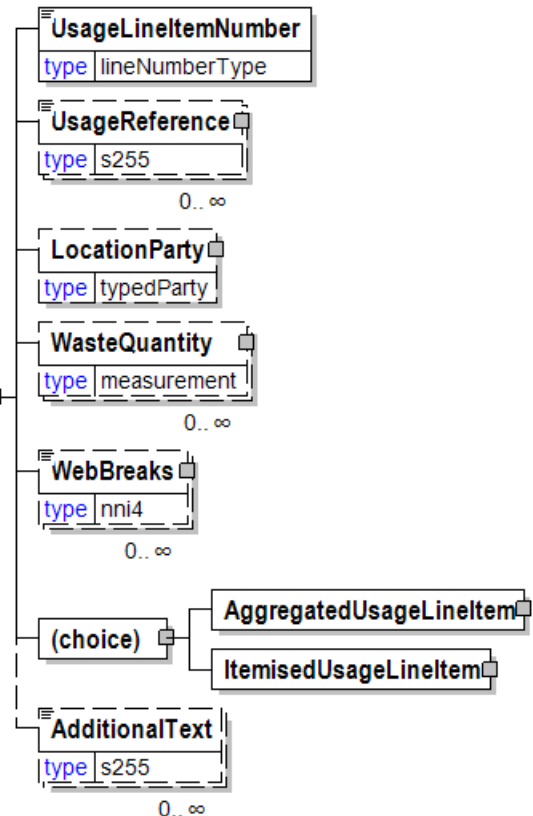

AdditionalText is optional. Multiple instances might exist.

A text field that is used to communicate information not previously defined or for special instructions. To be used only for circumstances not covered by specific elements.

UsageLineItemDetail

For each ItemisedUsageLineItem there must be one or more UsageLineItemDetail. This element lists the specific product that has been consumed.

UsageStatus [attribute]

UsageStatus is mandatory. A single instance is required.

The Usage Status element identifies the state of an individual item after consumption has been applied to it.

Refer to UsageStatus definition for any enumerations.

ItemType [attribute]

ItemType is mandatory. A single instance is required.

Indicates the form of the item being reported as being used. Many of the ItemType(s) indicated here have a corresponding named element equivalent, which is referenced here for definition purposes.

Refer to ItemType definition for any enumerations.

(sequence)

The sequence of items below is mandatory. A single instance is required.

Identifier

Identifier is mandatory. A single instance is required.

An Identifier is required for packages and items (pallets, reel packages, boxes, ream items, reel items, etc). The Identifier element contains the actual item identifier code. Identifier is repeatable so more than one identifier can be communicated. For example, the printed identifier on a label may be different from the barcode printed on the label.

RawMaterialSet

RawMaterialSet is optional. Multiple instances might exist.

This identifier derived element indicates a grouping of raw materials that were used to manufacture the product.

Quantity

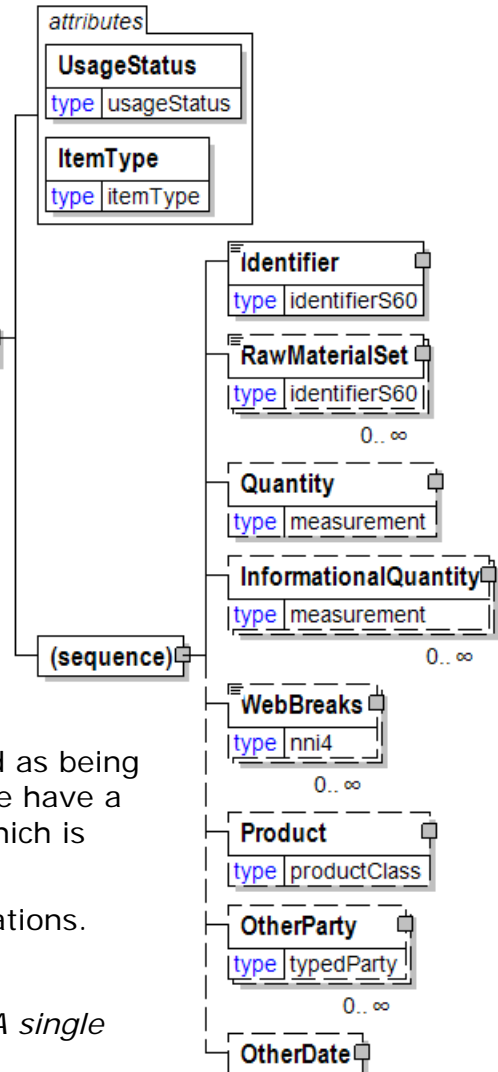

papiNet V2R31

Quantity is optional. A single instance might exist.

The Quantity element contains attributes that provide information about the type of quantity that is being communicated, the context in which the particular quantity is to be viewed, and (if the quantity represents an adjustment) an adjustment type.

The Quantity element contains three child elements that enable you to communicate a range of values for the quantity and a target or actual value. It is at this level (Value, RangeMin, and RangeMax) that the unit of measure is specified. This permits the range to be specified in a different unit of measure than the target.

InformationalQuantity

InformationalQuantity is optional. Multiple instances might exist.

A quantity given in a valid UOM used for information purposes only (not for calculation). For example, an ordered quantity was 100 reels as opposed to the invoice quantity of 20,000 pounds.

WebBreaks

WebBreaks is optional. Multiple instances might exist.

The number of web breaks.

Product

Product is optional. A single instance might exist.

Product is a group item defining the article and its characteristics. Product is used to specify product characteristics organized by ProductIdentifier, ProductDescription, and Classification. Book Manufacturing, Label Stock, Paper, Pulp, Recovered Paper, Wood Products, and Virgin Fibre market segments have defined their product characteristics and conversion features for implementation in papiNet.

OtherParty

OtherParty is optional. Multiple instances might exist.

An organisation or business entity other than those specifically detailed within a e-Document.

OtherDate

OtherDate is optional. A single instance might exist.

A date that may not be specifically detailed within a document (example: print date at the PurchaseOrderLineItem).

UsageLineItemNumber

A sequential number that uniquely identifies the Usage line item.

UsageLineItemNumber	
type	lineNumberType

UsageNumber

Unique identifier assigned to each Usage document as agreed by the trading partners.

UsageNumber	
type	s30

UsageReference

A repeatable element that details relevant references pertaining to the Usage. The content of the UsageReference is identified by UsageReferenceType.

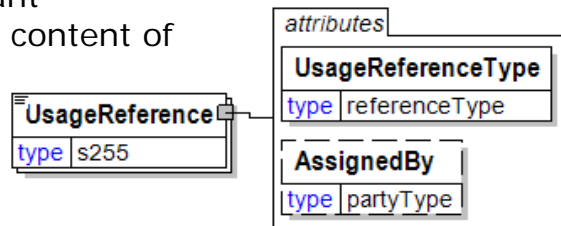

UsageReferenceType [attribute]

UsageReferenceType is mandatory. A single instance is required.

Provides a contextual explanation of the specific reference identifier. Many items are currently prefixed by "Buyer", "Forwarder", "Manufacturer", "Mill", "Seller", "Supplier", "Warehouse", or "Vendor". Check for an existing non-prefixed version and use the non-prefixed version instead. In the (yet to be announced release date) version 3.0 the prefixed versions will be removed. Instead the attribute @AssignedBy will communicate the information previously communicated in the prefix.

Refer to UsageReferenceType definition for any enumerations.

AssignedBy [attribute]

AssignedBy is optional. A single instance might exist.

Identifies the type of party that has assigned the associated item, e.g. a reference of type OrderNumber.

Refer to AssignedBy for any enumerations.

UsageReferenceType [attribute]

Provides a contextual explanation of the specific reference identifier. Many items are currently prefixed by "Buyer", "Forwarder", "Manufacturer", "Mill", "Seller", "Supplier", "Warehouse", or "Vendor". Check for an existing non-prefixed version and use the non-prefixed version instead. In the (yet to be announced release date) version 3.0 the prefixed versions will be removed. Instead the attribute @AssignedBy will communicate the information previously communicated in the prefix.

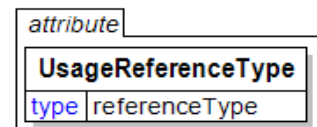

Refer to the [referenceType](#) entry for the list of enumerations and their definitions.

UsageStatus [attribute]

The Usage Status element identifies the state of an individual item after consumption has been applied to it.

This item is restricted to the following list.

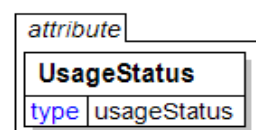

Consumed

Indicates that the entire item has been consumed.

MachineReject

Indicates that the item has been rejected from the production machine

StrippedButt

Indicates that this item has been prepped for consumption but has not been used in the manufacturing process.

UsableButt

Indicates that a partial amount of a reel product has been consumed and the remainder is useable.

UsablePallet

Indicates that a partial amount of a pallet product has been consumed and the remainder is useable.

UnusableButt

Indicates that a partial amount of a reel product has been consumed and the remainder is not useable.

UnusablePallet

Indicates that a partial amount of a pallet product has been consumed and the remainder is not useable.

UsageStatusType [attribute]

Identifies the status of the entire Usage e-Document

This item is restricted to the following list.

Cancelled

The supplied information has been cancelled. Items that have been cancelled are not included in totals on the summary levels of the e-Document.

Original

The supplied information is the first version of that information.

Replaced

The supplied information is replacing earlier supplied information. The receiver should revalidate the information in their system based upon the entire information received.

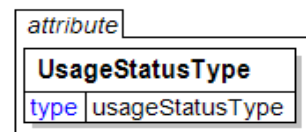

UsageSummary

The root element of the Usage e-Document.

(sequence)

The sequence of items below is mandatory. A single instance is required.

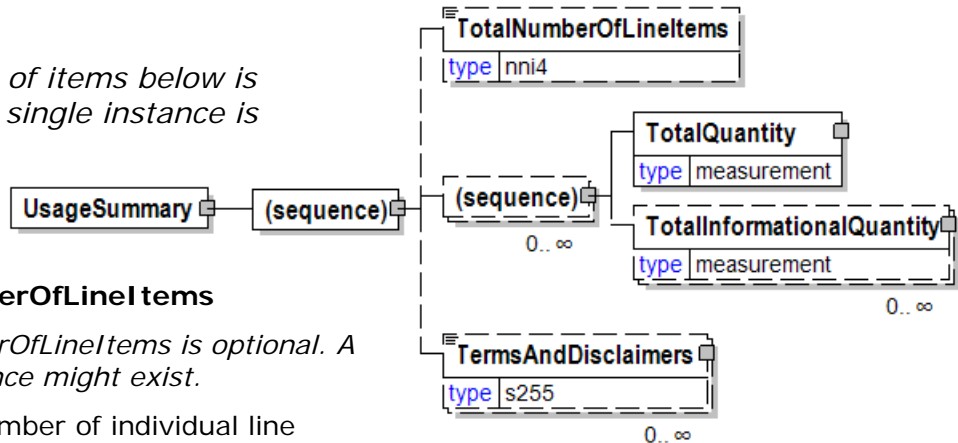

TotalNumberOfLineItems

TotalNumberOfLineItems is optional. A single instance might exist.

The total number of individual line items in the document, regardless of the status or type.

(sequence)

The sequence of items below is optional. Multiple instances might exist.

TotalQuantity

TotalQuantity is mandatory. A single instance is required.

The total quantity of similar items in the e-Document. TotalQuantity is primarily used in the summary section of documents where it is repeatable to permit totaling for different units of measure.

TotalInformationalQuantity

TotalInformationalQuantity is optional. Multiple instances might exist.

A quantity that is used to communicate related information about the parent element. This element represents a total that is derived from individual line items.

TermsAndDisclaimers

TermsAndDisclaimers is optional. Multiple instances might exist.

An element that contains legal information with an indication of what the Language is.

ValidityPeriod

The validity period for a specific item, e.g. the validity period for an e-Document.

(sequence)

The sequence of items below is mandatory. A single instance is required.

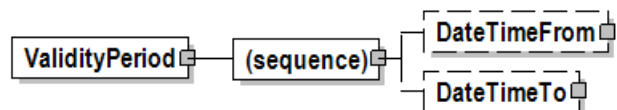

DateTimeFrom

DateTimeFrom is optional. A single instance might exist.

The start or beginning Date and Time of a date range.

DateTimeTo

DateTimeTo is optional. A single instance might exist.

The ending Date and Time of a date/time range.

Value

A numeric value expressed in the unit of measure (UOM).

UOM [attribute]

UOM is mandatory. A single instance is required.

Defines the unit of measure for the value.

Refer to UOM definition for any enumerations.

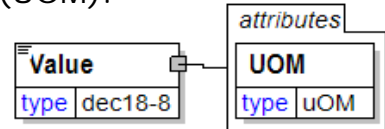

VarianceType [attribute]

Defines the type of difference that the GoodsReceiptPackage has from the information on the DeliveryMessage

This item is restricted to the following list.

DifferingWeights

The physical item was weighed and the weight is different from the DeliveryMessage weight.

NotReceived

The physical item that was specified on the DeliveryMessage was not received.

ReceivedNotSpecified

The physical item was received but was not on the DeliveryMessage

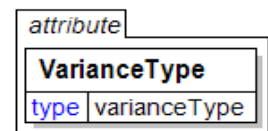

VideoCassette

Video cassette information.

VideoFormatType [attribute]

VideoFormatType is optional. A single instance might exist.

The type of video format.

Refer to VideoFormatType definition for any enumerations.

TrackType [attribute]

TrackType is optional. A single instance might exist.

The type of track

Refer to TrackType definition for any enumerations.

Tabs [attribute]

Tabs is optional. A single instance might exist.

The type of tabs

Refer to Tabs definition for any enumerations.

VideoCassetteCaseType [attribute]

VideoCassetteCaseType is optional. A single instance might exist.

The type of video cassette case.

Refer to VideoCassetteCaseType definition for any enumerations.

AssemblyType [attribute]

AssemblyType is optional. A single instance might exist.

Assembly type

Refer to AssemblyType definition for any enumerations.

WrapType [attribute]

WrapType is optional. A single instance might exist.

Communicates the type of material used to wrap the product.

Refer to WrapType definition for any enumerations.

(sequence)

The sequence of items below is mandatory. A single instance is required.

SequenceNumber

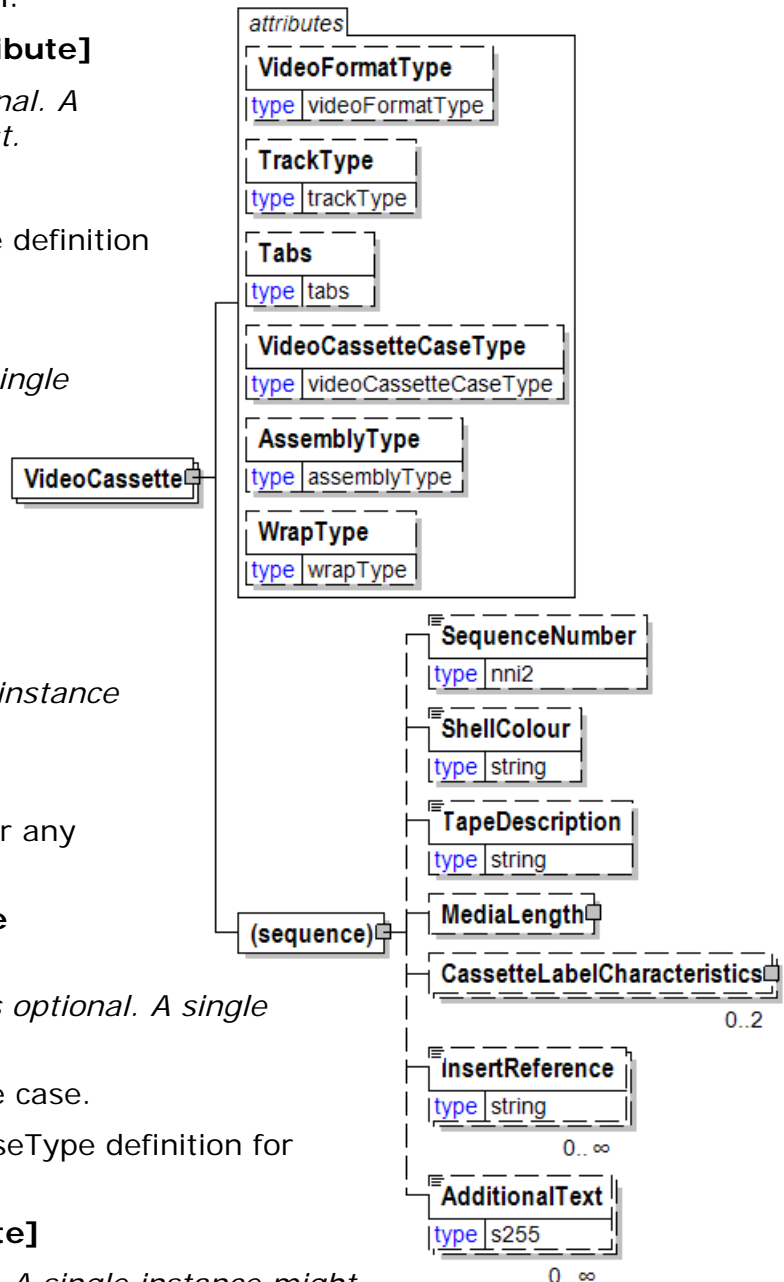

papiNet V2R31

SequenceNumber is optional. A single instance might exist.

ShellColour

ShellColour is optional. A single instance might exist.

Shell colour

TapeDescription

TapeDescription is optional. A single instance might exist.

Tape description

MediaLength

MediaLength is optional. A single instance might exist.

Media length

CassetteLabelCharacteristics

CassetteLabelCharacteristics is optional.

Cassette label characteristics

InsertReference

InsertReference is optional. Multiple instances might exist.

Insert reference

AdditionalText

AdditionalText is optional. Multiple instances might exist.

A text field that is used to communicate information not previously defined or for special instructions. To be used only for circumstances not covered by specific elements.

VideoCassetteCaseType [attribute]

The type of video cassette case.

This item is restricted to the following list.

HardPlastic

VacuumAlbum

SleeveBottomLoaded

SleeveSideLoaded



VideoFormatType [attribute]

The type of video format.

This item is restricted to the following list.

VHS

Video Home System

PCL

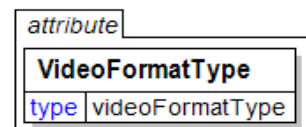

VirginFibre

Virgin Fibre

(sequence)

The sequence of items below is mandatory. A single instance is required.

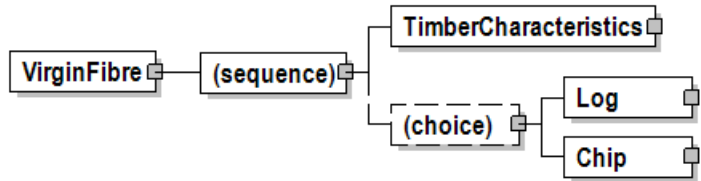

TimberCharacteristics

TimberCharacteristics is mandatory. A single instance is required.

Timber characteristics

(choice)

[choice] is optional because of choice construct.

Log

Log is optional because of choice construct.

Log information

Chip

Chip is optional because of choice construct.

Chip information.

Viscosity

Viscosity

TestMethod [attribute]

TestMethod is optional. A single instance might exist.

The method used to determine the results of the test under consideration.

TestAgency [attribute]

TestAgency is optional. A single instance might exist.

The agency that has set the parameters for the testing

Refer to TestAgency definition for any enumerations.

SampleType [attribute]

SampleType is optional. A single instance might exist.

Communicates how sampling was done to measure the product characteristics.

Refer to SampleType definition for any enumerations.

ResultSource [attribute]

ResultSource is optional. A single instance might exist.

Used to define the data source of the specified test

Refer to ResultSource definition for any enumerations.

(sequence)

The sequence of items below is mandatory. A single instance is required.

DetailValue

DetailValue is mandatory. A single instance is required.

A numeric value expressed in the unit of measure (UOM).

DetailRangeMin

DetailRangeMin is optional. A single instance might exist.

The minimum value (lower boundary) allowed for the DetailValue that is the parent of this element.

DetailRangeMax

DetailRangeMax is optional. A single instance might exist.

The maximum value (upper boundary) allowed for the DetailValue that is the parent of this element.

StandardDeviation

StandardDeviation is optional. A single instance might exist.

A statistic used as a measure of dispersion in a distribution.

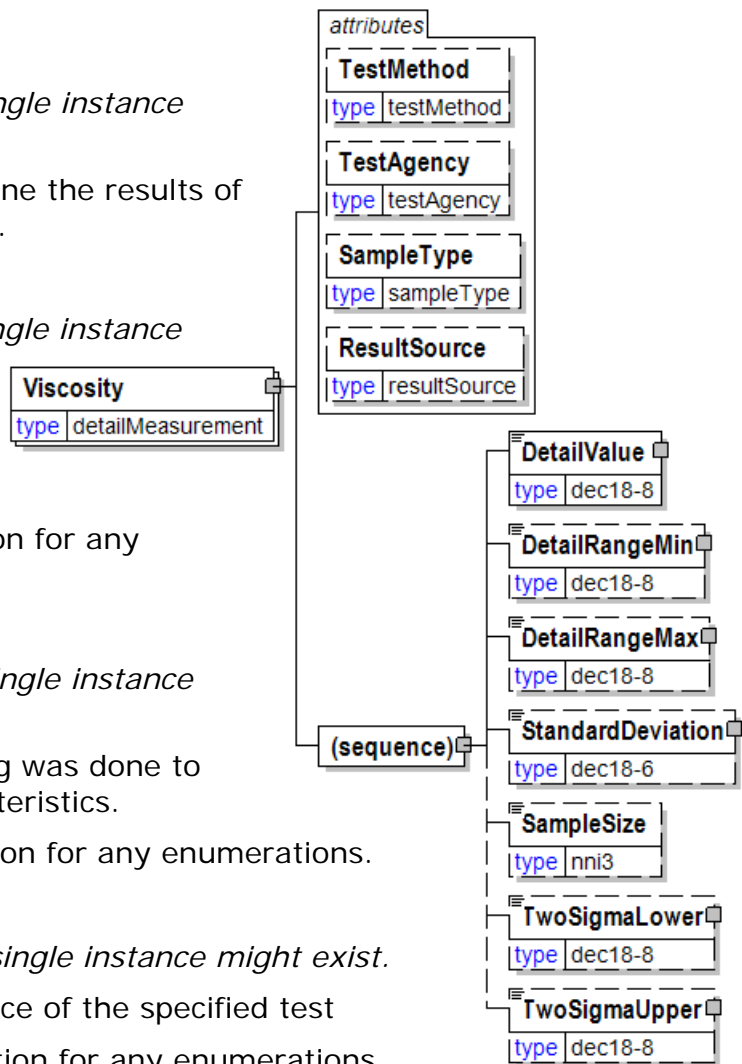

SampleSize

SampleSize is optional. A single instance might exist.

The number of samples used to determine the product characteristic in question.

TwoSigmaLower

TwoSigmaLower is optional. A single instance might exist.

Two sigma (a measure of dispersion associated with standard deviation) on the lower side of the standard deviation.

TwoSigmaUpper

TwoSigmaUpper is optional. A single instance might exist.

Two sigma (a measure of dispersion associated with standard deviation) on the upper side of the standard deviation.

Wall

Defines parts and complete wall systems.

(sequence)

The sequence of items below is mandatory. A single instance is required.

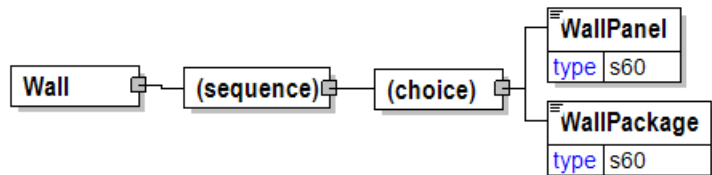

(choice)

[choice] is optional because of choice construct.

WallPanel

WallPanel is optional because of choice construct.

Material used for wall surface.

WallPackage

WallPackage is optional because of choice construct.

Package including parts to build a wall.

WallPackage

Package including parts to build a wall.

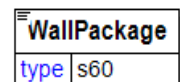

WallPanel

Material used for wall surface.

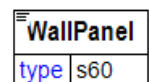

WasteImpressions

The number of bad revolutions produced on a printing unit.

WasteImpressions	
type	nni4

WasteQuantity

The quantity of product wasted.

WasteType [attribute]

WasteType is mandatory. A single instance is required.

An indication of where in the process the waste has taken place.

Refer to WasteType definition for any enumerations.

(sequence)

The sequence of items below is mandatory. A single instance is required.

Value

Value is mandatory. A single instance is required.

A numeric value expressed in the unit of measure (UOM).

RangeMin

RangeMin is optional. A single instance might exist.

The minimum value (lower boundary) allowed for the Measurement that is the parent of this element.

RangeMax

RangeMax is optional. A single instance might exist.

The maximum value (upper boundary) allowed for the Measurement that is the parent of this element. Some elements use the RangeMax element with an extended list of unit of measures. (Note: the red colour in the picture is an artifact of how the graphic was captured and should be disregarded.)

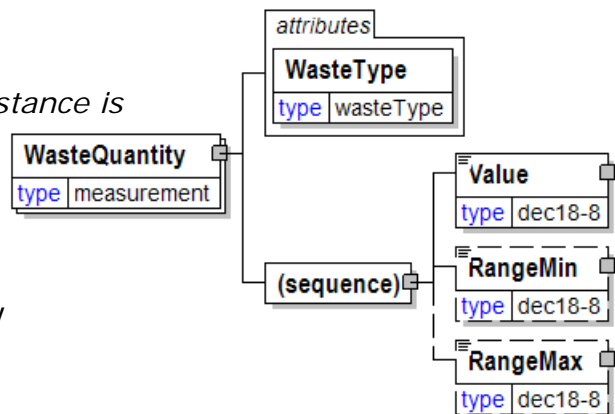

WasteType [attribute]

An indication of where in the process the waste has taken place.

This item is restricted to the following list.

Binding

Core

MakeReady

Running

Strip

WasteType	
type	wasteType

WrapCore
Wrapper

Watermark

Watermark information

(sequence)

The sequence of items below is mandatory. A single instance is required.

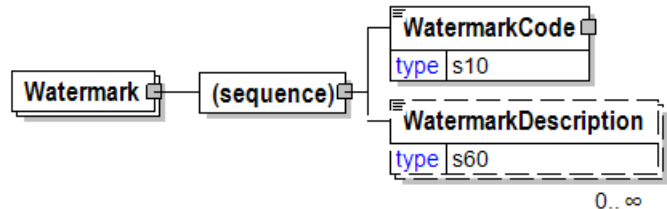

WatermarkCode

WatermarkCode is mandatory. A single instance is required.

The code representing the watermark on the paper.

WatermarkDescription

WatermarkDescription is optional. Multiple instances might exist.

Watermark Description

WatermarkCode

The code representing the watermark on the paper.

Agency [attribute]

Agency is mandatory. A single instance is required.

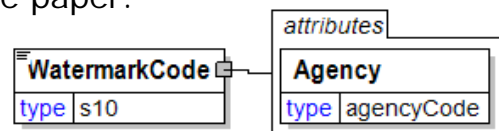

Describes the agency maintaining the list of codes. To be included in this list the agency must be a recognized standards body or industry organisation.

For the element that owns this attribute.

For another attribute in the list of attributes associated with the parent element.

Refer to Agency definition for any enumerations.

WatermarkDescription

Watermark Description

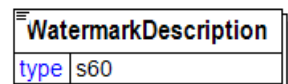

Webbing

The webbing that is used in the printing process.

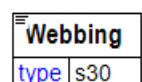

WebBreak

Separation of the paper web during the printing process causing the operator to stop and rethread the press.

If the ConcernIndicatorType is "Y" then a defect cause must be given.

(sequence)

The sequence of items below is mandatory. A single instance is required.

WebBreakCause

WebBreakCause is mandatory. A single instance is required.

A group element that contains information that describes the cause of a web break.

PressBreakLocation

PressBreakLocation is optional. Multiple instances might exist.

The specific location identified within a printing press.

ReelBreakDiameter

ReelBreakDiameter is mandatory. A single instance is required.

The diameter of a reel at which the web break occurred. This is measured from the core to outside diameter.

WebBreakDate

WebBreakDate is optional. A single instance might exist.

The date of the web break.

MachineDownTime

MachineDownTime is optional. A single instance might exist.

The length of loss production time that a machine experienced due to malfunction regardless of cause.

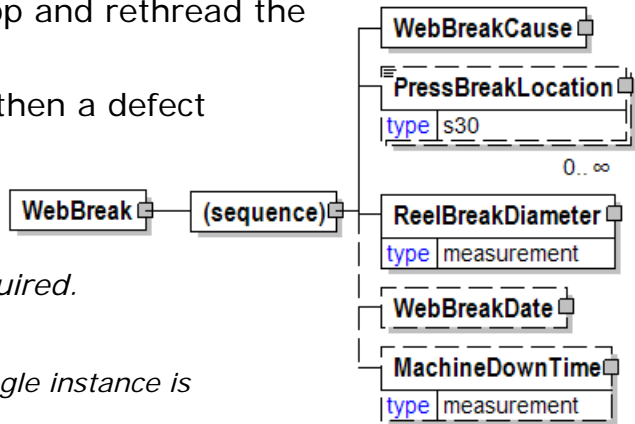

WebBreakCause

A group element that contains information that describes the cause of a web break.

WebBreakCauseType [attribute]

WebBreakCauseType is optional. A single instance might exist.

Web Break Cause Type

Refer to WebBreakCauseType definition for any enumerations.

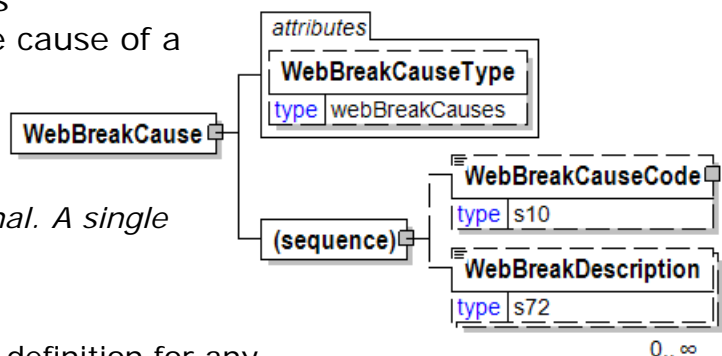

(sequence)

The sequence of items below is mandatory. A single instance is required.

WebBreakCauseCode

WebBreakCauseCode is optional. A single instance might exist.

Codes pertaining to the break supplied by the User.

WebBreakDescription

WebBreakDescription is optional. Multiple instances might exist.

Description of the web break

WebBreakCauseAgency [attribute]

WebBreakCauseAgency

This item is restricted to the following list.

attribute
WebBreakCauseAgency
type agencyCode

AFPA

American Forest and Paper Association.

ANSI

American National Standards Institute.

APPITA

Technical Association of the Australian and NZ Pulp and Paper Industry

ATA

ATA (American Truckers Association)

BISAC

Book Industry Study Group

Bowker

The agency that issues the StandardAddressNumber (www.bowker.com).

BSI

British Standards Institute (refer to bsi-global.com for more information).

Buyer

The buyer has defined the codes used in the particular element of the transaction. Care must be used when using this agency to assure that the recipient of the e-Document understands what is being communicated. (Not to be used for logistics buyer, see LogisticsBuyer.)

Carrier

The carrier has defined the codes used in the particular element of the transaction. Care must be used when using this agency to assure that the recipient of the e-Document understands what is being communicated.

CCTI

Composite Can and Tube Institute

CEN

European Committee for Standardisation (<http://www.cenorm.be>)

CEPI

Confederation of European Paper Industries.

CoSe

Agency for the the wood processing industry. (www.commonsense.at)

Customs

Any customs agency.

DUNS

Dun & Bradstreet.

EAN

European Article Numbering Agency.

ECTA-EPCA-CEFIC

European Chemical Transport Association, European Petrochemical Association, European Chemical Council. Information about the joint guidelines developed by these agencies can be found at www.ecta.be.

EndUser

The end-user has defined the codes used in the particular element of the transaction. Care must be used when using this agency to assure that the recipient of the e-Document understands what is being communicated

FINFO

Article numbering agency and system in some Nordic countries for all building products. (www.finfo.se)

Forwarder

The OtherParty indicated by party type "Forwarder" or when communicating OrderStatus the party indicated by ForwarderParty.

FSC

Forest Stewardship Council

GCA

Graphic Communications Association. (This agency now calls itself IDEAlliance.)

GCA-CCTI

The GCA and CCTI combined coding

GOST

Russian federal agency on technical regulating and metrology (<http://www.gost.ru>)

IFRA

INCA FIEJ Research Association (Technical Research and Consulting Association for the Newspaper Industry).

Intrastat

The agency responsible for collecting statistics on the physical trade of goods between the members of the EU.

ISO

International Organisation for Standardisation.

ISRI

Institute of Scrap Recycling Industries

LogisticsBuyer

The buyer of the logistics service has defined the codes used in the particular element of the transaction. Care must be used when using this agency to assure that the recipient of the e-Document understands what is being communicated.

LogisticsSeller

The seller of the logistics service has defined the codes used in the particular element of the transaction. Care must be used when using this agency to assure that the recipient of the e-Document understands what is being communicated.

LogisticsSupplier

The supplier of the logistics service has defined the codes used in the particular element of the transaction. Care must be used when using this agency to assure that the recipient of the e-Document understands what is being communicated.

Mill

The OtherParty indicated by party type "Mill" or when available the party indicated by MillParty.

NOBB

Norwegian Building Products database, (Norsk ByggvareBase)

NMFTA

National Motor Freight Traffic Association (NMFTA)

NPTA

National Paper Trade Association.

Ondule

European Association of Corrugated Base Papers Manufacturers (actually Óndule).

PEFC

www.pefc.org

PMS

Pantone Matching System is a colour matching system that is widely used in the book industry. See www.pantone.com for more information.

PPPC

Pulp and Paper Products Council

Publisher

The person, company or organization responsible for placing a book, journal, or other publication on the market (as opposed to the printer or bookseller); also referred to as the "buyer".

RASI

Article numbering agency and system in Finland for building products. (www.rasi.fi)

RevenueCanada

Canadian Revenue Agency. See www.cra.gc.ca

RVR

Agency maintaining codes for the German wood supply segment. RVR is the abbreviation for "RahmenVereinbarung für den Rohholzhandel in Deutschland". (www.rvr-deutschland.de).

SD

Agency maintaining codes for the Norwegian wood supply segment (www.skogdata.no).

SDC

Agency maintaining codes for the Swedish wood supply segment (www.sdc.se).

Seller

The seller of the product has defined the codes used in the particular element of the transaction. Care must be used when using this agency to assure that the recipient of the e-Document understands what is being communicated. (Not to be used for logistics seller, see LogisticsSeller.)

Supplier

The supplier has defined the codes used in the particular element of the transaction. Care must be used when using this agency to assure that the recipient of the e-Document understands what is being communicated. (Not to be used for logistics supplier, see LogisticsSupplier.)

TAPPI

Technical Association for the Paper and Pulp Industry

UCC

The Uniform Code Council.

UIC

International Union of Railways. (<http://www.uic.org>)
(Union Internationale des Chemins de fer)

UN/ECE

The United Nations – Economic Commission for Europe

WarehouseOperator

WCO

World Customs Organization (refer to wcoomd.org for more information).

XBITS

papiNet V2R31

XML Book Industry Transaction Standards

Other

Used when the agency responsible for a coding system is not defined in the attribute list, or there is no agency responsible for the codes used.

WebBreakCauseCode

Codes pertaining to the break supplied by the User.

WebBreakCauseAgency [attribute]

WebBreakCauseAgency is mandatory. A single instance is required.

WebBreakCauseAgency

Refer to WebBreakCauseAgency definition for any enumerations.

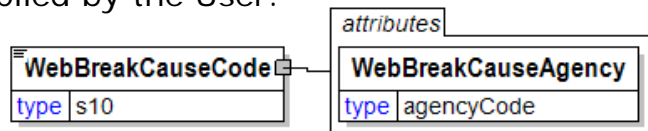

WebBreakCauseType [attribute]

Web Break Cause Type

This item is restricted to the following list.

BaggyRoll

CalendarCut

CoatingScuffBack

Detector

FlatSpots

GlueOnRoll

HairCut

InkFellOnWeb

KnifeCut

LooseCore

MillSplice

MissedPaste

PasterJamFolder

RibbonOutFolder

ScorchOut

ScrapInRoll

SlimeHole

SlitterFoldOver

SlitterNicks

StartOrStop

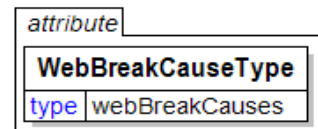

StuckWeb
Telescoped
TensionWrinklesPaste
Unknown
WaterFellOnWeb
WinderBurst
WinderWrinkles

WebBreakDate

The date of the web break.

(sequence)

The sequence of items below is mandatory. A single instance is required.

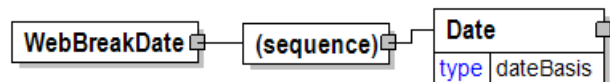

Date

Date is mandatory. A single instance is required.

A group element that contains the specification of Year, Month, and Day.

WebBreakDescription

Description of the web break

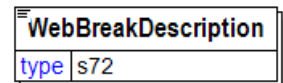

WebBreaks

The number of web breaks.

WebBreakType [attribute]

WebBreakType is mandatory. A single instance is required.

An indication of the cause of the paper break.

Refer to WebBreakType definition for any enumerations.

ReasonCode [attribute]

ReasonCode is optional. A single instance might exist.

Free-form text providing the Reason Code for the item. An Agency attribute may exist at the same level as this attribute to provide an indication of the nature of the text.

Agency [attribute]

Agency is optional. A single instance might exist.

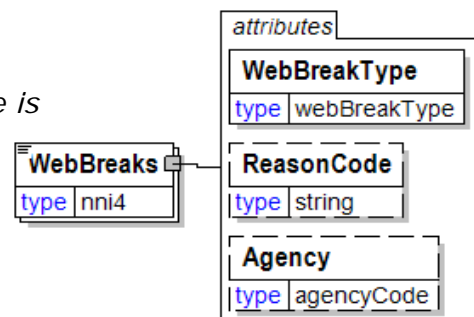

Describes the agency maintaining the list of codes. To be included in this list the agency must be a recognized standards body or industry organisation.

For the element that owns this attribute.

For another attribute in the list of attributes associated with the parent element.

Refer to Agency definition for any enumerations.

WebBreakType [attribute]

An indication of the cause of the paper break.

This item is restricted to the following list.

MachineCaused

PaperCaused

Unknown

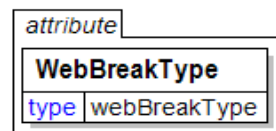

WebConcerns

A grouping element that contains the information about a web break.

(sequence)

The sequence of items below is mandatory. A single instance is required.

WebBreak

WebBreak is mandatory. A single instance is required.

Separation of the paper web during the printing process causing the operator to stop and rethread the press.

If the ConcernIndicatorType is "Y" then a defect cause must be given.

AdditionalText

AdditionalText is optional. Multiple instances might exist.

A text field that is used to communicate information not previously defined or for special instructions. To be used only for circumstances not covered by specific elements.

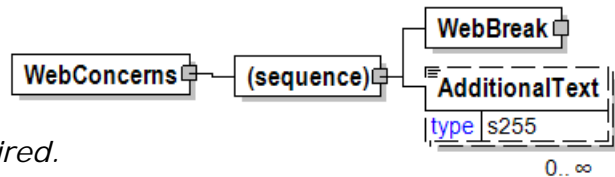

WebConfiguration

The way the web runs through the press.

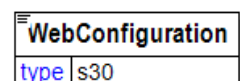

Week

A field defining the week number of the calendar year. ISO 8601 is used as the basis for this element, "Week 01 of a

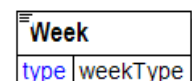

year is the first week that has the Thursday in this year, which is equivalent to the week that contains the fourth day of January."

Weight

The weight of the item.

(sequence)

The sequence of items below is mandatory. A single instance is required.

Value

Value is mandatory. A single instance is required.

A numeric value expressed in the unit of measure (UOM).

RangeMin

RangeMin is optional. A single instance might exist.

The minimum value (lower boundary) allowed for the Measurement that is the parent of this element.

RangeMax

RangeMax is optional. A single instance might exist.

The maximum value (upper boundary) allowed for the Measurement that is the parent of this element. Some elements use the RangeMax element with an extended list of unit of measures. (Note: the red colour in the picture is an artifact of how the graphic was captured and should be disregarded.)

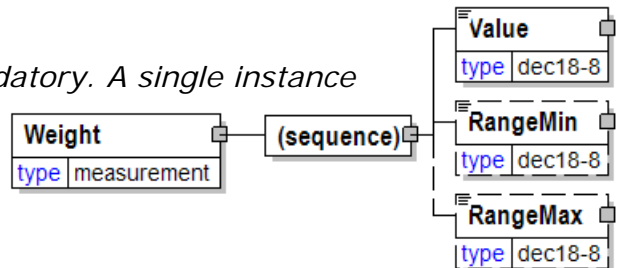

Whiteness

A group item used to communicate degree of whiteness target or test value according to a particular TestMethod.

TestMethod [attribute]

TestMethod is optional. A single instance might exist.

The method used to determine the results of the test under consideration.

TestAgency [attribute]

TestAgency is optional. A single instance might exist.

The agency that has set the parameters for the testing

Refer to TestAgency definition for any enumerations.

SampleType [attribute]

SampleType is optional. A single instance might exist.

Communicates how sampling was done to measure the product characteristics.

Refer to SampleType definition for any enumerations.

ResultSource [attribute]

ResultSource is optional. A single instance might exist.

Used to define the data source of the specified test

Refer to ResultSource definition for any enumerations.

(sequence)

The sequence of items below is mandatory. A single instance is required.

DetailValue

DetailValue is mandatory. A single instance is required.

A numeric value expressed in the unit of measure (UOM).

DetailRangeMin

DetailRangeMin is optional. A single instance might exist.

The minimum value (lower boundary) allowed for the DetailValue that is the parent of this element.

DetailRangeMax

DetailRangeMax is optional. A single instance might exist.

The maximum value (upper boundary) allowed for the DetailValue that is the parent of this element.

StandardDeviation

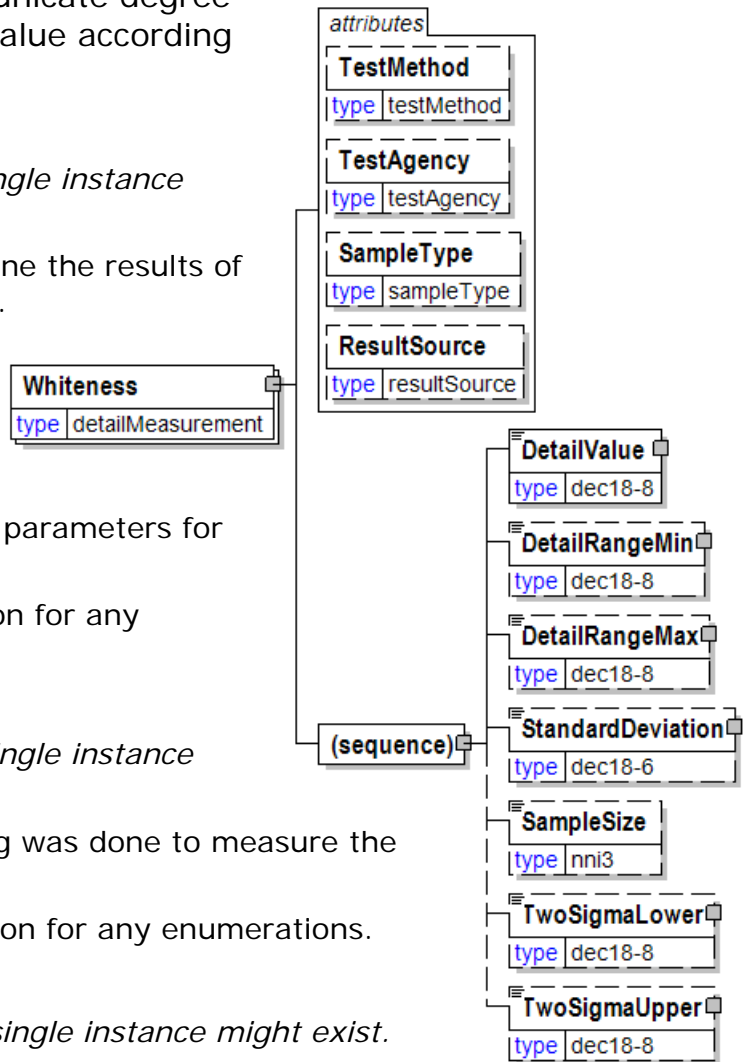

StandardDeviation is optional. A single instance might exist.

A statistic used as a measure of dispersion in a distribution.

SampleSize

SampleSize is optional. A single instance might exist.

The number of samples used to determine the product characteristic in question.

TwoSigmaLower

TwoSigmaLower is optional. A single instance might exist.

Two sigma (a measure of dispersion associated with standard deviation) on the lower side of the standard deviation.

TwoSigmaUpper

TwoSigmaUpper is optional. A single instance might exist.

Two sigma (a measure of dispersion associated with standard deviation) on the upper side of the standard deviation.

Width

The approach for width used in the timber/lumber related constructs.

ActualNominal [attribute]

ActualNominal is optional. A single instance might exist.

Indicates the

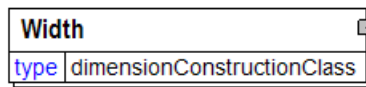

measurement approach used to communicate the dimensions of the individual pieces.

Refer to ActualNominal definition for any enumerations.

WithGrain [attribute]

WithGrain is optional. A single instance might exist.

Either "Yes" or "No".

Refer to WithGrain definition for any enumerations.

(choice)

[choice] is optional because of choice construct.

Value

Value is optional because of choice construct.

A numeric value expressed in the unit of measure (UOM).

(sequence)

The sequence of items below is mandatory. A single instance is required.

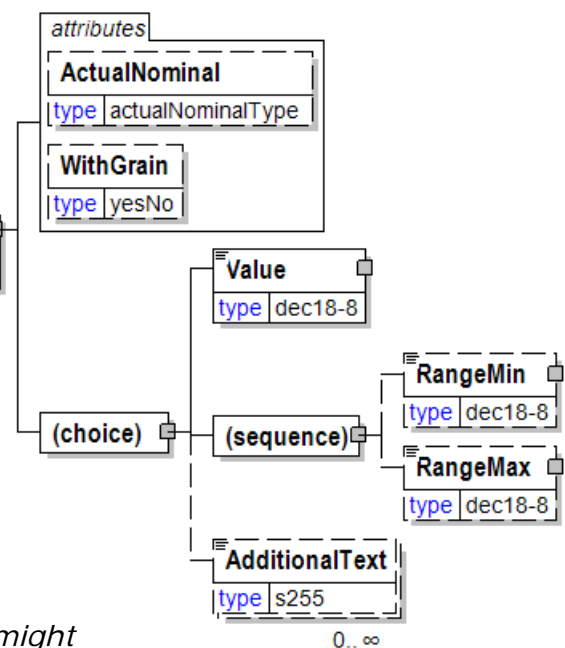

RangeMin

RangeMin is optional. A single instance might exist.

The minimum value (lower boundary) allowed for the Measurement that is the parent of this element.

RangeMax

RangeMax is optional. A single instance might exist.

The maximum value (upper boundary) allowed for the Measurement that is the parent of this element. Some elements use the RangeMax element with an extended list of unit of measures. (Note: the red colour in the picture is an artifact of how the graphic was captured and should be disregarded.)

AdditionalText

AdditionalText is optional because of choice construct.

A text field that is used to communicate information not previously defined or for special instructions. To be used only for circumstances not covered by specific elements.

Width

The approach for width used in the timber/lumber related constructs.

ActualNominal [attribute]

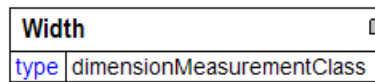

ActualNominal is optional. A single instance might exist.

Indicates the measurement approach used to communicate the dimensions of the individual pieces.

Refer to ActualNominal definition for any enumerations.

(choice)

[choice] is optional because of choice construct.

Value

Value is optional because of choice construct.

A numeric value expressed in the unit of measure (UOM).

(sequence)

The sequence of items below is mandatory. A single instance is required.

RangeMin

RangeMin is optional. A single instance might exist.

The minimum value (lower boundary) allowed for the Measurement that is the parent of this element.

RangeMax

RangeMax is optional. A single instance might exist.

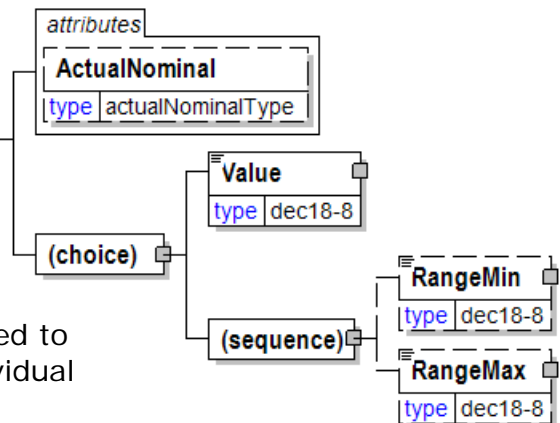

papiNet V2R31

The maximum value (upper boundary) allowed for the Measurement that is the parent of this element. Some elements use the RangeMax element with an extended list of unit of measures. (Note: the red colour in the picture is an artifact of how the graphic was captured and should be disregarded.)

Width

The width of the object.

(sequence)

The sequence of items below is mandatory. A single instance is required.

Value

Value is mandatory. A single instance is required.

A numeric value expressed in the unit of measure (UOM).

RangeMin

RangeMin is optional. A single instance might exist.

The minimum value (lower boundary) allowed for the Measurement that is the parent of this element.

RangeMax

RangeMax is optional. A single instance might exist.

The maximum value (upper boundary) allowed for the Measurement that is the parent of this element. Some elements use the RangeMax element with an extended list of unit of measures. (Note: the red colour in the picture is an artifact of how the graphic was captured and should be disregarded.)

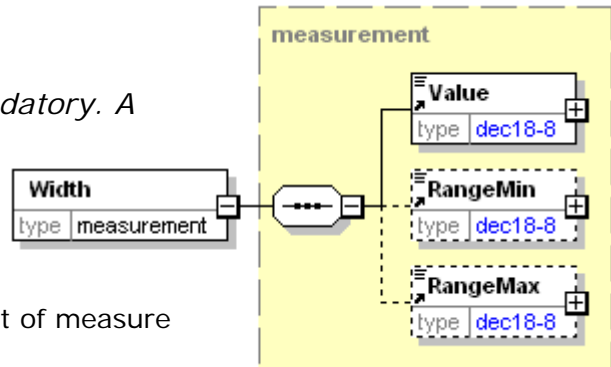

WindingDirection

An element that indicates how the material is wound on the reel.

This item is restricted to the following list.

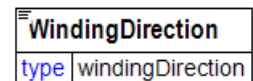

FaceIn

The face of the label is wound on the inside of the reel.

FaceOut

The face of the label is wound on the outside of the reel.

WireSideIn

When someone looks at a finished reel, the wire side of the sheet is facing the core.

WireSideOut

When someone looks at a finished reel, the wire side of the sheet is facing away from the core.

Any

Any approach to winding the reel is acceptable.

WireCoating [attribute]

Wire Coating

This item is restricted to the following list.

Yes

No

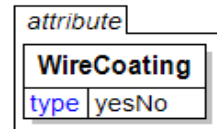

WireGauge

Wire Gauge

(sequence)

The sequence of items below is mandatory. A single instance is required.

Value

Value is mandatory. A single instance is required.

A numeric value expressed in the unit of measure (UOM).

RangeMin

RangeMin is optional. A single instance might exist.

The minimum value (lower boundary) allowed for the Measurement that is the parent of this element.

RangeMax

RangeMax is optional. A single instance might exist.

The maximum value (upper boundary) allowed for the Measurement that is the parent of this element. Some elements use the RangeMax element with an extended list of unit of measures. (Note: the red colour in the picture is an artifact of how the graphic was captured and should be disregarded.)

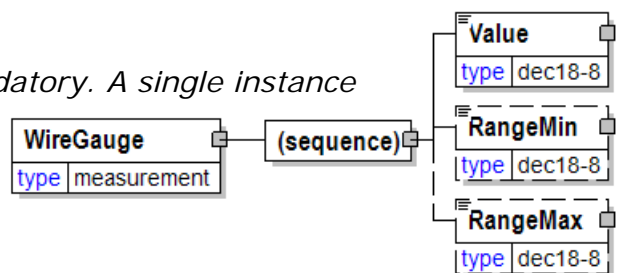

WireMaterial

Wire Material

WireCoating [attribute]

WireCoating is optional. A single instance might exist.

Wire Coating

Refer to WireCoating definition for any enumerations.

(sequence)

The sequence of items below is mandatory. A single instance is required.

WireGauge

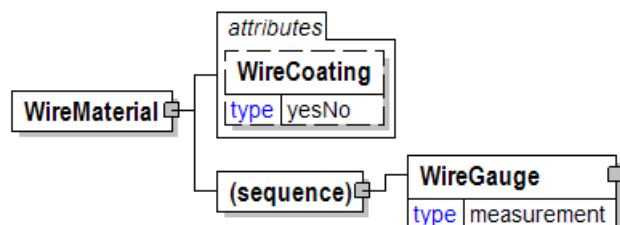

WireGauge is mandatory. A single instance is required.

Wire Gauge

WithGrain [attribute]

Either "Yes" or "No".

This item is restricted to the following list.

Yes

No

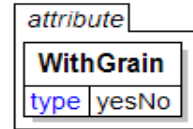

WoodBasedPanelGrade

Face [attribute]

Face is optional. A single instance might exist.

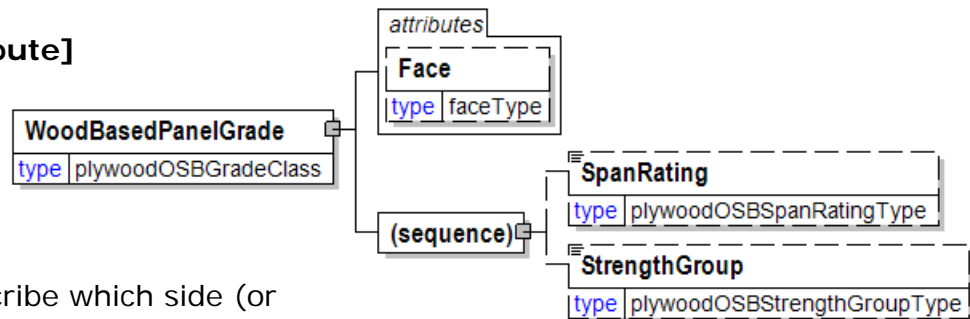

Used to describe which side (or face) of the product that the grade is applicable to.

Refer to Face definition for any enumerations.

(sequence)

The sequence of items below is mandatory. A single instance is required.

SpanRating

SpanRating is optional. A single instance might exist.

Span Rating according to NIST standards and indicated on grade stamp.

Refer to SpanRating definition for any enumerations.

StrengthGroup

StrengthGroup is optional. A single instance might exist.

As defined in the NIST standard, an additional classification of panel strength.

Refer to StrengthGroup definition for any enumerations.

WoodItem

Group element containing elements describing a wood industry product.

(sequence)

The sequence of items below is mandatory. A single instance is required.

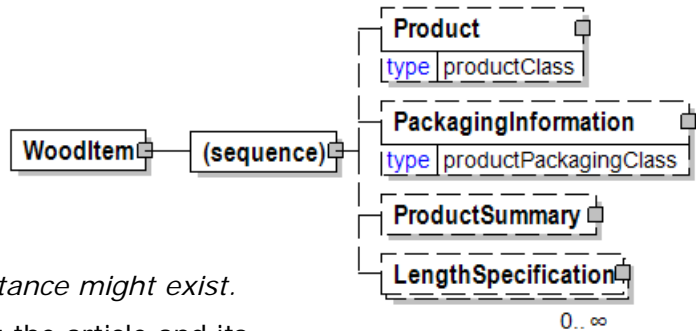

Product

Product is optional. A single instance might exist.

Product is a group item defining the article and its characteristics. Product is used to specify product characteristics organized by ProductIdentifier, ProductDescription, and Classification. Book Manufacturing, Label Stock, Paper, Pulp, Recovered Paper, Wood Products, and Virgin Fibre market segments have defined their product characteristics and conversion features for implementation in papiNet.

PackagingInformation

PackagingInformation is optional. A single instance might exist.

Group element construct used to all information associated with the packaging of a product. Measurements, package ID, label, stencil, band, pallet and wrap characteristics may all be detailed.

ProductSummary

ProductSummary is optional. A single instance might exist.

Group of elements to provide summary information on product level.

LengthSpecification

LengthSpecification is optional. Multiple instances might exist.

Length specification of the wood product.

WoodPanelCharacteristics

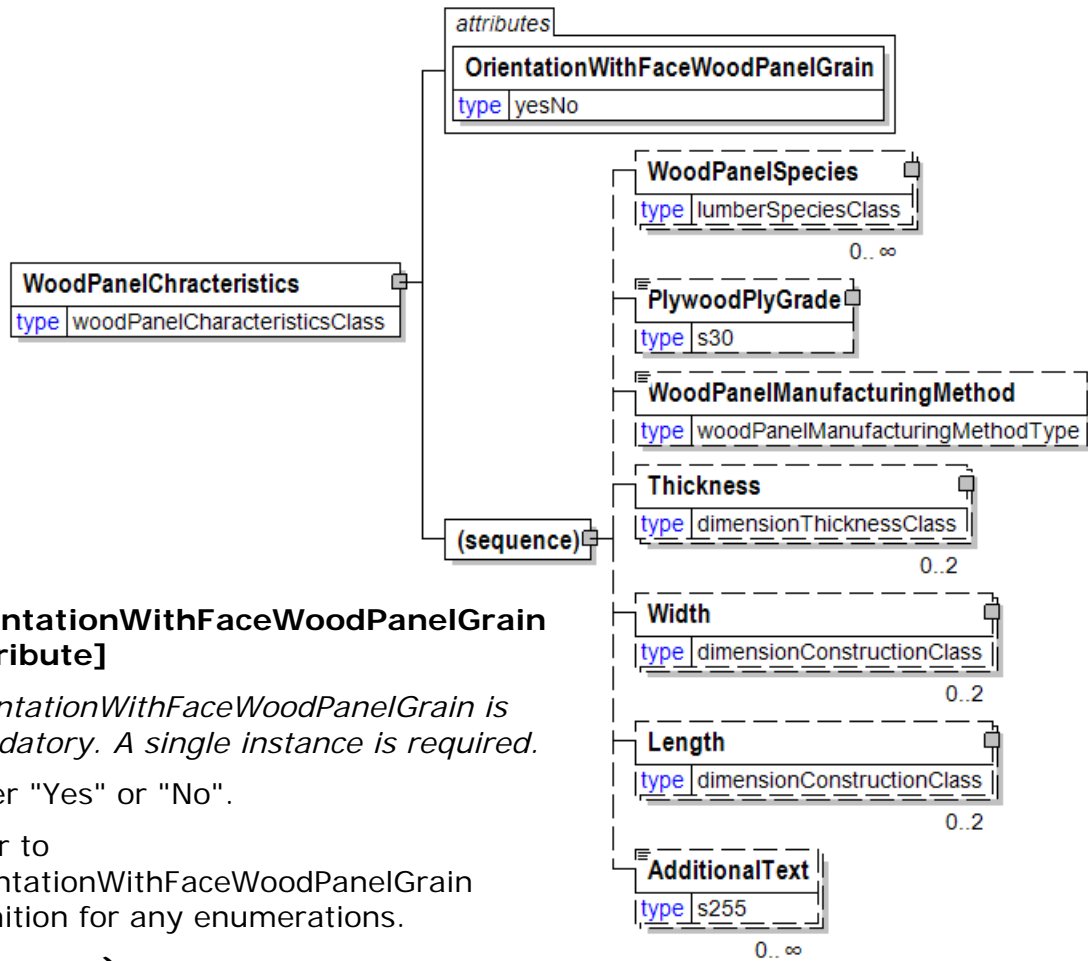

OrientationWithFaceWoodPanelGrain [attribute]

OrientationWithFaceWoodPanelGrain is mandatory. A single instance is required.

Either "Yes" or "No".

Refer to OrientationWithFaceWoodPanelGrain definition for any enumerations.

(sequence)

The sequence of items below is mandatory. A single instance is required.

WoodPanelSpecies

WoodPanelSpecies is optional. Multiple instances might exist.

Characteristics of the lumber used in the item.

PlywoodPlyGrade

PlywoodPlyGrade is optional. A single instance might exist.

Defines the grade of one ply, used with Agency to specify the grading agency.

WoodPanelManufacturingMethod

WoodPanelManufacturingMethod is optional. A single instance might exist.

The manufacturing method for the wood panels.

Refer to WoodPanelManufacturingMethod definition for any enumerations.

Thickness

Thickness is optional.

Physical dimension of a product.

Width

Width is optional.

The width of the object.

Length

Length is optional.

The length of the object.

AdditionalText

AdditionalText is optional. Multiple instances might exist.

A text field that is used to communicate information not previously defined or for special instructions. To be used only for circumstances not covered by specific elements.

WoodPanelManufacturingMethod

The manufacturing method for the wood panels.

WoodPanelManufacturingMethod
type woodPanelManufacturingMethodType

WoodPanelProducts

Characteristics of wood panelling products.

(sequence)

The sequence of items below is mandatory. A single instance is required.

WoodBasedPanelGrade

WoodBasedPanelGrade is optional. A single instance might exist.

WoodPanelSpecies

WoodPanelSpecies is optional. Multiple instances might exist.

Characteristics of the lumber used in the item.

Thickness

Thickness is optional.

Physical dimension of a product.

Width

Width is optional.

The width of the object.

Length

Length is optional.

The length of the object.

PlywoodLayupStructure

PlywoodLayupStructure is optional. A single instance might exist.

Edge

Edge is optional.

Describes the finishing of the edge of the board.

Side

Side is optional.

The structure defines the features of a panel's side. An attribute of side element indicates which side (either top or bottom the child elements refer to).

PressureTreatment

PressureTreatment is optional. A single instance might exist.

Method and parameter values of pressure treatment.

FireTreatment

FireTreatment is optional. A single instance might exist.

Fire treatment

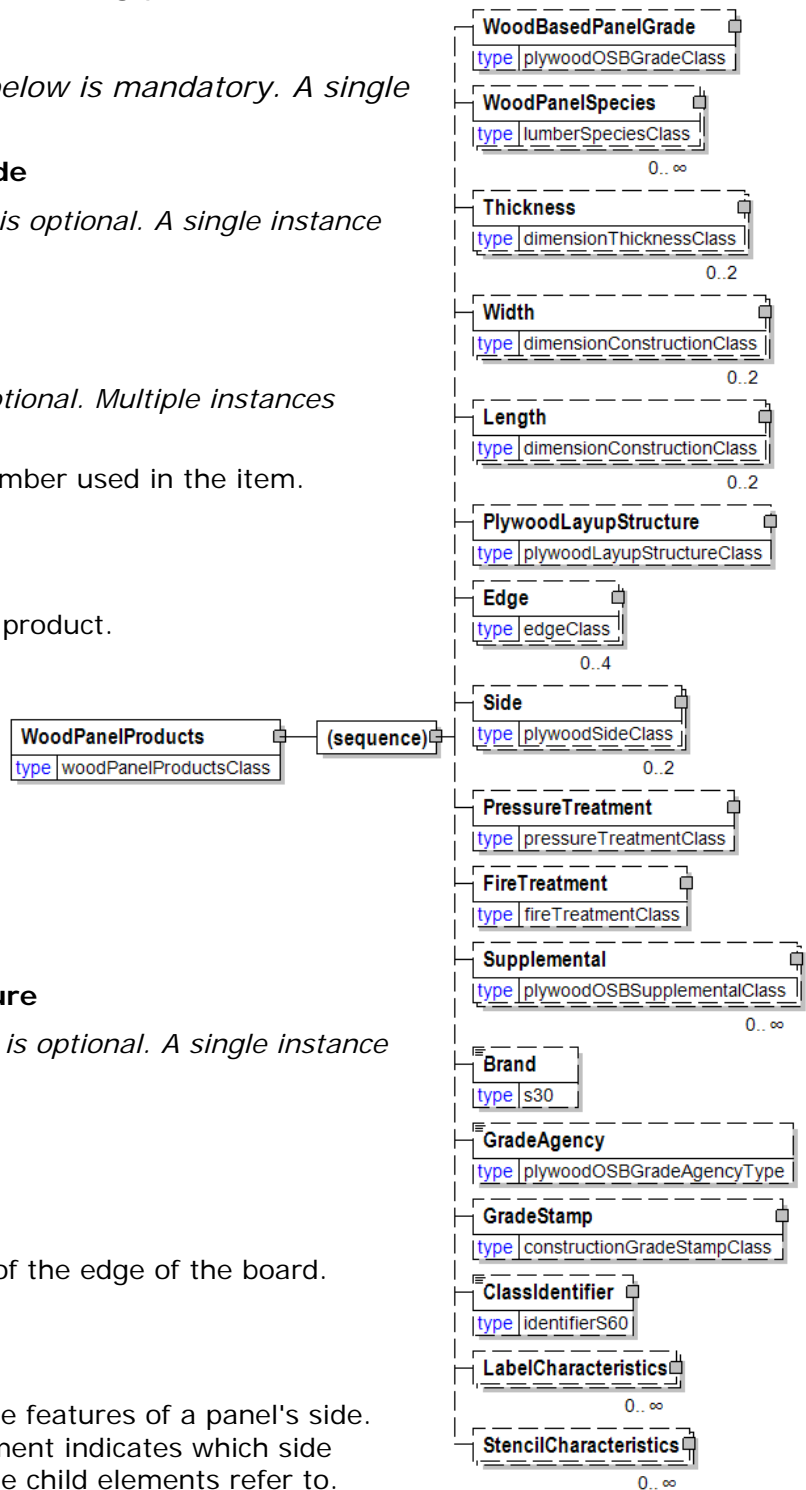

Supplemental

Supplemental is optional. Multiple instances might exist.

Supplemental

Brand

Brand is optional. A single instance might exist.

Specifies a brand or trade name of wrapping material to be used when wrapping the product.

GradeAgency

GradeAgency is optional. A single instance might exist.

North American structural panel grading agencies. Defines the governing organisation of the grading scheme employed.

Note: There is a GradeAgency attribute, as well.

Refer to GradeAgency definition for any enumerations.

GradeStamp

GradeStamp is optional. A single instance might exist.

Grade stamp information

ClassIdentifier

ClassIdentifier is optional. A single instance might exist.

Standard used for product identification.

LabelCharacteristics

LabelCharacteristics is optional. Multiple instances might exist.

A group item that organises the labeling information.

StencilCharacteristics

StencilCharacteristics is optional. Multiple instances might exist.

A group element specifying attributes of a stencil to be applied to an item, and optional text.

WoodPanelSpecies

Characteristics of the lumber used in the item.

SpeciesType [attribute]

SpeciesType is optional. A single instance might exist.

Defines the species or mix of species comprising the product.

Refer to SpeciesType definition for any enumerations.

SpeciesOrigin [attribute]

SpeciesOrigin is optional. A single instance might exist.

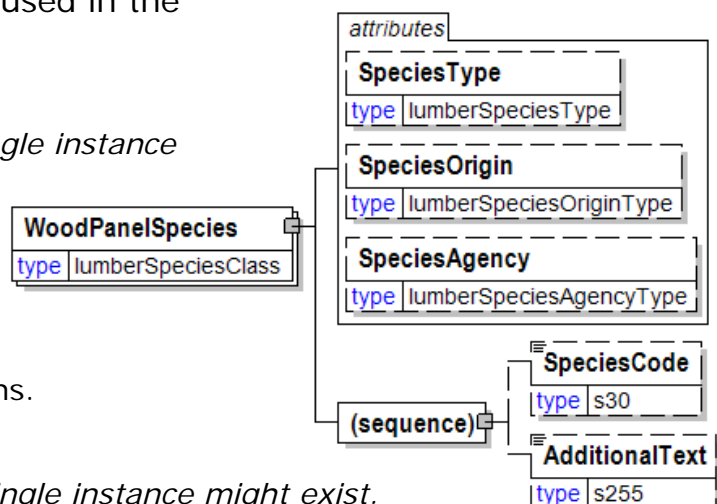

papiNet V2R31

The country of origin of the species employed in manufacture of the product.
Refer to SpeciesOrigin definition for any enumerations.

SpeciesAgency [attribute]

SpeciesAgency is optional. A single instance might exist.

Defines the governing organisation of the scheme employed in determining the species of the product.

Refer to SpeciesAgency definition for any enumerations.

(sequence)

The sequence of items below is mandatory. A single instance is required.

SpeciesCode

SpeciesCode is optional. A single instance might exist.

Species Code

AdditionalText

AdditionalText is optional. A single instance might exist.

A text field that is used to communicate information not previously defined or for special instructions. To be used only for circumstances not covered by specific elements.

WoodProducts

A grouping element for all wood products.

(sequence)

The sequence of items below is mandatory. A single instance is required.

(choice)

[choice] is optional because of choice construct.

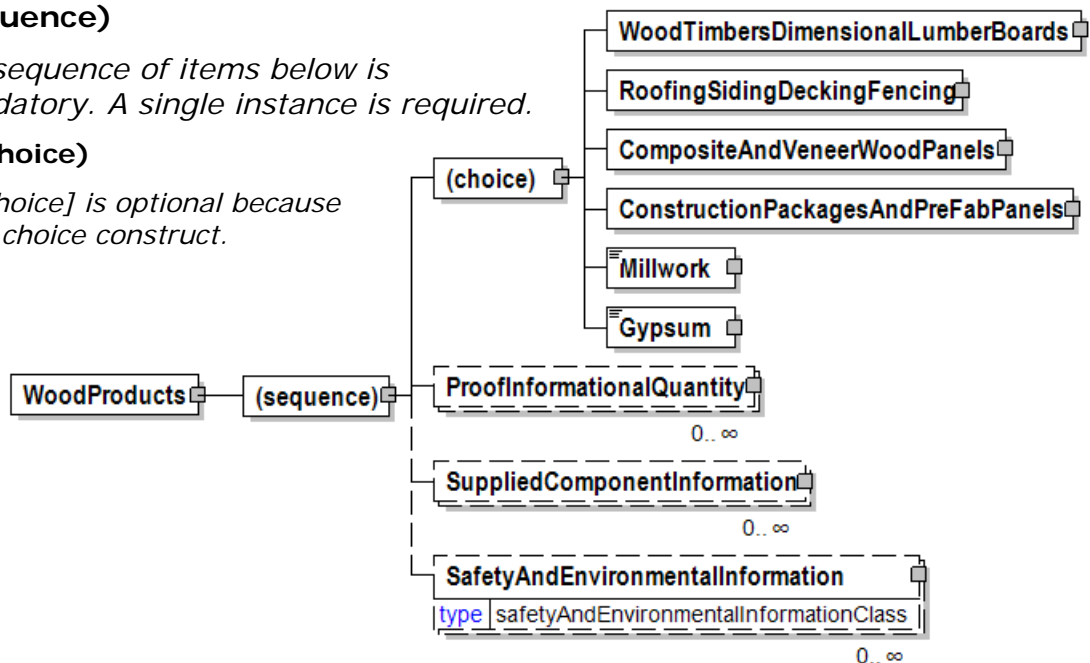

WoodTimbersDimensionalLumberBoards

WoodTimbersDimensionalLumberBoards is optional because of choice construct.

A grouping element that contains the various types of dimensional lumber.

RoofingSidingDeckingFencing

RoofingSidingDeckingFencing is optional because of choice construct.

A grouping element that contains the timber/lumber products that are used in roofing, siding, decking, or fencing.

CompositeAndVeneerWoodPanels

CompositeAndVeneerWoodPanels is optional because of choice construct.

A grouping element that contains the timber/lumber products that comprise composite and veneer wood panels.

ConstructionPackagesAndPreFabPanels

ConstructionPackagesAndPreFabPanels is optional because of choice construct.

A grouping element that contains the timber/lumber products that comprise construction packages and pre-fabricated panels.

Millwork

Millwork is optional because of choice construct.

A placeholder for the further definition of millwork items.

Gypsum

Gypsum is optional because of choice construct.

A placeholder for further definition of gypsum items.

ProofInformationalQuantity

ProofInformationalQuantity is optional. Multiple instances might exist.

ProofInformationalQuantity

SuppliedComponentInformation

SuppliedComponentInformation is optional. Multiple instances might exist.

Information about components supplied by the publisher to the vendor i.e. paper supplied to the print vendor or jackets supplied to the bind vendor.

SafetyAndEnvironmentalInformation

SafetyAndEnvironmentalInformation is optional. Multiple instances might exist.

Name of certification type, if any, on the goods (For example, FSC, PEFC).

SafetyAndEnvironmental needs a value or measurement to communicate the percentage of the product is certified (for example, 75% is certified by the indicated agency).

WoodTimbersDimensionalLumberBoards

A grouping element that contains the various types of dimensional lumber.

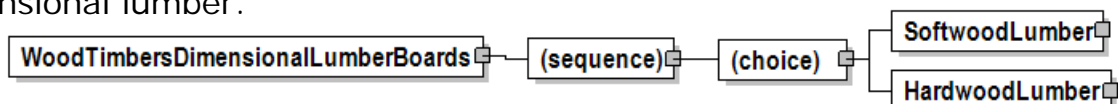

(sequence)

The sequence of items below is mandatory. A single instance is required.

(choice)

[choice] is optional because of choice construct.

SoftwoodLumber

SoftwoodLumber is optional because of choice construct.

Product structure for solid wood products made of softwood

HardwoodLumber

HardwoodLumber is optional because of choice construct.

Product structure for solid wood products made of hardwood.

Wrap

A group item that organises wrapping detail information.

WrapType [attribute]

WrapType is optional. A single instance might exist.

Communicates the type of material used to wrap the product.

Refer to WrapType definition for any enumerations.

WrapProperties [attribute]

WrapProperties is optional. A single instance might exist.

Communicates the nature of the wrap that is used to package the product

Refer to WrapProperties definition for any enumerations.

WrapLocation [attribute]

WrapLocation is optional. A single instance might exist.

Wrap Location

Refer to WrapLocation definition for any enumerations.

(sequence)

The sequence of items below is mandatory. A single instance is required.

NumberOfWraps

NumberOfWraps is optional. A single instance might exist.

The number of turns of wrapping material to be applied to the package.

Brand

Brand is optional. A single instance might exist.

Specifies a brand or trade name of wrapping material to be used when wrapping the product.

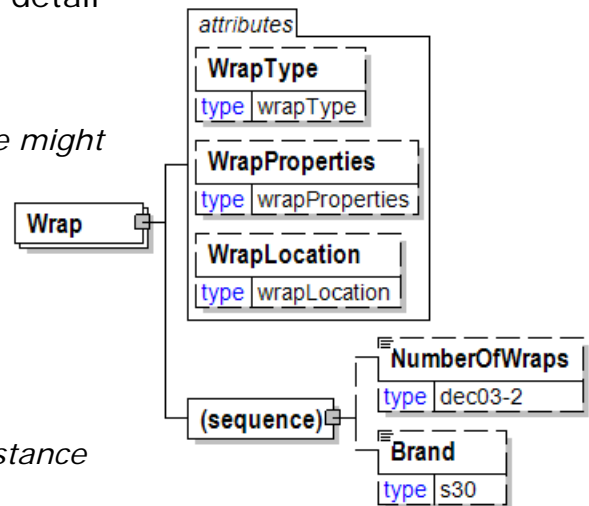

WrapCharacteristics

A group element that contains elements that describe the manner in which the item is wrapped.

(sequence)

The sequence of items

below is mandatory. A single instance is required.

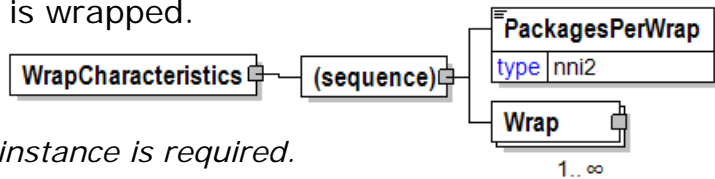

PackagesPerWrap

PackagesPerWrap is mandatory. A single instance is required.

The number of packages wrapped together.

Wrap

Wrap is mandatory. One instance is required, multiple instances might exist.

A group item that organises wrapping detail information.

WrapLocation [attribute]

Wrap Location

This item is restricted to the following list.

None

Entire

Indicates that the entire item (box, pallet, etc.) is wrapped.

Top

Bottom

FiveSides

TopAndEnds

Ends

LongSides

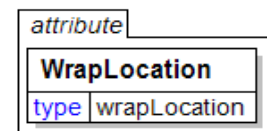

WrapProperties [attribute]

Communicates the nature of the wrap that is used to package the product

This item is restricted to the following list.

Bleached

the wrapping has been bleached using one of the methods described in the data type bleachingProcess.

Unbleached

the wrapping has not been bleached

MoistureBarrier

the wrapping provides a barrier to moisture.

Pulpable



the wrapping can be blended with pulp and reused.

WrapType [attribute]

Communicates the type of material used to wrap the product.

This item is restricted to the following list.

Cardboard

Chipboard

Fibreboard

KraftPaper

Kraft paper is used to wrap the product.

Laminatedboard

Metal

None

The product is not wrapped

Paper

Peelercores

Plastic

PlasticBag

The product is wrapped in a plastic bag.

Plywood

Self

The product is wrapped using the same material that is contained within.

ShrinkWrap

The product is wrapped using shrink wrap material.

StretchWrap

The product is wrapped using stretch wrap material.

Timber

attribute
WrapType
type wrapType

Year

Identifies the year number when communicating a calendar date.

Year
type gYear

Yellow

The Yellow component of a colour.

(sequence)

The sequence of items below is mandatory. A single instance is required.

DetailValue

DetailValue is mandatory. A single instance is required.

A numeric value expressed in the unit of measure (UOM).

DetailRangeMin

DetailRangeMin is optional. A single instance might exist.

The minimum value (lower boundary) allowed for the DetailValue that is the parent of this element.

DetailRangeMax

DetailRangeMax is optional. A single instance might exist.

The maximum value (upper boundary) allowed for the DetailValue that is the parent of this element.

StandardDeviation

StandardDeviation is optional. A single instance might exist.

A statistic used as a measure of dispersion in a distribution.

SampleSize

SampleSize is optional. A single instance might exist.

The number of samples used to determine the product characteristic in question.

TwoSigmaLower

TwoSigmaLower is optional. A single instance might exist.

Two sigma (a measure of dispersion associated with standard deviation) on the lower side of the standard deviation.

TwoSigmaUpper

TwoSigmaUpper is optional. A single instance might exist.

Two sigma (a measure of dispersion associated with standard deviation) on the upper side of the standard deviation.

