



papiNet

InvoiceWood

papiNet Standard - Version 2.31

Documentation

**Global Standard for the Paper and Forest
Products Supply Chain**

Build V2R31_20120413

Date 2012-04-13

Production Release

InvoiceWood

papiNet Standard - Version 2.31

Copyright

Copyright 2000 - 2012 papiNet G.I.E ("papiNet") and International Digital Enterprise Alliance, Inc. ("IDEAlliance") collectively "Copyright Owner". All rights reserved by the Copyright Owner under the laws of the United States, Belgium, the European Economic Community, and all states, domestic and foreign. This document may be downloaded and copied provided that all copies retain and display the copyright and any other proprietary notices contained in this document. This document may not be sold, modified, edited, or taken out of context such that it creates a false or misleading statement or impression as to the purpose or use of the papiNet specification, which is an open standard. Use of this Standard, in accord with the foregoing limited permission, shall not create for the user any rights in or to the copyright, which rights are exclusively reserved to the Copyright Owner.

papiNet, IDEAlliance, and the members of all papiNet Groups (collectively and individually, "Presenters") make no representations or warranties, express or implied, including, but not limited to, warranties of merchantability, fitness for a particular purpose, title, or non-infringement. The presenters do not make any representation or warranty that the contents of this document are free from error, suitable for any purpose of any user, or that implementation of such contents will not infringe any third party patents, copyrights, trademarks or other rights. By making use of this document, the user assumes all risks and waives all claims against Presenters.

In no event shall Presenters be liable to user (or other person) for direct, indirect, special or consequential damages arising from or related to any use of this document, including, without limitation, lost profits, business interruption, loss of programs, or other data on your information handling system even if Presenters are expressly advised of the possibility of such damages.

Use of Documents in papiNet Implementations

Documents may be used as templates for a papiNet implementation. The Presenters grant the right to modify and edit them to fit an actual implementation project provided all copies display the copyright and any other proprietary notices contained in this document. Such modified documents must not be distributed beyond the trading partners implementing or maintaining a papiNet connection.

InvoiceWood

papiNet Standard - Version 2.31

Table of Contents

Copyright	2
Use of Documents in papiNet Implementations	2
Table of Contents	3
InvoiceWood Documentation.....	4
InvoiceWood e-Document Overview	4
The Scope of InvoiceWood e-Document	4
InvoiceType [attribute].....	5
Business Rules for InvoiceWood.....	6
Processing the InvoiceWood e-Document	8
Understanding the Diagrams and Content	9
InvoiceWood Root Element	11
InvoiceWood.....	11
Primary Elements	14
InvoiceWoodHeader	14
InvoiceShipment	16
InvoiceProductGroup.....	17
InvoiceWoodLineItem.....	18
MonetaryAdjustment.....	22
InvoiceWoodSummary	28
InvoiceWood Business Scenarios	31
Invoice Scenario Listing.....	31
Scenario A.....	31
Scenario B.....	32
Scenario C.....	32
Scenario D	33
Scenario E	33

InvoiceWood

papiNet Standard - Version 2.31

InvoiceWood Documentation

InvoiceWood e-Document Overview

An InvoiceWood e-Document can handle both debits and credits. Typically a seller sends an invoice to a buyer after delivering the products or services specified in a purchase order or as part of an automatic replenishment agreement. Alternatively, an invoice can be prepared by the buyer as part of a self-billing process. The invoice is a list of the goods shipped and their quantities, or services rendered, indicating the price, terms of sale, supplemental charges, allowances, and communicates the payment required for the indicated items.

There are a variety of invoice types designed to fulfil different payment or documentation requirements. Sellers can use invoices to claim payment for goods supplied (a "regular" invoice), resend an invoice that the buyer misplaced or never received, request payment in advance of delivery, or provide information (usually to a third party) without claiming payment..

Invoice types of CreditNote and DebitNote are generally used by the Seller to compensate or charge the trading parties (ShipToParty, BuyerParty, OtherParty, etc.) for matters outside the scope of the invoice. Typically these matters include commercial claims, logistics claims, technical claims, invoice corrections, commissions, and rebates.

The InvoiceWood has been checked and found compliant with the EU Council Directive 2001/115/EC in force from 1 January 2004 in existing EU Member States and from 1 May 2004 in the Accession Countries. Directive 2001/115/EC harmonises, simplifies and modernises invoicing obligations on traders when they sell products or services that are subject to Value Added Tax (VAT). It also creates an EU legal framework for electronic transmission and storage of invoices. Refer to http://www.eic.ie/legislation/vat_invoicing.htm for additional information.

The Scope of InvoiceWood e-Document

The InvoiceWood e-Document can include:

- Specific contractual information
- Details referencing to the order and delivery message
- Seller's payment terms and bank account information
- Product, quantity and price information
- Invoice amount
- Taxes
- The reasons for the credit or debit
- Information to support custom requirements

An InvoiceWood e-Document assumes that a previous agreement between buyer and seller has taken place. It does not contain the contractual, legal, and other conditions of that agreement, which may be too lengthy to communicate on a transaction-by-transaction basis.

Notes:

- With the exception of contractual agreements, the seller

InvoiceWood

papiNet Standard - Version 2.31

assumes no previous alignment of data when generating an invoice.

- An invoice does not specify any detailed product information such as package specifications instead; it refers to the purchase order and delivery message.

InvoiceType [attribute]

Defines the various types of invoices. The Invoice has been checked and found compliant with the EU Council Directive 2001/115/EC in force from 1 January 2004 in existing EU Member States and from 1 May 2004 in the Accession Countries. Directive 2001/115/EC harmonises, simplifies and modernises invoicing obligations on traders when they sell products or services that are subject to Value Added Tax (VAT). It also creates an EU legal framework for electronic transmission and storage of invoices. Use http://www.eic.ie/legislation/vat_invoicing.htm for additional information.



Types of invoices not covered in this standard include:

- Delcredere – An invoice sent to the party paying for a number of buyers
- Factored – An invoice assigned to a third party for collection

This item is restricted to the following list.

Approximate

An Invoice that is created to record ownership transfer without the material physically being moved. Typically what occurs is that the buyer has agreed to take ownership of the item at a certain point in time but has not arranged for transportation. Approximate invoices are invoices that are claiming payment.

CreditNote

Credits that are provided for amount reductions and complaints. A CreditNote will normally have a reference to an earlier issued Invoice.

DebitNote

A DebitNote claims payment for additional charges. A DebitNote normally has a reference to an earlier issued Invoice.

Duplicate

To be removed in a future version. When an Invoice is reissued as a duplicate the Invoice type should be the same as on the original Invoice. Use attribute Reissued = Yes to indicate a duplicate.

Invoice

A regular Invoice (referred to as an Invoice) claiming payment for products, services and charges supplied under conditions agreed to between seller and buyer. The Invoice communicates, among other things, payment terms, payment method, and the payment amount required for one or more deliveries.

InvoiceWood

papiNet Standard - Version 2.31

PrePayment

A prepayment Invoice is used as a notification of amounts to be paid in advance. It is not a legal Invoice claiming payment for provided products or services.

ProForma

A pro-forma Invoice is not a legal Invoice claiming payment. A pro-forma Invoice is an e-Document serving as a preliminary Invoice, containing on the whole the same information as the final Invoice, but not actually claiming payment. Pro-forma invoices are typically used in a cross-border shipment for customs purposes. Can travel with the product or be sent to a broker.

SelfBillingStatement

A SelfBillingStatement is an Invoice that is prepared by the buyer of the product (or the consumer of the service) for the provider of the product or service. The preparer will pay the Invoice.

Typically logistics costs charges are the service that are communicated. They are incurred during a certain period of time between the party who provides the logistics services (typically the party with a LogisticsRole of "LogisticsProvider") and the requestor of such services (typically the party with a LogisticsRole of "Consignor").

Raw materials, maintenance, repair, and operating supplies are examples of products that can be entered on a self billing statement for products. This type of Invoice is also referred to as an Invoice for "evaluated receipts" because it developed from the receiving department's evaluation of their receipts and from that creating the Invoice.

The SelfBillingStatement process exists when there is a great deal of trust between the trading partners that permits this cost savings business process.

Business Rules for InvoiceWood

General Business Rules

The following table lists the business rules that apply to all InvoiceWood e-Document types. Rules that apply to a single InvoiceWood e-Document type are described in separate tables.

Identifier	Business Rule
IVW001	Invoice corrections are handled by indicating an InvoiceType attribute of CreditNote or DebitNote.
IVW002	Invoice cancellation is handled by issuing a CreditNote for invoiced debits or a DebitNote for invoiced credits.
IVW003	An Invoice e-Document can refer to one or more orders. Note: Some buying parties will require that an Invoice refer to a single order. This is an implementation decision fully supported by the e-Document structure.

InvoiceWood papiNet Standard - Version 2.31

IVW004	An Invoice e-Document can refer to one or more order line item(s). Note: Some buying parties will require that an Invoice refer to a single order line item. This is an implementation decision fully supported by the e-Document structure.
IVW005	An Invoice e-Document can refer to zero or more deliveries. An Invoice that does not refer to a delivery is typically a pro-forma or pre-payment Invoice. Note: Some buying parties will require that an Invoice refer to a single delivery. This is an implementation decision that is fully supported by the e-Document structure.
IVW006	An Invoice e-Document can refer to one or many ship-to parties. Note: Some buying parties will require that an Invoice refer to a single delivery. This is an implementation decision that is fully supported by the e-Document structure.
IVW017	At least one instance of either the Product or ChargeOrAllowance elements is required.
IVW019	TotalTermsDiscountTaxAmount in TotalNetOfTermsDiscount is mandatory when tax is specified for prompt payment discount.

Business Rules for Regular Invoice

For a regular InvoiceWood e-Document, the following rules apply in addition to the general rules:

Identifier	Business Rule
IVW007	The seller handles adjustments to a grouping of invoice lines using the Summary portion of the Invoice with multiple total quantities.
IVW008	The InvoiceWoodHeader includes TermsOfPayment. When there are multiple payment terms for the goods being invoiced, the seller needs to generate multiple invoices.
IVW009	An InvoiceWood may refer to one or more orders, order line items, deliveries, or call off messages.
IVW010	An Invoice for cross-border or export/import transactions may contain additional information for customs or statistical services.
IVW011	An Invoice may contain transport details.

InvoiceWood

papiNet Standard - Version 2.31

Business Rules for a CreditNote or DebitNote Invoice

For a credit note or debit note InvoiceWood e-Document, the following rule applies in addition to the general rules:

Identifier	Business Rule
IVW018	InvoiceTypes of CreditNote and DebitNote must contain a reason for the transaction.

Business Rules for Duplicate Invoice

For a duplicate InvoiceWood e-Document, the following rule applies in addition to the general rules:

Identifier	Business Rule
IVW012	A duplicate Invoice introduces no new information. If the buyer finds the original copy of the Invoice and processes it instead of the duplicate Invoice, no confusion will result.

Business Rules for PrePayment Invoice

For a pre-payment InvoiceWood e-Document, the following rule applies in addition to the general rules:

Identifier	Business Rule
IVW013	The seller handles monetary adjustments to a grouping of Invoice lines using the Summary portion of the Invoice with multiple total quantities.

Business Rules for ProForma Invoice

For a proforma InvoiceWood e-Document, the following rule applies in addition to the general rules:

Identifier	Business Rule
IVW014	[Removed]
IVW015	The seller handles monetary adjustments to a grouping of invoice lines using the Summary portion of the Invoice with multiple total quantities.
IVW016	An Invoice for cross-border or export/import transactions may contain additional information for customs or statistical services.

Processing the InvoiceWood e-Document

Invoices are issued when goods are shipped to the buyer. An Invoice is sent from a seller to a buyer specifying a request for payment for goods being consigned to the consignee.

An InvoiceWood is usually issued together with a DeliveryMessage (type =

InvoiceWood

papiNet Standard - Version 2.31

PackingSpecification).

e-Document processing depends on the e-Document type and on the value(s) in status field(s) at the e-Document, header, and line item levels. For the InvoiceWood e-Document, all e-Document types are processed in the same way. In addition, there are no status fields in the InvoiceWood e-Document.

Status Values Used When Processing the InvoiceWood e-Document

No special status values are used to communicate acceptance of the InvoiceWood e-Document. No amendment of the InvoiceWood e-Document is permitted.

The seller is responsible for ensuring that the combination of InvoiceNumber and InvoiceLineNumber are unique and refer to the same BuyerParty and Product throughout the life of the InvoiceWood. The buyer may reject a e-Document that includes a previously received combination of InvoiceNumber and InvoiceLineNumber. The buyer communicates that rejection to the seller via an agreed-to process. If no process is specified, the buyer uses phone or email.

Understanding the Diagrams and Content

This section provides a graphical view of the schema structures, a discussion of the item's children. You can find additional information about papiNet and the standard at www.papiNet.org.

The graphics contain content model indicators, cardinality indicators, and data type information.

Associated with each graphic are the definitions for the parent item and any associated child items. All attributes are listed first, followed by the elements.

The following information should help you interpret and understand this standard. Please note the following:

- Content Model and Cardinality operate together to determine if the element or attribute are required in the instance document.
- The same attribute can never appear multiple times in the same element so, you will never see a multiple cardinality indicator.

Content model indicators:

There are three possible types of content: "sequence", "choice", and "all". The papiNet standard currently does not use the "all" construct.

- (sequence)

The sequence of the items to the right of the graphic (or below the text) is required.

- (choice)

A choice of the items to the right of the graphic (or below the text) is permitted.

- (all)

All the items to the right of the graphic are required.

Cardinality indicators:

- Dotted line around element or attribute.

InvoiceWood

papiNet Standard - Version 2.31

A single instance of the item can optionally exist.

- Dotted line around item with range indicated below.

Multiple instances of the item can optionally exist.

- Solid line around item.

A single instance of the item must exist.

- Solid line around item with range indicated below

At least one instance must exist; multiple instances can optionally exist.

Datatype indication:

When a data type is assigned to an element (either a simple type or complex type) the name of the data type is presented beneath the item name in the graphic.

- In some cases additional information about the data type is presented (the default value).

Elements can either have content that is textual/numeric in nature or content that is made up of additional elements and/or attributes.

- When the content is textual/numeric in nature “three straight horizontal lines” will appear in the upper left-hand corner of the graphic. Pay attention to these elements because they are where you will be entering your information.
- When the content is made up of additional elements and/or attributes a “gray-box” will appear on the right-hand side of the graphic.
- If the graphic shows both the horizontal lines and the gray-box then, in the papiNet standard, the content below the element are attributes.

InvoiceWood

papiNet Standard - Version 2.31

InvoiceWood Root Element

InvoiceWood

The InvoiceWood element is the root element for the InvoiceWood e-Document.

An InvoiceWood e-Document can handle both debits and credits. Typically a seller sends an InvoiceWood to a buyer after delivering the products or services specified in a purchase order or as part of an automatic replenishment agreement. Alternatively, an InvoiceWood can be prepared by the buyer as part of a self-billing process. The InvoiceWood is a list of the goods shipped and their quantities, or services rendered, indicating the price, terms of sale, supplemental charges, allowances, and communicates the payment required for the indicated items.

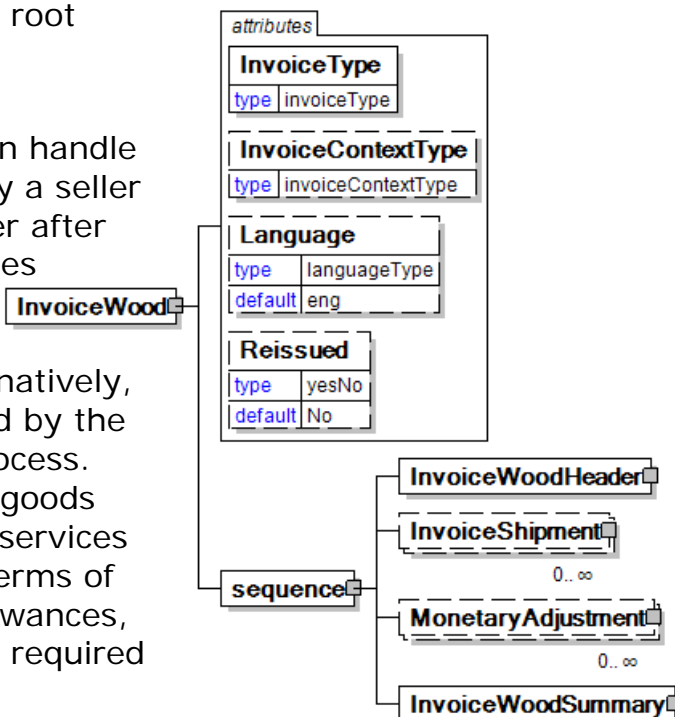

InvoiceType [attribute]

InvoiceType is mandatory. A single instance is required.

Defines the various types of invoices. The Invoice has been checked and found compliant with the EU Council Directive 2001/115/EC in force from 1 January 2004 in existing EU Member States and from 1 May 2004 in the Accession Countries. Directive 2001/115/EC harmonises, simplifies and modernises invoicing obligations on traders when they sell products or services that are subject to Value Added Tax (VAT). It also creates an EU legal framework for electronic transmission and storage of invoices. Use http://www.eic.ie/legislation/vat_invoicing.htm for additional information.

Types of invoices not covered in this standard include:

- Delcredere – An invoice sent to the party paying for a number of buyers
- Factored – An invoice assigned to a third party for collection

This item is restricted to the following list.

Approximate

An Invoice that is created to record ownership transfer without the material physically being moved. Typically what occurs is that the buyer has agreed to take ownership of the item at a certain point in time but has not arranged for transportation. Approximate invoices are invoices that are claiming payment.

CreditNote

Credits that are provided for amount reductions and complaints. A CreditNote will normally have a reference to an earlier issued Invoice.

DebitNote

A DebitNote claims payment for additional charges. A DebitNote normally has a reference to an earlier issued Invoice.

InvoiceWood

papiNet Standard - Version 2.31

Duplicate

To be removed in a future version. When an Invoice is reissued as a duplicate the Invoice type should be the same as on the original Invoice. Use attribute Reissued = Yes to indicate a duplicate.

Invoice

A regular Invoice (referred to as an Invoice) claims payment for products, services, and charges supplied under conditions agreed to between seller and buyer. The Invoice communicates, among other things, payment terms, payment method, and the payment amount required for one or more deliveries.

PrePayment

A prepayment Invoice is used as a notification of amounts to be paid in advance. It is not a legal Invoice claiming payment for provided products or services.

ProForma

A pro-forma Invoice is not a legal Invoice claiming payment. A pro-forma Invoice is an e-Document serving as a preliminary Invoice, containing on the whole the same information as the final Invoice, but not actually claiming payment. Pro-forma invoices are typically used in a cross-border shipment for customs purposes. Can travel with the product or be sent to a broker.

SelfBillingStatement

A SelfBillingStatement is an Invoice that is prepared by the buyer of the product (or the consumer of the service) for the provider of the product or service. The preparer will pay the Invoice.

Typically logistics costs charges are the service that are communicated. They are incurred during a certain period of time between the party who provides the logistics services (typically the party with a LogisticsRole of "LogisticsProvider") and the requestor of such services (typically the party with a LogisticsRole of "Consignor").

Raw materials, maintenance, repair, and operating supplies are examples of products that can be entered on a self billing statement for products. This type of Invoice is also referred to as an Invoice for "evaluated receipts" because it developed from the receiving department's evaluation of their receipts and from that creating the Invoice.

The SelfBillingStatement process exists when there is a great deal of trust between the trading partners that permits this cost savings business process.

InvoiceContextType [attribute]

InvoiceContextType is optional. A single instance might exist.

Indicates the nature of what is included in the Invoice.

This item is restricted to the following list.

LogisticsService

The Invoice is exclusively for logistics services.

Product

The Invoice includes product with optional logistics charges.

Language [attribute]

Language is optional. A single instance might exist.

XML has embraced 2 and 3 digit language codes through the application of an addendum to the standard.

InvoiceWood

papiNet Standard - Version 2.31

Information on the content of this attribute is available at <http://www.loc.gov/standards/iso639-2/> this is the official site of the ISO 639-2 Registration Authority.

- <http://www.w3.org/International/O-HTML-tags.html> provides an explanation of the errata updating XML.
- <http://www.ietf.org/rfc/rfc3066.txt> is the key document that is referenced in the above errata.

Reissued [attribute]

Reissued is optional. A single instance might exist.

Either "Yes" or "No".

This item is restricted to the following list.

Yes

No

(sequence)

The contents of (sequence) are mandatory. A single instance is required.

InvoiceWoodHeader

InvoiceWoodHeader is mandatory. A single instance is required.

This element contains the information that is consistent for the entire InvoiceWood document.

InvoiceShipment

InvoiceShipment is optional. Multiple instances might exist.

Shipment grouping for invoiced items.

MonetaryAdjustment

MonetaryAdjustment is optional. Multiple instances might exist.

The element containing the information necessary for the understanding, calculation, and treatment of an adjustment to a currency amount. MonetaryAdjustment contains an attribute that indicates they type of adjustment being communicated.

InvoiceWoodSummary

InvoiceWoodSummary is mandatory. A single instance is required.

Summary information that applies to all items on a Wood Market Segment Invoice.

InvoiceWood

papiNet Standard - Version 2.31

Primary Elements

InvoiceWoodHeader

This element contains the information that is consistent for the entire InvoiceWood document.

(sequence)

The sequence of items below is mandatory. A single instance is required.

InvoiceNumber

InvoiceNumber is mandatory. A single instance is required.

The identification number of the papiNet e-Document Invoice. This number uniquely identifies documents for all InvoiceType such as Invoice, DebitNote, CreditNote, Approximate, SelfBillingStatement etc

InvoiceDate

InvoiceDate is mandatory. A single instance is required.

A date that is qualifying the invoicing period. This date often drives payment terms. Note that this date is not necessarily the same as the issue date of the invoice.

OtherDate

OtherDate is optional. Multiple instances might exist.

A date that may not be specifically detailed within a document (example: print date at the PurchaseOrderLineItem).

InvoiceReference

InvoiceReference is optional. Multiple instances might exist.

A group item detailing relevant references pertaining to the invoice e-Document. InvoiceReferenceType describes the content.

BillToParty

BillToParty is mandatory. A single instance is required.

The address where the invoice is to be sent.

SupplierParty

SupplierParty is mandatory. A single instance is required.

The organisation or business entity responsible for providing the product. SupplierParty is also the seller of the product, if Seller is not specified as OtherParty = Seller.

BuyerParty

BuyerParty is mandatory. A single instance is required.

The legal entity to which the product is sold. Also commonly referred to as the sold-to party or customer. If no OtherParty is defined

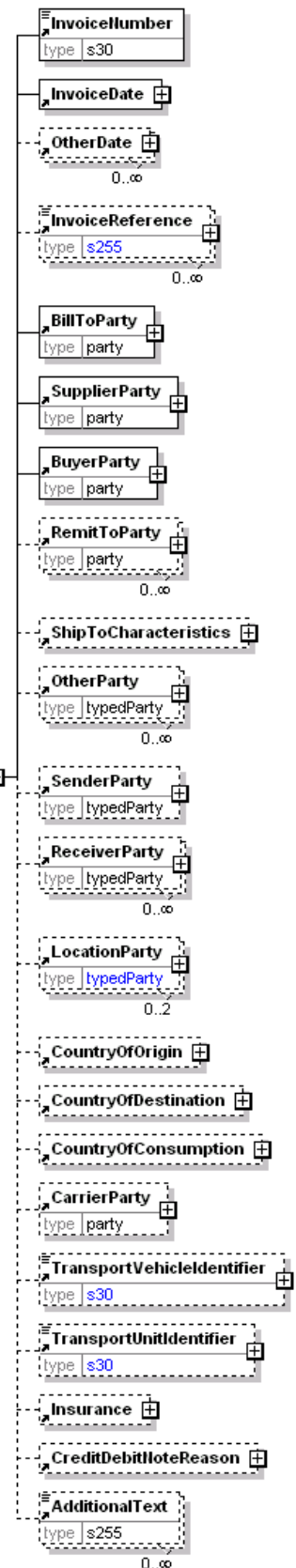

InvoiceWood

papiNet Standard - Version 2.31

as the Payer, the Buyer is the Payer.

RemitToParty

RemitToParty is optional. Multiple instances might exist.

A group item containing details of the party to whom payment will be made. The RemitToParty contains all information related to remittance.

ShipToCharacteristics

ShipToCharacteristics is optional. A single instance might exist.

A group item that provides information important for the Ship-To Party.

A group item that provides information important for the Ship-To Party. ShipToCharacteristics may be referenced at both the header and line item level. The reference at the header is required and acts as a default for the value at the line level, unless overridden at the line level.

OtherParty

OtherParty is optional. Multiple instances might exist.

An organisation or business entity other than those specifically detailed within a e-Document.

SenderParty

SenderParty is optional. A single instance might exist.

The business entity issuing the e-Document, the source of the document.

- The entity responsible for the content. If the sender party has out sourced the message service to a third party the SenderParty is the issuer of the e-Document and not the party performing the transmission service of the electronic message.

ReceiverParty

ReceiverParty is optional. Multiple instances might exist.

The business entity for whom the e-Document is intended, the destination of the document.

- The entity interested in the content. If the receiver party has outsourced the message service to a third party the ReceiverParty is the intended party for the e-Document and not the party performing the receiving service of the electronic message.

LocationParty

LocationParty is optional.

The organization or business entity where the business event took place or will take place.

CountryOfOrigin

CountryOfOrigin is optional. A single instance might exist.

The country of origin for the material.

CountryOfDestination

CountryOfDestination is optional. A single instance might exist.

The country where the goods will be, or were, shipped to.

CountryOfConsumption

CountryOfConsumption is optional. A single instance might exist.

The country of consumption for the material.

InvoiceWood

papiNet Standard - Version 2.31

CarrierParty

CarrierParty is optional. A single instance might exist.

The party performing the transport of the product from the pickup location to the ship-to location; could be a hauler.

TransportVehicleIdentifier

TransportVehicleIdentifier is optional. A single instance might exist.

The identifier of the transport vehicle (license plate number, voyage number, or vessel name). TransportVehicleIdentifier contains the TransportVehicleIdentifierType attribute.

TransportUnitIdentifier

TransportUnitIdentifier is optional. A single instance might exist.

The identifier of the transport unit, such as a container ID. It could be a license plate number if the transport unit is the vehicle at the same time. The type of identifier is indicated by the TransportUnitIdentifierType.

Insurance

Insurance is optional. A single instance might exist.

Group element containing information about insurance

CreditDebitNoteReason

CreditDebitNoteReason is optional. A single instance might exist.

A group item containing the reason for the entire CreditDebitNote.

AdditionalText

AdditionalText is optional. Multiple instances might exist.

A text field that is used to communicate information not previously defined or for special instructions. To be used only for circumstances not covered by specific elements.

InvoiceShipment

Shipment grouping for invoiced items.

(sequence)

The contents of (sequence) are mandatory. A single instance is required.

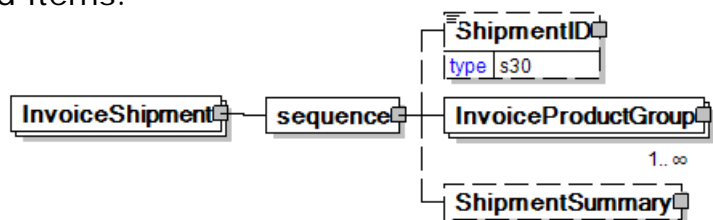

ShipmentID

ShipmentID is optional. A single instance might exist.

The ShipmentID may be a Bill of Lading Marking, which is customer's reference mark on each package used for logistic purposes. Should not be mixed up with Bill of Lading number. Another example of ShipmentID is grouping by a ContainerID.

InvoiceProductGroup

InvoiceProductGroup is mandatory. One instance is required, multiple instances might exist.

Product grouping for invoiced items.

ShipmentSummary

InvoiceWood

papiNet Standard - Version 2.31

ShipmentSummary is optional. A single instance might exist.

Summary information for an entire shipment

InvoiceProductGroup

Product grouping for invoiced items.

(sequence)

The sequence of items below is mandatory. A single instance is required.

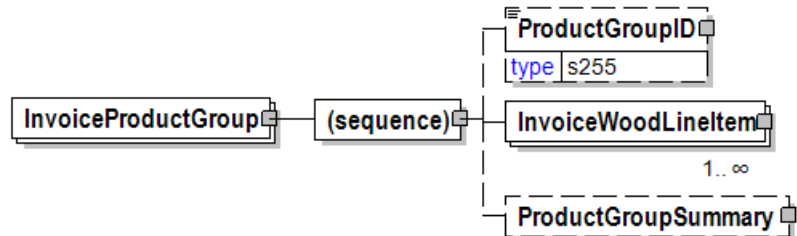

ProductGroupID

ProductGroupID is optional. A single instance might exist.

Possibility to group packages or Shipments. Example: Creating temporary group ID's for logistic reasons or lot number.

InvoiceWoodLineItem

InvoiceWoodLineItem is mandatory. One instance is required, multiple instances might exist.

Specific information for a given item on an Invoice.

- Note Business Rule IVW017: At least one instance of either the Product or ChargeOrAllowance elements is required.

ProductGroupSummary

ProductGroupSummary is optional. A single instance might exist.

Group of elements to provide summary information on product level.

InvoiceWood papiNet Standard - Version 2.31

InvoiceWoodLineItem

Specific information for a given item on an Invoice.

- Note Business Rule IVW017: At least one instance of either the Product or ChargeOrAllowance elements is required.

(sequence)

The sequence of items below is mandatory. A single instance is required.

InvoiceLineNumber

InvoiceLineNumber is mandatory. A single instance is required.

The sequential number that uniquely identifies the Invoice line item. It may enable the Invoice to be printed, viewed, or discussed in a common order.

PurchaseOrderInformation

PurchaseOrderInformation is optional. A single instance might exist.

A group item containing information unique to this purchase order, which is provided by the buyer. PurchaseOrderInformation can be optional in the supply chain. Invoices are created without having a Purchase Order in Vendor Managed Inventory. Freight invoices also will not have a Purchase Order number.

PurchaseOrderLineItemNumber

PurchaseOrderLineItemNumber is optional. A single instance might exist.

The sequential number that uniquely identifies the purchase order line item.

DocumentReferenceInformation

DocumentReferenceInformation is optional. Multiple instances might exist.

A group item containing reference information applicable to a document.

EndsDiscountInformation

EndsDiscountInformation is optional. A single instance might exist.

Rule for calculating the ends discount, expressed by a code.

ChargeOrAllowance

ChargeOrAllowance is optional. A single instance might exist.

The description of the charge or allowance; such as freight, special handling, and stop-off handling.

Product

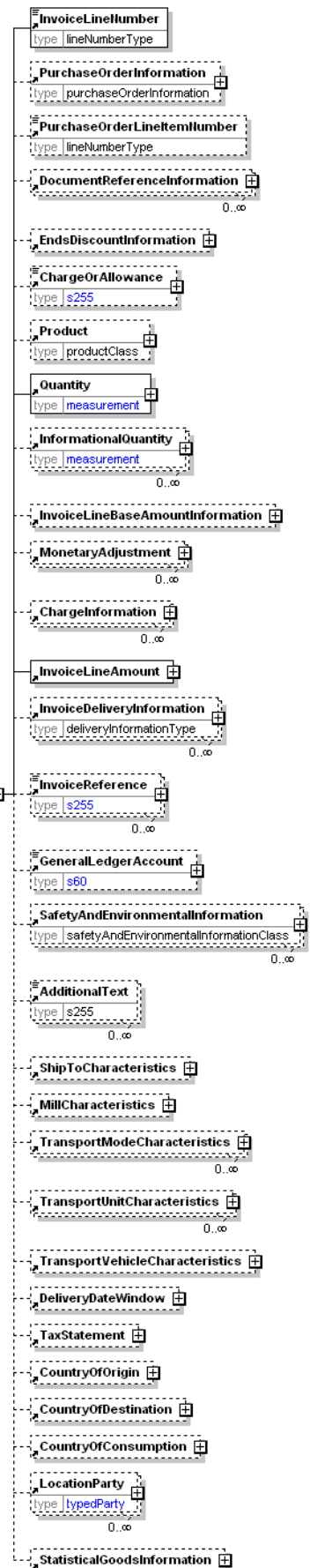

InvoiceWood

papiNet Standard - Version 2.31

Product is optional. A single instance might exist.

Product is a group item defining the article and its characteristics. Product is used to specify product characteristics organized by ProductIdentifier, ProductDescription, and Classification. Book Manufacturing, Label Stock, Paper, Pulp, Recovered Paper, Wood Products, and Virgin Fibre market segments have defined their product characteristics and conversion features for implementation in papiNet.

Quantity

Quantity is mandatory. A single instance is required.

The Quantity element contains attributes that provide information about the type of quantity that is being communicated, the context in which the particular quantity is to be viewed, and (if the quantity represents an adjustment) an adjustment type.

The Quantity element contains three child elements that enable you to communicate a range of values for the quantity and a target or actual value. It is at this level (Value, RangeMin, and RangeMax) that the unit of measure is specified. This permits the range to be specified in a different unit of measure than the target.

InformationalQuantity

InformationalQuantity is optional. Multiple instances might exist.

A quantity given in a valid UOM used for information purposes only (not for calculation). For example, an ordered quantity was 100 reels as opposed to the invoice quantity of 20,000 pounds.

InvoiceLineBaseAmountInformation

InvoiceLineBaseAmountInformation is optional. A single instance might exist.

A group item containing the price per unit and the invoice price amount subtotal.

MonetaryAdjustment

MonetaryAdjustment is optional. Multiple instances might exist.

The element containing the information necessary for the understanding, calculation, and treatment of an adjustment to a currency amount. MonetaryAdjustment contains an attribute that indicates they type of adjustment being communicated.

ChargeInformation

ChargeInformation is optional. Multiple instances might exist.

A group element that contains elements that describe a charge.

InvoiceLineAmount

InvoiceLineAmount is mandatory. A single instance is required.

The total invoice amount per line (includes adjustments and tax).

- InvoiceLineAmount is equal to the InvoiceLineBaseAmount plus the sum of the signed values of the MonetaryAdjustmentAmount for all instances of MonetaryAdjustment.

InvoiceDeliveryInformation

InvoiceDeliveryInformation is optional. Multiple instances might exist.

A group item that contains delivery information for invoice purposes. The delivery information that is contained will be similar to that on the DeliveryMessage.

InvoiceReference

InvoiceWood

papiNet Standard - Version 2.31

InvoiceReference is optional. Multiple instances might exist.

A group item detailing relevant references pertaining to the Invoice e-Document. InvoiceReferenceType describes the content.

GeneralLedgerAccount

GeneralLedgerAccount is optional. A single instance might exist.

The general ledger account to be referenced for the item.

SafetyAndEnvironmentalInformation

SafetyAndEnvironmentalInformation is optional. Multiple instances might exist.

Name of certification type, if any, on the goods (For example, FSC, PEFC). SafetyAndEnvironmental needs a value or measurement to communicate the percentage of the product is certified (for example, 75% is certified by the indicated agency).

AdditionalText

AdditionalText is optional. Multiple instances might exist.

A text field that is used to communicate information not previously defined or for special instructions. To be used only for circumstances not covered by specific elements.

ShipToCharacteristics

ShipToCharacteristics is optional. A single instance might exist.

A group item that provides information important for the Ship-To Party.

A group item that provides information important for the Ship-To Party. ShipToCharacteristics may be referenced at both the header and line item level. The reference at the header is required and acts as a default for the value at the line level, unless overridden at the line level.

MillCharacteristics

MillCharacteristics is optional. A single instance might exist.

A group item defining the mill party and machine identifier where a product is or was produced.

TransportModeCharacteristics

TransportModeCharacteristics is optional and repeatable .Multiple instances might exist.

A group item defining the primary mode of transport.

TransportUnitCharacteristics

TransportUnitCharacteristics is optional. Multiple instances might exist.

A group item defining and identifying the primary means of containing the goods. In some instances, the transport unit and vehicle are the same.

TransportVehicleCharacteristics

TransportVehicleCharacteristics is optional. A single instance might exist.

A group item defining the primary means of transporting the goods, such as a side port vessel. In some instances, the transport unit and vehicle are the same.

DeliveryDateWindow

DeliveryDateWindow is optional. A single instance might exist.

A group item defining the date/time interval for delivery to take place. An element

InvoiceWood

papiNet Standard - Version 2.31

which may contain the estimated date for which delivery is expected. This date is not absolute.

TaxStatement

TaxStatement is optional. A single instance might exist.

A group element for declaration of exception from normal charges of tax and the reason for tax exemption.

CountryOfOrigin

CountryOfOrigin is optional. A single instance might exist.

The country of origin for the material.

CountryOfDestination

CountryOfDestination is optional. A single instance might exist.

The country where the goods will be, or were, shipped to.

CountryOfConsumption

CountryOfConsumption is optional. A single instance might exist.

The country of consumption for the material.

LocationParty

LocationParty is optional. Multiple instances might exist.

The organization or business entity where the business event took place or will take place.

StatisticalGoodsInformation

StatisticalGoodsInformation is optional. A single instance might exist.

A group item containing statistical information about handled or traded goods.

MonetaryAdjustment

The element containing the information necessary for the understanding, calculation, and treatment of an adjustment to a currency amount.

MonetaryAdjustment contains an attribute that indicates they type of adjustment

being communicated.

AdjustmentType [attribute]

AdjustmentType is mandatory. A single instance is required.

Describes the type of adjustment applied to a monetary oriented element. Adjustments values should always be given as negative or positive adjustments even if AdjustmentType indicates the sign. For example, a rebate of 1% on an Invoice should be given as an adjustment percentage of -1%.

This item is restricted to the following list.

BillOfLadingCharge

An extra charge for creating a Bill of Lading.

CancellationCharge

A charge applied because a cancellation was late (after the last date of change) and all or part of the ordered product has already been made.

CashDiscount

A reduction due to a discount applied.

CertificateCharge

An extra charge for creating a certificate. Some countries requires Certificates in which different characteristics of the delivery, transport unit, route, product, and others must be proved.

There are certificates for gasen pallets, for the place of production, for the age of the ship/vessel, for not departing from one country's harbour when delivering to another.

ChargesForward

A pending invoice amount brought forward from a previous Invoice.

ClaimAdjustment

An adjustment related to a filed complaint.

Commission

Commission costs paid to the trading agency or trader.

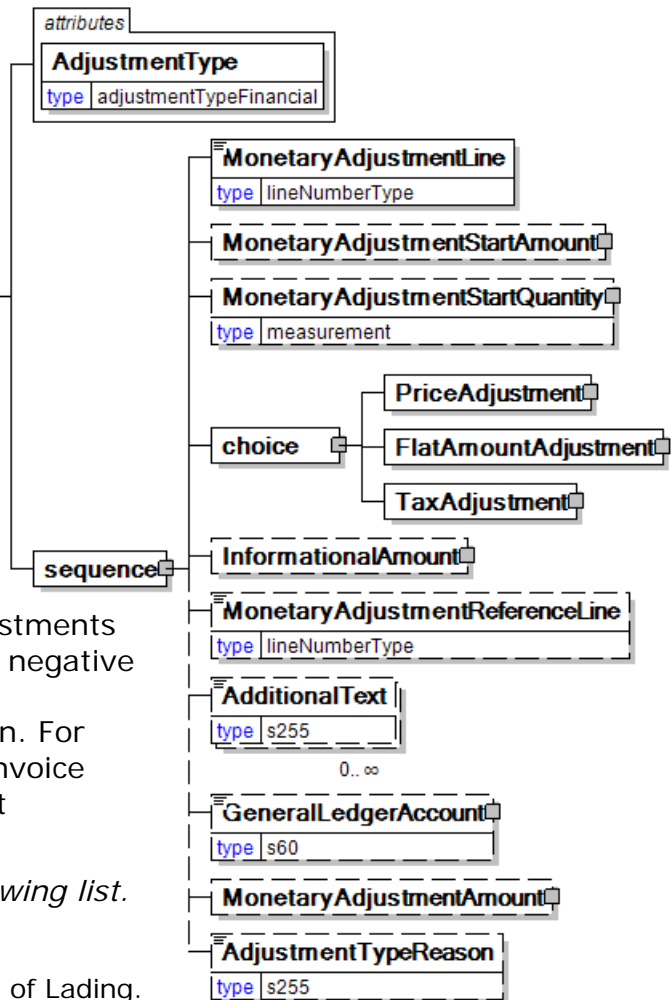

InvoiceWood

papiNet Standard - Version 2.31

CompetitiveAllowance

An allowance provided for competitive reasons.

CongestionCharge

An extra fee from ports for waiting time of ships in ports, railcars on a siding, trucks at a dock. (Synonym: Demurrage.)

ConsigneeUnloadCharge

An unloading charge that is the responsibility of the consignee.

ContractAllowance

An allowance for a volume discount, usually because the agreed amount has been exceeded.

CurrencyAdjustmentCharge

An extra fee to adjust for currency variations.

DecimalRounding

Adjustments for rounding of amounts to fit the business agreement or national monetary legislation. This adjustment is typically used for decimal rounding of amounts not including tax.

N.B. Use InformationalAmount with AmountType "DecimalRounding" for specification of decimal rounding of amounts including tax.

DefectiveAllowance

An allowance provided for defective material.

DeliveryCharge

The charge for delivering the product.

DeliveryNonConformanceAllowance

An allowance due to non-conformance with the purchase agreement regarding a delivery.

DeliveryTimeBonus

A bonus given for deliveries of products within a certain time period.

EarlyShipAllowance

An allowance due to a delivery that took place earlier than planned. The seller may be charged a penalty. If this is found before issuing the Invoice, it can be handled through this allowance. If found later, it will be handled through a credit note.

EnergySurcharge

A charge related to increases in the cost of energy.

Environmental

An allowance applied due to environmental regulations.

ExpeditedShipmentCharge

An extra cost charged due to unexpected or emergency requirements (for example, breaking off a run in the mill to reach the production date for a rush order).

ExportClearanceCharge

An extra fee for customs administration.

FlatRateCharge

InvoiceWood

papiNet Standard - Version 2.31

A general flat charge.

FreightAllowance

The freight cost allowed by the mill. This amount is negative, and will be deducted from the Invoice (U.S. business practice, in the European Union (EU), use only Freight Charge).

FreightCharge

The actual cost incurred to deliver the product. This amount is positive, and will be added to the Invoice.

FuelAdjustmentCharge

An extra fee, usually from shipping companies, to adjust fuel prices.

HandlingCharge

A charge related to the handling of the product.

Inspection

The cost associated with performing an inspection of the product.

InterestCharge

A charge applied for interest on overdue payments.

LabourAllowance

An allowance due to additional labour required in the use or acceptance of the product.

LabourCharge

A charge due to additional labour required in the use or acceptance of the product.

LoggingDamage

An adjustment caused by logging damages on Forest Wood products. Logging damages normally cause a reduction of the product price.

LotCharge

A charge applied to the lot of material.

MetalDetection

A charge for additional metal detection applied to the goods.

ModelHomeDiscount

A discount associated with the building of the model home.

NewStoreCouponDiscount

A discount associated with entry into a new store.

OrderQuantity

A charge or allowance for small/big ordered quantities.

PalletCharge

A charge that represents the cost or rental of the pallet.

PickUpAllowance

An allowance provided to compensate for the cost of picking up the product.

PromotionalAllowance

An allowance provided for the promotion of the product.

InvoiceWood

papiNet Standard - Version 2.31

PromotionalCharge

A charge associated with the promotion of the product.

PriceCorrection

An adjustment associated with a correction of the product's price.

ProductionSetUpCharge

A special charge applied due to specific buyer requests.

Provision

The act of making ready or equipping for use.

Rebate

A rebate accepted by the buyer and seller based on the agreed price and volume.

ReelDiscount

An allowance for purchasing reels instead of sheets.

ReturnedLoadAllowance

An allowance applied due to the return of the load.

ReturnLoadCharge

A charge applied due to the return of the load.

RoadFeeCharge

A freight charge for a special tax applied to road transports in some countries, e.g. Germany

ScrapAndDunnageCharge

A charge that represents the scrapping of the material and its removal.

ServiceCharge

A charge associated with a miscellaneous service.

SpecialConversionCharge

Additional charge for a special conversion of the product.

SpecialDeliveryCharge

A special charge for delivering the product differently from the usual or agreed-to method.

SpecialHandlingCharge

A special charge for handling the product differently from the usual or agreed-to method.

SpecialPackagingCharge

A special charge for packaging the product differently from the usual or agreed-to method, or if packaging as requested is out of spec.

StopOffAllowance

An allowance for a delivery stop-off.

StopOffCharge

A charge for a delivery stop-off.

StorageAllowance

An allowance for storing the product.

InvoiceWood

papiNet Standard - Version 2.31

StorageCharge

An extra cost charged for storing the product on location (in the plant).

Tax

An adjustment that reflects a tax item.

TestingCharge

A charge related to testing a paper grade.

TradeDiscount

A discount based on the terms of the trade given on the agreed price. Usually a percentage.

TrialDiscount

A discount applied for a trial run of a new or improved product.

TransferCharge

A freight charge incurred by the goods transfer from one location to another location not previously agreed upon.

UnloadingAllowance

An allowance to compensate for the unloading the product.

UnloadingCharge

A charge for the unloading the product.

VolumeDiscount

A rebate accepted by the buyer and the seller based on the agreed volume

WarRiskCharge

An extra fee from transport companies for transport units that cross war zones.

Other

Any other adjustment not covered by the attribute list.

(sequence)

The contents of (sequence) are mandatory. A single instance is required.

MonetaryAdjustmentLine

MonetaryAdjustmentLine is mandatory. A single instance is required.

A sequence number indicating the order of printing or the sequence in which a group of adjustments are to be considered.

MonetaryAdjustmentStartAmount

MonetaryAdjustmentStartAmount is optional. A single instance might exist.

The beginning currency amount used in the calculation of a monetary adjustment.

MonetaryAdjustmentStartQuantity

MonetaryAdjustmentStartQuantity is optional. A single instance might exist.

The beginning quantity used in the calculation of a monetary adjustment.

(choice)

The contents of (choice) are mandatory. A single instance is required.

PriceAdjustment

InvoiceWood

papiNet Standard - Version 2.31

PriceAdjustment is mandatory. A single instance is required.

A group item defining a deviation from the PricePerUnit.

FlatAmountAdjustment

FlatAmountAdjustment is mandatory. A single instance is required.

A group item that contains flat adjustment amount information.

TaxAdjustment

TaxAdjustment is mandatory. A single instance is required.

This content element contains the necessary information to describe, calculate, and handle a tax adjustment.

InformationalAmount

InformationalAmount is optional. A single instance might exist.

A monetary amount used for information purposes only (not for calculation). For example, the invoice price adjustment subtotal is expressed in sterling pounds, and the buyer wants this information expressed in U.S. dollars.

- CreditDebitNote and Invoice - The TaxAmount is displayed in the currency that is applicable throughout the e-Document. When a TaxAmount needs to be displayed in a different national currency, this field is used.

MonetaryAdjustmentReferenceLine

MonetaryAdjustmentReferenceLine is optional. A single instance might exist.

A link to a previously defined MonetaryAdjustmentLine upon which this adjustment is based.

AdditionalText

AdditionalText is optional. Multiple instances might exist.

A text field that is used to communicate information not previously defined or for special instructions. To be used only for circumstances not covered by specific elements.

GeneralLedgerAccount

GeneralLedgerAccount is optional. A single instance might exist.

The general ledger account to be referenced for the item.

MonetaryAdjustmentAmount

MonetaryAdjustmentAmount is optional. A single instance might exist.

The actual amount of the monetary adjustment.

AdjustmentTypeReason

AdjustmentTypeReason is optional. A single instance might exist.

Provides additional information about the type of adjustment. Can be viewed as a sub-classification of the adjustment type attribute or as a textual explanation.

InvoiceWood papiNet Standard - Version 2.31

InvoiceWoodSummary

Summary information that applies to all items on a Wood Market Segment Invoice.

(sequence)

The sequence of items below is mandatory. A single instance is required.

TotalNumberOfLineItems

TotalNumberOfLineItems is mandatory. A single instance is required.

The total number of individual line items in the document, regardless of the status or type.

(sequence)

The sequence of items below is mandatory. One instance is required, multiple instances might exist.

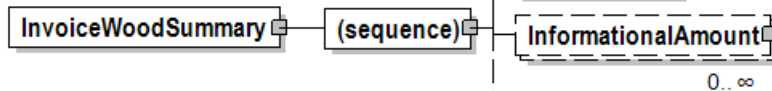

TotalQuantity

TotalQuantity is mandatory. A single instance is required.

The total quantity of similar items in the e-Document. TotalQuantity is primarily used in the summary section of documents where it is repeatable to permit totaling for different units of measure.

TotalInformationalQuantity

TotalInformationalQuantity is optional. Multiple instances might exist.

A quantity that is used to communicate related information about the parent element. This element represents a total that is derived from individual line items.

LineItemSubTotal

LineItemSubTotal is optional. A single instance might exist.

The total amount of all e-Document LineBaseAmount(s) line items without any monetary adjustments that may occur after the e-Document line items.

TotalAdjustments

TotalAdjustments is optional. A single instance might exist.

The CurrencyValue of TotalAdjustments contains the total of all

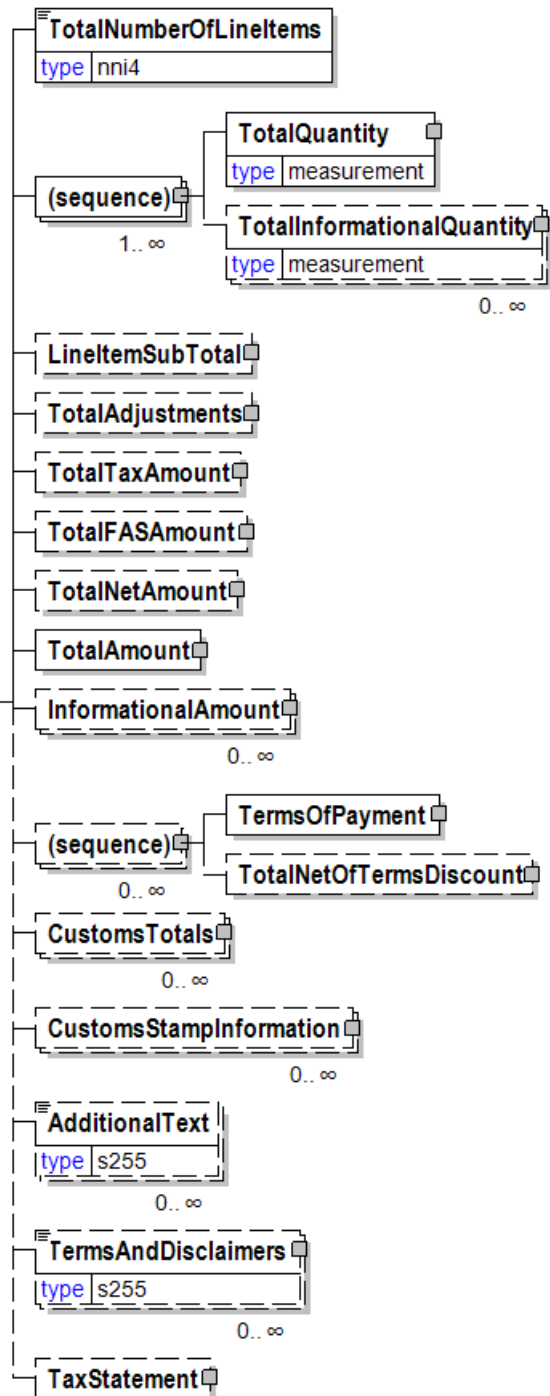

InvoiceWood

papiNet Standard - Version 2.31

MonetaryAdjustmentAmount for all instances of PriceAdjustment and FlatAmountAdjustment in the document (it excludes TaxAdjustments).

TotalTaxAmount

TotalTaxAmount is optional. A single instance might exist.

The CurrencyValue of TotalTaxAmount contains the sum of all instances of TaxAdjustment in the document. TotalTaxAmount contains the sum of all instances of the MonetaryAdjustmentAmount for tax adjustments.

TotalFASAmount

TotalFASAmount is optional. A single instance might exist.

TotalFASAmount is the total Free Alongside Ship value.

TotalNetAmount

TotalNetAmount is optional. A single instance might exist.

A field containing total amount excluding tax. For example, in the Invoice TotalNetAmount is equal to the sum of LineItemSubTotal plus TotalAdjustments. TotalNetAmount encapsulates CurrencyValue.

TotalAmount

TotalAmount is mandatory. A single instance is required.

The total amount including tax.

In e-Documents claiming payment this is the amount due for payment based on the terms of payment. Decimal rounding might be applied to this amount.

InformationalAmount

InformationalAmount is optional. Multiple instances might exist.

A monetary amount used for information purposes only (not for calculation). For example, the invoice price adjustment subtotal is expressed in sterling pounds, and the buyer wants this information expressed in U.S. dollars.

- CreditDebitNote and Invoice - The TaxAmount is displayed in the currency that is applicable throughout the e-Document. When a TaxAmount needs to be displayed in a different national currency, this field is used.

(sequence)

The sequence of items below is optional. Multiple instances might exist.

TermsOfPayment

TermsOfPayment is mandatory. A single instance is required.

A group item that contains agreed-to terms defining when, how, and under what conditions the payment is to be made.

When TermsOfPayment is optional; if omitted, TermsOfPayment is controlled through previous negotiation.

TotalNetOfTermsDiscount

TotalNetOfTermsDiscount is optional. A single instance might exist.

The components of the amount to be paid if prompt payment discount terms are met, including the amount that is subject to the payment terms discount, the discount amount, and the amount due after prompt payment discount.

CustomsTotals

CustomsTotals is optional. Multiple instances might exist.

A grouping element for customs total information.

InvoiceWood

papiNet Standard - Version 2.31

CustomsStampInformation

CustomsStampInformation is optional. Multiple instances might exist.

A grouping element that organises the information for customs.

AdditionalText

AdditionalText is optional. Multiple instances might exist.

A text field that is used to communicate information not previously defined or for special instructions. To be used only for circumstances not covered by specific elements.

TermsAndDisclaimers

TermsAndDisclaimers is optional. Multiple instances might exist.

An element that contains legal information with an indication of what the Language is.

TaxStatement

TaxStatement is optional. A single instance might exist.

A group element for declaration of exception from normal charges of tax and the reason for tax exemption.

InvoiceWood papiNet Standard - Version 2.31

InvoiceWood Business Scenarios

Invoice Scenario Listing

Scenario A	Regular Invoice sent to Buyer with payment directly to Supplier. The Supplier is also the Seller.
Scenario B	Regular Invoice sent to Buyer with payment to the Supplier's bank account. The Supplier is also the Seller.
Scenario C	Delivery cancelled after Invoice is communicated to the buyer. Alternatively, the Invoice was created in error.
Scenario D	Invoice for a call-off
Scenario E	Self-Billing Invoice

Scenario A

e-Document	InvoiceWood
Type	Invoice
Scenario	Regular Invoice sent to Buyer with payment directly to the Supplier. The Supplier is also the Seller.
Outcome	Invoice is entered into the Buyer's system. Payment is made directly to Supplier, for example, by sending a check.
Initiator	Supplier
Receiver	Buyer
Preconditions	This Use Case assumes the Supplier has previously sent material to the Buyer.
Trigger	Material shipment
Step 1.	<p>Supplier sends a regular Invoice to the Buyer. The Invoice does not contain any statuses. The following information that is included in the Invoice is particular to this Use Case.</p> <ul style="list-style-type: none"> • InvoiceType = "Invoice" • SupplierParty <ul style="list-style-type: none"> • PartyIdentifier = the code itself • RemitToParty <ul style="list-style-type: none"> • Not included in e-Document

InvoiceWood papiNet Standard - Version 2.31

Scenario B

e-Document	InvoiceWood
Type	Invoice
Scenario	Regular Invoice sent to Buyer with payment to the Supplier's bank account. The Supplier is also the Seller
Outcome	Invoice is entered into the Supplier's system. Payment is made to the Supplier's bank account.
Initiator	Supplier
Receiver	Buyer
Preconditions	This Use Case assumes the Supplier has previously sent material to the Buyer.
Trigger	Material shipment
Step 1.	<p>Supplier sends a regular Invoice to the Buyer. The Invoice does not contain any statuses. Additional information sent with e-Document.</p> <ul style="list-style-type: none"> • InvoiceType = "Invoice" • SupplierParty <ul style="list-style-type: none"> • contains normal address information for the supplier. RemitToParty • PartyIdentifierType(1) = "BankIdentificationCode" <ul style="list-style-type: none"> • PartyIdentifier(1) = the code itself • PartyIdentifierType(2) = "PayeeAccountNumber" <ul style="list-style-type: none"> • PartyIdentifier(2) = the code itself

Scenario C

e-Document	InvoiceWood
Type	Invoice
Scenario	Delivery cancelled after Invoice is communicated to buyer. An alternative could be that the Invoice is created in error.
Outcome	Invoice is entered into the Buyer's system and a Credit Note is required to offset it.
Initiator	Supplier
Receiver	Buyer

InvoiceWood papiNet Standard - Version 2.31

Step 1.	Supplier sends an Invoice to the Buyer <ul style="list-style-type: none"> • The exact nature of the Invoice is not relevant
Step 2.	Supplier sends a new Invoice with type of type equal to "CreditNote" to the Buyer.

Scenario D

e-Document	InvoiceWood
Type	Invoice
Scenario	Invoice for a call-off <ul style="list-style-type: none"> • The Purchase Order is referenced in the CallOff. The Supplier is also the Seller.
Outcome	Invoice is entered into the Buyer's system.
Initiator	Supplier
Receiver	Buyer
Preconditions	A CallOff initiated shipment
Trigger	DeliveryMessage
Step 1.	Buyer sends a CallOff to the Supplier.
Step 2.	Supplier responds with a CallOffConfirmation.
Step 3.	Supplier sends the delivery along with a DeliveryMessage.
Step 4.	Supplier sends a regular Invoice to the Buyer. The Invoice does not contain any statuses. Additional information sent with e-Document. <ul style="list-style-type: none"> • InvoiceType = "Invoice" • SupplierParty contains normal address information for the supplier • RemitToParty is supplied if payments will be made to an associated Seller's bank account • PurchaseOrderInformation indicates the purchase order against which the material was shipped. • InvoiceReference contains references to CallOffNumber and CallOffLineItemNumber.

Scenario E

e-Document	InvoiceWood
-------------------	-------------

InvoiceWood papiNet Standard - Version 2.31

Type	SelfBillingStatement
Scenario	When sending a SelfBillingStatement to the supplier of the logistics services.
Outcome	SelfBillingStatement is entered into the logistics supplier's system.
Initiator	Buyer of the logistics services
Receiver	Supplier of the logistics services
Preconditions	A previous agreement between the two parties
Trigger	Services are rendered
XML File	Invoice_ScenarioE.xml <ul style="list-style-type: none"> • Focus on InvoiceLineItem
Step 1.	Buyer of the logistics services sends an Invoice (InvoiceType = "SelfBillingStatement" and InvoiceContextType = "LogisticsService").
Step 2.	Supplier of the logistics services checks to see that the data are correct. The supplier responds with a BusinessAcceptance indicating Accepted or Rejected. If the data are not correct and the SelfBillingStatement is Rejected, then reconciliation will occur outside of the e-transaction process.
Step 3.	Buyer of the logistics services will selfbill.
Step 4.	Additional information sent with SelfBillingStatement could be: <ul style="list-style-type: none"> • ChargeInformation • Reference to CostComponents