



papiNet

Invoice

papiNet Standard - Version 2.31

Documentation

**Global Standard for the Paper and Forest
Products Supply Chain**

Build V2R31_20140408

Date 2014-04-15

Production Release

Invoice

papiNet Standard - Version 2.31

Copyright

Copyright 2000 - 2014 papiNet G.I.E ("papiNet") and International Digital Enterprise Alliance, Inc. ("IDEAlliance") collectively "Copyright Owner". All rights reserved by the Copyright Owner under the laws of the United States, Belgium, the European Economic Community, and all states, domestic and foreign. This document may be downloaded and copied provided that all copies retain and display the copyright and any other proprietary notices contained in this document. This document may not be sold, modified, edited, or taken out of context such that it creates a false or misleading statement or impression as to the purpose or use of the papiNet specification, which is an open standard. Use of this Standard, in accord with the foregoing limited permission, shall not create for the user any rights in or to the copyright, which rights are exclusively reserved to the Copyright Owner.

papiNet, IDEAlliance, and the members of all papiNet Groups (collectively and individually, "Presenters") make no representations or warranties, express or implied, including, but not limited to, warranties of merchantability, fitness for a particular purpose, title, or non-infringement. The presenters do not make any representation or warranty that the contents of this document are free from error, suitable for any purpose of any user, or that implementation of such contents will not infringe any third party patents, copyrights, trademarks or other rights. By making use of this document, the user assumes all risks and waives all claims against Presenters.

In no event shall Presenters be liable to user (or other person) for direct, indirect, special or consequential damages arising from or related to any use of this document, including, without limitation, lost profits, business interruption, loss of programs, or other data on your information handling system even if Presenters are expressly advised of the possibility of such damages.

Use of Documents in papiNet Implementations

Documents may be used as templates for a papiNet implementation. The Presenters grant the right to modify and edit them to fit an actual implementation project provided all copies display the copyright and any other proprietary notices contained in this document. Such modified documents must not be distributed beyond the trading partners implementing or maintaining a papiNet connection.

Invoice

papiNet Standard - Version 2.31

Table of Contents

Copyright	2
Use of Documents in papiNet Implementations	2
Table of Contents	3
Invoice Documentation	4
Invoice e-Document Overview	4
The Scope of Invoice.....	4
InvoiceType [attribute].....	5
Business Rules for Invoice	7
Processing the Invoice.....	8
Understanding the Diagrams and Content	8
Invoice Root Element.....	10
Invoice	10
Primary Elements.....	13
InvoiceHeader	13
InvoiceLineItem	16
MonetaryAdjustment.....	20
InvoiceSummary	26
Invoice Business Scenarios.....	29
Invoice Scenario Listing.....	29
Scenario A.....	29
Scenario B.....	30
Scenario C.....	31
Scenario D	31
Scenario E.....	32
Scenario F	33
Scenario G	33
Scenario H.....	34
Scenario I	34
Scenario J	35
Scenario K.....	35

Invoice

papiNet Standard - Version 2.31

Invoice Documentation

Invoice e-Document Overview

An Invoice e-Document can handle both debits and credits. Typically a seller sends an Invoice to a buyer after delivering the products or services specified in a purchase order or as part of an automatic replenishment agreement. Alternatively, an Invoice can be prepared by the buyer as part of a self-billing process. The Invoice is a list of the goods shipped and their quantities, or services rendered, indicating the price, terms of sale, supplemental charges, allowances, and communicates the payment required for the indicated items.

There are a variety of Invoice types designed to fulfil different payment or documentation requirements. Sellers can use invoices to claim payment for goods supplied (a "regular" invoice), resend an Invoice that the buyer misplaced or never received, request payment in advance of delivery, or provide information (usually to a third party) without claiming payment..

Invoice types of CreditNote and DebitNote are generally used by the Seller to compensate or charge the trading parties (ShipToParty, BuyerParty, OtherParty, etc.) for matters outside the scope of the Invoice. Typically these matters include commercial claims, logistics claims, technical claims, invoice corrections, commissions, and rebates.

The Invoice has been checked and found compliant with the EU Council Directive 2001/115/EC in force from 1 January 2004 in existing EU Member States and from 1 May 2004 in the Accession Countries. Directive 2001/115/EC harmonises, simplifies and modernises invoicing obligations on traders when they sell products or services that are subject to Value Added Tax (VAT). It also creates an EU legal framework for electronic transmission and storage of invoices. Refer to http://www.eic.ie/legislation/vat_invoicing.htm for additional information.

The Scope of Invoice

The Invoice can include:

- Details drawn from the purchase order, delivery message, and/or usage reporting
- Seller's general operating procedures, bank account information, and payment terms
- Specific contractual and legal information
- Details, such as general ledger distribution information, provided as a service to the buyer
- Taxes
- Information to support custom requirements, though there may be custom duty requirements that are not supported by the Invoice
- Any charges associated with the products or services provided
- Any compensation or charge associated with credits or debits for services, claims, or corrections
- The reason for a debit or credit
- An Invoice assumes that a previous agreement between buyer and

Invoice

papiNet Standard - Version 2.31

seller has taken place.

Each implementation must check and confirm that legal requirements are met for your specific environment. The papiNet Invoice is designed to support the information required to achieve legal status by a governmental authority.

InvoiceType [attribute]

Defines the various types of invoices. The Invoice has been checked and found compliant with the EU Council Directive 2001/115/EC in force from 1 January 2004 in existing EU Member States and from 1 May 2004 in the Accession Countries. Directive 2001/115/EC harmonises, simplifies and modernises invoicing obligations on traders when they sell products or services that are subject to Value Added Tax (VAT). It also creates an EU legal framework for electronic transmission and storage of invoices. Use http://www.eic.ie/legislation/vat_invoicing.htm for additional information.



Types of invoices not covered in this standard include:

- Delcredere – An invoice sent to the party paying for a number of buyers
- Factored – An invoice assigned to a third party for collection

This item is restricted to the following list.

Approximate

An Invoice that is created to record ownership transfer without the material physically being moved. Typically what occurs is that the buyer has agreed to take ownership of the item at a certain point in time but has not arranged for transportation. Approximate invoices are invoices that are claiming payment.

CreditNote

Credits that are provided for amount reductions and complaints. A CreditNote will normally have a reference to an earlier issued Invoice.

DebitNote

A DebitNote claims payment for additional charges. A DebitNote normally has a reference to an earlier issued Invoice.

Duplicate

To be removed in a future version. When an Invoice is reissued as a duplicate the invoice type should be the same as on the original Invoice. Use attribute Reissued = Yes to indicate a duplicate.

Invoice

A regular Invoice (referred to as an Invoice) claims payment for products, services, and charges supplied under conditions agreed to between seller and buyer. The Invoice communicates, among other things, payment terms, payment method, and the payment amount required for one or more deliveries.

PrePayment

Invoice

papiNet Standard - Version 2.31

A prepayment Invoice is used as a notification of amounts to be paid in advance. It is not a legal Invoice claiming payment for provided products or services.

ProForma

A pro-forma Invoice is not a legal invoice claiming payment. A pro-forma Invoice is an e-Document serving as a preliminary Invoice, containing on the whole the same information as the final Invoice, but not actually claiming payment. Pro-forma invoices are typically used in a cross-border shipment for customs purposes. Can travel with the product or be sent to a broker.

SelfBillingStatement

A SelfBillingStatement is an Invoice that is prepared by the buyer of the product (or the consumer of the service) for the provider of the product or service. The preparer will pay the Invoice.

Typically logistics costs charges are the services that are communicated. They are incurred during a certain period of time between the party who provides the logistics services (typically the party with a LogisticsRole of "LogisticsProvider") and the requestor of such services (typically the party with a LogisticsRole of "Consignor").

Raw materials, maintenance, repair, and operating supplies are examples of products that can be entered on a self billing statement for products. This type of Invoice is also referred to as an Invoice for "evaluated receipts" because it developed from the receiving department's evaluation of their receipts and from that creating the Invoice.

The SelfBillingStatement process exists when there is a great deal of trust between the trading partners that permits this cost savings business process.

Invoice

papiNet Standard - Version 2.31

Business Rules for Invoice

General Business Rules

The following table lists the business rules that apply to all Invoice types.

Identifier	Business Rule
ICD001	Invoice corrections are handled by indicating an InvoiceType attribute of CreditNote or DebitNote.
ICD002	Invoice cancellation is handled by issuing a CreditNote for invoiced debits or a DebitNote for invoiced credits.
ICD003	At least one instance of the Product, ChargeInformation or, ChargeAllowance elements is required.
ICD004	Adjustments that apply to all Invoice lines, the entire Invoice, are handled by using the MonetaryAdjustment at the Invoice root level.
ICD005	LocationParty(s) at the LineItem level override the ones at the header.
ICD006	Corrections or cancellations for the non-claiming-payment invoices (ProForma and PrePayment) are handled by issuing a new Invoice e-business document.
ICD007	TermsOfPayment is mandatory for Invoice types that are claiming payment. When there are multiple mandatory payment terms for the goods being invoiced, then multiple invoices should be generated.
ICD008	The LocationParty types permitted in a SelfBillingStatement, at header and line level, are "PlaceOfLoading" and "PlaceOfFinalDestination"
ICD009	InvoiceTypes of CreditNote and DebitNote must contain a reason for the transaction.
ICD010	Invoiced amounts are positive for all Invoice types, that is, credited amounts in CreditNote and debit amounts in all other invoices. Adjustment values should always be given as negative or positive adjustments even if the AdjustmentType infers the sign. (For example, a rebate of 1% should be given as an adjustment percentage of -1)
ICD011	TotalTermsDiscountTaxAmount in TotalNetOfTermsDiscount is mandatory when tax is specified for prompt payment discount.

Invoice

papiNet Standard - Version 2.31

Processing the Invoice

For the Invoice, all e-Document types are processed in the same way.

The Invoice has an attributed, Reissued, with two values that are used when processing the Invoice.

- No - Indicates that this is the first, the original generation of the Invoice.
- Yes - Indicates that this is a copy of the Invoice. It can be sent by the issuing party based upon a request from the originally intended receiver of the Invoice. If the original Invoice is located after the issuing party sends a copy, the receiver can decide whether to process the original Invoice or the copy. In addition it indicates that the Invoice was sent previously.

When the InvoiceType is "SelfBillingStatement", the sender is providing the receiver (typically the supplier but possibly a logistics provider) a statement of the products or services that have been provided to the sender (typically the buyer) during an agreed period of time. Any reconciliation process between the two business partners will be handled outside the e-transaction environment. Confirmation of the SelfBillingStatement is achieved by means of the papiNet BusinessAcceptance.

Status Values Used When Processing the Invoice e-Document

- No special status values are used to communicate acceptance of the Invoice e-Document. Use the papiNet BusinessAcceptance and BusinessAcknowledgement to confirm Invoice receipt.
- No amendment of the Invoice is permitted. All Invoice changes are currently completed through the Invoice types CreditNote and DebitNote.
- The seller is responsible for ensuring that the combination of InvoiceNumber and InvoiceLineNumber are unique and refer to the same BuyerParty throughout the life of the Invoice. The buyer may reject an Invoice that includes a previously received combination of InvoiceNumber and InvoiceLineNumber. The buyer communicates that rejection to the seller via an agreed-to process. If no process is specified, the buyer uses phone or email.

Understanding the Diagrams and Content

This section provides a graphical view of the schema structures, a discussion of the item's children. You can find additional information about papiNet and the standard at www.papiNet.org.

The graphics contain content model indicators, cardinality indicators, and data type information.

Associated with each graphic are the definitions for the parent item and any associated child items. All attributes are listed first, followed by the elements.

The following information should help you interpret and understand this standard. Please note the following:

- Content Model and Cardinality operate together to determine if the

Invoice

papiNet Standard - Version 2.31

element or attribute are required in the instance document.

- The same attribute can never appear multiple times in the same element so, you will never see a multiple cardinality indicator.

Content model indicators:

There are three possible types of content: "sequence", "choice", and "all". The papiNet standard currently does not use the "all" construct.

- (sequence)

The sequence of the items to the right of the graphic (or below the text) is required.

- (choice)

A choice of the items to the right of the graphic (or below the text) is permitted.

- (all)

All the items to the right of the graphic are required.

Cardinality indicators:

- Dotted line around element or attribute.

A single instance of the item can optionally exist.

- Dotted line around item with range indicated below.

Multiple instances of the item can optionally exist.

- Solid line around item.

A single instance of the item must exist.

- Solid line around item with range indicated below

At least one instance must exist; multiple instances can optionally exist.

Datatype indication:

When a data type is assigned to an element (either a simple type or complex type the name of the data type is presented beneath the item name in the graphic.

- In some cases additional information about the data type is presented (the default value).

Elements can either have content that is textual/numeric in nature or content that is made up of additional elements and/or attributes.

- When the content is textual/numeric in nature "three straight horizontal lines" will appear in the upper left-hand corner of the graphic. Pay attention to these elements because they are where you will be entering your information.
- When the content is made up of additional elements and/or attributes a "gray-box" will appear on the right-hand side of the graphic.
- If the graphic shows both the horizontal lines and the gray-box then, in the papiNet standard, the content below the element are attributes.

Invoice

papiNet Standard - Version 2.31

Invoice Root Element

Invoice

The Invoice element is the root element for the Invoice e-Document.

An Invoice e-Document can handle both debits and credits. Typically a seller sends an Invoice to a buyer after delivering the products or services specified in a purchase order or as part of an automatic replenishment agreement.

Alternatively, an Invoice can be prepared by the buyer as part of a self-billing process. The Invoice is a list of the goods shipped and their quantities, or services rendered, indicating the price, terms of sale, supplemental charges, allowances, and communicates the payment required for the indicated items.

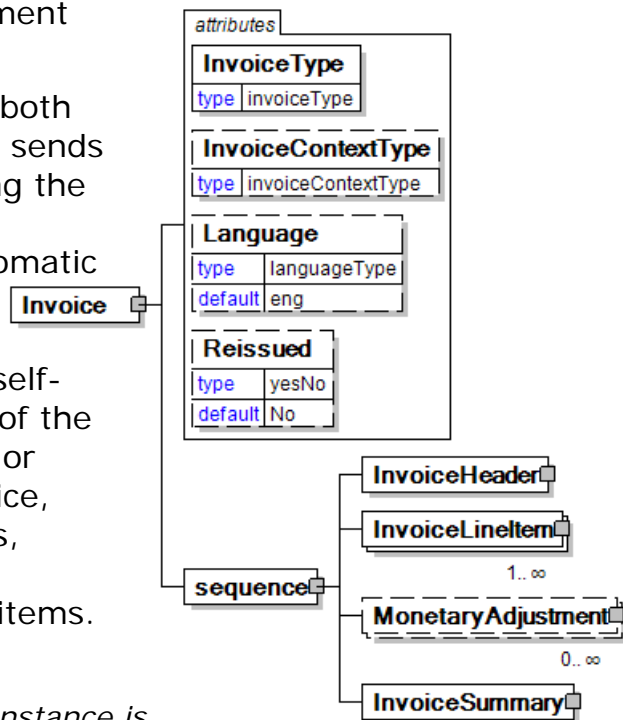

InvoiceType [attribute]

InvoiceType is mandatory. A single instance is required.

Defines the various types of invoices. The Invoice has been checked and found compliant with the EU Council Directive 2001/115/EC in force from 1 January 2004 in existing EU Member States and from 1 May 2004 in the Accession Countries. Directive 2001/115/EC harmonises, simplifies and modernises invoicing obligations on traders when they sell products or services that are subject to Value Added Tax (VAT). It also creates an EU legal framework for electronic transmission and storage of invoices. Use http://www.eic.ie/legislation/vat_invoicing.htm for additional information.

Types of invoices not covered in this standard include:

- Delcredere – An invoice sent to the party paying for a number of buyers
- Factored – An invoice assigned to a third party for collection

This item is restricted to the following list.

Approximate

An Invoice that is created to record ownership transfer without the material physically being moved. Typically what occurs is that the buyer has agreed to take ownership of the item at a certain point in time but has not arranged for transportation. Approximate invoices are invoices that are claiming payment.

CreditNote

Credits that are provided for amount reductions and complaints. A CreditNote will normally have a reference to an earlier issued Invoice.

DebitNote

A DebitNote claims payment for additional charges. A DebitNote normally has a reference to an earlier issued Invoice.

Duplicate

Invoice

papiNet Standard - Version 2.31

To be removed in a future version. When an Invoice is reissued as a duplicate the Invoice type should be the same as on the original Invoice. Use attribute Reissued = Yes to indicate a duplicate.

Invoice

A regular Invoice (referred to as an Invoice) claiming payment for products, services and charges supplied under conditions agreed to between seller and buyer. The Invoice communicates, among other things, payment terms, payment method, and the payment amount required for one or more deliveries.

PrePayment

A prepayment Invoice is used as a notification of amounts to be paid in advance. It is not a legal Invoice claiming payment for provided products or services.

ProForma

A pro-forma Invoice is not a legal Invoice claiming payment. A pro-forma Invoice is an e-Document serving as a preliminary Invoice, containing on the whole the same information as the final Invoice, but not actually claiming payment. Pro-forma invoices are typically used in a cross-border shipment for customs purposes. Can travel with the product or be sent to a broker.

SelfBillingStatement

A SelfBillingStatement is an Invoice that is prepared by the buyer of the product (or the consumer of the service) for the provider of the product or service. The preparer will pay the Invoice.

Typically logistics costs charges are the service that are communicated. They are incurred during a certain period of time between the party who provides the logistics services (typically the party with a LogisticsRole of "LogisticsProvider") and the requestor of such services (typically the party with a LogisticsRole of "Consignor").

Raw materials, maintenance, repair, and operating supplies are examples of products that can be entered on a self billing statement for products. This type of Invoice is also referred to as an Invoice for "evaluated receipts" because it developed from the receiving department's evaluation of their receipts and from that creating the Invoice.

The SelfBillingStatement process exists when there is a great deal of trust between the trading partners that permits this cost savings business process.

InvoiceContextType [attribute]

InvoiceContextType is optional. A single instance might exist.

Indicates the nature of what is included in the Invoice.

This item is restricted to the following list.

LogisticsService

The Invoice is exclusively for logistics services.

Product

The Invoice includes product with optional logistics charges.

Language [attribute]

Language is optional. A single instance might exist.

XML has embraced 2 and 3 digit language codes through the application of an addendum to the standard.

Information on the content of this attribute is available at

Invoice

papiNet Standard - Version 2.31

<http://www.loc.gov/standards/iso639-2/> this is the official site of the ISO 639-2 Registration Authority.

- <http://www.w3.org/International/O-HTML-tags.html> provides an explanation of the errata updating XML.
- <http://www.ietf.org/rfc/rfc3066.txt> is the key document that is referenced in the above errata.

Reissued [attribute]

Reissued is optional. A single instance might exist.

Either "Yes" or "No".

This item is restricted to the following list.

Yes

No

(sequence)

The contents of (sequence) are mandatory. A single instance is required.

InvoiceHeader

InvoiceHeader is mandatory. A single instance is required.

Information that applies to all items on the Invoice.

InvoiceLineItem

InvoiceLineItem is mandatory. One instance is required, multiple instances might exist.

Information for each item on an Invoice.

- Note Business Rule INV008: At least one instance of either the Product, ChargeInformation or ChargeOrAllowance elements is required.

MonetaryAdjustment

MonetaryAdjustment is optional. Multiple instances might exist.

The element containing the information necessary for the understanding, calculation, and treatment of an adjustment to a currency amount.

MonetaryAdjustment contains an attribute that indicates they type of adjustment being communicated.

InvoiceSummary

InvoiceSummary is mandatory. A single instance is required.

Summary information for all items on an Invoice.

Invoice

papiNet Standard - Version 2.31

Primary Elements

InvoiceHeader

Information that applies to all items on the Invoice.

(sequence)

The sequence of items below is mandatory. A single instance is required.

InvoiceNumber

InvoiceNumber is mandatory. A single instance is required.

The identification number of the invoice, generated by the seller.

InvoiceDate

InvoiceDate is mandatory. A single instance is required.

A date that is qualifying the invoicing period. This date often drives payment terms. Note that this date is not necessarily the same as the issue date of the invoice.

OtherDate

OtherDate is optional. Multiple instances might exist.

A date that may not be specifically detailed within a document (example: print date at the PurchaseOrderLineItem).

InvoiceReference

InvoiceReference is optional. Multiple instances might exist.

A group item detailing relevant references pertaining to the invoice e-Document. InvoiceReferenceType describes the content.

DocumentReferenceInformation

DocumentReferenceInformation is optional. Multiple instances might exist.

A group item containing reference information applicable to a document.

BillToParty

BillToParty is mandatory. A single instance is required.

The address where the invoice is to be sent.

SupplierParty

SupplierParty is mandatory. A single instance is required.

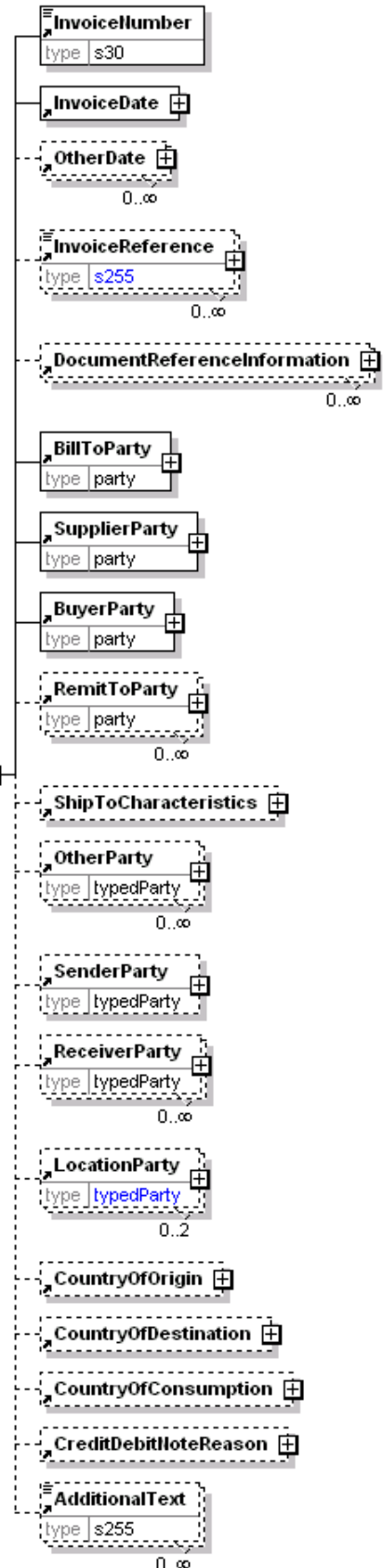

Invoice

papiNet Standard - Version 2.31

The organisation or business entity responsible for providing the product. SupplierParty is also the seller of the product, if Seller is not specified as OtherParty = Seller.

BuyerParty

BuyerParty is mandatory. A single instance is required.

The legal entity to which the product is sold. Also commonly referred to as the sold-to party or customer. If no OtherParty is defined as the Payer, the Buyer is the Payer.

RemitToParty

RemitToParty is optional. Multiple instances might exist.

A group item containing details of the party to whom payment will be made. The RemitToParty contains all information related to remittance.

ShipToCharacteristics

ShipToCharacteristics is optional. A single instance might exist.

A group item that provides information important for the Ship-To Party.

A group item that provides information important for the Ship-To Party. ShipToCharacteristics may be referenced at both the header and line item level. The reference at the header is required and acts as a default for the value at the line level, unless overridden at the line level.

OtherParty

OtherParty is optional. Multiple instances might exist.

An organisation or business entity other than those specifically detailed within a e-Document.

SenderParty

SenderParty is optional. A single instance might exist.

The business entity issuing the e-Document, the source of the document.

- The entity responsible for the content. If the sender party has out sourced the message service to a third party the SenderParty is the issuer of the e-Document and not the party performing the transmission service of the electronic message.

ReceiverParty

ReceiverParty is optional. Multiple instances might exist.

The business entity for whom the e-Document is intended, the destination of the document.

- The entity interested in the content. If the receiver party has outsourced the message service to a third party the ReceiverParty is the intended party for the e-Document and not the party performing the receiving service of the electronic message.

LocationParty

LocationParty is optional.

The organization or business entity where the business event took place or will take place.

CountryOfOrigin

CountryOfOrigin is optional. A single instance might exist.

The country of origin for the material.

Invoice

papiNet Standard - Version 2.31

CountryOfDestination

CountryOfDestination is optional. A single instance might exist.

The country where the goods will be, or were, shipped to.

CountryOfConsumption

CountryOfConsumption is optional. A single instance might exist.

The country of consumption for the material.

CreditDebitNoteReason

CreditDebitNoteReason is optional. A single instance might exist.

A group item containing the reason for the entire CreditDebitNote.

AdditionalText

AdditionalText is optional. Multiple instances might exist.

A text field that is used to communicate information not previously defined or for special instructions. To be used only for circumstances not covered by specific elements.

Invoice

papiNet Standard - Version 2.31

InvoiceLineItem

Information for each item on an Invoice.

IsFinalInvoice [attribute]

IsFinalInvoice is optional. A single instance might exist.

Communicates to the receiver that this is the last Invoice so that the customer can “close out” the associated PO as completely invoiced.

This item is restricted to the following list.

Yes

No

(sequence)

The sequence of items below is mandatory. A single instance is required.

InvoiceLineNumber

InvoiceLineNumber is mandatory. A single instance is required.

The sequential number that uniquely identifies the Invoice line item. It may enable the Invoice to be printed, viewed, or discussed in a common order.

PurchaseOrderInformation

PurchaseOrderInformation is optional. A single instance might exist.

A group item containing information unique to this purchase order, which is provided by the buyer. PurchaseOrderInformation can be optional in the supply chain. Invoices are created without having a Purchase Order in Vendor Managed Inventory. Freight invoices also will not have a Purchase Order number.

PurchaseOrderLineItemNumber

PurchaseOrderLineItemNumber is optional. A single instance might exist.

The sequential number that uniquely identifies the purchase order line item.

ChargeOrAllowance

ChargeOrAllowance is optional. A single instance might exist.

The description of the charge or allowance; such as freight, special handling, and stop-off handling.

Product

Product is optional. A single instance might exist.

Product is a group item defining the article and its characteristics. Product is used to specify product characteristics organized by ProductIdentifier,

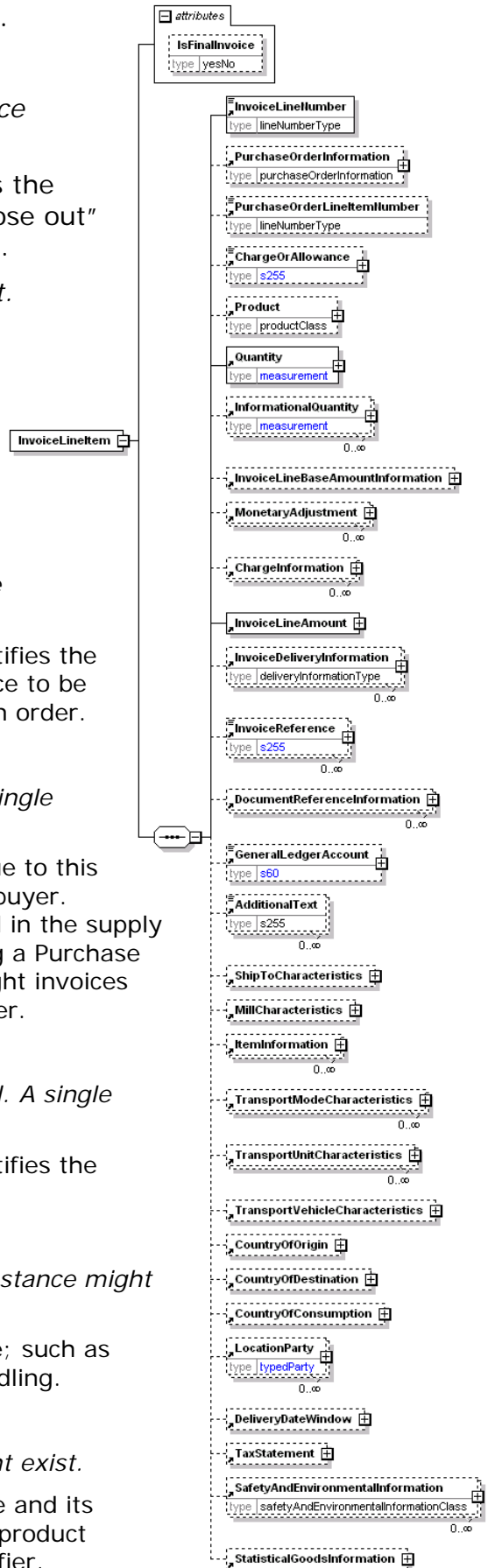

Invoice

papiNet Standard - Version 2.31

ProductDescription, and Classification. Book Manufacturing, Label Stock, Paper, Pulp, Recovered Paper, Wood Products, and Virgin Fibre market segments have defined their product characteristics and conversion features for implementation in papiNet.

Quantity

Quantity is mandatory. A single instance is required.

The Quantity element contains attributes that provide information about the type of quantity that is being communicated, the context in which the particular quantity is to be viewed, and (if the quantity represents an adjustment) an adjustment type.

The Quantity element contains three child elements that enable you to communicate a range of values for the quantity and a target or actual value. It is at this level (Value, RangeMin, and RangeMax) that the unit of measure is specified. This permits the range to be specified in a different unit of measure than the target.

InformationalQuantity

InformationalQuantity is optional. Multiple instances might exist.

A quantity given in a valid UOM used for information purposes only (not for calculation). For example, an ordered quantity was 100 reels as opposed to the invoice quantity of 20,000 pounds.

InvoiceLineBaseAmountInformation

InvoiceLineBaseAmountInformation is optional. A single instance might exist.

A group item containing the price per unit and the invoice price amount subtotal.

MonetaryAdjustment

MonetaryAdjustment is optional. Multiple instances might exist.

The element containing the information necessary for the understanding, calculation, and treatment of an adjustment to a currency amount. MonetaryAdjustment contains an attribute that indicates they type of adjustment being communicated.

ChargeInformation

ChargeInformation is optional. Multiple instances might exist.

A group element that contains elements that describe a charge. ChargeInformation is used when charge details need to be specified by using a code assigned by an agency. It is typically used for freight costs and other costs related to the supply chain.

InvoiceLineAmount

InvoiceLineAmount is mandatory. A single instance is required.

The total invoice amount per line including adjustments, charges and tax (when tax is specified on the invoice line item).

InvoiceLineAmount is equal to the InvoiceLineBaseAmount plus the sum of the signed values of the MonetaryAdjustmentAmount for all instances of MonetaryAdjustment and plus the sum of the signed values of the ChargeAmount for all instances of ChargeInformation.

InvoiceDeliveryInformation

InvoiceDeliveryInformation is optional. Multiple instances might exist.

A group item that contains delivery information for invoice purposes. The delivery information that is contained will be similar to that on the DeliveryMessage.

Invoice

papiNet Standard - Version 2.31

InvoiceReference

InvoiceReference is optional. Multiple instances might exist.

A group item detailing relevant references pertaining to the Invoice e-Document. InvoiceReferenceType describes the content.

DocumentReferenceInformation

DocumentReferenceInformation is optional. Multiple instances might exist.

A group item containing reference information applicable to a document.

GeneralLedgerAccount

GeneralLedgerAccount is optional. A single instance might exist.

The general ledger account to be referenced for the item.

AdditionalText

AdditionalText is optional. Multiple instances might exist.

A text field that is used to communicate information not previously defined or for special instructions. To be used only for circumstances not covered by specific elements.

ShipToCharacteristics

ShipToCharacteristics is optional. A single instance might exist.

A group item that provides information important for the Ship-To Party.

A group item that provides information important for the Ship-To Party. ShipToCharacteristics may be referenced at both the header and line item level. The reference at the header is required and acts as a default for the value at the line level, unless overridden at the line level.

MillCharacteristics

MillCharacteristics is optional. A single instance might exist.

A group item defining the mill party and machine identifier where a product is or was produced.

ItemInformation

ItemInformation is optional. Multiple instances might exist.

The purpose of the ItemInformation structure is to clearly identify physical items. The attribute ItemType defines the type of physical item. Physical items can be handling units like packages as well as items contained in packages.

TransportModeCharacteristics

TransportModeCharacteristics is optional. Multiple instances might exist.

A group item defining the primary mode of transport.

TransportUnitCharacteristics

TransportUnitCharacteristics is optional. Multiple instances might exist.

A group item defining and identifying the primary means of containing the goods. In some instances, the transport unit and vehicle are the same.

TransportVehicleCharacteristics

TransportVehicleCharacteristics is optional. A single instance might exist.

A group item defining the primary means of transporting the goods, such as a side port vessel. In some instances, the transport unit and vehicle are the same.

Invoice

papiNet Standard - Version 2.31

CountryOfOrigin

CountryOfOrigin is optional. A single instance might exist.

The country of origin for the material.

CountryOfDestination

CountryOfDestination is optional. A single instance might exist.

The country where the goods will be, or were, shipped to.

CountryOfConsumption

CountryOfConsumption is optional. A single instance might exist.

The country of consumption for the material.

LocationParty

LocationParty is optional. Multiple instances might exist.

The organization or business entity where the business event took place or will take place.

DeliveryDateWindow

DeliveryDateWindow is optional. A single instance might exist.

A group item defining the date/time interval for delivery to take place. An element which may contain the estimated date for which delivery is expected. This date is not absolute.

TaxStatement

TaxStatement is optional. A single instance might exist.

A group element for declaration of exception from normal charges of tax and the reason for tax exemption.

SafetyAndEnvironmentalInformation

SafetyAndEnvironmentalInformation is optional. Multiple instances might exist.

Name of certification type, if any, on the goods (For example, FSC, PEFC). SafetyAndEnvironmental needs a value or measurement to communicate the percentage of the product is certified (for example, 75% is certified by the indicated agency).

StatisticalGoodsInformation

StatisticalGoodsInformation is optional. A single instance might exist.

A group item containing statistical information about handled or traded goods.

Invoice

papiNet Standard - Version 2.31

MonetaryAdjustment

The element containing the information necessary for the understanding, calculation, and treatment of an adjustment to a currency amount. MonetaryAdjustment contains an attribute that indicates they type of adjustment being communicated.

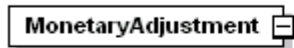

AdjustmentType [attribute]

AdjustmentType is mandatory. A single instance is required.

Describes the type of adjustment applied to a monetary oriented element. Adjustment values should always be given as negative or positive adjustments even if AdjustmentType indicates the sign. For example, a rebate of 1% on an invoice should be given as an adjustment percentage of -1%.

This item is restricted to the following list.

BillOfLadingCharge

An extra charge for creating a Bill of Lading.

CancellationCharge

A charge applied because a cancellation was late (after the last date of change) and all or part of the ordered product has already been made.

CashDiscount

A reduction due to a discount applied.

CertificateCharge

An extra charge for creating a certificate. Some countries requires Certificates in which different characteristics of the delivery, transport unit, route, product, and others must be proved.

There are certificates for gasen pallets, for the place of production, for the age of the ship/vessel, for not departing from one country's harbour when delivering to another.

ChargesForward

A pending invoice amount brought forward from a previous Invoice.

ClaimAdjustment

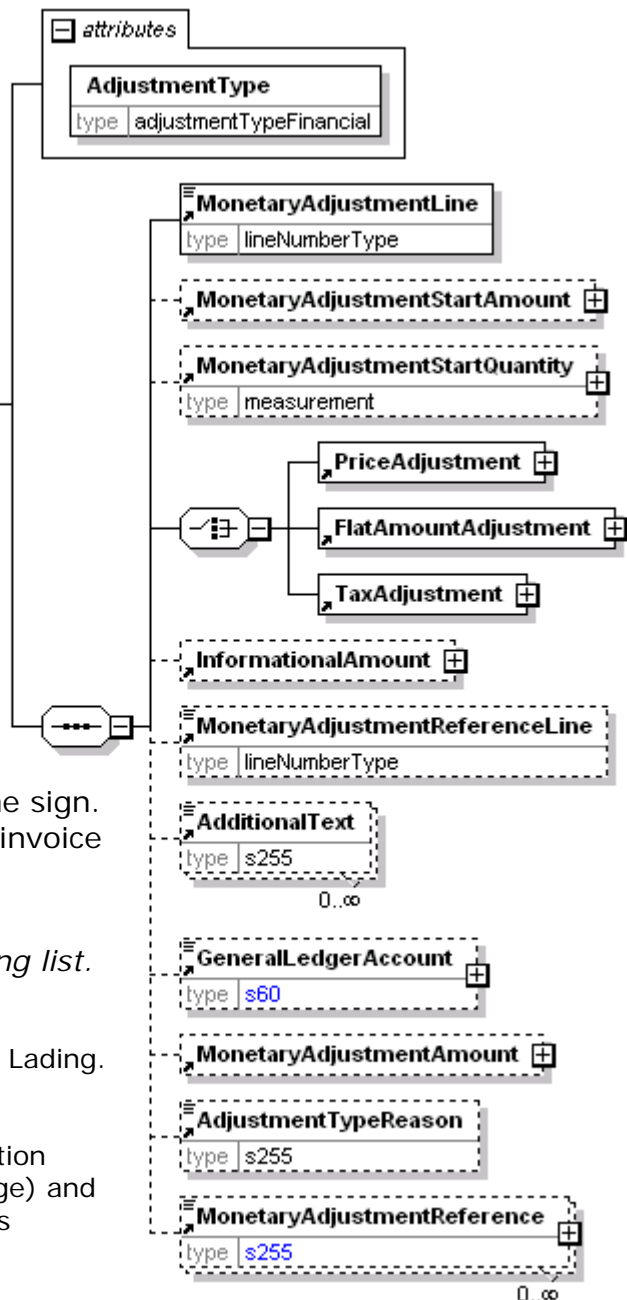

Invoice

papiNet Standard - Version 2.31

An adjustment related to a filed complaint.

Commission

Commission costs paid to the trading agency or trader.

CompetitiveAllowance

An allowance provided for competitive reasons.

CongestionCharge

An extra fee from ports for waiting time of ships in ports, railcars on a siding, trucks at a dock. (Synonym: Demurrage.)

ConsigneeUnloadCharge

An unloading charge that is the responsibility of the consignee.

ContractAllowance

An allowance for a volume discount, usually because the agreed amount has been exceeded.

CurrencyAdjustmentCharge

An extra fee to adjust for currency variations.

DecimalRounding

Adjustments for rounding of amounts to fit the business agreement or national monetary legislation. This adjustment is typically used for decimal rounding of amounts not including tax.

N.B. Use InformationalAmount with AmountType "DecimalRounding" for specification of decimal rounding of amounts including tax.

DefectiveAllowance

An allowance provided for defective material.

DeliveryCharge

The charge for delivering the product.

DeliveryNonConformanceAllowance

An allowance due to non-conformance with the purchase agreement regarding a delivery.

DeliveryTimeBonus

A bonus given for deliveries of products within a certain time period.

EarlyShipAllowance

An allowance due to a delivery that took place earlier than planned. The seller may be charged a penalty. If this is found before issuing the Invoice, it can be handled through this allowance. If found later, it will be handled through a credit note.

EnergySurcharge

A charge related to increases in the cost of energy.

Environmental

An allowance applied due to environmental regulations.

ExpeditedShipmentCharge

An extra cost charged due to unexpected or emergency requirements (for example, breaking off a run in the mill to reach the production date for a rush order).

Invoice

papiNet Standard - Version 2.31

ExportClearanceCharge

An extra fee for customs administration.

FlatRateCharge

A general flat charge.

FreightAllowance

The freight cost allowed by the mill. This amount is negative, and will be deducted from the Invoice (U.S. business practice, in the European Union (EU), use only Freight Charge).

FreightCharge

The actual cost incurred to deliver the product. This amount is positive, and will be added to the Invoice.

FuelAdjustmentCharge

An extra fee, usually from shipping companies, to adjust fuel prices.

HandlingCharge

A charge related to the handling of the product.

Inspection

The cost associated with performing an inspection of the product.

InterestCharge

A charge applied for interest on overdue payments.

LabourAllowance

An allowance due to additional labour required in the use or acceptance of the product.

LabourCharge

A charge due to additional labour required in the use or acceptance of the product.

LoggingDamage

An adjustment caused by logging damages on Forest Wood products. Logging damages normally cause a reduction of the product price.

LotCharge

A charge applied to the lot of material.

MetalDetection

A charge for additional metal detection applied to the goods.

ModelHomeDiscount

A discount associated with the building of the model home.

NewStoreCouponDiscount

A discount associated with entry into a new store.

OrderQuantity

A charge or allowance for small/big ordered quantities.

PalletCharge

A charge that represents the cost or rental of the pallet.

PickUpAllowance

Invoice

papiNet Standard - Version 2.31

An allowance provided to compensate for the cost of picking up the product.

PromotionalAllowance

An allowance provided for the promotion of the product.

PromotionalCharge

A charge associated with the promotion of the product.

PriceCorrection

An adjustment associated with a correction of the product's price.

ProductionSetUpCharge

A special charge applied due to specific buyer requests.

Provision

The act of making ready or equipping for use.

Rebate

A rebate accepted by the buyer and seller based on the agreed price and volume.

ReelDiscount

An allowance for purchasing reels instead of sheets.

ReturnedLoadAllowance

An allowance applied due to the return of the load.

ReturnLoadCharge

A charge applied due to the return of the load.

RoadFeeCharge

A freight charge for a special tax applied to road transports in some countries, e.g. Germany

ScrapAndDunnageCharge

A charge that represents the scrapping of the material and its removal.

ServiceCharge

A charge associated with a miscellaneous service.

SpecialConversionCharge

Additional charge for a special conversion of the product.

SpecialDeliveryCharge

A special charge for delivering the product differently from the usual or agreed-to method.

SpecialHandlingCharge

A special charge for handling the product differently from the usual or agreed-to method.

SpecialPackagingCharge

A special charge for packaging the product differently from the usual or agreed-to method, or if packaging as requested is out of spec.

StopOffAllowance

An allowance for a delivery stop-off.

StopOffCharge

Invoice

papiNet Standard - Version 2.31

A charge for a delivery stop-off.

StorageAllowance

An allowance for storing the product.

StorageCharge

An extra cost charged for storing the product on location (in the plant).

Tax

An adjustment that reflects a tax item.

TestingCharge

A charge related to testing a paper grade.

TradeDiscount

A discount based on the terms of the trade given on the agreed price. Usually a percentage.

TrialDiscount

A discount applied for a trial run of a new or improved product.

TransferCharge

A freight charge incurred by the goods transfer from one location to another location not previously agreed upon.

UnloadingAllowance

An allowance to compensate for the unloading the product.

UnloadingCharge

A charge for the unloading the product.

VolumeDiscount

A rebate accepted by the buyer and the seller based on the agreed volume

WarRiskCharge

An extra fee from transport companies for transport units that cross war zones.

Other

Any other adjustment not covered by the attribute list.

(sequence)

The sequence of items below is mandatory. A single instance is required.

MonetaryAdjustmentLine

MonetaryAdjustmentLine is mandatory. A single instance is required.

A sequence number indicating the order of printing or the sequence in which a group of adjustments are to be considered.

MonetaryAdjustmentStartAmount

MonetaryAdjustmentStartAmount is optional. A single instance might exist.

The beginning currency amount used in the calculation of a monetary adjustment.

MonetaryAdjustmentStartQuantity

MonetaryAdjustmentStartQuantity is optional. A single instance might exist.

The beginning quantity used in the calculation of a monetary adjustment.

Invoice

papiNet Standard - Version 2.31

(choice)

[choice] is optional because of choice construct.

PriceAdjustment

PriceAdjustment is optional because of choice construct.

A group item defining a deviation from the PricePerUnit.

FlatAmountAdjustment

FlatAmountAdjustment is optional because of choice construct.

A group item that contains flat adjustment amount information.

TaxAdjustment

TaxAdjustment is optional because of choice construct.

This content element contains the necessary information to describe, calculate, and handle a tax adjustment.

InformationalAmount

InformationalAmount is optional. A single instance might exist.

A monetary amount used for information purposes only (not for calculation). For example, the invoice price adjustment subtotal is expressed in sterling pounds, and the buyer wants this information expressed in U.S. dollars.

- CreditDebitNote and Invoice - The TaxAmount is displayed in the currency that is applicable throughout the e-Document. When a TaxAmount needs to be displayed in a different national currency, this field is used.

MonetaryAdjustmentReferenceLine

MonetaryAdjustmentReferenceLine is optional. A single instance might exist.

A link to a previously defined MonetaryAdjustmentLine upon which this adjustment is based.

AdditionalText

AdditionalText is optional. Multiple instances might exist.

A text field that is used to communicate information not previously defined or for special instructions. To be used only for circumstances not covered by specific elements.

GeneralLedgerAccount

GeneralLedgerAccount is optional. A single instance might exist.

The general ledger account to be referenced for the item.

MonetaryAdjustmentAmount

MonetaryAdjustmentAmount is optional. A single instance might exist.

The actual amount of the monetary adjustment.

AdjustmentTypeReason

AdjustmentTypeReason is optional. A single instance might exist.

Provides additional information about the type of adjustment. Can be viewed as a sub-classification of the adjustment type attribute or as a textual explanation.

MonetaryAdjustmentReference

MonetaryAdjustmentReference is optional. Multiple instances might exist.

An element detailing relevant references pertaining to the MonetaryAdjustment as

Invoice

papiNet Standard - Version 2.31

indicated by MonetaryAdjustmentReferenceType and AssignedBy.

InvoiceSummary

Summary information for all items on an invoice.

(sequence)

The sequence of items below is mandatory. A single instance is required.

TotalNumberOfLineItems

TotalNumberOfLineItems is optional. A single instance might exist.

The total number of individual line items in the document, regardless of the status or type.

(sequence)

The sequence of items below is optional. Multiple instances might exist.

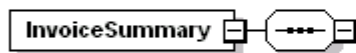

TotalQuantity

TotalQuantity is mandatory. A single instance is required.

The total quantity of similar items in the e-Document. TotalQuantity is primarily used in the summary section of documents where it is repeatable to permit totaling for different units of measure.

TotalInformationalQuantity

TotalInformationalQuantity is optional. Multiple instances might exist.

A quantity that is used to communicate related information about the parent element. This element represents a total that is derived from individual line items.

LineItemSubTotal

LineItemSubTotal is optional. A single instance might exist.

The total amount of all base amounts on e-Document line items. The base amount contains the result of the calculation quantity times the base unit price. As such it does not include any taxes. For example, in an Invoice claiming payment for products LineItemSubTotal is equal to the sum of all InvoiceLineBaseAmount.

TotalAdjustments

TotalAdjustments is optional. A single instance might exist.

The CurrencyValue of TotalAdjustments contains the total of all adjustments and

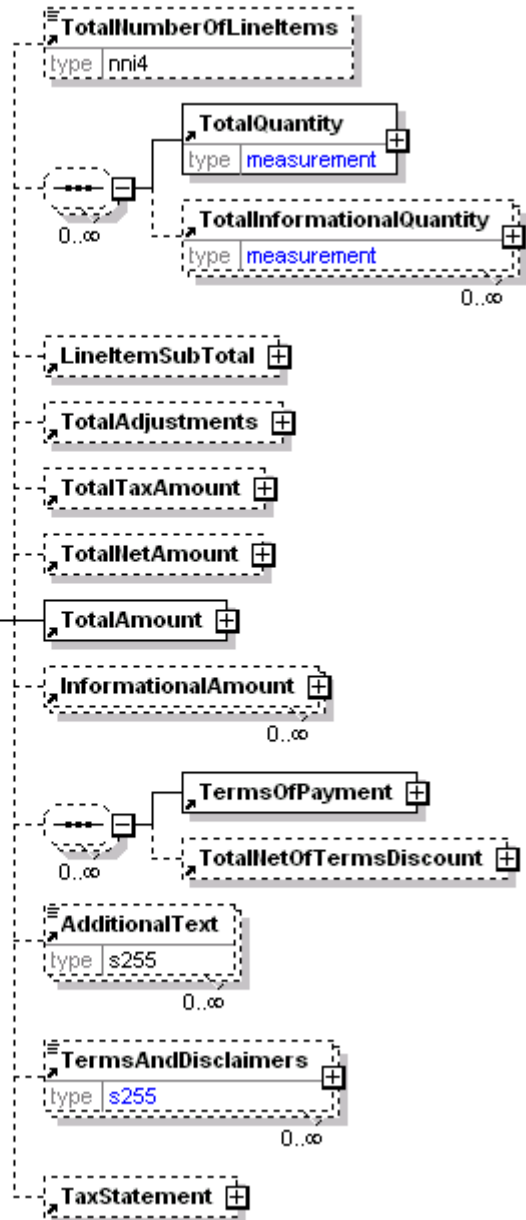

Invoice

papiNet Standard - Version 2.31

charges excluding tax. For example, in the Invoice TotalAdjustments is equal to the sum of the signed values of the MonetaryAdjustmentAmount for all instances of MonetaryAdjustment with PriceAdjustment and FlatAmountAdjustment and plus the sum of the signed values of the ChargeNetAmount for all instances of ChargeInformation.

TotalTaxAmount

TotalTaxAmount is optional. A single instance might exist.

The CurrencyValue of TotalTaxAmount contains the sum of all instances of TaxAdjustment in the document. TotalTaxAmount contains the sum of all instances of the MonetaryAdjustmentAmount for tax adjustments.

TotalNetAmount

TotalNetAmount is optional. A single instance might exist.

A field containing total amount excluding tax. For example, in the Invoice TotalNetAmount is equal to the sum of LineItemSubTotal plus TotalAdjustments. TotalNetAmount encapsulates CurrencyValue.

TotalAmount

TotalAmount is mandatory. A single instance is required.

The total amount including tax (when tax is specified in the e-Document).

In e-Documents claiming payment this is the amount due for payment based on the terms of payment. Decimal rounding might be applied to this amount.

InformationalAmount

InformationalAmount is optional. Multiple instances might exist.

A monetary amount used for information purposes only (not for calculation). For example, the invoice price adjustment subtotal is expressed in sterling pounds, and the buyer wants this information expressed in U.S. dollars.

- CreditDebitNote and Invoice - The TaxAmount is displayed in the currency that is applicable throughout the e-Document. When a TaxAmount needs to be displayed in a different national currency, this field is used.

(sequence)

The sequence of items below is optional. Multiple instances might exist.

TermsOfPayment

TermsOfPayment is mandatory. A single instance is required.

A group item that contains agreed-to terms defining when, how, and under what conditions the payment is to be made.

When TermsOfPayment is optional; if omitted, TermsOfPayment is controlled through previous negotiation.

TotalNetOfTermsDiscount

TotalNetOfTermsDiscount is optional. A single instance might exist.

The components of the amount to be paid if prompt payment discount terms are met, including the amount that is subject to the payment terms discount, the discount amount, and the amount due after prompt payment discount.

AdditionalText

AdditionalText is optional. Multiple instances might exist.

A text field that is used to communicate information not previously defined or for special instructions. To be used only for circumstances not covered by specific

Invoice

papiNet Standard - Version 2.31

elements.

TermsAndDisclaimers

TermsAndDisclaimers is optional. Multiple instances might exist.

An element that contains legal information with an indication of what the Language is.

TaxStatement

TaxStatement is optional. A single instance might exist.

A group element for declaration of exception from normal charges of tax and the reason for tax exemption.

Invoice

papiNet Standard - Version 2.31

Invoice Business Scenarios

Invoice Scenario Listing

Scenario A	Regular Invoice sent to Buyer with payment directly to Supplier. The Supplier is also the Seller.
Scenario B	Regular Invoice sent to Buyer with payment to the Supplier's bank account. The Supplier is also the Seller.
Scenario C	Delivery cancelled after Invoice is communicated to the buyer. Alternatively, the Invoice was created in error.
Scenario D	Invoice for a call-off
Scenario E	Self-Billing Invoice
Scenario F	A DebitNote is sent with one or more InvoiceLineItem(s) due to unforeseen costs upon delivery of the goods.
Scenario G	A DebitNote is sent that corrects an erroneous CreditNote
Scenario H	A CreditNote is sent that cancels an erroneous DebitNote
Scenario I	A CreditNote is sent to compensate or charge one of the trading partners for damage that occurred during goods transport
Scenario J	A CreditNote is sent to compensate for an Invoice that was erroneously issued by the seller
Scenario K	A quarterly CreditNote is sent as a rebate to a customer for having reached a pre-agreed target volume

Scenario A

e-Document	Invoice
Type	Invoice
Scenario	Regular Invoice sent to Buyer with payment directly to the Supplier. The Supplier is also the Seller.
Outcome	Invoice is entered into the Buyer's system. Payment is made directly to Supplier, for example, by sending a check.
Initiator	Supplier

Invoice papiNet Standard - Version 2.31

Receiver	Buyer
Preconditions	This Use Case assumes the Supplier has previously sent material to the Buyer.
Trigger	Material shipment
Step 1.	Supplier sends a regular Invoice to the Buyer. The Invoice does not contain any statuses. The following information that is included in the Invoice is particular to this Use Case. <ul style="list-style-type: none"> • InvoiceType = "Invoice" • SupplierParty <ul style="list-style-type: none"> • PartyIdentifier = the code itself • RemitToParty <ul style="list-style-type: none"> • Not included in e-Document

Scenario B

e-Document	Invoice
Type	Invoice
Scenario	Regular Invoice sent to Buyer with payment to the Supplier's bank account. The Supplier is also the Seller
Outcome	Invoice is entered into the Supplier's system. Payment is made to the Supplier's bank account.
Initiator	Supplier
Receiver	Buyer
Preconditions	This Use Case assumes the Supplier has previously sent material to the Buyer.
Trigger	Material shipment
Step 1.	Supplier sends a regular Invoice to the Buyer. The Invoice does not contain any statuses. Additional information sent with e-Document. <ul style="list-style-type: none"> • InvoiceType = "Invoice" • SupplierParty <ul style="list-style-type: none"> • contains normal address information for the supplier. RemitToParty • PartyIdentifierType(1) = "BankIdentificationCode" • PartyIdentifier(1) = the code itself

Invoice

papiNet Standard - Version 2.31

	<ul style="list-style-type: none"> • PartyIdentifierType(2) = "PayeeAccountNumber" • PartyIdentifier(2) = the code itself
--	---

Scenario C

e-Document	Invoice
Type	Invoice
Scenario	Delivery cancelled after Invoice is communicated to buyer. An alternative could be that the Invoice is created in error.
Outcome	Invoice is entered into the Buyer's system and a Credit Note is required to offset it.
Initiator	Supplier
Receiver	Buyer
Step 1.	Supplier sends an Invoice to the Buyer the exact nature of the Invoice is not relevant
Step 2.	Supplier sends a new Invoice with type equal to "CreditNote" to the Buyer.

Scenario D

e-Document	Invoice
Type	Invoice
Scenario	Invoice is referenced in the CallOff. The Supplier is also the Seller.
Outcome	Invoice is entered into the Buyer's system.
Initiator	Supplier
Receiver	Buyer
Preconditions	A CallOff initiated shipment
Trigger	DeliveryMessage
Step 1.	Buyer sends a CallOff to the Supplier.
Step 2.	Supplier responds with a CallOffConfirmation.
Step 3.	Supplier sends the delivery along with a DeliveryMessage.
Step 4.	Supplier sends a regular Invoice to the Buyer. The Invoice does not contain any statuses.

Invoice

papiNet Standard - Version 2.31

	<p>Additional information sent with e-Document.</p> <ul style="list-style-type: none"> • InvoiceType = "Invoice" • SupplierParty contains normal address information for the supplier • RemitToParty is supplied if payments will be made to an associated Seller's bank account • PurchaseOrderInformation indicates the purchase order against which the material was shipped. • InvoiceReference contains references to CallOffNumber and CallOffLineItemNumber.
--	--

Scenario E

e-Document	Invoice
Type	SelfBillingStatement
Scenario	When sending a SelfBillingStatement to the supplier of the logistics services.
Outcome	SelfBillingStatement is entered into the logistics supplier's system.
Initiator	Buyer of the logistics services
Receiver	Supplier of the logistics services
Preconditions	A previous agreement between the two parties
Trigger	Services are rendered
XML File	Invoice_ScenarioE.xml <ul style="list-style-type: none"> • Focus on InvoiceLineItem
Step 1.	Buyer of the logistics services sends an Invoice (InvoiceType = "SelfBillingStatement" and InvoiceContextType = "LogisticsService").
Step 2.	<p>Supplier of the logistics services checks to see that the data are correct. The supplier responds with a BusinessAcceptance indicating Accepted or Rejected.</p> <p>If the data are not correct and the SelfBillingStatement is Rejected, then reconciliation will occur outside of the e-transaction process.</p>
Step 3.	Buyer of the logistics services will selfbill.
Step 4.	Additional information sent with

Invoice

papiNet Standard - Version 2.31

	SelfBillingStatement could be: <ul style="list-style-type: none"> • ChargeInformation • Reference to CostComponents
--	---

Scenario F

e-Document	Invoice
Type	DebitNote
Scenario	A DebitNote is sent with one or more InvoiceLineItem(s) referring to multiple Delivery Messages
Outcome	ShipToParty and SupplierParty systems are updated with DebitNote information
Initiator	ShipToParty
Receiver	SupplierParty
Trigger	Unforeseen costs upon delivery of the goods occurred.
Example	ShipToParty is issueing a DebitNote.

Scenario G

e-Document	Invoice
Type	DebitNote
Scenario	A DebitNote is sent that corrects an erroneous CreditNote.
Outcome	SupplierParty and BillToParty systems are updated according to the DebitNote information
Initiator	SupplierParty
Receiver	BillToParty
Trigger	The CreditNote has an error and needs to be corrected
Step 1	SupplierParty send a CreditNote
Step 2	An error in the CreditNote amount is detected. Note: This type of error would not normally be communicated via the BusinessAcknowledgement but would take place through another means.

Invoice

papiNet Standard - Version 2.31

Step 3	SupplierParty sends a DebitNote correcting the amount
---------------	---

Scenario H

e-Document	Invoice
Type	CreditNote
Scenario	A CreditNote is sent that cancels an erroneous DebitNote
Outcome	SupplierParty and ShipToParty systems are updated according to the CreditNote information
Initiator	SupplierParty
Receiver	ShipToParty
Trigger	The DebitNote has an error and should be cancelled
Step 1	SupplierParty sends a DebitNote
Step 2	An error in the DebitNote is detected. Note: This type of error would not normally be communicated via the BusinessAcknowledgement but would take place through other means.
Step 3	SupplierParty sends a CreditNote cancelling the DebitNote amount

Scenario I

e-Document	Invoice
Type	CreditNote
Scenario	A CreditNote is sent to compensate or charge one of the trading partners for damage that occurred during goods transport
Outcome	SupplierParty and ShipToParty or BuyerParty systems are updated with CreditNote information
Initiator	SupplierParty
Receiver	ShipToParty or BuyerParty
Preconditions	Terms of sales preclude that the transport is paid by the SupplierParty
Trigger	Unforeseen costs upon delivery of the goods has occurred

Invoice

papiNet Standard - Version 2.31

Example	The SupplierParty delivers a load of reels to the ShipToParty. During transport, the paper gets wet because of water infiltration through a leak in the transport vehicle.
----------------	--

Scenario J

e-Document	Invoice
Type	CreditNote
Scenario	A CreditNote is sent to compensate for an Invoice that was erroneously issued by the seller
Outcome	SupplierParty and BillToParty or BuyerParty systems are updated with the CreditNote information
Initiator	SupplierParty
Receiver	BillToParty or BuyerParty
Trigger	Unforeseen Invoice error
Example	An Invoice has been sent to the BillToParty or BuyerParty by mistake

Scenario K

e-Document	Invoice
Type	CreditNote
Scenario	A quarterly CreditNote is sent as a rebate to the buyer for having reached a pre-agreed to target volume
Outcome	SupplierParty and BuyerParty systems are updated with CreditNote information
Initiator	SupplierParty
Receiver	BuyerParty
Trigger	Rebate/Bonus analysis
Example	A rebate/bonus agreement is fulfilled by the buyer