



**papiNet**

**LoadTender & LoadTenderResponse**

**papiNet Standard - Version 2.31**

**Documentation**

**Global Standard for the Paper and Forest  
Products Supply Chain**

**Build V2R31\_20151026**

**Date 2015-10-28**

**Production Release**

# LoadTender

## papiNet Standard - Version 2.31

---

### Copyright

Copyright 2000 - 2015 papiNet G.I.E ("papiNet") and International Digital Enterprise Alliance, Inc. ("IDEAlliance") collectively "Copyright Owner". All rights reserved by the Copyright Owner under the laws of the United States, Belgium, the European Economic Community, and all states, domestic and foreign. This document may be downloaded and copied provided that all copies retain and display the copyright and any other proprietary notices contained in this document. This document may not be sold, modified, edited, or taken out of context such that it creates a false or misleading statement or impression as to the purpose or use of the papiNet specification, which is an open standard. Use of this Standard, in accord with the foregoing limited permission, shall not create for the user any rights in or to the copyright, which rights are exclusively reserved to the Copyright Owner.

papiNet, IDEAlliance, and the members of all papiNet Groups (collectively and individually, "Presenters") make no representations or warranties, express or implied, including, but not limited to, warranties of merchantability, fitness for a particular purpose, title, or non-infringement. The presenters do not make any representation or warranty that the contents of this document are free from error, suitable for any purpose of any user, or that implementation of such contents will not infringe any third party patents, copyrights, trademarks or other rights. By making use of this document, the user assumes all risks and waives all claims against Presenters.

In no event shall Presenters be liable to user (or other person) for direct, indirect, special or consequential damages arising from or related to any use of this document, including, without limitation, lost profits, business interruption, loss of programs, or other data on your information handling system even if Presenters are expressly advised of the possibility of such damages.

---

### Use of Documents in papiNet Implementations

Documents may be used as templates for a papiNet implementation. The Presenters grant the right to modify and edit them to fit an actual implementation project provided all copies display the copyright and any other proprietary notices contained in this document. Such modified documents must not be distributed beyond the trading partners implementing or maintaining a papiNet connection.

# LoadTender

## papiNet Standard - Version 2.31

---

---

### Table of Contents

Copyright .....	2
Use of Documents in papiNet Implementations .....	2
Table of Contents .....	3
LoadTender & LoadTenderResponse Documentation .....	4
LoadTender e-Document Overview .....	4
LoadTender Scope .....	4
LoadTenderType [attribute] .....	4
Business Rules for LoadTender .....	4
Processing the LoadTender .....	5
Understanding the Diagrams and Content .....	6
LoadTender Root Element .....	8
LoadTender .....	8
Primary Elements .....	10
LoadTenderHeader .....	10
LoadTenderSegment .....	13
LoadTenderLineItem .....	16
MonetaryAdjustment .....	18
LoadTenderSummary .....	24
LoadTenderResponse Root Element .....	25
LoadTenderResponse .....	25
Primary Elements .....	28
LoadTenderResponseHeader .....	28
LoadTenderResponseSegment .....	32
LoadTenderResponseLineItem .....	35
MonetaryAdjustment .....	38
LoadTenderResponseSummary .....	44
LoadTender Business Scenarios .....	46
LoadTender and LoadTenderResponse Scenario Listing .....	46
Scenario A .....	46
Scenario B .....	47
Scenario C .....	48
Scenario D .....	48
Scenario E .....	49
Scenario F .....	50
Scenario G .....	51
Scenario H .....	51
Scenario I .....	52
Scenario J .....	53
Scenario K .....	54
Scenario L .....	55
Scenario M .....	56
Scenario N .....	57
Scenario o .....	58
Scenario P .....	58

# LoadTender

## papiNet Standard - Version 2.31

### LoadTender & LoadTenderResponse Documentation

#### LoadTender e-Document Overview

The LoadTender e-Document supports the transport booking process. Transport booking includes the following steps:

- LoadTender – more than one carrier has been informed about the upcoming transport.
- Booking – identifies a transport booking that is part of a detail transport plan, the load has been booked with a single carrier.

#### LoadTender Scope

The booking process, which is supported by the LoadTender e-document, is used to forward information and associated basic booking data on upcoming transports for pre-booking, booking and load tender phases, including responses.

#### LoadTenderType [attribute]

Code indicating the function of the LoadTender e-Document.



*This item is restricted to the following list.*

##### PreBooking

A requirement for a transport vehicle or unit reservation that has risen from a rough transport plan.

##### Booking

An indication that time for a service is required. For example a booking that is part of a detail transport plan.

##### LoadTender

More than one carrier has been informed about the upcoming transport requirement (the load).

#### Business Rules for LoadTender

##### General Business Rules

The following table list the business rules that apply to the booking process(es).

Identifier	Business Rule
LT001	Transport booking process refers to a LoadTenderNumber, which is the unique alphanumeric identifier.
LT002	Basic booking process data may include data of ShipFromLocationParty, ShipToParty, reloading locations and amount of to be delivered goods on a certain day within a certain time range.

## LoadTender papiNet Standard - Version 2.31

Identifier	Business Rule
<b>LT003</b>	Booking process may include information on certain loading / unloading characteristics (instructions / restrictions).
<b>LT004</b>	e-Document structure (see charts above) initially allows multiple booking references (stowage modes) on a single transport mode.
<b>LT005</b>	ShipToCharacteristics may appear at either the LoadTenderHeader / LoadTenderResponse Header or the LoadTenderSegment / LoadTenderResponseSegment depending on transport requirements. The information in the LoadTenderSegment / LoadTenderResponseSegment overrides the information at the LoadTenderHeader / LoadTenderResponseHeader.
<b>LT006</b>	TransportInformation may appear at either the LoadTenderHeader / LoadTenderResponse Header or the LoadTenderSegment / LoadTenderResponseSegment depending on transport requirements. The information in the LoadTenderSegment / LoadTenderResponseSegment overrides the information at the LoadTenderHeader / LoadTenderResponseHeader.
<b>LT007</b>	[obsolete]
<b>LT008</b>	All transport orders, assigned to the same CoLoadingIdentifier have to be in one LoadTender e-Document.
<b>LT009</b>	The booking e-Document can only be accepted or declined as a whole; deletion of specific LoadTenderSegment's is not permitted.

### Processing the LoadTender

#### Triggers

The booking process (the LoadTender e-Document provides the data for the transport booking process) can be triggered during order entry and/or at transport planning. The booking process includes new bookings as well as changes to associated booking data.

# LoadTender

## papiNet Standard - Version 2.31

---

### Confirmation

Confirmation can be provided using either the LoadTenderResponse or via the papiNet BusinessAcknowledgment e-Document, depending on the trading partner agreement.

---

### Understanding the Diagrams and Content

This section provides a graphical view of the schema structures, a discussion of the item's children. You can find additional information about papiNet and the standard at [www.papiNet.org](http://www.papiNet.org).

The graphics contain content model indicators, cardinality indicators, and data type information.

Associated with each graphic are the definitions for the parent item and any associated child items. All attributes are listed first, followed by the elements.

The following information should help you interpret and understand this standard. Please note the following:

- Content Model and Cardinality operate together to determine if the element or attribute are required in the instance document.
- The same attribute can never appear multiple times in the same element so, you will never see a multiple cardinality indicator.

#### Content model indicators:

There are three possible types of content: "sequence", "choice", and "all". The papiNet standard currently does not use the "all" construct.

- (sequence)

The sequence of the items to the right of the graphic (or below the text) is required.

- (choice)

A choice of the items to the right of the graphic (or below the text) is permitted.

- (all)

All the items to the right of the graphic are required.

#### Cardinality indicators:

- Dotted line around element or attribute.

A single instance of the item can optionally exist.

- Dotted line around item with range indicated below.

Multiple instances of the item can optionally exist.

- Solid line around item.

A single instance of the item must exist.

- Solid line around item with range indicated below

At least one instance must exist; multiple instances can optionally exist.

#### Datatype indication:

When a data type is assigned to an element (either a simple type or complex type) the name of the data type is presented beneath the item name in the graphic.

- In some cases additional information about the data type is presented

## LoadTender

### papiNet Standard - Version 2.31

---

---

(the default value).

Elements can either have content that is textual/numeric in nature or content that is made up of additional elements and/or attributes.

- When the content is textual/numeric in nature “three straight horizontal lines” will appear in the upper left-hand corner of the graphic. Pay attention to these elements because they are where you will be entering your information.
- When the content is made up of additional elements and/or attributes a “gray-box” will appear on the right-hand side of the graphic.
- If the graphic shows both the horizontal lines and the gray-box then, in the papiNet standard, the content below the element are attributes.

# LoadTender

## papiNet Standard - Version 2.31

### LoadTender Root Element

#### LoadTender

The LoadTender element is the root element for the LoadTender e-Document.

The LoadTender e-Document supports the transport booking process. Transport booking includes the following steps:

- LoadTender – more than one carrier has been informed about the upcoming transport.
- Booking – identifies a transport booking that is part of a detail transport plan, the load has been booked with a single carrier.

**LoadTender**

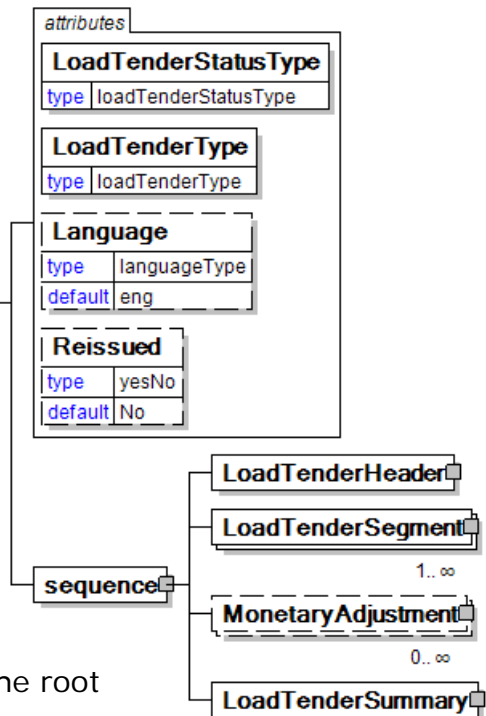

#### LoadTenderStatusType [attribute]

*LoadTenderStatusType is mandatory. A single instance is required.*

Identifies the status of the entire LoadTender e-Document (in other words, at the root level).

*This item is restricted to the following list.*

##### **Amended**

The supplied information is changed.

##### **Cancelled**

The supplied information has been cancelled. Items that have been cancelled are not included in totals on the summary levels of the e-document.

##### **Original**

The supplied information is the first version of that information.

#### LoadTenderType [attribute]

*LoadTenderType is mandatory. A single instance is required.*

Code indicating the function of the LoadTender e-Document

*This item is restricted to the following list.*

##### **PreBooking**

A requirement for a transport vehicle or unit reservation that has risen from a rough transport plan.

##### **Booking**

An indication that time for a service is required. For example a booking that is part of a detail transport plan.

##### **LoadTender**

More than one carrier has been informed about the upcoming transport requirement (the load).

#### Language [attribute]



# LoadTender

## papiNet Standard - Version 2.31

---

*Language is optional. A single instance might exist.*

XML has embraced 2 and 3 digit language codes through the application of an addendum to the standard.

Information on the content of this attribute is available at <http://www.loc.gov/standards/iso639-2/> this is the official site of the ISO 639-2 Registration Authority.

- <http://www.w3.org/International/O-HTML-tags.html> provides an explanation of the errata updating XML.
- <http://www.ietf.org/rfc/rfc3066.txt> is the key document that is referenced in the above errata.

### **Reissued [attribute]**

*Reissued is optional. A single instance might exist.*

Either "Yes" or "No".

*This item is restricted to the following list.*

**Yes**

**No**

### **(sequence)**

*The contents of (sequence) are mandatory. A single instance is required.*

#### **LoadTenderHeader**

*LoadTenderHeader is mandatory. A single instance is required.*

The LoadTenderHeader contains information common to the entire LoadTender.

#### **LoadTenderSegment**

*LoadTenderSegment is mandatory. One instance is required, multiple instances might exist.*

The details for a particular load segment.

#### **MonetaryAdjustment**

*MonetaryAdjustment is optional. Multiple instances might exist.*

The element containing the information necessary for the understanding, calculation, and treatment of an adjustment to a currency amount.

MonetaryAdjustment contains an attribute that indicates they type of adjustment being communicated.

#### **LoadTenderSummary**

*LoadTenderSummary is mandatory. A single instance is required.*

Summary information that applies to the entire LoadTender e-Document

# LoadTender

## papiNet Standard - Version 2.31

### Primary Elements

#### LoadTenderHeader

The LoadTenderHeader contains information common to the entire LoadTender.

##### LoadTenderHeaderStatusType [attribute]

*LoadTenderHeaderStatusType is mandatory. A single instance is required.*

Identifies the status of the header of the LoadTender e-Document.

*This item is restricted to the following list.*

##### Amended

The supplied information is changed

##### Cancelled

The supplied information has been cancelled. Items that have been cancelled are not included in totals on the summary levels of the e-document.

##### Original

The supplied information is the first version of that information.

##### IsPartialConfirmationsAllowed [attribute]

*IsPartialConfirmationsAllowed is optional. A single instance is might exist.*

Specifies if partial confirmations are allowed or not, e.g. confirmations of one segment only. Default value is No.

*This item is restricted to the following list.*

Yes

No

##### (sequence)

*The sequence of items below is mandatory. A single instance is required.*

##### LoadTenderNumber

*LoadTenderNumber is mandatory. A single instance is required.*

The identifier for the LoadTender e-Document.

LoadTenderHeader

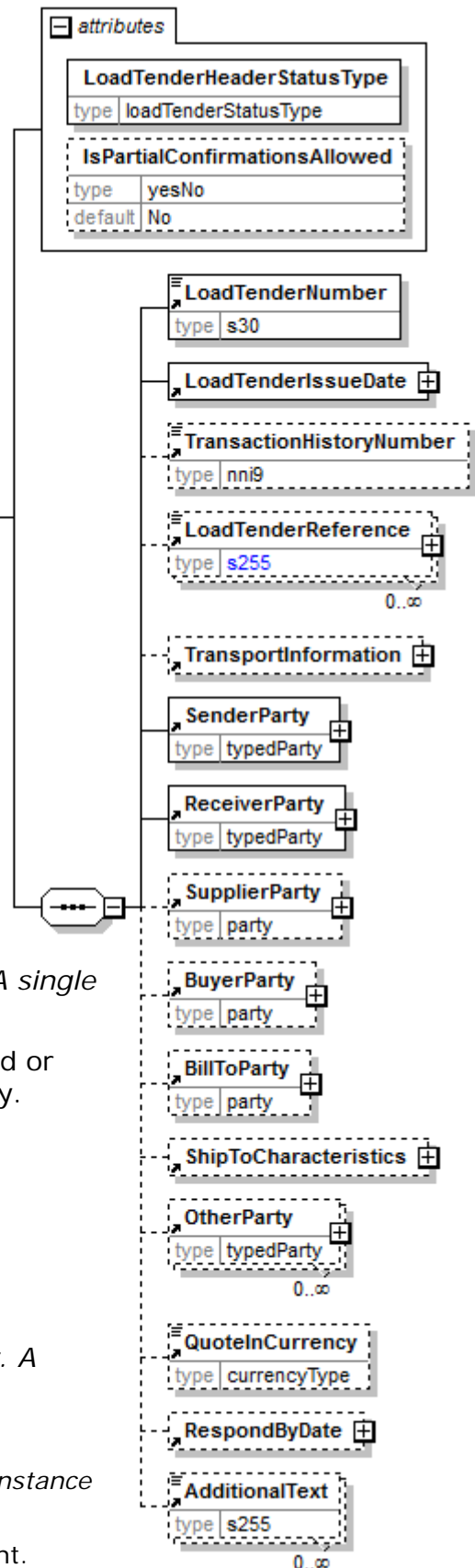

# LoadTender

## papiNet Standard - Version 2.31

---

### **LoadTenderIssueDate**

*LoadTenderIssueDate is mandatory. A single instance is required.*

The date when the e-Document was issued.

### **TransactionHistoryNumber**

*TransactionHistoryNumber is optional. A single instance might exist.*

A sequential number that keeps track of the version of a document being sent by the document originator except in the case where TransactionHistoryConfirmation is used, in which case the TransactionHistoryNumber refers to the trigger transaction for which the confirmation is being sent.

### **LoadTenderReference**

*LoadTenderReference is optional. Multiple instances might exist.*

An item detailing relevant references pertaining to the LoadTender. The type of reference is identified by the LoadTenderReferenceType attribute.

### **TransportInformation**

*TransportInformation is optional. A single instance might exist.*

A grouping element for transport information.

### **SenderParty**

*SenderParty is mandatory. A single instance is required.*

The business entity issuing the e-Document, the source of the document.

- The entity responsible for the content. If the sender party has out sourced the message service to a third party the SenderParty is the issuer of the e-Document and not the party performing the transmission service of the electronic message.

### **ReceiverParty**

*ReceiverParty is mandatory. A single instance is required.*

The business entity for whom the e-Document is intended, the destination of the document.

- The entity interested in the content. If the receiver party has outsourced the message service to a third party the ReceiverParty is the intended party for the e-Document and not the party performing the receiving service of the electronic message.

### **SupplierParty**

*SupplierParty is optional. A single instance might exist.*

The organisation or business entity responsible for providing the product.

SupplierParty is also the seller of the product, if Seller is not specified as OtherParty = Seller.

### **BuyerParty**

*BuyerParty is optional. A single instance might exist.*

The legal entity to which the product is sold. Also commonly referred to as the sold-to party or customer. If no OtherParty is defined as the Payer, the Buyer is the Payer.

### **BillToParty**

*BillToParty is optional. A single instance might exist.*

The address where the invoice is to be sent.

# LoadTender

## papiNet Standard - Version 2.31

---

### **ShipToCharacteristics**

*ShipToCharacteristics is optional. A single instance might exist.*

A group item that provides information important for the Ship-To Party.

ShipToCharacteristics may be referenced at both the header and line item level. The reference at the header is required and acts as a default for the value at the line level, unless overridden at the line level.

### **OtherParty**

*OtherParty is optional. Multiple instances might exist.*

An organisation or business entity other than those specifically detailed within a e-Document.

### **QuoteInCurrency**

*QuoteInCurrency is optional. A single instance might exist.*

Indicates that the quote is to be provided in the currency specified.

Refer to QuoteInCurrency definition for any enumerations.

### **RespondByDate**

*RespondByDate is optional. A single instance might exist.*

The date that a response to the query if required.

### **AdditionalText**

*AdditionalText is optional. Multiple instances might exist.*

A text field that is used to communicate information not previously defined or for special instructions. To be used only for circumstances not covered by specific elements.

# LoadTender

## papiNet Standard - Version 2.31

### LoadTenderSegment

The details for a particular load segment.

#### LoadTenderSegmentStatusType [attribute]

*LoadTenderSegmentStatusType is mandatory. A single instance is required.*

Identifies the status of the LoadTender segment.

*This item is restricted to the following list.*

##### Amended

The supplied information is changed

##### Cancelled

The supplied information has been cancelled. Items that have been cancelled are not included in totals on the summary levels of the e-document.

##### Original

The supplied information is the first version of that information.

#### LoadTenderSegmentDocumentStatus [attribute]

*LoadTenderSegmentDocumentStatus is optional. A single instance might exist.*

Defines the actual document status for the LoadTenderSegment.

*This item is restricted to the following list.*

##### Cancelled

The supplied information of the document item is cancelled. Items that have been cancelled are not included in totals on the summary level of e-documents.

##### Requested

The supplied information of the document item is ordered.

#### (sequence)

*The sequence of items below is mandatory. A single instance is required.*

#### LoadTenderSegmentNumber

*LoadTenderSegmentNumber is mandatory. A single instance is required.*

The identifier for the LoadTender segment.

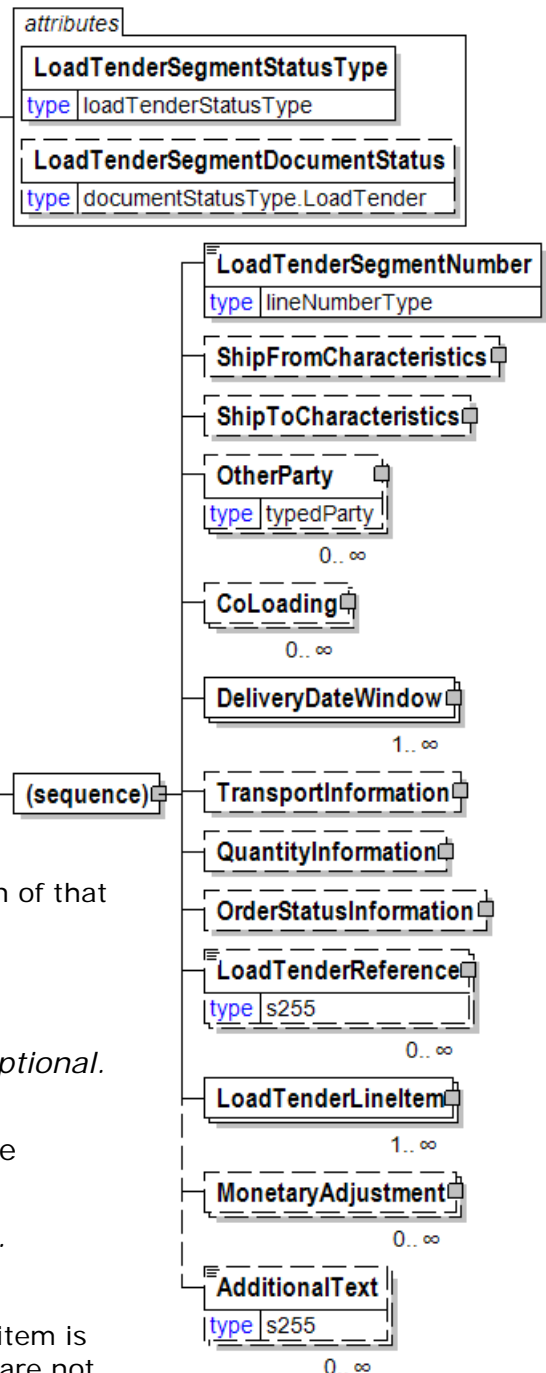

# LoadTender

## papiNet Standard - Version 2.31

---

### **ShipFromCharacteristics**

*ShipFromCharacteristics is optional. A single instance might exist.*

A group item that provides information pertaining to the Ship-From Party.

ShipFromCharacteristics may be referenced at both the header and line item level. The reference at the header, if it exists, acts as a default for the value at the line level, unless overridden at the line level.

### **ShipToCharacteristics**

*ShipToCharacteristics is optional. A single instance might exist.*

A group item that provides information important for the Ship-To Party.

A group item that provides information important for the Ship-To Party. ShipToCharacteristics may be referenced at both the header and line item level. The reference at the header is required and acts as a default for the value at the line level, unless overridden at the line level.

### **OtherParty**

*OtherParty is optional. Multiple instances might exist.*

An organisation or business entity other than those specifically detailed within a business document.

### **CoLoading**

*CoLoading is optional. Multiple instances might exist.*

A group item specifying information about items to be loaded or loaded on the same transport unit.

Used to identify:

- Delivery together to the drop point
- Transport Orders stuffed together in a container
- Transport Orders not splittable

### **DeliveryDateWindow**

*DeliveryDateWindow is mandatory. One instance is required, multiple instances might exist.*

A group item defining the date/time interval for delivery to take place. An element which may contain the estimated date for which delivery is expected. This date is not absolute.

### **TransportInformation**

*TransportInformation is optional. A single instance might exist.*

A grouping element for transport information.

### **QuantityInformation**

*QuantityInformation is optional. A single instance might exist.*

A group item containing information about quantity and informational quantity of similar items.

### **OrderStatusInformation**

*OrderStatusInformation is optional. A single instance might exist.*

A group element that stores two levels of Order status codes.

### **LoadTenderReference**

# LoadTender

## papiNet Standard - Version 2.31

---

*LoadTenderReference is optional. Multiple instances might exist.*

An item detailing relevant references pertaining to the LoadTender. The type of reference is identified by the LoadTenderReferenceType attribute.

### **LoadTenderLineItem**

*LoadTenderLineItem is mandatory. One instance is required, multiple instances might exist.*

Group element identifying a line item to be included within this LoadTender Segment.

### **MonetaryAdjustment**

*MonetaryAdjustment is optional. Multiple instances might exist.*

The element containing the information necessary for the understanding, calculation, and treatment of an adjustment to a currency amount. MonetaryAdjustment contains an attribute that indicates they type of adjustment being communicated.

### **AdditionalText**

*AdditionalText is optional. Multiple instances might exist.*

A text field that is used to communicate information not previously defined or for special instructions. To be used only for circumstances not covered by specific elements.

# LoadTender

## papiNet Standard - Version 2.31

### LoadTenderLineItem

Group element identifying a line item to be included within this LoadTender Segment.

**(sequence)**

*The sequence of items below is mandatory. A single instance is required.*

**LoadTenderLineItemNumber**

*LoadTenderLineItemNumber is mandatory. A single instance is required.*

The sequential number that uniquely identifies the LoadTender line item.

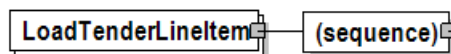

**SupplierParty**

*SupplierParty is optional. A single instance might exist.*

The organisation or business entity responsible for providing the product. SupplierParty is also the seller of the product, if Seller is not specified as OtherParty = Seller.

**Product**

*Product is optional. A single instance might exist.*

Product is a group item defining the article and its characteristics. Product is used to specify product characteristics organized by ProductIdentifier, ProductDescription, and Classification. Book Manufacturing, Label Stock, Paper, Pulp, Recovered Paper, Wood Products, and Virgin Fibre market segments have defined their product characteristics and conversion features for implementation in papiNet.

**QuantityInformation**

*QuantityInformation is mandatory. A single instance is required.*

A group item containing information about quantity and informational quantity of similar items.

**LoadTenderLineItemBaseAmountInformation**

*LoadTenderLineItemBaseAmountInformation is optional. A single instance might exist.*

Group element used to detail the LoadTender Line Item's PriceDetails and TotalAmount. Normally used to identify the PricePerUnit of the line item.

**MonetaryAdjustment**

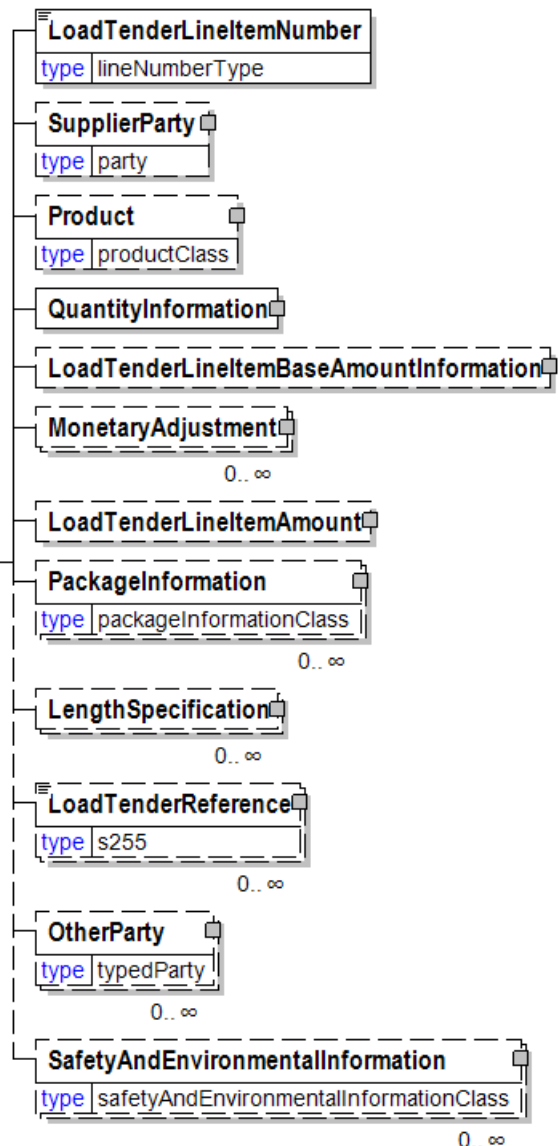



# LoadTender

## papiNet Standard - Version 2.31

---

*MonetaryAdjustment is optional. Multiple instances might exist.*

The element containing the information necessary for the understanding, calculation, and treatment of an adjustment to a currency amount. MonetaryAdjustment contains an attribute that indicates the type of adjustment being communicated.

### **LoadTenderLineItemAmount**

*LoadTenderLineItemAmount is optional. A single instance might exist.*

Total Amount of the LoadTenderLineItem including adjustments and tax (when tax is specified on the load tender line item).

LoadTenderLineItemAmount is equal to the LoadTenderAmount plus the sum of the signed values of the MonetaryAdjustmentAmount for all instances of MonetaryAdjustment.

### **PackageInformation**

*PackageInformation is optional. Multiple instances might exist.*

The purpose of the PackageInformation structure is to clearly identify physical handling items that constitute the delivery.

PackageInformation is the highest level of product packaging it describes the shipping or warehousing unit.

- If you are communicating a package, usually for logistics or transport purposes, you should include the PackageType, Identifier, ItemCount, and Quantity. (Note: you still have the ability to describe the item with one of the "named" items.)
- If you are communicating one of the named Items there is no need to include PackageType, Identifier, ItemCount, and Quantity.

Since either of these two approaches can be used the entire contents of this element are optional even though the parent may be required. It is expected that you will fill in the appropriate details.

### **LengthSpecification**

*LengthSpecification is optional. Multiple instances might exist.*

Length specification of the wood product.

### **LoadTenderReference**

*LoadTenderReference is optional. Multiple instances might exist.*

An item detailing relevant references pertaining to the LoadTender. The type of reference is identified by the LoadTenderReferenceType attribute.

### **OtherParty**

*OtherParty is optional. Multiple instances might exist.*

An organisation or business entity other than those specifically detailed within a business document.

### **SafetyAndEnvironmentalInformation**

*SafetyAndEnvironmentalInformation is optional. Multiple instances might exist.*

Name of certification type, if any, on the goods (For example, FSC, PEFC). SafetyAndEnvironmental needs a value or measurement to communicate the percentage of the product is certified (for example, 75% is certified by the indicated agency).

## MonetaryAdjustment

The element containing the information necessary for the understanding, calculation, and treatment of an adjustment to a currency amount. MonetaryAdjustment contains an attribute that indicates they type of adjustment being communicated.

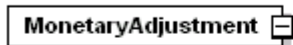

### AdjustmentType [attribute]

*AdjustmentType is mandatory. A single instance is required.*

Describes the type of adjustment applied to a monetary oriented element. Adjustment values should always be given as negative or positive adjustments even if AdjustmentType indicates the sign. For example, a rebate of 1% on an invoice should be given as an adjustment percentage of -1%.

*This item is restricted to the following list.*

#### BillOfLadingCharge

An extra charge for creating a Bill of Lading.

#### CancellationCharge

A charge applied because a cancellation was late (after the last date of change) and all or part of the ordered product has already been made.

#### CashDiscount

A reduction due to a discount applied.

#### CertificateCharge

An extra charge for creating a certificate. Some countries requires Certificates in which different characteristics of the delivery, transport unit, route, product, and others must be proved.

There are certificates for gasen pallets, for the place of production, for the age of the ship/vessel, for not departing from one country's harbour when delivering to another.

#### ChargesForward

A pending invoice amount brought forward from a previous Invoice.

#### ClaimAdjustment

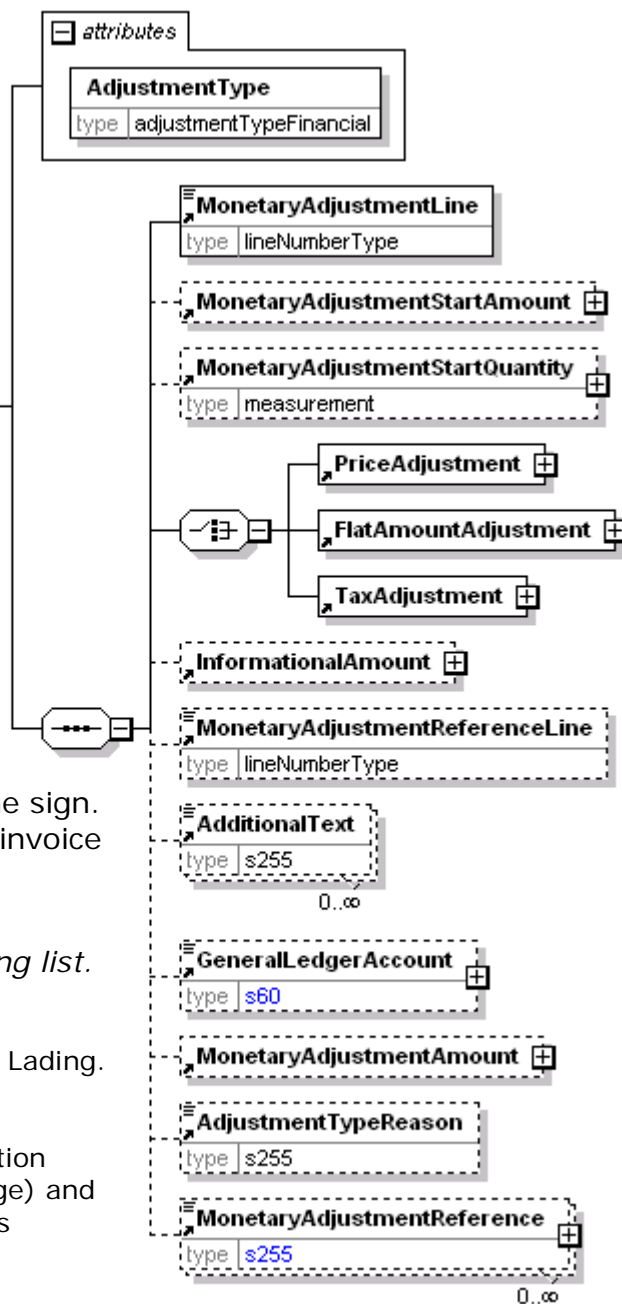

# LoadTender

## papiNet Standard - Version 2.31

---

---

An adjustment related to a filed complaint.

### **Commission**

Commission costs paid to the trading agency or trader.

### **CompetitiveAllowance**

An allowance provided for competitive reasons.

### **CongestionCharge**

An extra fee from ports for waiting time of ships in ports, railcars on a siding, trucks at a dock. (Synonym: Demurrage.)

### **ConsigneeUnloadCharge**

An unloading charge that is the responsibility of the consignee.

### **ContractAllowance**

An allowance for a volume discount, usually because the agreed amount has been exceeded.

### **CurrencyAdjustmentCharge**

An extra fee to adjust for currency variations.

### **DecimalRounding**

Adjustments for rounding of amounts to fit the business agreement or national monetary legislation. This adjustment is typically used for decimal rounding of amounts not including tax.

N.B. Use InformationalAmount with AmountType "DecimalRounding" for specification of decimal rounding of amounts including tax.

### **DefectiveAllowance**

An allowance provided for defective material.

### **DeliveryCharge**

The charge for delivering the product.

### **DeliveryNonConformanceAllowance**

An allowance due to non-conformance with the purchase agreement regarding a delivery.

### **DeliveryTimeBonus**

A bonus given for deliveries of products within a certain time period.

### **EarlyShipAllowance**

An allowance due to a delivery that took place earlier than planned. The seller may be charged a penalty. If this is found before issuing the Invoice, it can be handled through this allowance. If found later, it will be handled through a credit note.

### **EnergySurcharge**

A charge related to increases in the cost of energy.

### **Environmental**

An allowance applied due to environmental regulations.

### **ExpeditedShipmentCharge**

An extra cost charged due to unexpected or emergency requirements (for example, breaking off a run in the mill to reach the production date for a rush order).

# LoadTender

## papiNet Standard - Version 2.31

---

---

### **ExportClearanceCharge**

An extra fee for customs administration.

### **FlatRateCharge**

A general flat charge.

### **FreightAllowance**

The freight cost allowed by the mill. This amount is negative, and will be deducted from the Invoice (U.S. business practice, in the European Union (EU), use only Freight Charge).

### **FreightCharge**

The actual cost incurred to deliver the product. This amount is positive, and will be added to the Invoice.

### **FuelAdjustmentCharge**

An extra fee, usually from shipping companies, to adjust fuel prices.

### **HandlingCharge**

A charge related to the handling of the product.

### **Inspection**

The cost associated with performing an inspection of the product.

### **InterestCharge**

A charge applied for interest on overdue payments.

### **LabourAllowance**

An allowance due to additional labour required in the use or acceptance of the product.

### **LabourCharge**

A charge due to additional labour required in the use or acceptance of the product.

### **LoggingDamage**

An adjustment caused by logging damages on Forest Wood products. Logging damages normally cause a reduction of the product price.

### **LotCharge**

A charge applied to the lot of material.

### **MetalDetection**

A charge for additional metal detection applied to the goods.

### **ModelHomeDiscount**

A discount associated with the building of the model home.

### **NewStoreCouponDiscount**

A discount associated with entry into a new store.

### **OrderQuantity**

A charge or allowance for small/big ordered quantities.

### **PalletCharge**

A charge that represents the cost or rental of the pallet.

### **PickUpAllowance**

# LoadTender

## papiNet Standard - Version 2.31

---

---

An allowance provided to compensate for the cost of picking up the product.

### **PromotionalAllowance**

An allowance provided for the promotion of the product.

### **PromotionalCharge**

A charge associated with the promotion of the product.

### **PriceCorrection**

An adjustment associated with a correction of the product's price.

### **ProductionSetUpCharge**

A special charge applied due to specific buyer requests.

### **Provision**

The act of making ready or equipping for use.

### **Rebate**

A rebate accepted by the buyer and seller based on the agreed price and volume.

### **ReelDiscount**

An allowance for purchasing reels instead of sheets.

### **ReturnedLoadAllowance**

An allowance applied due to the return of the load.

### **ReturnLoadCharge**

A charge applied due to the return of the load.

### **RoadFeeCharge**

A freight charge for a special tax applied to road transports in some countries, e.g. Germany

### **ScrapAndDunnageCharge**

A charge that represents the scrapping of the material and its removal.

### **ServiceCharge**

A charge associated with a miscellaneous service.

### **SpecialConversionCharge**

Additional charge for a special conversion of the product.

### **SpecialDeliveryCharge**

A special charge for delivering the product differently from the usual or agreed-to method.

### **SpecialHandlingCharge**

A special charge for handling the product differently from the usual or agreed-to method.

### **SpecialPackagingCharge**

A special charge for packaging the product differently from the usual or agreed-to method, or if packaging as requested is out of spec.

### **StopOffAllowance**

An allowance for a delivery stop-off.

### **StopOffCharge**

# LoadTender

## papiNet Standard - Version 2.31

---

---

A charge for a delivery stop-off.

### **StorageAllowance**

An allowance for storing the product.

### **StorageCharge**

An extra cost charged for storing the product on location (in the plant).

### **Tax**

An adjustment that reflects a tax item.

### **TestingCharge**

A charge related to testing a paper grade.

### **TradeDiscount**

A discount based on the terms of the trade given on the agreed price. Usually a percentage.

### **TrialDiscount**

A discount applied for a trial run of a new or improved product.

### **TransferCharge**

A freight charge incurred by the goods transfer from one location to another location not previously agreed upon.

### **UnloadingAllowance**

An allowance to compensate for the unloading the product.

### **UnloadingCharge**

A charge for the unloading the product.

### **VolumeDiscount**

A rebate accepted by the buyer and the seller based on the agreed volume

### **WarRiskCharge**

An extra fee from transport companies for transport units that cross war zones.

### **Other**

Any other adjustment not covered by the attribute list.

### **(sequence)**

*The sequence of items below is mandatory. A single instance is required.*

### **MonetaryAdjustmentLine**

*MonetaryAdjustmentLine is mandatory. A single instance is required.*

A sequence number indicating the order of printing or the sequence in which a group of adjustments are to be considered.

### **MonetaryAdjustmentStartAmount**

*MonetaryAdjustmentStartAmount is optional. A single instance might exist.*

The beginning currency amount used in the calculation of a monetary adjustment.

### **MonetaryAdjustmentStartQuantity**

*MonetaryAdjustmentStartQuantity is optional. A single instance might exist.*

The beginning quantity used in the calculation of a monetary adjustment.

# LoadTender

## papiNet Standard - Version 2.31

---

### **(choice)**

*[choice] is optional because of choice construct.*

#### **PriceAdjustment**

*PriceAdjustment is optional because of choice construct.*

A group item defining a deviation from the PricePerUnit.

#### **FlatAmountAdjustment**

*FlatAmountAdjustment is optional because of choice construct.*

A group item that contains flat adjustment amount information.

#### **TaxAdjustment**

*TaxAdjustment is optional because of choice construct.*

This content element contains the necessary information to describe, calculate, and handle a tax adjustment.

#### **InformationalAmount**

*InformationalAmount is optional. A single instance might exist.*

A monetary amount used for information purposes only (not for calculation). For example, the invoice price adjustment subtotal is expressed in sterling pounds, and the buyer wants this information expressed in U.S. dollars.

- CreditDebitNote and Invoice - The TaxAmount is displayed in the currency that is applicable throughout the e-Document. When a TaxAmount needs to be displayed in a different national currency, this field is used.

#### **MonetaryAdjustmentReferenceLine**

*MonetaryAdjustmentReferenceLine is optional. A single instance might exist.*

A link to a previously defined MonetaryAdjustmentLine upon which this adjustment is based.

#### **AdditionalText**

*AdditionalText is optional. Multiple instances might exist.*

A text field that is used to communicate information not previously defined or for special instructions. To be used only for circumstances not covered by specific elements.

#### **GeneralLedgerAccount**

*GeneralLedgerAccount is optional. A single instance might exist.*

The general ledger account to be referenced for the item.

#### **MonetaryAdjustmentAmount**

*MonetaryAdjustmentAmount is optional. A single instance might exist.*

The actual amount of the monetary adjustment.

#### **AdjustmentTypeReason**

*AdjustmentTypeReason is optional. A single instance might exist.*

Provides additional information about the type of adjustment. Can be viewed as a sub-classification of the adjustment type attribute or as a textual explanation.

#### **MonetaryAdjustmentReference**

*MonetaryAdjustmentReference is optional. Multiple instances might exist.*

An element detailing relevant references pertaining to the MonetaryAdjustment as

# LoadTender

## papiNet Standard - Version 2.31

indicated by MonetaryAdjustmentReferenceType and AssignedBy.

### LoadTenderSummary

Summary information that applies to the entire LoadTender e-Document

#### (sequence)

The contents of (sequence) are mandatory. A single instance is required.

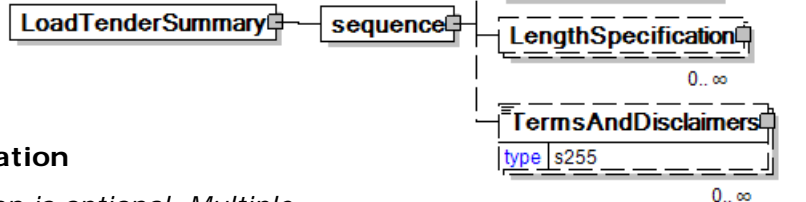

#### TotalQuantityInformation

TotalQuantityInformation is optional. Multiple instances might exist.

A group item containing information about the total quantity and total informational quantity of similar items in the document. TotalQuantityInformation is primarily used in the summary section of e-Documents where it is repeatable to permit totalling for different units of measure.

#### LinelItemSubTotal

LinelItemSubTotal is optional. A single instance might exist.

The total amount of all base amounts on e-Document line items. The base amount contains the result of the calculation quantity times the base unit price. As such it does not include any taxes. For example, in an Invoice claiming payment for products LinelItemSubTotal is equal to the sum of all InvoiceLineBaseAmount.

#### LengthSpecification

LengthSpecification is optional. Multiple instances might exist.

Length specification of the wood product.

#### TermsAndDisclaimers

TermsAndDisclaimers is optional. Multiple instances might exist.

An element that contains legal information with an indication of what the Language is.



# LoadTender

## papiNet Standard - Version 2.31

### LoadTenderResponse Root Element

#### LoadTenderResponse

The LoadTenderResponse element is the root element for the LoadTenderResponse e-Document.

The LoadTenderResponse e-Document supports the transport booking process and is used as a response e-Document to LoadTender e-Document. Transport booking includes the following steps:

- **LoadTenderResponse** – more than one carrier has been informed about the upcoming transport.
- **BookingConfirmation** – identifies a transport booking that is part of a detail transport plan, the load has been booked with a single carrier.

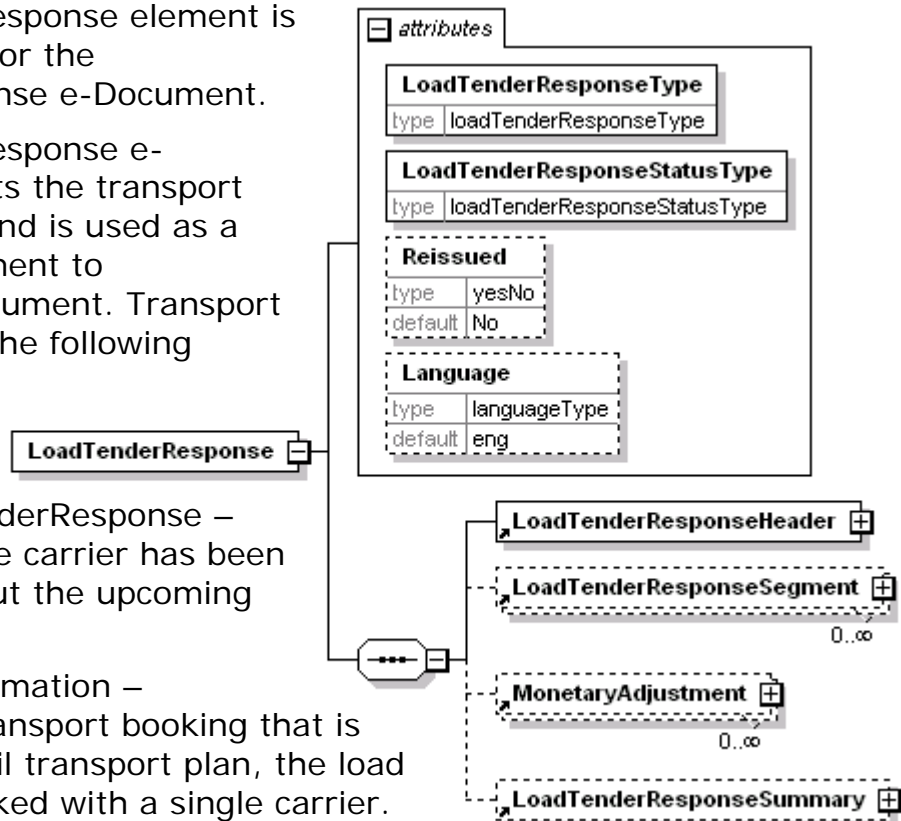

The LoadTenderResponse provides a means of communicating these events.

#### **LoadTenderResponseType [attribute]**

*LoadTenderResponseType is mandatory. A single instance is required.*

Code indicating the function of the e-Document.

*This item is restricted to the following list.*

#### **PreBookingConfirmation**

A communication of the requirement for a transport vehicle or unit reservation that has risen from a rough transport plan.

#### **BookingConfirmation**

A communication affirming the placement of the booking with a particular party.

#### **LoadTenderResponse**

Indicates the ability of the respondent to fulfill the LoadTender request.

#### **Reissued [attribute]**

*Reissued is optional. A single instance might exist.*

Either "Yes" or "No".

*This item is restricted to the following list.*

**Yes**

# LoadTender

## papiNet Standard - Version 2.31

---

**No**

### **Language [attribute]**

*Language is optional. A single instance might exist.*

XML has embraced 2 and 3 digit language codes through the application of an addendum to the standard.

Information on the content of this attribute is available at <http://www.loc.gov/standards/iso639-2/> this is the official site of the ISO 639-2 Registration Authority.

- <http://www.w3.org/International/O-HTML-tags.html> provides an explanation of the errata updating XML.
- <http://www.ietf.org/rfc/rfc3066.txt> is the key document that is referenced in the above errata.

### **LoadTenderResponseStatusType [attribute]**

*LoadTenderResponseStatusType is mandatory. A single instance is required.*

Identifies the status of the entire LoadTenderResponse e-Document (in other words, at the root level).

*This item is restricted to the following list.*

#### **Accepted**

The supplied information is accepted.

#### **Amended**

The supplied information is changed

#### **Cancelled**

The supplied information is cancelled. Items that have been cancelled are not included in totals on the summary levels of the e-Document.

#### **Pending**

The supplied information of the document item is being investigated.

#### **Rejected**

The supplied information is rejected.

### **(sequence)**

*The contents of (sequence) are mandatory. A single instance is required.*

#### **LoadTenderResponseHeader**

*LoadTenderResponseHeader is mandatory. A single instance is required.*

The LoadTenderResponseHeader contains information common to the entire LoadTenderResponse.

#### **LoadTenderResponseSegment**

*LoadTenderResponseSegment is optional. Multiple instances might exist.*

The details for a particular load segment.

#### **MonetaryAdjustment**

*MonetaryAdjustment is optional. Multiple instances might exist.*

The element containing the information necessary for the understanding, calculation, and treatment of an adjustment to a currency amount.

# LoadTender

## papiNet Standard - Version 2.31

---

MonetaryAdjustment contains an attribute that indicates the type of adjustment being communicated.

### **LoadTenderResponseSummary**

*LoadTenderResponseSummary is optional. A single instance might exist.*

Summary information that applies to the entire LoadTenderResponse e-Document

# LoadTender

## papiNet Standard - Version 2.31

### Primary Elements

#### LoadTenderResponseHeader

The LoadTenderResponseHeader contains information common to the entire LoadTenderResponse.

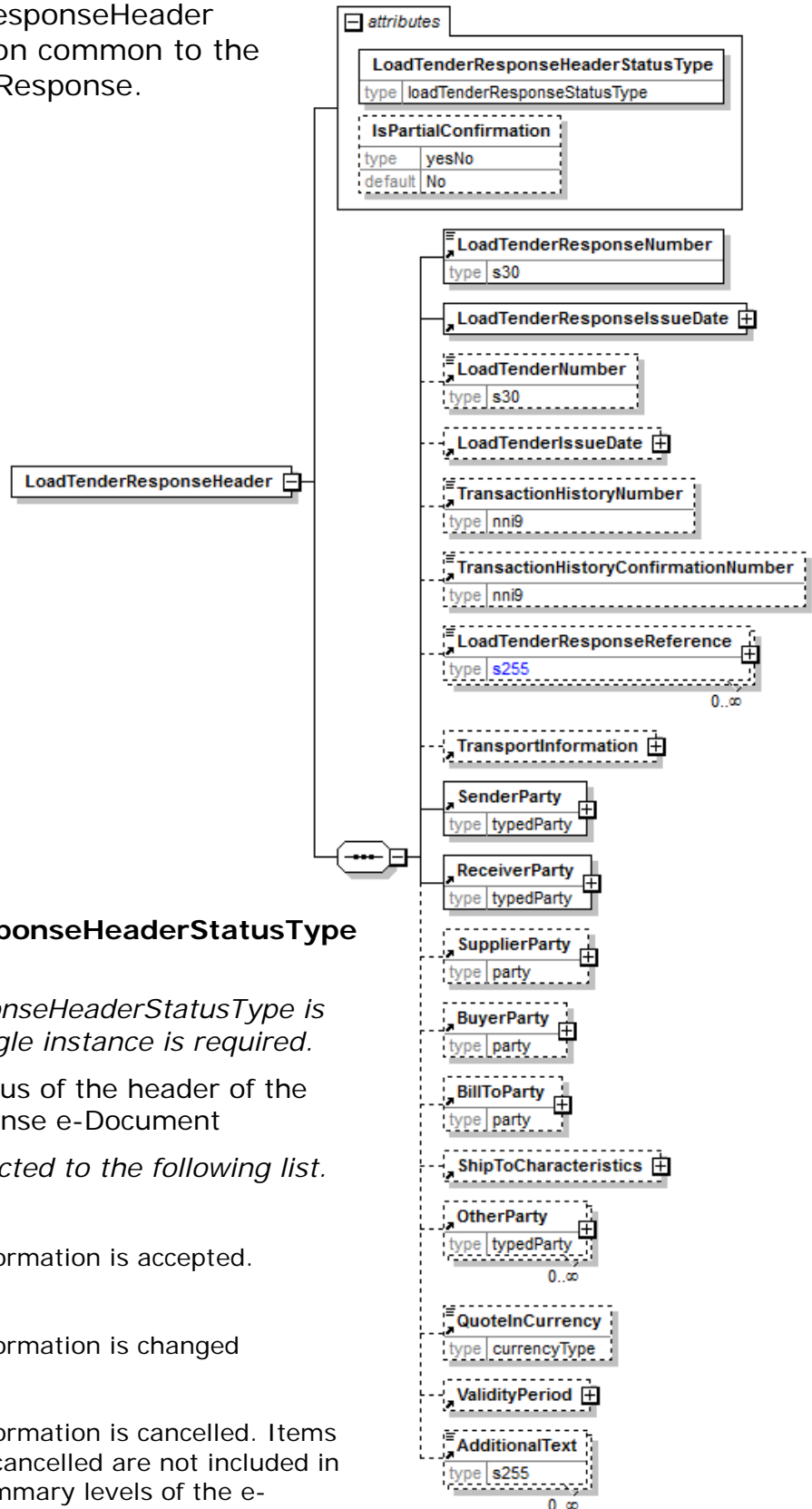

#### LoadTenderResponseHeaderStatusType [attribute]

*LoadTenderResponseHeaderStatusType is mandatory. A single instance is required.*

Identifies the status of the header of the LoadTenderResponse e-Document

*This item is restricted to the following list.*

**Accepted**

The supplied information is accepted.

**Amended**

The supplied information is changed

**Cancelled**

The supplied information is cancelled. Items that have been cancelled are not included in totals on the summary levels of the e-Document.

**Pending**

# LoadTender

## papiNet Standard - Version 2.31

---

The supplied information of the document item is being investigated.

### **Rejected**

The supplied information is rejected.

### **IsPartialConfirmation [attribute]**

*IsPartialConfirmation is optional. A single instance is might exist.*

Specifies if the confirmation is a partial confirmation or not, e.g. confirmation of one segment only. Default value is No.

*This item is restricted to the following list.*

**Yes**

**No**

### **(sequence)**

*The contents of (sequence) are mandatory. A single instance is required.*

### **LoadTenderResponseNumber**

*LoadTenderResponseNumber is mandatory. A single instance is required.*

The identifier for the LoadTenderResponse e-Document

### **LoadTenderResponseIssueDate**

*LoadTenderResponseIssueDate is mandatory. A single instance is required.*

The date when the e-Document was issued.

### **LoadTenderNumber**

*LoadTenderNumber is optional. A single instance might exist.*

The identifier for the LoadTender b-business document.

### **LoadTenderIssueDate**

*LoadTenderIssueDate is optional. A single instance might exist.*

The date when the e-Document was issued.

### **TransactionHistoryNumber**

*TransactionHistoryNumber is optional. A single instance might exist.*

A sequential number that keeps track of the version of a document being sent by the document originator except in the case where TransactionHistoryConfirmation is used, in which case the TransactionHistoryNumber refers to the trigger transaction for which the confirmation is being sent.

### **TransactionHistoryConfirmationNumber**

*TransactionHistoryConfirmationNumber is optional. A single instance might exist.*

A sequential number that indicates the version of the confirmation document being sent.

### **LoadTenderResponseReference**

*LoadTenderResponseReference is optional. Multiple instances might exist.*

An item detailing relevant references pertaining to the LoadTenderResponse. The type of reference is identified by the LoadTenderReferenceType attribute.

### **TransportInformation**

*TransportInformation is optional. A single instance might exist.*

# LoadTender

## papiNet Standard - Version 2.31

---

A grouping element for transport information.

### **SenderParty**

*SenderParty is mandatory. A single instance is required.*

The business entity issuing the business document, the source of the document.

- This is the same entity as the "From" party in the ebXML message service envelope. The entity responsible for the content. If the sender party has outsourced the transmission function to a third party the sender party is the original party not the party performing the transmission service.

### **ReceiverParty**

*ReceiverParty is mandatory. A single instance is required.*

The business entity for whom the business document is intended, the destination of the document.

- This is the same entity as the "To" party in the ebXML message service envelop. The entity interested in the content. If the receiver party has outsourced the message receipt function to a third party the receiver party is the intended party not the party performing the receiving process.

### **SupplierParty**

*SupplierParty is optional. A single instance might exist.*

The organisation or business entity responsible for providing the product.

SupplierParty is also the seller of the product, if Seller is not specified as OtherParty = Seller.

### **BuyerParty**

*BuyerParty is optional. A single instance might exist.*

The legal entity to which the product is sold. Also commonly referred to as the sold-to party or customer. If no OtherParty is defined as the Payer, the Buyer is the Payer.

### **BillToParty**

*BillToParty is optional. A single instance might exist.*

The address where the invoice is to be sent.

### **ShipToCharacteristics**

*ShipToCharacteristics is optional. A single instance might exist.*

A group item that provides information important for the Ship-To Party.

A group item that provides information important for the Ship-To Party. ShipToCharacteristics may be referenced at both the header and line item level. The reference at the header is required and acts as a default for the value at the line level, unless overridden at the line level.

### **OtherParty**

*OtherParty is optional. Multiple instances might exist.*

An organisation or business entity other than those specifically detailed within a business document.

### **QuoteInCurrency**

*QuoteInCurrency is optional. A single instance might exist.*

Indicates that the quote is to be provided in the currency specified.

### **ValidityPeriod**

# LoadTender

## papiNet Standard - Version 2.31

---

---

*ValidityPeriod is optional. A single instance might exist.*

The validity period for a specific item, e.g. the validity period for an e-document.

### **AdditionalText**

*AdditionalText is optional. Multiple instances might exist.*

A text field that is used to communicate information not previously defined or for special instructions. To be used only for circumstances not covered by specific elements.

# LoadTender

## papiNet Standard - Version 2.31

### LoadTenderResponseSegment

The details for a particular load segment.

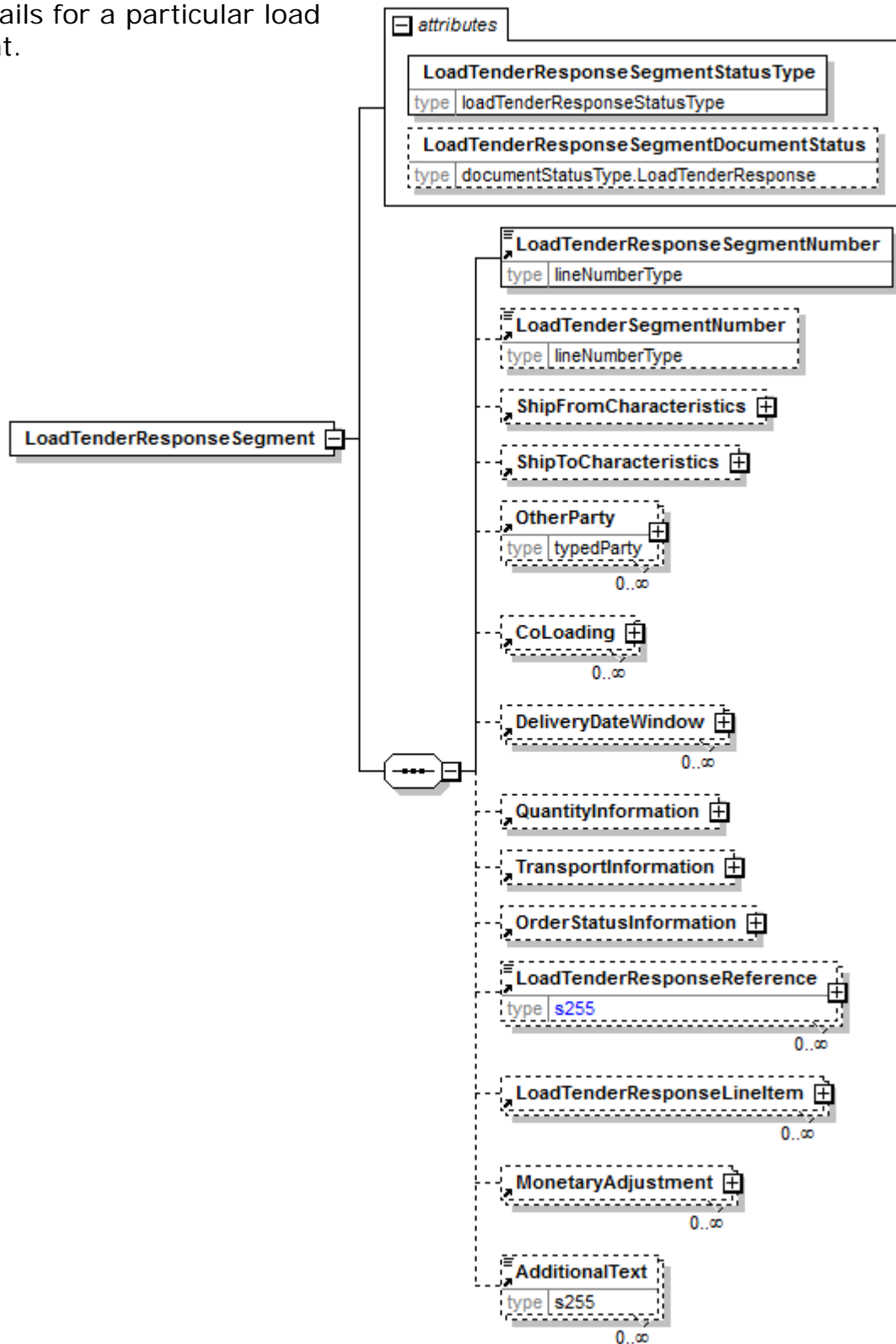

#### LoadTenderResponseSegmentStatusType [attribute]

*LoadTenderResponseSegmentStatusType* is mandatory. A single instance is required.

Identifies the status of the LoadTender segment.



# LoadTender

## papiNet Standard - Version 2.31

---

*This item is restricted to the following list.*

### **Accepted**

The supplied information is accepted.

### **Amended**

The supplied information is changed

### **Cancelled**

The supplied information is cancelled. Items that have been cancelled are not included in totals on the summary levels of the e-Document.

### **Pending**

The supplied information of the document item is being investigated.

### **Rejected**

The supplied information is rejected.

## **LoadTenderResponseSegmentDocumentStatus [attribute]**

*LoadTenderResponseSegmentDocumentStatus is optional. A single instance might exist.*

Defines the actual document status for the LoadTenderResponseSegment.

*This item is restricted to the following list.*

### **Cancelled**

The supplied information of the document item is cancelled. Items that have been cancelled are not included in totals on the summary level of e-documents.

### **Confirmed**

The supplied information of the document item is agreed. If a requested change or cancellation of an existing document item can not be accepted, then the earlier agreed information of the document item will be re-confirmed.

### **Pending**

The supplied information of the document item is being investigated.

### **Rejected**

The supplied information of the document item can not be accepted. The document item is new or not earlier confirmed.

## **(sequence)**

*The sequence of items below is mandatory. A single instance is required.*

### **LoadTenderResponseSegmentNumber**

*LoadTenderResponseSegmentNumber is mandatory. A single instance is required.*

The identifier for the LoadTenderResponse segment.

### **LoadTenderSegmentNumber**

*LoadTenderSegmentNumber is optional. A single instance might exist.*

The identifier for the LoadTender segment.

### **ShipFromCharacteristics**

*ShipFromCharacteristics is optional. A single instance might exist.*

A group item that provides information pertaining to the Ship-From Party.

# LoadTender

## papiNet Standard - Version 2.31

---

ShipFromCharacteristics may be referenced at both the header and line item level. The reference at the header, if it exists, acts as a default for the value at the line level, unless overridden at the line level.

### **ShipToCharacteristics**

*ShipToCharacteristics is optional. A single instance might exist.*

A group item that provides information important for the Ship-To Party.

A group item that provides information important for the Ship-To Party. ShipToCharacteristics may be referenced at both the header and line item level. The reference at the header is required and acts as a default for the value at the line level, unless overridden at the line level.

### **OtherParty**

*OtherParty is optional. Multiple instances might exist.*

An organisation or business entity other than those specifically detailed within a business document.

### **CoLoading**

*CoLoading is optional. Multiple instances might exist.*

A group item specifying information about items to be loaded or loaded on the same transport unit.

Used to identify:

- Delivery together to the drop point
- Transport Orders stuffed together in a container
- Transport Orders not splittable

### **DeliveryDateWindow**

*DeliveryDateWindow is optional. Multiple instances might exist.*

A group item defining the date/time interval for delivery to take place. An element which may contain the estimated date for which delivery is expected. This date is not absolute.

### **QuantityInformation**

*QuantityInformation is optional. A single instance might exist.*

A group item containing information about quantity and informational quantity of similar items.

### **TransportInformation**

*TransportInformation is optional. A single instance might exist.*

A grouping element for transport information.

### **OrderStatusInformation**

*OrderStatusInformation is optional. A single instance might exist.*

A group element that stores two levels of Order status codes.

### **LoadTenderResponseReference**

*LoadTenderResponseReference is optional. Multiple instances might exist.*

An item detailing relevant references pertaining to the LoadTenderResponse. The type of reference is identified by the LoadTenderReferenceType attribute.

### **LoadTenderResponseLineItem**

# LoadTender

## papiNet Standard - Version 2.31

---

*LoadTenderResponseLineItem is optional. Multiple instances might exist.*

The details for a particular load line item.

### MonetaryAdjustment

*MonetaryAdjustment is optional. Multiple instances might exist.*

The element containing the information necessary for the understanding, calculation, and treatment of an adjustment to a currency amount. MonetaryAdjustment contains an attribute that indicates they type of adjustment being communicated.

### AdditionalText

*AdditionalText is optional. Multiple instances might exist.*

A text field that is used to communicate information not previously defined or for special instructions. To be used only for circumstances not covered by specific elements.

---

## LoadTenderResponseLineItem

The details for a particular load line item.

**(sequence)**

*The sequence of items below is mandatory. A single instance is required.*



# LoadTender

## papiNet Standard - Version 2.31

---

### **LoadTenderResponseLineItemNumber**

*LoadTenderResponseLineItemNumber is mandatory. A single instance is required.*

The sequential number that uniquely identifies the LoadTenderResponse line item.

### **SupplierParty**

*SupplierParty is optional. A single instance might exist.*

The organisation or business entity responsible for providing the product.

SupplierParty is also the seller of the product, if Seller is not specified as OtherParty = Seller.

### **Product**

*Product is optional. A single instance might exist.*

Product is a group item defining the article and its characteristics. Product is used to specify product characteristics organized by ProductIdentifier, ProductDescription, and Classification. Book Manufacturing, Label Stock, Paper, Pulp, Recovered Paper, Wood Products, and Virgin Fibre market segments have defined their product characteristics and conversion features for implementation in papiNet.

### **QuantityInformation**

*QuantityInformation is mandatory. A single instance is required.*

A group item containing information about quantity and informational quantity of similar items.

### **LoadTenderLineItemBaseAmountInformation**

*LoadTenderLineItemBaseAmountInformation is optional. A single instance might exist.*

Group element used to detail the LoadTender Line Item's PriceDetails and TotalAmount. Normally used to identify the PricePerUnit of the line item.

### **MonetaryAdjustment**

*MonetaryAdjustment is optional. Multiple instances might exist.*

The element containing the information necessary for the understanding, calculation, and treatment of an adjustment to a currency amount.

MonetaryAdjustment contains an attribute that indicates they type of adjustment being communicated.

### **LoadTenderLineItemAmount**

*LoadTenderLineItemAmount is optional. A single instance might exist.*

Total Amount of the LoadTenderLineItem including adjustments and tax (when tax is specified on the load tender line item).

LoadTenderLineItemAmount is equal to the LoadTenderAmount plus the sum of the signed values of the MonetaryAdjustmentAmount for all instances of MonetaryAdjustment.

### **PackageInformation**

*PackageInformation is optional. Multiple instances might exist.*

The purpose of the PackageInformation structure is to clearly identify physical handling items that constitute the delivery.

PackageInformation is the highest level of product packaging it describes the shipping or warehousing unit.

- If you are communicating a package, usually for logistics or transport

# LoadTender

## papiNet Standard - Version 2.31

---

purposes, you should include the PackageType, Identifier, ItemCount, and Quantity. (Note: you still have the ability to describe the item with one of the "named" items.)

- If you are communicating one of the named Items there is no need to include PackageType, Identifier, ItemCount, and Quantity.

Since either of these two approaches can be used the entire contents of this element are optional even though the parent may be required. It is expected that you will fill in the appropriate details.

### **LengthSpecification**

*LengthSpecification is optional. Multiple instances might exist.*

Length specification of the wood product.

### **LoadTenderResponseReference**

*LoadTenderResponseReference is optional. Multiple instances might exist.*

An item detailing relevant references pertaining to the LoadTenderResponse. The type of reference is identified by the LoadTenderReferenceType attribute.

### **OtherParty**

*OtherParty is optional. Multiple instances might exist.*

An organisation or business entity other than those specifically detailed within a business document.

### **SafetyAndEnvironmentalInformation**

*SafetyAndEnvironmentalInformation is optional. Multiple instances might exist.*

Name of certification type, if any, on the goods (For example, FSC, PEFC). SafetyAndEnvironmental needs a value or measurement to communicate the percentage of the product is certified (for example, 75% is certified by the indicated agency).

## MonetaryAdjustment

The element containing the information necessary for the understanding, calculation, and treatment of an adjustment to a currency amount. MonetaryAdjustment contains an attribute that indicates they type of adjustment being communicated.

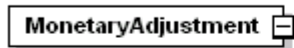

### AdjustmentType [attribute]

*AdjustmentType is mandatory. A single instance is required.*

Describes the type of adjustment applied to a monetary oriented element. Adjustment values should always be given as negative or positive adjustments even if AdjustmentType indicates the sign. For example, a rebate of 1% on an invoice should be given as an adjustment percentage of -1%.

*This item is restricted to the following list.*

#### BillOfLadingCharge

An extra charge for creating a Bill of Lading.

#### CancellationCharge

A charge applied because a cancellation was late (after the last date of change) and all or part of the ordered product has already been made.

#### CashDiscount

A reduction due to a discount applied.

#### CertificateCharge

An extra charge for creating a certificate. Some countries requires Certificates in which different characteristics of the delivery, transport unit, route, product, and others must be proved.

There are certificates for gasen pallets, for the place of production, for the age of the ship/vessel, for not departing from one country's harbour when delivering to another.

#### ChargesForward

A pending invoice amount brought forward from a previous Invoice.

#### ClaimAdjustment

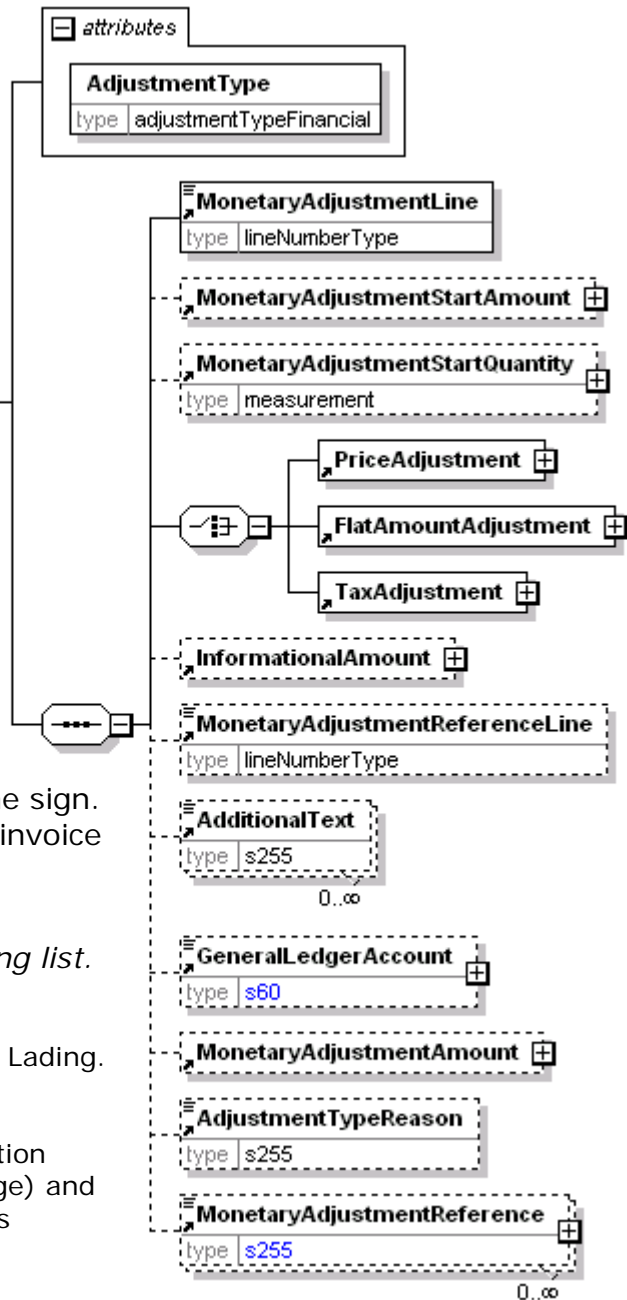

# LoadTender

## papiNet Standard - Version 2.31

---

---

An adjustment related to a filed complaint.

### **Commission**

Commission costs paid to the trading agency or trader.

### **CompetitiveAllowance**

An allowance provided for competitive reasons.

### **CongestionCharge**

An extra fee from ports for waiting time of ships in ports, railcars on a siding, trucks at a dock. (Synonym: Demurrage.)

### **ConsigneeUnloadCharge**

An unloading charge that is the responsibility of the consignee.

### **ContractAllowance**

An allowance for a volume discount, usually because the agreed amount has been exceeded.

### **CurrencyAdjustmentCharge**

An extra fee to adjust for currency variations.

### **DecimalRounding**

Adjustments for rounding of amounts to fit the business agreement or national monetary legislation. This adjustment is typically used for decimal rounding of amounts not including tax.

N.B. Use InformationalAmount with AmountType "DecimalRounding" for specification of decimal rounding of amounts including tax.

### **DefectiveAllowance**

An allowance provided for defective material.

### **DeliveryCharge**

The charge for delivering the product.

### **DeliveryNonConformanceAllowance**

An allowance due to non-conformance with the purchase agreement regarding a delivery.

### **DeliveryTimeBonus**

A bonus given for deliveries of products within a certain time period.

### **EarlyShipAllowance**

An allowance due to a delivery that took place earlier than planned. The seller may be charged a penalty. If this is found before issuing the Invoice, it can be handled through this allowance. If found later, it will be handled through a credit note.

### **EnergySurcharge**

A charge related to increases in the cost of energy.

### **Environmental**

An allowance applied due to environmental regulations.

### **ExpeditedShipmentCharge**

An extra cost charged due to unexpected or emergency requirements (for example, breaking off a run in the mill to reach the production date for a rush order).

# LoadTender

## papiNet Standard - Version 2.31

---

---

### **ExportClearanceCharge**

An extra fee for customs administration.

### **FlatRateCharge**

A general flat charge.

### **FreightAllowance**

The freight cost allowed by the mill. This amount is negative, and will be deducted from the Invoice (U.S. business practice, in the European Union (EU), use only Freight Charge).

### **FreightCharge**

The actual cost incurred to deliver the product. This amount is positive, and will be added to the Invoice.

### **FuelAdjustmentCharge**

An extra fee, usually from shipping companies, to adjust fuel prices.

### **HandlingCharge**

A charge related to the handling of the product.

### **Inspection**

The cost associated with performing an inspection of the product.

### **InterestCharge**

A charge applied for interest on overdue payments.

### **LabourAllowance**

An allowance due to additional labour required in the use or acceptance of the product.

### **LabourCharge**

A charge due to additional labour required in the use or acceptance of the product.

### **LoggingDamage**

An adjustment caused by logging damages on Forest Wood products. Logging damages normally cause a reduction of the product price.

### **LotCharge**

A charge applied to the lot of material.

### **MetalDetection**

A charge for additional metal detection applied to the goods.

### **ModelHomeDiscount**

A discount associated with the building of the model home.

### **NewStoreCouponDiscount**

A discount associated with entry into a new store.

### **OrderQuantity**

A charge or allowance for small/big ordered quantities.

### **PalletCharge**

A charge that represents the cost or rental of the pallet.

### **PickUpAllowance**



# LoadTender

## papiNet Standard - Version 2.31

---

---

An allowance provided to compensate for the cost of picking up the product.

### **PromotionalAllowance**

An allowance provided for the promotion of the product.

### **PromotionalCharge**

A charge associated with the promotion of the product.

### **PriceCorrection**

An adjustment associated with a correction of the product's price.

### **ProductionSetUpCharge**

A special charge applied due to specific buyer requests.

### **Provision**

The act of making ready or equipping for use.

### **Rebate**

A rebate accepted by the buyer and seller based on the agreed price and volume.

### **ReelDiscount**

An allowance for purchasing reels instead of sheets.

### **ReturnedLoadAllowance**

An allowance applied due to the return of the load.

### **ReturnLoadCharge**

A charge applied due to the return of the load.

### **RoadFeeCharge**

A freight charge for a special tax applied to road transports in some countries, e.g. Germany

### **ScrapAndDunnageCharge**

A charge that represents the scrapping of the material and its removal.

### **ServiceCharge**

A charge associated with a miscellaneous service.

### **SpecialConversionCharge**

Additional charge for a special conversion of the product.

### **SpecialDeliveryCharge**

A special charge for delivering the product differently from the usual or agreed-to method.

### **SpecialHandlingCharge**

A special charge for handling the product differently from the usual or agreed-to method.

### **SpecialPackagingCharge**

A special charge for packaging the product differently from the usual or agreed-to method, or if packaging as requested is out of spec.

### **StopOffAllowance**

An allowance for a delivery stop-off.

### **StopOffCharge**

# LoadTender

## papiNet Standard - Version 2.31

---

---

A charge for a delivery stop-off.

### **StorageAllowance**

An allowance for storing the product.

### **StorageCharge**

An extra cost charged for storing the product on location (in the plant).

### **Tax**

An adjustment that reflects a tax item.

### **TestingCharge**

A charge related to testing a paper grade.

### **TradeDiscount**

A discount based on the terms of the trade given on the agreed price. Usually a percentage.

### **TrialDiscount**

A discount applied for a trial run of a new or improved product.

### **TransferCharge**

A freight charge incurred by the goods transfer from one location to another location not previously agreed upon.

### **UnloadingAllowance**

An allowance to compensate for the unloading the product.

### **UnloadingCharge**

A charge for the unloading the product.

### **VolumeDiscount**

A rebate accepted by the buyer and the seller based on the agreed volume

### **WarRiskCharge**

An extra fee from transport companies for transport units that cross war zones.

### **Other**

Any other adjustment not covered by the attribute list.

### **(sequence)**

*The sequence of items below is mandatory. A single instance is required.*

### **MonetaryAdjustmentLine**

*MonetaryAdjustmentLine is mandatory. A single instance is required.*

A sequence number indicating the order of printing or the sequence in which a group of adjustments are to be considered.

### **MonetaryAdjustmentStartAmount**

*MonetaryAdjustmentStartAmount is optional. A single instance might exist.*

The beginning currency amount used in the calculation of a monetary adjustment.

### **MonetaryAdjustmentStartQuantity**

*MonetaryAdjustmentStartQuantity is optional. A single instance might exist.*

The beginning quantity used in the calculation of a monetary adjustment.

# LoadTender

## papiNet Standard - Version 2.31

---

### (choice)

*[choice] is optional because of choice construct.*

#### **PriceAdjustment**

*PriceAdjustment is optional because of choice construct.*

A group item defining a deviation from the PricePerUnit.

#### **FlatAmountAdjustment**

*FlatAmountAdjustment is optional because of choice construct.*

A group item that contains flat adjustment amount information.

#### **TaxAdjustment**

*TaxAdjustment is optional because of choice construct.*

This content element contains the necessary information to describe, calculate, and handle a tax adjustment.

#### **InformationalAmount**

*InformationalAmount is optional. A single instance might exist.*

A monetary amount used for information purposes only (not for calculation). For example, the invoice price adjustment subtotal is expressed in sterling pounds, and the buyer wants this information expressed in U.S. dollars.

- CreditDebitNote and Invoice - The TaxAmount is displayed in the currency that is applicable throughout the e-Document. When a TaxAmount needs to be displayed in a different national currency, this field is used.

#### **MonetaryAdjustmentReferenceLine**

*MonetaryAdjustmentReferenceLine is optional. A single instance might exist.*

A link to a previously defined MonetaryAdjustmentLine upon which this adjustment is based.

#### **AdditionalText**

*AdditionalText is optional. Multiple instances might exist.*

A text field that is used to communicate information not previously defined or for special instructions. To be used only for circumstances not covered by specific elements.

#### **GeneralLedgerAccount**

*GeneralLedgerAccount is optional. A single instance might exist.*

The general ledger account to be referenced for the item.

#### **MonetaryAdjustmentAmount**

*MonetaryAdjustmentAmount is optional. A single instance might exist.*

The actual amount of the monetary adjustment.

#### **AdjustmentTypeReason**

*AdjustmentTypeReason is optional. A single instance might exist.*

Provides additional information about the type of adjustment. Can be viewed as a sub-classification of the adjustment type attribute or as a textual explanation.

#### **MonetaryAdjustmentReference**

*MonetaryAdjustmentReference is optional. Multiple instances might exist.*

An element detailing relevant references pertaining to the MonetaryAdjustment as

# LoadTender papiNet Standard - Version 2.31

indicated by MonetaryAdjustmentReferenceType and AssignedBy.

## LoadTenderResponseSummary

Summary information that applies to the entire LoadTenderResponse e-Document

**(sequence)**

*The contents of (sequence) are mandatory. A single instance is required.*

### TotalQuantityInformation

*TotalQuantityInformation is optional. Multiple instances might exist.*

A group item containing information about the total quantity and total informational quantity of similar items in the document. TotalQuantityInformation is primarily used in the summary section of e-Documents where it is repeatable to permit totalling for different units of measure.

### LineItemSubTotal

*LineItemSubTotal is optional. A single instance might exist.*

The total amount of all base amounts on e-Document line items. The base amount contains the result of the calculation quantity times the base unit price. As such it does not include any taxes. For example, in an Invoice claiming payment for products LineItemSubTotal is equal to the sum of all InvoiceLineBaseAmount.

### TotalAdjustments

*TotalAdjustments is optional. A single instance might exist.*

The CurrencyValue of TotalAdjustments contains the total of all adjustments and charges excluding tax. For example, in the Invoice TotalAdjustments is equal to the sum of the signed values of the MonetaryAdjustmentAmount for all instances of MonetaryAdjustment with PriceAdjustment and FlatAmountAdjustment and plus the sum of the signed values of the ChargeNetAmount for all instances of ChargeInformation.

### TotalTaxAmount

*TotalTaxAmount is optional. A single instance might exist.*

The CurrencyValue of TotalTaxAmount contains the sum of all instances of TaxAdjustment in the document. TotalTaxAmount contains the sum of all instances of the MonetaryAdjustmentAmount for tax adjustments.

### TotalNetAmount

*TotalNetAmount is optional. A single instance might exist.*

A field containing total amount excluding tax. For example, in the Invoice TotalNetAmount is equal to the sum of LineItemSubTotal plus TotalAdjustments. TotalNetAmount encapsulates CurrencyValue.

### TotalAmount

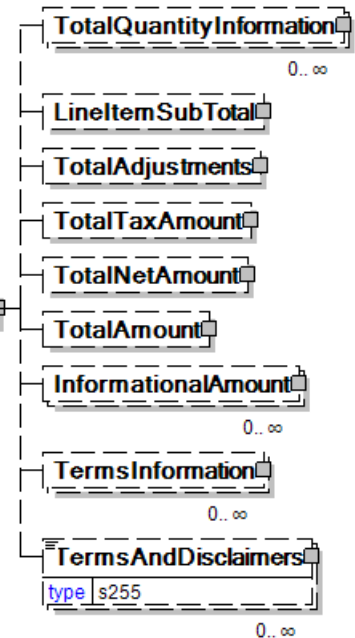

# LoadTender

## papiNet Standard - Version 2.31

---

---

*TotalAmount is optional. A single instance might exist.*

The total amount including tax.

In e-Documents claiming payment this is the amount due for payment based on the terms of payment. Decimal rounding might be applied to this amount.

### **InformationalAmount**

*InformationalAmount is optional. Multiple instances might exist.*

A monetary amount used for information purposes only (not for calculation). For example, the invoice price adjustment subtotal is expressed in sterling pounds, and the buyer wants this information expressed in U.S. dollars.

- CreditDebitNote and Invoice - The TaxAmount is displayed in the currency that is applicable throughout the e-Document. When a TaxAmount needs to be displayed in a different national currency, this field is used.

### **TermsInformation**

*TermsInformation is optional. Multiple instances might exist.*

An element that contains the term related information.

### **TermsAndDisclaimers**

*TermsAndDisclaimers is optional. Multiple instances might exist.*

An element that contains legal information with an indication of what the Language is.

# LoadTender papiNet Standard - Version 2.31

## LoadTender Business Scenarios

### LoadTender and LoadTenderResponse Scenario Listing

#### Frequently-used Scenarios

<b>Scenario A</b>	Transportation from consignor to consignee
<b>Scenario B</b>	Transportation from consignor to several consignee
<b>Scenario C</b>	Pre-booking request (for price/vessel/dates/quantity etc.)
<b>Scenario D</b>	LoadTender for a transportation from consignor to consignee

#### Less Frequently-used Scenarios

<b>Scenario E</b>	Transportation from several consignors to consignee
<b>Scenario F</b>	Transportation from consignor to consignee including return transportation information
<b>Scenario G</b>	Multi leg and multi mode transportation
<b>Scenario H</b>	Container shipment
<b>Scenario I</b>	Break bulk shipment
<b>Scenario J</b>	On-carriage
<b>Scenario K</b>	Transport from consignor to consignee for certain goods (length specification)
<b>Scenario L</b>	Alternative routing (proposals from carrier)
<b>Scenario M</b>	Web portal
<b>Scenario N</b>	Price adjustments (stock keeping costs)
<b>Scenario O</b>	Co-loading
<b>Scenario P</b>	Order status information

#### Scenario A

<b>e-Document</b>	LoadTender
<b>Type</b>	Booking / BookingConfirmation
<b>Scenario</b>	(direct) transportation from consignor to consignee
<b>Outcome</b>	Goods booked with selected carrier
<b>Initiator</b>	Consignor/Broker
<b>Receiver</b>	Carrier

## LoadTender papiNet Standard - Version 2.31

<b>Trigger</b>	Delivery Instruction , Call off or sales order, replenishment
<b>Step 1.</b>	Booking requestor sends <ul style="list-style-type: none"> <li>• Loading location</li> <li>• Requested Loading Date</li> <li>• Country</li> <li>• Destination</li> <li>• Delivery Date&amp;Time</li> <li>• Reference</li> <li>• Name and address of receiver Product</li> <li>• Loading instructions</li> <li>• Type of vehicle</li> <li>• Free text instructions</li> <li>• Total weight</li> <li>• Total amount</li> </ul>
<b>Results</b>	Booking confirmation is sent from the carrier to the requestor

### Scenario B

<b>e-Document</b>	LoadTender
<b>Type</b>	Booking / BookingConfirmation
<b>Scenario</b>	Transportation from consignor to several consignee
<b>Outcome</b>	Goods booked with selected carrier
<b>Initiator</b>	Consignor/Broker
<b>Receiver</b>	Carrier
<b>Trigger</b>	Delivery Instruction , Call off or sales order, replenishment
<b>Step 1.</b>	This Scenario is similar to Scenario A with that difference that there is more than one consignee. Some data needs to be repeated.  Booking requestor sends <ul style="list-style-type: none"> <li>• Loading location</li> <li>• Requested Loading Date</li> <li>• Country</li> <li>• Destination</li> <li>• Delivery Date&amp;Time</li> <li>• Reference</li> <li>• Name and address of receiver</li> </ul>

## LoadTender papiNet Standard - Version 2.31

	<ul style="list-style-type: none"> <li>• Product</li> <li>• Loading instructions</li> <li>• Type of vehicle</li> <li>• Free text instructions</li> <li>• Total weight</li> <li>• Total amount</li> <li>• Bill-to Party</li> </ul>
<b>Results</b>	Booking confirmation is sent from the carrier to the requestor

### Scenario C

<b>e-Document</b>	LoadTender
<b>Type</b>	PreBooking / PreBookingConfirmation
<b>Scenario</b>	Pre-booking request (for price/vessel space / truck space / train space /dates/quantity etc.)
<b>Outcome</b>	Basis for booking
<b>Initiator</b>	Consignor/Broker
<b>Receiver</b>	Carrier/Haulier
<b>Trigger</b>	Delivery Request
<b>Step 1.</b>	PreBooking request information is sent to the carrier/haulier
<b>Step 2.</b>	Carrier/haulier calculates request
<b>Results</b>	Booking request reply is sent from the Carrier/Haulier to the requestor (pre booking confirmation)

### Scenario D

<b>e-Document</b>	LoadTender
<b>Type</b>	LoadTender / LoadTenderResponse
<b>Scenario</b>	LoadTender for a transportation from consignor to consignee
<b>Outcome</b>	Price information
<b>Initiator</b>	Consignor/Broker
<b>Receiver</b>	Carrier
<b>Preconditions</b>	What exists prior to the start?
<b>XML File</b>	The name of any sample file.



## LoadTender papiNet Standard - Version 2.31

<b>Trigger</b>	Delivery Instruction , Call off or sales order, replenishment
<b>Step 1.</b>	Booking requestor sends <ul style="list-style-type: none"> <li>• Loading location</li> <li>• Requested Loading Date</li> <li>• Country</li> <li>• Destination</li> <li>• Delivery Date&amp;Time</li> <li>• Reference</li> <li>• Name and address of receiver</li> <li>• Product</li> <li>• Loading instructions</li> <li>• Type of vehicle</li> <li>• Free text instructions</li> <li>• Total weight</li> <li>• Total amount</li> <li>• Bill-to party</li> </ul>
<b>Results</b>	LoadTenderResponse including price information

### Scenario E

<b>e-Document</b>	LoadTender
<b>Type</b>	Booking / BookingConfirmation
<b>Scenario</b>	Transportation from several consignors to consignee
<b>Outcome</b>	Goods booked with selected carrier
<b>Initiator</b>	Consignor/Broker
<b>Receiver</b>	Carrier
<b>Trigger</b>	Delivery Instruction , Call off or sales order, replenishment
<b>Step 1.</b>	This Scenario is similar to Scenario A with that difference that there is more than one pickup. Some data needs to be repeated.  Booking requestor sends <ul style="list-style-type: none"> <li>• Loading location</li> <li>• Requested Loading Date</li> <li>• Country</li> <li>• Destination</li> <li>• Delivery Date&amp;Time</li> <li>• Reference</li> </ul>

## LoadTender papiNet Standard - Version 2.31

	<ul style="list-style-type: none"> <li>• Name and address of receiver</li> <li>• Product</li> <li>• Loading instructions</li> <li>• Type of vehicle</li> <li>• Free text instructions</li> <li>• Total weight</li> <li>• Total amount</li> <li>• Bill-to party</li> </ul>
<b>Results</b>	Booking confirmation is sent from the carrier to the requestor

### Scenario F

<b>e-Document</b>	LoadTender
<b>Type</b>	Booking / BookingConfirmation
<b>Scenario</b>	Transportation from consignor to consignee with return transportation
<b>Outcome</b>	Goods booked with selected carrier
<b>Initiator</b>	Consignor/Broker
<b>Receiver</b>	Carrier
<b>Preconditions</b>	What exists prior to the start?
<b>XML File</b>	The name of any sample file.
<b>Trigger</b>	Delivery Instruction , Call off or sales order, replenishment
<b>Step 1.</b>	<p>This Scenario is similar to Scenario A with that difference that there is also return transportation. Some data needs to be repeated.</p> <p>Booking requestor sends</p> <ul style="list-style-type: none"> <li>• Loading location</li> <li>• Requested Loading Date</li> <li>• Country</li> <li>• Destination</li> <li>• Delivery Date&amp;Time</li> <li>• Reference</li> <li>• Name and address of receiver</li> <li>• Product</li> <li>• Loading instructions</li> <li>• Type of vehicle</li> <li>• Free text instructions</li> <li>• Total weight</li> </ul>

## LoadTender papiNet Standard - Version 2.31

	<ul style="list-style-type: none"> <li>• Total amount</li> </ul>
<b>Results</b>	Booking confirmation is sent from the carrier to the requestor

### Scenario G

<b>e-Document</b>	LoadTender
<b>Type</b>	Booking / BookingConfirmation
<b>Scenario</b>	Multi leg and multi mode transportation
<b>Outcome</b>	Goods booked with selected carrier
<b>Initiator</b>	Consignor/Broker
<b>Receiver</b>	Carrier
<b>Preconditions</b>	What exists prior to the start?
<b>XML File</b>	The name of any sample file.
<b>Trigger</b>	Delivery Instruction , Call off or sales order, replenishment
<b>Step 1.</b>	<p>In this scenario a trailer should be delivered from place A to B which can include several legs and transport modes. Some data needs to be repeated.</p> <p>Booking requestor sends</p> <ul style="list-style-type: none"> <li>• Loading location</li> <li>• Requested Loading Date</li> <li>• Country</li> <li>• Destination</li> <li>• Delivery Date&amp;Time</li> <li>• Reference</li> <li>• Name and address of receiver</li> <li>• Product</li> <li>• Loading instructions</li> <li>• Type of trailer</li> <li>• Free text instructions</li> <li>• Total weight</li> <li>• Total amount</li> <li>• Bill-to party</li> </ul>
<b>Results</b>	Booking confirmation is sent from the carrier to the requestor

### Scenario H

<b>e-Document</b>	LoadTender
-------------------	------------

**LoadTender**  
**papiNet Standard - Version 2.31**

<b>Type</b>	Booking / BookingConfirmation
<b>Scenario</b>	Container shipment (Vessel booking)
<b>Outcome</b>	Container reservation for a certain time period
<b>Initiator</b>	Consignor/Broker
<b>Receiver</b>	Carrier
<b>Preconditions</b>	What exists prior to the start?
<b>XML File</b>	The name of any sample file.
<b>Trigger</b>	Delivery Instruction , Call off or sales order , replenishment
<b>Step 1.</b>	<p>PreBooking information is sent to the carrier</p> <ul style="list-style-type: none"> <li>• Amount of containers</li> <li>• Type of container</li> <li>• Container reservation for a certain time period</li> <li>• Loading location</li> <li>• Booking reference</li> </ul> <p>SubCarrier or Forwarder is used in OtherParty to identify the transport vehicle and/or containers required.</p>
<b>Step 2.</b>	<p>Booking information is sent to the carrier with detailed ready to loading instruction</p> <ul style="list-style-type: none"> <li>• Amount of containers</li> <li>• Type of container</li> <li>• Loading time</li> <li>• Loading location</li> <li>• Booking reference</li> </ul>
<b>Results</b>	Booking confirmation is sent from the carrier to the requestor

**Scenario I**

<b>e-Document</b>	LoadTender
<b>Type</b>	PreBooking / PreBookingConfirmation / Booking / BookingConfirmation
<b>Scenario</b>	Break bulk shipment (Vessel booking)
<b>Outcome</b>	Goods booked as break bulk cargo with selected carrier
<b>Initiator</b>	Consignor/Broker

## LoadTender papiNet Standard - Version 2.31

<b>Receiver</b>	Carrier
<b>Preconditions</b>	What exists prior to the start?
<b>XML File</b>	The name of any sample file.
<b>Trigger</b>	Delivery Request
<b>Step 1.</b>	<p>Preliminary booking information is sent to the carrier</p> <ul style="list-style-type: none"> <li>• Amount/Weight/Dimensions of goods</li> <li>• Destination port</li> <li>• Ready for loading</li> <li>• Arrival date request</li> <li>• Storage request</li> <li>• Loading instructions</li> <li>• Loading location</li> <li>• Booking reference</li> </ul>
<b>Step 2.</b>	<p>Carrier takes booking information in preliminary delivery plan and reserves space and equipment for the shipment. Carrier send LoadTenderResponse (Vessel Nomination) to the requestor (updates may happen more than once)</p>
<b>Step 3.</b>	<p>Firm Booking information is sent to the carrier</p> <ul style="list-style-type: none"> <li>• Amount/Weight/Dimensions of goods</li> <li>• Destination port</li> <li>• Ready for loading</li> <li>• Arrival date request</li> <li>• Storage request</li> <li>• Loading instructions</li> <li>• Loading location</li> <li>• Booking reference</li> <li>• Vessel</li> </ul>
<b>Results</b>	Booking confirmation is sent from the carrier to the requestor

### Scenario J

<b>e-Document</b>	LoadTender
<b>Type</b>	Booking / BookingConfirmation
<b>Scenario</b>	On-carriage (Vessel booking)
<b>Outcome</b>	Goods booked to be delivered to consignee
<b>Initiator</b>	Consignor/Broker/Carrier

**LoadTender**  
**papiNet Standard - Version 2.31**

<b>Receiver</b>	Carrier/Haulier depending on agreement and transport mode
<b>Preconditions</b>	What exists prior to the start?
<b>XML File</b>	The name of any sample file.
<b>Trigger</b>	Delivery Instruction , Call off or sales order, replenishment
<b>Step 1.</b>	Booking information is sent to the carrier <ul style="list-style-type: none"> <li>• Amount of containers</li> <li>• Type of container</li> <li>• Destination Port</li> <li>• Ready for loading</li> <li>• Arrival date/time request (in port)</li> <li>• Final destination</li> <li>• Delivery plant</li> <li>• Booking reference</li> </ul>
<b>Step 2.</b>	Carrier/haulier takes booking information in delivery plan and reserves space and equipment for that transport
<b>Results</b>	Booking confirmation is sent from the Haulier to the requestor. If arranged by the carrier, no separate confirmation is sent.

**Scenario K**

<b>e-Document</b>	LoadTender
<b>Type</b>	Booking / BookingConfirmation
<b>Scenario</b>	Transport from consignor to consignee for certain goods (length specification)
<b>Outcome</b>	Goods (wood) booked to be delivered to loading port
<b>Initiator</b>	Consignor/Broker /Carrier
<b>Receiver</b>	Carrier/Haulier depending on agreement and transport mode
<b>Preconditions</b>	What exists prior to the start?
<b>XML File</b>	The name of any sample file.
<b>Trigger</b>	Delivery Instruction , Call off or sales order, replenishment
<b>Step 1.</b>	Booking information is sent to the carrier

## LoadTender papiNet Standard - Version 2.31

	<ul style="list-style-type: none"> <li>• Amount of containers</li> <li>• Type of container</li> <li>• Amount/Weight/Length/Dimensions of goods (wood)</li> <li>• Port</li> <li>• Ready for loading</li> <li>• Arrival date/time request (in port)</li> <li>• Loading instructions</li> <li>• Loading location</li> <li>• Booking reference</li> </ul>
<b>Step 2.</b>	Carrier/haulier takes booking information in delivery plan and reserves space and equipment for that transport
<b>Results</b>	Booking confirmation is sent from the Haulier/carrier to the requestor

### Scenario L

<b>e-Document</b>	LoadTender
<b>Type</b>	Booking / BookingConfirmation
<b>Scenario</b>	Transport booking from consignor to consignee, response includes alternative route (including price information)
<b>Outcome</b>	Confirmed Transport including different route
<b>Initiator</b>	Consignor/Broker
<b>Receiver</b>	Carrier
<b>Preconditions</b>	What exists prior to the start?
<b>XML File</b>	The name of any sample file.
<b>Trigger</b>	What starts the process?
<b>Step 1.</b>	<p>This Scenario is similar to Scenario B (multi leg) with that difference that the consignee propose a different transportation route (A – C – B instead of A – B – C).</p> <p>Booking requestor sends</p> <ul style="list-style-type: none"> <li>• Loading location</li> <li>• Requested Loading Date</li> <li>• Country</li> <li>• Destination</li> <li>• Delivery Date&amp;Time</li> <li>• Reference</li> </ul>

## LoadTender

### papiNet Standard - Version 2.31

	<ul style="list-style-type: none"> <li>• Name and address of receiver</li> <li>• Product</li> <li>• Loading instructions</li> <li>• Type of vehicle</li> <li>• Free text instructions</li> <li>• Total weight</li> <li>• Total amount</li> </ul>
<b>Step 2.</b>	Booking receiver sends information back (same date) but different structured (legs got switched).
<b>Results</b>	Automation of transport optimization

#### Scenario M

<b>e-Document</b>	LoadTender
<b>Type</b>	LoadTender / LoadTenderResponse
<b>Scenario</b>	LoadTenderResponse for a transportation from consignee to consignor. <ul style="list-style-type: none"> <li>• See Scenario D</li> </ul>
<b>Outcome</b>	Confirmed Transport
<b>Initiator</b>	Carrier
<b>Receiver</b>	Consignor/Broker/Carrier
<b>Preconditions</b>	What exists prior to the start?
<b>XML File</b>	The name of any sample file.
<b>Trigger</b>	Acceptance of Transport
<b>Step 1.</b>	Publishing of transport on web
<b>Step 2.</b>	Confirmation / Acceptance of Transport via web
<b>Step 3.</b>	Booking as well as Booking confirmation send to both parties including information of <ul style="list-style-type: none"> <li>• Loading location</li> <li>• Requested Loading Date</li> <li>• Country</li> <li>• Destination</li> <li>• Delivery Date&amp;Time</li> <li>• Reference</li> <li>• Name and address of receiver</li> <li>• Product</li> <li>• Loading instructions</li> <li>• Type of vehicle</li> </ul>



## LoadTender papiNet Standard - Version 2.31

	<ul style="list-style-type: none"> <li>• Free text instructions</li> <li>• Total weight</li> <li>• Total amount</li> <li>• Bill-to party</li> <li>• Confirmed / accepted price</li> </ul>
<b>Results</b>	Automation of web interface to both involved parties

### Scenario N

<b>e-Document</b>	LoadTender
<b>Type</b>	Booking / BookingConfirmation
<b>Scenario</b>	Transport booking from consignor to consignee, response includes alternative route (including price information)
<b>Outcome</b>	Confirmed Transport including different route
<b>Initiator</b>	Consignor/Broker
<b>Receiver</b>	Carrier
<b>Preconditions</b>	What exists prior to the start?
<b>XML File</b>	The name of any sample file.
<b>Trigger</b>	Delivery Instruction , Call off or sales order, replenishment
<b>Step 1.</b>	<p>This Scenario is similar to Scenario A including stock keeping / handling up charges</p> <p>Booking requestor sends</p> <ul style="list-style-type: none"> <li>• Loading location</li> <li>• Requested Loading Date</li> <li>• Country</li> <li>• Destination</li> <li>• Delivery Date&amp;Time</li> <li>• Reference</li> <li>• Name and address of receiver</li> <li>• Product</li> <li>• Loading instructions</li> <li>• Type of vehicle</li> <li>• Free text instructions</li> <li>• Total weight</li> <li>• Total amount</li> <li>• Bill-to party</li> </ul>
<b>Step 2.</b>	Booking receiver confirms transport including

## LoadTender papiNet Standard - Version 2.31

	price details and up charges (stock keeping/handling)
<b>Results</b>	Automation of transport optimization

### Scenario o

<b>e-Document</b>	LoadTender
<b>Type</b>	Booking / BookingConfirmation
<b>Scenario</b>	Transport booking from consignor to consignee including CoLoading instructions
<b>Outcome</b>	2 transport orders must get shipped at once
<b>Initiator</b>	Consignor/Broker
<b>Receiver</b>	Carrier
<b>Preconditions</b>	What exists prior to the start?
<b>XML File</b>	The name of any sample file.
<b>Trigger</b>	Delivery Instruction , Call off or sales order, replenishment
<b>Step 1.</b>	<p>This Scenario is similar to Scenario G including CoLoading instructions</p> <p>Booking requestor sends</p> <ul style="list-style-type: none"> <li>• Loading location</li> <li>• Requested Loading Date</li> <li>• Country</li> <li>• Destination</li> <li>• Delivery Date&amp;Time</li> <li>• Reference</li> <li>• CoLoading</li> <li>• Name and address of receiver</li> <li>• Product</li> <li>• Loading instructions</li> <li>• Type of vehicle</li> <li>• Free text instructions</li> <li>• Total weight</li> <li>• Total amount</li> <li>• Bill-to party</li> </ul>
<b>Results</b>	Booking receiver confirms transport

### Scenario P

<b>e-Document</b>	LoadTender
-------------------	------------

**LoadTender**  
**papiNet Standard - Version 2.31**

<b>Type</b>	Booking / BookingConfirmation
<b>Scenario</b>	Transport booking from consignor to consignee including order status information
<b>Outcome</b>	Shipment on hold (customer not paid in advance)
<b>Initiator</b>	Consignor/Broker
<b>Receiver</b>	Carrier
<b>Preconditions</b>	What exists prior to the start?
<b>XML File</b>	The name of any sample file.
<b>Trigger</b>	Delivery Instruction , Call off or sales order, replenishment
<b>Step 1.</b>	<p>This Scenario is similar to Scenario A including stock keeping / handling up charges</p> <p>Booking requestor sends</p> <ul style="list-style-type: none"> <li>• Loading location</li> <li>• Requested Loading Date</li> <li>• Country</li> <li>• Destination</li> <li>• Delivery Date&amp;Time</li> <li>• Reference</li> <li>• Name and address of receiver</li> <li>• Product</li> <li>• Loading instructions</li> <li>• Type of vehicle</li> <li>• Free text instructions</li> <li>• Total weight</li> <li>• Total amount</li> <li>• Bill-to party</li> <li>• Order status information (finished / on hold)</li> </ul>
<b>Results</b>	Booking receiver confirms planning.