



papiNet

MeasuringTicket

papiNet Standard - Version 2.31

Documentation

**Global Standard for the Paper and Forest
Products Supply Chain**

Build V2R31_20151026

Date 2015-10-28

Production Release

MeasuringTicket

papiNet Standard – Version 2.31

Copyright

Copyright 2000 - 2015 papiNet G.I.E (“papiNet”) and International Digital Enterprise Alliance, Inc. (“IDEAlliance”) collectively “Copyright Owner”. All rights reserved by the Copyright Owner under the laws of the United States, Belgium, the European Economic Community, and all states, domestic and foreign. This document may be downloaded and copied provided that all copies retain and display the copyright and any other proprietary notices contained in this document. This document may not be sold, modified, edited, or taken out of context such that it creates a false or misleading statement or impression as to the purpose or use of the papiNet specification, which is an open standard. Use of this Standard, in accord with the foregoing limited permission, shall not create for the user any rights in or to the copyright, which rights are exclusively reserved to the Copyright Owner.

papiNet, IDEAlliance, and the members of all papiNet Groups (collectively and individually, “Presenters”) make no representations or warranties, express or implied, including, but not limited to, warranties of merchantability, fitness for a particular purpose, title, or non-infringement. The presenters do not make any representation or warranty that the contents of this document are free from error, suitable for any purpose of any user, or that implementation of such contents will not infringe any third party patents, copyrights, trademarks or other rights. By making use of this document, the user assumes all risks and waives all claims against Presenters.

In no event shall Presenters be liable to user (or other person) for direct, indirect, special or consequential damages arising from or related to any use of this document, including, without limitation, lost profits, business interruption, loss of programs, or other data on your information handling system even if Presenters are expressly advised of the possibility of such damages.

Use of Documents in papiNet Implementations

Documents may be used as templates for a papiNet implementation. The Presenters grant the right to modify and edit them to fit an actual implementation project provided all copies display the copyright and any other proprietary notices contained in this document. Such modified documents must not be distributed beyond the trading partners implementing or maintaining a papiNet connection.

MeasuringTicket papiNet Standard – Version 2.31

Table of Contents

Copyright	2
Use of Documents in papiNet Implementations	2
Table of Contents	3
MeasuringTicket Documentation	4
MeasuringTicket e-Document Overview	4
The Scope of the MeasuringTicket	4
MeasuringTicketType [attribute]	5
Business Rules for MeasuringTicket	5
Processing the MeasuringTicket	6
Understanding the Diagrams and Content	7
MeasuringTicket Root Element	9
MeasuringTicket	9
Primary Elements	12
MeasuringTicketHeader	12
MeasuringTicketSequence	15
MeasuringTicketSequenceLineItem	19
MeasuringTicketSummary	21
MeasuringTicket Business Scenarios	23
MeasuringTicket Scenario Listing	23
Scenario A	25
Scenario B	27
Scenario C	28
Scenario D	31
Scenario E	32
Scenario F	35
Scenario G	38
Scenario H	39
Scenario I	43
Scenario J	45
Scenario K	46
Scenario L	47

MeasuringTicket

papiNet Standard – Version 2.31

MeasuringTicket Documentation

MeasuringTicket e-Document Overview

The MeasuringTicket e-Document specifies the details from measuring of items. Packages and loads can be measured as well as individual items in packages and loads. Products, Quantities and various measured properties can be reported. These measurements can be used as a base for calculation of billable products.

The MeasuringTicketType controls the usage of the MeasuringTicket e-Document. It can be used as a measuring ticket, a production ticket or a specification of an invoice as well as a report for calibration of measuring equipment and analysis of product samples.

The MeasuringTicket e-Document is typically used by the Forest Wood Supply business but can also be used by other businesses.

The Scope of the MeasuringTicket

The MeasuringTicket includes:

- Information about measuring location, measuring equipment and the party responsible for carrying out the measuring.
- The date when the measuring is done.
- Measuring Specification including measuring procedures that is a legal requirement in some countries.
- Packages and loads can be measured as well as individual items in packages and loads.
- Details about the measured items such as product, quantity, dimensions and measured properties.
- Details about produced items when used as a production ticket. The production machines often also make a lot of measuring of produced items that are included in the production ticket.
- Price and amounts for measured products when used as an invoice specification.
- Tracking details such as reference ID for the produced and delivered items as well as the products origin.

Using this information, the receiver can:

- Get information about actual quantities and products delivered or produced.
- Calculate quantity and price of billable products.
- Create detail specification of billable or invoiced products.
- Get information about measured product properties that are used for statistical purposes and planning.
- Compare incoming deliveries of raw material with sale orders of finished goods.
- Compare sample measuring with the original measuring and calculate correction factors

MeasuringTicket

papiNet Standard – Version 2.31

MeasuringTicketType [attribute]

MeasuringTicket Type defines the type of MeasuringTicket.

This item is restricted to the following list.

ArrivalTicket

A MeasuringTicketType that contains information about rough measurements done upon arrival of a transport vehicle to a measuring location. For example used for updating physical location of the load and calculating compensation to the carrier.

CalibrationCheckLog

A MeasuringTicketType that contains a check log with information about calibration of measuring equipment.

InvoiceSpecification

A MeasuringTicketType that contains information about measured products including prices and amounts. This MeasuringTicketType is normally used as a detailed specification of billable or invoiced products.

MeasuringTicket

A MeasuringTicketType that contains detailed information about measured products and items. This information can be used as a base for calculation of billable products.

ProductionTicket

A MeasuringTicketType that contains information about produced products and items. A ProductionTicket can also contain measuring information for produced items.

SampleMeasuringTicket

A MeasuringTicketType that contains detailed information about measured samples taken from e.g. a delivery.

Business Rules for MeasuringTicket

General Business Rules

Identifier	Business Rule
MEA001	MeasuringNumber and MeasuringDate are mandatory for all MeasuringTicket types except for type InvoiceSpecification.
MEA002	MeasuringParty is mandatory for all MeasuringTicket types except for type InvoiceSpecification.
MEA003	One package is reported per sequence when totals per product are needed for packages.

MeasuringTicket papiNet Standard – Version 2.31

Identifier	Business Rule
MEA004	Measurements ByLoad, ByPackage and ByTransportUnit are reported in PackageMeasuringInfo. The resulting products and quantities are reported on the line items when products are specified.
MEA005	Rejects during measurements are reported as a product and a quantity.
MEA006	PriceAndAmountInfo is mandatory for MeasuringTicketType InvoiceSpecification.
MEA007	Product and Quantity for the sample taken for measuring of chip fractions are specified as product and quantity on the line item for MeasuringTicketType SampleMeasuringTicket.
MEA008	MeasuringInfoInvoicingType is mandatory for MeasuringTicketType InvoiceSpecification.
MEA009	A positive amount is debit and a negative amount is credit in MeasuringTicketType InvoiceSpecification.
MEA010	Quantities on MeasuringTicketSequence and MeasuringTicketSequenceLineItem are quantities generated by measurements of items when MeasuringType is ByPackageAndItem. Quantities of packages are reported only in PackageMeasuringInfo.

Processing the MeasuringTicket

MeasuringTicket processing depends on the value in the status field at the e-Document root level. There is only one status field MeasuringTicketStatusType at the root level.

Status Values Used When Processing the MeasuringTicket

The following status values of MeasuringTicketStatusType are used at the MeasuringTicket root level:

- Original - The supplied information is the first version of that information.
- Cancelled - The supplied information is cancelled. Items that have been cancelled are not included in Totals on the Summary levels of the e-Document.
- Replaced - The supplied information is replacing earlier supplied information. The receiver should revalidate the information in their system based upon the entire information received.

MeasuringTicket e-Documents must be processed in ascending date time

MeasuringTicket

papiNet Standard – Version 2.31

order using MeasuringTicketIssueDate to ensure the correct processing of replacements and/or cancellations.

When a replaced e-Document is received as the first version of the e-Document, then the receiving party must be able to accept this version without having the original e-Document.

E.g. the replaced e-Document might be the first one that arrives and it is updated in the system of the receiver. Then later the original e-Document arrives having an earlier issue date. In this case the second e-Document must be stopped.

Understanding the Diagrams and Content

This section provides a graphical view of the schema structures, a discussion of the item's children. You can find additional information about papiNet and the standard at www.papiNet.org.

The graphics contain content model indicators, cardinality indicators, and data type information.

Associated with each graphic are the definitions for the parent item and any associated child items. All attributes are listed first, followed by the elements.

The following information should help you interpret and understand this standard. Please note the following:

- Content Model and Cardinality operate together to determine if the element or attribute are required in the instance document.
- The same attribute can never appear multiple times in the same element so, you will never see a multiple cardinality indicator.

Content model indicators:

There are three possible types of content: "sequence", "choice", and "all". The papiNet standard currently does not use the "all" construct.

- (sequence)

The sequence of the items to the right of the graphic (or below the text) is required.

- (choice)

A choice of the items to the right of the graphic (or below the text) is permitted.

- (all)

All the items to the right of the graphic are required.

Cardinality indicators:

- Dotted line around element or attribute.

A single instance of the item can optionally exist.

- Dotted line around item with range indicated below.

Multiple instances of the item can optionally exist.

- Solid line around item.

A single instance of the item must exist.

- Solid line around item with range indicated below

MeasuringTicket

papiNet Standard – Version 2.31

At least one instance must exist; multiple instances can optionally exist.

Datatype indication:

When a data type is assigned to an element (either a simple type or complex type) the name of the data type is presented beneath the item name in the graphic.

- In some cases additional information about the data type is presented (the default value).

Elements can either have content that is textual/numeric in nature or content that is made up of additional elements and/or attributes.

- When the content is textual/numeric in nature “three straight horizontal lines” will appear in the upper left-hand corner of the graphic. Pay attention to these elements because they are where you will be entering your information.
- When the content is made up of additional elements and/or attributes a “gray-box” will appear on the right-hand side of the graphic.
- If the graphic shows both the horizontal lines and the gray-box then, in the papiNet standard, the content below the element are attributes.

MeasuringTicket

papiNet Standard – Version 2.31

MeasuringTicket Root Element

MeasuringTicket

The MeasuringTicket element is the root element for the MeasuringTicket e-Document.

The MeasuringTicket e-Document specifies the details from measuring of items. Packages and loads can be measured as well as individual items in packages and loads. Products, Quantities and various measured properties can be reported. These measurements can be used as a base for calculation of billable products.

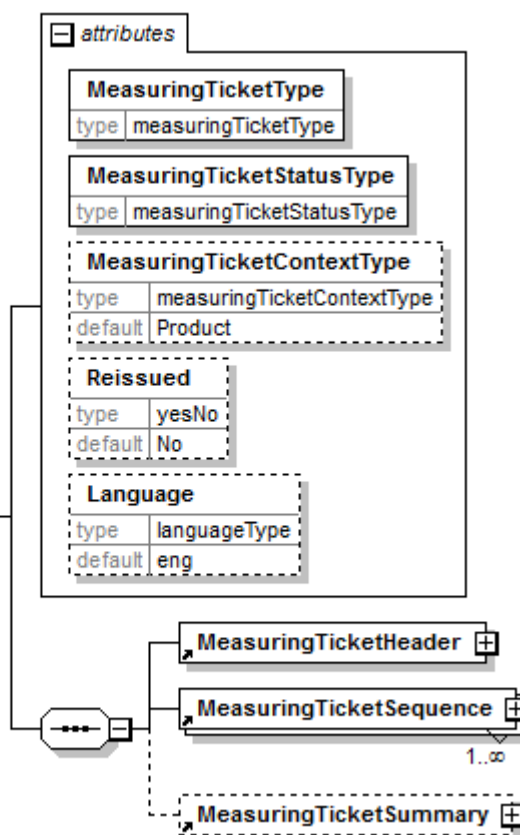
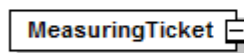

MeasuringTicketType [attribute]

MeasuringTicketType is mandatory. A single instance is required.

MeasuringTicketType defines the type of MeasuringTicket.

This item is restricted to the following list.

ArrivalTicket

A MeasuringTicketType that contains information about rough measurements done upon arrival of a transport vehicle to a measuring location. For example used for updating physical location of the load and calculating compensation to the carrier.

CalibrationCheckLog

A MeasuringTicketType that contains a check log with information about calibration of measuring equipment.

InvoiceSpecification

A MeasuringTicketType that contains information about measured products including prices and amounts. This MeasuringTicketType is normally used as a detailed specification of billable or invoiced products.

MeasuringTicket

A MeasuringTicketType that contains detailed information about measured products and items. This information can be used as a base for calculation of billable products.

ProductionTicket

A MeasuringTicketType that contains information about produced products and items. A ProductionTicket can also contain measuring information for produced items.

SampleMeasuringTicket

A MeasuringTicketType that contains detailed information about measured samples

MeasuringTicket

papiNet Standard – Version 2.31

taken from e.g. a delivery.

MeasuringTicketStatusType [attribute]

MeasuringTicketStatusType is mandatory. A single instance is required.

Identifies the status of the entire MeasuringTicket e-Document.

This item is restricted to the following list.

Cancelled

The supplied information has been cancelled. Items that have been cancelled are not included in totals on the summary levels of the e-Document.

Original

The supplied information is the first version of that information.

Replaced

The supplied information is replacing earlier supplied information. The receiver should revalidate the information in their system based upon the entire information received.

MeasuringTicketContextType [attribute]

MeasuringTicketContextType is optional. A single instance might exist.

Indicates the nature of what is included in the MeasuringTicket e-document.

This item is restricted to the following list.

LogisticsService

The MeasuringTicket is exclusively for logistics business.

Product

The MeasuringTicket is exclusively for product business

Reissued [attribute]

Reissued is optional. A single instance might exist.

Either "Yes" or "No".

This item is restricted to the following list.

Yes

No

Language [attribute]

Language is optional. A single instance might exist.

XML has embraced 2 and 3 digit language codes through the application of an addendum to the standard.

Information on the content of this attribute is available at <http://www.loc.gov/standards/iso639-2/> this is the official site of the ISO 639-2 Registration Authority.

- <http://www.w3.org/International/O-HTML-tags.html> provides an explanation of the errata updating XML.

<http://www.ietf.org/rfc/rfc3066.txt> is the key document that is referenced in the above errata.

(sequence)

MeasuringTicket

papiNet Standard – Version 2.31

The sequence of items below is mandatory. A single instance is required.

MeasuringTicketHeader

MeasuringTicketHeader is mandatory. A single instance is required.

The MeasuringTicketHeader contains information common to the entire MeasuringTicket e-Document.

MeasuringTicketSequence

MeasuringTicketSequence is mandatory. Multiple instances might exist.

A grouping element that contains information for a measuring event, e.g. a truck load.

MeasuringTicketSummary

MeasuringTicketSummary is optional. A single instance might exist.

A grouping element that contains summary information that applies to the entire MeasuringTicket e-Document.

MeasuringTicket

papiNet Standard – Version 2.31

Primary Elements

MeasuringTicketHeader

The MeasuringTicketHeader contains information common to the entire MeasuringTicket e-Document.

MeasuringInfoVersions

MeasuringInfoVersions is optional. A single instance might exist.

Specifies the principle for how versions of measuring information are communicated for given **MeasuringTicketHeader**

measuring numbers. Default value is Single.

This item is restricted to the following list

Multiple

Multiple versions of measuring information might exist for a given measuring number.

Single

Only one version of measuring information exists for a given measuring number, normally the latest version.

(sequence)

The sequence of items below is mandatory. A single instance is required.

MeasuringTicketNumber

MeasuringTicketNumber is mandatory. A single instance is required.

The unique identifier for the MeasuringTicket e-Document.

MeasuringTicketIssueDate

MeasuringTicketIssueDate is mandatory. A single instance is required.

The date and time when the MeasuringTicket e-Document was issued.

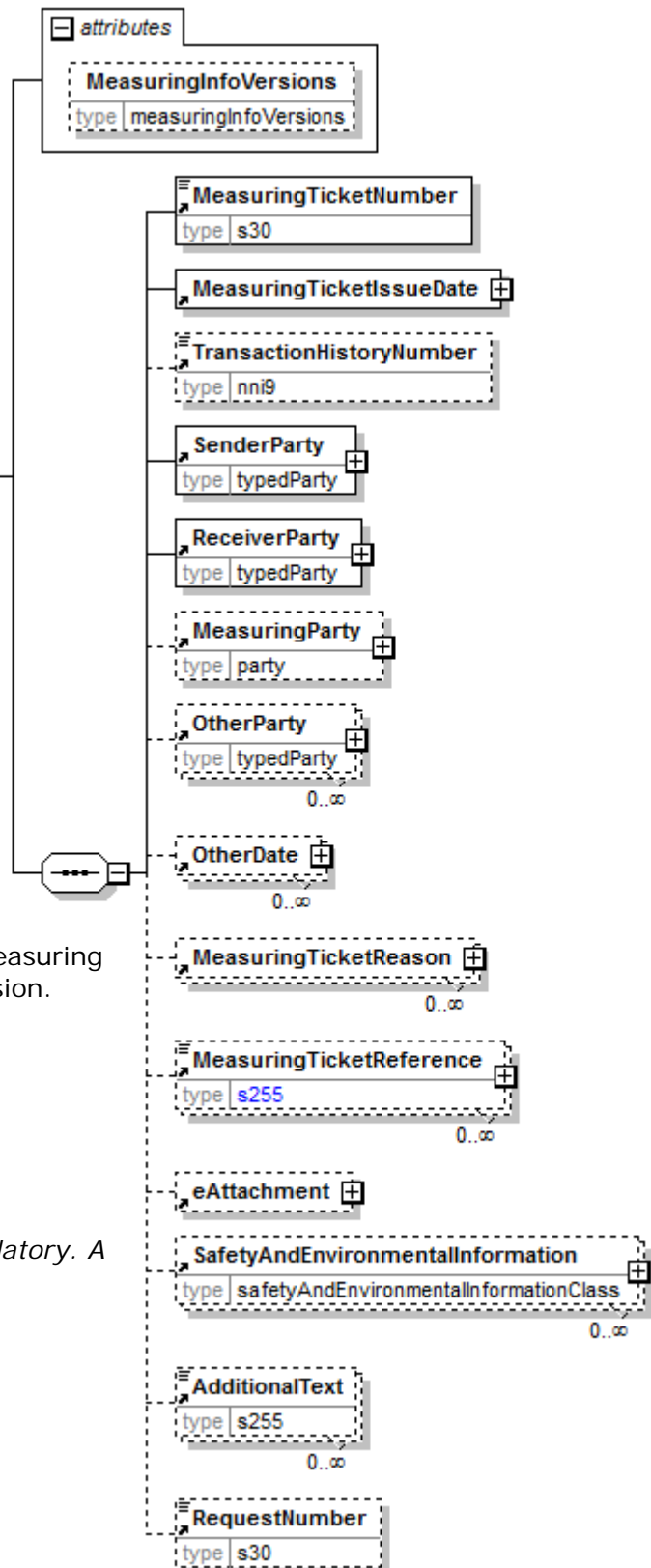

MeasuringTicket

papiNet Standard – Version 2.31

TransactionHistoryNumber

TransactionHistoryNumber is optional. A single instance might exist.

A sequential number that keeps track of the version of a document being sent by the document originator except in the case where TransactionHistoryConfirmation is used, in which case the TransactionHistoryNumber refers to the trigger transaction for which the confirmation is being sent.

SenderParty

SenderParty is mandatory. A single instance is required.

The business entity issuing the e-Document, the source of the document.

- The entity responsible for the content. If the sender party has out sourced the message service to a third party the SenderParty is the issuer of the e-Document and not the party performing the transmission service of the electronic message.

ReceiverParty

ReceiverParty is mandatory. One instance is required, multiple instances might exist.

The business entity for whom the e-Document is intended, the destination of the document.

- The entity interested in the content. If the receiver party has outsourced the message service to a third party the ReceiverParty is the intended party for the e-Document and not the party performing the receiving service of the electronic message.

MeasuringParty

MeasuringParty is optional. A single instance might exist.

The party that is responsible for the measurements at the measuring location.

OtherParty

OtherParty is optional. Multiple instances might exist.

An organisation or business entity other than those specifically detailed within a e-Document.

OtherDate

OtherDate is optional. Multiple instances might exist.

A date that may not be specifically detailed within a document (example: print date at the PurchaseOrderLineItem).

MeasuringTicketReason

MeasuringTicketReason is optional. Multiple instances might exist.

A group item containing the reason for issuing the MeasuringTicket e-Document, e.g. why it is replaced.

MeasuringTicketReference

MeasuringTicketReference is optional. Multiple instances might exist.

An element detailing relevant references pertaining to the MeasuringTicket as indicated by MeasuringTicketReferenceType and AssignedBy.

eAttachment

eAttachment is optional. A single instance might exist.

eAttachment enables the sender to provide information about attachments to the

MeasuringTicket

papiNet Standard – Version 2.31

document.

- Note: An element "e-Attachment" also exists. papiNet will no longer use hyphens in our element and attribute names as this causes issues with BizTalk.

SafetyAndEnvironmentalInformation

SafetyAndEnvironmentalInformation is optional. Multiple instances might exist.

Name of certification type, if any, on the goods (For example, FSC, PEFC). SafetyAndEnvironmental needs a value or measurement to communicate the percentage of the product is certified (for example, 75% is certified by the indicated agency).

AdditionalText

AdditionalText is optional. Multiple instances might exist.

A text field that is used to communicate information not previously defined or for special instructions. To be used only for circumstances not covered by specific elements.

RequestNumber

RequestNumber is optional. A single instance might exist.

A unique tracking number specifically identifying the InfoRequest e-Document to the originator. The tracking number is returned with the "information", the answer, to help match the answer to the request.

MeasuringTicket

papiNet Standard – Version 2.31

MeasuringTicketSequence

A grouping element that contains information for a measuring event, e.g. a truck load.

MeasuringInfoInvoicingType

MeasuringInfoInvoicingType is optional. A single instance might exist.

Specifies the type of measuring information that is supplied for invoicing. Depending on the invoicing process can the entire measuring information or just the difference to a previous invoiced version of measuring information be invoiced. A previous invoiced version of measuring information has to be credited when the entire measuring information is invoiced for a new version. A positive amount is debit and a negative amount is credit.

This item is restricted to the following list.

Difference

Measuring information is specified as the difference to the previous invoiced versions.

Entire

Measuring information is specified as the entire measured information.

(sequence)

The sequence of items below is mandatory. A single instance is required.

MeasuringTicketSequenceNumber

MeasuringTicketSequenceNumber is mandatory. A single instance is required.

A sequential number that uniquely identifies the Sequence of a MeasuringTicket.

MeasuringNumber

MeasuringNumber is optional. A single instance might exist.

A unique identifier for the measuring event.

MeasuringDate

MeasuringDate is optional. A single instance might exist.

The date when the measuring was done.

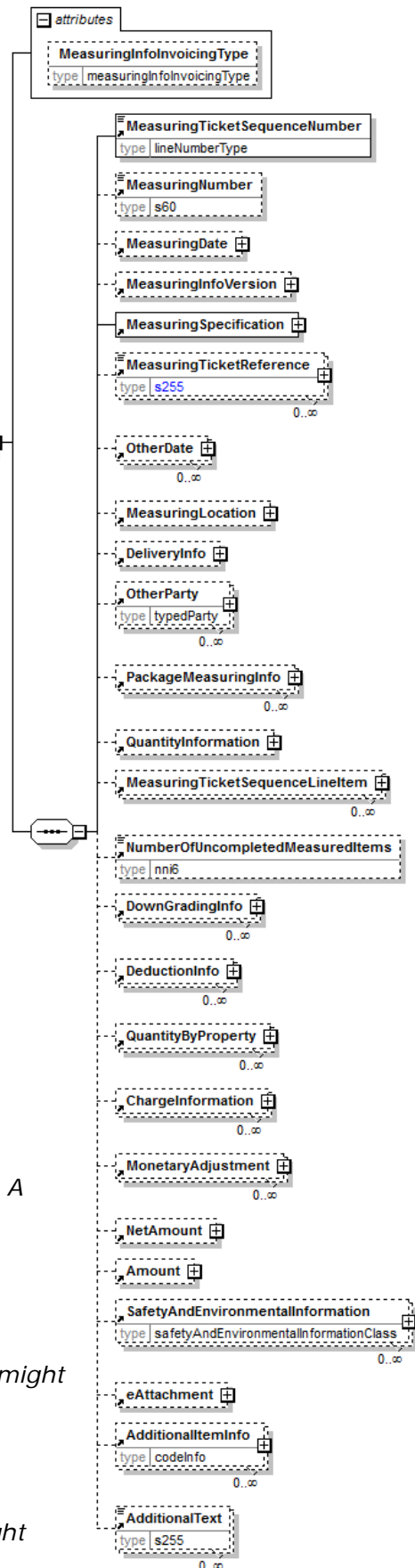

MeasuringTicket

papiNet Standard – Version 2.31

MeasuringInfoVersion

MeasuringInfoVersion is optional. A single instance might exist.

A grouping element that contains a specification of the version for the measuring information associated with a measurement.

MeasuringSpecification

MeasuringSpecification is mandatory. A single instance is required.

A grouping element that contains a specification for measurement procedures.

MeasuringTicketReference

MeasuringTicketReference is optional. Multiple instances might exist.

An element detailing relevant references pertaining to the MeasuringTicket as indicated by MeasuringTicketReferenceType and AssignedBy.

OtherDate

OtherDate is optional. Multiple instances might exist.

A date that may not be specifically detailed within a document (example: print date at the PurchaseOrderLineItem).

MeasuringLocation

MeasuringLocation is optional. A single instance might exist.

A grouping element that contains information about where the measuring is taken place.

DeliveryInfo

DeliveryInfo is optional. A single instance might exist.

Information about the delivery.

OtherParty

OtherParty is optional. Multiple instances might exist.

An organisation or business entity other than those specifically detailed within a e-Document.

PackageMeasuringInfo

PackageMeasuringInfo is optional. Multiple instances might exist.

A grouping element that contains information about a measured package or a measured load when the load is treated as one package.

QuantityInformation

QuantityInformation is optional. Multiple instances might exist.

A group item containing information about quantity and informational quantity of similar items.

MeasuringTicketSequenceLineItem

MeasuringTicketSequenceLineItem is optional. Multiple instances might exist.

A grouping element identifying a line item included within the MeasuringTicket Sequence.

NumberOfUnCompletedMeasuredItems

NumberOfUnCompletedMeasuredItems is optional. A single instance might exist.

Specifies the number of items that are uncompleted measured, i.e. some

MeasuringTicket

papiNet Standard – Version 2.31

measurement values are missing for these items.

DownGradingInfo

DownGradingInfo is optional. Multiple instances might exist.

A grouping element that contains information about downgrading of products.

DeductionInfo

DeductionInfo is optional. Multiple instances might exist.

A grouping element that contains information about deductions of quantities.

QuantityByProperty

QuantityByProperty is optional. Multiple instances might exist.

A grouping element that contains specification of quantities per property value.

ChargeInformation

ChargeInformation is optional. Multiple instances might exist.

A group element that contains elements that describe a charge. ChargeInformation is used when charge details need to be specified by using a code assigned by an agency. It is typically used for freight costs and other costs related to the supply chain.

MonetaryAdjustment

MonetaryAdjustment is optional. Multiple instances might exist.

The element containing the information necessary for the understanding, calculation, and treatment of an adjustment to a currency amount. MonetaryAdjustment contains an attribute that indicates the type of adjustment being communicated.

NetAmount

NetAmount is optional. A single instance might exist.

An element that contains the net amount excluding tax. NetAmount encapsulates CurrencyValue.

Amount

Amount is optional. A single instance might exist.

An element that contains the amount including tax. The Amount encapsulates CurrencyValue.

SafetyAndEnvironmentalInformation

SafetyAndEnvironmentalInformation is optional. Multiple instances might exist.

Name of certification type, if any, on the goods (For example, FSC, PEFC). SafetyAndEnvironmental needs a value or measurement to communicate the percentage of the product is certified (for example, 75% is certified by the indicated agency).

eAttachment

eAttachment is optional. A single instance might exist.

eAttachment enables the sender to provide information about attachments to the document.

- Note: An element "e-Attachment" also exists. papiNet will no longer use hyphens in our element and attribute names as this causes issues with BizTalk.

AdditionalItemInfo

MeasuringTicket

papiNet Standard – Version 2.31

AdditionalItemInfo is optional. Multiple instances might exist.

A grouping element that contains information about additional items specified by an agency. Restricted use of this element is recommended.

AdditionalText

AdditionalText is optional. Multiple instances might exist.

A text field that is used to communicate information not previously defined or for special instructions. To be used only for circumstances not covered by specific elements.

MeasuringTicket

papiNet Standard – Version 2.31

MeasuringTicketSequenceLineItem

A grouping element identifying a line item included within the MeasuringTicket Sequence.

MeasuringComplete [attribute]

MeasuringComplete is optional. A single instance might exist.

Indicates that measuring is completed for a particular item.

This item is restricted to the

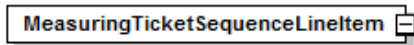

following list.

ByOrderLineItemNumber

Specifies that measuring is completed for an order line item of an order number.

ByOrderNumber

Specifies that measuring is completed for all order line items of an order number.

NotComplete

Specifies that measuring is not completed.

(sequence)

The sequence of items below is mandatory. A single instance is required.

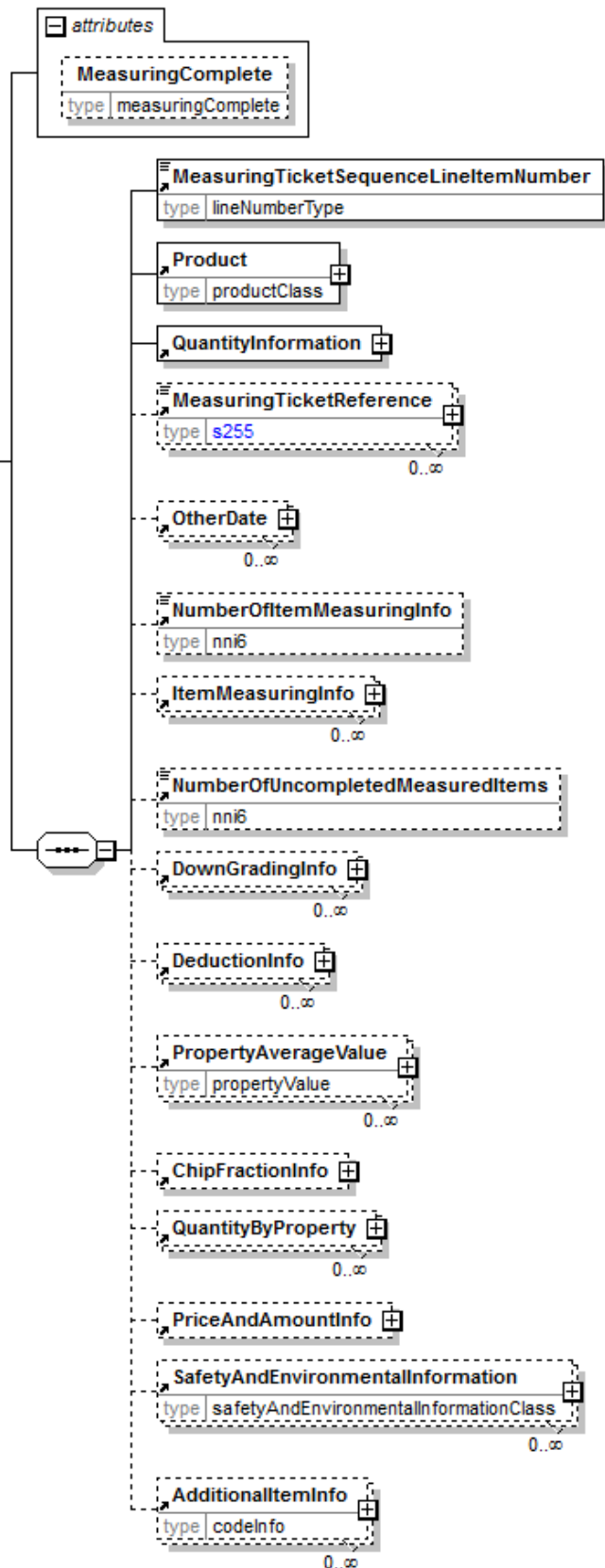

MeasuringTicketSequenceLineItemNumber

MeasuringTicketSequenceLineItemNumber is mandatory. A single instance is required.

MeasuringTicket

papiNet Standard – Version 2.31

A sequential number that uniquely identifies the line item of the MeasuringTicket Sequence.

Product

Product is optional. A single instance might exist.

Product is a group item defining the article and its characteristics. Product is used to specify product characteristics organized by ProductIdentifier, ProductDescription, and Classification. Book Manufacturing, Label Stock, Paper, Pulp, Recovered Paper, Wood Products, and Virgin Fibre market segments have defined their product characteristics and conversion features for implementation in papiNet.

QuantityInformation

QuantityInformation is mandatory. A single instance is required.

A group item containing information about quantity and informational quantity of similar items.

MeasuringTicketReference

MeasuringTicketReference is optional. Multiple instances might exist.

An element detailing relevant references pertaining to the MeasuringTicket as indicated by MeasuringTicketReferenceType and AssignedBy.

OtherDate

OtherDate is optional. Multiple instances might exist.

A date that may not be specifically detailed within a document (example: print date at the PurchaseOrderLineItem).

NumberOfItemMeasuringInfo

NumberOfItemMeasuringInfo is optional. A single instance might exist.

Number of reported items by ItemMeasuringInfo.

ItemMeasuringInfo

ItemMeasuringInfo is optional. Multiple instances might exist.

A grouping element that contains information about measured items.

NumberOfUnCompletedMeasuredItems

NumberOfUnCompletedMeasuredItems is optional. A single instance might exist.

Specifies the number of items that are uncompleted measured, i.e. some measurement values are missing for these items.

DownGradingInfo

DownGradingInfo is optional. Multiple instances might exist.

A grouping element that contains information about downgrading of products.

DeductionInfo

DeductionInfo is optional. Multiple instances might exist.

A grouping element that contains information about deductions of quantities.

PropertyAverageValue

PropertyAverageValue is optional. Multiple instances might exist.

Specifies an average value for a property for a number of items. The property is defined by the attribute PropertyType. The attribute MeasuringMethod and

MeasuringTicket

papiNet Standard – Version 2.31

MeasuringAgency can be used to clarify details for a how a property is measured or calculated, e.g. Diameter for a saw log can be measured “Under Bark” or “Over Bark”. The attribute MeasuringMethodType defines how the value is created, e.g. measured automatically, calculated etc.

ChipFractionInfo

ChipFractionInfo is optional. A single instance might exist.

Grouping element that contains information about analysis of chip fractions.

QuantityByProperty

QuantityByProperty is optional. Multiple instances might exist.

A grouping element that contains specification of quantities per property value.

PriceAndAmountInfo

PriceAndAmountInfo is optional. A single instance might exist.

A grouping element that contains information about price and amounts.

SafetyAndEnvironmentalInformation

SafetyAndEnvironmentalInformation is optional. Multiple instances might exist.

Name of certification type, if any, on the goods (For example, FSC, PEFC). SafetyAndEnvironmental needs a value or measurement to communicate the percentage of the product is certified (for example, 75% is certified by the indicated agency).

AdditionalItemInfo

AdditionalItemInfo is optional. Multiple instances might exist.

A grouping element that contains information about additional items specified by an agency. Restricted use of this element is recommended.

MeasuringTicketSummary

A grouping element that contains summary information that applies to the entire MeasuringTicket e-Document.

(sequence)

The sequence of items below is mandatory. A single instance is required.

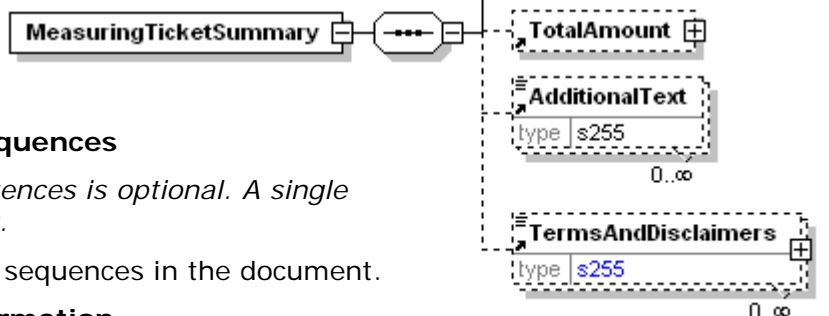

TotalNumberOfSequences

TotalNumberOfSequences is optional. A single instance might exist.

The total number of sequences in the document.

TotalQuantityInformation

TotalQuantityInformation is mandatory. A single instance is required.

A group item containing information about the total quantity and total informational quantity of similar items in the document.

TotalNetAmount

MeasuringTicket

papiNet Standard – Version 2.31

TotalNetAmount is optional. A single instance might exist.

A field containing total amount excluding tax. For example, in the Invoice TotalNetAmount is equal to the sum of LineItemSubTotal plus TotalAdjustments. TotalNetAmount encapsulates CurrencyValue.

TotalAmount

TotalAmount is optional . A single instance might exist.

The total amount including tax (when tax is specified in the e-Document).

In e-Documents claiming payment this is the amount due for payment based on the terms of payment. Decimal rounding might be applied to this amount.

AdditionalText

AdditionalTexts is optional. Multiple instances might exist.

A text field that is used to communicate information not previously defined or for special instructions. To be used only for circumstances not covered by specific elements.

TermsAndDisclaimers

TermsAndDisclaimers is optional. Multiple instances might exist.

An element that contains legal information with an indication of what the Language is.

MeasuringTicket

papiNet Standard – Version 2.31

MeasuringTicket Business Scenarios

MeasuringTicket Scenario Listing

Scenario A	A MeasuringTicket is sent that specifies a measured load on a truck. The load contains products from one OriginalSupplier.
Scenario B	A MeasuringTicket is sent that specifies measured packages on a railcar. The railcar carries three log piles with products from one OriginalSupplier
Scenario C	A MeasuringTicket is sent that specifies a measured log pile at a road side landing by a forest owner. The forest owner is the OriginalSupplier.
Scenario D	A MeasuringTicket is sent that specifies individually measured logs at a measuring location delivered as a truck load. The load contains products from one OriginalSupplier.
Scenario E	A MeasuringTicket is sent that specifies individual produced and measured trees and logs, a ProductionTicket. Production and measurement is done at the logging area by Forest Harvester.
Scenario F	A MeasuringTicket is sent that specifies energy content of delivered bioenergy products as a summary report without any details per loads. Energy content is measured and reported by the buyer to the supplier of the products. This scenario is restricted to reporting the deliveries of one individual transporting company during a time period (e.g. one month).
Scenario G	A Sample MeasuringTicket is sent that specifies individually measured logs in a log pile taken as a random sample from delivered and measured packages.
Scenario H	A MeasuringTicket is sent that specifies individually produced and measured check logs, i.e. a CalibrationCheckLog. The CalibrationCheckLog includes both automatic measurements by the Forest Harvester and manual measurements by the operator of the harvester.
Scenario I	A MeasuringTicket (type InvoiceSpecification) is sent that contains a detail specification of invoiced products. It contains information about measured products including prices and amounts.

MeasuringTicket papiNet Standard – Version 2.31

Scenario J	A MeasuringTicket is sent that corrects an erroneous MeasuringTicket sent earlier.
Scenario K	A MeasuringTicket is sent that cancels an erroneous MeasuringTicket sent earlier.
Scenario L	<p>A MeasuringTicket (ArrivalTicket) is sent to the Forest Company after arrival of a truck to a measuring location, when some – but not all - product properties and/or quantities of the truck load have been measured. Some product properties and/or quantities remain to be measured. The load contains products from one OriginalSupplier. The Forest Company can update its stock records.</p> <p>This is typically the case in a two-step measuring process, where the truck load first is measured at arrival and later in more detail after unloading of the goods and the truck has departed.</p>

MeasuringTicket

papiNet Standard – Version 2.31

Scenario A

E-document	MeasuringTicket
Type	MeasuringTicket
Scenario	A MeasuringTicket is sent that specifies a measured load on a truck. The load contains products from one OriginalSupplier.
Outcome	The load is recorded in the receiver's system with measured quantities and products as well as measurements of product properties.
Initiator	Measuring Party
Receiver	The Forest Company that has issued the measuring instruction.
Preconditions	The Measuring Party has a measuring instruction that specifies how the products should be measured.
Trigger	The measuring of the load is completed at the measuring location
Step 1.	<p>The Measuring Party sends the MeasuringTicket e-Document to the Forest Company. The following information that is included in the MeasuringTicket is particular to this scenario.</p> <p>Root</p> <ul style="list-style-type: none"> • MeasuringTicketType = "MeasuringTicket" • MeasuringTicketStatusType = "Original" <p>Header</p> <ul style="list-style-type: none"> • MeasuringParty <p>Sequence</p> <ul style="list-style-type: none"> • One MeasuringTicketSequence with measured information about the load. • MeasuringNumber • MeasuringDate • MeasuringSpecification <ul style="list-style-type: none"> • MeasuringType = "ByLoad" • MeasuringCode and MeasuringDescription • MeasuringTicketReference - specifying <ul style="list-style-type: none"> • MeasuringInstructionNumber • DeliveryMessageNumber • MeasuringLocation and MeasuringEquipment • DeliveryInfo

MeasuringTicket papiNet Standard – Version 2.31

	<ul style="list-style-type: none"> • TransportUnitCharacteristics specifying details such as TrailerID. • DeliveryOrigin • OtherParty – specifying OriginalSupplier • PackageMeasuringInfo – specifying information for the load measured as one package. • ItemInfo with ItemType = "LogPile" <ul style="list-style-type: none"> • Identifier – the identifier for the package load with IdentifierCodeType = "Carrier". • QuantityInformation – such as volume and/or weight • PropertyValue – measurements of various properties • ProductPercentage – specifying estimated percentage of the quantity per product in the load if more then one product. • Note: Product and quantity per product are reported on the MeasuringTicketSequenceLineItem <p>Line Item</p> <ul style="list-style-type: none"> • Product • QuantityInformation • MeasuringTicketReference - specifying <ul style="list-style-type: none"> • ProductOriginIdentifier • DownGradingInfo – specifying reason and quantity if a product quantity is downgraded to another product, e.g. as Reject
Result	<p>The MeasuringTicket has been recorded in the Forest Company's system. The Forest Company can based on the information in the MeasuringTicket calculate billable amounts for the products. Stock records previously updated by DeliveryMessage can be adjusted by actual measured quantity. Correction factors can be calculated and updated.</p>

MeasuringTicket

papiNet Standard – Version 2.31

Scenario B

E-document	MeasuringTicket
Type	MeasuringTicket
Scenario	A MeasuringTicket is sent that specifies measured packages on a railcar. The railcar carries three log piles with products from one OriginalSupplier
Outcome	The packages on the railcar are recorded in the receiver's system with measured quantities and products as well as measurements of product properties.
Initiator	Measuring Party
Receiver	The Forest Company that has issued the measuring instruction.
Preconditions	The Measuring Party has a measuring instruction that specifies how the products should be measured.
Trigger	The measuring of the load on the railcar is completed at the measuring location
Step 1.	<p>The Measuring Party sends the MeasuringTicket e-Document to the Forest Company. The following information that is included in the MeasuringTicket is particular to this scenario.</p> <p>Root</p> <ul style="list-style-type: none"> • MeasuringTicketType = "MeasuringTicket" • MeasuringTicketStatusType = "Original" <p>Header</p> <ul style="list-style-type: none"> • MeasuringParty <p>Sequence</p> <ul style="list-style-type: none"> • One MeasuringTicketSequence with measured information about the packages on the railcar. • MeasuringNumber • MeasuringDate • MeasuringSpecification <ul style="list-style-type: none"> • MeasuringType = "ByPackage" • MeasuringCode and MeasuringDescription • MeasuringTicketReference - specifying <ul style="list-style-type: none"> • MeasuringInstructionNumber • DeliveryMessageNumber • MeasuringLocation and MeasuringEquipment

MeasuringTicket papiNet Standard – Version 2.31

	<ul style="list-style-type: none"> • DeliveryInfo <ul style="list-style-type: none"> • TransportUnitCharacteristics specifying details for the railcar such as RailCarID • DeliveryOrigin • OtherParty – specifying OriginalSupplier • PackageMeasuringInfo – repeated three times specifying information for the three measured packages (log piles). <ul style="list-style-type: none"> • ItemInfo with ItemType = “LogPile” <ul style="list-style-type: none"> • Identifier – the identifier for the package on the railcar with IdentifierCodeType = “Carrier”. • QuantityInformation – such as volume and/or weight. • PropertyValue – measurements of various properties • ProductPercentage – specifying estimated percentage of the quantity per product in the package if more than one product. <ul style="list-style-type: none"> • Note: Product and quantity per product are reported on the MeasuringTicketSequenceLineItem <p>Line Item</p> <ul style="list-style-type: none"> • Product • QuantityInformation • MeasuringTicketReference - specifying <ul style="list-style-type: none"> • ProductOriginIdentifier • DownGradingInfo – specifying reason and quantity if a product quantity is downgraded to another product, e.g. as Reject
Result	<p>The MeasuringTicket has been recorded in the Forest Company’s system. The Forest Company can based on the information in the MeasuringTicket calculate billable amounts for the products. Stock records previously updated by DeliveryMessage can be adjusted by actual measured quantity. Correction factors can be calculated and updated.</p>

Scenario C

E-document	MeasuringTicket
Type	MeasuringTicket
Scenario	A MeasuringTicket is sent that specifies a measured log pile at a road side landing by a forest owner. The forest owner is the OriginalSupplier.
Outcome	The log pile is recorded in the receiver’s system with measured quantities and products as well as

MeasuringTicket

papiNet Standard – Version 2.31

	measurements of product properties.
Initiator	The forest owner is acting as the Measuring Party
Receiver	The Buyer, e.g. a saw mill
Preconditions	The Measuring Party has a measuring instruction that specifies how the products should be measured.
Trigger	The measuring of the log pile is completed at the measuring location, i.e. at the roadside landing.
Step 1.	<p>The Measuring Party sends the MeasuringTicket e-Document to the buyer. The following information that is included in the MeasuringTicket is particular to this scenario.</p> <p>Root</p> <ul style="list-style-type: none"> • MeasuringTicketType = "MeasuringTicket" • MeasuringTicketStatusType = "Original" <p>Header</p> <ul style="list-style-type: none"> • MeasuringParty = the forest owner <p>Sequence</p> <ul style="list-style-type: none"> • One MeasuringTicketSequence with measured information about the log pile. • MeasuringNumber • MeasuringDate • MeasuringSpecification <ul style="list-style-type: none"> • MeasuringType = "ByPackage" • MeasuringCode and MeasuringDescription • MeasuringTicketReference - specifying <ul style="list-style-type: none"> • MeasuringInstructionNumber • ContractNumber • MeasuringLocation and MeasuringEquipment • OtherParty – specifying <ul style="list-style-type: none"> • OriginalSupplier • PackageMeasuringInfo – specifying information for the log pile measured as one package. <ul style="list-style-type: none"> • ItemInfo with ItemType = "LogPile" <ul style="list-style-type: none"> • Identifier – the identifier for the package with IdentifierCodeType = "Supplier" (can be a running number). • QuantityInformation – such as volume • PropertyValue – measurements of various properties • ProductPercentage – specifying estimated or measured percentage of the quantity per product in the log pile if more than one product. <ul style="list-style-type: none"> • Note: Product and quantity per product are

MeasuringTicket papiNet Standard – Version 2.31

	<p>reported on the MeasuringTicketSequenceLineItem</p> <p>Line Item</p> <ul style="list-style-type: none">• Product• QuantityInformation• MeasuringTicketReference - specifying<ul style="list-style-type: none">• ProductOriginIdentifier• DownGradingInfo – specifying reason and quantity if a product quantity is downgraded to another product, e.g. as Reject
Result	<p>The MeasuringTicket has been recorded in the Forest Company's system. The Forest Company can based on the information in the MeasuringTicket calculate billable amounts for the products. Stock records can be adjusted by actual measured quantity. Correction factors can be calculated and updated.</p>

MeasuringTicket

papiNet Standard – Version 2.31

Scenario D

E-document	MeasuringTicket
Type	MeasuringTicket
Scenario	A MeasuringTicket is sent that specifies individually measured logs at a measuring location delivered as a truck load. The load contains products from one OriginalSupplier.
Outcome	The load is recorded in the receiver's system with measured quantities and products as well as measurements of product properties for every log on the load
Initiator	Measuring Party
Receiver	The Forest Company that has issued the measuring instruction.
Preconditions	The Measuring Party has a measuring instruction that specifies how the products should be measured.
Trigger	The measuring of logs on the load is completed at the measuring location.
Step 1.	<p>The Measuring Party sends the MeasuringTicket e-Document to the Forest Company. The following information that is included in the MeasuringTicket is particular to this scenario.</p> <p>Root</p> <ul style="list-style-type: none"> • MeasuringTicketType = "MeasuringTicket" • MeasuringTicketStatusType = "Original" <p>Header</p> <ul style="list-style-type: none"> • MeasuringParty <p>Sequence</p> <ul style="list-style-type: none"> • One MeasuringTicketSequence with measured information about the load. • MeasuringNumber • MeasuringDate • MeasuringSpecification <ul style="list-style-type: none"> • MeasuringType = "ByItem" • MeasuringCode and MeasuringDescription • MeasuringTicketReference - specifying <ul style="list-style-type: none"> • MeasuringInstructionNumber

MeasuringTicket papiNet Standard – Version 2.31

	<ul style="list-style-type: none"> • DeliveryMessageNumber • MeasuringLocation and MeasuringEquipment • DeliveryInfo <ul style="list-style-type: none"> • TransportUnitCharacteristics specifying details such as TrailerID. • DeliveryOrigin • OtherParty – specifying OriginalSupplier <p>Line Item</p> <ul style="list-style-type: none"> • Product • QuantityInformation • MeasuringTicketReference - specifying <ul style="list-style-type: none"> • ProductOriginIdentifier • NumberOfItemMeasuringInfo = number of measured items, i.e. logs • ItemMeasuringInfo – specifying information for a measured log, repeated once per log. <ul style="list-style-type: none"> • ItemInfo with ItemType = "Log" <ul style="list-style-type: none"> • Identifier – the identifier for the log with IdentifierCodeType = "Measurer". • QuantityInformation – such as volume and/or weight • PropertyValue – measurements of various properties • Note: Measured logs are sorted and reported per assigned Product on the MeasuringTicketSequenceLineItem • DownGradingInfo – specifying reason and quantity if a product quantity is downgraded to another product, e.g. as Reject
Result	<p>The MeasuringTicket has been recorded in the Forest Company's system. The Forest Company can based on the information in the MeasuringTicket calculate billable amounts for the products. Stock records previously updated by DeliveryMessage can be adjusted by actual measured quantity. Correction factors can be calculated and updated.</p>

Scenario E

E-document	MeasuringTicket
Type	ProductionTicket
Scenario	A MeasuringTicket is sent that specifies individually produced and measured trees and logs, i.e. a Production Ticket. Production and measurement is done at the logging area by Forest Harvester.

MeasuringTicket papiNet Standard – Version 2.31

The original raw data is sent from Forest Harvester to Forest company using StanForD standard message (type pri or hpr). The StanForD message is converted by the Forest Company or their representative (in Sweden often SDC) into a MeasuringTicket e-Document that is sent to a Forest Industry Company, e.g. a sawmill. The MeasuringTicket contains only the products that will be delivered to the sawmill. The StanForD message is not suitable for this purpose since it always includes all products harvested at a certain logging area. Normally, when sending information to a certain industry, you do not want to include information concerning products manufactured for other industries.

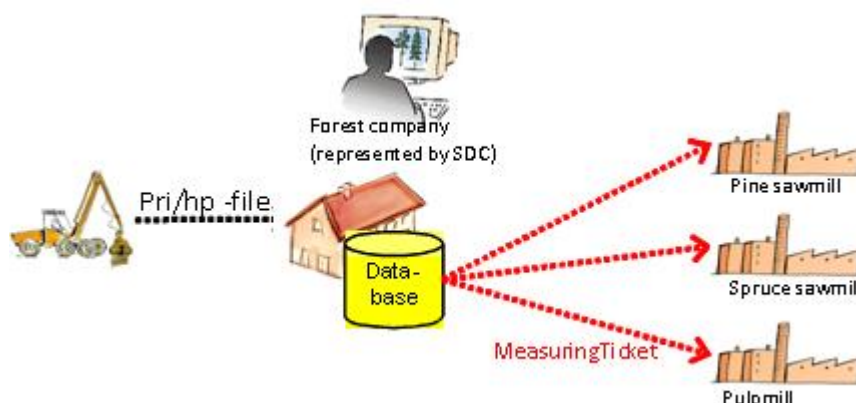

Outcome	The logs are recorded in the receiver's system with measured diameters, lengths, quantities, products and production date.
Initiator	Forest Company
Receiver	Forest Industry Company, e.g. a Sawmill
Preconditions	The Forest Harvester has an instruction that specifies how the logs should be produced and measured. The raw data is sent from ForestHarvester to Forest company using StanForD standard message (type pri or hpr).
Trigger	The production and measuring is sent daily before machine shut down. The MeasuringTicket is generated and sent when the Forest company receives data from the Forest Harvester.
Step 1.	The Forest Company sends the MeasuringTicket e-

MeasuringTicket

papiNet Standard – Version 2.31

	<p>Document to the Forest Industry. The following information that is included in the MeasuringTicket is particular to this scenario.</p> <p>Root</p> <ul style="list-style-type: none"> • MeasuringTicketType = "ProductionTicket" • MeasuringTicketStatusType = "Original" <p>Header</p> <ul style="list-style-type: none"> • MeasuringParty, the owner of forest harvester <p>Sequence</p> <ul style="list-style-type: none"> • One MeasuringTicketSequence with measured information about the logs. • MeasuringNumber • MeasuringDate • MeasuringSpecification <ul style="list-style-type: none"> • MeasuringType = "ByItem" • MeasuringCode and MeasuringDescription • MeasuringLocation and MeasuringEquipment <ul style="list-style-type: none"> • Specifying ForestHarvester and machine operators. Specifying who and where measuring is carried out. • OtherParty – specifying OriginalSupplier and LoggingArea <p>Line Item</p> <ul style="list-style-type: none"> • One MeasuringTicketSequenceLineItem per product, • Product • QuantityInformation • MeasuringTicketReference - specifying <ul style="list-style-type: none"> • ProductOriginIdentifier • NumberOfItemMeasuringInfo = number of measured items, i.e. logs • ItemMeasuringInfo – specifying information for the logs. <ul style="list-style-type: none"> • ItemInfo with ItemType = "Log" <ul style="list-style-type: none"> • Identifier – the identifier for the log, for example with IdentifierCodeType = "Measurer" (Identifier can be a running number) or with IdentifierCodeType = "RFTagSerialNumber". • QuantityInformation – volume of logs • PropertyValue – measurements of various properties • Note: Measured logs are sorted and reported per assigned Product on the MeasuringTicketSequenceLineItem
Result	The MeasuringTicket has been recorded in the Forest

MeasuringTicket papiNet Standard – Version 2.31

	Industry Company's system (for example a sawmill). The Industry can, based on the information in the MeasuringTicket, estimate up-coming deliveries and calculate billable amounts for product.
--	---

Scenario F

E-document	MeasuringTicket
Type	MeasuringTicket
Scenario	<p>A MeasuringTicket is sent that specifies energy content of delivered bioenergy products as a summary report without any details per loads. Energy content is measured and reported by the buyer to the supplier of the products. This scenario is restricted to reporting the deliveries of one individual transporting company during a time period (e.g. one month).</p> <p>Energy content expressed in MegaWattHour is the most commonly used invoicing basis in the sales of bioenergy products. It is often used as a calculation unit for transportation payments as well. Energy content can be measured with different methods depending on the type of the product as well as the supply and production processes. Usually it is calculated based on the weighed mass and sample measured moisture content. Product or tree species specific energy content functions or tables are often used to calculate the energy content value.</p> <p>Measuring of the product quantities may have been carried out already earlier in the supply chain for logistics purposes by using other units than MegaWattHour, e.g. cubic meters or kilograms. It is typical that the moisture content of the product changes during the long-lasting supply chain due to drying of wood. Also other changes, like decaying, might have an effect on the quality and energy content of the wood. Therefore the energy content is normally measured just before the end-use or after the drying process is finished.</p>
Outcome	Measured energy content of the bioenergy product deliveries are recorded in the receiver's system.
Initiator	The company buying the bioenergy product, which

MeasuringTicket papiNet Standard – Version 2.31

	normally is also the end-user, is acting as the Measuring Party.
Receiver	The supplier of the bioenergy product.
Preconditions	Business partners have agreed and specified how the measurement is done and which measuring methods and equipments are to be used. Measurement can partly be based on the volume or mass of the product that has been measured and reported by a third party, like transporting vehicle or transporting company.
Trigger	MeasuringTicket is generated and sent at the time intervals that have been agreed by the business partners or after that the deliveries are finished.
Step 1.	<p>The company buying the bioenergy product sends the MeasuringTicket e-Document to the supplier. The following information that is included in the MeasuringTicket is particular to this scenario.</p> <p>Root</p> <ul style="list-style-type: none"> • MeasuringTicketType = "MeasuringTicket" • MeasuringTicketStatusType = "Original" <p>Header</p> <ul style="list-style-type: none"> • MeasuringParty <p>Sequence</p> <ul style="list-style-type: none"> • One MeasuringTicketSequence with measured energy content of the delivered bioenergy products by <ul style="list-style-type: none"> • Vehicles of a transporting company • Delivery time period • MeasuringSpecification <ul style="list-style-type: none"> • MeasuringType = "ByLoad" • MeasuringTicketReference – repeated for specifying of transport vehicles <ul style="list-style-type: none"> • TransportVehicleIdentifier • OtherDate – specifying delivery time period <ul style="list-style-type: none"> • DateType = "DeliveryDate" • DateTimeRange • MeasuringLocation <ul style="list-style-type: none"> • LocationParty PartyType = "EndUser" • OtherParty <ul style="list-style-type: none"> • PartyType="Carrier" – specifying transport company <p>Line Item</p> <ul style="list-style-type: none"> • Product

MeasuringTicket papiNet Standard – Version 2.31

	<ul style="list-style-type: none">• QuantityInformation• QuantityByProperty - specifying the delivered quantities by moisture content of the product<ul style="list-style-type: none">• Based on moisture content samples taken normally from the delivered truck loads.• PropertyValue PropertyType = "Moisture"• DetailValue, DetailRangeMin and DetailRangeMax together with UOM = "Percentage" can be used to specify the moisture content classes
Result	The MeasuringTicket has been recorded in the system of the bioenergy product supplier. The supplier can based on the information in the MeasuringTicket calculate billable amounts for the products. Stock records can be adjusted by measured quantities of deliveries. Transformations between different quantity units can be done. Correction factors can be calculated and updated.

MeasuringTicket

papiNet Standard – Version 2.31

Scenario G

E-document	MeasuringTicket
Type	SampleMeasuringTicket
Scenario	A Sample MeasuringTicket is sent that specifies individually measured logs in a log pile taken as a random sample from delivered and measured packages.
Outcome	Detailed measurements of the random sample are recorded in the receiver's system.
Initiator	Measuring Party
Receiver	Forest Company
Preconditions	A log pile is measured as a package and marked with a random sample number. A MeasuringTicket is sent to Forest Company with information about the measured package and with a reference to the random sample number.
Trigger	The measuring of the logs in the log pile marked with the random sample number is completed at the measuring location.
Step 1.	<p>The Measuring Party sends the MeasuringTicket e-Document to the Forest Company. The following information that is included in the MeasuringTicket is particular to this scenario.</p> <p>Root</p> <ul style="list-style-type: none"> • MeasuringTicketType = "SampleMeasuringTicket" • MeasuringTicketStatusType = "Original" <p>Header</p> <ul style="list-style-type: none"> • MeasuringParty <p>Sequence</p> <ul style="list-style-type: none"> • One MeasuringTicketSequence with measured information for the random sample • MeasuringNumber • MeasuringDate • MeasuringSpecification <ul style="list-style-type: none"> • MeasuringType = "ByItem" • MeasuringCode and MeasuringDescription

MeasuringTicket papiNet Standard – Version 2.31

	<ul style="list-style-type: none"> • MeasuringTicketReference - specifying <ul style="list-style-type: none"> • RandomSampleNumber • PopulationNumber • MeasuringInstructionNumber • MeasuringLocation and MeasuringEquipment • OtherParty – specifying OriginalSupplier <p>Line Item</p> <ul style="list-style-type: none"> • Product • QuantityInformation • MeasuringTicketReference - specifying <ul style="list-style-type: none"> • ProductOriginIdentifier • NumberOfItemMeasuringInfo = number of measured items, i.e. logs • ItemMeasuringInfo – specifying information for a measured log, repeated once per log. <ul style="list-style-type: none"> • ItemInfo with ItemType = "Log" <ul style="list-style-type: none"> • Identifier – the identifier for the log with IdentifierCodeType = "Measurer". • QuantityInformation – such as volume • PropertyValue – measurements of various properties • Note: Measured logs are sorted and reported per assigned Product on the MeasuringTicketSequenceLineItem • DownGradingInfo – specifying reason and quantity if a product quantity is downgraded to another product, e.g. as Reject
Result	<p>The Sample MeasuringTicket has been recorded in the Forest Company's system. The reference to RandomSampleNumber makes it possible for the Forest Company to compare the measuring of the same package by package and by item. Measuring correction factors can be calculated per population number. These measuring correction factors can be used for improving accuracy for measurements by package.</p>

Scenario H

E-document	MeasuringTicket
Type	CalibrationCheckLog
Scenario	A MeasuringTicket is sent that specifies individually produced and measured check logs, i.e. a CalibrationCheckLog. The CalibrationCheckLog includes both automatic measurements by the Forest

MeasuringTicket papiNet Standard – Version 2.31

	<p>Harvester and manual measurements by the operator of the harvester. It may also include a third measurement carried out by an independent auditor, but that is not included in this scenario. Production and measurement is done at the logging area by Forest Harvester.</p> <p>The original raw data is sent from Forest Harvester to Forest company using StanForD message (type ktr or hqc). The StanForD message is converted by the Forest Company or their representative (in Sweden often SDC) into a MeasuringTicket e-Document that is sent to a forest owner (original supplier). The MeasuringTicket contains all products.</p>  <pre> graph LR Harvester[Harvester] -- "Ktr/h qc-file" --> ForestCompany["Forest company (represented by SDC)"] ForestCompany --> Database[(Data-base)] Database -- "MeasuringTicket (all products)" --> ForestOwner[Forestowner] </pre>
Outcome	The logs are recorded in the receiver's system with measured diameters, lengths, quantities, products and production date. Machine and operator measurements are stored in the receiver's system.
Initiator	Forest Company
Receiver	Forest owner (Original supplier)
Preconditions	The Forest Harvester has an instruction that specifies how the logs should be produced, machine measured and check measured. The raw data is sent from ForestHarvester to Forest company using StanForD standard message (type ktr or hqc).
Trigger	The production and measuring is sent daily before machine shut down. Normally two trees at a time. The MeasuringTicket is generated and sent when the Forest company receives data from the Forest Harvester.
Step 1.	The Forest Company sends the MeasuringTicket e-Document to the Forest owner. The following information that is included in the MeasuringTicket is particular to this scenario.

MeasuringTicket

papiNet Standard – Version 2.31

Root

- MeasuringTicketType = "CalibrationCheckLog"
- MeasuringTicketStatusType = "Original"

Header

- MeasuringParty, the owner of forest harvester

Sequence

- Two MeasuringTicketSequence with measured information about the logs, one per type of measurement (machine and operator).
- MeasuringNumber
- MeasuringDate
- MeasuringSpecification
 - MeasuringType = "ByItem"
 - MeasuringCode and MeasuringDescription identifying whether the sequence includes operator or harvester measurements
- MeasuringTicketReference - specifying
 - MeasuringNumber - a reference on the sequence with operator measurements in order to identify original harvester measurement
- MeasuringLocation
 - PartyType ForestHarvester - specifying who and where measuring is carried out.
 - MeasuringEquipment - specifies harvester equipment or Caliper used for operator measurement
- OtherParty – specifying OriginalSupplier and LoggingArea

Line Item

- One MeasuringTicketSequenceLineItem per product
- Product
- QuantityInformation
- MeasuringTicketReference - specifying
 - ProductOriginIdentifier
- NumberOfItemMeasuringInfo = number of measured items, i.e. stems and logs
- ItemMeasuringInfo – specifying information for the stem and logs. The identifiers of the stems and the logs are the same for harvester and operator measurements
 - ItemInfo with ItemType = "Stem"
 - Identifier – the identifier for the stem, for example with IdentifierCodeType = "Measurer" (Identifier can

MeasuringTicket papiNet Standard – Version 2.31

	<p>be a running number) or with IdentifierCodeType = "RFTagSerialNumber".</p> <ul style="list-style-type: none"> • ItemInfo with ItemType = "Log" (repeated for logs) <ul style="list-style-type: none"> • Identifier – the identifier for the log, for example with IdentifierCodeType = "Measurer" (Identifier can be a running number) or with IdentifierCodeType = "RFTagSerialNumber". • TrackingReferenceID - used to identify parent stem <ul style="list-style-type: none"> • TrackingReferenceIDType = "Parent", ItemType= "Stem" • Identifier - contains the identifier of the stem • QuantityInformation – volume of the log • PropertyValue – measurements of various properties <ul style="list-style-type: none"> • MeasuringMethodType specifying Automatic (harvester) or Manual (operator). • PositionOnItem - used for repeated diameter measurements along the log, normally 1 m interval. • Note: Measured logs are sorted and reported per assigned Product on the MeasuringTicketSequenceLineItem
Result	<p>The MeasuringTicket has been recorded in the Forest owner's system. The Forest owner can, based on the information in the MeasuringTicket, monitor the measuring quality of the Forest Harvester.</p>

MeasuringTicket

papiNet Standard – Version 2.31

Scenario I

E-document	MeasuringTicket
Type	InvoiceSpecification
Scenario	<p>A MeasuringTicket (type InvoiceSpecification) is sent that specifies detail specification of invoiced products. It contains information about measured products including prices and amounts.</p> <p>In this scenario the MeasuringTicket type InvoiceSpecification contains a detailed specification of products invoiced on a normal invoice, i.e. not a self-billing invoice.</p> <p>Remarks:</p> <ul style="list-style-type: none"> • An invoice can be sent without having a MeasuringTicket type InvoiceSpecification with detailed specifications. • A MeasuringTicket type InvoiceSpecification can specify many measuring events at many measuring locations. • Several MeasuringTicket type InvoiceSpecification can also be used to specify one Invoice.
Outcome	Detail specification of invoiced products is recorded in the system of the buyer.
Initiator	The issuer of the invoice, the seller
Receiver	The receiver of the invoice, the buyer.
Preconditions	Products are ready for invoicing.
Trigger	The Measuring of the products is completed at the measuring location and the seller has calculated billable amounts for the products based on a MeasuringTicket type MeasuringTicket received from the MeasuringParty.
Step 1.	<p>The sender sends the e-Document MeasuringTicket type InvoiceSpecification to the buyer. The following information that is included in the MeasuringTicket is particular to this scenario.</p> <p>Root</p> <ul style="list-style-type: none"> • MeasuringTicketType = "InvoiceSpecification" • MeasuringTicketStatusType = "Original"

MeasuringTicket papiNet Standard – Version 2.31

	<p>Header</p> <ul style="list-style-type: none"> • MeasuringParty <ul style="list-style-type: none"> • Note: MeasuringParty is optional and is not supplied when specification contains products measured by many measuring parties • MeasuringTicketReference - specifying <ul style="list-style-type: none"> • InvoiceNumber <p>Sequence</p> <ul style="list-style-type: none"> • One MeasuringTicketSequence per measuring event • MeasuringNumber • MeasuringDate • MeasuringSpecification and MeasuringType • MeasuringTicketReference - specifying <ul style="list-style-type: none"> • ContractNumber • MeasuringTicketNumber – from Measuring Party • MeasuringTicketSequenceNumber • MeasuringLocation • MonetaryAdjustment – if any adjustments, e.g. freight charge • NetAmount – amount without tax <p>Line Item</p> <ul style="list-style-type: none"> • Product • QuantityInformation • MeasuringTicketReference - specifying <ul style="list-style-type: none"> • ProductOriginIdentifier • PriceAndAmountInfo <ul style="list-style-type: none"> • BaseAmountInfo • QuantityInformation • MonetaryAdjustment – if any adjustments • NetAmount – amount without tax
Result	<p>The MeasuringTicket type InvoiceSpecification has been recorded in the buyer's system. The buyer can make a detailed check of invoiced amounts and price details for the products before payment.</p>

MeasuringTicket

papiNet Standard – Version 2.31

Scenario J

E-document	MeasuringTicket
Type	MeasuringTicket
Scenario	A MeasuringTicket is sent that corrects an erroneous MeasuringTicket sent earlier.
Outcome	The previous MeasuringTicket recorded in the receiver ´s system is replaced by the new correct MeasuringTicket.
Initiator	Measuring Party
Receiver	Forest Company
Precondi- tions	The Measuring Party has sent a MeasuringTicket with MeasuringTicketStatusType = "Original" to Forest Company.
Trigger	The Measuring Party has updated the MeasuringTicket in their system, because some property values were not correctly measured.
Step 1.	<p>The Measuring Party sends the MeasuringTicket e-Document to the Forest Company. The following information that is included in the MeasuringTicket is particular to this scenario.</p> <p>Root</p> <ul style="list-style-type: none"> • MeasuringTicketType = "MeasuringTicket" • MeasuringTicketStatusType = "Replaced" <p>Header</p> <ul style="list-style-type: none"> • MeasuringTicketNumber <ul style="list-style-type: none"> • The MeasuringTicketNumber is the same as the MeasuringTicketNumber on the previous MeasuringTicket with MeasuringTicketStatusType = "Original" • MeasuringTicketIssueDate <ul style="list-style-type: none"> • Issue date is later then the issue date on the previous MeasuringTicket with MeasuringTicketStatusType = "Original" • Information on header is updated if applicable <p>Sequence</p> <ul style="list-style-type: none"> • Information on sequence level is updated if applicable

MeasuringTicket papiNet Standard – Version 2.31

	<p>Line Item</p> <ul style="list-style-type: none"> Information on line items is updated if applicable
Result	The previous MeasuringTicket recorded in the receiver's system is rolled back and replaced by the new correct MeasuringTicket.

Scenario K

E-document	MeasuringTicket
Type	MeasuringTicket
Scenario	A MeasuringTicket is sent that cancels an erroneous MeasuringTicket sent earlier.
Outcome	The previous MeasuringTicket recorded in the receiver's system is cancelled.
Initiator	Measuring Party
Receiver	Forest Company
Preconditions	The Measuring Party has sent a MeasuringTicket with MeasuringTicketStatusType = "Original" or "Replaced" to Forest Company.
Trigger	The Measuring Party has cancelled the MeasuringTicket in their system, because the measurements are invalid.
Step 1.	<p>The Measuring Party sends the MeasuringTicket e-Document to the Forest Company. The following information that is included in the MeasuringTicket is particular to this scenario.</p> <p>Root</p> <ul style="list-style-type: none"> MeasuringTicketType = "MeasuringTicket" MeasuringTicketStatusType = "Cancelled" <p>Header</p> <ul style="list-style-type: none"> MeasuringTicketNumber <ul style="list-style-type: none"> The MeasuringTicketNumber is the same as the MeasuringTicketNumber on the previous MeasuringTicket with MeasuringTicketStatusType = "Original" or "Replaced" MeasuringTicketIssueDate <ul style="list-style-type: none"> Issue date is later then the issue date on the previous MeasuringTicket with

MeasuringTicket papiNet Standard – Version 2.31

	<p>MeasuringTicketStatusType = "Original" or "Replaced"</p> <ul style="list-style-type: none"> Information on header is the same as before. <p>Sequence</p> <ul style="list-style-type: none"> Information on sequence level is the same as before. <p>Line Item</p> <ul style="list-style-type: none"> Information on line items is the same as before.
Result	The previous MeasuringTicket recorded in the receiver's system is rolled back and cancelled.

Scenario L

E-document	MeasuringTicket
Type	ArrivalTicket
Scenario	<p>A MeasuringTicket is sent to the Forest Company after arrival of a truck to a measuring location, when some – but not all - product properties and/or quantities of the truck load have been measured. Some product properties and/or quantities remain to be measured. The load contains products from one OriginalSupplier. The Forest Company can update its stock records.</p> <p>This is typically the case in a two-step measuring process, where the truck load first is measured at arrival and later in more detail after unloading of the goods and the truck has departed.</p>
Outcome	The load is recorded in the receiver's system with measured quantities and products related to a delivery.
Initiator	Measuring Party
Receiver	The Forest Company that has sold the products.
Preconditions	<p>The Measuring Party has a measuring instruction that specifies how the products should be measured.</p> <p>The Delivery Message Number of the load and the Seller of the products are known by the Measuring Party.</p>
Trigger	In a multiple step measuring process, the initial measuring of the load has been completed after

MeasuringTicket papiNet Standard – Version 2.31

	<p>arrival at the measuring location. This could for instance be measurement of load weight by measuring the transport vehicle before and after unloading of the load.</p>
<p>Step 1.</p>	<p>The Measuring Party sends the MeasuringTicket e-Document to the Forest Company. The following information that is included in the MeasuringTicket is particular to this scenario.</p> <p>Root</p> <ul style="list-style-type: none"> • MeasuringTicketType = "ArrivalTicket" • MeasuringTicketStatusType = "Original" <p>Header</p> <ul style="list-style-type: none"> • SenderParty with PartyType = "MeasuringParty" • ReceiverParty with PartyType = "ForestCompany" • MeasuringParty <p>Sequence</p> <p>One MeasuringTicketSequence with measured information about the load.</p> <ul style="list-style-type: none"> • MeasuringNumber • MeasuringDate • MeasuringSpecification • MeasuringType = "ByLoad" • MeasuringTicketReference - specifying MeasuringInstructionNumber and DeliveryMessageNumber • MeasuringLocation • DeliveryInfo <ul style="list-style-type: none"> • CarrierParty • DeliveryOrigin • OtherParty – specifying OriginalSupplier <p>Line Item</p> <ul style="list-style-type: none"> • Product • QuantityInformation • MeasuringTicketReference - specifying ProductOriginIdentifier
<p>Result</p>	<p>The MeasuringTicket has been recorded in the system of the Forest Company. Stock records previously updated by a DeliveryMessage can be adjusted by measured quantities with their current location based on the information in the MeasuringTicket.</p> <p>The stock records of not yet compensation measured</p>

MeasuringTicket papiNet Standard – Version 2.31

	products at a measuring location can be increased with the measured quantity at arrival and the stock record of products in transit to the measuring location can be reduced with this quantity.
--	--