



papiNet

LoadTender & LoadTenderResponse

papiNet Standard - Version 2.31

Documentation

**Global Standard for the Paper and Forest
Products Supply Chain**

Build V2R31_20211013

Date 2021-10-22

Production Release

LoadTender

papiNet Standard - Version 2.31

Copyright

Copyright 2000 - 2021 papiNet G.I.E ("papiNet") and International Digital Enterprise Alliance, Inc. ("IDEAlliance") collectively "Copyright Owner". All rights reserved by the Copyright Owner under the laws of the United States, Belgium, the European Economic Community, and all states, domestic and foreign. This document may be downloaded and copied provided that all copies retain and display the copyright and any other proprietary notices contained in this document. This document may not be sold, modified, edited, or taken out of context such that it creates a false or misleading statement or impression as to the purpose or use of the papiNet specification, which is an open standard. Use of this Standard, in accord with the foregoing limited permission, shall not create for the user any rights in or to the copyright, which rights are exclusively reserved to the Copyright Owner.

papiNet, IDEAlliance, and the members of all papiNet Groups (collectively and individually, "Presenters") make no representations or warranties, express or implied, including, but not limited to, warranties of merchantability, fitness for a particular purpose, title, or non-infringement. The presenters do not make any representation or warranty that the contents of this document are free from error, suitable for any purpose of any user, or that implementation of such contents will not infringe any third party patents, copyrights, trademarks or other rights. By making use of this document, the user assumes all risks and waives all claims against Presenters.

In no event shall Presenters be liable to user (or other person) for direct, indirect, special or consequential damages arising from or related to any use of this document, including, without limitation, lost profits, business interruption, loss of programs, or other data on your information handling system even if Presenters are expressly advised of the possibility of such damages.

Use of Documents in papiNet Implementations

Documents may be used as templates for a papiNet implementation. The Presenters grant the right to modify and edit them to fit an actual implementation project provided all copies display the copyright and any other proprietary notices contained in this document. Such modified documents must not be distributed beyond the trading partners implementing or maintaining a papiNet connection.

LoadTender

papiNet Standard - Version 2.31

Table of Contents

Copyright	2
Use of Documents in papiNet Implementations	2
Table of Contents	3
LoadTender & LoadTenderResponse Documentation	4
LoadTender e-Document Overview	4
LoadTender Scope	4
LoadTenderType [attribute]	4
Business Rules for LoadTender	4
Processing the LoadTender	5
Understanding the Diagrams and Content	6
LoadTender Root Element	8
LoadTender	8
Primary Elements	10
LoadTenderHeader	10
LoadTenderSegment	13
LoadTenderLineItem	16
MonetaryAdjustment	19
LoadTenderSummary	25
LoadTenderResponse Root Element	26
LoadTenderResponse	26
Primary Elements	29
LoadTenderResponseHeader	29
LoadTenderResponseSegment	33
LoadTenderResponseLineItem	37
MonetaryAdjustment	40
LoadTenderResponseSummary	46
LoadTender Business Scenarios	48
LoadTender and LoadTenderResponse Scenario Listing	48
Scenario A	48
Scenario B	49
Scenario C	50
Scenario D	50
Scenario E	51
Scenario F	52
Scenario G	53
Scenario H	53
Scenario I	54
Scenario J	55
Scenario K	56
Scenario L	57
Scenario M	58
Scenario N	59
Scenario o	60
Scenario P	60

LoadTender

papiNet Standard - Version 2.31

LoadTender & LoadTenderResponse Documentation

LoadTender e-Document Overview

The LoadTender e-Document supports the transport booking process. Transport booking includes the following steps:

- LoadTender – more than one carrier has been informed about the upcoming transport.
- Booking – identifies a transport booking that is part of a detail transport plan, the load has been booked with a single carrier.

LoadTender Scope

The booking process, which is supported by the LoadTender e-document, is used to forward information and associated basic booking data on upcoming transports for pre-booking, booking and load tender phases, including responses.

LoadTenderType [attribute]

Code indicating the function of the LoadTender e-Document.

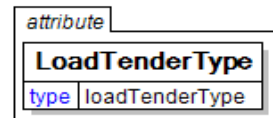

This item is restricted to the following list.

PreBooking

A requirement for a transport vehicle or unit reservation that has arisen from a rough transport plan.

Booking

An indication that time for a service is required. For example a booking that is part of a detail transport plan.

LoadTender

More than one carrier has been informed about the upcoming transport requirement (the load).

Business Rules for LoadTender

General Business Rules

The following table list the business rules that apply to the booking process(es).

Identifier	Business Rule
LT001	Transport booking process refers to a LoadTenderNumber, which is the unique alphanumeric identifier.
LT002	Basic booking process data may include data of ShipFromLocationParty, ShipToParty, reloading

LoadTender

papiNet Standard - Version 2.31

Identifier	Business Rule
	locations and amount of to be delivered goods on a certain day within a certain time range.
LT003	Booking process may include information on certain loading / unloading characteristics (instructions / restrictions).
LT004	e-Document structure (see charts above) initially allows multiple booking references (stowage modes) on a single transport mode.
LT005	ShipToCharacteristics may appear at either the LoadTenderHeader / LoadTenderResponse Header or the LoadTenderSegment / LoadTenderResponseSegment depending on transport requirements. The information in the LoadTenderSegment / LoadTenderResponseSegment overrides the information at the LoadTenderHeader / LoadTenderResponseHeader.
LT006	TransportInformation may appear at either the LoadTenderHeader / LoadTenderResponse Header or the LoadTenderSegment / LoadTenderResponseSegment depending on transport requirements. The information in the LoadTenderSegment / LoadTenderResponseSegment overrides the information at the LoadTenderHeader / LoadTenderResponseHeader.
LT007	[obsolete]
LT008	All transport orders, assigned to the same CoLoadingIdentifier have to be in one LoadTender e-Document.
LT009	The booking e-Document can only be accepted or declined as a whole; deletion of specific LoadTenderSegment's is not permitted.

Processing the LoadTender

Triggers

The booking process (the LoadTender e-Document provides the data for the transport booking process) can be triggered during order entry and/or at transport planning. The booking process includes new bookings as well as changes to associated booking data.

LoadTender

papiNet Standard - Version 2.31

Confirmation

Confirmation can be provided using either the LoadTenderResponse or via the papiNet BusinessAcknowledgment e-Document, depending on the trading partner agreement.

Understanding the Diagrams and Content

This section provides a graphical view of the schema structures, a discussion of the item's children. You can find additional information about papiNet and the standard at www.papiNet.org.

The graphics contain content model indicators, cardinality indicators, and data type information.

Associated with each graphic are the definitions for the parent item and any associated child items. All attributes are listed first, followed by the elements.

The following information should help you interpret and understand this standard. Please note the following:

- Content Model and Cardinality operate together to determine if the element or attribute are required in the instance document.
- The same attribute can never appear multiple times in the same element so, you will never see a multiple cardinality indicator.

Content model indicators:

There are three possible types of content: "sequence", "choice", and "all". The papiNet standard currently does not use the "all" construct.

- (sequence)

The sequence of the items to the right of the graphic (or below the text) is required.

- (choice)

A choice of the items to the right of the graphic (or below the text) is permitted.

- (all)

All the items to the right of the graphic are required.

Cardinality indicators:

- Dotted line around element or attribute.

A single instance of the item can optionally exist.

- Dotted line around item with range indicated below.

Multiple instances of the item can optionally exist.

- Solid line around item.

A single instance of the item must exist.

- Solid line around item with range indicated below

At least one instance must exist; multiple instances can optionally exist.

Datatype indication:

When a data type is assigned to an element (either a simple type or complex type) the name of the data type is presented beneath the item name in the graphic.

- In some cases additional information about the data type is presented

LoadTender

papiNet Standard - Version 2.31

(the default value).

Elements can either have content that is textual/numeric in nature or content that is made up of additional elements and/or attributes.

- When the content is textual/numeric in nature “three straight horizontal lines” will appear in the upper left-hand corner of the graphic. Pay attention to these elements because they are where you will be entering your information.
- When the content is made up of additional elements and/or attributes a “gray-box” will appear on the right-hand side of the graphic.
- If the graphic shows both the horizontal lines and the gray-box then, in the papiNet standard, the content below the element are attributes.

LoadTender

papiNet Standard - Version 2.31

LoadTender Root Element

LoadTender

The LoadTender element is the root element for the LoadTender e-Document.

The LoadTender e-Document supports the transport booking process. Transport booking includes the following steps:

- LoadTender – more than one carrier has been informed about the upcoming transport.
- Booking – identifies a transport booking that is part of a detail transport plan, the load has been booked with a single carrier.

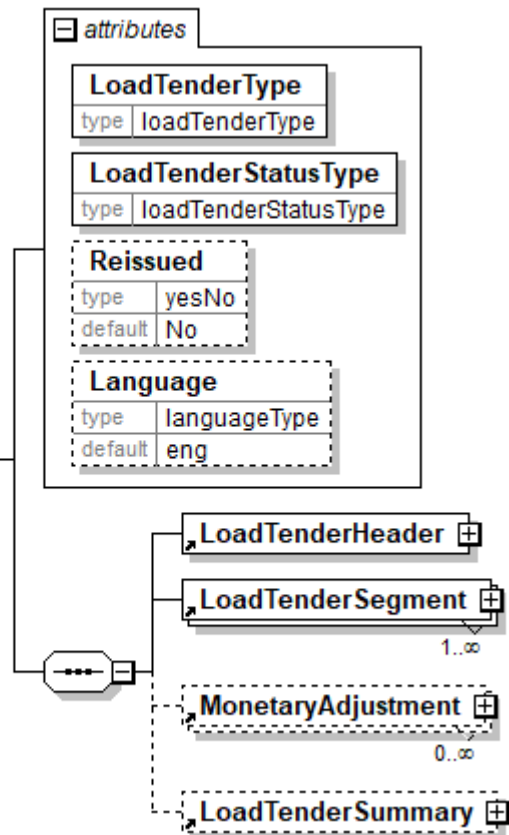

LoadTenderStatusType [attribute]

LoadTenderStatusType is mandatory. A single instance is required.

Identifies the status of the entire LoadTender e-Document (in other words, at the root level).

This item is restricted to the following list.

Amended

The supplied information is changed.

Cancelled

The supplied information has been cancelled. Items that have been cancelled are not included in totals on the summary levels of the e-document.

Original

The supplied information is the first version of that information.

LoadTenderType [attribute]

LoadTenderType is mandatory. A single instance is required.

Code indicating the function of the LoadTender e-Document

This item is restricted to the following list.

PreBooking

A requirement for a transport vehicle or unit reservation that has risen from a rough transport plan.

Booking

An indication that time for a service is required. For example a booking that is part of a detail transport plan.

LoadTender

More than one carrier has been informed about the upcoming transport requirement (the load).

LoadTender

papiNet Standard - Version 2.31

Language [attribute]

Language is optional. A single instance might exist.

The valid Alpha 2- and Alpha 3-character list of language codes in the ISO 639-1 and 639-2 international standards.

Information on the content of this attribute is available at:
https://www.loc.gov/standards/iso639-2/php/code_list.php

Reissued [attribute]

Reissued is optional. A single instance might exist.

Either "Yes" or "No".

This item is restricted to the following list.

Yes

No

(sequence)

The contents of (sequence) are mandatory. A single instance is required.

LoadTenderHeader

LoadTenderHeader is mandatory. A single instance is required.

The LoadTenderHeader contains information common to the entire LoadTender.

LoadTenderSegment

LoadTenderSegment is mandatory. One instance is required, multiple instances might exist.

The details for a particular load segment.

MonetaryAdjustment

MonetaryAdjustment is optional. Multiple instances might exist.

The element containing the information necessary for the understanding, calculation, and treatment of an adjustment to a currency amount. MonetaryAdjustment contains an attribute that indicates the type of adjustment being communicated.

LoadTenderSummary

LoadTenderSummary is optional. A single instance might exist.

Summary information that applies to the entire LoadTender e-Document.

LoadTender

papiNet Standard - Version 2.31

Primary Elements

LoadTenderHeader

The LoadTenderHeader contains information common to the entire LoadTender.

LoadTenderHeaderStatusType [attribute]

LoadTenderHeaderStatusType is mandatory. A single instance is required.

Identifies the status of the header of the LoadTender e-Document.

This item is restricted to the following list.

Amended

The supplied information is changed

Cancelled

The supplied information has been cancelled. Items that have been cancelled are not included in totals on the summary levels of the e-document.

Original

The supplied information is the first version of that information.

IsPartialConfirmationsAllowed [attribute]

IsPartialConfirmationsAllowed is optional. A single instance is might exist.

Specifies if partial confirmations are allowed or not, e.g. confirmations of one segment only. Default value is No.

This item is restricted to the following list.

Yes

No

(sequence)

The sequence of items below is mandatory. A single instance is required.

LoadTenderNumber

LoadTenderNumber is mandatory. A single instance is required.

The identifier for the LoadTender e-Document.

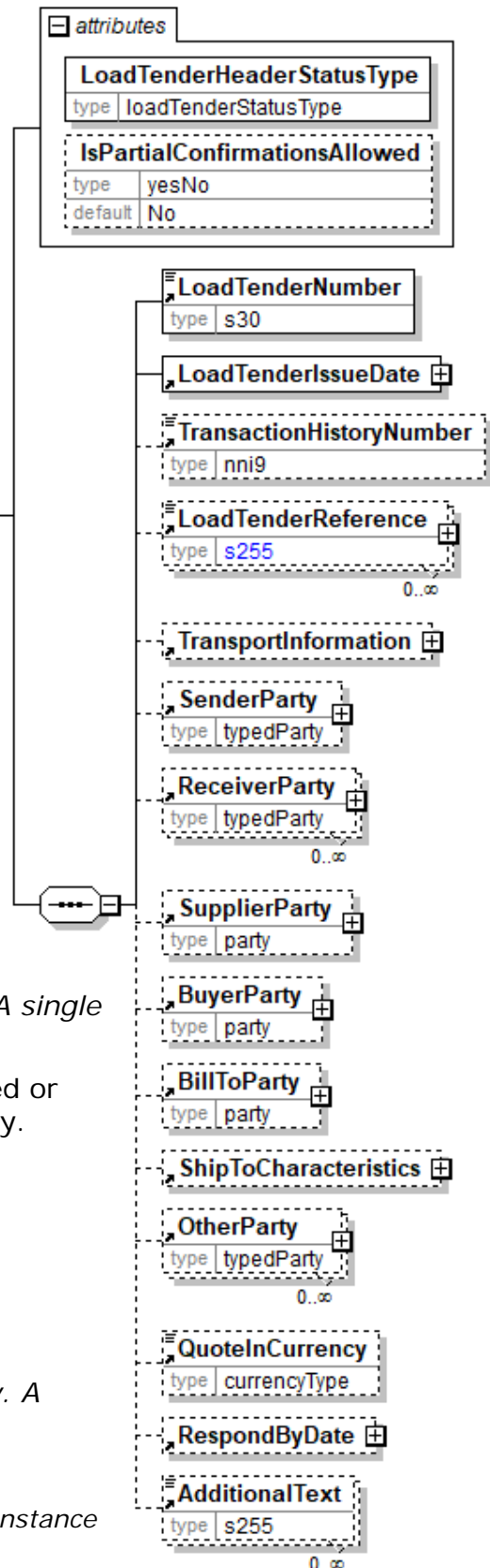

LoadTender

papiNet Standard - Version 2.31

LoadTenderIssueDate

LoadTenderIssueDate is mandatory. A single instance is required.

The date when the e-Document was issued.

TransactionHistoryNumber

TransactionHistoryNumber is optional. A single instance might exist.

A sequential number that keeps track of the version of a document being sent by the document originator. However when the document is a confirmation document, in which case the TransactionHistoryNumber refers to the trigger transaction for which the confirmation is being sent.

LoadTenderReference

LoadTenderReference is optional. Multiple instances might exist.

An item detailing relevant references pertaining to the LoadTender. The type of reference is identified by the LoadTenderReferenceType attribute.

TransportInformation

TransportInformation is optional. A single instance might exist.

A grouping element for transport information.

SenderParty

SenderParty is optional. A single instance might exist.

The business entity issuing the e-Document, the source of the document.

- The entity responsible for the content. If the sender party has out sourced the message service to a third party the SenderParty is the issuer of the e-Document and not the party performing the transmission service of the electronic message.

ReceiverParty

ReceiverParty is optional. Multiple instances might exist.

The business entity for whom the e-Document is intended, the destination of the document.

- The entity interested in the content. If the receiver party has outsourced the message service to a third party the ReceiverParty is the intended party for the e-Document and not the party performing the receiving service of the electronic message.

SupplierParty

SupplierParty is optional. A single instance might exist.

The organisation or business entity responsible for providing the product.

SupplierParty is also the seller of the product, if Seller is not specified as OtherParty = Seller.

BuyerParty

BuyerParty is optional. A single instance might exist.

The legal entity to which the product is sold. Also commonly referred to as the sold-to party or customer. If no OtherParty is defined as the Payer, the Buyer is the Payer.

BillToParty

BillToParty is optional. A single instance might exist.

The address where the invoice is to be sent.

LoadTender

papiNet Standard - Version 2.31

ShipToCharacteristics

ShipToCharacteristics is optional. A single instance might exist.

A group item that provides information important for the Ship-To Party.

OtherParty

OtherParty is optional. Multiple instances might exist.

An organisation or business entity other than those specifically detailed within a e-Document.

QuoteInCurrency

QuoteInCurrency is optional. A single instance might exist.

Indicates that the quote is to be provided in the currency specified.

A three-character ISO 4217 currency code in capital letters. The ISO standard classification for currencies. Refer to the ISO standard for information about the choices for the enumerations.

<https://www.iso.org/iso-4217-currency-codes.html>

RespondByDate

RespondByDate is optional. A single instance might exist.

The date that a response to the query is required.

AdditionalText

AdditionalText is optional. Multiple instances might exist.

A text field that is used to communicate information not previously defined or for special instructions. To be used only for circumstances not covered by specific elements.

LoadTender

papiNet Standard - Version 2.31

LoadTenderSegment

The details for a particular load segment.

LoadTenderSegmentStatusType [attribute]

LoadTenderSegmentStatusType is mandatory. A single instance is required.

Identifies the status of the LoadTender segment.

This item is restricted to the following list.

Amended

The supplied information is changed

Cancelled

The supplied information has been cancelled. Items that have been cancelled are not included in totals on the summary levels of the e-document.

NoAction

The supplied information has not been amended and thereby requires no action.

Original

The supplied information is the first version of that information.

LoadTenderSegmentDocumentStatus [attribute]

LoadTenderSegmentDocumentStatus is optional. A single instance might exist.

Defines the actual document status for the LoadTenderSegment.

This item is restricted to the following list.

Cancelled

The supplied information of the document item is cancelled. Items that have been cancelled are not included in totals on the summary level of e-documents.

Requested

The supplied information of the document item is ordered.

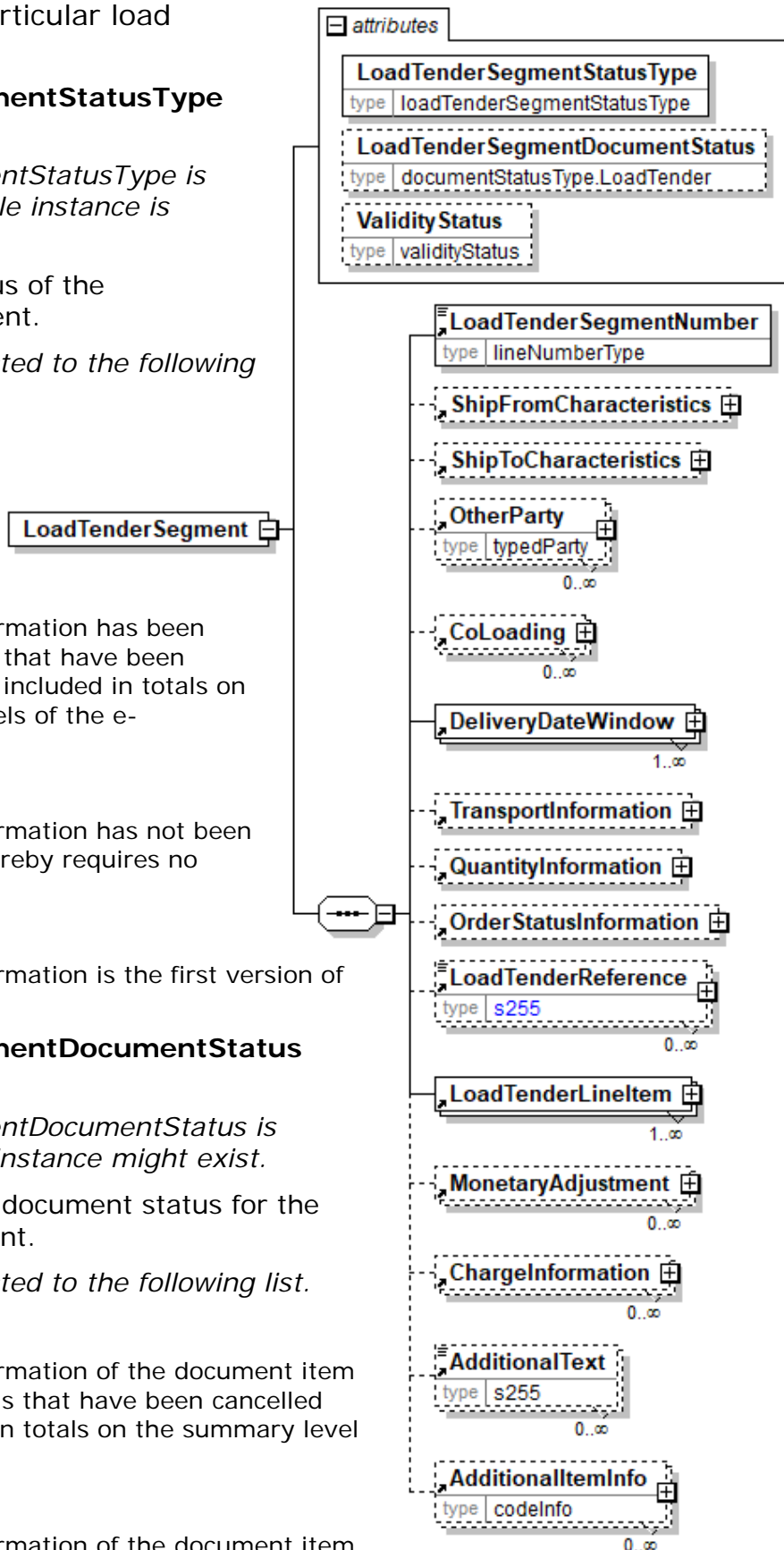

LoadTender

papiNet Standard - Version 2.31

ValidityStatus [attribute]

ValidityStatus is optional. A single instance might exist.

The validity status for a specific item.

This item is restricted to the following list.

Active

The item is active. Business transactions can be executed with reference to the item during the validity period.

Closed

The item is terminated or completed. Business transactions cannot be executed with reference to the item.

Pending

The item is preliminary or unfinished. Business transactions cannot be executed with reference to the item.

(sequence)

The sequence of items below is mandatory. A single instance is required.

LoadTenderSegmentNumber

LoadTenderSegmentNumber is mandatory. A single instance is required.

The identifier for the LoadTender segment.

ShipFromCharacteristics

ShipFromCharacteristics is optional. A single instance might exist.

A group item that provides information pertaining to the Ship-From Party.

ShipToCharacteristics

ShipToCharacteristics is optional. A single instance might exist.

A group item that provides information important for the Ship-To Party.

OtherParty

OtherParty is optional. Multiple instances might exist.

An organisation or business entity other than those specifically detailed within a e-Document.

CoLoading

CoLoading is optional. Multiple instances might exist.

A group item specifying information about items to be loaded or loaded on the same transport unit.

Used to identify:

- Delivery together to the drop point
- Transport Orders stuffed together in a container
- Transport Orders not splittable

DeliveryDateWindow

DeliveryDateWindow is mandatory. One instance is required, multiple instances might exist.

A group item defining the date/time interval for delivery to take place. An element which may contain the estimated date for which delivery is expected. This date is not absolute.

LoadTender

papiNet Standard - Version 2.31

TransportInformation

TransportInformation is optional. A single instance might exist.

A grouping element for transport information.

QuantityInformation

QuantityInformation is optional. A single instance might exist.

A group item containing information about quantity and informational quantity of similar items.

OrderStatusInformation

OrderStatusInformation is optional. A single instance might exist.

A group element that stores two levels of order status codes.

LoadTenderReference

LoadTenderReference is optional. Multiple instances might exist.

An item detailing relevant references pertaining to the LoadTender. The type of reference is identified by the LoadTenderReferenceType attribute.

LoadTenderLineItem

LoadTenderLineItem is mandatory. One instance is required, multiple instances might exist.

Group element identifying a line item to be included within this LoadTender Segment.

MonetaryAdjustment

MonetaryAdjustment is optional. Multiple instances might exist.

The element containing the information necessary for the understanding, calculation, and treatment of an adjustment to a currency amount. MonetaryAdjustment contains an attribute that indicates they type of adjustment being communicated.

ChargeInformation

ChargeInformation is optional. Multiple instances might exist.

A group element that contains elements that describe a charge. ChargeInformation is used when charge details need to be specified by using a code assigned by an agency. It is typically used for freight costs and other costs related to the supply chain.

AdditionalText

AdditionalText is optional. Multiple instances might exist.

A text field that is used to communicate information not previously defined or for special instructions. To be used only for circumstances not covered by specific elements.

AdditionalItemInfo

AdditionalItemInfo is optional. Multiple instances might exist.

A grouping element that contains information about additional items specified by an agency. Restricted use of this element is recommended.

LoadTender

papiNet Standard - Version 2.31

LoadTenderLineItem

Group element identifying a line item to be included within this LoadTender Segment.

(sequence)

The sequence of items below is mandatory. A single instance is required.

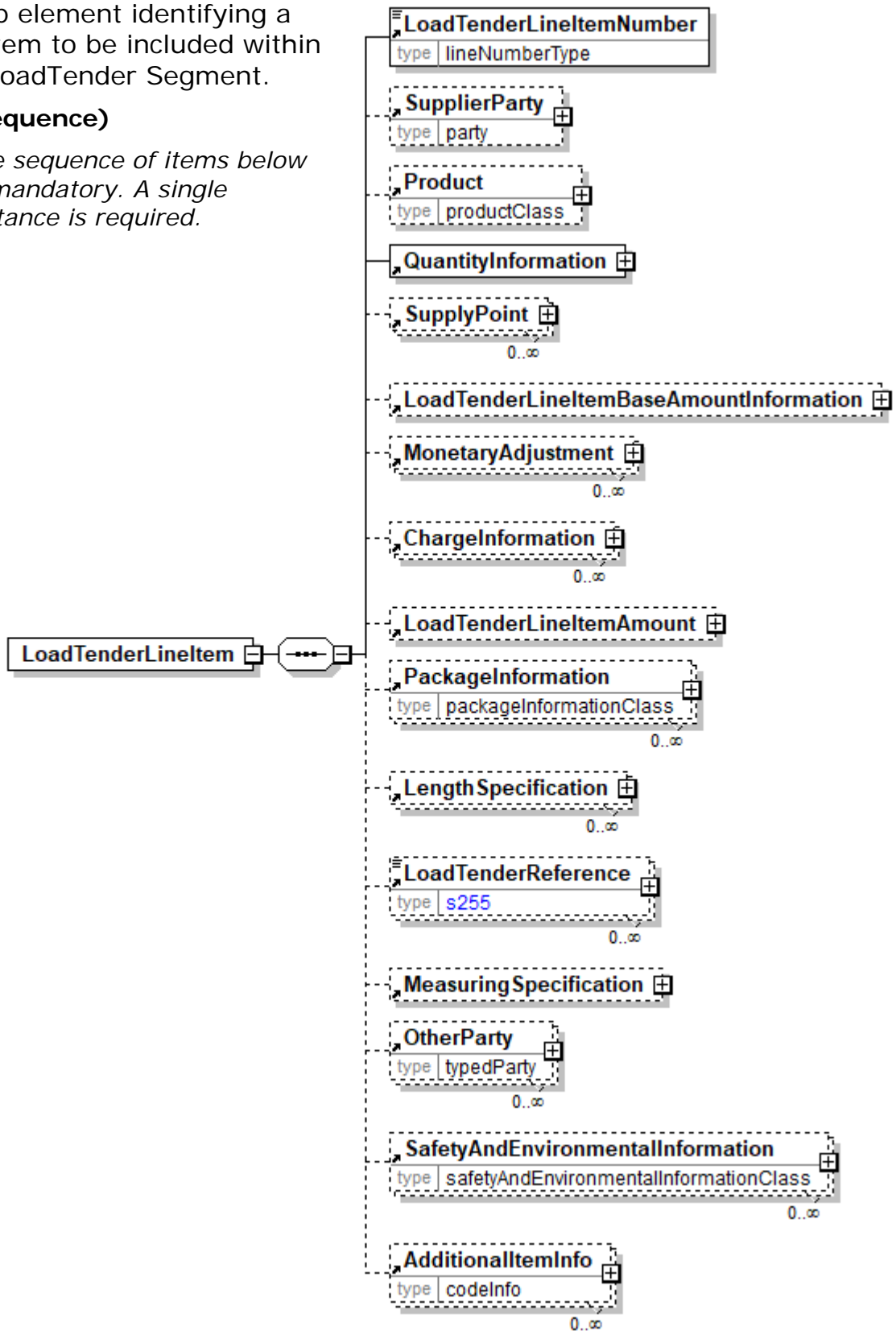

LoadTenderLineItemNumber

LoadTenderLineItemNumber is mandatory. A single instance is required.

LoadTender

papiNet Standard - Version 2.31

The sequential number that uniquely identifies the LoadTender line item.

SupplierParty

SupplierParty is optional. A single instance might exist.

The organisation or business entity responsible for providing the product. SupplierParty is also the seller of the product, if Seller is not specified as OtherParty = Seller.

Product

Product is optional. A single instance might exist.

Product is a group item defining the article and its characteristics. Product is used to specify product characteristics organized by ProductIdentifier, ProductDescription, and Classification. Book Manufacturing, Label Stock, Paper, Pulp, Recovered Paper, Wood Products, and Virgin Fibre market segments have defined their product characteristics and conversion features for implementation in papiNet.

QuantityInformation

QuantityInformation is mandatory. A single instance is required.

A group item containing information about quantity and informational quantity of similar items.

SupplyPoint

SupplyPoint is optional. Multiple instances might exist.

Grouping element that contains items describing a supply point. A SupplyPoint belongs to a LocationParty, e.g. in a DeliveryOrigin or DeliveryDestination, and describes where goods are stored and can be loaded or unloaded. A SupplyPoint can for example be a loading or unloading gate at a warehouse or a road side landing at a logging area in the forest.

LoadTenderLineItemBaseAmountInformation

LoadTenderLineItemBaseAmountInformation is optional. A single instance might exist.

Group element used to detail the LoadTender Line Item's PriceDetails and TotalAmount. Normally used to identify the PricePerUnit of the line item.

MonetaryAdjustment

MonetaryAdjustment is optional. Multiple instances might exist.

The element containing the information necessary for the understanding, calculation, and treatment of an adjustment to a currency amount. MonetaryAdjustment contains an attribute that indicates the type of adjustment being communicated.

ChargeInformation

ChargeInformation is optional. Multiple instances might exist.

A group element that contains elements that describe a charge. ChargeInformation is used when charge details need to be specified by using a code assigned by an agency. It is typically used for freight costs and other costs related to the supply chain.

LoadTenderLineItemAmount

LoadTenderLineItemAmount is optional. A single instance might exist.

Total amount of the LoadTenderLineItem including charges, adjustments and tax

LoadTender

papiNet Standard - Version 2.31

(when tax is specified on the load tender line item).

LoadTenderLineItemAmount is equal to the LoadTenderAmount plus the sum of the signed values of the ChargeAmount for all instances of ChargeInformation plus the sum of the signed values of the MonetaryAdjustmentAmount for all instances of MonetaryAdjustment.

PackageInformation

PackageInformation is optional. Multiple instances might exist.

The purpose of the PackageInformation structure is to clearly identify physical handling items that constitute the delivery.

PackageInformation is the highest level of product packaging it describes the shipping or warehousing unit.

- If you are communicating a package, usually for logistics or transport purposes, you should include the PackageType, Identifier, ItemCount, and Quantity. (Note: you still have the ability to describe the item with one of the "named" items.)
- If you are communicating one of the named Items there is no need to include PackageType, Identifier, ItemCount, and Quantity.

Since either of these two approaches can be used the entire contents of this element are optional even though the parent may be required. It is expected that you will fill in the appropriate details.

LengthSpecification

LengthSpecification is optional. Multiple instances might exist.

Length specification of the wood product.

LoadTenderReference

LoadTenderReference is optional. Multiple instances might exist.

An item detailing relevant references pertaining to the LoadTender. The type of reference is identified by the LoadTenderReferenceType attribute.

MeasuringSpecification

MeasuringSpecification is optional. A single instance might exist.

A grouping element that contains a specification for measurement procedures.

OtherParty

OtherParty is optional. Multiple instances might exist.

An organisation or business entity other than those specifically detailed within a e-Document.

SafetyAndEnvironmentalInformation

SafetyAndEnvironmentalInformation is optional. Multiple instances might exist.

Name of certification type, if any, on the goods (For example, FSC, PEFC). SafetyAndEnvironmental needs a value or measurement to communicate the percentage of the product is certified (for example, 75% is certified by the indicated agency).

AdditionalItemInfo

AdditionalItemInfo is optional. Multiple instances might exist.

A grouping element that contains information about additional items specified by an agency. Restricted use of this element is recommended.

MonetaryAdjustment

The element containing the information necessary for the understanding, calculation, and treatment of an adjustment to a currency amount. MonetaryAdjustment contains an attribute that indicates they type of adjustment being communicated.

MonetaryAdjustment

AdjustmentType [attribute]

AdjustmentType is mandatory. A single instance is required.

Describes the type of adjustment applied to a monetary oriented element. Adjustment values should always be given as negative or positive adjustments even if AdjustmentType indicates the sign. For example, a rebate of 1% on an invoice should be given as an adjustment percentage of -1%.

This item is restricted to the following list.

BillOfLadingCharge

An extra charge for creating a Bill of Lading.

CancellationCharge

A charge applied because a cancellation was late (after the last date of change) and all or part of the ordered product has already been made.

CashDiscount

A reduction due to a discount applied.

CertificateCharge

An extra charge for creating a certificate. Some countries requires Certificates in which different characteristics of the delivery, transport unit, route, product, and others must be proved.

There are certificates for gasen pallets, for the place of production, for the age of the ship/vessel, for not departing from one country's harbour when delivering to

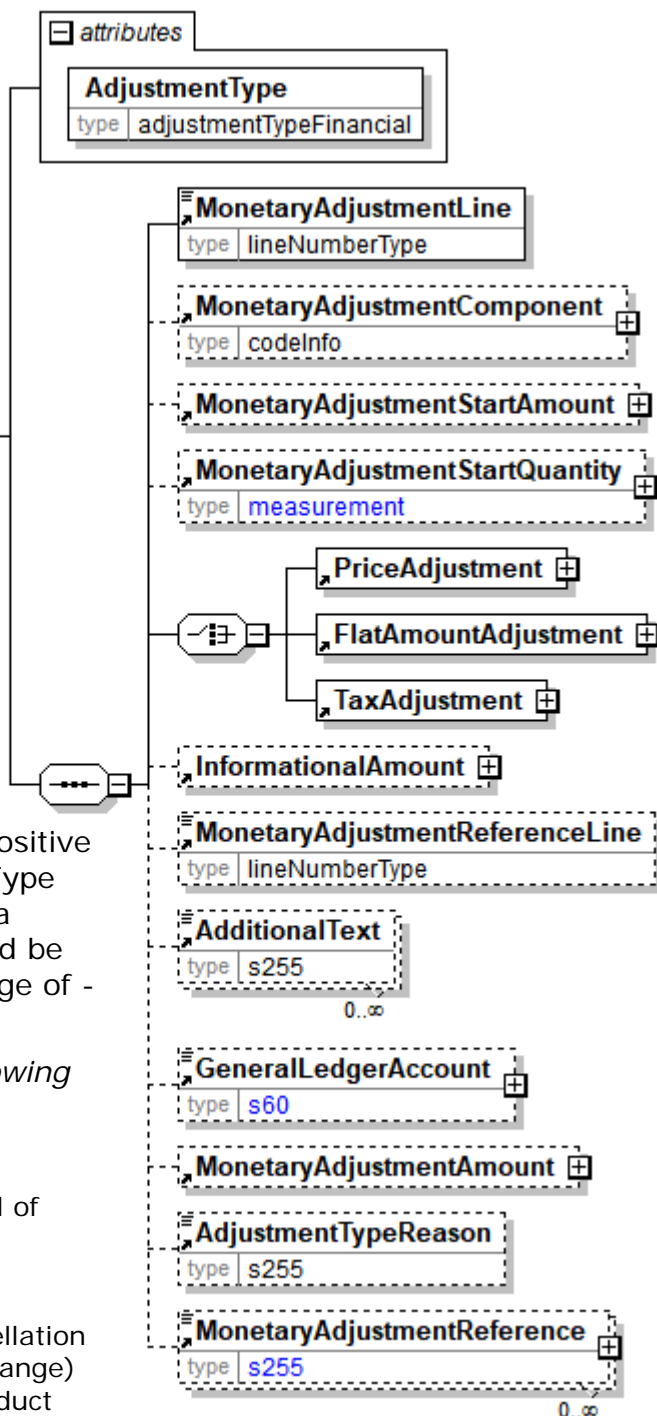

LoadTender

papiNet Standard - Version 2.31

another.

ChargesForward

A pending invoice amount brought forward from a previous Invoice.

ClaimAdjustment

An adjustment related to a filed complaint.

Commission

Commission costs paid to the trading agency or trader.

CompetitiveAllowance

An allowance provided for competitive reasons.

CongestionCharge

An extra fee from ports for waiting time of ships in ports, railcars on a siding, trucks at a dock. (Synonym: Demurrage.)

ConsigneeUnloadCharge

An unloading charge that is the responsibility of the consignee.

ContractAllowance

An allowance for a volume discount, usually because the agreed amount has been exceeded.

CurrencyAdjustmentCharge

An extra fee to adjust for currency variations.

DecimalRounding

Adjustments for rounding of amounts to fit the business agreement or national monetary legislation. This adjustment is typically used for decimal rounding of amounts not including tax.

N.B. Use InformationalAmount with AmountType "DecimalRounding" for specification of decimal rounding of amounts including tax.

DefectiveAllowance

An allowance provided for defective material.

DeliveryCharge

The charge for delivering the product.

DeliveryNonConformanceAllowance

An allowance due to non-conformance with the purchase agreement regarding a delivery.

DeliveryTimeBonus

A bonus given for deliveries of products within a certain time period.

EarlyShipAllowance

An allowance due to a delivery that took place earlier than planned. The seller may be charged a penalty. If this is found before issuing the Invoice, it can be handled through this allowance. If found later, it will be handled through a credit note.

EnergySurcharge

A charge related to increases in the cost of energy.

Environmental

LoadTender

papiNet Standard - Version 2.31

An allowance applied due to environmental regulations.

ExpeditedShipmentCharge

An extra cost charged due to unexpected or emergency requirements (for example, breaking off a run in the mill to reach the production date for a rush order).

ExportClearanceCharge

An extra fee for customs administration.

FlatRateCharge

A general flat charge.

FreightAllowance

The freight cost allowed by the mill. This amount is negative, and will be deducted from the Invoice (U.S. business practice, in the European Union (EU), use only Freight Charge).

FreightCharge

The actual cost incurred to deliver the product. This amount is positive, and will be added to the Invoice.

FuelAdjustmentCharge

An extra fee, usually from shipping companies, to adjust fuel prices.

HandlingCharge

A charge related to the handling of the product.

Inspection

The cost associated with performing an inspection of the product.

InterestCharge

A charge applied for interest on overdue payments.

LabourAllowance

An allowance due to additional labour required in the use or acceptance of the product.

LabourCharge

A charge due to additional labour required in the use or acceptance of the product.

LoggingDamage

An adjustment caused by logging damages on Forest Wood products. Logging damages normally cause a reduction of the product price.

LotCharge

A charge applied to the lot of material.

MetalDetection

A charge for additional metal detection applied to the goods.

ModelHomeDiscount

A discount associated with the building of the model home.

NewStoreCouponDiscount

A discount associated with entry into a new store.

OrderQuantity

LoadTender

papiNet Standard - Version 2.31

A charge or allowance for small/big ordered quantities.

PalletCharge

A charge that represents the cost or rental of the pallet.

PickUpAllowance

An allowance provided to compensate for the cost of picking up the product.

PromotionalAllowance

An allowance provided for the promotion of the product.

PromotionalCharge

A charge associated with the promotion of the product.

PriceCorrection

An adjustment associated with a correction of the product's price.

ProductionSetUpCharge

A special charge applied due to specific buyer requests.

Provision

The act of making ready or equipping for use.

Rebate

A rebate accepted by the buyer and seller based on the agreed price and volume.

ReelDiscount

An allowance for purchasing reels instead of sheets.

ReturnedLoadAllowance

An allowance applied due to the return of the load.

ReturnLoadCharge

A charge applied due to the return of the load.

RoadFeeCharge

A freight charge for a special tax applied to road transports in some countries, e.g. Germany

ScrapAndDunnageCharge

A charge that represents the scrapping of the material and its removal.

ServiceCharge

A charge associated with a miscellaneous service.

SpecialConversionCharge

Additional charge for a special conversion of the product.

SpecialDeliveryCharge

A special charge for delivering the product differently from the usual or agreed-to method.

SpecialHandlingCharge

A special charge for handling the product differently from the usual or agreed-to method.

SpecialPackagingCharge

LoadTender

papiNet Standard - Version 2.31

A special charge for packaging the product differently from the usual or agreed-to method, or if packaging as requested is out of spec.

StopOffAllowance

An allowance for a delivery stop-off.

StopOffCharge

A charge for a delivery stop-off.

StorageAllowance

An allowance for storing the product.

StorageCharge

An extra cost charged for storing the product on location (in the plant).

Tax

An adjustment that reflects a tax item.

TestingCharge

A charge related to testing a paper grade.

TradeDiscount

A discount based on the terms of the trade given on the agreed price. Usually a percentage.

TrialDiscount

A discount applied for a trial run of a new or improved product.

TransferCharge

A freight charge incurred by the goods transfer from one location to another location not previously agreed upon.

UnloadingAllowance

An allowance to compensate for the unloading the product.

UnloadingCharge

A charge for the unloading the product.

VolumeDiscount

A rebate accepted by the buyer and the seller based on the agreed volume

WarRiskCharge

An extra fee from transport companies for transport units that cross war zones.

Other

Any other adjustment not covered by the attribute list.

(sequence)

The sequence of items below is mandatory. A single instance is required.

MonetaryAdjustmentLine

MonetaryAdjustmentLine is mandatory. A single instance is required.

A sequence number indicating the order of printing or the sequence in which a group of adjustments are to be considered.

MonetaryAdjustmentComponent

MonetaryAdjustmentComponent is optional. A single instance might exist.

LoadTender

papiNet Standard - Version 2.31

A group item that contains information for specifying a monetary adjustment component by a code assigned by an agency.

MonetaryAdjustmentStartAmount

MonetaryAdjustmentStartAmount is optional. A single instance might exist.

The beginning currency amount used in the calculation of a monetary adjustment.

MonetaryAdjustmentStartQuantity

MonetaryAdjustmentStartQuantity is optional. A single instance might exist.

The beginning quantity used in the calculation of a monetary adjustment.

(choice)

[choice] is optional because of choice construct.

PriceAdjustment

PriceAdjustment is optional because of choice construct.

A group item defining a deviation from the PricePerUnit.

FlatAmountAdjustment

FlatAmountAdjustment is optional because of choice construct.

A group item that contains flat adjustment amount information.

TaxAdjustment

TaxAdjustment is optional because of choice construct.

This content element contains the necessary information to describe, calculate, and handle a tax adjustment.

InformationalAmount

InformationalAmount is optional. A single instance might exist.

A monetary amount used for information purposes only (not for calculation). For example, the invoice price adjustment subtotal is expressed in sterling pounds, and the buyer wants this information expressed in U.S. dollars.

- CreditDebitNote and Invoice - The TaxAmount is displayed in the currency that is applicable throughout the e-Document. When a TaxAmount needs to be displayed in a different national currency, this field is used.

MonetaryAdjustmentReferenceLine

MonetaryAdjustmentReferenceLine is optional. A single instance might exist.

A link to a previously defined MonetaryAdjustmentLine upon which this adjustment is based.

AdditionalText

AdditionalText is optional. Multiple instances might exist.

A text field that is used to communicate information not previously defined or for special instructions. To be used only for circumstances not covered by specific elements.

GeneralLedgerAccount

GeneralLedgerAccount is optional. A single instance might exist.

The general ledger account to be referenced for the item.

MonetaryAdjustmentAmount

MonetaryAdjustmentAmount is optional. A single instance might exist.

LoadTender

papiNet Standard - Version 2.31

The actual amount of the monetary adjustment.

AdjustmentTypeReason

AdjustmentTypeReason is optional. A single instance might exist.

Provides additional information about the type of adjustment. Can be viewed as a sub-classification of the adjustment type attribute or as a textual explanation.

MonetaryAdjustmentReference

MonetaryAdjustmentReference is optional. Multiple instances might exist.

An element detailing relevant references pertaining to the MonetaryAdjustment as indicated by MonetaryAdjustmentReferenceType and AssignedBy.

LoadTenderSummary

Summary information that applies to the entire LoadTender e-Document

(sequence)

The contents of (sequence) are mandatory. A single instance is required.

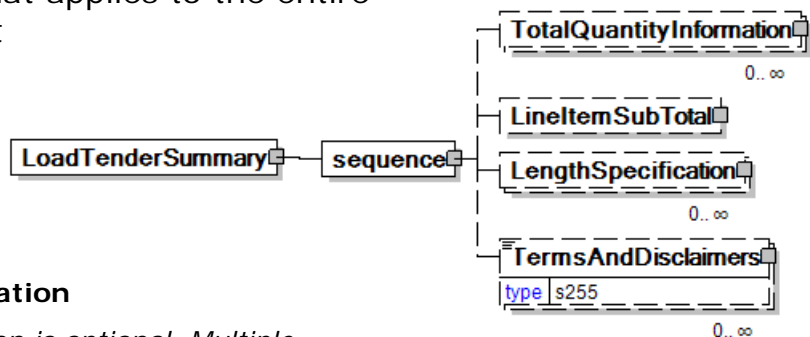

TotalQuantityInformation

TotalQuantityInformation is optional. Multiple instances might exist.

A group item containing information about the total quantity and total informational quantity of similar items in the document. TotalQuantityInformation is primarily used in the summary section of e-Documents where it is repeatable to permit totalling for different units of measure.

LinelItemSubTotal

LinelItemSubTotal is optional. A single instance might exist.

The total amount of all base amounts on e-Document line items. The base amount contains the result of the calculation quantity times the base unit price. As such it does not include any taxes. For example, in an Invoice claiming payment for products LinelItemSubTotal is equal to the sum of all InvoiceLineBaseAmount.

LengthSpecification

LengthSpecification is optional. Multiple instances might exist.

Length specification of the wood product.

TermsAndDisclaimers

TermsAndDisclaimers is optional. Multiple instances might exist.

An element that contains legal information with an indication of what the Language is.

LoadTender

papiNet Standard - Version 2.31

LoadTenderResponse Root Element

LoadTenderResponse

The LoadTenderResponse element is the root element for the LoadTenderResponse e-Document.

The LoadTenderResponse e-Document supports the transport booking process and is used as a response e-Document to LoadTender e-Document. Transport booking includes the following steps:

- **LoadTenderResponse** – more than one carrier has been informed about the upcoming transport.
- **BookingConfirmation** – identifies a transport booking that is part of a detail transport plan, the load has been booked with a single carrier.

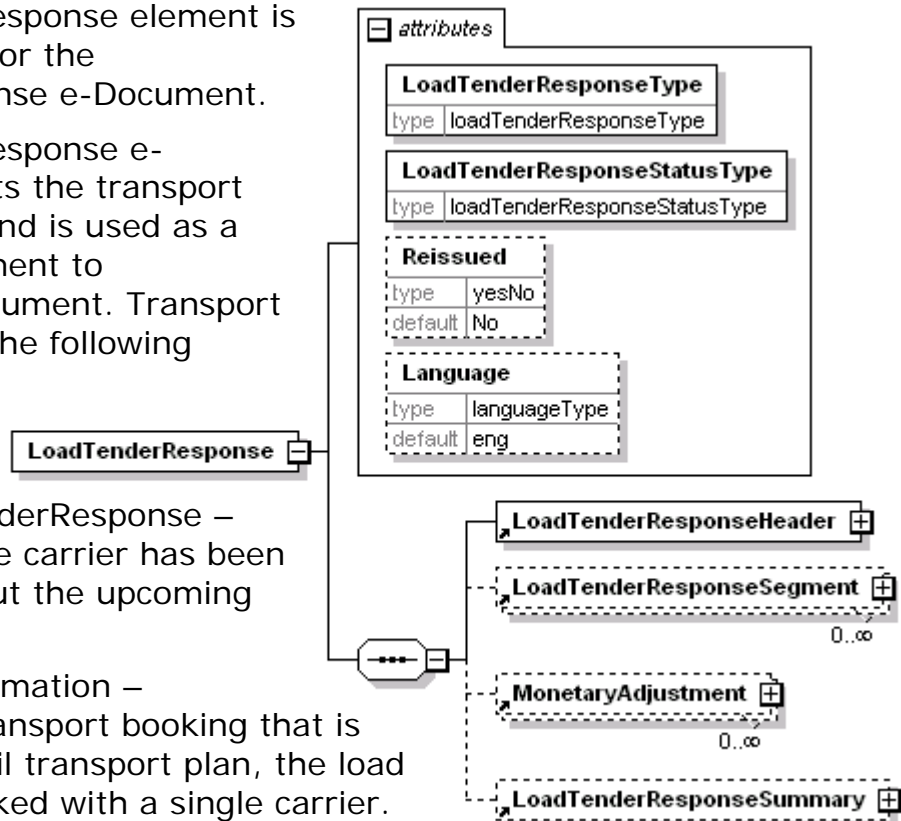

The LoadTenderResponse provides a means of communicating these events.

LoadTenderResponseType [attribute]

LoadTenderResponseType is mandatory. A single instance is required.

Code indicating the function of the e-Document.

This item is restricted to the following list.

PreBookingConfirmation

A communication of the requirement for a transport vehicle or unit reservation that has risen from a rough transport plan.

BookingConfirmation

A communication affirming the placement of the booking with a particular party.

LoadTenderResponse

Indicates the ability of the respondent to fulfill the LoadTender request.

Reissued [attribute]

Reissued is optional. A single instance might exist.

Either "Yes" or "No".

This item is restricted to the following list.

Yes

LoadTender

papiNet Standard - Version 2.31

No

Language [attribute]

Language is optional. A single instance might exist.

XML has embraced 2 and 3 digit language codes through the application of an addendum to the standard.

Information on the content of this attribute is available at <http://www.loc.gov/standards/iso639-2/> this is the official site of the ISO 639-2 Registration Authority.

- <http://www.w3.org/International/O-HTML-tags.html> provides an explanation of the errata updating XML.
- <http://www.ietf.org/rfc/rfc3066.txt> is the key document that is referenced in the above errata.

LoadTenderResponseStatusType [attribute]

LoadTenderResponseStatusType is mandatory. A single instance is required.

Identifies the status of the entire LoadTenderResponse e-Document (in other words, at the root level).

This item is restricted to the following list.

Accepted

The supplied information is accepted.

Amended

The supplied information is changed

Cancelled

The supplied information is cancelled. Items that have been cancelled are not included in totals on the summary levels of the e-Document.

Pending

The supplied information of the document item is being investigated.

Rejected

The supplied information is rejected.

(sequence)

The contents of (sequence) are mandatory. A single instance is required.

LoadTenderResponseHeader

LoadTenderResponseHeader is mandatory. A single instance is required.

The LoadTenderResponseHeader contains information common to the entire LoadTenderResponse.

LoadTenderResponseSegment

LoadTenderResponseSegment is optional. Multiple instances might exist.

The details for a particular load segment.

MonetaryAdjustment

MonetaryAdjustment is optional. Multiple instances might exist.

The element containing the information necessary for the understanding, calculation, and treatment of an adjustment to a currency amount.

LoadTender

papiNet Standard - Version 2.31

MonetaryAdjustment contains an attribute that indicates the type of adjustment being communicated.

LoadTenderResponseSummary

LoadTenderResponseSummary is optional. A single instance might exist.

Summary information that applies to the entire LoadTenderResponse e-Document

LoadTender

papiNet Standard - Version 2.31

Primary Elements

LoadTenderResponseHeader

The LoadTenderResponseHeader contains information common to the entire LoadTenderResponse.

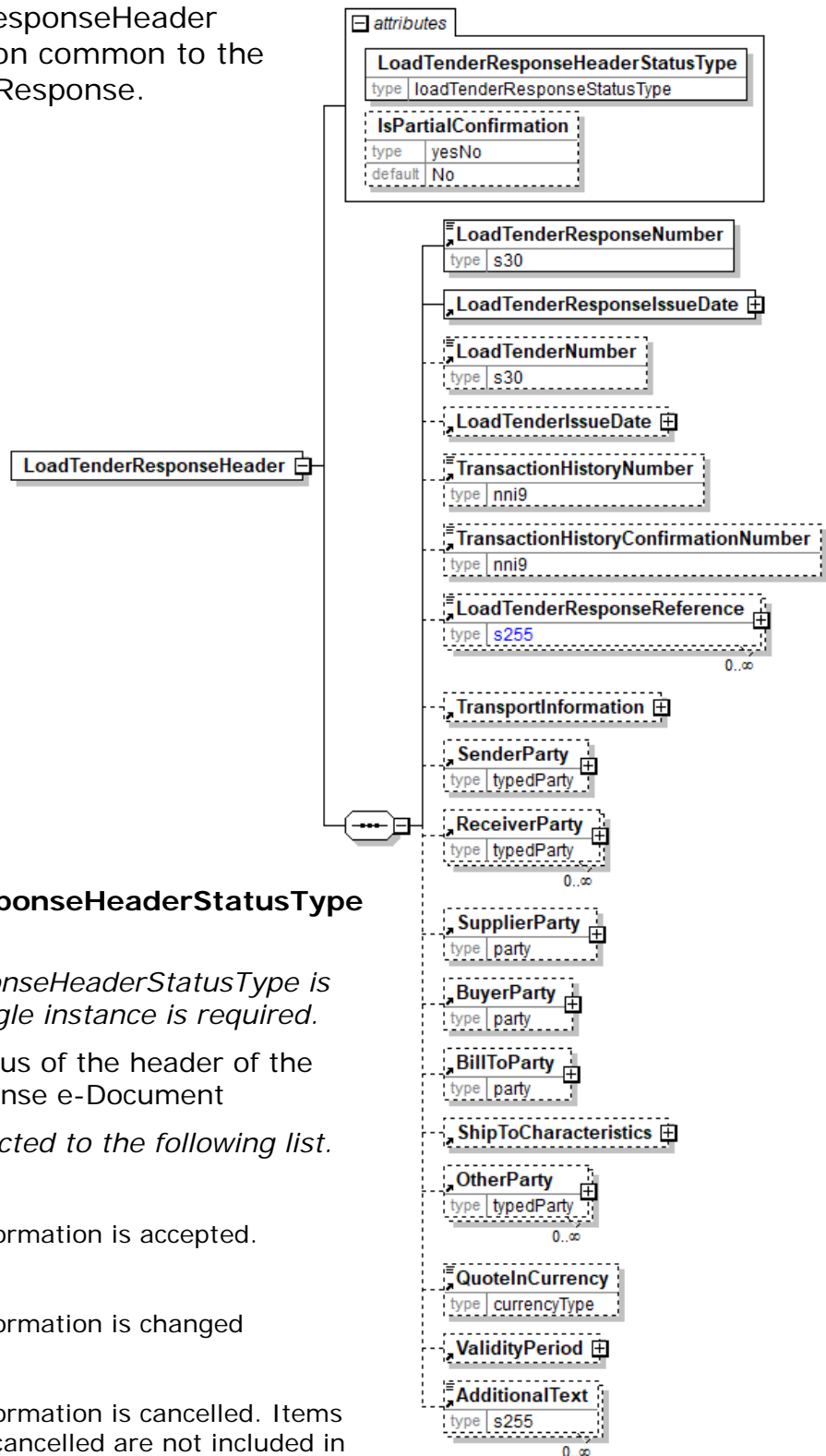

LoadTenderResponseHeaderStatusType [attribute]

LoadTenderResponseHeaderStatusType is mandatory. A single instance is required.

Identifies the status of the header of the LoadTenderResponse e-Document

This item is restricted to the following list.

Accepted

The supplied information is accepted.

Amended

The supplied information is changed

Cancelled

The supplied information is cancelled. Items that have been cancelled are not included in totals on the summary levels of the e-Document.

Pending

The supplied information of the document item is being investigated.

LoadTender

papiNet Standard - Version 2.31

Rejected

The supplied information is rejected.

IsPartialConfirmation [attribute]

IsPartialConfirmation is optional. A single instance is might exist.

Specifies if the confirmation is a partial confirmation or not, e.g. confirmation of one segment only. Default value is No.

This item is restricted to the following list.

Yes

No

(sequence)

The contents of (sequence) are mandatory. A single instance is required.

LoadTenderResponseNumber

LoadTenderResponseNumber is mandatory. A single instance is required.

The identifier for the LoadTenderResponse e-Document

LoadTenderResponseIssueDate

LoadTenderResponseIssueDate is mandatory. A single instance is required.

The date when the e-Document was issued.

LoadTenderNumber

LoadTenderNumber is optional. A single instance might exist.

The identifier for the LoadTender b-business document.

LoadTenderIssueDate

LoadTenderIssueDate is optional. A single instance might exist.

The date when the e-Document was issued.

TransactionHistoryNumber

TransactionHistoryNumber is optional. A single instance might exist.

A sequential number that keeps track of the version of a document being sent by the document originator. However when the document is a confirmation document, in which case the TransactionHistoryNumber refers to the trigger transaction for which the confirmation is being sent.

TransactionHistoryConfirmationNumber

TransactionHistoryConfirmationNumber is optional. A single instance might exist.

A sequential number that indicates the version of the confirmation document being sent.

LoadTenderResponseReference

LoadTenderResponseReference is optional. Multiple instances might exist.

An item detailing relevant references pertaining to the LoadTenderResponse. The type of reference is identified by the LoadTenderReferenceType attribute.

TransportInformation

TransportInformation is optional. A single instance might exist.

A grouping element for transport information.

LoadTender

papiNet Standard - Version 2.31

SenderParty

SenderParty is optional. A single instance might exist.

The business entity issuing the business document, the source of the document.

- This is the same entity as the "From" party in the ebXML message service envelope. The entity responsible for the content. If the sender party has outsourced the transmission function to a third party the sender party is the original party not the party performing the transmission service.

ReceiverParty

ReceiverParty is optional. Multiple instances might exist.

The business entity for whom the business document is intended, the destination of the document.

- This is the same entity as the "To" party in the ebXML message service envelope. The entity interested in the content. If the receiver party has outsourced the message receipt function to a third party the receiver party is the intended party not the party performing the receiving process.

SupplierParty

SupplierParty is optional. A single instance might exist.

The organisation or business entity responsible for providing the product.

SupplierParty is also the seller of the product, if Seller is not specified as OtherParty = Seller.

BuyerParty

BuyerParty is optional. A single instance might exist.

The legal entity to which the product is sold. Also commonly referred to as the sold-to party or customer. If no OtherParty is defined as the Payer, the Buyer is the Payer.

BillToParty

BillToParty is optional. A single instance might exist.

The address where the invoice is to be sent.

ShipToCharacteristics

ShipToCharacteristics is optional. A single instance might exist.

A group item that provides information important for the Ship-To Party.

OtherParty

OtherParty is optional. Multiple instances might exist.

An organisation or business entity other than those specifically detailed within a business document.

QuoteInCurrency

QuoteInCurrency is optional. A single instance might exist.

A three-character ISO 4217 currency code in capital letters. The ISO standard classification for currencies. Refer to the ISO standard for information about the choices for the enumerations.

<https://www.iso.org/iso-4217-currency-codes.html>

ValidityPeriod

ValidityPeriod is optional. A single instance might exist.

The validity period for a specific item, e.g. the validity period for an e-document.

LoadTender

papiNet Standard - Version 2.31

AdditionalText

AdditionalText is optional. Multiple instances might exist.

A text field that is used to communicate information not previously defined or for special instructions. To be used only for circumstances not covered by specific elements.

LoadTender

papiNet Standard - Version 2.31

LoadTenderResponseSegment

The details for a particular load segment.

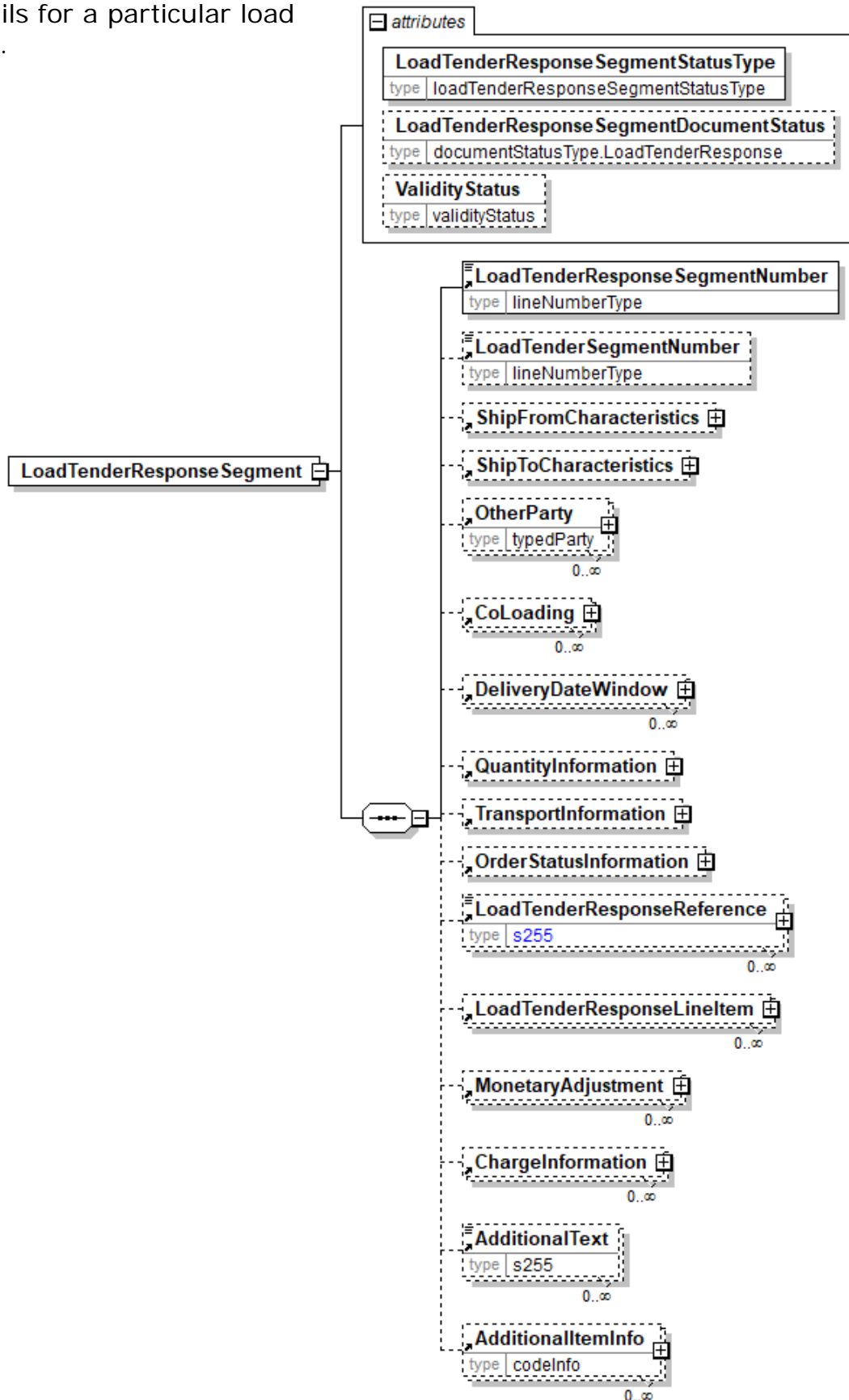

LoadTender

papiNet Standard - Version 2.31

LoadTenderResponseSegmentStatusType [attribute]

LoadTenderResponseSegmentStatusType is mandatory. A single instance is required.

Identifies the status of the load tender segment.

This item is restricted to the following list.

Accepted

The supplied information is accepted.

Amended

The supplied information is changed

Cancelled

The supplied information is cancelled. Items that have been cancelled are not included in totals on the summary levels of the e-Document.

NoAction

The supplied information has not been amended and thereby requires no action.

Pending

The supplied information of the document item is being investigated.

Rejected

The supplied information is rejected.

LoadTenderResponseSegmentDocumentStatus [attribute]

LoadTenderResponseSegmentDocumentStatus is optional. A single instance might exist.

Defines the actual document status for the LoadTenderResponseSegment.

This item is restricted to the following list.

Cancelled

The supplied information of the document item is cancelled. Items that have been cancelled are not included in totals on the summary level of e-documents.

Confirmed

The supplied information of the document item is agreed. If a requested change or cancellation of an existing document item can not be accepted, then the earlier agreed information of the document item will be re-confirmed.

Pending

The supplied information of the document item is being investigated.

Rejected

The supplied information of the document item can not be accepted. The document item is new or not earlier confirmed.

ValidityStatus [attribute]

ValidityStatus is optional. A single instance might exist.

The validity status for a specific item.

This item is restricted to the following list.

Active

LoadTender

papiNet Standard - Version 2.31

The item is active. Business transactions can be executed with reference to the item during the validity period.

Closed

The item is terminated or completed. Business transactions cannot be executed with reference to the item.

Pending

The item is preliminary or unfinished. Business transactions cannot be executed with reference to the item.

(sequence)

The sequence of items below is mandatory. A single instance is required.

LoadTenderResponseSegmentNumber

LoadTenderResponseSegmentNumber is mandatory. A single instance is required.

The identifier for the LoadTenderResponse segment.

LoadTenderSegmentNumber

LoadTenderSegmentNumber is optional. A single instance might exist.

The identifier for the LoadTender segment.

ShipFromCharacteristics

ShipFromCharacteristics is optional. A single instance might exist.

A group item that provides information pertaining to the Ship-From Party.

ShipToCharacteristics

ShipToCharacteristics is optional. A single instance might exist.

A group item that provides information important for the Ship-To Party.

OtherParty

OtherParty is optional. Multiple instances might exist.

An organisation or business entity other than those specifically detailed within a e-Document.

CoLoading

CoLoading is optional. Multiple instances might exist.

A group item specifying information about items to be loaded or loaded on the same transport unit.

Used to identify:

- Delivery together to the drop point
- Transport Orders stuffed together in a container
- Transport Orders not splittable

DeliveryDateWindow

DeliveryDateWindow is optional. Multiple instances might exist.

A group item defining the date/time interval for delivery to take place. An element which may contain the estimated date for which delivery is expected. This date is not absolute.

QuantityInformation

QuantityInformation is optional. A single instance might exist.

A group item containing information about quantity and informational quantity of

LoadTender

papiNet Standard - Version 2.31

similar items.

TransportInformation

TransportInformation is optional. A single instance might exist.

A grouping element for transport information.

OrderStatusInformation

OrderStatusInformation is optional. A single instance might exist.

A group element that stores two levels of order status codes.

LoadTenderResponseReference

LoadTenderResponseReference is optional. Multiple instances might exist.

An item detailing relevant references pertaining to the LoadTenderResponse. The type of reference is identified by the LoadTenderReferenceType attribute.

LoadTenderResponseLineItem

LoadTenderResponseLineItem is optional. Multiple instances might exist.

The details for a particular load line item.

MonetaryAdjustment

MonetaryAdjustment is optional. Multiple instances might exist.

The element containing the information necessary for the understanding, calculation, and treatment of an adjustment to a currency amount.

MonetaryAdjustment contains an attribute that indicates they type of adjustment being communicated.

ChargeInformation

ChargeInformation is optional. Multiple instances might exist.

A group element that contains elements that describe a charge. ChargeInformation is used when charge details need to be specified by using a code assigned by an agency. It is typically used for freight costs and other costs related to the supply chain.

AdditionalText

AdditionalText is optional. Multiple instances might exist.

A text field that is used to communicate information not previously defined or for special instructions. To be used only for circumstances not covered by specific elements.

AdditionalItemInfo

AdditionalItemInfo is optional. Multiple instances might exist.

A grouping element that contains information about additional items specified by an agency. Restricted use of this element is recommended.

LoadTender

papiNet Standard - Version 2.31

LoadTenderResponseLineItem

The details for a particular load line item.

(sequence)

The sequence of items below is mandatory. A single instance is required.

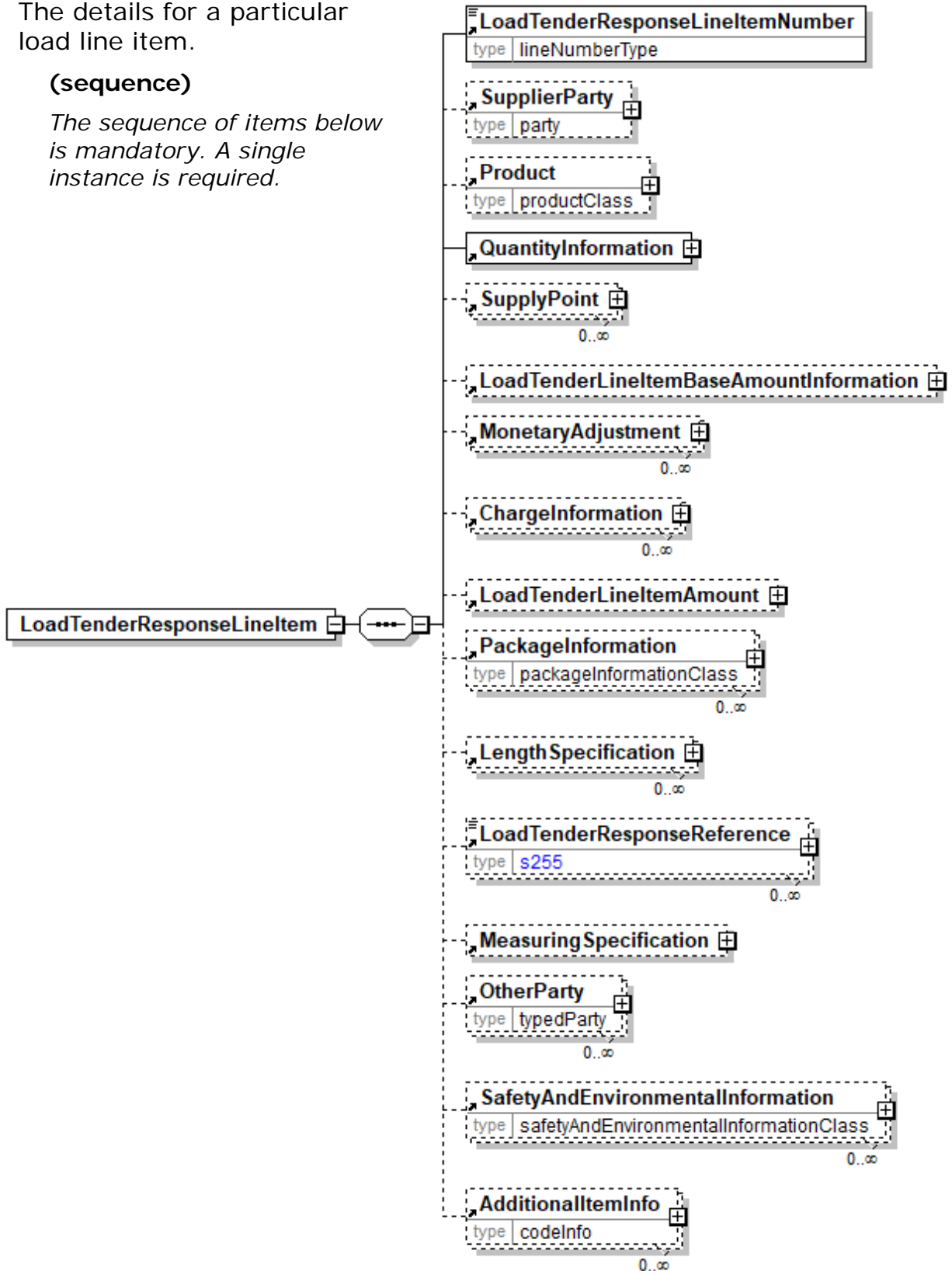

LoadTenderResponseLineItemNumber

LoadTenderResponseLineItemNumber is mandatory. A single instance is required.

LoadTender

papiNet Standard - Version 2.31

The sequential number that uniquely identifies the LoadTenderResponse line item.

SupplierParty

SupplierParty is optional. A single instance might exist.

The organisation or business entity responsible for providing the product. SupplierParty is also the seller of the product, if Seller is not specified as OtherParty = Seller.

Product

Product is optional. A single instance might exist.

Product is a group item defining the article and its characteristics. Product is used to specify product characteristics organized by ProductIdentifier, ProductDescription, and Classification. Book Manufacturing, Label Stock, Paper, Pulp, Recovered Paper, Wood Products, and Virgin Fibre market segments have defined their product characteristics and conversion features for implementation in papiNet.

QuantityInformation

QuantityInformation is mandatory. A single instance is required.

A group item containing information about quantity and informational quantity of similar items.

SupplyPoint

SupplyPoint is optional. Multiple instances might exist.

Grouping element that contains items describing a supply point. A SupplyPoint belongs to a LocationParty, e.g. in a DeliveryOrigin or DeliveryDestination, and describes where goods are stored and can be loaded or unloaded. A SupplyPoint can for example be a loading or unloading gate at a warehouse or a road side landing at a logging area in the forest.

LoadTenderLineItemBaseAmountInformation

LoadTenderLineItemBaseAmountInformation is optional. A single instance might exist.

Group element used to detail the LoadTender Line Item's PriceDetails and TotalAmount. Normally used to identify the PricePerUnit of the line item.

MonetaryAdjustment

MonetaryAdjustment is optional. Multiple instances might exist.

The element containing the information necessary for the understanding, calculation, and treatment of an adjustment to a currency amount. MonetaryAdjustment contains an attribute that indicates the type of adjustment being communicated.

ChargeInformation

ChargeInformation is optional. Multiple instances might exist.

A group element that contains elements that describe a charge. ChargeInformation is used when charge details need to be specified by using a code assigned by an agency. It is typically used for freight costs and other costs related to the supply chain.

LoadTenderLineItemAmount

LoadTenderLineItemAmount is optional. A single instance might exist.

Total amount of the LoadTenderLineItem including charges, adjustments and tax

LoadTender

papiNet Standard - Version 2.31

(when tax is specified on the load tender line item).

LoadTenderLineItemAmount is equal to the LoadTenderAmount plus the sum of the signed values of the ChargeAmount for all instances of ChargeInformation plus the sum of the signed values of the MonetaryAdjustmentAmount for all instances of MonetaryAdjustment.

PackageInformation

PackageInformation is optional. Multiple instances might exist.

The purpose of the PackageInformation structure is to clearly identify physical handling items that constitute the delivery.

PackageInformation is the highest level of product packaging it describes the shipping or warehousing unit.

- If you are communicating a package, usually for logistics or transport purposes, you should include the PackageType, Identifier, ItemCount, and Quantity. (Note: you still have the ability to describe the item with one of the "named" items.)
- If you are communicating one of the named Items there is no need to include PackageType, Identifier, ItemCount, and Quantity.

Since either of these two approaches can be used the entire contents of this element are optional even though the parent may be required. It is expected that you will fill in the appropriate details.

LengthSpecification

LengthSpecification is optional. Multiple instances might exist.

Length specification of the wood product.

LoadTenderResponseReference

LoadTenderResponseReference is optional. Multiple instances might exist.

An item detailing relevant references pertaining to the LoadTenderResponse. The type of reference is identified by the LoadTenderReferenceType attribute.

MeasuringSpecification

MeasuringSpecification is optional. A single instance might exist.

A grouping element that contains a specification for measurement procedures.

OtherParty

OtherParty is optional. Multiple instances might exist.

An organisation or business entity other than those specifically detailed within a e-Document.

SafetyAndEnvironmentalInformation

SafetyAndEnvironmentalInformation is optional. Multiple instances might exist.

Name of certification type, if any, on the goods (For example, FSC, PEFC). SafetyAndEnvironmental needs a value or measurement to communicate the percentage of the product is certified (for example, 75% is certified by the indicated agency).

AdditionalItemInfo

AdditionalItemInfo is optional. Multiple instances might exist.

A grouping element that contains information about additional items specified by an agency. Restricted use of this element is recommended.

MonetaryAdjustment

The element containing the information necessary for the understanding, calculation, and treatment of an adjustment to a currency amount. MonetaryAdjustment contains an attribute that indicates they type of adjustment being communicated.

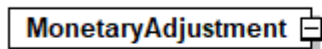

AdjustmentType [attribute]

AdjustmentType is mandatory. A single instance is required.

Describes the type of adjustment applied to a monetary oriented element. Adjustment values should always be given as negative or positive adjustments even if AdjustmentType indicates the sign. For example, a rebate of 1% on an invoice should be given as an adjustment percentage of -1%.

This item is restricted to the following list.

BillOfLadingCharge

An extra charge for creating a Bill of Lading.

CancellationCharge

A charge applied because a cancellation was late (after the last date of change) and all or part of the ordered product has already been made.

CashDiscount

A reduction due to a discount applied.

CertificateCharge

An extra charge for creating a certificate. Some countries requires Certificates in which different characteristics of the delivery, transport unit, route, product, and others must be proved.

There are certificates for gasen pallets, for the place of production, for the age of the ship/vessel, for not departing from one country's harbour when delivering to another.

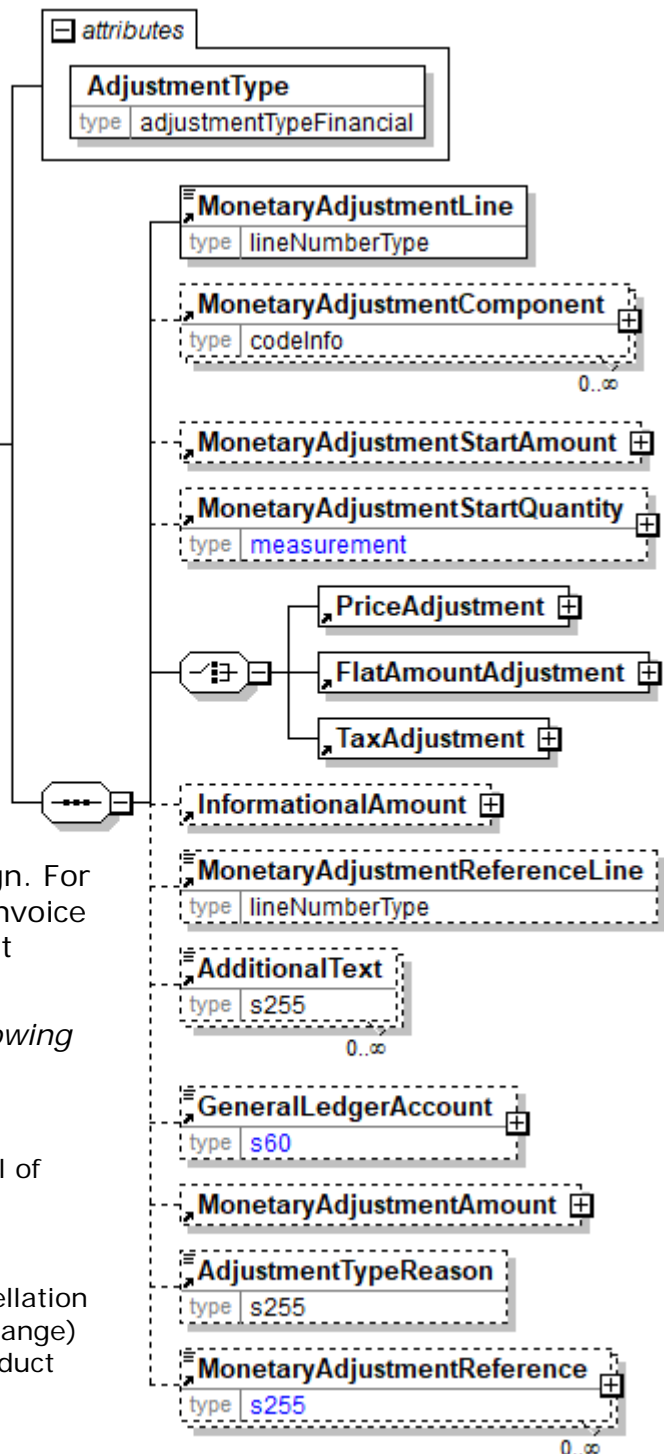

LoadTender

papiNet Standard - Version 2.31

ChargesForward

A pending invoice amount brought forward from a previous Invoice.

ClaimAdjustment

An adjustment related to a filed complaint.

Commission

Commission costs paid to the trading agency or trader.

CompetitiveAllowance

An allowance provided for competitive reasons.

CongestionCharge

An extra fee from ports for waiting time of ships in ports, railcars on a siding, trucks at a dock. (Synonym: Demurrage.)

ConsigneeUnloadCharge

An unloading charge that is the responsibility of the consignee.

ContractAllowance

An allowance for a volume discount, usually because the agreed amount has been exceeded.

CurrencyAdjustmentCharge

An extra fee to adjust for currency variations.

DecimalRounding

Adjustments for rounding of amounts to fit the business agreement or national monetary legislation. This adjustment is typically used for decimal rounding of amounts not including tax.

N.B. Use InformationalAmount with AmountType "DecimalRounding" for specification of decimal rounding of amounts including tax.

DefectiveAllowance

An allowance provided for defective material.

DeliveryCharge

The charge for delivering the product.

DeliveryNonConformanceAllowance

An allowance due to non-conformance with the purchase agreement regarding a delivery.

DeliveryTimeBonus

A bonus given for deliveries of products within a certain time period.

EarlyShipAllowance

An allowance due to a delivery that took place earlier than planned. The seller may be charged a penalty. If this is found before issuing the Invoice, it can be handled through this allowance. If found later, it will be handled through a credit note.

EnergySurcharge

A charge related to increases in the cost of energy.

Environmental

An allowance applied due to environmental regulations.

LoadTender

papiNet Standard - Version 2.31

ExpeditedShipmentCharge

An extra cost charged due to unexpected or emergency requirements (for example, breaking off a run in the mill to reach the production date for a rush order).

ExportClearanceCharge

An extra fee for customs administration.

FlatRateCharge

A general flat charge.

FreightAllowance

The freight cost allowed by the mill. This amount is negative, and will be deducted from the Invoice (U.S. business practice, in the European Union (EU), use only Freight Charge).

FreightCharge

The actual cost incurred to deliver the product. This amount is positive, and will be added to the Invoice.

FuelAdjustmentCharge

An extra fee, usually from shipping companies, to adjust fuel prices.

HandlingCharge

A charge related to the handling of the product.

Inspection

The cost associated with performing an inspection of the product.

InterestCharge

A charge applied for interest on overdue payments.

LabourAllowance

An allowance due to additional labour required in the use or acceptance of the product.

LabourCharge

A charge due to additional labour required in the use or acceptance of the product.

LoggingDamage

An adjustment caused by logging damages on Forest Wood products. Logging damages normally cause a reduction of the product price.

LotCharge

A charge applied to the lot of material.

MetalDetection

A charge for additional metal detection applied to the goods.

ModelHomeDiscount

A discount associated with the building of the model home.

NewStoreCouponDiscount

A discount associated with entry into a new store.

OrderQuantity

A charge or allowance for small/big ordered quantities.

LoadTender

papiNet Standard - Version 2.31

PalletCharge

A charge that represents the cost or rental of the pallet.

PickUpAllowance

An allowance provided to compensate for the cost of picking up the product.

PromotionalAllowance

An allowance provided for the promotion of the product.

PromotionalCharge

A charge associated with the promotion of the product.

PriceCorrection

An adjustment associated with a correction of the product's price.

ProductionSetUpCharge

A special charge applied due to specific buyer requests.

Provision

The act of making ready or equipping for use.

Rebate

A rebate accepted by the buyer and seller based on the agreed price and volume.

ReelDiscount

An allowance for purchasing reels instead of sheets.

ReturnedLoadAllowance

An allowance applied due to the return of the load.

ReturnLoadCharge

A charge applied due to the return of the load.

RoadFeeCharge

A freight charge for a special tax applied to road transports in some countries, e.g. Germany

ScrapAndDunnageCharge

A charge that represents the scrapping of the material and its removal.

ServiceCharge

A charge associated with a miscellaneous service.

SpecialConversionCharge

Additional charge for a special conversion of the product.

SpecialDeliveryCharge

A special charge for delivering the product differently from the usual or agreed-to method.

SpecialHandlingCharge

A special charge for handling the product differently from the usual or agreed-to method.

SpecialPackagingCharge

A special charge for packaging the product differently from the usual or agreed-to method, or if packaging as requested is out of spec.

LoadTender

papiNet Standard - Version 2.31

StopOffAllowance

An allowance for a delivery stop-off.

StopOffCharge

A charge for a delivery stop-off.

StorageAllowance

An allowance for storing the product.

StorageCharge

An extra cost charged for storing the product on location (in the plant).

Tax

An adjustment that reflects a tax item.

TestingCharge

A charge related to testing a paper grade.

TradeDiscount

A discount based on the terms of the trade given on the agreed price. Usually a percentage.

TrialDiscount

A discount applied for a trial run of a new or improved product.

TransferCharge

A freight charge incurred by the goods transfer from one location to another location not previously agreed upon.

UnloadingAllowance

An allowance to compensate for the unloading the product.

UnloadingCharge

A charge for the unloading the product.

VolumeDiscount

A rebate accepted by the buyer and the seller based on the agreed volume

WarRiskCharge

An extra fee from transport companies for transport units that cross war zones.

Other

Any other adjustment not covered by the attribute list.

(sequence)

The sequence of items below is mandatory. A single instance is required.

MonetaryAdjustmentLine

MonetaryAdjustmentLine is mandatory. A single instance is required.

A sequence number indicating the order of printing or the sequence in which a group of adjustments are to be considered.

MonetaryAdjustmentComponent

MonetaryAdjustmentComponent is optional. Multiple instances might exist.

A group item that contains information for specifying a monetary adjustment component by a code assigned by an agency.

LoadTender

papiNet Standard - Version 2.31

MonetaryAdjustmentStartAmount

MonetaryAdjustmentStartAmount is optional. A single instance might exist.

The beginning currency amount used in the calculation of a monetary adjustment.

MonetaryAdjustmentStartQuantity

MonetaryAdjustmentStartQuantity is optional. A single instance might exist.

The beginning quantity used in the calculation of a monetary adjustment.

(choice)

[choice] is optional because of choice construct.

PriceAdjustment

PriceAdjustment is optional because of choice construct.

A group item defining a deviation from the PricePerUnit.

FlatAmountAdjustment

FlatAmountAdjustment is optional because of choice construct.

A group item that contains flat adjustment amount information.

TaxAdjustment

TaxAdjustment is optional because of choice construct.

This content element contains the necessary information to describe, calculate, and handle a tax adjustment.

InformationalAmount

InformationalAmount is optional. A single instance might exist.

A monetary amount used for information purposes only (not for calculation). For example, the invoice price adjustment subtotal is expressed in sterling pounds, and the buyer wants this information expressed in U.S. dollars.

- CreditDebitNote and Invoice - The TaxAmount is displayed in the currency that is applicable throughout the e-Document. When a TaxAmount needs to be displayed in a different national currency, this field is used.

MonetaryAdjustmentReferenceLine

MonetaryAdjustmentReferenceLine is optional. A single instance might exist.

A link to a previously defined MonetaryAdjustmentLine upon which this adjustment is based.

AdditionalText

AdditionalText is optional. Multiple instances might exist.

A text field that is used to communicate information not previously defined or for special instructions. To be used only for circumstances not covered by specific elements.

GeneralLedgerAccount

GeneralLedgerAccount is optional. A single instance might exist.

The general ledger account to be referenced for the item.

MonetaryAdjustmentAmount

MonetaryAdjustmentAmount is optional. A single instance might exist.

The actual amount of the monetary adjustment.

LoadTender

papiNet Standard - Version 2.31

AdjustmentTypeReason

AdjustmentTypeReason is optional. A single instance might exist.

Provides additional information about the type of adjustment. Can be viewed as a sub-classification of the adjustment type attribute or as a textual explanation.

MonetaryAdjustmentReference

MonetaryAdjustmentReference is optional. Multiple instances might exist.

An element detailing relevant references pertaining to the MonetaryAdjustment as indicated by MonetaryAdjustmentReferenceType and AssignedBy.

LoadTenderResponseSummary

Summary information that applies to the entire LoadTenderResponse e-Document

(sequence)

The contents of (sequence) are mandatory. A single instance is required.

TotalQuantityInformation

TotalQuantityInformation is optional. Multiple instances might exist.

A group item containing information about the total quantity and total informational quantity of similar items in the document. TotalQuantityInformation is primarily used in the summary section of e-Documents where it is repeatable to permit totalling for different units of measure.

LineItemSubTotal

LineItemSubTotal is optional. A single instance might exist.

The total amount of all base amounts on e-Document line items. The base amount contains the result of the calculation quantity times the base unit price. As such it does not include any taxes. For example, in an Invoice claiming payment for products LineItemSubTotal is equal to the sum of all InvoiceLineBaseAmount.

TotalAdjustments

TotalAdjustments is optional. A single instance might exist.

The CurrencyValue of TotalAdjustments contains the total of all adjustments and charges excluding tax. For example, in the Invoice TotalAdjustments is equal to the sum of the signed values of the MonetaryAdjustmentAmount for all instances of MonetaryAdjustment with PriceAdjustment and FlatAmountAdjustment and plus the sum of the signed values of the ChargeNetAmount for all instances of ChargeInformation.

TotalTaxAmount

TotalTaxAmount is optional. A single instance might exist.

The CurrencyValue of TotalTaxAmount contains the sum of all instances of TaxAdjustment in the document. TotalTaxAmount contains the sum of all instances

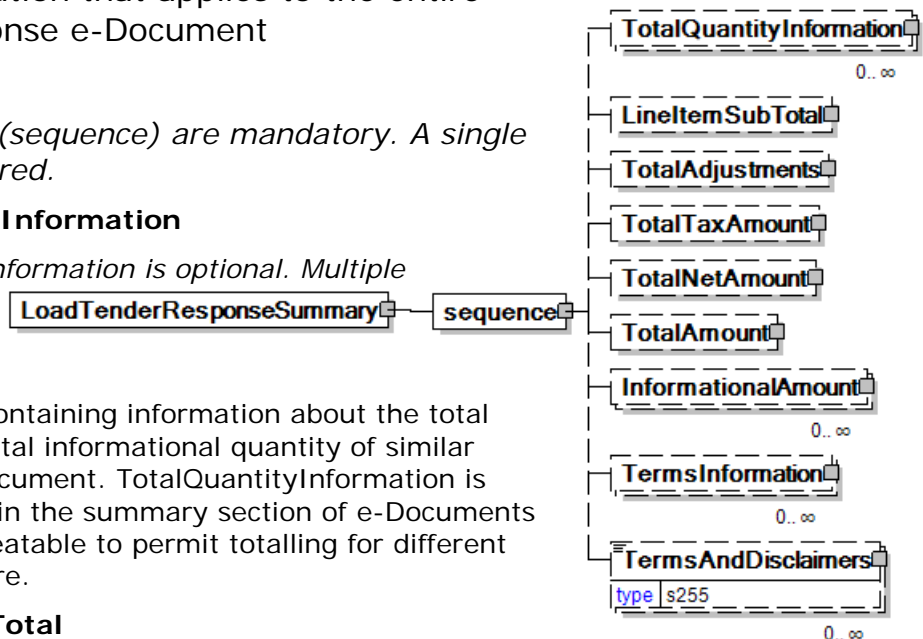

LoadTender

papiNet Standard - Version 2.31

of the MonetaryAdjustmentAmount for tax adjustments.

TotalNetAmount

TotalNetAmount is optional. A single instance might exist.

A field containing total amount excluding tax. For example, in the Invoice TotalNetAmount is equal to the sum of LineItemSubTotal plus TotalAdjustments. TotalNetAmount encapsulates CurrencyValue.

TotalAmount

TotalAmount is optional. A single instance might exist.

The total amount including tax.

In e-Documents claiming payment this is the amount due for payment based on the terms of payment. Decimal rounding might be applied to this amount.

InformationalAmount

InformationalAmount is optional. Multiple instances might exist.

A monetary amount used for information purposes only (not for calculation). For example, the invoice price adjustment subtotal is expressed in sterling pounds, and the buyer wants this information expressed in U.S. dollars.

- CreditDebitNote and Invoice - The TaxAmount is displayed in the currency that is applicable throughout the e-Document. When a TaxAmount needs to be displayed in a different national currency, this field is used.

TermsInformation

TermsInformation is optional. Multiple instances might exist.

An element that contains the term related information.

TermsAndDisclaimers

TermsAndDisclaimers is optional. Multiple instances might exist.

An element that contains legal information with an indication of what the Language is.

LoadTender papiNet Standard - Version 2.31

LoadTender Business Scenarios

LoadTender and LoadTenderResponse Scenario Listing

Frequently-used Scenarios

Scenario A	Transportation from consignor to consignee
Scenario B	Transportation from consignor to several consignee
Scenario C	Pre-booking request (for price/vessel/dates/quantity etc.)
Scenario D	LoadTender for a transportation from consignor to consignee

Less Frequently-used Scenarios

Scenario E	Transportation from several consignors to consignee
Scenario F	Transportation from consignor to consignee including return transportation information
Scenario G	Multi leg and multi mode transportation
Scenario H	Container shipment
Scenario I	Break bulk shipment
Scenario J	On-carriage
Scenario K	Transport from consignor to consignee for certain goods (length specification)
Scenario L	Alternative routing (proposals from carrier)
Scenario M	Web portal
Scenario N	Price adjustments (stock keeping costs)
Scenario O	Co-loading
Scenario P	Order status information

Scenario A

e-Document	LoadTender
Type	Booking / BookingConfirmation
Scenario	(direct) transportation from consignor to consignee
Outcome	Goods booked with selected carrier
Initiator	Consignor/Broker
Receiver	Carrier

LoadTender papiNet Standard - Version 2.31

Trigger	Delivery Instruction , Call off or sales order, replenishment
Step 1.	Booking requestor sends <ul style="list-style-type: none"> • Loading location • Requested Loading Date • Country • Destination • Delivery Date&Time • Reference • Name and address of receiver Product • Loading instructions • Type of vehicle • Free text instructions • Total weight • Total amount
Results	Booking confirmation is sent from the carrier to the requestor

Scenario B

e-Document	LoadTender
Type	Booking / BookingConfirmation
Scenario	Transportation from consignor to several consignee
Outcome	Goods booked with selected carrier
Initiator	Consignor/Broker
Receiver	Carrier
Trigger	Delivery Instruction , Call off or sales order, replenishment
Step 1.	This Scenario is similar to Scenario A with that difference that there is more than one consignee. Some data needs to be repeated. Booking requestor sends <ul style="list-style-type: none"> • Loading location • Requested Loading Date • Country • Destination • Delivery Date&Time • Reference • Name and address of receiver

LoadTender

papiNet Standard - Version 2.31

	<ul style="list-style-type: none"> • Product • Loading instructions • Type of vehicle • Free text instructions • Total weight • Total amount • Bill-to Party
Results	Booking confirmation is sent from the carrier to the requestor

Scenario C

e-Document	LoadTender
Type	PreBooking / PreBookingConfirmation
Scenario	Pre-booking request (for price/vessel space / truck space / train space /dates/quantity etc.)
Outcome	Basis for booking
Initiator	Consignor/Broker
Receiver	Carrier/Haulier
Trigger	Delivery Request
Step 1.	PreBooking request information is sent to the carrier/haulier
Step 2.	Carrier/haulier calculates request
Results	Booking request reply is sent from the Carrier/Haulier to the requestor (pre booking confirmation)

Scenario D

e-Document	LoadTender
Type	LoadTender / LoadTenderResponse
Scenario	LoadTender for a transportation from consignor to consignee
Outcome	Price information
Initiator	Consignor/Broker
Receiver	Carrier
Preconditions	What exists prior to the start?
XML File	The name of any sample file.

LoadTender papiNet Standard - Version 2.31

Trigger	Delivery Instruction , Call off or sales order, replenishment
Step 1.	Booking requestor sends <ul style="list-style-type: none"> • Loading location • Requested Loading Date • Country • Destination • Delivery Date&Time • Reference • Name and address of receiver • Product • Loading instructions • Type of vehicle • Free text instructions • Total weight • Total amount • Bill-to party
Results	LoadTenderResponse including price information

Scenario E

e-Document	LoadTender
Type	Booking / BookingConfirmation
Scenario	Transportation from several consignors to consignee
Outcome	Goods booked with selected carrier
Initiator	Consignor/Broker
Receiver	Carrier
Trigger	Delivery Instruction , Call off or sales order, replenishment
Step 1.	This Scenario is similar to Scenario A with that difference that there is more than one pickup. Some data needs to be repeated. Booking requestor sends <ul style="list-style-type: none"> • Loading location • Requested Loading Date • Country • Destination • Delivery Date&Time • Reference

LoadTender papiNet Standard - Version 2.31

	<ul style="list-style-type: none"> • Name and address of receiver • Product • Loading instructions • Type of vehicle • Free text instructions • Total weight • Total amount • Bill-to party
Results	Booking confirmation is sent from the carrier to the requestor

Scenario F

e-Document	LoadTender
Type	Booking / BookingConfirmation
Scenario	Transportation from consignor to consignee with return transportation
Outcome	Goods booked with selected carrier
Initiator	Consignor/Broker
Receiver	Carrier
Preconditions	What exists prior to the start?
XML File	The name of any sample file.
Trigger	Delivery Instruction , Call off or sales order, replenishment
Step 1.	<p>This Scenario is similar to Scenario A with that difference that there is also return transportation. Some data needs to be repeated.</p> <p>Booking requestor sends</p> <ul style="list-style-type: none"> • Loading location • Requested Loading Date • Country • Destination • Delivery Date&Time • Reference • Name and address of receiver • Product • Loading instructions • Type of vehicle • Free text instructions • Total weight

LoadTender papiNet Standard - Version 2.31

	<ul style="list-style-type: none"> • Total amount
Results	Booking confirmation is sent from the carrier to the requestor

Scenario G

e-Document	LoadTender
Type	Booking / BookingConfirmation
Scenario	Multi leg and multi mode transportation
Outcome	Goods booked with selected carrier
Initiator	Consignor/Broker
Receiver	Carrier
Preconditions	What exists prior to the start?
XML File	The name of any sample file.
Trigger	Delivery Instruction , Call off or sales order, replenishment
Step 1.	<p>In this scenario a trailer should be delivered from place A to B which can include several legs and transport modes. Some data needs to be repeated.</p> <p>Booking requestor sends</p> <ul style="list-style-type: none"> • Loading location • Requested Loading Date • Country • Destination • Delivery Date&Time • Reference • Name and address of receiver • Product • Loading instructions • Type of trailer • Free text instructions • Total weight • Total amount • Bill-to party
Results	Booking confirmation is sent from the carrier to the requestor

Scenario H

e-Document	LoadTender
-------------------	------------

LoadTender papiNet Standard - Version 2.31

Type	Booking / BookingConfirmation
Scenario	Container shipment (Vessel booking)
Outcome	Container reservation for a certain time period
Initiator	Consignor/Broker
Receiver	Carrier
Preconditions	What exists prior to the start?
XML File	The name of any sample file.
Trigger	Delivery Instruction , Call off or sales order , replenishment
Step 1.	<p>PreBooking information is sent to the carrier</p> <ul style="list-style-type: none"> • Amount of containers • Type of container • Container reservation for a certain time period • Loading location • Booking reference <p>SubCarrier or Forwarder is used in OtherParty to identify the transport vehicle and/or containers required.</p>
Step 2.	<p>Booking information is sent to the carrier with detailed ready to loading instruction</p> <ul style="list-style-type: none"> • Amount of containers • Type of container • Loading time • Loading location • Booking reference
Results	Booking confirmation is sent from the carrier to the requestor

Scenario I

e-Document	LoadTender
Type	PreBooking / PreBookingConfirmation / Booking / BookingConfirmation
Scenario	Break bulk shipment (Vessel booking)
Outcome	Goods booked as break bulk cargo with selected carrier
Initiator	Consignor/Broker

LoadTender papiNet Standard - Version 2.31

Receiver	Carrier
Preconditions	What exists prior to the start?
XML File	The name of any sample file.
Trigger	Delivery Request
Step 1.	<p>Preliminary booking information is sent to the carrier</p> <ul style="list-style-type: none"> • Amount/Weight/Dimensions of goods • Destination port • Ready for loading • Arrival date request • Storage request • Loading instructions • Loading location • Booking reference
Step 2.	<p>Carrier takes booking information in preliminary delivery plan and reserves space and equipment for the shipment. Carrier send LoadTenderResponse (Vessel Nomination) to the requestor (updates may happen more than once)</p>
Step 3.	<p>Firm Booking information is sent to the carrier</p> <ul style="list-style-type: none"> • Amount/Weight/Dimensions of goods • Destination port • Ready for loading • Arrival date request • Storage request • Loading instructions • Loading location • Booking reference • Vessel
Results	Booking confirmation is sent from the carrier to the requestor

Scenario J

e-Document	LoadTender
Type	Booking / BookingConfirmation
Scenario	On-carriage (Vessel booking)
Outcome	Goods booked to be delivered to consignee
Initiator	Consignor/Broker/Carrier

LoadTender papiNet Standard - Version 2.31

Receiver	Carrier/Haulier depending on agreement and transport mode
Preconditions	What exists prior to the start?
XML File	The name of any sample file.
Trigger	Delivery Instruction , Call off or sales order, replenishment
Step 1.	Booking information is sent to the carrier <ul style="list-style-type: none"> • Amount of containers • Type of container • Destination Port • Ready for loading • Arrival date/time request (in port) • Final destination • Delivery plant • Booking reference
Step 2.	Carrier/haulier takes booking information in delivery plan and reserves space and equipment for that transport
Results	Booking confirmation is sent from the Haulier to the requestor. If arranged by the carrier, no separate confirmation is sent.

Scenario K

e-Document	LoadTender
Type	Booking / BookingConfirmation
Scenario	Transport from consignor to consignee for certain goods (length specification)
Outcome	Goods (wood) booked to be delivered to loading port
Initiator	Consignor/Broker /Carrier
Receiver	Carrier/Haulier depending on agreement and transport mode
Preconditions	What exists prior to the start?
XML File	The name of any sample file.
Trigger	Delivery Instruction , Call off or sales order, replenishment
Step 1.	Booking information is sent to the carrier

LoadTender papiNet Standard - Version 2.31

	<ul style="list-style-type: none"> • Amount of containers • Type of container • Amount/Weight/Length/Dimensions of goods (wood) • Port • Ready for loading • Arrival date/time request (in port) • Loading instructions • Loading location • Booking reference
Step 2.	Carrier/haulier takes booking information in delivery plan and reserves space and equipment for that transport
Results	Booking confirmation is sent from the Haulier/carrier to the requestor

Scenario L

e-Document	LoadTender
Type	Booking / BookingConfirmation
Scenario	Transport booking from consignor to consignee, response includes alternative route (including price information)
Outcome	Confirmed Transport including different route
Initiator	Consignor/Broker
Receiver	Carrier
Preconditions	What exists prior to the start?
XML File	The name of any sample file.
Trigger	What starts the process?
Step 1.	<p>This Scenario is similar to Scenario B (multi leg) with that difference that the consignee propose a different transportation route (A – C – B instead of A – B – C).</p> <p>Booking requestor sends</p> <ul style="list-style-type: none"> • Loading location • Requested Loading Date • Country • Destination • Delivery Date&Time • Reference

LoadTender

papiNet Standard - Version 2.31

	<ul style="list-style-type: none"> • Name and address of receiver • Product • Loading instructions • Type of vehicle • Free text instructions • Total weight • Total amount
Step 2.	Booking receiver sends information back (same date) but different structured (legs got switched).
Results	Automation of transport optimization

Scenario M

e-Document	LoadTender
Type	LoadTender / LoadTenderResponse
Scenario	LoadTenderResponse for a transportation from consignee to consignor. <ul style="list-style-type: none"> • See Scenario D
Outcome	Confirmed Transport
Initiator	Carrier
Receiver	Consignor/Broker/Carrier
Preconditions	What exists prior to the start?
XML File	The name of any sample file.
Trigger	Acceptance of Transport
Step 1.	Publishing of transport on web
Step 2.	Confirmation / Acceptance of Transport via web
Step 3.	Booking as well as Booking confirmation send to both parties including information of <ul style="list-style-type: none"> • Loading location • Requested Loading Date • Country • Destination • Delivery Date&Time • Reference • Name and address of receiver • Product • Loading instructions • Type of vehicle

LoadTender papiNet Standard - Version 2.31

	<ul style="list-style-type: none"> • Free text instructions • Total weight • Total amount • Bill-to party • Confirmed / accepted price
Results	Automation of web interface to both involved parties

Scenario N

e-Document	LoadTender
Type	Booking / BookingConfirmation
Scenario	Transport booking from consignor to consignee, response includes alternative route (including price information)
Outcome	Confirmed Transport including different route
Initiator	Consignor/Broker
Receiver	Carrier
Preconditions	What exists prior to the start?
XML File	The name of any sample file.
Trigger	Delivery Instruction , Call off or sales order, replenishment
Step 1.	<p>This Scenario is similar to Scenario A including stock keeping / handling up charges</p> <p>Booking requestor sends</p> <ul style="list-style-type: none"> • Loading location • Requested Loading Date • Country • Destination • Delivery Date&Time • Reference • Name and address of receiver • Product • Loading instructions • Type of vehicle • Free text instructions • Total weight • Total amount • Bill-to party
Step 2.	Booking receiver confirms transport including

LoadTender papiNet Standard - Version 2.31

	price details and up charges (stock keeping/handling)
Results	Automation of transport optimization

Scenario o

e-Document	LoadTender
Type	Booking / BookingConfirmation
Scenario	Transport booking from consignor to consignee including CoLoading instructions
Outcome	2 transport orders must get shipped at once
Initiator	Consignor/Broker
Receiver	Carrier
Preconditions	What exists prior to the start?
XML File	The name of any sample file.
Trigger	Delivery Instruction , Call off or sales order, replenishment
Step 1.	<p>This Scenario is similar to Scenario G including CoLoading instructions</p> <p>Booking requestor sends</p> <ul style="list-style-type: none"> • Loading location • Requested Loading Date • Country • Destination • Delivery Date&Time • Reference • CoLoading • Name and address of receiver • Product • Loading instructions • Type of vehicle • Free text instructions • Total weight • Total amount • Bill-to party
Results	Booking receiver confirms transport

Scenario P

e-Document	LoadTender
-------------------	------------

LoadTender
papiNet Standard - Version 2.31

Type	Booking / BookingConfirmation
Scenario	Transport booking from consignor to consignee including order status information
Outcome	Shipment on hold (customer not paid in advance)
Initiator	Consignor/Broker
Receiver	Carrier
Preconditions	What exists prior to the start?
XML File	The name of any sample file.
Trigger	Delivery Instruction , Call off or sales order, replenishment
Step 1.	<p>This Scenario is similar to Scenario A including stock keeping / handling up charges</p> <p>Booking requestor sends</p> <ul style="list-style-type: none"> • Loading location • Requested Loading Date • Country • Destination • Delivery Date&Time • Reference • Name and address of receiver • Product • Loading instructions • Type of vehicle • Free text instructions • Total weight • Total amount • Bill-to party • Order status information (finished / on hold)
Results	Booking receiver confirms planning.