



**papiNet**

**OrderConfirmation**

**papiNet Standard - Version 2.31**

**Documentation**

**Global Standard for the Paper and Forest  
Products Supply Chain**

**Build V2R31\_20211013**

**Date 2021-10-22**

**Production Release**

# OrderConfirmation

## papiNet Standard - Version 2.31

---

### Copyright

Copyright 2000 - 2021 papiNet G.I.E ("papiNet") and International Digital Enterprise Alliance, Inc. ("IDEAlliance") collectively "Copyright Owner". All rights reserved by the Copyright Owner under the laws of the United States, Belgium, the European Economic Community, and all states, domestic and foreign. This document may be downloaded and copied provided that all copies retain and display the copyright and any other proprietary notices contained in this document. This document may not be sold, modified, edited, or taken out of context such that it creates a false or misleading statement or impression as to the purpose or use of the papiNet specification, which is an open standard. Use of this Standard, in accord with the foregoing limited permission, shall not create for the user any rights in or to the copyright, which rights are exclusively reserved to the Copyright Owner.

papiNet, IDEAlliance, and the members of all papiNet Groups (collectively and individually, "Presenters") make no representations or warranties, express or implied, including, but not limited to, warranties of merchantability, fitness for a particular purpose, title, or non-infringement. The presenters do not make any representation or warranty that the contents of this document are free from error, suitable for any purpose of any user, or that implementation of such contents will not infringe any third party patents, copyrights, trademarks or other rights. By making use of this document, the user assumes all risks and waives all claims against Presenters.

In no event shall Presenters be liable to user (or other person) for direct, indirect, special or consequential damages arising from or related to any use of this document, including, without limitation, lost profits, business interruption, loss of programs, or other data on your information handling system even if Presenters are expressly advised of the possibility of such damages.

---

### Use of Documents in papiNet Implementations

Documents may be used as templates for a papiNet implementation. The Presenters grant the right to modify and edit them to fit an actual implementation project provided all copies display the copyright and any other proprietary notices contained in this document. Such modified documents must not be distributed beyond the trading partners implementing or maintaining a papiNet connection.

# OrderConfirmation

## papiNet Standard - Version 2.31

---

---

### Table of Contents

Copyright .....	2
Use of Documents in papiNet Implementations .....	2
Table of Contents .....	3
OrderConfirmation Documentation.....	4
OrderConfirmation e-Document Overview .....	4
The Scope of OrderConfirmation e-Document .....	4
OrderConfirmationStatusType [attribute] .....	4
Business Rules for OrderConfirmation.....	4
Processing the OrderConfirmation e-Document .....	5
Understanding the Diagrams and Content .....	7
OrderConfirmation Root Element .....	9
OrderConfirmation .....	9
Primary Elements .....	12
OrderConfirmationHeader .....	12
OrderConfirmationLineItem .....	16
MonetaryAdjustment .....	21
OrderConfirmationSummary.....	27
OrderConfirmation (Paper) Business Scenarios .....	30
OrderConfirmation Scenario Listing .....	30
Scenario A .....	30
Scenario B .....	31
Scenario C .....	32
Scenario D .....	32
Scenario E .....	33
Scenario F .....	34
Scenario G .....	35
Scenario H .....	37

# OrderConfirmation

## papiNet Standard - Version 2.31

### OrderConfirmation Documentation

#### OrderConfirmation e-Document Overview

A seller sends an OrderConfirmation e-Document to a buyer after receiving a PurchaseOrder from that buyer. The e-Document contains a response to the conditions specified in the PurchaseOrder. A supplier may also send an OrderConfirmation e-Document to convey changes that the supplier has made in the order or to convey new information such as a Supplier Reference Number or Job Number.

#### The Scope of OrderConfirmation e-Document

The OrderConfirmation e-Document can include:

- Confirmation or adjustment to the preceding PurchaseOrder e-Document
- The supplier can suggest alternative products only when there has been prior agreement with the buyer.

#### OrderConfirmationStatusType [attribute]

Identifies the status of the whole OrderConfirmation e-Document (i.e. at the root level).



*This item is restricted to the following list.*

##### Accepted

The supplied information is accepted.

##### Amended

The supplied information is changed.

##### Cancelled

The supplied information has been cancelled. Items that have been cancelled are not included in totals on the summary levels of the e-document.

##### Rejected

The supplied information is rejected.

#### Business Rules for OrderConfirmation

##### General Business Rules

The following table lists the business rules that apply to an OrderConfirmation e-Document. For more information about the statuses mentioned in the rules, see the section on processing the OrderConfirmation e-Document.

Identifier	Business Rule
ORC001	An OrderConfirmation e-Document must contain a status type at the document, header, and line item levels.
ORC002	The OrderConfirmation document status must be

## OrderConfirmation papiNet Standard - Version 2.31

Identifier	Business Rule
	Accepted, Amended, Cancelled, or Rejected.
<b>ORC003</b>	The OrderConfirmationHeader status must be Accepted, Amended, NoAction, Pending, or Rejected.
<b>ORC004</b>	An OrderConfirmationLineItem status must be communicated. If the status of a line item is Pending this e-Document will be followed up by at least one other OrderConfirmation e-Document ultimately resulting in the status of the line item being either Accepted or Rejected.
<b>ORC005</b>	An OrderConfirmation e-Document refers to only one PurchaseOrder.
<b>ORC006</b>	An OrderConfirmation e-Document must have all the PurchaseOrderLineItem(s) from the original PurchaseOrder e-Document.
<b>ORC007</b>	If the seller rejects information in the PurchaseOrderHeader, the OrderConfirmation document status will be set to Rejected. The seller must include a reason for the rejection in the OrderConfirmationHeaderStatusTypeText field.
<b>ORC008</b>	If the seller rejects information in a PurchaseOrderLineItem, the OrderConfirmationLineItem status will be set to Rejected. The seller must include a reason for the rejection in the OrderConfirmationLineItemStatusTypeText field.
<b>ORC009</b>	All purchase orders must be responded to with an OrderConfirmation.

### Processing the OrderConfirmation e-Document

e-Document processing depends on the e-Document type and on the values in status fields at the e-Document, header, and line item levels. For the OrderConfirmation e-Document, there is only one e-Document type. There are, however, status fields at all three levels. The status at the e-Document level determines the possible statuses at the header and line item levels.

A seller must send an OrderConfirmation e-Document in response to each purchase order received. The status set at the e-Document level of the OrderConfirmation e-Document indicates whether the seller has accepted the purchase order as a legal commitment between the two parties. The

## OrderConfirmation papiNet Standard - Version 2.31

---

---

status set at the header level indicates whether the seller understands and agrees with the information communicated at the header level, while the statuses set at the line item level indicate whether the seller has committed to providing the line item(s) under the terms defined.

If the seller wants to accept a purchase order but request a change at the line item level, the status set at the e-Document level and header level would be "Accepted", while the status set at the line item level would be "Amended".

Notes:

- Some buyers will cancel the purchase order unless the seller sends an OrderConfirmation e-Document within a specified timeframe. The defined time frame is the ValidityPeriod construct within the Purchase Order.
- When the OrderConfirmation is sent to a party other than the original buyer the pricing information can be removed from the e-Document before transmission.
- The seller can give purchase order line items the status of "Rejected", "Pending", or "NoAction" in the OrderConfirmation e-Document, even though the overall purchase order and other line items are accepted.

After sending an OrderConfirmation e-Document with the status of "Accepted", a seller may need to change details of the agreement at either the header or line item level. Examples of details that might need to change include price, diameter, manufacturing locations, delivery window, shipping instructions, core specifications, or shipment mode. When changes are necessary, the seller sends another OrderConfirmation e-Document, this time with the status of "Amended" at the e-Document level as well as at the header and/or line item level.

Note: The seller should reach agreement with the buyer on these changes before sending the amended e-Document.

### **Status Values Used When Processing the OrderConfirmation e-Document**

The following OrderConfirmationStatusType values provide information about the OrderConfirmation e-Document's status:

- Accepted – Indicates that the purchase order is accepted as a binding commitment under the conditions included in this e-Document.
- Rejected – Indicates that the purchase order is not accepted.
- Amended – Indicates that the seller has made changes to the conditions under which the seller will fulfil a previously accepted purchase order.

If the OrderConfirmationStatusType is "Accepted", OrderConfirmation-Header-Status-Type and OrderConfirmationLineItemStatusType can be any of the following:

- "Accepted" – The seller has accepted all elements in the OrderConfirmationHeader or OrderConfirmationLineItem.
- "Rejected" (only at the line item level) – The seller has rejected one or more elements in the OrderConfirmationLineItem.
- Whenever the OrderConfirmationHeaderStatusType is "Rejected", the e-Document as a whole must also have a status of "Rejected".

# OrderConfirmation

## papiNet Standard - Version 2.31

---

- “Amended” – The seller has amended one or more elements in the OrderConfirmationHeader or OrderConfirmationLineItem.
- “NoAction” – The seller has not amended the OrderConfirmationHeader or OrderConfirmationLineItem and therefore no action is necessary.
- “Pending” – The seller cannot confirm one or more elements in the OrderConfirmationHeader or OrderConfirmationLineItem.

If the OrderConfirmationStatusType is “Rejected” then OrderConfirmationHeaderStatusType and OrderConfirmationLineItemStatusType must also be set to “Rejected”. The purchase order is not in the seller’s system.

If the OrderConfirmationStatusType is “Amended” then OrderConfirmationHeaderStatusType and OrderConfirmationLineItemStatusType can be any of the following:

- “Amended” – The seller has amended one or more elements in the OrderConfirmationHeader or OrderConfirmationLineItem.
- “NoAction” – The seller has not amended the OrderConfirmationHeader or OrderConfirmationLineItem and therefore no action is necessary.
- “Rejected” – The seller has rejected one or more elements in the OrderConfirmationHeader or OrderConfirmationLineItem.

---

### Understanding the Diagrams and Content

This section provides a graphical view of the schema structures, a discussion of the item’s children. You can find additional information about papiNet and the standard at [www.papiNet.org](http://www.papiNet.org).

The graphics contain content model indicators, cardinality indicators, and data type information.

Associated with each graphic are the definitions for the parent item and any associated child items. All attributes are listed first, followed by the elements.

The following information should help you interpret and understand this standard. Please note the following:

- Content Model and Cardinality operate together to determine if the element or attribute are required in the instance document.
- The same attribute can never appear multiple times in the same element so, you will never see a multiple cardinality indicator.

#### Content model indicators:

There are three possible types of content: “sequence”, “choice”, and “all”. The papiNet standard currently does not use the “all” construct.

- (sequence)

The sequence of the items to the right of the graphic (or below the text) is required.

- (choice)

A choice of the items to the right of the graphic (or below the text) is permitted.

- (all)

All the items to the right of the graphic are required.

# OrderConfirmation

## papiNet Standard - Version 2.31

---

---

### Cardinality indicators:

- Dotted line around element or attribute.  
A single instance of the item can optionally exist.
- Dotted line around item with range indicated below.

Multiple instances of the item can optionally exist.

- Solid line around item.  
A single instance of the item must exist.
- Solid line around item with range indicated below

At least one instance must exist; multiple instances can optionally exist.

### Datatype indication:

When a data type is assigned to an element (either a simple type or complex type) the name of the data type is presented beneath the item name in the graphic.

- In some cases additional information about the data type is presented (the default value).

Elements can either have content that is textual/numeric in nature or content that is made up of additional elements and/or attributes.

- When the content is textual/numeric in nature “three straight horizontal lines” will appear in the upper left-hand corner of the graphic. Pay attention to these elements because they are where you will be entering your information.
- When the content is made up of additional elements and/or attributes a “gray-box” will appear on the right-hand side of the graphic.
- If the graphic shows both the horizontal lines and the gray-box then, in the papiNet standard, the content below the element are attributes.



# OrderConfirmation

## papiNet Standard - Version 2.31

### OrderConfirmation Root Element

#### OrderConfirmation

The OrderConfirmation element is the root element for the OrderConfirmation e-Document.

A seller sends an OrderConfirmation e-Document to a buyer after receiving a PurchaseOrder from that buyer. The e-Document contains a response to the conditions specified in the PurchaseOrder. A supplier may also send an OrderConfirmation e-Document to convey changes that the supplier has made in the order or to convey new information such as a Supplier Reference Number or Job Number.

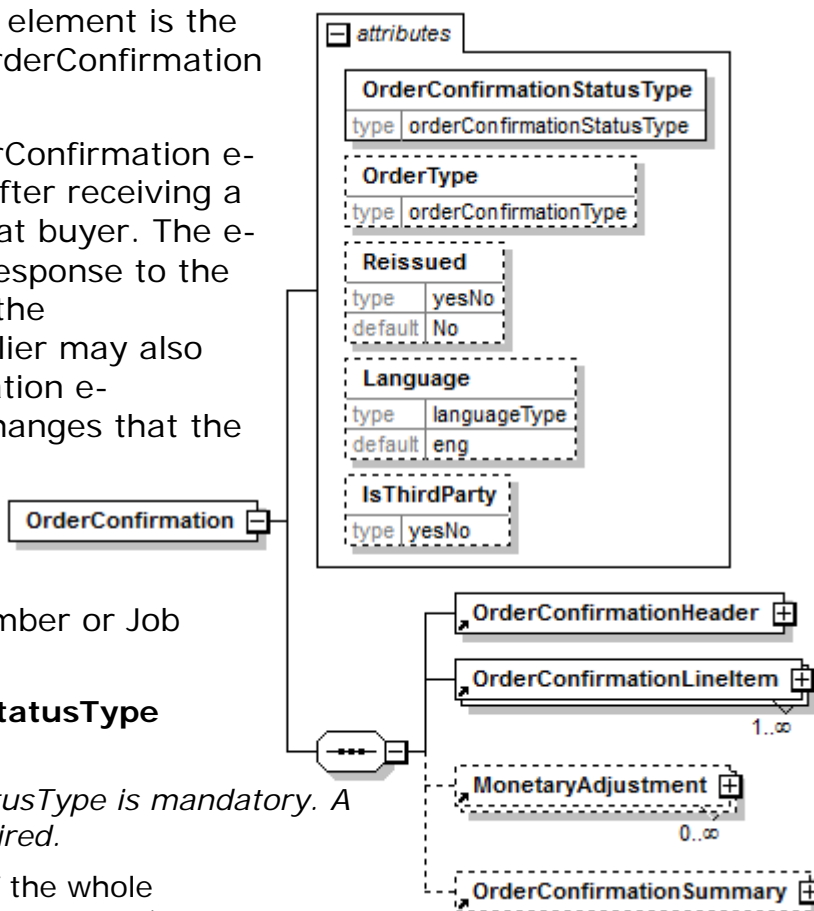

#### OrderConfirmationStatusType [attribute]

*OrderConfirmationStatusType is mandatory. A single instance is required.*

Identifies the status of the whole OrderConfirmation e-Document (i.e. at the root level).

*This item is restricted to the following list.*

##### Accepted

The supplied information is accepted.

##### Amended

The supplied information is changed

##### Cancelled

The supplied information has been cancelled. Items that have been cancelled are not included in totals on the summary levels of the e-document.

##### Rejected

The supplied information is rejected.

#### OrderType [attribute]

*OrderType is optional. A single instance might exist.*

Defines the type of OrderConfirmation being communicated.

*This item is restricted to the following list.*

##### Agreement

# OrderConfirmation

## papiNet Standard - Version 2.31

---

A legally binding exchange of promises between parties that the law will enforce.

### **BlanketOrder**

An order that communicates the same information as a StandardOrder but also indicates that the order may be completed over a period of time or, until a certain volume is achieved or, until a certain currency amount is spent.

### **ConfirmingOrder**

A confirming order is used to electronically confirm an order that has not been placed electronically by the customer that is, it was placed using another mean such as fax, phone or email.

### **ConsumptionOrder**

A purchase order that is based upon consumption for a particular period of time or instance.

### **ReleaseOrder**

A release order is used to release a product to be made. This type of order refers to a previous order or agreement, such as a reservation order, a contract, or a blanket order. A release number version which is an incremented number, is used in this type.

### **ReservationOrder**

A reservation order is used to book a paper supplier's capacity for specific quantities of specific products, but it is not yet a firm commitment to buy. Consequently, all line items of a reservation order have a ProductionStatusType of NotFree. To release one or more purchase order line items of a reservation order, a buyer can use a standard order or a release order.

### **StandardOrder**

A standard order is a regular one-time order. It defines quantities for one or more products to be purchased and may also define a delivery location and date. A standard order may reference a previous agreement (for example, a quotation, a contract, or a reservation order) for information.

### **TrialOrder**

A trial order is used whenever a seller has agreed to have a buyer sample a product. The seller needs to process this order differently from other orders, because a trial order may include a product sold at a discounted rate or even provided for free. A trial order typically is for small quantities.

### **Language [attribute]**

*Language is optional. A single instance might exist.*

The valid Alpha 2- and Alpha 3-character list of language codes in the ISO 639-1 and 639-2 international standards.

Information on the content of this attribute is available at:  
[https://www.loc.gov/standards/iso639-2/php/code\\_list.php](https://www.loc.gov/standards/iso639-2/php/code_list.php)

### **Reissued [attribute]**

*Reissued is optional. A single instance might exist.*

Either "Yes" or "No".

*This item is restricted to the following list.*

**Yes**

# OrderConfirmation

## papiNet Standard - Version 2.31

---

---

**No**

### **IsThirdParty [attribute]**

*IsThirdParty is optional. A single instance might exist.*

Indication of an indirect business process.

*This item is restricted to the following list.*

**Yes**

**No**

### **(sequence)**

*The sequence of items below is mandatory. A single instance is required.*

#### **OrderConfirmationHeader**

*OrderConfirmationHeader is mandatory. A single instance is required.*

Information that is common to all items on the OrderConfirmation.

#### **OrderConfirmationLineItem**

*OrderConfirmationLineItem is mandatory. One instance is required, multiple instances might exist.*

The detail of the items that are communicated in the OrderConfirmation e-Document.

#### **MonetaryAdjustment**

*MonetaryAdjustment is optional. Multiple instances might exist.*

The element containing the information necessary for the understanding, calculation, and treatment of an adjustment to a currency amount.

MonetaryAdjustment contains an attribute that indicates they type of adjustment being communicated.

#### **OrderConfirmationSummary**

*OrderConfirmationSummary is optional. A single instance might exist.*

Summary information that applies to the whole OrderConfirmation e-Document.

# OrderConfirmation

## papiNet Standard - Version 2.31

### Primary Elements

#### OrderConfirmationHeader

Information that is common to all items on the OrderConfirmation.

##### OrderConfirmationHeaderStatusType [attribute]

*OrderConfirmationHeaderStatusType is mandatory. A single instance is required.*

An attribute defining the status of the OrderConfirmation header

*This item is restricted to the following list.*

##### Accepted

The supplied information is accepted.

##### Amended

The supplied information is changed.

##### Cancelled

The supplied information has been cancelled. Items that have been cancelled are not included in totals on the summary levels of the e-document.

##### NoAction

The supplied information has not been amended and thereby requires no action.

##### Pending

The supplied information is not complete and will be updated later.

##### Rejected

The supplied information is rejected.

##### (sequence)

*The sequence of items below is mandatory. A single instance is required.*

##### OrderConfirmationNumber

*OrderConfirmationNumber is optional. A single instance might exist.*

The unique order identifier as designated by the seller.

##### OrderConfirmationHeaderStatusTypeText

*OrderConfirmationHeaderStatusTypeText is optional. A single instance might exist.*

A text field that may provide detail explaining the status of the OrderConfirmationHeader.

- This field is required if the

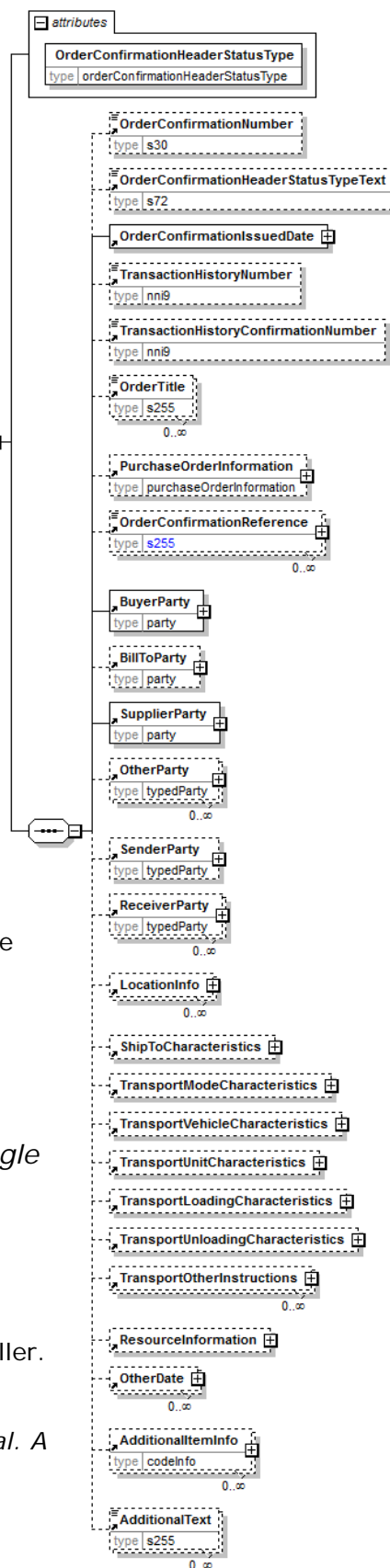

# OrderConfirmation

## papiNet Standard - Version 2.31

---

OrderConfirmationHeaderStatusType is "Rejected".

- When the OrderConfirmationHeaderStatusType is "Pending", the reason can be specified in this field.
- Not required if the PurchaseOrder is "Accepted".

### **OrderConfirmationIssuedDate**

*OrderConfirmationIssuedDate is mandatory. A single instance is required.*

The Date and optionally the Time that the OrderConfirmation was issued.

### **TransactionHistoryNumber**

*TransactionHistoryNumber is optional. A single instance might exist.*

A sequential number that keeps track of the version of a document being sent by the document originator. However when the document is a confirmation document, in which case the TransactionHistoryNumber refers to the trigger transaction for which the confirmation is being sent.

### **TransactionHistoryConfirmationNumber**

*TransactionHistoryConfirmationNumber is optional. A single instance might exist.*

A sequential number that indicates the version of the confirmation document being sent.

### **OrderTitle**

*OrderTitle is optional. Multiple instances might exist.*

A text describing the context of the order

### **PurchaseOrderInformation**

*PurchaseOrderInformation is optional. A single instance might exist.*

A group item containing information unique to this PurchaseOrder, which is provided by the buyer. PurchaseOrderInformation can be optional in the supply chain. Invoices are created without having a PurchaseOrder in Vendor Managed Inventory. Freight invoices also will not have a PurchaseOrder number.

### **OrderConfirmationReference**

*OrderConfirmationReference is optional. Multiple instances might exist.*

A group item detailing relevant references pertaining to the OrderConfirmation. Typically, the ContractNumber is referenced. OrderConfirmationReferenceType provides the identification of what the reference represents.

### **BuyerParty**

*BuyerParty is mandatory. A single instance is required.*

The legal entity to which the product is sold. Also commonly referred to as the sold-to party or customer. If no OtherParty is defined as the Payer, the Buyer is the Payer.

### **BillToParty**

*BillToParty is optional. A single instance might exist.*

The address where the invoice is to be sent.

### **SupplierParty**

*SupplierParty is mandatory. A single instance is required.*

The organisation or business entity responsible for providing the product. SupplierParty is also the seller of the product, if Seller is not specified as OtherParty = Seller.

# OrderConfirmation

## papiNet Standard - Version 2.31

---

### **OtherParty**

*OtherParty is optional. Multiple instances might exist.*

An organisation or business entity other than those specifically detailed within a e-Document.

### **SenderParty**

*SenderParty is optional. A single instance might exist.*

The business entity issuing the e-Document, the source of the document.

- The entity responsible for the content. If the sender party has out sourced the message service to a third party the SenderParty is the issuer of the e-Document and not the party performing the transmission service of the electronic message.

### **ReceiverParty**

*ReceiverParty is optional. Multiple instances might exist.*

The business entity for whom the e-Document is intended, the destination of the document.

- The entity interested in the content. If the receiver party has outsourced the message service to a third party the ReceiverParty is the intended party for the e-Document and not the party performing the receiving service of the electronic message.

### **LocationInfo**

*LocationInfo is optional. Multiple instances might exist.*

A grouping element that contains information about a geographical location.

### **ShipToCharacteristics**

*ShipToCharacteristics is optional. A single instance might exist.*

A group item that provides information important for the Ship-To Party.

### **TransportModeCharacteristics**

*TransportModeCharacteristics is optional. A single instance might exist.*

A group item defining the primary mode of transport.

### **TransportVehicleCharacteristics**

*TransportVehicleCharacteristics is optional. A single instance might exist.*

A group item containing information about a transport vehicle, e.g. a truck. A transport vehicle has its own power and can be used to pull, push, carry, or tow a transport unit loaded with goods.

### **TransportUnitCharacteristics**

*TransportUnitCharacteristics is optional. A single instance might exist.*

A group item containing information about a transport unit, e.g. a trailer. Transport units contain goods and move using power from another source, the transport vehicle.

### **TransportLoadingCharacteristics**

*TransportLoadingCharacteristics is optional. A single instance might exist.*

A group item defining how the transported items are to be loaded.

### **TransportUnloadingCharacteristics**

*TransportUnloadingCharacteristics is optional. A single instance might exist.*

# OrderConfirmation

## papiNet Standard - Version 2.31

---

---

A group item defining how the transported items are to be unloaded.

### **TransportOtherInstructions**

*TransportOtherInstructions is optional. Multiple instances might exist.*

A group item defining any other instructions for the transport not covered in the description of transport mode, vehicle, unit, and loading characteristics or defining an alternative description for the categories mentioned above.

### **ResourceInformation**

*ResourceInformation is optional. A single instance might exist.*

A group item that contains information for specification of resources.

### **OtherDate**

*OtherDate is optional. Multiple instances might exist.*

A date that may not be specifically detailed within a document (example: print date at the PurchaseOrderLineItem).

### **AdditionalItemInfo**

*AdditionalItemInfo is optional. Multiple instances might exist.*

A grouping element that contains information about additional items specified by an agency. Restricted use of this element is recommended.

### **AdditionalText**

*AdditionalText is optional. Multiple instances might exist.*

A text field that is used to communicate information not previously defined or for special instructions. To be used only for circumstances not covered by specific elements.

# OrderConfirmation

## papiNet Standard - Version 2.31

### OrderConfirmationLineItem

The detail of the items that are communicated in the OrderConfirmation e-Document.

#### OrderConfirmationLineItemStatusType [attribute]

*OrderConfirmationLineItemStatusType is mandatory. A single instance is required.*

Defines the status of the OrderConfirmation line item

*This item is restricted to the following list.*

##### Accepted

The supplied information is accepted.

##### Amended

The supplied information is changed.

##### Cancelled

The supplied information has been cancelled. Items that have been cancelled are not included in totals on the summary levels of the e-document.

##### NoAction

The supplied information has not been amended and thereby requires no action.

##### Pending

The supplied information is not complete and will be updated later.

##### Rejected

The supplied information is rejected.

#### OrderConfirmationLineItemDocumentStatus [attribute]

*OrderConfirmationLineItemDocumentStatus is optional. A single instance might exist.*

Defines the actual document status for the OrderConfirmationLineItem.

*This item is restricted to the following list.*

##### Cancelled

The supplied information of the document item is cancelled. Items that have been cancelled are not included in totals on the summary level of e-documents.

##### Confirmed

The supplied information of the document item is agreed. If a requested change or cancellation of an existing document item can not be accepted, then the earlier agreed information of the document item will be re-confirmed.

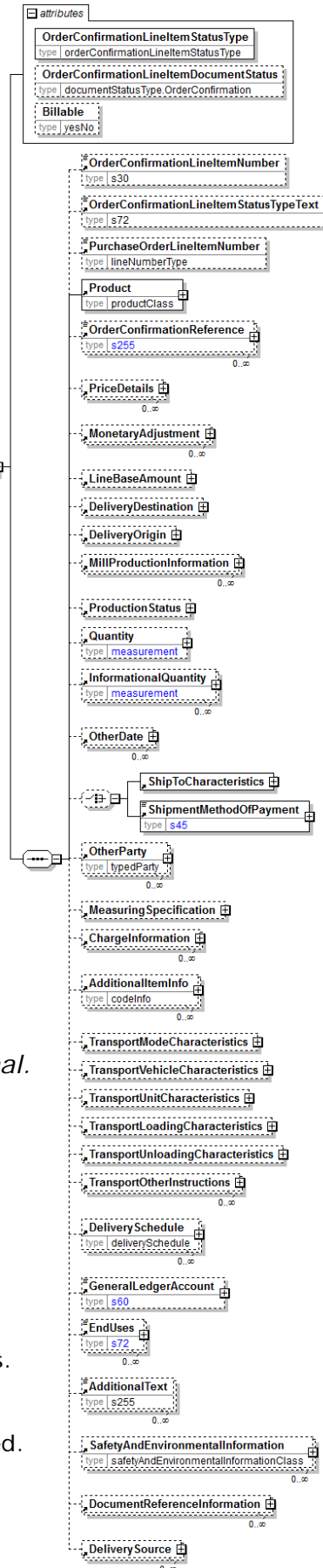



# OrderConfirmation

## papiNet Standard - Version 2.31

---

### **Pending**

The supplied information of the document item is being investigated.

### **Rejected**

The supplied information of the document item can not be accepted. The document item is new or not earlier confirmed.

### **Billable [attribute]**

*Billable is optional. A single instance might exist.*

Either "Yes" or "No".

*This item is restricted to the following list.*

**Yes**

**No**

### **(sequence)**

*The sequence of items below is mandatory. A single instance is required.*

#### **OrderConfirmationLineItemNumber**

*OrderConfirmationLineItemNumber is optional. A single instance might exist.*

The sequential number that uniquely identifies the OrderConfirmation line item.

#### **OrderConfirmationLineItemStatusTypeText**

*OrderConfirmationLineItemStatusTypeText is optional. A single instance might exist.*

A text field that may provide detail explaining the status of the OrderConfirmationLineItem.

- When a PurchaseOrderLineItem is rejected, the reason for the rejection must be specified in this field.
- Not required if the PurchaseOrder is accepted or no changes have been made.
- If the item is pending, the reason may be specified here.

#### **PurchaseOrderLineItemNumber**

*PurchaseOrderLineItemNumber is optional. A single instance might exist.*

The sequential number that uniquely identifies the PurchaseOrder line item.

#### **Product**

*Product is mandatory. A single instance is required.*

Product is a group item defining the article and its characteristics. Product is used to specify product characteristics organized by ProductIdentifier, ProductDescription, and Classification. Book Manufacturing, Label Stock, Paper, Pulp, Recovered Paper, Wood Products, and Virgin Fibre market segments have defined their product characteristics and conversion features for implementation in papiNet.

#### **OrderConfirmationReference**

*OrderConfirmationReference is optional. Multiple instances might exist.*

A group item detailing relevant references pertaining to the OrderConfirmation. Typically, the ContractNumber is referenced. OrderConfirmationReferenceType provides the identification of what the reference represents.

#### **PriceDetails**

*PriceDetails is optional. Multiple instances might exist.*

# OrderConfirmation

## papiNet Standard - Version 2.31

---

An element that groups together price information.

### **MonetaryAdjustment**

*MonetaryAdjustment is optional. Multiple instances might exist.*

The element containing the information necessary for the understanding, calculation, and treatment of an adjustment to a currency amount. MonetaryAdjustment contains an attribute that indicates the type of adjustment being communicated.

### **LineBaseAmount**

*LineBaseAmount is optional. A single instance might exist.*

For the particular e-Document being communicated the LineBaseAmount represents the quantity times the base unit price.

### **DeliveryDestination**

*DeliveryDestination is optional. A single instance might exist.*

The DeliveryDestination specifies the end of one leg of the delivery. In order to comply with the US Trade Act of 2002 you would use this element with a LocationParty/@PartyType of Port.

### **DeliveryOrigin**

*DeliveryOrigin is optional. A single instance might exist.*

A group item that represents the start of one leg in a route. Compare to DeliveryDestination.

- The DeliveryOrigin specifies the start of one leg of the delivery.
- In order to comply with the US Trade Act of 2002 you would use this element with a LocationParty/@PartyType of Port.

### **MillProductionInformation**

*MillProductionInformation is optional. Multiple instances might exist.*

A grouping element that contains information about production at the mill.

### **ProductionStatus**

*ProductionStatus is optional. A single instance might exist.*

A group item used to communicate the release of a delivery line number.

### **Quantity**

*Quantity is optional. A single instance might exist.*

The Quantity element contains attributes that provide information about the type of quantity that is being communicated, the context in which the particular quantity is to be viewed, and (if the quantity represents an adjustment) an adjustment type.

The Quantity element contains three child elements that enable you to communicate a range of values for the quantity and a target or actual value. It is at this level (Value, RangeMin, and RangeMax) that the unit of measure is specified. This permits the range to be specified in a different unit of measure than the target.

### **InformationalQuantity**

*InformationalQuantity is optional. Multiple instances might exist.*

A quantity given in a valid UOM used for information purposes only (not for calculation). For example, an ordered quantity was 100 reels as opposed to the invoice quantity of 20,000 pounds.

# OrderConfirmation

## papiNet Standard - Version 2.31

---

---

### **OtherDate**

*OtherDate is optional. Multiple instances might exist.*

A date that may not be specifically detailed within a document (example: print date at the PurchaseOrderLineItem).

### **(choice)**

*[choice] is optional. A single instance might exist.*

### **ShipToCharacteristics**

*ShipToCharacteristics is mandatory. A single instance is required.*

A group item that provides information important for the Ship-To Party.

### **ShipmentMethodOfPayment**

*ShipmentMethodOfPayment is mandatory. A single instance is required.*

An element communicating responsibility of freight payment and when transfer of ownership will occur.

### **OtherParty**

*OtherParty is optional. Multiple instances might exist.*

An organisation or business entity other than those specifically detailed within a e-Document.

### **MeasuringSpecification**

*MeasuringSpecification is optional. A single instance might exist.*

A grouping element that contains a specification for measurement procedures

### **ChargeInformation**

*ChargeInformation is optional. Multiple instances might exist.*

A group element that contains elements that describe a charge. ChargeInformation is used when charge details need to be specified by using a code assigned by an agency. It is typically used for freight costs and other costs related to the supply chain.

### **AdditionalItemInfo**

*AdditionalItemInfo is optional. Multiple instances might exist.*

A grouping element that contains information about additional items specified by an agency. Restricted use of this element is recommended.

### **TransportModeCharacteristics**

*TransportModeCharacteristics is optional. A single instance might exist.*

A group item defining the primary mode of transport.

### **TransportVehicleCharacteristics**

*TransportVehicleCharacteristics is optional. A single instance might exist.*

A group item containing information about a transport vehicle, e.g. a truck. A transport vehicle has its own power and can be used to pull, push, carry, or tow a transport unit loaded with goods.

### **TransportUnitCharacteristics**

*TransportUnitCharacteristics is optional. A single instance might exist.*

A group item containing information about a transport unit, e.g. a trailer. Transport units contain goods and move using power from another source, the transport

# OrderConfirmation

## papiNet Standard - Version 2.31

---

vehicle.

### **TransportLoadingCharacteristics**

*TransportLoadingCharacteristics is optional. A single instance might exist.*

A group item defining how the transported items are to be loaded.

### **TransportUnloadingCharacteristics**

*TransportUnloadingCharacteristics is optional. A single instance might exist.*

A group item defining how the transported items are to be unloaded.

### **TransportOtherInstructions**

*TransportOtherInstructions is optional. Multiple instances might exist.*

A group item defining any other instructions for the transport not covered in the description of transport mode, vehicle, unit, and loading characteristics or defining an alternative description for the categories mentioned above.

### **DeliverySchedule**

*DeliverySchedule is optional. Multiple instances might exist.*

A group item defining a series of DeliveryDateWindow(s) in which specified quantities must be delivered.

### **GeneralLedgerAccount**

*GeneralLedgerAccount is optional. A single instance might exist.*

The general ledger account to be referenced for the item.

### **EndUses**

*EndUses is optional. Multiple instances might exist.*

A text element used to express in human readable form a list of applicable end uses for a product. Examples of end uses are:

- Magazine
- Book
- Commercial print
- etc

### **AdditionalText**

*AdditionalText is optional. Multiple instances might exist.*

A text field that is used to communicate information not previously defined or for special instructions. To be used only for circumstances not covered by specific elements.

### **SafetyAndEnvironmentalInformation**

*SafetyAndEnvironmentalInformation is optional. Multiple instances might exist.*

Name of certification type, if any, on the goods (For example, FSC, PEFC). SafetyAndEnvironmental needs a value or measurement to communicate the percentage of the product is certified (for example, 75% is certified by the indicated agency).

### **DocumentReferenceInformation**

*DocumentReferenceInformation is optional. Multiple instances might exist.*

A group item containing reference information applicable to a document.

### **DeliverySource**

DeliverySource is optional. Multiple instances might exist.

# OrderConfirmation

## papiNet Standard - Version 2.31

A grouping element with information that identifies and specifies the source of a delivery, e.g. a logging area.

### MonetaryAdjustment

The element containing the information necessary for the understanding, calculation, and treatment of an adjustment to a currency amount. MonetaryAdjustment contains an attribute that indicates they type of adjustment being communicated.

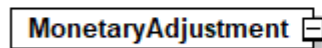

#### AdjustmentType [attribute]

*AdjustmentType is mandatory. A single instance is required.*

Describes the type of adjustment applied to a monetary oriented element. Adjustment values should always be given as negative or positive adjustments even if AdjustmentType indicates the sign. For example, a rebate of 1% on an invoice should be given as an adjustment percentage of -1%.

*This item is restricted to the following list.*

#### BillOfLadingCharge

An extra charge for creating a Bill of Lading.

#### CancellationCharge

A charge applied because a cancellation was late (after the last date of change) and all or part of the ordered product has already been made.

#### CashDiscount

A reduction due to a discount applied.

#### CertificateCharge

An extra charge for creating a certificate. Some countries requires Certificates in which different characteristics of the delivery, transport unit, route, product, and

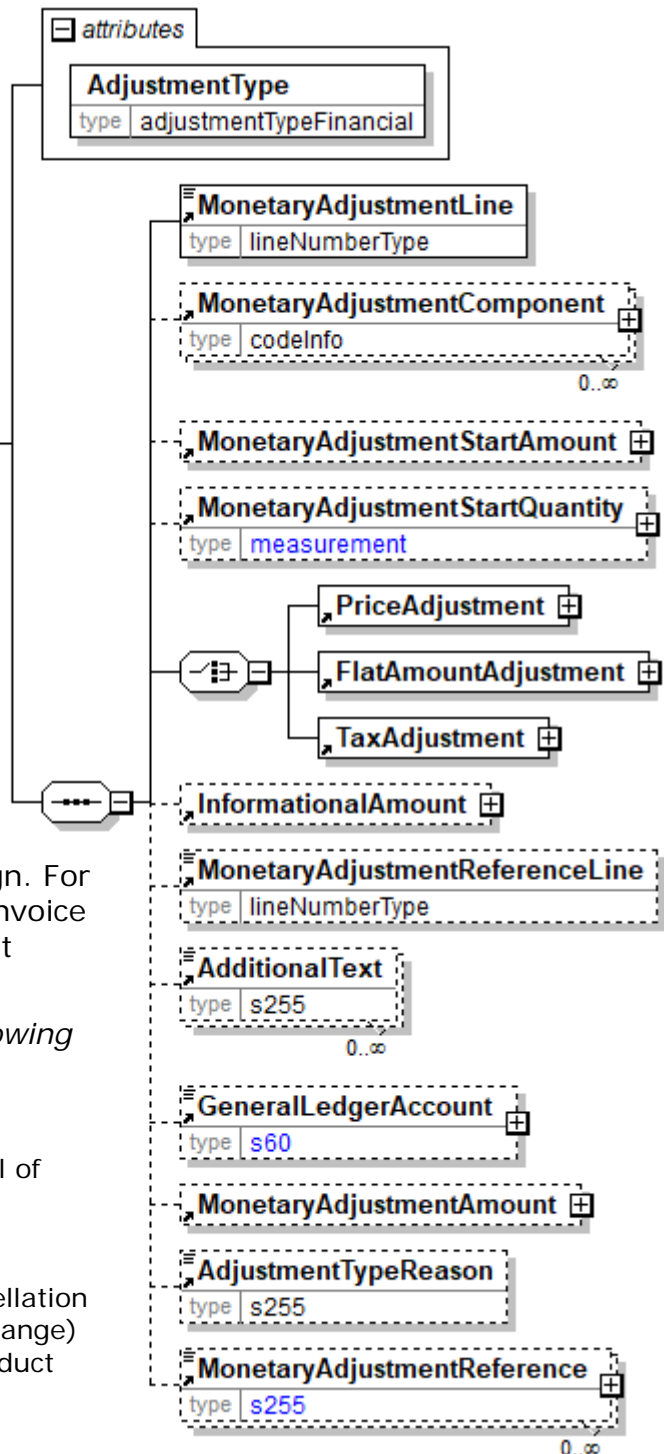

# OrderConfirmation

## papiNet Standard - Version 2.31

---

---

others must be proved.

There are certificates for gasen pallets, for the place of production, for the age of the ship/vessel, for not departing from one country's harbour when delivering to another.

### **ChargesForward**

A pending invoice amount brought forward from a previous Invoice.

### **ClaimAdjustment**

An adjustment related to a filed complaint.

### **Commission**

Commission costs paid to the trading agency or trader.

### **CompetitiveAllowance**

An allowance provided for competitive reasons.

### **CongestionCharge**

An extra fee from ports for waiting time of ships in ports, railcars on a siding, trucks at a dock. (Synonym: Demurrage.)

### **ConsigneeUnloadCharge**

An unloading charge that is the responsibility of the consignee.

### **ContractAllowance**

An allowance for a volume discount, usually because the agreed amount has been exceeded.

### **CurrencyAdjustmentCharge**

An extra fee to adjust for currency variations.

### **DecimalRounding**

Adjustments for rounding of amounts to fit the business agreement or national monetary legislation. This adjustment is typically used for decimal rounding of amounts not including tax.

N.B. Use InformationalAmount with AmountType "DecimalRounding" for specification of decimal rounding of amounts including tax.

### **DefectiveAllowance**

An allowance provided for defective material.

### **DeliveryCharge**

The charge for delivering the product.

### **DeliveryNonConformanceAllowance**

An allowance due to non-conformance with the purchase agreement regarding a delivery.

### **DeliveryTimeBonus**

A bonus given for deliveries of products within a certain time period.

### **EarlyShipAllowance**

An allowance due to a delivery that took place earlier than planned. The seller may be charged a penalty. If this is found before issuing the Invoice, it can be handled through this allowance. If found later, it will be handled through a credit note.

### **EnergySurcharge**

# OrderConfirmation

## papiNet Standard - Version 2.31

---

---

A charge related to increases in the cost of energy.

### **Environmental**

An allowance applied due to environmental regulations.

### **ExpeditedShipmentCharge**

An extra cost charged due to unexpected or emergency requirements (for example, breaking off a run in the mill to reach the production date for a rush order).

### **ExportClearanceCharge**

An extra fee for customs administration.

### **FlatRateCharge**

A general flat charge.

### **FreightAllowance**

The freight cost allowed by the mill. This amount is negative, and will be deducted from the Invoice (U.S. business practice, in the European Union (EU), use only Freight Charge).

### **FreightCharge**

The actual cost incurred to deliver the product. This amount is positive, and will be added to the Invoice.

### **FuelAdjustmentCharge**

An extra fee, usually from shipping companies, to adjust fuel prices.

### **HandlingCharge**

A charge related to the handling of the product.

### **Inspection**

The cost associated with performing an inspection of the product.

### **InterestCharge**

A charge applied for interest on overdue payments.

### **LabourAllowance**

An allowance due to additional labour required in the use or acceptance of the product.

### **LabourCharge**

A charge due to additional labour required in the use or acceptance of the product.

### **LoggingDamage**

An adjustment caused by logging damages on Forest Wood products. Logging damages normally cause a reduction of the product price.

### **LotCharge**

A charge applied to the lot of material.

### **MetalDetection**

A charge for additional metal detection applied to the goods.

### **ModelHomeDiscount**

A discount associated with the building of the model home.

### **NewStoreCouponDiscount**

# OrderConfirmation

## papiNet Standard - Version 2.31

---

---

A discount associated with entry into a new store.

### **OrderQuantity**

A charge or allowance for small/big ordered quantities.

### **PalletCharge**

A charge that represents the cost or rental of the pallet.

### **PickUpAllowance**

An allowance provided to compensate for the cost of picking up the product.

### **PromotionalAllowance**

An allowance provided for the promotion of the product.

### **PromotionalCharge**

A charge associated with the promotion of the product.

### **PriceCorrection**

An adjustment associated with a correction of the product's price.

### **ProductionSetUpCharge**

A special charge applied due to specific buyer requests.

### **Provision**

The act of making ready or equipping for use.

### **Rebate**

A rebate accepted by the buyer and seller based on the agreed price and volume.

### **ReelDiscount**

An allowance for purchasing reels instead of sheets.

### **ReturnedLoadAllowance**

An allowance applied due to the return of the load.

### **ReturnLoadCharge**

A charge applied due to the return of the load.

### **RoadFeeCharge**

A freight charge for a special tax applied to road transports in some countries, e.g. Germany

### **ScrapAndDunnageCharge**

A charge that represents the scrapping of the material and its removal.

### **ServiceCharge**

A charge associated with a miscellaneous service.

### **SpecialConversionCharge**

Additional charge for a special conversion of the product.

### **SpecialDeliveryCharge**

A special charge for delivering the product differently from the usual or agreed-to method.

### **SpecialHandlingCharge**

A special charge for handling the product differently from the usual or agreed-to



# OrderConfirmation

## papiNet Standard - Version 2.31

---

---

method.

### **SpecialPackagingCharge**

A special charge for packaging the product differently from the usual or agreed-to method, or if packaging as requested is out of spec.

### **StopOffAllowance**

An allowance for a delivery stop-off.

### **StopOffCharge**

A charge for a delivery stop-off.

### **StorageAllowance**

An allowance for storing the product.

### **StorageCharge**

An extra cost charged for storing the product on location (in the plant).

### **Tax**

An adjustment that reflects a tax item.

### **TestingCharge**

A charge related to testing a paper grade.

### **TradeDiscount**

A discount based on the terms of the trade given on the agreed price. Usually a percentage.

### **TrialDiscount**

A discount applied for a trial run of a new or improved product.

### **TransferCharge**

A freight charge incurred by the goods transfer from one location to another location not previously agreed upon.

### **UnloadingAllowance**

An allowance to compensate for the unloading the product.

### **UnloadingCharge**

A charge for the unloading the product.

### **VolumeDiscount**

A rebate accepted by the buyer and the seller based on the agreed volume

### **WarRiskCharge**

An extra fee from transport companies for transport units that cross war zones.

### **Other**

Any other adjustment not covered by the attribute list.

### **(sequence)**

*The sequence of items below is mandatory. A single instance is required.*

### **MonetaryAdjustmentLine**

*MonetaryAdjustmentLine is mandatory. A single instance is required.*

A sequence number indicating the order of printing or the sequence in which a group of adjustments are to be considered.

# OrderConfirmation

## papiNet Standard - Version 2.31

---

### **MonetaryAdjustmentComponent**

*MonetaryAdjustmentComponent is optional. Multiple instances might exist.*

A group item that contains information for specifying a monetary adjustment component by a code assigned by an agency.

### **MonetaryAdjustmentStartAmount**

*MonetaryAdjustmentStartAmount is optional. A single instance might exist.*

The beginning currency amount used in the calculation of a monetary adjustment.

### **MonetaryAdjustmentStartQuantity**

*MonetaryAdjustmentStartQuantity is optional. A single instance might exist.*

The beginning quantity used in the calculation of a monetary adjustment.

### **(choice)**

*[choice] is optional because of choice construct.*

### **PriceAdjustment**

*PriceAdjustment is optional because of choice construct.*

A group item defining a deviation from the PricePerUnit.

### **FlatAmountAdjustment**

*FlatAmountAdjustment is optional because of choice construct.*

A group item that contains flat adjustment amount information.

### **TaxAdjustment**

*TaxAdjustment is optional because of choice construct.*

This content element contains the necessary information to describe, calculate, and handle a tax adjustment.

### **InformationalAmount**

*InformationalAmount is optional. A single instance might exist.*

A monetary amount used for information purposes only (not for calculation). For example, the invoice price adjustment subtotal is expressed in sterling pounds, and the buyer wants this information expressed in U.S. dollars.

- CreditDebitNote and Invoice - The TaxAmount is displayed in the currency that is applicable throughout the e-Document. When a TaxAmount needs to be displayed in a different national currency, this field is used.

### **MonetaryAdjustmentReferenceLine**

*MonetaryAdjustmentReferenceLine is optional. A single instance might exist.*

A link to a previously defined MonetaryAdjustmentLine upon which this adjustment is based.

### **AdditionalText**

*AdditionalText is optional. Multiple instances might exist.*

A text field that is used to communicate information not previously defined or for special instructions. To be used only for circumstances not covered by specific elements.

### **GeneralLedgerAccount**

*GeneralLedgerAccount is optional. A single instance might exist.*

The general ledger account to be referenced for the item.

# OrderConfirmation

## papiNet Standard - Version 2.31

---

### MonetaryAdjustmentAmount

*MonetaryAdjustmentAmount is optional. A single instance might exist.*

The actual amount of the monetary adjustment.

### AdjustmentTypeReason

*AdjustmentTypeReason is optional. A single instance might exist.*

Provides additional information about the type of adjustment. Can be viewed as a sub-classification of the adjustment type attribute or as a textual explanation.

### MonetaryAdjustmentReference

*MonetaryAdjustmentReference is optional. Multiple instances might exist.*

An element detailing relevant references pertaining to the MonetaryAdjustment as indicated by MonetaryAdjustmentReferenceType and AssignedBy.

---

## OrderConfirmationSummary

Summary information that applies to the whole OrderConfirmation e-Document.

### (sequence)

*The sequence of items below is mandatory. A single instance is required.*

#### TotalNumberOfLineItems

*TotalNumberOfLineItems is optional. A single instance might exist.*

The total number of individual line items in the document, regardless of the status or type.

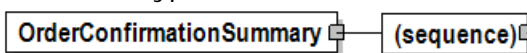

### (sequence)

*The sequence of items below is optional. Multiple instances might exist.*

#### TotalQuantity

*TotalQuantity is mandatory. A single instance is required.*

The total quantity of similar items in the e-Document. TotalQuantity is primarily used in the summary section of documents where it is repeatable to permit totaling for different units of measure.

#### TotalInformationalQuantity

*TotalInformationalQuantity is optional. Multiple instances might exist.*

A quantity that is used to communicate related information about the parent

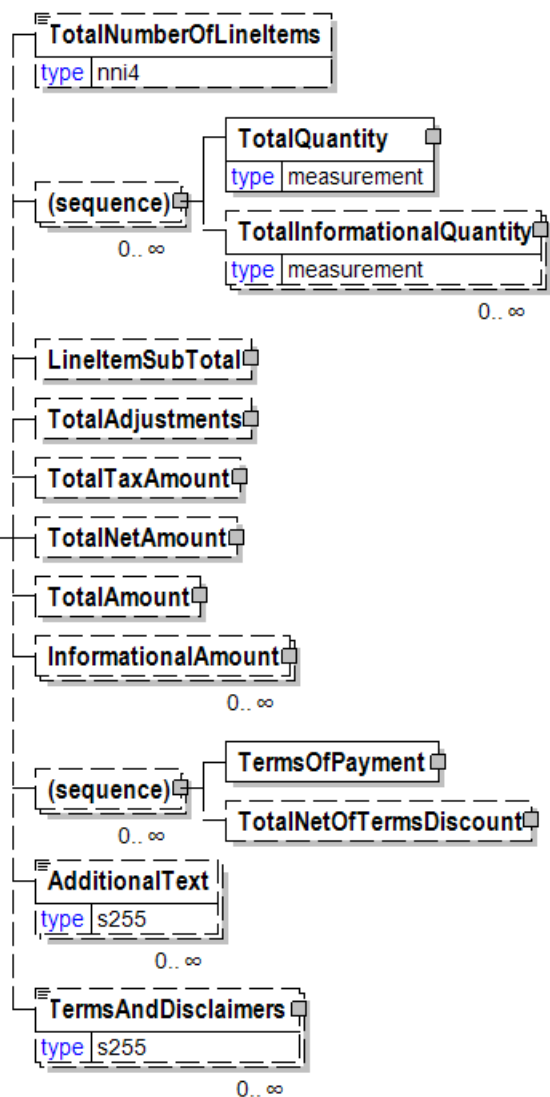

# OrderConfirmation

## papiNet Standard - Version 2.31

---

---

element. This element represents a total that is derived from individual line items.

### **LineItemSubTotal**

*LineItemSubTotal is optional. A single instance might exist.*

The total amount of all base amounts on e-Document line items. The base amount contains the result of the calculation quantity times the base unit price. As such it does not include any taxes. For example, in an Invoice claiming payment for products LineItemSubTotal is equal to the sum of all InvoiceLineBaseAmount.

### **TotalAdjustments**

*TotalAdjustments is optional. A single instance might exist.*

The CurrencyValue of TotalAdjustments contains the total of all adjustments and charges excluding tax. For example, in the Invoice TotalAdjustments is equal to the sum of the signed values of the MonetaryAdjustmentAmount for all instances of MonetaryAdjustment with PriceAdjustment and FlatAmountAdjustment and plus the sum of the signed values of the ChargeNetAmount for all instances of ChargeInformation.

### **TotalTaxAmount**

*TotalTaxAmount is optional. A single instance might exist.*

The CurrencyValue of TotalTaxAmount contains the sum of all instances of TaxAdjustment in the document. TotalTaxAmount contains the sum of all instances of the MonetaryAdjustmentAmount for tax adjustments.

### **TotalNetAmount**

*TotalNetAmount is optional. A single instance might exist.*

A field containing total amount excluding tax. For example, in the Invoice TotalNetAmount is equal to the sum of LineItemSubTotal plus TotalAdjustments. TotalNetAmount encapsulates CurrencyValue.

### **TotalAmount**

*TotalAmount is optional. A single instance might exist.*

The total amount including tax (when tax is specified in the e-Document).

In e-Documents claiming payment this is the amount due for payment based on the terms of payment. Decimal rounding might be applied to this amount.

### **InformationalAmount**

*InformationalAmount is optional. Multiple instances might exist.*

A monetary amount used for information purposes only (not for calculation). For example, the invoice price adjustment subtotal is expressed in sterling pounds, and the buyer wants this information expressed in U.S. dollars.

- CreditDebitNote and Invoice - The TaxAmount is displayed in the currency that is applicable throughout the e-Document. When a TaxAmount needs to be displayed in a different national currency, this field is used.

### **(sequence)**

*The sequence of items below is optional. Multiple instances might exist.*

### **TermsOfPayment**

*TermsOfPayment is mandatory. A single instance is required.*

A group item that contains agreed-to terms defining when, how, and under what conditions the payment is to be made.

# OrderConfirmation

## papiNet Standard - Version 2.31

---

---

When TermsOfPayment is optional; if omitted, TermsOfPayment is controlled through previous negotiation.

### **TotalNetOfTermsDiscount**

*TotalNetOfTermsDiscount is optional. A single instance might exist.*

The components of the amount to be paid if prompt payment discount terms are met, including the amount that is subject to the payment terms discount, the discount amount, and the amount due after prompt payment discount.

### **AdditionalText**

*AdditionalText is optional. Multiple instances might exist.*

A text field that is used to communicate information not previously defined or for special instructions. To be used only for circumstances not covered by specific elements.

### **TermsAndDisclaimers**

*TermsAndDisclaimers is optional. Multiple instances might exist.*

An element that contains legal information with an indication of what the Language is.

## OrderConfirmation papiNet Standard - Version 2.31

### OrderConfirmation (Paper) Business Scenarios

#### OrderConfirmation Scenario Listing

<b>Scenario A</b>	Buyer issues a single-line PurchaseOrder that is Pending by Supplier specifying the reason (optional) and then is later Accepted by the Supplier.
<b>Scenario B</b>	Buyer issues a PurchaseOrder that contains a change to Header information.
<b>Scenario C</b>	Buyer issues a multi-line PurchaseOrder with all line items Accepted by the Supplier.
<b>Scenario D</b>	Buyer issues a multi-line PurchaseOrder with all line items Rejected by the Supplier
<b>Scenario E</b>	Buyer issues a multi-line item PurchaseOrder and Supplier responds with 2 Accepted line items and 1 Rejected line items. Buyer only pursues the accepted items.
<b>Scenario F</b>	Buyer issues multi-line PurchaseOrder and the Supplier responds by accepting some line items and rejecting others. Buyer modifies the rejected line items and sends an Amended Purchase Order.
<b>Scenario G</b>	Buyer issues multi-line PurchaseOrder and Supplier responds by accepting some line items, rejecting some items, and pending others. Buyer modifies the rejected line items and sends an Amended Purchase Order.
<b>Scenario H</b>	Supplier initiates a change to a PurchaseOrder that had been previously Accepted.

#### Scenario A

<b>e-Document</b>	OrderConfirmation
<b>Scenario</b>	Buyer issues a single-line PurchaseOrder that is returned by the Supplier as Pending. The Supplier may specify the reason (optional). Later the Supplier accepts the item.
<b>Outcome</b>	Purchase Order is entered into Supplier's system
<b>Initiator</b>	Buyer
<b>Receiver</b>	Supplier
<b>Preconditions</b>	None

## OrderConfirmation papiNet Standard - Version 2.31

<b>Trigger</b>	Customer issues a PurchaseOrder to a Supplier with a single line item.
<b>Step 1.</b>	Supplier returns an OrderConfirmation with a status of Pending for the line item, specifying the reason (optional for pending).  Statuses sent within the e-Document: <ul style="list-style-type: none"> <li>• OrderConfirmationStatusType = "Accepted"</li> <li>• OrderConfirmationHeaderStatusType = "Accepted"</li> <li>• OrderConfirmationLineItemStatusType = "Pending"</li> </ul>
<b>Step 2.</b>	Supplier resolves the issue for the Pending status and sends a follow up OrderConfirmation accepting the item specifying desired information  Statuses sent within the e-Document: <ul style="list-style-type: none"> <li>• OrderConfirmationStatusType = "Accepted"</li> <li>• OrderConfirmationHeaderStatusType = "NoAction"</li> <li>• OrderConfirmationLineItemStatusType = "Accepted"</li> </ul>

### Scenario B

<b>e-Document</b>	OrderConfirmation
<b>Scenario</b>	Buyer issues an Amended PurchaseOrder that contains a change to Header information only.
<b>Outcome</b>	The Purchase Order is changed in the Supplier's system
<b>Initiator</b>	Buyer
<b>Receiver</b>	Supplier
<b>Preconditions</b>	This Use Case assumes the Buyer has previously sent a PurchaseOrder to the Supplier and the Supplier has already Accepted the order.
<b>Trigger</b>	Subsequently, the Buyer issues an Amended PurchaseOrder to a Supplier that contains a change to Header information.  Statuses sent within the e-Document: <ul style="list-style-type: none"> <li>• OrderConfirmationStatusType = "Amended"</li> <li>• OrderConfirmationHeaderStatusType = "Amended"</li> </ul>

## OrderConfirmation papiNet Standard - Version 2.31

	<ul style="list-style-type: none"> <li>OrderConfirmationLineItemStatusType = "NoAction"</li> </ul>
<b>Step 1.</b>	<p>The Supplier returns an OrderConfirmation accepting the Header change.</p> <p>Statuses sent within the e-Document:</p> <ul style="list-style-type: none"> <li>OrderConfirmationStatusType = "Accepted"</li> <li>OrderConfirmationHeaderStatusType = "Accepted"</li> <li>OrderConfirmationLineItemStatusType = "NoAction"</li> </ul>

### Scenario C

<b>e-Document</b>	OrderConfirmation
<b>Scenario</b>	Buyer issues a multi-line PurchaseOrder with all line items Accepted by the Supplier.
<b>Outcome</b>	The Purchase Order is entered into the Supplier's system.
<b>Initiator</b>	Buyer
<b>Receiver</b>	Supplier
<b>Preconditions</b>	None
<b>Trigger</b>	Buyer issues a PurchaseOrder to a Supplier with multiple line items.
<b>Step 1.</b>	<p>Supplier returns an OrderConfirmation to the Buyer accepting each line item, specifying the following information for each line item:</p> <ul style="list-style-type: none"> <li>Supplier Reference Number (optional)</li> <li>Supplier Delivery Window (optional)</li> <li>Ship From Location (optional)</li> <li>Last Date To Change (optional)</li> <li>Freight Terms (optional)</li> <li>Packaging Characteristics (optional)</li> </ul> <p>Statuses sent within the e-Document:</p> <ul style="list-style-type: none"> <li>OrderConfirmationStatusType = "Accepted"</li> <li>OrderConfirmationHeaderStatusType = "Accepted"</li> <li>OrderConfirmationLineItemStatusType(s) = "Accepted"</li> </ul>

### Scenario D

<b>e-Document</b>	OrderConfirmation
-------------------	-------------------



## OrderConfirmation papiNet Standard - Version 2.31

<b>Scenario</b>	Buyer issues a multi-line PurchaseOrder with all line items Rejected by the Supplier
<b>Outcome</b>	The Purchase Order is not entered into the Supplier's system.
<b>Initiator</b>	Buyer
<b>Receiver</b>	Supplier
<b>Preconditions</b>	None
<b>Trigger</b>	Buyer issues a PurchaseOrder to a Supplier.
<b>Step 1.</b>	<p>Supplier returns an OrderConfirmation rejecting each line item. The supplier must specify the reason(s) for the rejection in the OrderConfirmationLineItemStatusTypeText field. Line items can be rejected for multiple reasons. For example: Delivery date window, qty., core types, or sizes. Since all line item(s) were Rejected, the entire order was Rejected.</p> <p>Statuses sent within the e-Document:</p> <ul style="list-style-type: none"> <li>• OrderConfirmationStatusType = "Rejected"</li> <li>• OrderConfirmationHeaderStatusType = "Rejected"</li> <li>• OrderConfirmationLineItemStatusType(s) = "Rejected"</li> </ul>

### Scenario E

<b>e-Document</b>	OrderConfirmation
<b>Scenario</b>	Rejected line items. Buyer only pursues the accepted items.
<b>Outcome</b>	Purchase Order with two line items is created on Supplier's system.
<b>Initiator</b>	Buyer
<b>Receiver</b>	Supplier
<b>Preconditions</b>	None
<b>Trigger</b>	Buyer issues a PurchaseOrder to a Supplier with multiple line items.
<b>Step 1.</b>	Supplier returns an OrderConfirmation accepting 2 line items, specifying desired information for each accepted line item. Supplier rejects 1 line

## OrderConfirmation papiNet Standard - Version 2.31

	<p>item. Supplier must specify the reason(s) for the rejection in the OrderConfirmationLineItemStatusTypeText field. Line items can be Rejected for multiple reasons. For example: delivery date window, quantity, core types or sizes.</p> <p>Statuses sent within the e-Document:</p> <ul style="list-style-type: none"> <li>• OrderConfirmationStatusType = "Accepted"</li> <li>• OrderConfirmationHeaderStatusType = "Accepted"</li> <li>• OrderConfirmationLineItemStatusType (1) = "Accepted"</li> <li>• OrderConfirmationLineItemStatusType (2) = "Accepted"</li> <li>• OrderConfirmationLineItemStatusType (3) = "Rejected"</li> </ul>
<b>Step 2.</b>	Buyer receives the OrderConfirmation e-Document, and decides to pursue the Rejected line item in some other fashion.
<b>Step 3.</b>	Buyer deletes the Rejected item for the PurchaseOrder in their ERP system.
<b>Step 4.</b>	No other e-Document needs to be sent.

### Scenario F

<b>e-Document</b>	OrderConfirmation
<b>Scenario</b>	Buyer issues multi-line PurchaseOrder and the Supplier responds by accepting some line items and rejecting others. Buyer modifies the Rejected line items and sends an Amended PurchaseOrder.
<b>Outcome</b>	A three-line purchase order is created on the supplier's system.
<b>Initiator</b>	Buyer
<b>Receiver</b>	Supplier
<b>Trigger</b>	Buyer issues a PurchaseOrder to a Supplier with multiple line items.
<b>Step 1.</b>	Supplier accepts some line items, specifying the desired information for each accepted line item. Supplier rejects some line items. The Supplier must specify the reason(s) for the rejection in the

## OrderConfirmation papiNet Standard - Version 2.31

	<p>OrderConfirmationLineItemStatusTypeText field. Line items can be Rejected for multiple reasons. For example: delivery date window, quantity, core types or sizes.</p> <p>Statuses sent within the e-Document:</p> <ul style="list-style-type: none"> <li>• OrderConfirmationStatusType = "Accepted"</li> <li>• OrderConfirmationHeaderStatusType = "Accepted"</li> <li>• OrderConfirmationLineItemStatusType (1) = "Accepted"</li> <li>• OrderConfirmationLineItemStatusType (2) = "Accepted"</li> <li>• OrderConfirmationLineItemStatusType (3) = "Rejected"</li> </ul>
<b>Step 2.</b>	Buyer modifies the Rejected line items.
<b>Step 3.</b>	<p>Buyer sends an Amended PurchaseOrder to the Supplier.</p> <p>Statuses sent within the e-Document:</p> <ul style="list-style-type: none"> <li>• PurchaseOrderStatusType = "Amended"</li> <li>• PurchaseOrderHeaderStatusType = "NoAction"</li> <li>• PurchaseOrderLineItemStatusType (1) = "NoAction"</li> <li>• PurchaseOrderLineItemStatusType (2) = "NoAction"</li> <li>• PurchaseOrderLineItemStatusType (3) = "Amended"</li> </ul>
<b>Step 4.</b>	Supplier reviews and accepts the changes.
<b>Step 5.</b>	<p>Supplier returns an OrderConfirmation to the Buyer.</p> <p>Statuses sent within the e-Document:</p> <ul style="list-style-type: none"> <li>• OrderConfirmationStatusType = "Accepted"</li> <li>• OrderConfirmationHeaderStatusType = "NoAction"</li> <li>• OrderConfirmationLineItemStatusType (1) = "NoAction"</li> <li>• OrderConfirmationLineItemStatusType (2) = "NoAction"</li> <li>• OrderConfirmationLineItemStatusType (3) = "Amended"</li> </ul>

### Scenario G

<b>e-Document</b>	OrderConfirmation
-------------------	-------------------

## OrderConfirmation papiNet Standard - Version 2.31

<b>Scenario</b>	Buyer issues multi-line PurchaseOrder and Supplier responds by accepting some line items, rejecting some items, and pending others. Buyer modifies the Rejected line items and sends an Amended PurchaseOrder.
<b>Outcome</b>	A three-line purchase order is created in the supplier's system.
<b>Initiator</b>	Buyer
<b>Receiver</b>	Supplier
<b>Preconditions</b>	None
<b>Trigger</b>	Buyer issues a PurchaseOrder to a Supplier with multiple line items.
<b>Step 1.</b>	<p>Supplier accepts line item 1, specifying the desired information for the accepted line item. Supplier rejects line item 2. The Supplier specifies the reason for the rejection in the OrderConfirmationLineItemStatusTypeText field. Supplier puts line item 3 into Pending status. The Supplier may specify the reason for the Pending status in the OrderConfirmationLineItemStatusTypeText field.</p> <p>Statuses sent within the e-Document:</p> <ul style="list-style-type: none"> <li>• OrderConfirmationStatusType = "Accepted"</li> <li>• OrderConfirmationHeaderStatusType = "Accepted"</li> <li>• OrderConfirmationLineItemStatusType (1) = "Accepted"</li> <li>• OrderConfirmationLineItemStatusType (2) = "Rejected"</li> <li>• OrderConfirmationLineItemStatusType (3) = "Pending"</li> </ul>
<b>Step 2.</b>	Buyer receives the OrderConfirmation e-Document, and modifies the Rejected line item.
<b>Step 3.</b>	<p>Buyer sends an Amended PurchaseOrder to the Supplier.</p> <p>Statuses sent within the e-Document:</p> <ul style="list-style-type: none"> <li>• PurchaseOrderStatusType = "Amended"</li> <li>• PurchaseOrderHeaderStatusType = "NoAction"</li> </ul>

## OrderConfirmation papiNet Standard - Version 2.31

	<ul style="list-style-type: none"> <li>• PurchaseOrderLineItemType (1) = "NoAction"</li> <li>• PurchaseOrderLineItemType (2) = "Amended"</li> <li>• PurchaseOrderLineItemType (3) = "NoAction"</li> </ul>
<b>Step 4.</b>	Supplier accepts the changes.
<b>Step 5.</b>	<p>Supplier returns an OrderConfirmation to the Buyer.</p> <p>Statuses sent within the e-Document:</p> <ul style="list-style-type: none"> <li>• OrderConfirmationStatusType = "Accepted"</li> <li>• OrderConfirmationHeaderStatusType = "NoAction"</li> <li>• OrderConfirmationLineItemType (1) = "NoAction"</li> <li>• OrderConfirmationLineItemType (2) = "Pending"</li> <li>• OrderConfirmationLineItemType (3) = "Pending"</li> </ul>
<b>Step 6.</b>	Supplier has resolved the reason for the Pending line item.
<b>Step 7.</b>	<p>Supplier sends an OrderConfirmation to the Buyer accepting line item 3.</p> <p>Statuses sent within the e-Document:</p> <ul style="list-style-type: none"> <li>• OrderConfirmationStatusType = "Accepted"</li> <li>• OrderConfirmationHeaderStatusType = "NoAction"</li> <li>• OrderConfirmationLineItemType (1) = "NoAction"</li> <li>• OrderConfirmationLineItemType (2) = "Accepted"</li> <li>• OrderConfirmationLineItemType (3) = "Accepted"</li> </ul>

### Scenario H

<b>e-Document</b>	OrderConfirmation
<b>Type</b>	Indicate the e-Document type, if any.
<b>Scenario</b>	Supplier initiates a change to a PurchaseOrder that had been previously Accepted.
<b>Outcome</b>	The purchase order is changed in the supplier's

## OrderConfirmation papiNet Standard - Version 2.31

	system.
<b>Initiator</b>	Supplier
<b>Receiver</b>	Buyer
<b>Preconditions</b>	This Use Case assumes the Buyer has previously sent a PurchaseOrder to the Supplier and the Supplier has already Accepted the order. The change can be either to the header, line items or both.
<b>Trigger</b>	Supplier issues an Amended OrderConfirmation to the Buyer that suggests a change to the Header information.  Statuses sent within the e-Document: <ul style="list-style-type: none"> <li>• OrderConfirmationStatusType = "Amended"</li> <li>• OrderConfirmationHeaderStatusType = "Amended"</li> <li>• OrderConfirmationLineItemStatusType = "NoAction"</li> </ul>
<b>Step 1.</b>	The Buyer accepts the changes by sending an Amended PurchaseOrder to the Supplier with the changes suggested by the Buyer.  Statuses sent within the e-Document: <ul style="list-style-type: none"> <li>• PurchaseOrderStatusType = "Amended"</li> <li>• PurchaseOrderHeaderStatusType = "Amended"</li> <li>• PurchaseOrderLineItemStatusType = "NoAction"</li> </ul>
<b>Step 2.</b>	The Supplier returns an OrderConfirmation with a status of Accepted for the document Header level.  Statuses sent within the e-Document: <ul style="list-style-type: none"> <li>• OrderConfirmationStatusType = "Accepted"</li> <li>• OrderConfirmationHeaderStatusType = "Accepted"</li> <li>• OrderConfirmationLineItemStatusType = "NoAction"</li> </ul>