



papiNet

papiNet V2R31

Data Dictionary

**Global Standard for the Paper and Forest
Products Supply Chain**

Build V2R31_20240321

Date 2024-04-14

Production Release

Copyright

Copyright 2000 – 2024 Papinet SNC ("papiNet") the "Copyright Owner". All rights reserved by the Copyright Owner under the laws of the United States, Belgium, the European Economic Community, and all states, domestic and foreign. This document may be downloaded and copied provided that all copies retain and display the copyright and any other proprietary notices contained in this document. This document may not be sold, modified, edited, or taken out of context such that it creates a false or misleading statement or impression as to the purpose or use of the papiNet specification, which is an open standard. Use of this Standard, in accord with the foregoing limited permission, shall not create for the user any rights in or to the copyright, which rights are exclusively reserved to the Copyright Owner.

papiNet, and the members of all papiNet Groups (collectively and individually, "Presenters") make no representations or warranties, express or implied, including, but not limited to, warranties of merchantability, fitness for a particular purpose, title, or non-infringement. The presenters do not make any representation or warranty that the contents of this document are free from error, suitable for any purpose of any user, or that implementation of such contents will not infringe any third party patents, copyrights, trademarks or other rights. By making use of this document, the user assumes all risks and waives all claims against Presenters.

In no event shall Presenters be liable to user (or other person) for direct, indirect, special or consequential damages arising from or related to any use of this document, including, without limitation, lost profits, business interruption, loss of programs, or other data on your information handling system even if Presenters are expressly advised of the possibility of such damages.

Use of Documents in papiNet Implementations

Documents may be used as templates for a papiNet implementation. The Presenters grant the right to modify and edit them to fit an actual implementation project provided all copies display the copyright and any other proprietary notices contained in this document. Such modified documents must not be distributed beyond the trading partners implementing or maintaining a papiNet connection.

papiNet V2R31

Table of Contents

Copyright.....	2
Use of Documents in papiNet Implementations	2
Table of Contents	3
Data Dictionary: papiNet Version 2.31	43
a	43
Abrasion	44
AbsorptionInk	46
AbsorptionLight	48
AbsorptionWater	50
ActionType [attribute]	51
ActualNominal [attribute]	51
AdditionalItemInfo	52
AdditionalTest	53
AdditionalTestName	54
AdditionalText	54
Address1	54
Address2	55
Address3	55
Address4	55
AddressRoleType	55
AdjustmentFixedAmount	55
AdjustmentPercentage	56
AdjustmentType (Financial) [attribute]	56
AdjustmentType (Tare) [attribute]	61
AdjustmentTypeReason	63
AdjustmentValue	63
Age	64
Agency [attribute]	64
AggregatedUsageLineItem	70
Alignment	71
Altitude	71
AmbientTemperature	72
Amount	72
AmountSubjectToTermsDiscount	73
AmountType [attribute]	73
Appearance	74
AppliesTo [attribute]	75
AreaInfo	76
AreaProperty	77
ArrivalDate	77
Ash	79
AssemblyInstructions	80
AssemblyType [attribute]	80
AssignedBy [attribute]	81
AttachmentContext [attribute]	89
AttachmentFileName	89
AudioCassette	90
AudioCassetteCaseType [attribute]	92
AudioCassetteTapeLengthType [attribute]	92
Availability	93
AvailabilityDetail	94
AvailabilityHeader	96
AvailabilityIssueDate	97
AvailabilityNumber	98
AvailabilityStatusRequestDetail	98
b	100
Bale	100

papiNet V2R31

BaleCharacteristics	101
BaleConversionCharacteristics	102
BaleDepth	102
BaleHeight.....	103
BaleItem	104
BalePackagingCharacteristics	106
BaleReference	106
BaleReferenceType [attribute]	107
BalesPerUnit	107
BaleStandardWeight	107
BaleType [attribute].....	108
BaleWidth.....	108
BandCharacteristics	109
BandColour.....	109
BandDirection [attribute].....	110
BandLocationType [attribute]	110
BandMaterial	110
BandsRequired [attribute].....	110
BandType [attribute].....	111
BarcodeSuppliedByPublisher [attribute]	111
Bark	112
BaseAmountInfo.....	113
BaseNetAmount	113
BasisWeight.....	114
BasisWeightVariation	116
BendingResistance.....	117
BendingStiffness	119
BestBeforeDate	120
Billable [attribute]	120
BillOfMaterials	121
BillToParty	122
BinaryValue	122
BindingBackingType [attribute].....	122
BindingBackStyleType [attribute].....	123
BindingCoverScoring [attribute].....	123
BindingExtras.....	124
BindingExtrasDescription	124
BindingMaterialCharacteristics	125
BindingMaterialDescription	126
BindingReinforcement [attribute]	126
BindingRibbon [attribute]	126
BindingStyleType [attribute]	126
BindingType [attribute]	130
Black	131
Blanket	131
BlanketPacking.....	132
BlanketType	132
BleachingProcess [attribute].....	132
Bleed [attribute].....	132
Blue	133
BookBlock	134
BookBlockBulk	134
BookBlockEdgeTrim	135
BookBlockFinishExtras.....	135
BookClassification	136
BookClassificationType [attribute].....	136
BookManufacturing	138
BookPackageInformation	139
BookSpecIdentification	141

papiNet V2R31

BookSpecification	142
BookSubClassification	144
BookSubClassificationType [attribute]	144
BookUnitPacking.....	153
BookUnitType [attribute]	154
BooleanValue	154
BoxCharacteristics	155
BoxItem	157
BoxMeasurementsAppliesTo [attribute]	159
BoxReference.....	159
BoxReferenceType [attribute].....	160
BoxType [attribute]	160
Brand	160
BrandAndModel	161
BrandName [attribute]	161
Brightness	162
Brilliance	163
BucketStatusType [attribute]	164
BucketType [attribute]	164
Bulk	165
BulkNumberOfUnits	166
Burst	167
BurstIndex	169
BusinessAcceptance	171
BusinessAcceptanceDate	172
BusinessAcceptanceNumber	173
BusinessAcceptanceParty	173
BusinessAcceptanceStatus [attribute]	174
BusinessAcknowledgement	175
BusinessAcknowledgementDate	176
BusinessAcknowledgementNumber	177
BusinessChainContextType [attribute]	177
BusinessChainDescription	177
BusinessChainInfo	178
BusinessChainNumber.....	179
BusinessChainReferenceID.....	179
BusinessChainSequence	180
BusinessChainSequenceNumber	181
BusinessPartyProperty.....	181
BusinessPartyType.....	182
BuyerParty	188
ByInvoice	188
ByJob	189
ByLoad	190
ByLoadType [attribute]	190
ByPeriod	191
ByProduct.....	191
ByPurchaseOrder.....	192
ByQualifiedDeliveryMessage.....	193
ByQualifiedPurchaseOrderInformation	193
ByShipTo.....	194
BySupplierOrder.....	194
BySupplierOrderNumber	195
Calendar	196
CalendarEntry	197
CalendarEntryPeriod [attribute]	197
CalendarHeader	198
CalendarIssueDate	199
CalendarNumber	200

papiNet V2R31

CalendarRequestDetail	200
CalendarPeriod	201
CalendarSequence	202
CalendarSequenceNumber	203
CalendarStatus [attribute]	203
CalendarType [attribute]	203
Calibration	204
CalibrationDate	204
CalibrationDescription	205
CalibrationNumber	205
Caliper	205
CallOff	207
CallOffConfirmationIssuedDate	208
CallOffConfirmationLineItemNumber	208
CallOffConfirmationNumber	208
CallOffHeader	209
CallOffHeaderStatusType [attribute]	211
CallOffInformation	212
CallOffIssuedDate	213
CallOffLineItem	214
CallOffLineItemDocumentStatus [attribute]	216
CallOffLineItemDocumentStatus [attribute]	216
CallOffLineItemNumber	217
CallOffLineItemStatusType [attribute]	217
CallOffLineItemText	218
CallOffNumber	218
CallOffPaper	218
CallOffProduct	219
CallOffProductConversionType	220
CallOffPurchaseOrderLineItem	221
CallOffReel	221
CallOffReference	222
CallOffReferenceType [attribute]	222
CallOffSheet	223
CallOffStatusType [attribute]	223
CallOffSummary	224
CallOffType [attribute]	224
CallOffWood	225
CallOffWoodHeader	226
CallOffWoodLineItem	228
CallOffWoodProductGroup	230
CallOffWoodSummary	231
CarrierParty	232
Case	233
CaseBoardMaterials	234
CaseBoardType [attribute]	234
CaseFlushFoot [attribute]	235
CaseLining	235
CaseLiningDescription	235
CaseLocationType [attribute]	235
CaseMaking	236
CaseMaterial	236
CaseOversize	237
CaseShow	237
CaseShowType [attribute]	238
CaseSupers	238
CaseType [attribute]	238
CassetteCardReference	238
CassetteLabelCharacteristics	239

papiNet V2R31

CassetteLabelSide [attribute]	239
CassetteLabelType [attribute]	239
CD	240
CDFormatType [attribute].....	241
CDManufacturingProcess [attribute]	241
CDPackaging.....	242
CDRType [attribute].....	242
CertificationBody [attribute].....	242
ChainOfCustody	242
ChangeDetailType [attribute]	243
ChangesAllowed [attribute].....	243
Charge.....	243
ChargeAmount.....	244
ChargeContext [attribute].....	245
ChargeInformation	246
ChargeNetAmount	247
ChargeOrAllowance.....	248
ChargeOrAllowanceType [attribute].....	248
ChargePerUnit.....	253
ChargeReference	253
ChargeReferenceType [attribute]	254
ChargeType [attribute].....	254
ChildrensTitle [attribute]	256
Chip	256
ChipCharacteristics	257
ChipFraction	258
ChipFractionAnalysisDate.....	258
ChipFractionClass	259
ChipFractionDescription	259
ChipFractionInfo.....	259
ChipFractionNumber	260
ChipFractionPropertyType [attribute].....	260
ChipFractionValue.....	261
ChipPackagingCharacteristics	262
City	262
ClassCodeInfo.....	263
ClassIdentifier.....	263
Classification.....	264
ClassificationCode.....	264
ClassificationCodeType [attribute].....	265
ClassificationDescription	268
ClothCrossCut [attribute].....	268
CMYK.....	269
Coating	270
CoatingBottom [attribute].....	272
CoatingCoverageType [attribute]	273
CoatingLocation [attribute]	273
CoatingLocationType [attribute].....	273
CoatingTop [attribute].....	274
CoatWeight.....	275
CoatingWithAdditionalSpecs	276
Code	277
CodeDescription	277
CodeValue	277
Collated [attribute].....	277
CoLoading	278
CoLoadingNumber	279
CoLoadingReference	279
CoLoadingReferenceType [attribute].....	279

papiNet V2R31

CoLoadingType [attribute]	280
ColourCode.....	280
ColourDescription	280
ColourDetail.....	281
ColourLocation [attribute].....	282
ColourMatchDescription	282
ColourShade	282
ColourSpecs	283
CommodityGoodsCode	283
CommonContact.....	284
CommunicationRole [attribute].....	285
CompensationChainDescription.....	286
CompensationChainInfo.....	286
CompensationChainNumber	288
CompensationMeasuringType [attribute].....	288
Complaint.....	289
ComplaintHeader.....	290
ComplaintInformation	292
ComplaintIssueDate.....	292
ComplaintLineItem	293
ComplaintLineItemDetail	295
ComplaintLineItemDetailNumber.....	297
ComplaintLineItemNumber	297
ComplaintLineNetChargeAmount.....	297
ComplaintNumber.....	297
ComplaintReason.....	297
ComplaintReasonCode.....	298
ComplaintReasonDescription	298
ComplaintReasonType [attribute].....	298
ComplaintReference	299
ComplaintReferenceType [attribute].....	299
ComplaintResponse	300
ComplaintResponseHeader.....	302
ComplaintResponseHeaderStatusType [attribute].....	304
ComplaintResponseIssueDate.....	304
ComplaintResponseLineItem	306
ComplaintResponseLineItemDetail	309
ComplaintResponseLineItemDetailNumber	310
ComplaintResponseLineItemNumber	310
ComplaintResponseLineNetChargeAmount.....	311
ComplaintResponseLineStyleType [attribute]	311
ComplaintResponseNumber.....	311
ComplaintResponseReason	311
ComplaintResponseReasonCode.....	312
ComplaintResponseReasonDescription	312
ComplaintResponseReasonType [attribute].....	312
ComplaintResponseReference.....	313
ComplaintResponseReferenceType [attribute].....	313
ComplaintResponseSpecification	314
ComplaintResponseSummary	315
ComplaintResponseType [attribute].....	316
ComplaintSpecification	316
ComplaintSummary	317
ComplaintType [attribute].....	318
ComponentDueDate.....	318
ComponentNeededDate	319
ComponentShipDate	320
CompositeAndVeneerWoodPanels	320
CompoundAgency [attribute]	321

papiNet V2R31

CompoundType [attribute].....	321
ConcernIndicatorType [attribute]	321
ConstructionPackagesAndPreFabPanels	321
ConsumptionProcess	322
ContactAvailability	323
ContactIdentifier	324
ContactIdentifierType [attribute]	324
ContactName	324
ContactType [attribute]	325
ContentOrderOfMatter.....	327
ContentOrderOfMatterComponent	327
ContentOrderOfMatterHeader	329
ContentOrderOfMatterStatusType [attribute]	331
Contract.....	331
ContractConditions	332
ContractContextType [attribute]	333
ContractDate	333
ContractHeader.....	334
ContractLineItem.....	337
ContractLineItemNumber.....	339
ContractParagraph.....	339
ContractParagraphNumber.....	340
ContractParagraphText.....	340
ContractParty.....	340
ContractStatusType [attribute]	341
ContractSummary	342
ContractTitle	343
ContractType [attribute].....	343
ContractValidityStatus [attribute]	343
ConversionCode	344
CoordinateDisplayOrder [attribute]	344
CoordinateFormatType [attribute].....	344
Coordinates	346
CoreCharacteristics.....	346
CoreCode	347
CoreDiameterInside	347
CoreDiameterOutside.....	348
CoreEndType [attribute].....	348
CoreMaterialType [attribute]	349
CorePlugs.....	350
CoreStrengthCode	350
CorrectiveAction	350
CostComponent.....	350
CostComponentCode.....	351
CostComponentCodeValue	351
CostComponentDescription	352
Country.....	352
CountryAssociatedWithProduct	353
CountryAssociatedWithProductContextType [attribute].....	353
CountryAssociatedWithProductStatusType [attribute].....	354
CountryOfConsumption	354
CountryOfDestination.....	354
CountryOfOrigin	355
County.....	355
CreditDebitNote	355
CreditDebitNoteAmountSubtotal	356
CreditDebitNoteBaseAmountInformation	357
CreditDebitNoteDate	357
CreditDebitNoteHeader.....	358

papiNet V2R31

CreditDebitNoteLineAmount	360
CreditDebitNoteLineItem	361
CreditDebitNoteLineItemNumber	364
CreditDebitNoteNumber	364
CreditDebitNoteReason.....	364
CreditDebitNoteReasonCode.....	364
CreditDebitNoteReasonType [attribute].....	365
CreditDebitNoteReference.....	365
CreditDebitNoteReferenceType [attribute].....	366
CreditDebitNoteSummary	367
CreditDebitNoteType [attribute].....	369
CurrencyFromType [attribute]	369
CurrencyType [attribute]	369
CurrencyValue	369
CustomerMarks	370
CustomerMarksType [attribute]	370
CustomsParty	372
CustomsReferenceNumber	373
CustomsReferenceNumberType [attribute]	373
CustomsStampDate	373
CustomsStampHeaderText.....	374
CustomsStampInformation	374
CustomsStampTrailerText.....	375
CustomsTariffCode	375
CustomsTotals	375
CuttingDetails	375
CuttingTemplateCode.....	376
Cyan	377
Date	378
DateFinished.....	378
DateMade.....	379
DateSheeted.....	379
DateTimeFrom	380
DateTimeRange.....	380
DateTimeTo.....	381
DateTimeValue.....	381
DateType [attribute]	381
DateWound	386
Day	387
Days.....	387
Debarked [attribute].....	387
DeckAndPorchFlooringMaterials-NaturalWood	387
DeckAndPorchFlooringMaterials-NaturalWoodCharacteristics	388
DecorationCoverage.....	390
DecorationLocationType [attribute]	390
DecorationSpecs.....	391
DecorationType [attribute].....	392
DeductionInfo	392
DeductionReason.....	393
DeliveryDate.....	393
DeliveryDateType [attribute].....	394
DeliveryDateWindow	396
DeliveryDestination.....	398
DeliveryIndicator	399
DeliveryInfo.....	400
DeliveryInstruction	401
DeliveryInstructionDate	402
DeliveryInstructionHeader	403
DeliveryInstructionHeaderStatusType [attribute].....	404

papiNet V2R31

DeliveryInstructionNumber	405
DeliveryInstructionReference.....	405
DeliveryInstructionReferenceType [attribute].....	406
DeliveryInstructionSequence	407
DeliveryInstructionSequenceLineItem	411
DeliveryInstructionSequenceLineItemNumber	414
DeliveryInstructionSequenceNumber	414
DeliveryInstructionSequenceStatusType [attribute]	415
DeliveryInstructionStatusType [attribute]	415
DeliveryInstructionSummary	416
DeliveryInstructionType [attribute]	416
DeliveryLastDateOfChange.....	417
DeliveryLeg	418
DeliveryLegReference.....	421
DeliveryLegReferenceType [attribute].....	421
DeliveryLegSequenceNumber	422
DeliveryLegType [attribute]	422
DeliveryLineNumber.....	422
DeliveryMessage	423
DeliveryMessageBook.....	424
DeliveryMessageBookHeader.....	426
DeliveryMessageBookShipment	428
DeliveryMessageBookSummary	429
DeliveryMessageContextType [attribute].....	429
DeliveryMessageDate	430
DeliveryMessageHeader.....	431
DeliveryMessageLineItem	434
DeliveryMessageLineItemNumber	437
DeliveryMessageNumber	437
DeliveryMessageProductGroup.....	437
DeliveryMessageReason	438
DeliveryMessageReasonCode.....	438
DeliveryMessageReasonDescription	439
DeliveryMessageReelCharacteristics	439
DeliveryMessageReference.....	440
DeliveryMessageReferenceType [attribute].....	441
DeliveryMessageShipment	441
DeliveryMessageStatusType [attribute].....	442
DeliveryMessageSummary	442
DeliveryMessageType (Book) [attribute]	443
DeliveryMessageType [attribute]	444
DeliveryMessageType (Wood) [attribute]	444
DeliveryMessageWood.....	446
DeliveryMessageWoodHeader.....	448
DeliveryMessageWoodSummary	450
DeliveryModeType [attribute]	451
DeliveryOrigin	452
DeliveryPlanning	454
DeliveryPlanningHeader.....	456
DeliveryPlanningIssueDate.....	457
DeliveryPlanningNumber.....	458
DeliveryPlanningPeriodType [attribute]	458
DeliveryPlanningSequence	459
DeliveryPlanningSequenceLineItem	461
DeliveryPlanningSequenceLineItemNumber	462
DeliveryPlanningSequenceNumber	462
DeliveryPlanningStatusType [attribute].....	462
DeliveryPlanningSummary	463
DeliveryPlanningType [attribute].....	463

papiNet V2R31

DeliveryRouteCode	464
DeliverySchedule.....	464
DeliveryScheduleReference	466
DeliveryScheduleReferenceType [attribute]	466
DeliveryShipmentBookLineItem	467
DeliveryShipmentId	469
DeliveryShipmentLineItem.....	470
DeliveryShipmentLineItemNumber	473
DeliverySource.....	474
DeliverySourceCharacteristics	476
DeliverySourceDate	477
DeliverySourceItem	478
DeliverySourceItemNumber	479
DeliverySourceNumber.....	479
DeliverySourceProperty	479
DeliverySourceStatusType [attribute]	480
DeliverySourceTitle.....	480
DeliverySourceValidityStatus [attribute]	480
DeliveryStatus	481
DeliveryStatusType [attribute]	481
DeliveryTransitTime	482
DeliverySourceNumber	482
Density	483
DepartureDate	484
DetailRangeMax	485
DetailRangeMin	485
DetailValue	485
DeviationReason	485
DeviationReasonCode.....	486
DeviationReasonDescription	486
DiameterBreastHeight.....	486
DieCut [attribute]	487
DieCutDescription.....	487
DirectLoading [attribute]	487
DirectUnloading [attribute]	487
Dirt	488
DiscPrinting [attribute].....	489
DistanceFromCore	489
DistanceFromEdge.....	490
DistanceMeasuredTo [attribute].....	491
DistanceToNextStop.....	491
Document	492
DocumentContent.....	493
DocumentContentText.....	493
DocumentContentType [attribute].....	494
DocumentDate	496
DocumentExchangeType [attribute]	497
DocumentFormatType [attribute]	497
DocumentInformation	497
DocumentInstruction	498
DocumentInstructionText	498
DocumentIssueDate.....	498
DocumentName [attribute]	499
DocumentNumber	505
DocumentReference.....	506
DocumentReferenceID	506
DocumentReferenceIDLineItemNumber	507
DocumentReferenceIDType [attribute].....	507
DocumentReferenceInformation.....	507

papiNet V2R31

DocumentReferenceType [attribute]	508
DocumentRejectionReason	509
DocumentRequired	510
DocumentRequiredInfo	510
DocumentRequiredType [attribute]	511
DocumentType [attribute]	511
DocumentType [attribute]	512
DocumentVersionNumber	519
DominantWavelength	520
DoubleBunked [attribute]	521
DownGradingInfo	521
DownGradingReason	522
DownGradingReasonCode	522
DownGradingReasonDescription	522
Downtime	523
DowntimeDescription	523
DowntimeReasonCode	523
DrainageResistance	524
Drilled [attribute]	525
DuplicationRatio [attribute]	525
Duration	525
DurationTargetDate [attribute]	526
DurationType [attribute]	526
DurationValue	526
DVD	527
DVDFormatType [attribute]	528
eAttachment	528
e-Attachment	529
Edge	529
Edge	530
EdgeFinish	530
EdgeLocation [attribute]	531
EdgeLocationType [attribute]	531
EdgeMachiningProfile	531
EdgePaddable [attribute]	532
EdgeType [attribute]	532
EdgeType [attribute]	532
ElapsedPercentageOfPlanningPeriod	532
ElapsedTimeOfPlanningPeriod	533
Email	533
Embossing	533
EmbossingCode	533
EmbossingDescription	534
EndCaps	534
EndIdentifierRange	534
EndsDiscountInformation	535
EndsDiscountPercent	535
EndsDiscountRule [attribute]	536
EndsheetCopyDescription	536
EndsheetInformation	536
EndsheetLocationType [attribute]	537
EndsheetMaterials	537
EndsheetReinforcementMaterials	538
EndsheetReinforcementType [attribute]	538
EndsheetType [attribute]	538
EndsLengthMax	539
EndsPermittedPercent	539
EndUserParty	540
EndUses	540

papiNet V2R31

EquipmentPropertyValue	541
EquipmentPropertyType [attribute]	542
Error.....	543
ErrorCode.....	543
ErrorDescription	543
ErrorReference	544
ErrorReferenceType [attribute]	544
ErrorSeverity	544
EstimatedArrivalDate	545
EvenSpacing	545
EventDate	545
EventType [attribute].....	546
ExchangeRate	546
ExchangeRateType [attribute]	547
ExcitationPurity	548
ExecutionType [attribute]	549
ExLog	549
ExtraFeature.....	550
ExtraFeatureDescription	550
Face [attribute].....	550
Fax.....	550
FibreClassification.....	551
FibreLength	553
FibreSource [attribute].....	554
FinishedSize	556
FinishPrep	556
FinishPrepInput.....	557
FinishPrepInputType	557
FinishPrepOutputType [attribute]	558
FinishSpecs	558
FinishTexture	559
FinishType [attribute].....	559
FireTreatment	561
FireTreatmentType [attribute]	561
FlapLocation [attribute]	562
FlapWidth.....	562
FlatAmountAdjustment.....	563
FlatSize.....	563
Floor.....	563
FloorLocationType [attribute]	564
FloorPackage	564
FloorPanel	564
FloorTruss	564
Folded [attribute]	564
Folding.....	565
FolioNumber	566
FolioPosition [attribute]	566
Foot	567
ForestWood	568
ForestWoodCharacteristics	569
ForestWoodClass	570
ForestWoodClassCode	570
ForestWoodClassDescription.....	570
ForestWoodClassType [attribute]	571
ForestWoodItemType [attribute].....	571
ForestWoodPackagingCharacteristics	571
ForestWoodProcessingCharacteristics	572
ForestWoodType [attribute]	572
Formation	574

papiNet V2R31

ForwarderParty	575
FountainSolutionConductivity	576
FountainSolutionpH.....	576
Freeness	577
FreightPayableAt	578
Friction	579
From	580
FromProduct.....	581
FrontCouplingType [attribute]	582
GeneralLedgerAccount	583
Gimmick	583
GlobalPartyID	583
GlobalPartyIDType [attribute]	584
Gloss	586
GlueExposure.....	587
GlueExposure.....	587
GlueExposureID	588
GoodsLoadingPrinciple [attribute]	588
GoodsLoadingSequence	589
GoodsReceipt.....	590
GoodsReceiptAcceptance [attribute]	591
GoodsReceiptAcceptance [attribute]	592
GoodsReceiptArrivalDate	593
GoodsReceiptHeader	594
GoodsReceiptHeaderAcceptance [attribute]	596
GoodsReceiptIssueDate	597
GoodsReceiptLineItem.....	598
GoodsReceiptLineItemNumber.....	600
GoodsReceiptNumber.....	600
GoodsReceiptPackage	600
GoodsReceiptReference	601
GoodsReceiptReferenceType [attribute]	602
GoodsReceiptStatusType [attribute]	602
GoodsReceiptSummary	603
GoodsReceiptUnloadDate.....	603
GoodsReceivedRejectedType [attribute].....	604
GPSCoordinates	605
GPSSystem [attribute]	606
Grade	606
GradeAgency [attribute].....	606
GradeAgency	607
GradeCode	607
GradeName	608
GradeStamp	608
GradeStamped [attribute].....	608
GradeStampLocation.....	608
GradeStampMillNumber.....	609
GradeType [attribute]	609
GradingRule [attribute]	617
GrainDirection.....	617
Green	618
Gutter.....	619
Gypsum	619
Halftones	620
HardwoodLumber	620
HardwoodLumberCharacteristics.....	620
Head	621
Headband.....	622
HeatTreatment.....	622

papiNet V2R31

HeatTreatmentType [attribute]	623
Height	623
Height	624
HighlightedPlanningBucket.....	624
HolePunchInformation	625
HolePunchTemplateReference.....	625
HolePunchThroughCover [attribute]	625
HolePunchType	625
HoleReinforcement	626
HoleSpacing	626
Hours	626
HSB.....	627
Hue	628
Humidity	629
Identifier	629
IdentifierCodeType [attribute]	630
IdentifierFormatType [attribute]	634
IdentifierType [attribute]	639
Impressions.....	639
Incoterms [attribute]	640
IncotermsLocation	641
IncotermsVersion [attribute]	641
IncrementalOrderQuantity	642
IncrementalValue	642
InfoRequest.....	644
InfoRequestIssueDate	647
InfoRequestType [attribute]	647
InformationalAmount	648
InformationalPricePerUnit	649
InformationalPricePerUnitType [attribute]	650
InformationalQuantity	651
Ink.....	652
InkCharacteristics.....	653
InkCoverage	653
InkCoverageType [attribute]	654
InkDelivery.....	654
InkManufacturer.....	654
InkTack.....	654
InkTypeDescription	655
InkViscosity	655
InlayCardQuantity [attribute]	655
InsertReference.....	656
InstructionByType [attribute]	656
Insurance.....	656
InsuranceContractNo	657
InsuranceInfo	657
InsuredValue	657
Insurer	657
InventoryChange.....	658
InventoryChangeHeader	659
InventoryChangeIssuedDate	660
InventoryChangeLineItem.....	662
InventoryChangeLineItemDetail.....	664
InventoryChangeLineItemDetailNumber.....	665
InventoryChangeLineItemNumber.....	666
InventoryChangeNumber.....	666
InventoryChangeReason.....	666
InventoryChangeReasonCode	666
InventoryChangeReference	667

papiNet V2R31

InventoryChangeReferenceType [attribute]	667
InventoryChangeStatusType [attribute]	667
InventoryChangeSummary	668
InventoryChangeType [attribute]	669
InventoryClass	670
InventoryClassCode	671
InventoryClassDescription	671
InventoryClassLevel [attribute]	671
InventoryDispositionInstructions	672
InventoryDispositionInstructionsDetail	673
InventoryDispositionInstructionsHeader	675
InventoryDispositionInstructionsIssuedDate	676
InventoryDispositionInstructionsLineNumber	677
InventoryDispositionInstructionsNumber	677
InventoryDispositionInstructionsReference	677
InventoryDispositionInstructionsReferenceType [attribute]	678
InventoryDispositionInstructionsType [attribute]	678
InventoryInspectionDate	678
InventoryOwnedBy [attribute]	679
InventoryStatus	679
InventoryStatusHeader	681
InventoryStatusIssuedDate	682
InventoryStatusLineItem	683
InventoryStatusLineItemDetail	686
InventoryStatusLineItemDetailNumber	686
InventoryStatusLineItemNumber	686
InventoryStatusNumber	686
InventoryStatusReference	687
InventoryStatusReferenceType [attribute]	687
InventoryStatusReportingDetailType [attribute]	688
InventoryStatusRequestDetail	689
InventoryStatusRequestDetailType [attribute]	691
InventoryStatusSummary	692
InventoryStatusType [attribute]	692
Invoice	693
InvoiceContextType [attribute]	694
InvoiceDate	694
InvoiceDeliveryInformation	696
InvoiceHeader	699
InvoiceLineAmount	701
InvoiceLineBaseAmount	702
InvoiceLineBaseAmountInformation	702
InvoiceLineItem	703
InvoiceLineNumber	707
InvoiceNumber	707
InvoiceNumberMax	707
InvoiceNumberMin	707
InvoiceNumberRange	707
InvoicePrimaryStatus	707
InvoiceProductGroup	708
InvoiceReference	708
InvoiceReferenceType [attribute]	709
InvoiceSecondaryStatus	709
InvoiceShipment	709
InvoiceStatusCode [attribute]	710
InvoiceSummary	711
InvoiceType [attribute]	713
InvoiceWood	715
InvoiceWoodHeader	717

papiNet V2R31

InvoiceWoodLineItem.....	720
InvoiceWoodSummary	724
IsAverageValue [attribute].....	726
IsBindingHandSeparation [attribute]	726
IsBoxed [attribute]	726
IsBusinessChainSequenceApplicable [attribute].....	727
IsCarrierLoadingOperator [attribute]	727
IsCarrierUnloadingOperator [attribute]	727
IsCountryAllowed [attribute]	727
IsDeadEndRoad [attribute]	728
IsEaselBound [attribute].....	728
IsFinalInvoice [attribute]	728
IsFolioPresent [attribute].....	728
IsForestWoodReject [attribute].....	728
IsHalftones [attribute].....	729
IsLineCuts [attribute].....	729
IsLoaded [attribute].....	729
IsMeasuringInfoCancelled [attribute]	729
IsObjectMeasuringCompleted [attribute]	729
ISOCountryCode [attribute]	730
ISOCountryCodeAlpha3 [attribute].....	730
ISOCountryCodeNumeric [attribute].....	730
IsOpenDeliveryAgreement [attribute]	730
IsOptionalDeliveryOrigin [attribute].....	730
IsOptionalDestination [attribute].....	731
IsPageBlank [attribute]	731
IsPalletized [attribute].....	731
IsPartialConfirmation [attribute]	731
IsPartialConfirmationsAllowed [attribute]	732
IsPartialIndicator [attribute].....	732
IsPartialPalletsAllowed [attribute]	732
IsRFTagRequired [attribute]	732
IsRouteAsInstructed [attribute]	732
IsSlotManaged [attribute].....	733
IssueDate.....	733
IssueOrEventID.....	733
IsThirdPartyAdvice [attribute]	734
IsThirdPartyShipment [attribute]	734
IsTimeSlotAvailable [attribute]	734
IsTotal [attribute].....	734
IsTradeRegionAvailable [attribute]	734
IsVehicleTourComplete [attribute].....	735
IsVersionCancelled [attribute]	735
IsWithLoad [attribute].....	735
ItemCount.....	735
ItemDetails.....	736
ItemInfo	737
ItemInformation.....	739
ItemisedUsageLineItem	740
ItemMeasuringInfo	741
ItemReference	742
ItemReferenceType [attribute]	742
ItemsPerPallet.....	742
ItemsPerTier.....	743
ItemType [attribute]	743
ItemVersionNumber.....	744
JewelBox.....	744
JewelBoxType [attribute].....	745
JobCode.....	745

papiNet V2R31

JobDateTimeRange	746
JobDescription	746
JobID.....	746
JobInformation.....	746
Joining	747
JoiningType [attribute].....	747
L.....	748
Lab.....	749
LabelBrandName	750
LabelCharacteristics	750
LabelOrientation [attribute].....	751
LabelPosition	751
LabelStock.....	751
LabelStockCharacteristics	752
LabelStockLayer	752
LabelStockLayerNumber	753
LabelStockLayerType	753
LabelStyle	753
Language [attribute].....	753
LargeEndDiameter	754
LastDateOfChange	754
Latitude	754
LayerMaterial	755
LayerMaterialName	755
LayersPerUnit	755
LegStageType [attribute].....	755
Length	756
Length	757
Length	758
LengthCategory.....	758
LengthCutDescription	758
LengthCutType [attribute]	759
LengthFromCore.....	759
LengthSpecification.....	760
LengthType [attribute]	760
LengthTypeVersion [attribute].....	760
LicenceNumber	761
LightScattering.....	761
LineCuts.....	762
LineBaseAmount	763
LineItemNumber	763
LineItemSubTotal	763
LoadAvailable.....	764
LoadAvailableConfirmationIssuedDate	765
LoadAvailableHeader.....	766
LoadAvailableHeaderStatusType [attribute]	768
LoadAvailableInformation	769
LoadAvailableIssuedDate	770
LoadAvailableLineItem	771
LoadAvailableLineItemNumber	773
LoadAvailableLineItemStatusType [attribute].....	773
LoadAvailableNumber.....	774
LoadAvailableReference	774
LoadAvailableReferenceType [attribute]	774
LoadAvailableStatusType [attribute].....	775
LoadAvailableSummary	775
LoadAvailableType [attribute].....	776
LoadingFrom.....	776
LoadingSequence	776

papiNet V2R31

LoadingSequenceType [attribute]	777
LoadingTolerance [attribute]	777
LoadNumber	777
LoadOpeningSide [attribute]	777
LoadReleaseNumber	778
LoadTender	778
LoadTenderAmount.....	779
LoadTenderHeader.....	780
LoadTenderHeaderStatusType [attribute].....	782
LoadTenderIssueDate.....	782
LoadTenderLineItem	784
LoadTenderLineItemAmount	786
LoadTenderLineItemBaseAmountInformation.....	787
LoadTenderLineItemNumber	787
LoadTenderNumber	787
LoadTenderReference.....	787
LoadTenderReferenceType [attribute].....	788
LoadTenderResponse	788
LoadTenderResponseHeader	790
LoadTenderResponseHeaderStatusType [attribute].....	793
LoadTenderResponseIssueDate	793
LoadTenderResponseLineItem	795
LoadTenderResponseLineItemNumber	798
LoadTenderResponseNumber	798
LoadTenderResponseReference.....	798
LoadTenderResponseReferenceType [attribute].....	798
LoadTenderResponseSegment	800
LoadTenderResponseSegmentDocumentStatus [attribute].....	803
LoadTenderResponseSegmentNumber	803
LoadTenderResponseSegmentStatusType [attribute]	803
LoadTenderResponseStatusType [attribute].....	804
LoadTenderResponseSummary	805
LoadTenderResponseType [attribute]	806
LoadTenderSegment	807
LoadTenderSegmentDocumentStatus [attribute].....	809
LoadTenderSegmentNumber	809
LoadTenderSegmentStatusType [attribute]	810
LoadTenderStatusType [attribute].....	810
LoadTenderSummary	810
LoadTenderType [attribute]	811
LocationCharacteristics.....	812
LocationCode	813
LocationIdentifier	813
LocationInfo	814
LocationInformation	814
LocationParty.....	815
LocationPartyType	816
LocationProperty	818
LocationQualifier [attribute]	818
LocationType [attribute]	819
LocationType [attribute]	820
Log.....	820
LogCharacteristics	821
LogConversionRule [attribute]	822
LogisticsRole [attribute]	822
LogLengthType [attribute]	823
LogPackagingCharacteristics	823
Longitude.....	824
LumberGrade.....	824

papiNet V2R31

LumberSpecies.....	825
Luminance.....	827
Machine	828
MachineConditions.....	829
MachineDownTime.....	829
MachineID	830
MachineLocation.....	830
MachineSpeed	830
MachineStoppage [attribute].....	831
Magenta.....	831
MailAttachment.....	832
MailAttachmentType [attribute]	832
MakeTo	832
ManufacturingProcess	833
ManufacturingProcessAgency [attribute]	833
ManufacturingProcessType [attribute].....	834
ManufacturingSpecifications	836
MapAreaBorderType [attribute]	837
MapCoordinates	837
MapCoordinateType [attribute].....	838
MapPoint.....	840
MapPointComment.....	841
MapPointDisplayType [attribute].....	841
MapPointID.....	841
MapPointName	842
MapPointType [attribute]	842
MapReferenceSystem [attribute].....	844
Margins.....	846
MasterDataBusinessParty.....	846
MasterDataDetailsBusinessParty	847
MasterDataDetailsLocation	848
MasterDataDetailsProduct	849
MasterDataLocation	849
MasterDataOwner	850
MasterDataProduct	851
MasterReelWidth	852
MasterSource [attribute]	852
MasterStorageOption	853
MaterialCharacteristics	854
MaxCurrencyValue.....	856
MaximumClampingForce.....	856
MaximumGrossWeight.....	856
MaximumHeight	857
MaximumNumberOfJoins	857
MaximumOffcut.....	858
MaximumOrderQuantity	858
MeasurementModule	859
MeasurementsAre [attribute]	859
MeasurementSpecification	859
MeasurementSystem.....	860
MeasuringAgency [attribute]	860
MeasuringCode	862
MeasuringCodeInfo.....	863
MeasuringCodeType [attribute].....	864
MeasuringComplete [attribute]	864
MeasuringDate	865
MeasuringDescription	865
MeasuringEquipment.....	866
MeasuringEquipmentCode.....	867

papiNet V2R31

MeasuringEquipmentDescription	867
MeasuringInfoVersion.....	867
MeasuringInfoVersions [attribute].....	868
MeasuringInfoInvoicingType [attribute]	868
MeasuringInstruction	869
MeasuringInstructionContentType [attribute].....	870
MeasuringInstructionHeader.....	871
MeasuringInstructionSequence	873
MeasuringInstructionSequenceLineItem	875
MeasuringInstructionSequenceLineItemNumber	876
MeasuringInstructionSequenceNumber	876
MeasuringInstructionStatusType [attribute].....	876
MeasuringInstructionSummary	877
MeasuringInstructionTitle.....	877
MeasuringInstructionType [attribute]	877
MeasuringLineID	878
MeasuringLocation	878
MeasuringMethod [attribute].....	879
MeasuringMethodType [attribute]	879
MeasuringNumber	879
MeasuringParty	880
MeasuringProduct	880
MeasuringReference.....	881
MeasuringReferenceType [attribute].....	881
MeasuringSpecification	882
MeasuringTicket	884
MeasuringTicketContextType [attribute].....	885
MeasuringTicketHeader	886
MeasuringTicketIssueDate	888
MeasuringTicketNumber	889
MeasuringTicketReason	889
MeasuringTicketReasonCode	889
MeasuringTicketReasonDescription.....	890
MeasuringTicketReference	890
MeasuringTicketReferenceType [attribute].....	890
MeasuringTicketRequestDetail	891
MeasuringTicketRequestDetailType [attribute]	892
MeasuringTicketSequence.....	893
MeasuringTicketSequenceLineItem.....	898
MeasuringTicketSequenceLineItemNumber.....	901
MeasuringTicketSequenceNumber.....	901
MeasuringTicketStatusType [attribute]	901
MeasuringTicketSummary.....	901
MeasuringTicketType [attribute]	902
MeasuringType [attribute]	903
MeasuringUnitBrandAndModel	904
MeasuringUnitIdentifier	904
MeasuringUnitIdentifierType [attribute]	905
MechanicalMaterial	906
MechanicalMaterialCharacteristics	906
MechanicalMaterialDescription	907
Media	907
MediaLength	908
MediaType [attribute]	908
MerchantParty.....	909
Method [attribute]	910
MethodOfPayment	910
MillCharacteristics.....	910
MillJoinLocation	911

papiNet V2R31

MillJoinNumber.....	911
MillOrderInformation.....	912
MillOrderLineNumber.....	912
MillOrderNumber.....	912
MillParty.....	913
MillProductionInformation.....	913
Millwork.....	914
MinCurrencyValue.....	914
MinimumOrderQuantity.....	914
Minutes.....	915
MixedProductPalletIndicator [attribute].....	915
MixProductIndicator [attribute].....	915
MobilePhone.....	915
Model.....	916
ModelYear [attribute].....	916
ModulusElasticity [attribute].....	916
Moisture.....	917
MoistureContent.....	918
MoistureContentPercentage [attribute].....	919
MonetaryAdjustment.....	920
MonetaryAdjustmentAmount.....	922
MonetaryAdjustmentComponent.....	922
MonetaryAdjustmentLine.....	923
MonetaryAdjustmentReference.....	923
MonetaryAdjustmentReferenceLine.....	924
MonetaryAdjustmentReferenceType [attribute].....	924
MonetaryAdjustmentStartAmount.....	924
MonetaryAdjustmentStartQuantity.....	925
Month.....	926
Mullen.....	927
MWeight.....	928
Name1.....	929
Name2.....	929
Name3.....	929
NameAddress.....	930
NASTA [attribute].....	932
NaturalWoodSiding.....	932
NaturalWoodSidingCharacteristics.....	933
NaturalWoodSiding-Other.....	935
NaturalWoodSiding-OtherCharacteristics.....	936
NetAmount.....	938
NetChargeAmount.....	938
NoiseReduction [attribute].....	938
NonPressComponent.....	939
NonStandardPulp.....	939
Notification.....	940
NotificationDetails.....	940
NotificationNumber.....	941
NotificationProperty.....	941
NotificationPropertyParty.....	942
NotificationReasonType [attribute].....	942
NotificationText.....	942
NumberOfAttachments.....	943
NumberOfBands.....	943
NumberOfBindComponents.....	943
NumberOfColours.....	943
NumberOfComplaintLineItemDetail.....	943
NumberOfComplaintResponseLineItemDetail.....	943
NumberOfDocuments.....	943

papiNet V2R31

NumberOfDocumentsRequired.....	944
NumberOfGoodsReceiptPackages	944
NumberOfHits	944
NumberOfHoles.....	944
NumberOfInventoryChangeLineItemDetails	944
NumberOfInventoryStatusLineItemDetails.....	944
NumberOfItemMeasuringInfo	944
NumberOfLabels.....	945
NumberOfMillJoins	945
NumberOfPackageMeasuringInfo	945
NumberOfPackages.....	945
NumberOfPackingListItems	945
NumberOfPages	945
NumberOfPlies	945
NumberOfRibbons	945
NumberOfSides.....	946
NumberOfSignatures.....	946
NumberOfUncompletedMeasuredItems	946
NumberOfWraps.....	946
NumberOrderDocumentRequired	946
NumberPerProduct.....	946
NumericValue	947
OldInformationalQuantity	948
OldInventoryClass	949
OldQuantity	950
Opacity	952
OrderConfirmation	953
OrderConfirmationHeader	955
OrderConfirmationHeaderStatusType [attribute]	958
OrderConfirmationHeaderStatusTypeText.....	958
OrderConfirmationIssuedDate	959
OrderConfirmationLineItem	960
OrderConfirmationLineItemDocumentStatus [attribute].....	964
OrderConfirmationLineItemDocumentStatus [attribute].....	965
OrderConfirmationLineItemNumber.....	965
OrderConfirmationLineItemStatusType [attribute]	965
OrderConfirmationLineItemStatusTypeText	966
OrderConfirmationNumber	966
OrderConfirmationReference	966
OrderConfirmationReferenceType [attribute]	967
OrderConfirmationStatusType [attribute]	967
OrderConfirmationSummary.....	968
OrderConfirmationWood	970
OrderConfirmationWoodHeader	972
OrderConfirmationWoodLineItem	975
OrderConfirmationWoodProductGroup	979
OrderConfirmationWoodSummary	981
OrderContextType [attribute]	983
OrderDocumentRequired	983
OrderHeaderStatusType [attribute]	984
OrderLineItemDocumentStatus [attribute]	984
OrderLineItemStatusType [attribute].....	984
OrderOfMatterAdditional	985
OrderOfMatterAdditionalProcess [attribute]	986
OrderOfMatterAdditionalType [attribute]	986
OrderOfMatterAdditionalValue	986
OrderPrimaryStatus	986
OrderQuantities.....	987
OrderSecondaryStatus	987

papiNet V2R31

OrderStatus.....	987
OrderStatusCode [attribute].....	988
OrderStatusDetail.....	991
OrderStatusHeader.....	994
OrderStatusInformation.....	995
OrderStatusInformationDate.....	996
OrderStatusNumber.....	996
OrderStatusReference.....	996
OrderStatusReferenceType [attribute].....	997
OrderStatusRequestDetail.....	998
OrderStatusRequestDetailType [attribute].....	1000
OrderStatusResponseDate.....	1000
OrderStatusType [attribute].....	1001
OrderStatusType [attribute].....	1001
OrderTitle.....	1001
OrderType [attribute].....	1001
OrderType [attribute].....	1002
OrderType [attribute].....	1003
OrganisationUnit.....	1004
OrganisationUnitCode.....	1004
OrganisationUnitName.....	1004
OrganisationUnitType [attribute].....	1005
OrientationWithFaceWoodPanelGrain [attribute].....	1005
Original [attribute].....	1005
OtherDate.....	1006
OtherDocumentName [attribute].....	1007
OtherDocumentType [attribute].....	1007
OtherParty.....	1007
OtherProducts.....	1008
OtherProductsCharacteristics.....	1009
OtherProductsClass.....	1010
OtherProductsClassType [attribute].....	1010
OtherProductsItemCodeInfo.....	1011
OtherProductsItemType [attribute].....	1011
OtherProductsPackagingCharacteristics.....	1014
OtherProductsProcessingCharacteristics.....	1014
OtherProductsType [attribute].....	1014
OtherTreatment.....	1015
Overlay.....	1015
OverlaySide [attribute].....	1015
PackageAgency [attribute].....	1016
PackageCharacteristics.....	1017
PackageCode.....	1017
PackageIdentifier.....	1017
PackageIDInformation.....	1018
PackageInformation.....	1019
PackageLevel [attribute].....	1022
PackageMeasuringInfo.....	1022
PackageName.....	1023
PackageReference.....	1023
PackageReferenceType [attribute].....	1023
PackagesPerWrap.....	1024
PackageType [attribute].....	1024
PackageType.....	1025
Packaging.....	1026
PackagingCharacteristics.....	1027
PackagingCode.....	1028
PackagingCodeInfo.....	1028
PackagingCodeSpecification.....	1029

papiNet V2R31

PackagingDescription	1029
PackagingInformation	1030
PackingList	1031
PackingListDate.....	1032
PackingListHeader	1033
PackingListItem.....	1035
PackingListItemNumber.....	1036
PackingListItemType [attribute].....	1037
PackingListNumber	1037
PackingListReference	1037
PackingListReferenceType [attribute]	1038
PackingListStatusType [attribute]	1038
PackingListSummary	1038
PackingUnit	1040
PackingUnitMeasurements	1041
PackingUnitSerialNumber.....	1041
PackingUnitType [attribute]	1042
PageCountDetail.....	1042
PageSequenceNumber.....	1042
PagesPerSet	1042
PagesPerSignature.....	1043
Pagination	1043
PalletAdditionsType [attribute]	1043
PalletCharacteristics.....	1044
PalletCoverType [attribute]	1046
PalletHeight	1046
PalletLedgeType [attribute].....	1047
PalletLength.....	1047
PalletMaterialType [attribute]	1048
PalletPackagingCharacteristics.....	1048
PalletTopType [attribute]	1049
PalletType [attribute]	1050
PalletWidth	1051
Paper.....	1051
PaperCharacteristics	1052
PaperSizeType	1058
PartlyMeasuredObjectInfo	1058
PartyIdentifier.....	1059
PartyIdentifierType [attribute].....	1059
PartyType [attribute]	1064
PasteDiameter	1071
PatternProfile	1072
PatternProfileAgency [attribute].....	1072
PatternProfileCode	1073
PatternProfileType [attribute]	1073
PerCarton.....	1079
Perforated [attribute].....	1079
Perforation	1079
PerforationType [attribute]	1080
PeriodType [attribute]	1080
Permeability	1081
PerPallet	1082
PerReam	1082
PerTab.....	1082
pH.....	1083
PiecesPerRow.....	1084
PlacementInOrderOfMatter.....	1084
PlacementLocation [attribute]	1085
PlacementReference [attribute]	1085

papiNet V2R31

PlacementSequence [attribute].....	1086
Planning.....	1086
PlanningBucket.....	1087
PlanningBucketStatusType [attribute].....	1088
PlanningDuration.....	1089
PlanningHeader.....	1089
PlanningIdentifier.....	1090
PlanningInformation.....	1091
PlanningIssueDate.....	1091
PlanningLineItem.....	1092
PlanningLineItemNumber.....	1094
PlanningMessageNumber.....	1094
PlanningOutcome.....	1094
PlanningOutcomeBucket.....	1096
PlanningOutcomeContextType [attribute].....	1097
PlanningOutcomeDetailBucket.....	1097
PlanningOutcomePeriodType [attribute].....	1098
PlanningOutcomeType [attribute].....	1098
PlanningPeriodInfo.....	1099
PlanningProcessType [attribute].....	1099
PlanningPropertyType [attribute].....	1100
PlanningPropertyValue.....	1100
PlanningReference.....	1101
PlanningReferenceInformation.....	1101
PlanningReferenceType [attribute].....	1102
PlanningRequestDetail.....	1102
PlasticMaterial.....	1103
PlasticMaterialType [attribute].....	1103
PlasticPrinting [attribute].....	1104
PlasticPrintingDescription.....	1104
Plate.....	1104
PlateType.....	1104
PlyAttributes.....	1105
PlyBond.....	1110
PlyNumber.....	1111
PlySet.....	1112
PlywoodLayupStructure.....	1112
PlywoodMachining.....	1113
PlywoodOSBGrade.....	1113
PlywoodOSBSpecies.....	1114
PlywoodPlyCharacteristics.....	1114
PlywoodPlyGrade.....	1114
PlywoodPlySet.....	1115
Porosity.....	1116
PositionInSheet.....	1117
PositionMeasuredFrom [attribute].....	1117
PositionOnItem.....	1118
PostalCode.....	1118
PostConsumerWaste.....	1119
PPI.....	1120
PreConsumerWaste.....	1121
Preflight.....	1122
PreflightByPrepContentFile.....	1124
PreflightByProduct.....	1125
PreflightByPurchaseOrder.....	1126
PreflightContentType [attribute].....	1127
PreflightHeader.....	1128
PreflightInformationDate.....	1129
PreflightIssueDate.....	1129

papiNet V2R31

PreflightNumber	1130
PreflightPrimaryStatus.....	1130
PreflightPrimaryStatusCode [attribute]	1130
PreflightReference	1131
PreflightReferenceType [attribute]	1131
PreflightRequestDetail	1132
PreflightRequestDetailType [attribute].....	1133
PreflightSecondaryStatus.....	1133
PreflightSecondaryStatusCode [attribute].....	1133
PreflightStatusInformation	1134
PrepContent	1135
PrepContentDescription	1135
PrepContentName	1135
PrepContentOrderOfMatter.....	1136
PrepContentPagination	1137
PrepContentSequenceNumber	1137
PrepContentVersion	1138
PrepDueDate	1138
PrepInformation	1139
PrepNeededDate	1140
PrepReceivedDate.....	1140
PrepReference.....	1141
PrepReferenceType [attribute].....	1141
PrepShipDate.....	1142
PrepType [attribute]	1142
PressBreakLocation.....	1143
PressComponent	1144
PressConditions.....	1145
PressFormType	1146
PressImpositionType [attribute].....	1146
PressPrep	1146
PressPrepInput.....	1146
PressPrepInputType	1147
PressPrepOutputType [attribute].....	1148
PressType [attribute]	1148
PressureTreatment	1149
PressureTreatmentCompound.....	1150
PressureTreatmentComStdorUseCategory	1150
PressureTreatmentConcentration	1151
PriceAdjustment	1152
PriceAndAmountInfo	1152
PriceDetails	1153
PricePerUnit.....	1154
PriceQuantityBasis [attribute].....	1155
PriceSpecification	1157
PriceTaxBasis [attribute]	1157
PrintedMediaSpecs.....	1158
PrintingMaterials	1159
PrintParameters	1160
PrintType [attribute]	1160
PrintUnit	1162
PrintUnitNumber.....	1162
PrintUnitType [attribute].....	1162
PrioritisedMeasuringType [attribute].....	1163
PriorityOrder [attribute]	1163
ProcessingCode.....	1163
ProcessingCodeInfo	1164
ProcessingCodeSpecification.....	1164
ProcessingDescription	1165

papiNet V2R31

Product	1165
ProductAdaptedFor	1167
ProductAttributes	1167
ProductAttributesHeader	1168
ProductAttributesIssueDate	1170
ProductAttributesLineItem	1171
ProductAttributesLineItemStatusType [attribute]	1174
ProductAttributesNumber	1174
ProductAttributesProductURL	1174
ProductAttributesReference	1174
ProductAttributesReferenceType [attribute]	1175
ProductAttributesRequestDetail	1175
ProductAttributesRequestDetailType [attribute]	1176
ProductAttributesStatusType [attribute]	1176
ProductAttributesType [attribute]	1177
ProductBasisSizeType [attribute]	1177
ProductDescription	1178
ProductGroupID	1179
ProductGroupIDType [attribute]	1179
ProductGroupSummary	1179
ProductIdentification	1180
ProductIdentifier	1180
ProductIdentifierType [attribute]	1181
ProductInformationText	1184
ProductionLastDateOfChange	1184
ProductionRunNumber	1184
ProductionStatus	1185
ProductionStatusType [attribute]	1185
ProductPackaging	1186
ProductPercentage	1187
ProductPerformance	1188
ProductPerformanceConcerns	1189
ProductPerformanceConditions	1190
ProductPerformanceDate	1190
ProductPerformanceHeader	1191
ProductPerformanceIssueDate	1192
ProductPerformanceLineItem	1193
ProductPerformanceLineItemNumber	1195
ProductPerformanceNumber	1195
ProductPerformanceReference	1195
ProductPerformanceReferenceType [attribute]	1195
ProductPerformanceStatusType [attribute]	1196
ProductPerformanceSummary	1196
ProductQuality	1197
ProductQualityHeader	1198
ProductQualityIssueDate	1200
ProductQualityMessageNumber	1200
ProductQualityPeriod	1201
ProductQualityPurchaseOrder	1204
ProductQualityReference	1206
ProductQualityReferenceType [attribute]	1207
ProductQualityRequestDetail	1207
ProductQualityRequestDetailType [attribute]	1208
ProductQualityShipment	1209
ProductQualityStatusType [attribute]	1211
ProductRankingOrder [attribute]	1212
ProductReference	1212
ProductReferenceType [attribute]	1212
ProductSummary	1213

papiNet V2R31

ProductTradingRights	1213
ProofApprovalDate.....	1214
ProofColourType [attribute].....	1214
ProofDueDate	1215
ProofInformationalQuantity	1216
ProofType [attribute]	1217
PropertyAverageValue.....	1219
PropertyCode.....	1221
PropertyDescription	1221
PropertySpecification	1221
PropertySubSpecification	1223
PropertySubValue	1224
PropertyType [attribute].....	1226
PropertyValue	1240
PropertyValueOfWhichMax	1243
PropertyValueOfWhichMin	1246
Pulp.....	1248
PulpCharacteristics	1250
PulpConcernCode	1253
PulpConcernDescription	1253
PulpConcerns	1253
PulpingProcess [attribute].....	1254
PulpUnitCharacteristics.....	1255
PunchedHoleDetails	1256
PurchaseOrder	1257
PurchaseOrderDetail	1258
PurchaseOrderHeader	1260
PurchaseOrderHeaderStatusType [attribute].....	1262
PurchaseOrderInformation	1263
PurchaseOrderIssuedDate.....	1264
PurchaseOrderLineItem	1265
PurchaseOrderLineItemDocumentStatus [attribute].....	1269
PurchaseOrderLineItemNumber	1269
PurchaseOrderLineItemStatusType [attribute]	1269
PurchaseOrderNumber	1269
PurchaseOrderReference.....	1270
PurchaseOrderReferenceType [attribute].....	1270
PurchaseOrderReleaseNumber.....	1271
PurchaseOrderStatusType [attribute]	1271
PurchaseOrderSummary.....	1271
PurchaseOrderType [attribute]	1272
PurchaseOrderWood	1273
PurchaseOrderWoodHeader.....	1275
PurchaseOrderWoodLineItem	1278
PurchaseOrderWoodProductGroup.....	1283
PurchaseOrderWoodSummary	1284
Quantity.....	1286
QuantityByProperty	1287
QuantityDeviation.....	1288
QuantityInformation	1288
QuantityInUnit	1289
QuantityOrderedInformation	1290
QuantitySpecification	1291
QuantityType [attribute].....	1292
QuantityTypeContext [attribute].....	1294
QuantityValue	1297
QuoteInCurrency.....	1298
RangeMax	1298
RangeMin	1299

papiNet V2R31

RawMaterialSet	1299
ReamItem	1300
ReamType	1301
ReamWeight	1301
RearCouplingType [attribute]	1302
ReasonCode [attribute]	1302
ReasonDescription	1302
ReceiverParty.....	1303
RecoveredPaper	1304
RecoveredPaperAttributes.....	1304
Recycled	1305
RecycledCharacteristics	1306
RecycledRequired [attribute].....	1307
Red	1307
Reel	1308
ReelArm	1308
ReelBreakDiameter.....	1308
ReelConversionCharacteristics	1309
ReelDiameter.....	1310
ReelItem	1311
ReelLength	1312
ReelPackagingCharacteristics	1313
ReelsPerPack	1314
ReelStandUnit	1315
ReelWidth.....	1315
referenceType [simple type]	1315
Reissued [attribute]	1335
RelatedProduct.....	1335
RelatedProductGranularity [attribute]	1336
RelativeLocation [attribute].....	1336
RemitToParty	1336
RequestedAction	1337
RequestingParty	1337
RequestNumber	1338
Resistance.....	1339
ResourceAvailability	1340
ResourceCharacteristics.....	1341
ResourceDescription	1342
ResourceIdentifier	1342
ResourceIdentifierType [attribute]	1343
ResourceIDInfo	1344
ResourceInformation.....	1345
ResourceInformationIssueDate	1345
ResourceInformationNumber.....	1346
ResourceIntroductionDate.....	1346
ResourcePropertyValue.....	1346
ResourceReference	1347
ResourceReferenceIDInfo	1348
ResourceReferenceIDType [attribute]	1348
ResourceReferenceType [attribute]	1348
ResourceShiftCode.....	1349
ResourceShiftDescription	1349
ResourceShiftInformation	1349
ResourceTypeCode	1350
ResourceTypeDescription.....	1350
RespondByDate.....	1350
RespondToParty	1351
ResultSource [attribute]	1351
ReturnReason	1352

papiNet V2R31

ReturnReasonCode	1353
ReturnReasonDescription	1353
Return Type [attribute]	1353
RewoundIndicator [attribute]	1353
RFQ.....	1354
RFQHeader	1355
RFQHeaderStatusType [attribute]	1357
RFQInformation.....	1358
RFQIssuedDate	1358
RFQLineItem.....	1359
RFQLineItemDocumentStatus [attribute].....	1362
RFQLineItemNumber.....	1362
RFQLineItemStatusType [attribute].....	1362
RFQNumber	1362
RFQReference	1363
RFQReferenceType [attribute]	1363
RFQRespondByDate	1363
RFQResponse.....	1364
RFQResponseHeader	1366
RFQResponseHeaderStatusType [attribute]	1369
RFQResponseHeaderStatusTypeText	1369
RFQResponseIssuedDate	1369
RFQResponseLineItem.....	1371
RFQResponseLineItemDocumentStatus [attribute]	1374
RFQResponseLineItemPriceDetail	1374
RFQResponseLineItemStatusType [attribute].....	1375
RFQResponseLineItemStatusTypeText	1375
RFQResponseNumber.....	1375
RFQResponseReference	1376
RFQResponseReferenceType [attribute]	1376
RFQResponseStatusType [attribute].....	1377
RFQResponseSummary	1378
RFQResponseValidityDate	1380
RFQStatusType [attribute]	1380
RFQSummary	1381
RFQType [attribute].....	1381
RGB.....	1382
Ribbon	1383
RibbonExposure	1383
RibbonFacingType [attribute]	1383
RibbonMaterialCharacteristics	1384
RingCrush	1385
RoadAccessibilityType [attribute]	1386
RoadAvailability.....	1386
RoadBearingCapacity	1387
RoadBearingCapacityType [attribute]	1388
RoadCharacteristics	1389
RoadClassification.....	1390
RoadClassificationCode.....	1391
RoadClassificationDescription	1391
RoadKeeperType [attribute].....	1391
RoadMaintenanceCodeInfo.....	1392
RoadMaintenanceInfo.....	1392
RoadName.....	1393
RoadNumber.....	1393
RoadObstruction.....	1394
RoadObstructionType [attribute].....	1395
RoadOwnerType [attribute].....	1396
RoadPassingPossibility [attribute]	1396

papiNet V2R31

RoadSlopePercent.....	1396
RoadTurningPointType [attribute]	1396
RoadTurningPossibilityType [attribute].....	1396
Roof	1397
RoofingSidingDeckingFencing	1397
RoofPackage.....	1398
RoofPanel.....	1398
RoofTruss.....	1398
Roughness	1399
RoundCornered [attribute].....	1400
Route	1401
RouteComment	1403
RouteDefinition	1403
RouteDefinitionFormat [attribute]	1403
RouteLeg.....	1404
RouteLegLength	1405
RouteLegName.....	1406
RouteLegNumber.....	1406
RouteLength	1406
RouteLocation	1407
RouteName	1407
RouteReference.....	1407
RouteReferenceType [attribute].....	1408
RouteSeasonType [attribute].....	1408
RouteType [attribute]	1409
RowsPerUnit	1410
RunnabilityIndex	1411
SafetyAndEnvironmentalCertification	1412
SafetyAndEnvironmentalInformation	1413
SafetyAndEnvironmentalReferenceID	1414
SafetyAndEnvironmentalReferenceIDType [attribute].....	1415
SafetyAndEnvironmentalReferenceInfo	1415
SafetyAndEnvironmentalReferenceSubID	1416
SafetyAndEnvironmentalReferenceSubIDType [attribute]	1416
SafetyAndEnvironmentalType [attribute].....	1417
SalesOfficeParty	1420
SampleCharacteristics	1421
SampleReason [attribute].....	1421
SampleSelectionType [attribute].....	1422
SampleSize	1422
SampleType [attribute]	1422
Saturation	1423
Sawdust.....	1424
ScaleHouseID	1425
ScaleHouseIn.....	1425
ScaleHouseInfo	1426
ScaleHouseName.....	1427
ScaleHouseOut.....	1427
ScaleHouseTicketNumber	1428
ScalerID.....	1428
ScalerName	1428
ScaleTicket.....	1429
ScaleTicketAcceptance [attribute]	1430
ScaleTicketHeader	1431
ScaleTicketIssueDate	1433
ScaleTicketLineItem.....	1434
ScaleTicketLineNumber	1435
ScaleTicketNumber	1435
ScaleTicketReference	1435

papiNet V2R31

ScaleTicketReferenceType [attribute]	1436
ScaleTicketRejectedType [attribute]	1436
ScaleTicketStatusType [attribute]	1437
ScaleTicketSummary	1438
Scored [attribute]	1438
Screened [attribute]	1439
Seasoning	1439
SeasoningType [attribute]	1439
Secure [attribute]	1440
SenderParty	1440
SenderProductAttributesDescription	1441
SenderProductAttributesIdentifier	1441
SenderProductAttributesName	1441
SequenceNumber	1442
ServiceCharacteristics	1442
ServiceCodeInfo	1442
ServiceInstruction	1443
ServiceInstructionHeader	1445
ServiceInstructionLineItem	1447
ServiceInstructionNumber	1449
ServiceInstructionStatusType [attribute]	1449
ServiceInstructionSummary	1449
ServiceInstructionTitle	1450
ServiceInstructionType [attribute]	1450
ServiceLevel	1450
ServiceLevelContextType [attribute]	1451
ServiceLevelReference	1451
ServiceLevelReferenceType [attribute]	1451
ServiceLevelText	1452
ShapeOfHole [attribute]	1452
SetNumber	1452
SetPosition	1452
ShapeOfHole [attribute]	1452
Sheet	1453
SheetConcern	1453
SheetConcernCode	1454
SheetConcernDescription	1454
SheetConcernType [attribute]	1454
SheetConversionCharacteristics	1455
SheetCount	1457
SheetCountMethodType [attribute]	1457
SheeterConcerns	1458
SheeterConditions	1459
SheetItem	1459
SheetPackagingCharacteristics	1460
SheetSize	1461
ShellColour	1462
ShellType [attribute]	1462
ShipFromCharacteristics	1462
ShipFromParty	1463
ShipmentComplete [attribute]	1464
ShipmentDetails	1464
ShipmentDetailsType [attribute]	1465
ShipmentEventDate	1465
ShipmentEventDuration	1466
ShipmentEventIdentifier	1466
ShipmentEventInformation	1467
ShipmentEventQualifierType [attribute]	1469
ShipmentEventReference	1470

papiNet V2R31

ShipmentEventReferenceType [attribute]	1471
ShipmentEventStatusType [attribute]	1471
ShipmentEventType [attribute]	1471
ShipmentID	1472
ShipmentIDType [attribute]	1472
ShipmentIncident	1473
ShipmentIncidentAccountability	1474
ShipmentIncidentCategory	1475
ShipmentIncidentCause	1475
ShipmentIncidentCode	1476
ShipmentIncidentDate	1477
ShipmentIncidentInfo	1477
ShipmentIncidentPartOfSupplyChain	1478
ShipmentLoadDetails	1479
ShipmentMethodOfPayment	1481
ShipmentStatus	1481
ShipmentStatusDate	1482
ShipmentStatusDescription	1482
ShipmentStatusHeader	1483
ShipmentStatusIdentifier	1484
ShipmentStatusIssueDate	1484
ShipmentStatusNumber	1485
ShipmentStatusReference	1485
ShipmentStatusReferenceType [attribute]	1485
ShipmentStatusRequestDetail	1486
ShipmentStatusSearchReference	1487
ShipmentStatusSearchReferenceType [attribute]	1487
ShipmentStatusShipment	1488
ShipmentStatusType [attribute]	1489
ShipmentSummary	1490
ShippingInstructions	1491
ShippingInstructionsConfirmationIssuedDate	1492
ShippingInstructionsHeader	1493
ShippingInstructionsHeaderStatusType [attribute]	1494
ShippingInstructionsInformation	1495
ShippingInstructionsIssuedDate	1496
ShippingInstructionsLineItemByProduct	1497
ShippingInstructionsLineItemByShipTo	1499
ShippingInstructionsLineItemNumber	1500
ShippingInstructionsLineItemStatusType [attribute]	1501
ShippingInstructionsNumber	1501
ShippingInstructionsPurchaseOrderLineItem	1501
ShippingInstructionsReference	1502
ShippingInstructionsReferenceType [attribute]	1503
ShippingInstructionsRequestDetail	1503
ShippingInstructionsStatusType [attribute]	1504
ShippingInstructionsSummary	1505
ShippingInstructionsType [attribute]	1505
ShippingMark	1506
ShipToCharacteristics	1506
ShipToInformation	1507
ShipToParty	1507
ShowThrough	1509
Side	1510
SideOneTime	1511
SideTwoTime	1511
SignatureID	1511
Signatures	1511
SingleWidthReel	1512

papiNet V2R31

SingleWidthReelConversionCharacteristics.....	1512
SizeOfHolePunch	1513
Sizing	1514
Sleeve	1515
SleeveInsertType	1515
Slide.....	1516
SlideContainerDescription	1517
SlideContainerMail	1517
SlideMailerSizeDescription	1518
SlideMountCaptions [attribute]	1518
SlideMountDescription.....	1518
SlideMountMaterial	1518
SlideMountNumbering [attribute]	1518
SlidesPerPage	1518
SlitReel	1519
SlitReelLineNumber.....	1519
SlitReelOrderQuantity	1520
SlitReelReference	1521
SlitReelReferenceType [attribute]	1521
SlitReelsInSet	1521
SlitReelWidth	1522
Slurry	1522
SmallEndDiameter	1523
Smoothness.....	1524
SoftwoodLumber	1525
SoftwoodLumberCharacteristics	1526
SoftwoodPlywood	1529
SourceProduct.....	1531
SpanRating.....	1531
SpecAssembly	1532
SpecAssemblyType [attribute].....	1533
SpecBinding.....	1534
SpecComponent	1537
SpecGeneral	1539
SpecGroupingID	1541
SpeciesAgency [attribute].....	1541
SpeciesCode	1541
SpeciesOrigin [attribute]	1541
SpeciesType [attribute]	1542
SpecificationNumber	1547
SpecInformation.....	1547
SpecIssueDate	1548
SpecPacking	1549
SpecReference	1550
SpecReferenceType [attribute]	1550
SpecStatusType [attribute]	1550
SpecType [attribute].....	1551
SpecVersion.....	1551
SpeedType [attribute]	1552
SpineLabel [attribute]	1552
SpineLabel [attribute]	1552
SpineSize	1552
StackingMethod	1552
StacksPerPallet	1552
StandardDeviation	1553
StandardSpacing	1553
StartIdentifierRange	1553
Statement	1554
StatementDetail	1555

papiNet V2R31

StatementHeader	1557
StatementInformation	1558
StatementNumber	1559
StatementRequestDetail	1559
StatementRequestType [attribute]	1560
StatementResponseDate	1560
StatementType [attribute]	1561
StateOrProvince	1561
StateOrProvince [attribute]	1561
StatisticalGoodsInformation	1561
Status [attribute]	1562
StatusAsOfDate	1562
StencilCharacteristics	1563
StencilContent [attribute]	1564
StencilFormat [attribute]	1566
StencilInkType [attribute]	1566
StencilLocation [attribute]	1567
StencilText	1567
StencilType [attribute]	1567
Stiffness	1568
StopOffInformation	1569
StrengthGroup	1569
Stretch	1570
SubClassification	1571
SubClassificationCode	1572
SupersType [attribute]	1572
Supplemental	1572
SupplementalSpecification [attribute]	1573
SuppliedComponentFinishSpecs	1573
SuppliedComponentInformation	1574
SuppliedComponentReference	1576
SuppliedComponentReferenceType [attribute]	1576
SuppliedComponentType [attribute]	1576
SupplierCustomsReference	1577
SupplierCustomsReferenceType [attribute]	1577
SupplierMarks	1577
SupplierOrderLineItemNumber	1578
SupplierOrderNumber	1578
SupplierParty	1578
SupplyPoint	1579
SupplyPointCharacteristics	1580
SupplyPointCode	1580
SupplyPointDescription	1581
SupplyPointProperty	1581
SupplyPointPropertyCode	1582
SupplyPointPropertyCodeValue	1582
SupplyPointPropertyDescription	1582
SupplyPointType [attribute]	1583
SupplySubPoint	1583
SupplySubPointLevel [attribute]	1584
Surface	1584
SurfaceStrength	1585
SurfaceType [attribute]	1586
Tabs [attribute]	1587
TambourID	1587
TapeDescription	1587
TargetMoisture	1587
TargetProductWeight	1588
TargetSolidsContent	1588

papiNet V2R31

TaxAdjustment.....	1589
TaxAmount.....	1590
TaxCategoryType [attribute]	1590
TaxLocation	1590
TaxPercent	1590
TaxStatement	1591
TaxStatementCode	1591
TaxStatementDescription.....	1591
TaxType [attribute].....	1592
TEA	1593
Tear	1595
TearIndex	1597
TearStripType [attribute].....	1598
Telephone	1598
Tensile.....	1599
TensileIndex	1601
Tension	1602
TermsAndDisclaimers.....	1602
TermsBasisDate	1603
TermsBasisDateType [attribute]	1603
TermsDescription	1605
TermsDiscountDaysDue.....	1605
TermsDiscountDueDate	1605
TermsDiscountPercent.....	1606
TermsInformation	1606
TermsInterestPenaltyPercent.....	1607
TermsNetDaysDue	1607
TermsNetDueDate	1607
TermsOfChartering	1607
TermsOfCharteringType [attribute]	1608
TermsOfDelivery	1608
TermsOfPayment.....	1609
TermsOfPaymentCode.....	1610
TestAgency [attribute]	1611
TestMethod [attribute]	1613
TextValue.....	1613
Thickness	1613
Thickness	1614
Thumb	1615
TiersPerPallet.....	1615
TimberCharacteristics.....	1616
Time.....	1616
TimePeriod	1617
TimeSlot	1618
TimeSlotAvailability [attribute]	1618
TimeSlotCharacteristics	1618
TimeSlotInformation	1619
To	1619
ToProduct.....	1620
TopSide [attribute]	1621
TotalAdjustments	1621
TotalAmount.....	1622
TotalBlanketOrderValue	1622
TotalFASAmount.....	1622
TotalInformationalAmount	1623
TotalInformationalQuantity	1624
TotalNetAmount	1625
TotalNetOfTermsDiscount	1626
TotalNumberOfLineItems	1627

papiNet V2R31

TotalNumberOfPackingListItems	1627
TotalNumberOfPackingListPackingUnits	1627
TotalNumberOfSequences	1627
TotalNumberOfShipments	1627
TotalNumberOfUnits	1627
TotalOldInformationalQuantity	1628
TotalOldQuantity	1630
TotalOpenAmount	1631
TotalPageCount	1631
TotalPaymentAmount	1631
TotalQuantity	1632
TotalQuantityInformation	1633
TotalRunningLength	1634
TotalSetNumbers	1635
TotalSetPositions	1635
TotalTaxAmount	1635
TotalTermsDiscountAmount	1635
TotalTermsDiscountAmountDue	1635
TotalTermsDiscountNetAmount	1636
TotalTermsDiscountNetAmountDue	1636
TotalTermsDiscountNetAmountTax	1636
TotalTermsDiscountTaxAmount	1637
TotalTime	1637
TrackingReferenceID	1637
TrackingReferenceIDType [attribute]	1638
TrackType [attribute]	1638
TradeRegion	1638
TradingCompensationChain	1639
TradingCompensationChainValidityType [attribute]	1639
TransactionHistoryConfirmationNumber	1640
TransactionHistoryNumber	1640
TransportationComment	1640
TransportContextType [attribute]	1640
TransportDeckOption [attribute]	1641
TransportInformation	1642
TransportInstructionCode	1643
TransportInstructionText	1644
TransportInstructionType [attribute]	1644
TransportLoadingCharacteristics	1645
TransportLoadingCode	1647
TransportLoadingCodeDescription	1647
TransportLoadingText	1647
TransportLoadingType [attribute]	1648
TransportModeCharacteristics	1648
TransportModeCode	1649
TransportModeText	1649
TransportModeType [attribute]	1649
TransportOtherInstructions	1650
TransportPackageInformation	1652
TransportPropertyType [attribute]	1655
TransportPropertyValue	1656
TransportStatus	1656
TransportStatusIssueDate	1657
TransportUnitCapacity	1657
TransportUnitCharacteristics	1658
TransportUnitCode	1660
TransportUnitCount	1660
TransportUnitDetail	1661
TransportUnitDetailCode	1662

papiNet V2R31

TransportUnitDetailType [attribute]	1662
TransportUnitDirection [attribute]	1665
TransportUnitEquipment	1666
TransportUnitEquipmentCode	1667
TransportUnitEquipmentDescription	1667
TransportUnitEquipmentType [attribute]	1668
TransportUnitHeight	1668
TransportUnitHorizontalOrder [attribute]	1669
TransportUnitIdentifier	1671
TransportUnitIdentifierType [attribute]	1672
TransportUnitLength	1674
TransportUnitLevel [attribute]	1674
TransportUnitMeasurements	1675
TransportUnitReferenceIDInfo	1676
TransportUnitText	1676
TransportUnitType [attribute]	1677
TransportUnitVariable [attribute]	1678
TransportUnitWeight	1678
TransportUnitWidth	1679
TransportUnloadingCharacteristics	1679
TransportUnloadingCode	1680
TransportUnloadingCodeDescription	1681
TransportUnloadingText	1681
TransportUnloadingType [attribute]	1681
TransportVehicleCharacteristics	1682
TransportVehicleCode	1684
TransportVehicleCount	1684
TransportVehicleDetail	1684
TransportVehicleEmissionClass	1685
TransportVehicleEquipment	1685
TransportVehicleEquipmentCode	1686
TransportVehicleEquipmentDescription	1686
TransportVehicleHeight	1687
TransportVehicleIdentifier	1687
TransportVehicleIdentifierType [attribute]	1688
TransportVehicleLength	1690
TransportVehicleMeasurements	1690
TransportVehicleText	1691
TransportVehicleType [attribute]	1691
TransportVehicleWeight	1692
TransportVehicleWidth	1692
TrayColourType [attribute]	1693
TreeSpeciesGroup	1693
TreeSpeciesGroupCode	1694
TreeSpeciesGroupDescription	1694
Trim	1694
TrimmedOrderType	1694
TrimmedReel	1695
TrimmedReelConversionCharacteristics	1695
TrimSize	1696
TrimType [attribute]	1697
TwoSigmaLower	1697
TwoSigmaUpper	1697
TypePageSize	1698
UnCompletedMeasurement [attribute]	1698
UnevenSpacing	1698
UnitCharacteristics	1698
UnitDimension	1699
UnitItem	1700

papiNet V2R31

UnitReference	1701
UnitReferenceType [attribute]	1701
UnitsPerCarton	1702
UOM [attribute].....	1702
URL	1711
URLContext [attribute]	1712
Usage	1712
UsageHeader	1713
UsageHeaderReference.....	1714
UsageIssuedDate	1715
UsageLineItem	1716
UsageLineItemDetail	1717
UsageLineItemNumber	1718
UsageNumber	1718
UsageReference	1719
UsageReferenceType [attribute]	1719
UsageStatus [attribute]	1719
UsageStatusType [attribute]	1720
UsageSummary.....	1721
ValidityFlag.....	1721
ValidityPeriod.....	1722
ValidityStatus [attribute]	1722
Value.....	1722
ValueType [attribute]	1722
VarianceType [attribute].....	1723
VersionDate.....	1723
VersionNumber	1724
VersionReason	1724
VideoCassette	1725
VideoCassetteCaseType [attribute]	1726
VideoFormatType [attribute]	1726
VirginFibre.....	1727
Viscosity	1728
Wall.....	1729
WallPackage	1729
WallPanel	1729
WasteImpressions	1730
WasteQuantity	1730
WasteType [attribute]	1730
Watermark	1731
WatermarkCode	1731
WatermarkDescription.....	1731
Webbing	1732
WebBreak	1732
WebBreakCause	1733
WebBreakCauseAgency [attribute].....	1733
WebBreakCauseCode	1739
WebBreakCauseType [attribute]	1739
WebBreakDate	1740
WebBreakDescription	1740
WebBreaks	1740
WebBreakType [attribute].....	1741
WebConcerns.....	1741
WebConfiguration	1741
Week.....	1741
Weight.....	1742
Whiteness	1743
Width	1744
Width	1745

papiNet V2R31

Width	1746
WindingDirection	1746
WireCoating [attribute]	1747
WireGauge	1747
WireMaterial	1748
WithGrain [attribute]	1748
WoodBasedPanelGrade.....	1748
WoodItem	1749
WoodPanelChracteristics.....	1750
WoodPanelManufacturingMethod.....	1751
WoodPanelProducts	1752
WoodPanelSpecies.....	1753
WoodProducts	1754
WoodTimbersDimensionalLumberBoards	1755
Wrap	1756
WrapCharacteristics	1757
WrapLocation [attribute]	1757
WrapProperties [attribute]	1757
WrapType [attribute]	1758
Year	1758
YearMonth.....	1759
Yellow.....	1759

Data Dictionary: papiNet Version 2.31

a

The "a" portion of the method of colour represented by L^*a^*b .

(sequence)

The sequence of items below is mandatory. A single instance is required.

DetailValue

DetailValue is mandatory. A single instance is required.

A numeric value expressed in the unit of measure (UOM).

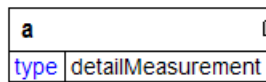

DetailRangeMin

DetailRangeMin is optional. A single instance might exist.

The minimum value (lower boundary) allowed for the DetailValue that is the parent of this element.

DetailRangeMax

DetailRangeMax is optional. A single instance might exist.

The maximum value (upper boundary) allowed for the DetailValue that is the parent of this element.

StandardDeviation

StandardDeviation is optional. A single instance might exist.

A statistic used as a measure of dispersion in a distribution.

SampleSize

SampleSize is optional. A single instance might exist.

The number of samples used to determine the product characteristic in question.

TwoSigmaLower

TwoSigmaLower is optional. A single instance might exist.

Two sigma (a measure of dispersion associated with standard deviation) on the lower side of the standard deviation.

TwoSigmaUpper

TwoSigmaUpper is optional. A single instance might exist.

Two sigma (a measure of dispersion associated with standard deviation) on the upper side of the standard deviation.

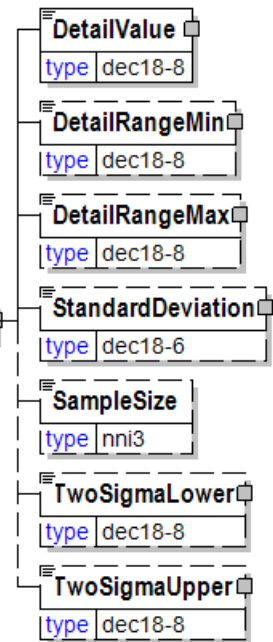

Abrasion

A group item used to communicate abrasion loss target or test value.

TestMethod [attribute]

TestMethod is optional. A single instance might exist.

The method used to determine the results of the test under consideration.

TestAgency [attribute]

TestAgency is optional. A single instance might exist.

The agency that has set the parameters for the testing

Refer to TestAgency definition for any enumerations.

SampleType [attribute]

SampleType is optional. A single instance might exist.

Communicates how sampling was done to measure the product characteristics.

Refer to SampleType definition for any enumerations.

ResultSource [attribute]

ResultSource is optional. A single instance might exist.

Used to define the data source of the specified test

Refer to ResultSource definition for any enumerations.

(sequence)

The sequence of items below is mandatory. A single instance is required.

DetailValue

DetailValue is mandatory. A single instance is required.

A numeric value expressed in the unit of measure (UOM).

DetailRangeMin

DetailRangeMin is optional. A single instance might exist.

The minimum value (lower boundary) allowed for the DetailValue that is the parent of this element.

DetailRangeMax

DetailRangeMax is optional. A single instance might exist.

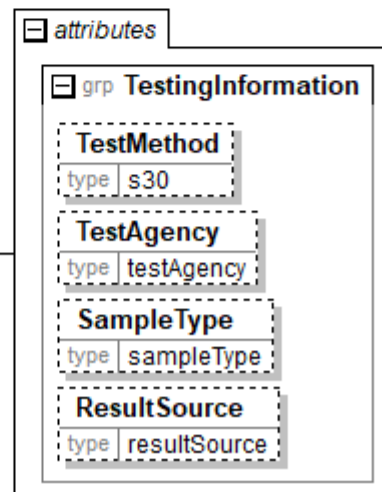
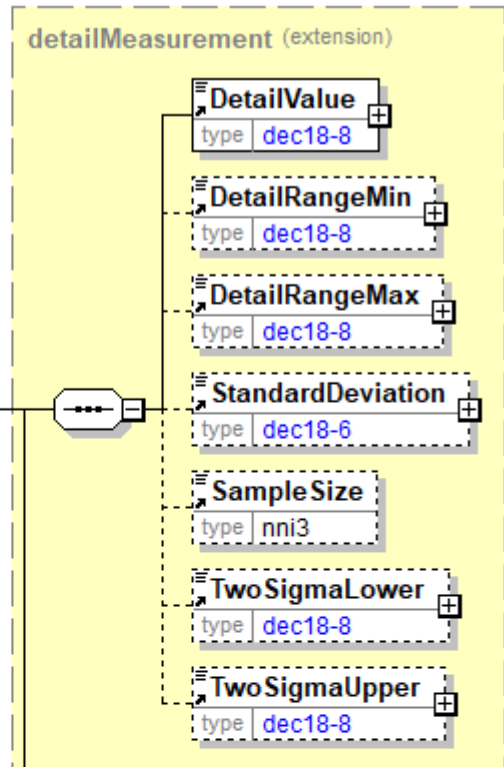

The maximum value (upper boundary) allowed for the DetailValue that is the parent of this element.

StandardDeviation

StandardDeviation is optional. A single instance might exist.

A statistic used as a measure of dispersion in a distribution.

SampleSize

SampleSize is optional. A single instance might exist.

The number of samples used to determine the product characteristic in question.

TwoSigmaLower

TwoSigmaLower is optional. A single instance might exist.

Two sigma (a measure of dispersion associated with standard deviation) on the lower side of the standard deviation.

TwoSigmaUpper

TwoSigmaUpper is optional. A single instance might exist.

Two sigma (a measure of dispersion associated with standard deviation) on the upper side of the standard deviation.

AbsorptionInk

A group item used to communicate ink absorption target or test value.

TestMethod [attribute]

TestMethod is optional. A single instance might exist.

The method used to determine the results of the test under consideration.

TestAgency [attribute]

TestAgency is optional. A single instance might exist.

The agency that has set the parameters for the testing

Refer to TestAgency definition for any enumerations.

SampleType [attribute]

SampleType is optional. A single instance might exist.

Communicates how sampling was done to measure the product characteristics.

Refer to SampleType definition for any enumerations.

ResultSource [attribute]

ResultSource is optional. A single instance might exist.

Used to define the data source of the specified test

Refer to ResultSource definition for any enumerations.

(sequence)

The sequence of items below is mandatory. A single instance is required.

DetailValue

DetailValue is mandatory. A single instance is required.

A numeric value expressed in the unit of measure (UOM).

DetailRangeMin

DetailRangeMin is optional. A single instance might exist.

The minimum value (lower boundary) allowed for the DetailValue that is the parent of this element.

DetailRangeMax

DetailRangeMax is optional. A single instance might exist.

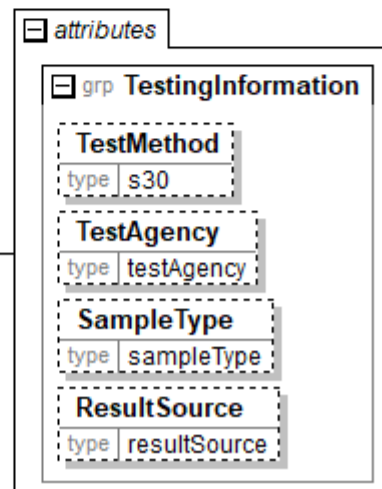
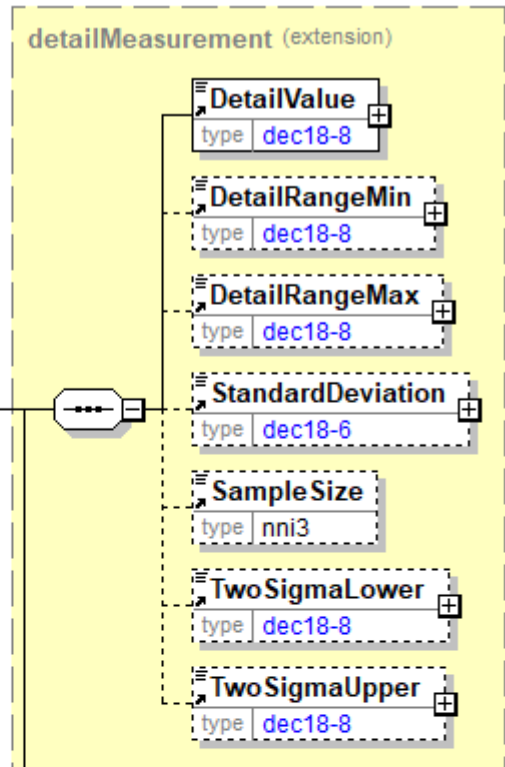

The maximum value (upper boundary) allowed for the DetailValue that is the parent of this element.

StandardDeviation

StandardDeviation is optional. A single instance might exist.

A statistic used as a measure of dispersion in a distribution.

SampleSize

SampleSize is optional. A single instance might exist.

The number of samples used to determine the product characteristic in question.

TwoSigmaLower

TwoSigmaLower is optional. A single instance might exist.

Two sigma (a measure of dispersion associated with standard deviation) on the lower side of the standard deviation.

TwoSigmaUpper

TwoSigmaUpper is optional. A single instance might exist.

Two sigma (a measure of dispersion associated with standard deviation) on the upper side of the standard deviation.

AbsorptionLight

A group item used to communicate light absorption target or test value.

TestMethod [attribute]

TestMethod is optional. A single instance might exist.

The method used to determine the results of the test under consideration.

TestAgency [attribute]

TestAgency is optional. A single instance might exist.

The agency that has set the parameters for the testing

Refer to TestAgency definition for any enumerations.

SampleType [attribute]

SampleType is optional. A single instance might exist.

Communicates how sampling was done to measure the product characteristics.

Refer to SampleType definition for any enumerations.

ResultSource [attribute]

ResultSource is optional. A single instance might exist.

Used to define the data source of the specified test

Refer to ResultSource definition for any enumerations.

(sequence)

The sequence of items below is mandatory. A single instance is required.

DetailValue

DetailValue is mandatory. A single instance is required.

A numeric value expressed in the unit of measure (UOM).

DetailRangeMin

DetailRangeMin is optional. A single instance might exist.

The minimum value (lower boundary) allowed for the DetailValue that is the parent of this element.

DetailRangeMax

DetailRangeMax is optional. A single instance might exist.

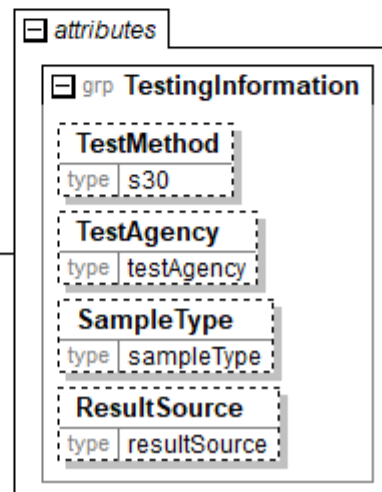
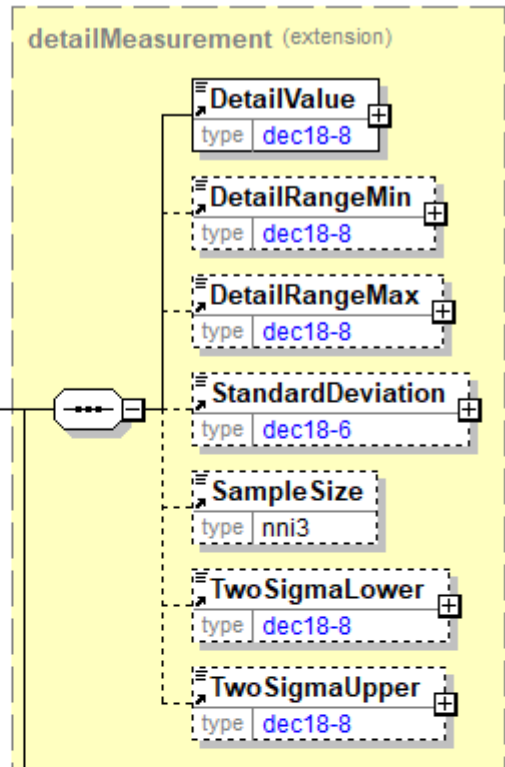
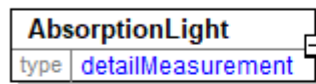

The maximum value (upper boundary) allowed for the DetailValue that is the parent of this element.

StandardDeviation

StandardDeviation is optional. A single instance might exist.

A statistic used as a measure of dispersion in a distribution.

SampleSize

SampleSize is optional. A single instance might exist.

The number of samples used to determine the product characteristic in question.

TwoSigmaLower

TwoSigmaLower is optional. A single instance might exist.

Two sigma (a measure of dispersion associated with standard deviation) on the lower side of the standard deviation.

TwoSigmaUpper

TwoSigmaUpper is optional. A single instance might exist.

Two sigma (a measure of dispersion associated with standard deviation) on the upper side of the standard deviation.

AbsorptionWater

A group item used to communicate water absorption target or test value.

TestMethod [attribute]

TestMethod is optional. A single instance might exist.

The method used to determine the results of the test under consideration.

TestAgency [attribute]

TestAgency is optional. A single instance might exist.

The agency that has set the parameters for the testing

Refer to TestAgency definition for any enumerations.

SampleType [attribute]

SampleType is optional. A single instance might exist.

Communicates how sampling was done to measure the product characteristics.

Refer to SampleType definition for any enumerations.

ResultSource [attribute]

ResultSource is optional. A single instance might exist.

Used to define the data source of the specified test

Refer to ResultSource definition for any enumerations.

(sequence)

The sequence of items below is mandatory. A single instance is required.

DetailValue

DetailValue is mandatory. A single instance is required.

A numeric value expressed in the unit of measure (UOM).

DetailRangeMin

DetailRangeMin is optional. A single instance might exist.

The minimum value (lower boundary) allowed for the DetailValue that is the parent of this element.

DetailRangeMax

DetailRangeMax is optional. A single instance might exist.

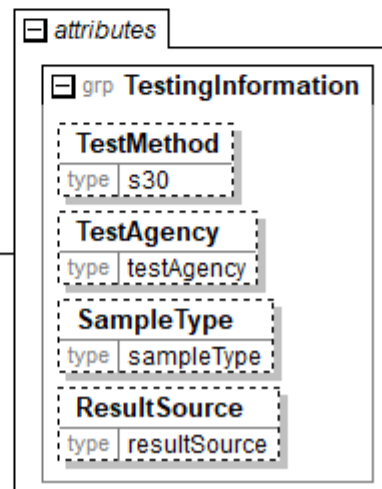
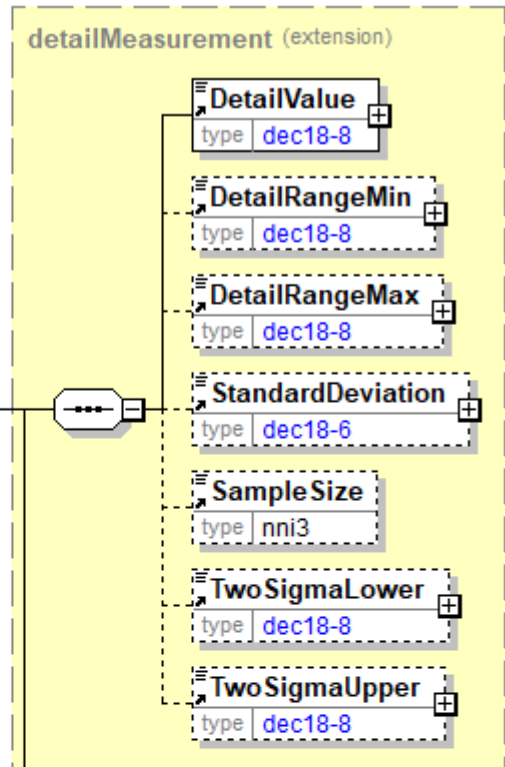
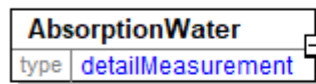

papiNet V2R31

The maximum value (upper boundary) allowed for the DetailValue that is the parent of this element.

StandardDeviation

StandardDeviation is optional. A single instance might exist.

A statistic used as a measure of dispersion in a distribution.

SampleSize

SampleSize is optional. A single instance might exist.

The number of samples used to determine the product characteristic in question.

TwoSigmaLower

TwoSigmaLower is optional. A single instance might exist.

Two sigma (a measure of dispersion associated with standard deviation) on the lower side of the standard deviation.

TwoSigmaUpper

TwoSigmaUpper is optional. A single instance might exist.

Two sigma (a measure of dispersion associated with standard deviation) on the upper side of the standard deviation.

ActionType [attribute]

Used to trigger an action concerning the element to which it refers.

This item is restricted to the following list.

Special

Specifies that an action is required.

Standard

Specifies that no action is required.

attribute	
ActionType	
type	actionType
default	Standard

ActualNominal [attribute]

Indicates the measurement approach used to communicate the dimensions of the individual pieces.

This item is restricted to the following list.

Actual

The measurement approach is based on the actual dimensions of the piece.

Covering

The measurement approach is based on an overlay of the piece.

Modal

The measurement approach is based on statistical data.

Nominal

A stated value rather than the actual value.

attribute	
ActualNominal	
type	actualNominalType

AdditionalItemInfo

A grouping element that contains information about additional items specified by an agency. Restricted use of this element is recommended.

Agency [attribute]

Agency is mandatory. A single instance is required.

Describes the agency maintaining the list of codes. To be included in this list the agency must be a recognized standards body or industry organisation.

- For the element that owns this attribute.
- For another attribute in the list of attributes associated with the parent element.

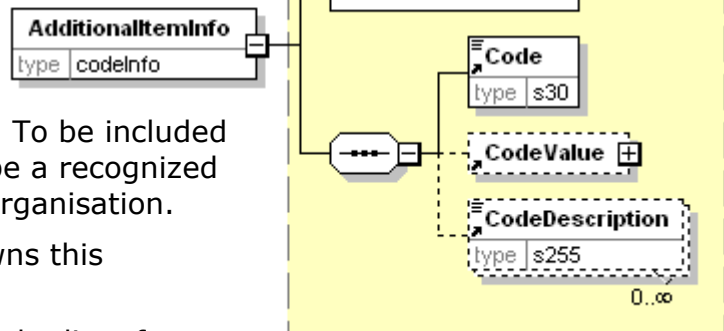

Refer to Agency definition for any enumerations.

(sequence)

The sequence of items below is mandatory. A single instance is required.

Code

Code is mandatory. A single instance is required.

Specifies a code that is defined by an agency. The agency is given for the whole construct containing the code.

CodeValue

CodeValue is optional. A single instance might exist.

A grouping element specifying a value belonging to a code that is defined by an agency.

CodeDescription

CodeDescription is optional. Multiple instances might exist.

A textual description for the meaning of a code that is defined by an agency. When the Code is associated with a CodeValue of type TextValue, then the CodeDescription is a textual description of both the Code and the TextValue.

AdditionalTest

AdditionalTest exists to enable the inclusion of a test that has not been identified by papiNet.org. It is always a single-instance element so it is very important that users, who come upon a test that papiNet.org has not identified, communicate the need for this test to us at www.papiNet.org.

TestMethod [attribute]

TestMethod is optional. A single instance might exist.

The method used to determine the results of the test under consideration.

TestAgency [attribute]

TestAgency is optional. A single instance might exist.

The agency that has set the parameters for the testing

Refer to TestAgency definition for any enumerations.

SampleType [attribute]

SampleType is optional. A single instance might exist.

Communicates how sampling was done to measure the product characteristics.

Refer to SampleType definition for any enumerations.

ResultSource [attribute]

ResultSource is optional. A single instance might exist.

Used to define the data source of the specified test

Refer to ResultSource definition for any enumerations.

(sequence)

The sequence of items below is mandatory. A single instance is required.

AdditionalTestName

AdditionalTestName is mandatory. A single instance is required.

The name of the additional test being communicated in the product definition.

DetailValue

DetailValue is mandatory. A single instance is required.

A numeric value expressed in the unit of measure (UOM).

DetailRangeMin

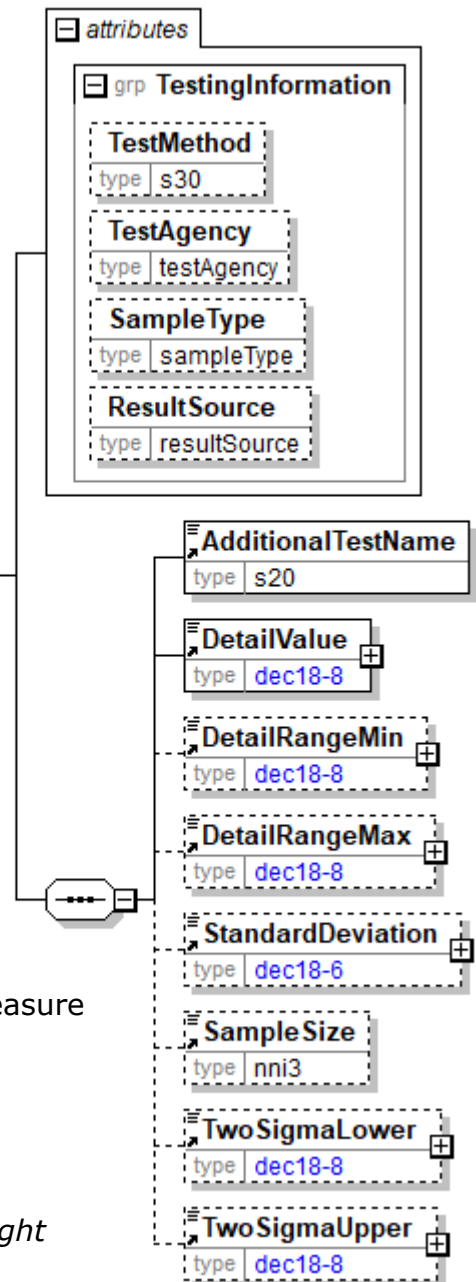

papiNet V2R31

DetailRangeMin is optional. A single instance might exist.

The minimum value (lower boundary) allowed for the DetailValue that is the parent of this element.

DetailRangeMax

DetailRangeMax is optional. A single instance might exist.

The maximum value (upper boundary) allowed for the DetailValue that is the parent of this element.

StandardDeviation

StandardDeviation is optional. A single instance might exist.

A statistic used as a measure of dispersion in a distribution.

SampleSize

SampleSize is optional. A single instance might exist.

The number of samples used to determine the product characteristic in question.

TwoSigmaLower

TwoSigmaLower is optional. A single instance might exist.

Two sigma (a measure of dispersion associated with standard deviation) on the lower side of the standard deviation.

TwoSigmaUpper

TwoSigmaUpper is optional. A single instance might exist.

Two sigma (a measure of dispersion associated with standard deviation) on the upper side of the standard deviation.

AdditionalTestName

The name of the additional test being communicated in the product definition.

AdditionalTestName	
type	s20

AdditionalText

A text field that is used to communicate information not previously defined or for special instructions. To be used only for circumstances not covered by specific elements.

AdditionalText	
type	s255

Address1

The primary-level address of an organisation or business entity (for example, street name, and number).

Address1	
type	s60

Address2

The second-level address of an organisation or business entity.

Address2	
type	s60

Address3

The third-level address of an organisation or business entity.

Address3	
type	s60

Address4

The fourth-level address of an organisation or business entity.

Address4	
type	s60

AddressRoleType

Specifies the role of an address.

This item is restricted to the following list.

Commercial

Address serves as a business location.

PostOfficeBox

Address is a post office box.

Residential

Address serves as a residence.

attributes
AddressRoleType
type addressRoleType

AdjustmentFixedAmount

A fixed monetary amount, either negative or positive, that is the value of the adjustment being applied in an instance of the MonetaryAdjustment structure.

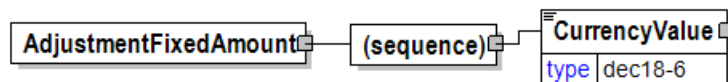

(sequence)

The sequence of items below is mandatory. A single instance is required.

CurrencyValue

CurrencyValue is mandatory. A single instance is required.

The amount in the referenced currency as defined by the CurrencyType attribute.

AdjustmentPercentage

A percentage, either negative or positive, that is applied to either the price, or a starting amount to determine the value of the particular MonetaryAdjustment.

(sequence)

The sequence of items below is mandatory. A single instance is required.

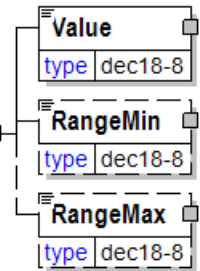
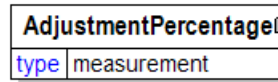

Value

Value is mandatory. A single instance is required.

A numeric value expressed in the unit of measure (UOM).

RangeMin

RangeMin is optional. A single instance might exist.

The minimum value (lower boundary) allowed for the Measurement that is the parent of this element.

RangeMax

RangeMax is optional. A single instance might exist.

The maximum value (upper boundary) allowed for the Measurement that is the parent of this element. Some elements use the RangeMax element with an extended list of unit of measures. (Note: the red colour in the picture is an artifact of how the graphic was captured and should be disregarded.)

AdjustmentType (Financial) [attribute]

Describes the type of adjustment applied to a monetary oriented element. Adjustment values should always be given as negative or positive adjustments even if AdjustmentType indicates the sign. For example, a rebate of 1% on an Invoice should be given as an adjustment percentage of -1%.

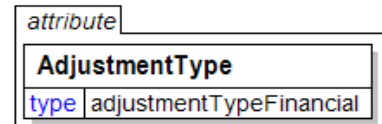

This item is restricted to the following list.

BillOfLadingCharge

An extra charge for creating a Bill of Lading.

CancellationCharge

A charge applied because a cancellation was late (after the last date of change) and all or part of the ordered product has already been made.

CashDiscount

A reduction due to a discount applied.

CertificateCharge

An extra charge for creating a certificate. Some countries requires Certificates in which different characteristics of the delivery, transport unit, route, product, and others must be proved.

There are certificates for gasen pallets, for the place of production, for the age

of the ship/vessel, for not departing from one country's harbour when delivering to another.

ChargesForward

A pending Invoice amount brought forward from a previous Invoice.

ClaimAdjustment

An adjustment related to a filed complaint.

Commission

Commission costs paid to the trading agency or trader.

CompetitiveAllowance

An allowance provided for competitive reasons.

CongestionCharge

An extra fee from ports for waiting time of ships in ports, railcars on a siding, trucks at a dock. (Synonym: Demurrage.)

ConsigneeUnloadCharge

An unloading charge that is the responsibility of the consignee.

ContractAllowance

An allowance for a volume discount, usually because the agreed amount has been exceeded.

CurrencyAdjustmentCharge

An extra fee to adjust for currency variations.

DecimalRounding

Adjustments for rounding of amounts to fit the business agreement or national monetary legislation. This adjustment is typically used for decimal rounding of amounts not including tax.

N.B. Use InformationalAmount with AmountType "DecimalRounding" for specification of decimal rounding of amounts including tax.

DefectiveAllowance

An allowance provided for defective material.

DeliveryCharge

The charge for delivering the product.

DeliveryNonConformanceAllowance

An allowance due to non-conformance with the purchase agreement regarding a delivery.

DeliveryTimeBonus

A bonus given for deliveries of products within a certain time period.

EarlyShipAllowance

An allowance due to a delivery that took place earlier than planned. The seller may be charged a penalty. If this is found before issuing the Invoice, it can be handled through this allowance. If found later, it will be handled through a credit note.

EnergySurcharge

A charge related to increases in the cost of energy.

Environmental

An allowance applied due to environmental regulations.

ExpeditedShipmentCharge

An extra cost charged due to unexpected or emergency requirements (for example, breaking off a run in the mill to reach the production date for a rush order).

ExportClearanceCharge

An extra fee for customs administration.

FlatRateCharge

A general flat charge.

FreightAllowance

The freight cost allowed by the mill. This amount is negative, and will be deducted from the Invoice (U.S. business practice, in the European Union (EU), use only Freight Charge).

FreightCharge

The actual cost incurred to deliver the product. This amount is positive, and will be added to the Invoice.

FuelAdjustmentCharge

An extra fee, usually from shipping companies, to adjust fuel prices.

HandlingCharge

A charge related to the handling of the product.

Inspection

The cost associated with performing an inspection of the product.

InterestCharge

A charge applied for interest on overdue payments.

LabourAllowance

An allowance due to additional labour required in the use or acceptance of the product.

LabourCharge

A charge due to additional labour required in the use or acceptance of the product.

LoggingDamage

An adjustment caused by logging damages on Forest Wood products. Logging damages normally cause a reduction of the product price.

LotCharge

A charge applied to the lot of material.

MetalDetection

papiNet V2R31

A charge for additional metal detection applied to the goods.

ModelHomeDiscount

A discount associated with the building of the model home.

NewStoreCouponDiscount

A discount associated with entry into a new store.

OrderQuantity

A charge or allowance for small/big ordered quantities.

PalletCharge

A charge that represents the cost or rental of the pallet.

PickUpAllowance

An allowance provided to compensate for the cost of picking up the product.

PromotionalAllowance

An allowance provided for the promotion of the product.

PromotionalCharge

A charge associated with the promotion of the product.

PriceCorrection

An adjustment associated with a correction of the product's price.

ProductionSetUpCharge

A special charge applied due to specific buyer requests.

Provision

The act of making ready or equipping for use.

Rebate

A rebate accepted by the buyer and seller based on the agreed price and volume.

ReelDiscount

An allowance for purchasing reels instead of sheets.

ReturnedLoadAllowance

An allowance applied due to the return of the load.

ReturnLoadCharge

A charge applied due to the return of the load.

RoadFeeCharge

A freight charge for a special tax applied to road transports in some countries, e.g. Germany

ScrapAndDunnageCharge

A charge that represents the scrapping of the material and its removal.

ServiceCharge

A charge associated with a miscellaneous service.

SpecialConversionCharge

Additional charge for a special conversion of the product.

SpecialDeliveryCharge

A special charge for delivering the product differently from the usual or agreed-to method.

SpecialHandlingCharge

A special charge for handling the product differently from the usual or agreed-to method.

SpecialPackagingCharge

A special charge for packaging the product differently from the usual or agreed-to method, or if packaging as requested is out of spec.

StopOffAllowance

An allowance for a delivery stop-off.

StopOffCharge

A charge for a delivery stop-off.

StorageAllowance

An allowance for storing the product.

StorageCharge

An extra cost charged for storing the product on location (in the plant).

Tax

An adjustment that reflects a tax item.

TestingCharge

A charge related to testing a paper grade.

TradeDiscount

A discount based on the terms of the trade given on the agreed price. Usually a percentage.

TrialDiscount

A discount applied for a trial run of a new or improved product.

TransferCharge

A freight charge incurred by the goods transfer from one location to another location not previously agreed upon.

UnloadingAllowance

An allowance to compensate for the unloading the product.

UnloadingCharge

A charge for the unloading the product.

VolumeDiscount

A rebate accepted by the buyer and the seller based on the agreed volume

WarRiskCharge

An extra fee from transport companies for transport units that cross war zones.

Other

Any other adjustment not covered by the attribute list.

AdjustmentType (Tare) [attribute]

Describes the type of adjustment associated with a quantity.

This item is restricted to the following list.

attribute
AdjustmentType
type adjustmentTypeTare

Advances

Product samples that are typically used by the Publisher sales people as product samples in the selling cycle.

Core

The adjustment is describing the core.

Deduction

The adjustment is describing a quantity that is deducted from the product quantity, for example because of defects, bad quality such as forest rot, etc.

Quality Rejects of whole items, for example logs, must not be included in AdjustmentType Deduction

Ends

The volume of short pieces for calculation of the "ends discount". In the timber business traditionally 'ends' refers to a time when ships were stowed tightly. Short timber pieces were used in this job and customers were given a discount because of the possible damage to these pieces. Today short lengths are in some cases sold for lower price because folks can't use these efficiently (short lengths are between 1.8 - 2.4 m).

Excess

The adjustment is describing a quantity that is the difference between the actual quantity and the contractual quantity. An Excess quantity can e.g. occur when actual dimensions are greater than contractual dimensions.

IncludesOverage

Quantity contains an amount over the order quantity for purposes of spoilage and contractual overproduction.

Example: PO to Printer/Binder has an order quantity of 10,000 and there is a supplied component for the cover under one of the line-items with a quantity of 10,800. Including the AdjustmentType attribute with a setting of IncludesOverage explains the difference in the order quantity for the book vs. the supplied component quantity.

IncludesPlannedOverProduction

The adjustment is describing a quantity that is a planned overrun production of the component or product.

MeasuringCorrection

The adjustment is describing a correction that is based on measuring statistics for populations of products.

NetAndDeductions

Specifies a quantity for a product or an item that is the net quantity plus all deductions.

NetAndExcess

Specifies a quantity for a product or an item that is the net quantity plus the excess quantity.

None

Used to indicate that there is no adjustment. (Typically used in the scenario where trading partners always want to communicate an adjustment type attribute.)

Pallet

The adjustment is describing the pallet.

PredeterminedCompensationQuantity

A special quantity that is predetermined for compensation.

For example, for some forest products a predetermined fixed log length is specified that shall be used when calculating the quantity for monetary remuneration, e.g. the solid wood volume of a log pile will be calculated as basis for compensation.

QualityRejectsAndDeductions

The adjustment is describing a quantity consisting of rejects and other deductions from the product quantity.

Reduction

The adjustment is describing a quantity that is reduced from the actual quantity of an item because of inappropriate content not belonging to the product(s) in the item, e.g. a log pile containing stones, mud, snow, ice or logging residues.

Please see AdjustmentType Deduction for deductions from product quantity.

Samples

Product samples that are sent to the buyer as an example of the production.

SchoolAdoption

The adjustment is describing text books that will be used by the school districts in that state.

Straps

The adjustment is describing the straps.

Total

The adjustment is describing the total adjustments.

Wrap

The weight adjustment value is the weight of the wrapper for a reel, the weight of a box for a box of reams, or the weight of any wrapping applied to a

pallet.

WrapCore

The adjustment is describing the wrapping plus the core

AdjustmentTypeReason

Provides additional information about the type of adjustment. Can be viewed as a sub-classification of the adjustment type attribute or as a textual explanation.

AdjustmentTypeReason
type s255

AdjustmentValue

A group element that contains a currency value, either positive or negative, and a measurement value (in other words a price per unit structure) that will be used in the price adjustment AdjustmentValue.

(sequence)

The sequence of items below is mandatory. A single instance is required.

AdjustmentValue
type pricePerUnit

(sequence)

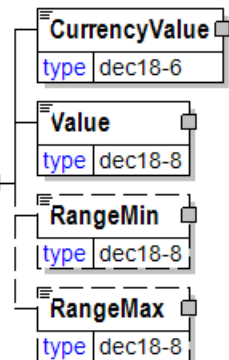

CurrencyValue

CurrencyValue is mandatory. A single instance is required.

The amount in the referenced currency as defined by the CurrencyType attribute.

Value

Value is mandatory. A single instance is required.

A numeric value expressed in the unit of measure (UOM).

RangeMin

RangeMin is optional. A single instance might exist.

The minimum value (lower boundary) allowed for the Measurement that is the parent of this element.

RangeMax

RangeMax is optional. A single instance might exist.

The maximum value (upper boundary) allowed for the Measurement that is the parent of this element. Some elements use the RangeMax element with an extended list of unit of measures. (Note: the red colour in the picture is an artifact of how the graphic was captured and should be disregarded.)

Age

Used to report the age of the wood.

(sequence)

The sequence of items below is mandatory. A single instance is required.

Value

Value is mandatory. A single instance is required.

A numeric value expressed in the unit of measure (UOM).

RangeMin

RangeMin is optional. A single instance might exist.

The minimum value (lower boundary) allowed for the Measurement that is the parent of this element.

RangeMax

RangeMax is optional. A single instance might exist.

The maximum value (upper boundary) allowed for the Measurement that is the parent of this element. Some elements use the RangeMax element with an extended list of unit of measures. (Note: the red colour in the picture is an artifact of how the graphic was captured and should be disregarded.)

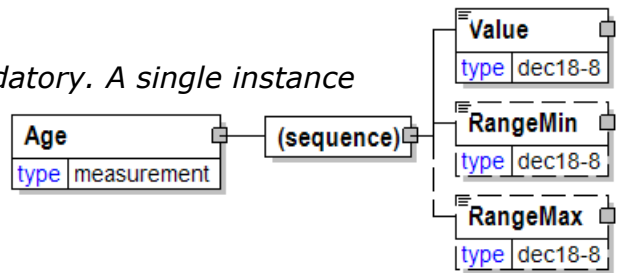

Agency [attribute]

Describes the agency maintaining the list of codes. To be included in this list the agency must be a recognized standards body or industry organisation.

- For the element that owns this attribute.
- For another attribute in the list of attributes associated with the parent element.

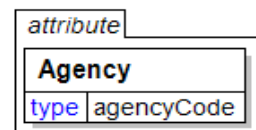

This item is restricted to the following list.

AFPA

American Forest and Paper Association.

AFNOR

AFNOR is an association specialized in standardization and certification in France. <http://www.afnor.org/en>

AmericanChemicalSociety

The American Chemical Society is a scientific society based in the United States that supports scientific inquiry in the field of chemistry. (www.acs.org)

ANSI

American National Standards Institute.

APPITA

Technical Association of the Australian and NZ Pulp and Paper Industry.

ASTM

ASTM International, known until 2001 as the American Society for Testing and Materials (ASTM), is an international standards organization that develops and publishes voluntary consensus technical standards for a wide range of materials, products, systems, and services. For example Winter Class diesel has to fulfil ASTM standards. (<http://www.astm.org>)

ASTM (misspelt with an ending space)

The item is misspelt ending with a space. It will be deprecated in a future version V3R00. Use instead the correctly spelt enumeration ASTM.

ATA

ATA (American Truckers Association)

BISAC

Book Industry Study Group

Bowker

The agency that issues the StandardAddressNumber (www.bowker.com).

BSI

British Standards Institute (refer to bsi-global.com for more information).

Buyer

The buyer has defined the codes used in the particular element of the transaction. Care must be used when using this agency to assure that the recipient of the e-Document understands what is being communicated. (Not to be used for logistics buyer, see LogisticsBuyer.)

Carrier

The carrier has defined the codes used in the particular element of the transaction. Care must be used when using this agency to assure that the recipient of the e-Document understands what is being communicated.

CCTI

Composite Can and Tube Institute

CEN

European Committee for Standardisation (<http://www.cen.eu>)

CEPI

Confederation of European Paper Industries.

ContractParty

The organisation or business entity responsible for managing the contract between business partners.

CoSe

Agency for the the wood processing industry. (www.commonsense.at)

Customs

Any customs agency.

DUNS

Dun & Bradstreet.

EAN

To be deprecated in a future version V3R00. In 2005 the EAN organisation changed its name to GS1. Use GS1 instead. <http://www.gs1.org/>

ECTA-EPCA-CEFIC

European Chemical Transport Association, European Petrochemical Association, European Chemical Council. Information about the joint guidelines developed by these agencies can be found at www.ecta.be.

eMOBOIS

French Forest Wood Supply User Group managed by FCBA.

<http://www.fcba.fr/catalogue/1ere-transformation-aprovisionnement/actions-collectives/emobois-un-projet-qui-relie-les-entreprises-de-la-mobilisation-et-de-lapprovisionnement-des>

EndUser

The end-user has defined the codes used in the particular element of the transaction. Care must be used when using this agency to assure that the recipient of the e-Document understands what is being communicated.

EU

European Union

FINFO

Article numbering agency and system in some Nordic countries for all building products. (www.info.se)

ForestForwarder

The party that transports forest wood products from logging areas to roadside landings.

ForestForwardingRequestor

The party requesting forest forwarding services.

ForestHarvester

The party that harvests forest wood products at logging areas.

ForestHarvestingRequestor

The party requesting forest harvesting services.

ForestHub

An agency for Forest Wood Supply & Bioproducts industries.

Forwarder

The OtherParty indicated by party type "Forwarder" or when communicating OrderStatus the party indicated by ForwarderParty.

FSC

Forest Stewardship Council

GCA

Graphic Communications Association. (This agency now calls itself

IDEAlliance.)

GCA-CCTI

The GCA and CCTI combined coding

GOST

Russian federal agency on technical regulating and metrology.
(<http://www.gost.ru>)

GS1

GS1 is an international not-for-profit association with Member Organisations in over 100 countries. GS1 is dedicated to the design and implementation of global standards and solutions to improve the efficiency and visibility of supply and demand chains globally and across sectors. <http://www.gs1.org/>

IFRA

INCA FIEJ Research Association (Technical Research and Consulting Association for the Newspaper Industry).

Intrastat

The agency responsible for collecting statistics on the physical trade of goods between the members of the EU.

ISO

International Organisation for Standardisation.

ISRI

Institute of Scrap Recycling Industries.

KpDC

Agency maintaining codes for the Latvia wood supply segment.
(www.KpDC.lv).

Loading Operator

A party that is carrying out loading of transport units.

Logistics Buyer

The buyer of the logistics service has defined the codes used in the particular element of the transaction. Care must be used when using this agency to assure that the recipient of the e-Document understands what is being communicated.

Logistics Seller

The seller of the logistics service has defined the codes used in the particular element of the transaction. Care must be used when using this agency to assure that the recipient of the e-Document understands what is being communicated.

Logistics Supplier

The supplier of the logistics service has defined the codes used in the particular element of the transaction. Care must be used when using this agency to assure that the recipient of the e-Document understands what is being communicated.

Measuring Party

The party that is responsible for the measurements at the measuring location.

Mill

The OtherParty indicated by party type "Mill" or when available the party indicated by MillParty.

NMFTA

National Motor Freight Traffic Association (NMFTA)

NOBB

Norwegian Building Products database, (Norsk ByggvareBase)

NorwegianEnvironmentAgency

The Norwegian Environment Agency is a government agency under the Ministry of Climate and Environment.

<https://www.environmentagency.no>

NPTA

National Paper Trade Association.

Ondule

European Association of Corrugated Base Papers Manufacturers (actually Óndule).

PEFC

www.pefc.org

PMS

Pantone Matching System is a colour matching system that is widely used in the book industry. See www.pantone.com for more information.

PPPC

Pulp and Paper Products Council.

Publisher

The person, company or organization responsible for placing a book, journal, or other publication on the market (as opposed to the printer or bookseller); also referred to as the "buyer".

PWO

Agency for Pulpwood Online.

RASI

Article numbering agency and system in Finland for building products. (www.rasi.fi)

RevenueCanada

Canadian Revenue Agency. See www.cra.gc.ca

RVR

Agency maintaining codes for the German wood supply segment. RVR is the abbreviation for "Rahmenvereinbarung für den Rohholzhandel in Deutschland". (www.rvr-deutschland.de).

SD

papiNet V2R31

Agency maintaining codes for the Norwegian wood supply segment
(www.skogdata.no).

SDC

Agency maintaining codes for the Swedish wood supply segment
(www.biometria.se).

Seller

The seller of the product has defined the codes used in the particular element of the transaction. Care must be used when using this agency to assure that the recipient of the e-Document understands what is being communicated. (Not to be used for logistics seller, see LogisticsSeller.)

Supplier

The supplier has defined the codes used in the particular element of the transaction. Care must be used when using this agency to assure that the recipient of the e-Document understands what is being communicated. (Not to be used for logistics supplier, see LogisticsSupplier).

SwedishEnvironmentalProtectionAgency

The public agency in Sweden that is responsible for environmental issues.
<https://www.naturvardsverket.se/en>

TAPPI

Technical Association for the Paper and Pulp Industry

UCC

To be deprecated in a future version V3R00. In 2005 the Uniform Code Council (UCC) changed its name to GS1 US as a member organisation of GS1 in United States of America. Use GS1 instead.

<http://www.gs1.org/>

<http://www.gs1us.org/>

UIC

International Union of Railways. (<http://www.uic.org>)
(Union Internationale des Chemins de fer)

UN/ECE

The United Nations – Economic Commission for Europe

WarehouseOperator

The party operating a warehouse.

WCO

World Customs Organization (refer to wcoomd.org for more information).

XBITS

XML Book Industry Transaction Standards

Other

Used when the agency responsible for a coding system is not defined in the attribute list, or there is no agency responsible for the codes used.

AggregatedUsageLineItem

A group item that summarises item usage at the Product level or at the Product plus PurchaseOrder level. Details concerning the individual items used are not included.

(sequence)

The sequence of items below is mandatory. A single instance is required.

Product

Product is

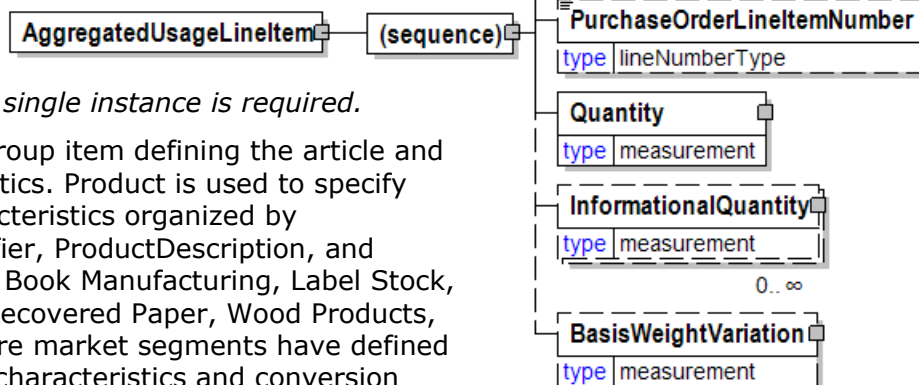

mandatory. A single instance is required.

Product is a group item defining the article and its characteristics. Product is used to specify product characteristics organized by ProductIdentifier, ProductDescription, and Classification. Book Manufacturing, Label Stock, Paper, Pulp, Recovered Paper, Wood Products, and Virgin Fibre market segments have defined their product characteristics and conversion features for implementation in papiNet.

OtherParty

OtherParty is optional. Multiple instances might exist.

An organisation or business entity other than those specifically detailed within an e-Document.

PurchaseOrderInformation

PurchaseOrderInformation is optional. A single instance might exist.

A group item containing information unique to this PurchaseOrder, which is provided by the buyer. PurchaseOrderInformation can be optional in the supply chain. Invoices are created without having a PurchaseOrder in Vendor Managed Inventory. Freight invoices also will not have a PurchaseOrder number.

PurchaseOrderLineItemNumber

PurchaseOrderLineItemNumber is optional. A single instance might exist.

The sequential number that uniquely identifies the PurchaseOrder line item.

Quantity

Quantity is mandatory. A single instance is required.

The Quantity element contains attributes that provide information about the type of quantity that is being communicated, the context in which the particular quantity is to be viewed, and (if the quantity represents an adjustment) an adjustment type.

The Quantity element contains three child elements that enable you to communicate a range of values for the quantity and a target or actual value. It is at this level (Value, RangeMin, and RangeMax) that the unit of measure is specified. This permits the range to be specified in a different unit of measure than the target.

InformationalQuantity

InformationalQuantity is optional. Multiple instances might exist.

papiNet V2R31

A quantity given in a valid UOM used for information purposes only (not for calculation). For example, an ordered quantity was 100 reels as opposed to the invoice quantity of 20,000 pounds.

BasisWeightVariation

BasisWeightVariation is optional. A single instance might exist.

BasisWeightVariation is the measured difference between the mill target basis weight and the mill actual basis weight.

Alignment

A measurement of how the reel is aligned on printing press

(sequence)

The sequence of items below is mandatory. A single instance is required.

Value

Value is mandatory. A single instance is required.

A numeric value expressed in the unit of measure (UOM).

RangeMin

RangeMin is optional. A single instance might exist.

The minimum value (lower boundary) allowed for the Measurement that is the parent of this element.

RangeMax

RangeMax is optional. A single instance might exist.

The maximum value (upper boundary) allowed for the Measurement that is the parent of this element. Some elements use the RangeMax element with an extended list of unit of measures. (Note: the red colour in the picture is an artifact of how the graphic was captured and should be disregarded.)

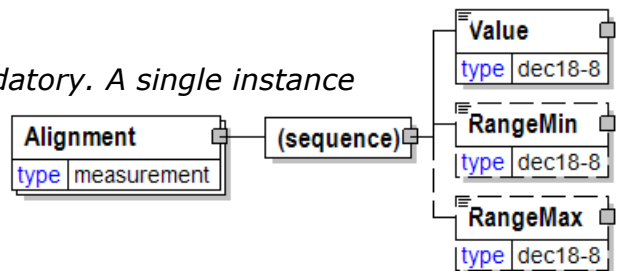

Altitude

The height of a location above a ground reference point as specified by the map reference system.

(sequence)

The sequence of items below is mandatory. A single instance is required.

Value

Value is mandatory. A single instance is required.

A numeric value expressed in the unit of measure (UOM).

RangeMin

RangeMin is optional. A single instance might exist.

The minimum value (lower boundary) allowed for the Measurement that is the parent of this element.

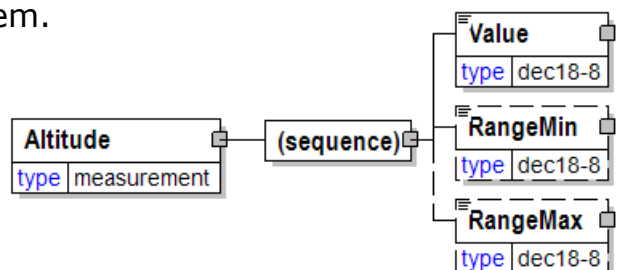

RangeMax

RangeMax is optional. A single instance might exist.

The maximum value (upper boundary) allowed for the Measurement that is the parent of this element. Some elements use the RangeMax element with an extended list of unit of measures. (Note: the red colour in the picture is an artifact of how the graphic was captured and should be disregarded.)

AmbientTemperature

The temperature of the surrounding environment.

(sequence)

The sequence of items below is mandatory. A single instance is required.

Value

Value is mandatory. A single instance is required.

A numeric value expressed in the unit of measure (UOM).

RangeMin

RangeMin is optional. A single instance might exist.

The minimum value (lower boundary) allowed for the Measurement that is the parent of this element.

RangeMax

RangeMax is optional. A single instance might exist.

The maximum value (upper boundary) allowed for the Measurement that is the parent of this element. Some elements use the RangeMax element with an extended list of unit of measures. (Note: the red colour in the picture is an artifact of how the graphic was captured and should be disregarded.)

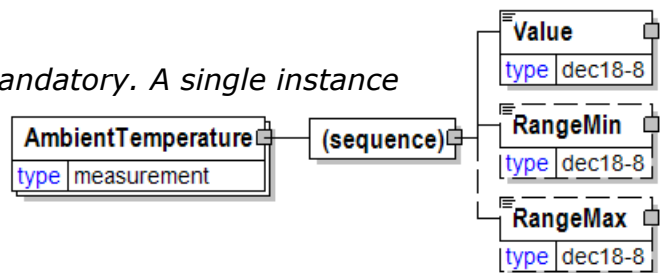

Amount

An element that contains the amount including tax. The Amount encapsulates CurrencyValue.

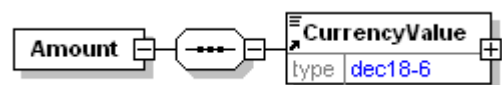

(sequence)

The sequence of items below is mandatory. A single instance is required.

CurrencyValue

CurrencyValue is mandatory. A single instance is required.

The amount in the referenced currency as defined by the CurrencyType attribute.

AmountSubjectToTermsDiscount

The amount against which prompt payment terms can be applied.

(sequence)

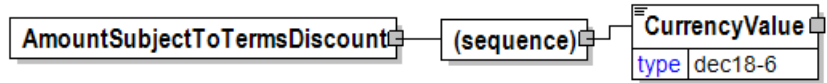

The sequence of items below is mandatory. A single instance is required.

CurrencyValue

CurrencyValue is mandatory. A single instance is required.

The amount in the referenced currency as defined by the CurrencyType attribute.

AmountType [attribute]

Defines the type of amount.

This item is restricted to the following list.

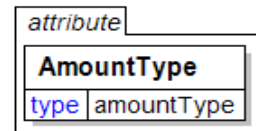

Adjustment

Adjustment amount, i.e. the sum of all instances of PriceAdjustment and FlatAmountAdjustment but excluding tax amounts.

DecimalRounding

Amount applied for decimal rounding of amounts due for payment.

For example, Finland does not use smaller than 5 cent coins. All cash payments are rounded to a 5 cent divisible amount according to national legislation. Alternatively, certain market segments prefer to remove all decimals.

Net

Net amount, i.e. an amount excluding tax

Tax

Tax amount

TermsDiscountNet

The prompt payment discount amount excluding tax.

Total

Total amount, i.e. an amount including tax.

Appearance

A group item used to communicate appearance.

TestMethod [attribute]

TestMethod is optional. A single instance might exist.

The method used to determine the results of the test under consideration.

TestAgency [attribute]

TestAgency is optional. A single instance might exist.

The agency that has set the parameters for the testing

Refer to TestAgency definition for any enumerations.

SampleType [attribute]

SampleType is optional. A single instance might exist.

Communicates how sampling was done to measure the product characteristics.

Refer to SampleType definition for any enumerations.

ResultSource [attribute]

ResultSource is optional. A single instance might exist.

Used to define the data source of the specified test

Refer to ResultSource definition for any enumerations.

(sequence)

The sequence of items below is mandatory. A single instance is required.

DetailValue

DetailValue is mandatory. A single instance is required.

A numeric value expressed in the unit of measure (UOM).

DetailRangeMin

DetailRangeMin is optional. A single instance might exist.

The minimum value (lower boundary) allowed for the DetailValue that is the parent of this element.

DetailRangeMax

DetailRangeMax is optional. A single instance might exist.

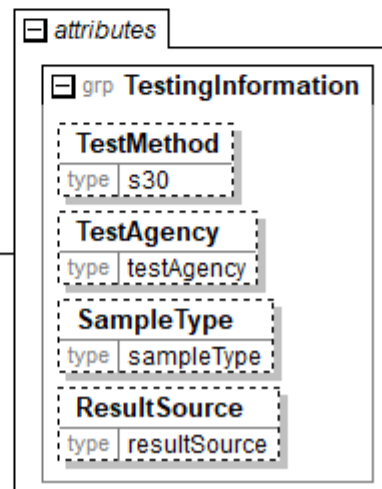
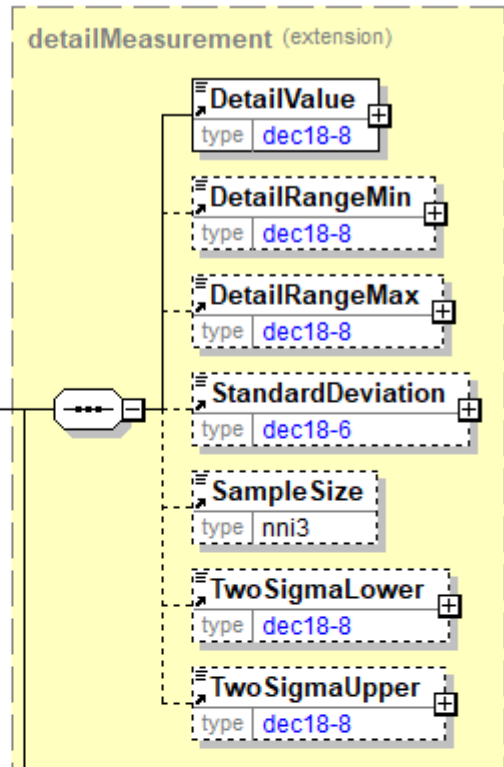

The maximum value (upper boundary) allowed for the DetailValue that is the parent of this element.

StandardDeviation

StandardDeviation is optional. A single instance might exist.

A statistic used as a measure of dispersion in a distribution.

SampleSize

SampleSize is optional. A single instance might exist.

The number of samples used to determine the product characteristic in question.

TwoSigmaLower

TwoSigmaLower is optional. A single instance might exist.

Two sigma (a measure of dispersion associated with standard deviation) on the lower side of the standard deviation.

TwoSigmaUpper

TwoSigmaUpper is optional. A single instance might exist.

Two sigma (a measure of dispersion associated with standard deviation) on the upper side of the standard deviation.

AppliesTo [attribute]

Specifies the type of item to which measurements apply to.

This item is restricted to the following list.



Dunnage

Material used for securing and protection of goods loaded in a transport unit during transportation.

Payload

Measurements apply to the payload.

Unit

Measurements apply to the physical unit.

VerifiedGrossMass

The total Verified Gross Mass of a packed transport unit is the transport unit tare weight plus the weight of the payload plus the weight of the dunnage used for securing and protection of the goods.

The International Maritime Organisation (IMO) has amended the Safety of Life at Sea Convention (SOLAS) in Chapter VI, Part A Regulation 2, requiring the shipper to verify Gross Mass of packed containers. As from 1 July 2016 according to this regulation the shipper is obliged to provide the Verified Gross Mass of each container prior to shipment on a vessel.

AreaInfo

A grouping element that contains information about an area, e.g. an area belonging to a location.

(sequence)

The sequence of items below is mandatory. A single instance is required.

AreaProperty

AreaProperty is optional. Multiple instances might exist.

A grouping element that contains a specification of a property for an area.

MapPoint

MapPoint is optional. Multiple instances might exist.

A grouping element for items describing a point on a map. A mappoint is normally named waypoint in a GPS.

PropertyValue

PropertyValue is optional. Multiple instances might exist.

Specifies a value for a property of an item. The property is defined by the attribute PropertyType. The attribute MeasuringMethod and MeasuringAgency can be used to clarify details for a how a property is measured or calculated, e.g. Diameter for a saw log can be measured "Under Bark" or "Over Bark". The attribute MeasuringMethodType defines how the value is created, e.g. measured automatically, calculated etc. The attribute IsAverageValue indicates if the value is an average value or not.

PropertySubValue can specify a value for a property related to the property specified by the attribute PropertyType of PropertyValue. PropertyValueOfWhichMax and PropertyValueOfWhichMin can specify maximum and minimum values for properties that are part of the property specified by the attribute PropertyType of PropertyValue.

eAttachment

eAttachment is optional. A single instance might exist.

eAttachment enables the sender to provide information about attachments to the document.

- Note: An element "e-Attachment" also exists. papiNet will no longer use hyphens in our element and attribute names as this causes issues with BizTalk.

AdditionalText

AdditionalText is optional. Multiple instances might exist.

A text field that is used to communicate information not previously defined or for special instructions. To be used only for circumstances not covered by specific elements.

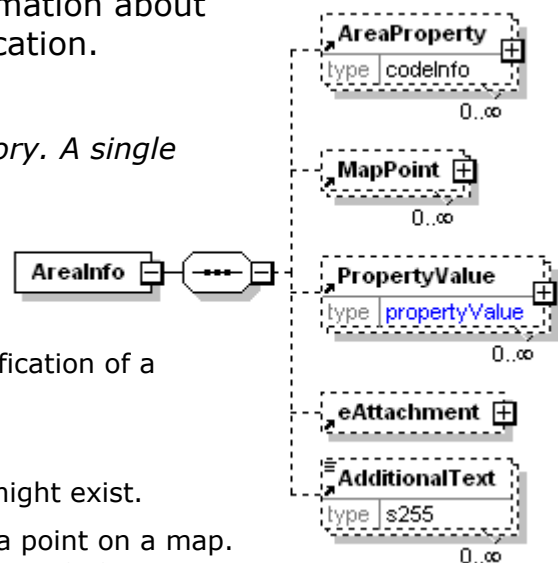

AreaProperty

A grouping element that contains a specification of a property for an area.

Agency [attribute]

Agency is mandatory. A single instance is required.

Describes the agency maintaining the list of codes. To be included in this list the agency must be a recognized standards body or industry organisation.

- For the element that owns this attribute.
- For another attribute in the list of attributes associated with the parent element.

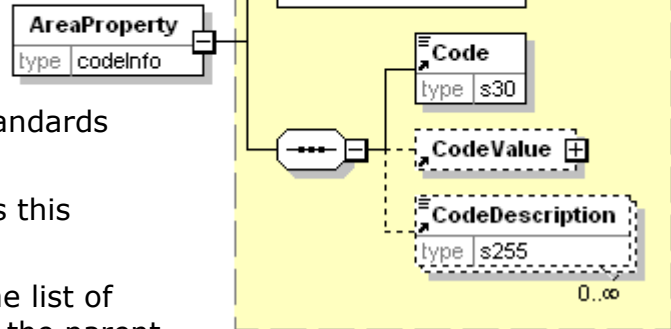

Refer to Agency definition for any enumerations.

(sequence)

The sequence of items below is mandatory. A single instance is required.

Code

Code is mandatory. A single instance is required.

Specifies a code that is defined by an agency. The agency is given for the whole construct containing the code.

CodeValue

CodeValue is optional. A single instance might exist.

A grouping element specifying a value belonging to a code that is defined by an agency.

CodeDescription

CodeDescription is optional. Multiple instances might exist.

A textual description for the meaning of a code that is defined by an agency. When the Code is associated with a CodeValue of type TextValue, then the CodeDescription is a textual description of both the Code and the TextValue.

ArrivalDate

The date of arrival.

(sequence)

The sequence of items below is mandatory. A single instance is required.

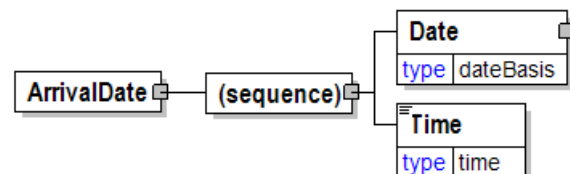

Date

Date is mandatory. A single instance is required.

A group element that contains the specification of Year, Month, and Day.

papiNet V2R31

Time

Time is mandatory. A single instance is required.

Times are treated in a standard XML fashion with a special case used to indicate a generalized "local" time. The standard XML approach to time is hh:mm:ss, hh:mm:ssZ, or hh:mm:ss±hh:mm.

hh:mm:ss±hh:mm is used to represent a time with a time zone. The time zone is communicated as the number of hours offset from the Universal Time Coordinate (UTC), a.k.a. Greenwich Mean Time.

hh:mm:ssZ indicates the time at Zulu (another name for UTC).

hh:mm:ss or hh:mm indicates within papiNet the applicable local time where the associated event is taking place. Caution should be used when processing times of this nature as the papiNet approach may be in discord with other users of XML.

Ash

A group item used to communicate the ash content of the product according to a particular TestMethod.

TestMethod [attribute]

TestMethod is optional. A single instance might exist.

The method used to determine the results of the test under consideration.

TestAgency [attribute]

TestAgency is optional. A single instance might exist.

The agency that has set the parameters for the testing

Refer to TestAgency definition for any enumerations.

SampleType [attribute]

SampleType is optional. A single instance might exist.

Communicates how sampling was done to measure the product characteristics.

Refer to SampleType definition for any enumerations.

ResultSource [attribute]

ResultSource is optional. A single instance might exist.

Used to define the data source of the specified test

Refer to ResultSource definition for any enumerations.

(sequence)

The sequence of items below is mandatory. A single instance is required.

DetailValue

DetailValue is mandatory. A single instance is required.

A numeric value expressed in the unit of measure (UOM).

DetailRangeMin

DetailRangeMin is optional. A single instance might exist.

The minimum value (lower boundary) allowed for the DetailValue that is the parent of this element.

DetailRangeMax

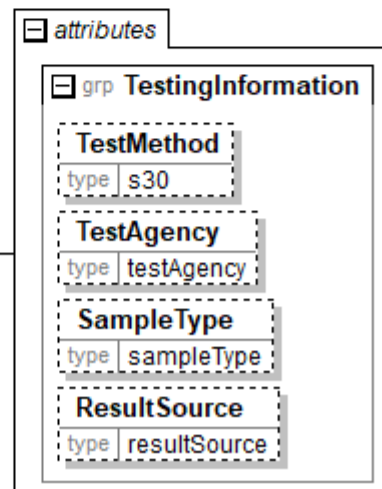
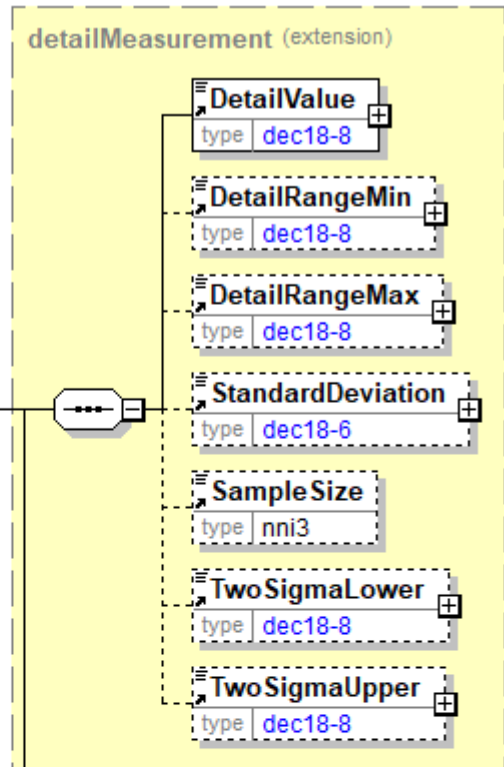

papiNet V2R31

DetailRangeMax is optional. A single instance might exist.

The maximum value (upper boundary) allowed for the DetailValue that is the parent of this element.

StandardDeviation

StandardDeviation is optional. A single instance might exist.

A statistic used as a measure of dispersion in a distribution.

SampleSize

SampleSize is optional. A single instance might exist.

The number of samples used to determine the product characteristic in question.

TwoSigmaLower

TwoSigmaLower is optional. A single instance might exist.

Two sigma (a measure of dispersion associated with standard deviation) on the lower side of the standard deviation.

TwoSigmaUpper

TwoSigmaUpper is optional. A single instance might exist.

Two sigma (a measure of dispersion associated with standard deviation) on the upper side of the standard deviation.

AssemblyInstructions

Instructions for assembly.

AssemblyInstructions
type s255

AssemblyType [attribute]

Assembly type

This item is restricted to the following list.

AVC

BulkPack

Capsule

CDBookStyle

CDOSleeve

CDWallet

CO/CR/CF-1

CO/CR/CF-2

CO/CR/CF-3

CO/CR/CF-4

CPN1

CPN2

attribute
AssemblyType
type assemblyType

CPN3

CPN4

DCN1

DCN2

ICanRead

OCard

PVCBag

UAB

UAS6

UAS8

AssignedBy [attribute]

Identifies the type of party or the agency that has assigned the associated item, e.g. a reference of type OrderNumber.

This item is restricted to the following list.

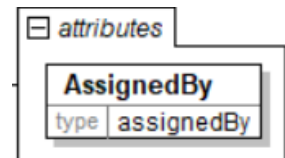

Auditor

A third party that is authorized for making audits and checkings.

Bank

The banking representative.

BillTo

The address where the invoice is to be sent. (Not to be used for logistics BillTo, see LogisticsBillTo.)

BorderCrossing

A geographic location separating two countries authorised to validate customs documentation.

Broker

The organisation acting as a broker for the buyer or supplier.

BusinessChainParty

The organisation or business entity responsible for managing the business chain between business partners when trading of products in many levels of trade.

Buyer

The legal entity to which the product is sold. Also commonly referred to as the sold-to party or customer. If no OtherParty is defined as the "Payer", the "Buyer" is the "Payer". (Not to be used for logistics buyer, see LogisticsBuyer.)

BuyerAgent

The entity acting for the buyer in the transaction. (Not to be used for logistics BuyerAgent, see LogisticsBuyerAgent.)

Carrier

The organisation or business entity that transports goods.

CarrierAssignmentResponsible

The organisation to which the carrier has assigned some task.

ComponentVendor

Vendor producing supplied components.

Compositor

Party that formats written material and illustrations for printing or electronic display.

Consignee

To be deprecated in a future version V3R00. Use LogisticsRole attribute to communicate this information.

Consignor

To be deprecated in a future version V3R00. Use LogisticsRole attribute to communicate this information.

Consuming

The eventual consumer of the material

ContractParty

The organisation or business entity responsible for managing the contract between business partners.

Converter

The organisation responsible for changing one form of paper into another form, providing specialised functions not available to the supplier.

CreditDepartment

The party responsible for credit authorization.

CrossDock

A third party involved in the transport of goods.

CustomerFacility

The type of the origin or destination location of a transport leg in a route is a buyer facility, usually a print site, or a warehouse owned by the buyer.

CustomerStock

A "virtual" location that indicates that the material is owned by the customer.

Customs

Any customs agency.

CustomsForwarder

A forwarder responsible for managing the transfer of goods through customs.

DeliveryPlanningParty

The organisation responsible for planning of deliveries to delivery destinations.

DomesticForwarder

A forwarder responsible for managing the transfer of goods.

EndUser

EndUser is the party using, consuming, or converting the product. For example, a printer using paper reels to print a job for a publisher (printer is the end user). The final ShipTo destination for a product is normally to the EndUser facilities.

EU

European Union.

ExportForwarder

A forwarder responsible for managing the export process.

FinnishForestCentre

The Finnish Forest Centre (Metsäkeskus) is an official forestry body of Finland. <https://www.metsakeskus.fi/en>

ForestForwarder

The party that transports forest wood products from logging areas to roadside landings.

ForestForwardingRequestor

The party requesting forest forwarding services.

ForestHarvester

The party that harvests forest wood products at logging areas.

ForestHarvestingRequestor

The party requesting forest harvesting services.

Forwarder

The party responsible for shipping arrangements.

FreightPayer

The party responsible for paying freight.

Insurer

The party providing insurance coverage for the goods.

Laboratory

Laboratory is where analysis is done.

LatvianForestService

The Latvian Forest Service (Valsts Meža Dienests) is an official forestry body of Latvia. <https://www.vmd.gov.lv>

Landowner

The party who owns the land upon which the product was produced.

LoadingOperator

A party that is carrying out loading of transport units.

LoggingArea

A geographic location in the forest where logging takes place.

LogisticsBillTo

The address where the logistics invoice is to be sent.

LogisticsBuyer

The buyer of logistics services. The legal entity to which the service is sold. Also commonly referred to as the sold-to party or customer. If no OtherParty is defined as the "LogisticsPayer", the "LogisticsBuyer" is the payer.

LogisticsBuyerAgent

The entity acting for the logistics buyer in the transaction.

LogisticsPayee

The party handling and receiving logistics payments on behalf of another party.

LogisticsPayer

The party handling and sending logistics payments of behalf of another party.

LogisticsPlanningParty

The organisation responsible for planning of logistics services.

LogisticsSeller

The seller of logistics services. LogisticsSupplier is the seller of the service, if logistics seller is not specified as OtherParty = LogisticsSeller.

LogisticsServiceProvider

A party that is responsible for a service in logistics business.

LogisticsServiceProvider (misspelt with an ending space)

The item is misspelt ending with a space. It will be deprecated in a future version V3R00.

Use instead the correctly spelt enumeration LogisticsServiceProvider.

LogisticsSupplier

The party responsible for providing the logistics services. LogisticsSupplier is also the seller of the service, if logistics seller is not specified as OtherParty = LogisticsSeller.

MainCarrier

The primary carrier involved in the movement of goods.

MainForestForwarder

The party responsible for transporting forest wood products from logging areas to roadside landings.

MainForestHarvester

The party responsible for harvesting of forest wood products at logging areas.

Measurer

The party that that is carrying out the measurement of the quantity and/or quality of the products. It can be a person, a piece of equipment or a device.

MeasuringParty

The party that is responsible for the measurements at the measuring location.

Merchant

A third party buying and reselling products.

Mill

A production facility.

NationalLandSurveyOfFinland

An official body, dealing with cartography and cadastre issues in Finland.

<https://www.nls.fi>

NotifyParty

A party that needs to be notified of the status of the transaction.

OnBehalfOf

The activity in question is being made on behalf of this party.

OrderParty

The organisation or business entity placing the order if different from the buyer party.

OriginalBuyer

The first buyer in a supply chain. OriginalBuyer is only used when the first buyer in a supply chain needs to be specified in other e-documents than e-documents belonging to the first level of trade. (Not to be used for the first buyer in a supply chain of logistics, see OriginalLogisticsBuyer.)

OriginalBuyerAgent

The entity acting for the OriginalBuyer in the transaction. OriginalBuyerAgent is only used when the first buyer agent in a supply chain needs to be specified in other e-documents than e-documents belonging to the first level of trade. (Not to be used for the first buyer agent in a supply chain of logistics, see OriginalLogisticsBuyerAgent.)

OriginalLogisticsBuyer

The first logistics buyer in a supply chain of logistics. OriginalLogisticsBuyer is only used when the first logistics buyer in a supply chain of logistics needs to be specified in other e-documents than e-documents belonging to the first level of logistics trade.

OriginalLogisticsBuyerAgent

The entity acting for the OriginalLogisticsBuyer in the transaction. OriginalLogisticsBuyerAgent is only used when the first logistics buyer agent in a supply chain of logistics needs to be specified in other e-documents than e-documents belonging to the first level of logistics trade.

OriginalLogisticsSeller

The first logistics seller in a supply chain of logistics. OriginalLogisticsSupplier is the OriginalLogisticsSeller of the service, if OriginalLogisticsSeller is not specified as OtherParty = OriginalLogisticsSeller. OriginalLogisticsSeller is only used when the first logistics seller in a supply chain of logistics needs to be specified in other e-documents than e-documents belonging to the first level of logistics trade.

OriginalLogisticsSupplier

The first logistics supplier in a supply chain of logistics. OriginalLogisticsSupplier is also the OriginalLogisticsSeller of the service, if OriginalLogisticsSeller is not specified as OtherParty = OriginalLogisticsSeller. OriginalLogisticsSupplier is only used when the first logistics supplier in a supply chain of logistics needs to be specified in other e-documents than e-documents belonging to the first level of logistics trade.

OriginalOrderParty

Party which ordered the product from the Party sending the first level PurchaseOrder in an indirect purchase order process.

OriginalSeller

The first seller in a supply chain. OriginalSupplier is the OriginalSeller of the product, if OriginalSeller is not specified as OtherParty = OriginalSeller. OriginalSeller is only used when the first seller in a supply chain needs to be specified in other e-documents than e-documents belonging to the first level of trade. (Not to be used for the first seller in a supply chain of logistics, see OriginalLogisticsSeller.)

OriginalSupplier

The first supplier in a supply chain. OriginalSupplier is also the OriginalSeller of the product, if OriginalSeller is not specified as OtherParty = OriginalSeller. OriginalSupplier is only intended to identify the business party, not the origin of the product. OriginalSupplier is only used when the first supplier in a supply chain needs to be specified in other e-documents than e-documents belonging to the first level of trade. (Not to be used for the first supplier in a supply chain of logistics, see OriginalLogisticsSupplier.)

Payee

The party handling and receiving payments on behalf of another party. (Not to be used for logistics payee, see LogisticsPayee.)

Payer

The party handling and sending payments of behalf of another party. (Not to be used for logistics payer, see LogisticsPayer.)

PlaceFinalDestination

The final destination of the goods.

PlaceOfAccept

The location where acceptance of the goods is to take place.

PlaceOfDespatch

The location where despatch took place.

PlaceOfDischarge

The location where the goods were unloaded.

PlaceOfLoading

The location where loading is to or took place.

PlaceOfMeasuring

The location where the products are measured.

PlaceOfPassingThrough

papiNet V2R31

A location to be passed by a vehicle, e.g. a main intersection on a Route.

PlaceOfReloading

A location where the goods were or will be transferred from one transport to another. It may but does not need to involve a change of transport mode.

Port

The type of the origin or destination location of a transport leg in a route. It is a maritime location.

PreCarrier

The party responsible for activities prior to carrier accepting the goods (but after shipping has taken place).

PriceListParty

The organization or business entity responsible managing for the price list between business partners.

PrinterFacility

The location of the printer who will be using the product.

Producer

The manufacturer of the goods.

ProductAgency

Organization responsible for defining unique product identifiers.

ProFormaInvoice

The organisation or business entity to which the pro-forma invoice will be sent.

Publisher

Individual or corporation responsible for the printing and distribution of digital or printed publications.

RemitTo

The organisation or business entity to which payment will be made.

Requestor

The originator of the original PurchaseOrder requisition (for example, a printing plant ordering through a central purchasing organisation).

RoadKeeper

The party who is responsible for the maintenance of the road.

RoadOwner

The party who is the legal owner of the road.

SalesAgent

The organisation or person responsible for product sales acting on behalf of the seller.

SalesOffice

The functional unit in an organisation or business entity that is responsible for product sales.

Seller

The seller of the product. SupplierParty is the seller of the product, if Seller is not specified as OtherParty = Seller. (Not to be used for logistics seller, see LogisticsSeller.)

ServiceProvider

The party that is responsible for a service in product business.

ShipFromLocation

The location the goods were shipped from.

ShipOwner

The owner of the vessel used to ship the goods.

ShipTo

The address the material should be shipped to.

SubCarrier

A sub carrier of another the shipping company.

Supplier

The organisation or business entity responsible for providing the product. SupplierParty is also the seller of the product, if Seller is not specified as OtherParty = Seller. (Not to be used for logistics supplier, see LogisticsSupplier.)

SupplyRequirementPlanningParty

The organisation responsible for planning of supply requirements for industries depending on their needs.

Terminal

The type of the origin or destination location of a transport leg in a route. It can be a sea, road or rail terminal.

TerminalOperator

The party providing facilities such as loading, unloading, or warehousing.

UnloadingOperator

A party that is carrying out unloading of transport units.

Warehouse

A storage location. It can be the origin or destination location of a transport leg in a route.

WarehouseOperator

The party operating a warehouse.

WillAdvise

Indicates that party will be identified at a later time

Other

Any other organisation or business entity that may get involved in the transaction and that is not covered by the list.

AttachmentContext [attribute]

The purpose of the attachment.



AttachmentFileName

The name of the attached file.

AttachmentContext [attribute]

AttachmentContext is optional. A single instance might exist.

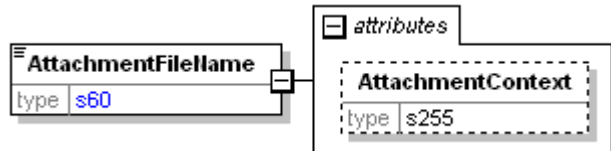

The purpose of the attachment

Refer to AttachmentContext definition for any enumerations.

AudioCassette

Audio cassette

SpineLabel [attribute]

SpineLabel is optional. A single instance might exist.

Is there a spine label?

Refer to SpineLabel definition for any enumerations.

NoiseReduction [attribute]

NoiseReduction is optional. A single instance might exist.

The noise reduction method

Refer to NoiseReduction definition for any enumerations.

DuplicationRatio [attribute]

DuplicationRatio is optional. A single instance might exist.

Duplication ratio

Any valid string

TrackType [attribute]

TrackType is optional. A single instance might exist.

The type of track

Refer to TrackType definition for any enumerations.

Tabs [attribute]

Tabs is optional. A single instance might exist.

The type of tabs

Refer to Tabs definition for any enumerations.

AudioCassetteCaseType [attribute]

AudioCassetteCaseType is optional. A single instance might exist.

Describes the type of audio cassette case.

Refer to AudioCassetteCaseType definition for any enumerations.

AudioCassetteTapeLengthType [attribute]

AudioCassetteTapeLengthType is optional. A single instance might exist.

Describes the length of the tape used in the audio cassette. The number indicates the expected number of minutes the tape will run.

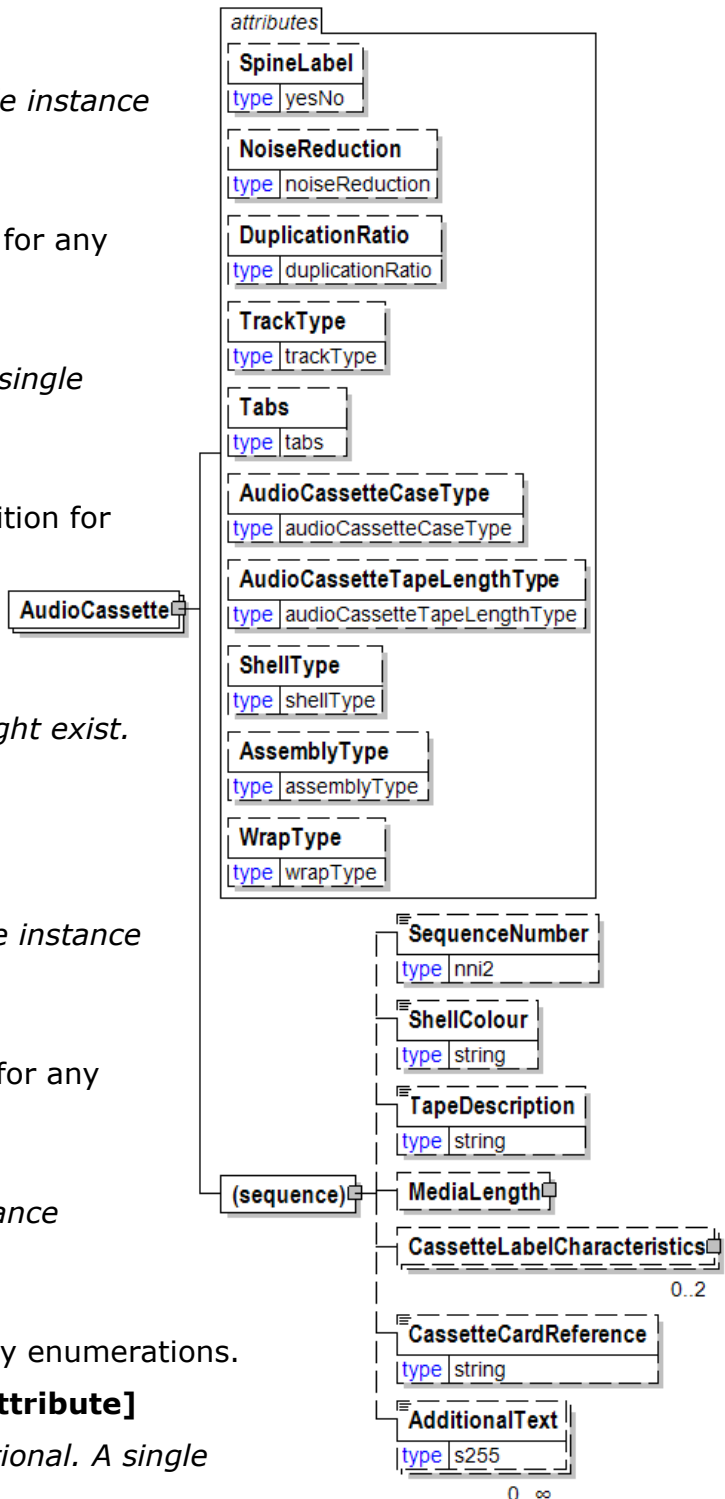

Refer to AudioCassetteTapeLengthType definition for any enumerations.

ShellType [attribute]

ShellType is optional. A single instance might exist.

The type of shell

Refer to ShellType definition for any enumerations.

AssemblyType [attribute]

AssemblyType is optional. A single instance might exist.

Assembly type

Refer to AssemblyType definition for any enumerations.

WrapType [attribute]

WrapType is optional. A single instance might exist.

Communicates the type of material used to wrap the product.

Refer to WrapType definition for any enumerations.

(sequence)

The sequence of items below is mandatory. A single instance is required.

SequenceNumber

SequenceNumber is optional. A single instance might exist.

A sequential number that uniquely identifies a sequence.

ShellColour

ShellColour is optional. A single instance might exist.

Shell colour

TapeDescription

TapeDescription is optional. A single instance might exist.

Tape description

MediaLength

MediaLength is optional. A single instance might exist.

Media length

CassetteLabelCharacteristics

CassetteLabelCharacteristics is optional.

Cassette label characteristics

CassetteCardReference

CassetteCardReference is optional. A single instance might exist.

Cassette card reference

AdditionalText

AdditionalText is optional. Multiple instances might exist.

A text field that is used to communicate information not previously defined or for special instructions. To be used only for circumstances not covered by specific elements.

AudioCassetteCaseType [attribute]

Describes the type of audio cassette case.

This item is restricted to the following list.

PolyBox

BlackClearNorelco

ClearClearNorelco

OCard



AudioCassetteTapeLengthType [attribute]

Describes the length of the tape used in the audio cassette. The number indicates the expected number of minutes the tape will run.

This item is restricted to the following list.

C-10

A tape length of 10 minutes.

C-15

A tape length of 15 minutes.

C-20

A tape length of 20 minutes.

C-25

A tape length of 25 minutes.

C-30

A tape length of 30 minutes.

C-35

A tape length of 35 minutes.

C-40

A tape length of 40 minutes.

C-45

A tape length of 45 minutes.

C-50

A tape length of 50 minutes.

C-55

A tape length of 55 minutes.

C-60

A tape length of 60 minutes.

C-65



A tape length of 65 minutes.

C-70

A tape length of 70 minutes.

C-75

A tape length of 75 minutes.

C-80

A tape length of 80 minutes.

C-85

A tape length of 85 minutes.

C-90

A tape length of 90 minutes.

C-95

A tape length of 95 minutes.

C-100

A tape length of 100 minutes.

C-105

A tape length of 105 minutes.

C-110

A tape length of 110 minutes.

C-115

A tape length of 115 minutes.

C-120

A tape length of 120 minutes.

Availability

The Availability element is the root element for the Availability e-Document.

The purpose of the Availability e-Document is to provide a means to ask about the availability of the specified product. The amount of the product immediately available (on-hand) is anticipated to be returned. Optionally, the anticipated availability of the product at a point in future can be communicated.

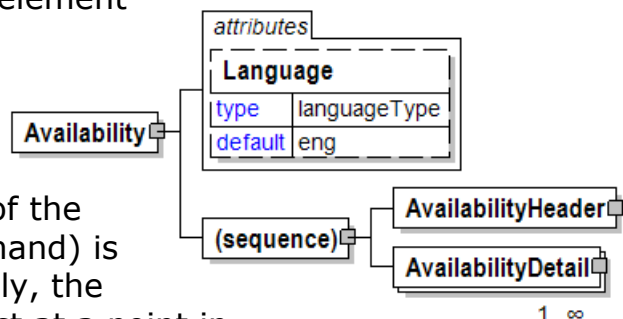

Language [attribute]

Language is optional. A single instance might exist.

The valid Alpha 2- and Alpha 3-character list of language codes in the ISO 639-1 and 639-2 international standards.

Information on the content of this attribute is available at:
https://www.loc.gov/standards/iso639-2/php/code_list.php

(sequence)

The sequence of items below is mandatory. A single instance is required.

AvailabilityHeader

AvailabilityHeader is mandatory. A single instance is required.

The AvailabilityHeader contains items that apply to the entire Availability e-Document.

AvailabilityDetail

AvailabilityDetail is mandatory. One instance is required, multiple instances might exist.

AvailabilityDetail provides the detailed availability information for the requested product.

AvailabilityDetail

AvailabilityDetail provides the detailed availability information for the requested product.

(sequence)

The sequence of items below is mandatory. A single instance is required.

Product

Product is mandatory. A single instance is required.

Product is a group item defining the article and its characteristics. Product is used to specify product characteristics organized by ProductIdentifier, ProductDescription, and Classification. Book

Manufacturing, Label Stock, Paper, Pulp, Recovered Paper, Wood Products, and Virgin Fibre market segments have defined their product characteristics and conversion features for implementation in papiNet.

TimePeriod

TimePeriod is mandatory. A single instance is required.

The TimePeriod element is used to communicate a duration period of time as indicated in PeriodType.

Quantity

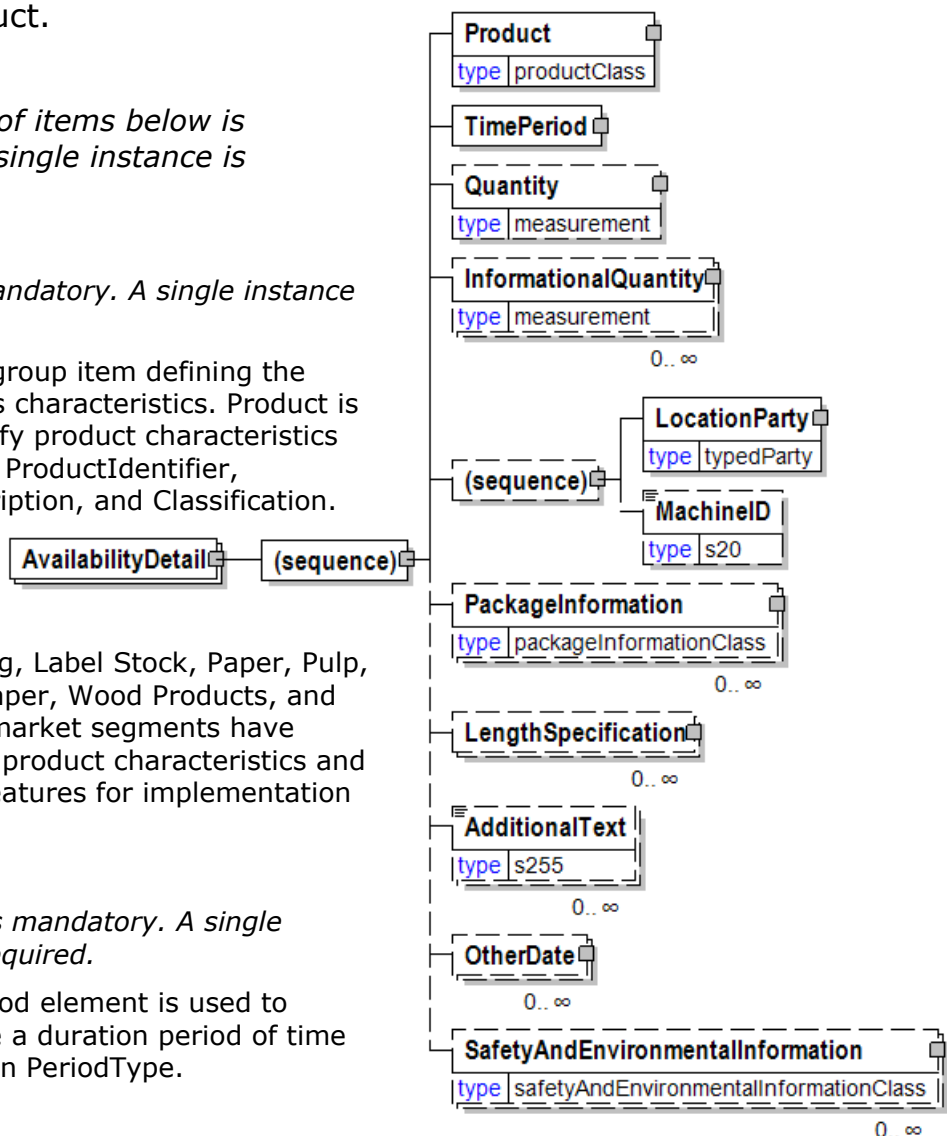

Quantity is optional. A single instance might exist.

The Quantity element contains attributes that provide information about the type of quantity that is being communicated, the context in which the particular quantity is to be viewed, and (if the quantity represents an adjustment) an adjustment type.

The Quantity element contains three child elements that enable you to communicate a range of values for the quantity and a target or actual value. It is at this level (Value, RangeMin, and RangeMax) that the unit of measure is specified. This permits the range to be specified in a different unit of measure than the target.

InformationalQuantity

InformationalQuantity is optional. Multiple instances might exist.

A quantity given in a valid UOM used for information purposes only (not for calculation). For example, an ordered quantity was 100 reels as opposed to the invoice quantity of 20,000 pounds.

(sequence)

The sequence of items below is optional. A single instance might exist.

LocationParty

LocationParty is mandatory. A single instance is required.

The organization or business entity where the business event took place or will take place.

MachineID

MachineID is optional. A single instance might exist.

An identifier assigned to the particular machine being referenced. For example, a machine could be a paper machine, an off-line coater, a sheeter, or a printing press. The particular machine being referenced will be determined by the business event being supported.

PackageInformation

PackageInformation is optional. Multiple instances might exist.

The purpose of the PackageInformation structure is to clearly identify physical handling items that constitute the delivery.

PackageInformation is the highest level of product packaging it describes the shipping or warehousing unit.

If you are communicating a package, usually for logistics or transport purposes, you should include the PackageType, Identifier, ItemCount, and Quantity. (Note: you still have the ability to describe the item with one of the "named" items.)

If you are communicating one of the named Items there is no need to include PackageType, Identifier, ItemCount, and Quantity.

Since either of these two approaches can be used the entire contents of this element are optional even though the parent may be required. It is expected that you will fill in the appropriate details.

LengthSpecification

LengthSpecification is optional. Multiple instances might exist.

Length specification of the wood product.

AdditionalText

AdditionalText is optional. Multiple instances might exist.

papiNet V2R31

A text field that is used to communicate information not previously defined or for special instructions. To be used only for circumstances not covered by specific elements.

OtherDate

OtherDate is optional. Multiple instances might exist.

A date that may not be specifically detailed within a document (example: print date at the PurchaseOrderLineItem).

SafetyAndEnvironmentalInformation

SafetyAndEnvironmentalInformation is optional. Multiple instances might exist.

Name of certification type, if any, on the goods (For example, FSC, PEFC). SafetyAndEnvironmental needs a value or measurement to communicate the percentage of the product is certified (for example, 75% is certified by the indicated agency).

AvailabilityHeader

The AvailabilityHeader contains items that apply to the entire Availability e-Document.

(sequence)

The sequence of items below is mandatory. A single instance is required.

AvailabilityNumber

AvailabilityNumber is mandatory. A single instance is required.

An element that contains the unique identifying number of the Availability e-Document.

AvailabilityIssueDate

AvailabilityIssueDate is mandatory. A single instance is required.

The date and time that the Availability was issued.

RequestNumber

RequestNumber is optional. A single instance might exist.

A unique tracking number specifically identifying the InfoRequest e-Document to the originator. The tracking number is returned with the "information", the answer, to help match the answer to the request.

SenderParty

SenderParty is optional. A single instance might exist.

The business entity issuing the e-Document, the source of the document.

The entity responsible for the content. If the sender party has out sourced the message service to a third party the SenderParty is the issuer of the e-Document and not the party performing the transmission service of the electronic message.

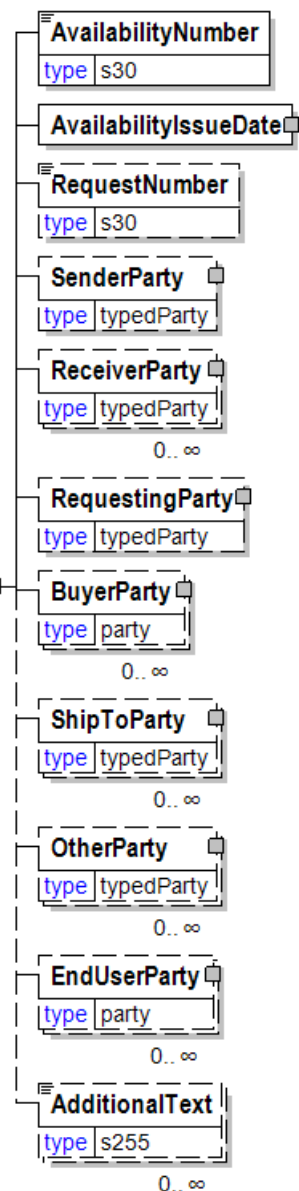

papiNet V2R31

ReceiverParty

ReceiverParty is optional. Multiple instances might exist.

The business entity for whom the e-Document is intended, the destination of the document.

The entity interested in the content. If the receiver party has outsourced the message service to a third party the ReceiverParty is the intended party for the e-Document and not the party performing the receiving service of the electronic message.

RequestingParty

RequestingParty is optional. A single instance might exist.

The party requesting the information.

BuyerParty

BuyerParty is optional. Multiple instances might exist.

The legal entity to which the product is sold. Also commonly referred to as the sold-to party or customer. If no OtherParty is defined as the Payer, the Buyer is the Payer.

ShipToParty

ShipToParty is optional. Multiple instances might exist.

The name and/or address to which the goods should be delivered with the party type indicated by the PartyType attribute.

OtherParty

OtherParty is optional. Multiple instances might exist.

An organisation or business entity other than those specifically detailed within an e-Document.

EndUserParty

EndUserParty is optional. Multiple instances might exist.

The party using, consuming, or converting the product. For example, a printer using paper reels for a print job for a publisher. The final ShipTo destination for a product is normally to the end user's facilities.

AdditionalText

AdditionalText is optional. Multiple instances might exist.

A text field that is used to communicate information not previously defined or for special instructions. To be used only for circumstances not covered by specific elements.

AvailabilityIssueDate

The date and time that the Availability was issued.

(sequence)

The sequence of items below is mandatory. A single instance is required.

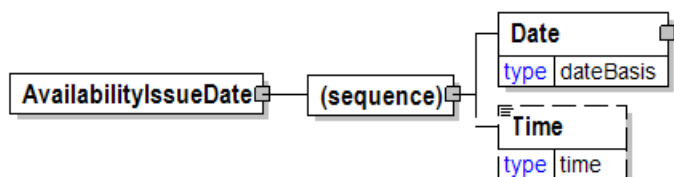

Date

Date is mandatory. A single instance is required.

papiNet V2R31

A group element that contains the specification of Year, Month, and Day.

Time

Time is optional. A single instance might exist.

Times are treated in a standard XML fashion with a special case used to indicate a generalized "local" time. The standard XML approach to time is hh:mm:ss, hh:mm:ssZ, or hh:mm:ss±hh:mm.

hh:mm:ss±hh:mm is used to represent a time with a time zone. The time zone is communicated as the number of hours offset from the Universal Time Coordinate (UTC), a.k.a. Greenwich Mean Time.

hh:mm:ssZ indicates the time at Zulu (another name for UTC).

hh:mm:ss or hh:mm indicates within papiNet the applicable local time where the associated event is taking place. Caution should be used when processing times of this nature as the papiNet approach may be in discord with other users of XML.

AvailabilityNumber

An element that contains the unique identifying number of the Availability e-Document.

AvailabilityNumber	
type	s30

AvailabilityStatusRequestDetail

A grouping element that provides the parameters to be used when responding with an Availability e-Document.

(sequence)

The sequence of items below is mandatory. A single instance is required.

Product

Product is mandatory. A single instance is required.

Product is a group item defining the article and its characteristics. Product is used to specify product

characteristics organized by ProductIdentifier, ProductDescription, and Classification. Book Manufacturing, Label Stock, Paper, Pulp, Recovered Paper, Wood Products, and Virgin Fibre market segments have defined their product characteristics and conversion features for implementation in papiNet.

TimePeriod

TimePeriod is optional. A single instance might exist.

The TimePeriod element is used to communicate a duration period of time as indicated in PeriodType.

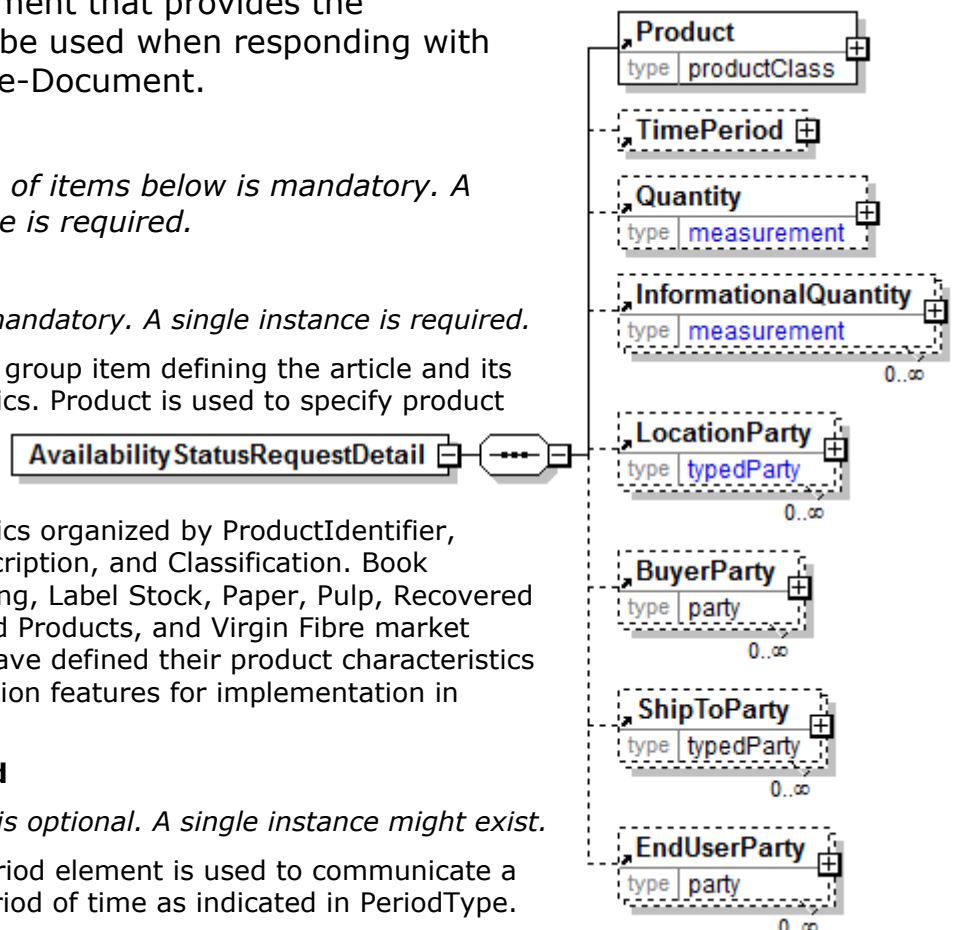

Quantity

Quantity is optional. A single instance might exist.

The Quantity element contains attributes that provide information about the type of quantity that is being communicated, the context in which the particular quantity is to be viewed, and (if the quantity represents an adjustment) an adjustment type.

The Quantity element contains three child elements that enable you to communicate a range of values for the quantity and a target or actual value. It is at this level (Value, RangeMin, and RangeMax) that the unit of measure is specified. This permits the range to be specified in a different unit of measure than the target.

InformationalQuantity

InformationalQuantity is optional. Multiple instances might exist.

A quantity given in a valid UOM used for information purposes only (not for calculation). For example, an ordered quantity was 100 reels as opposed to the invoice quantity of 20,000 pounds.

LocationParty

LocationParty is optional. Multiple instances might exist.

The organization or business entity where the business event took place or will take place.

BuyerParty

BuyerParty is optional. Multiple instances might exist.

The legal entity to which the product is sold. Also commonly referred to as the sold-to party or customer. If no OtherParty is defined as the Payer, the Buyer is the Payer.

ShipToParty

ShipToParty is optional. Multiple instances might exist.

The name and/or address to which the goods should be delivered with the party type indicated by the PartyType attribute.

EndUserParty

EndUserParty is optional. Multiple instances might exist.

The party using, consuming, or converting the product. For example, a printer using paper reels for a print job for a publisher. The final ShipTo destination for a product is normally to the end user's facilities.

b

The “b” component of the method of communicating colour termed L^*a^*b .

(sequence)

The sequence of items below is mandatory. A single instance is required.

DetailValue

DetailValue is mandatory. A single instance is required.

A numeric value expressed in the unit of measure (UOM).

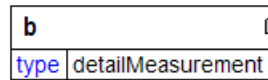

DetailRangeMin

DetailRangeMin is optional. A single instance might exist.

The minimum value (lower boundary) allowed for the DetailValue that is the parent of this element.

DetailRangeMax

DetailRangeMax is optional. A single instance might exist.

The maximum value (upper boundary) allowed for the DetailValue that is the parent of this element.

StandardDeviation

StandardDeviation is optional. A single instance might exist.

A statistic used as a measure of dispersion in a distribution.

SampleSize

SampleSize is optional. A single instance might exist.

The number of samples used to determine the product characteristic in question.

TwoSigmaLower

TwoSigmaLower is optional. A single instance might exist.

Two sigma (a measure of dispersion associated with standard deviation) on the lower side of the standard deviation.

TwoSigmaUpper

TwoSigmaUpper is optional. A single instance might exist.

Two sigma (a measure of dispersion associated with standard deviation) on the upper side of the standard deviation.

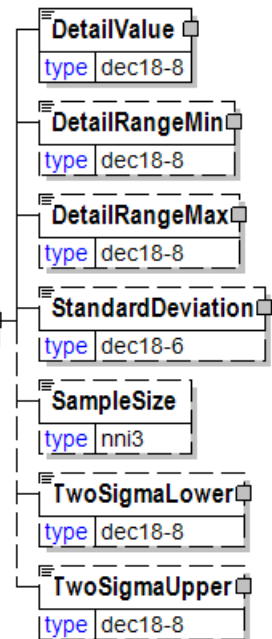

Bale

A single or rectangular grouping of product

BaleType [attribute]

BaleType is mandatory. A single instance is required.

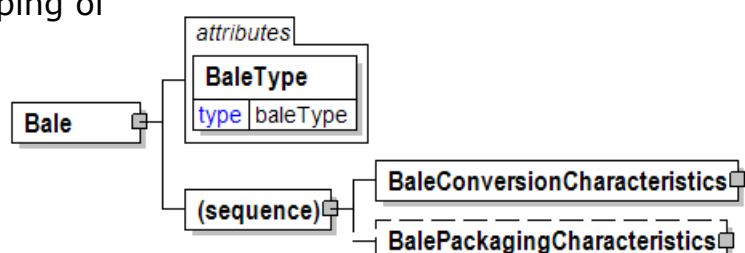

Defines the type of bale being produced. A different production process is indicated by each type.

Refer to BaleType definition for any enumerations.

(sequence)

The sequence of items below is mandatory. A single instance is required.

BaleConversionCharacteristics

BaleConversionCharacteristics is mandatory. A single instance is required.

A group element that contains data relevant to the physical characteristics of a bale of product.

BalePackagingCharacteristics

BalePackagingCharacteristics is optional. A single instance might exist.

A group element containing information relating to packaging of a bale.

BaleCharacteristics

A group item for actual measurement and manufacturing characteristics for a bale.

(sequence)

The sequence of items below is mandatory. A single instance is required.

BaleHeight

BaleHeight is optional. A single instance might exist.

A measurement of one side of the bale, which, in conjunction with the BaleDepth a BaleWidth make up the three measurements of the bale.

BaleWidth

BaleWidth is optional. A single instance might exist.

A measurement of one side of the bale, which, in conjunction with the BaleDepth and BaleHeight make up the three measurements of the bale.

BaleDepth

BaleDepth is optional. A single instance might exist.

A measurement of one side of the bale, in conjunction with BaleHeight and BaleWidth makes up the three measurements of the bale.

DateMade

DateMade is optional. A single instance might exist.

The Date and optionally the Time when an item was produced. DateMade is normally a date before the wrapping and labelling date of the item.

DateFinished

DateFinished is optional. A single instance might exist.

The Date and optionally the Time that an item was finished. For example, this could be the wrapping date for a reel or ream or the date the sheet(s) were packaged in preparation for shipment

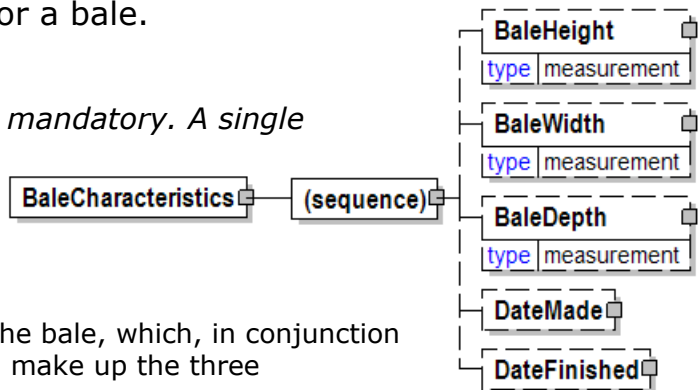

BaleConversionCharacteristics

A group element that contains data relevant to the physical characteristics of a bale of product.

(sequence)

The sequence of items below is mandatory. A single instance is required.

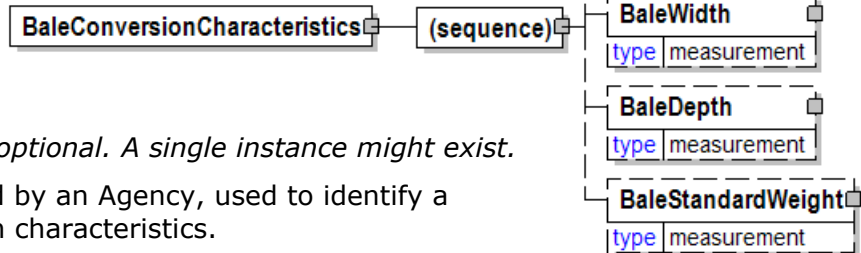

ConversionCode

ConversionCode is optional. A single instance might exist.

A code, as assigned by an Agency, used to identify a group of conversion characteristics.

BaleHeight

BaleHeight is optional. A single instance might exist.

A measurement of one side of the bale, which, in conjunction with the BaleDepth a BaleWidth make up the three measurements of the bale.

BaleWidth

BaleWidth is optional. A single instance might exist.

A measurement of one side of the bale, which, in conjunction with the BaleDepth and BaleHeight make up the three measurements of the bale.

BaleDepth

BaleDepth is optional. A single instance might exist.

A measurement of one side of the bale, in conjunction with BaleHeight and BaleWidth makes up the three measurements of the bale.

BaleStandardWeight

BaleStandardWeight is optional. A single instance might exist.

An individual mill usually produces bales of a target uniform weight to facilitate storage and stowage.

BaleDepth

A measurement of one side of the bale, in conjunction with BaleHeight and BaleWidth makes up the three measurements of the bale.

(sequence)

The sequence of items below is mandatory. A single instance is required.

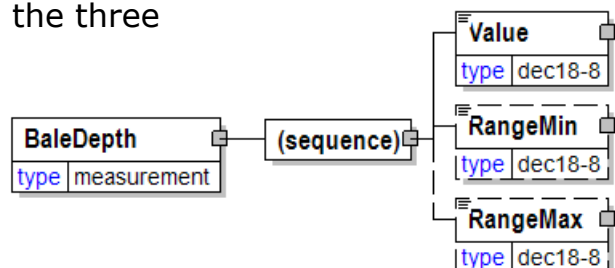

Value

Value is mandatory. A single instance is required.

A numeric value expressed in the unit of measure (UOM).

RangeMin

RangeMin is optional. A single instance might exist.

The minimum value (lower boundary) allowed for the Measurement that is the parent of this element.

RangeMax

RangeMax is optional. A single instance might exist.

The maximum value (upper boundary) allowed for the Measurement that is the parent of this element. Some elements use the RangeMax element with an extended list of unit of measures. (Note: the red colour in the picture is an artifact of how the graphic was captured and should be disregarded.)

BaleHeight

A measurement of one side of the bale, which, in conjunction with the BaleDepth a BaleWidth make up the three measurements of the bale.

(sequence)

The sequence of items below is mandatory. A single instance is required.

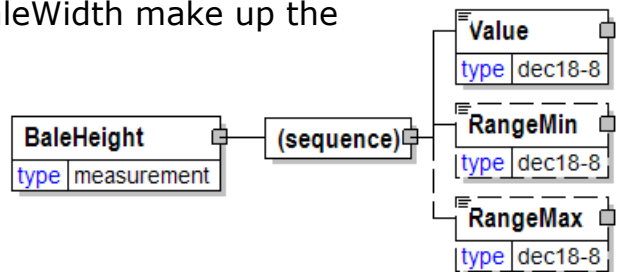

Value

Value is mandatory. A single instance is required.

A numeric value expressed in the unit of measure (UOM).

RangeMin

RangeMin is optional. A single instance might exist.

The minimum value (lower boundary) allowed for the Measurement that is the parent of this element.

RangeMax

RangeMax is optional. A single instance might exist.

The maximum value (upper boundary) allowed for the Measurement that is the parent of this element. Some elements use the RangeMax element with an extended list of unit of measures. (Note: the red colour in the picture is an artifact of how the graphic was captured and should be disregarded.)

BaleItem

An individual bale included as part of a delivery.

(sequence)

The sequence of items below is mandatory. A single instance is required.

Identifier

Identifier is optional. Multiple instances might exist.

An Identifier is required for packages and items (pallets, reel packages, boxes, ream items, reel items, etc). The Identifier element contains the actual item identifier code.

Identifier is repeatable so more than one identifier can be communicated. For example, the printed identifier on a label may be different from the barcode printed on the label.

(choice)

[choice] is optional. A single instance might exist.

(sequence)

The sequence of items below is mandatory. A single instance is required.

PartyIdentifier

PartyIdentifier is mandatory. One instance is required, multiple instances might exist.

A unique identifier of a specific party. This element contains an attribute PartyIdentifierType that indicates the type of the identifier.

MachineID

MachineID is optional. A single instance might exist.

An identifier assigned to the particular machine being referenced. For example, a machine could be a paper machine, an off-line coater, a sheeter, or a printing press. The particular machine being referenced will be determined by the business event being supported.

Product

Product is mandatory. A single instance is required.

Product is a group item defining the article and its characteristics. Product is used to specify product characteristics organized by ProductIdentifier, ProductDescription, and Classification. Book Manufacturing, Label Stock, Paper, Pulp, Recovered Paper, Wood Products, and Virgin Fibre market segments have defined their product characteristics and conversion features for implementation

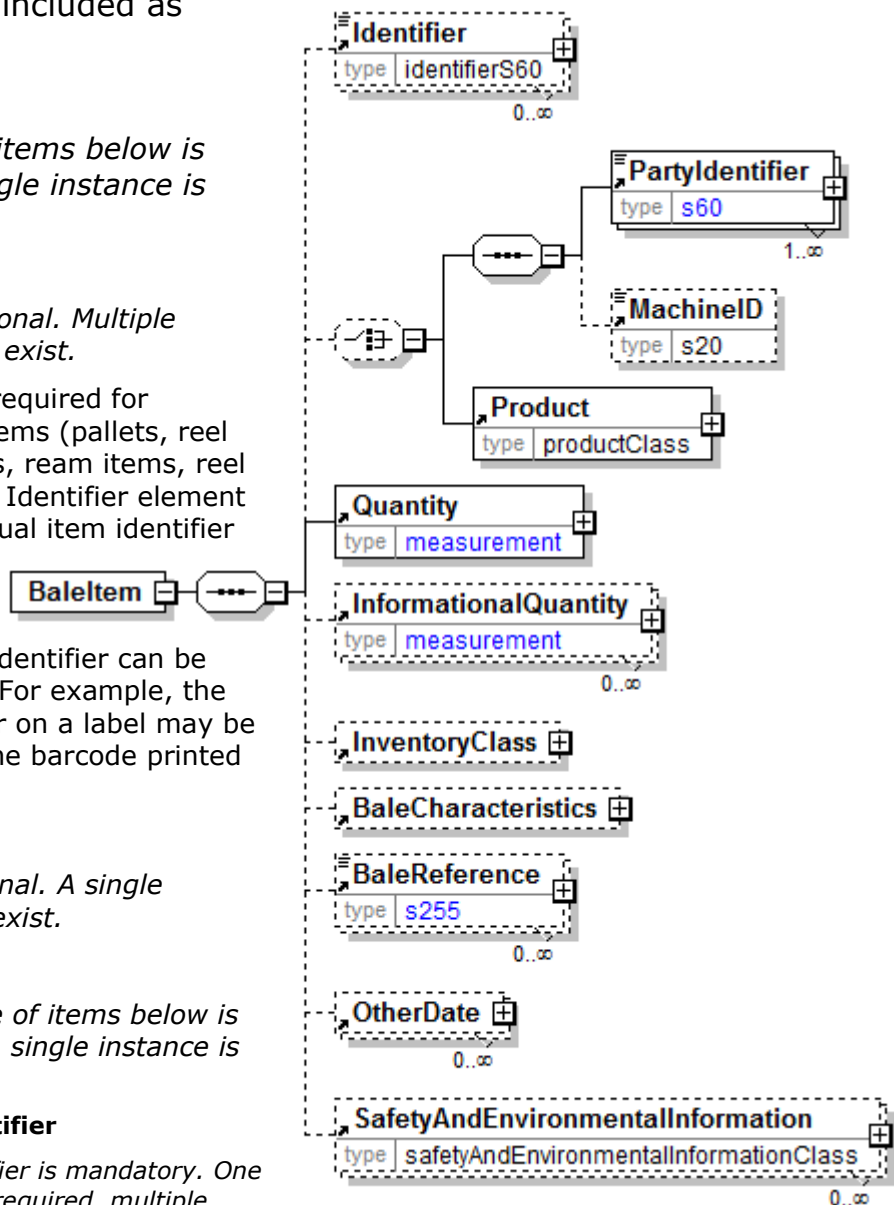

in papiNet.

Quantity

Quantity is mandatory. A single instance is required.

The Quantity element contains attributes that provide information about the type of quantity that is being communicated, the context in which the particular quantity is to be viewed, and (if the quantity represents an adjustment) an adjustment type.

The Quantity element contains three child elements that enable you to communicate a range of values for the quantity and a target or actual value. It is at this level (Value, RangeMin, and RangeMax) that the unit of measure is specified. This permits the range to be specified in a different unit of measure than the target.

InformationalQuantity

InformationalQuantity is optional. Multiple instances might exist.

A quantity given in a valid UOM used for information purposes only (not for calculation). For example, an ordered quantity was 100 reels as opposed to the invoice quantity of 20,000 pounds.

InventoryClass

InventoryClass is optional. A single instance might exist.

A group item containing information about status of inventory and goods items.

BaleCharacteristics

BaleCharacteristics is optional. A single instance might exist.

A group item for actual measurement and manufacturing characteristics for a bale.

BaleReference

BaleReference is optional. Multiple instances might exist.

An element detailing relevant references pertaining to the Bale. The type of reference is identified by the attributes BaleReferenceType and AssignedBy.

OtherDate

OtherDate is optional. Multiple instances might exist.

A date that may not be specifically detailed within a document (example: print date at the PurchaseOrderLineItem).

SafetyAndEnvironmentalInformation

SafetyAndEnvironmentalInformation is optional. Multiple instances might exist.

Name of certification type, if any, on the goods (For example, FSC, PEFC). SafetyAndEnvironmental needs a value or measurement to communicate the percentage of the product is certified (for example, 75% is certified by the indicated agency).

BalePackagingCharacteristics

A group element containing information relating to packaging of a bale.

(sequence)

The sequence of items below is mandatory. A single instance is required.

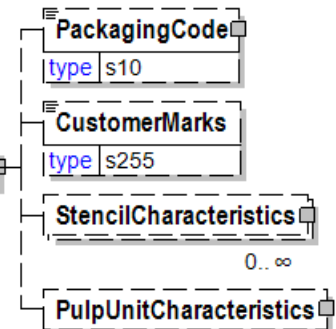

PackagingCode

PackagingCode is optional. A single instance might exist.

PackagingCode is a code describing the packaging of the product.

CustomerMarks

CustomerMarks is optional. A single instance might exist.

The text that the buyer wants the seller to print on the package label or elsewhere.

StencilCharacteristics

StencilCharacteristics is optional. Multiple instances might exist.

A group element specifying attributes of a stencil to be applied to an item, and optional text.

PulpUnitCharacteristics

PulpUnitCharacteristics is optional. A single instance might exist.

A group element that contains information primarily of use for ordering.

BaleReference

An element detailing relevant references pertaining to the Bale. The type of reference is identified by the attributes BaleReferenceType and AssignedBy.

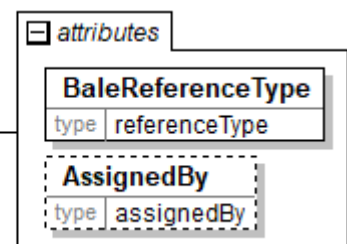
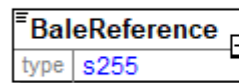

BaleReferenceType [attribute]

BaleReferenceType is mandatory. A single instance is required.

Provides a contextual explanation of the specific reference identifier. Many items are currently prefixed by "Buyer", "Forwarder", "Manufacturer", "Mill", "Seller", "Supplier", "Warehouse", or "Vendor". Check for an existing non-prefixed version and use the non-prefixed version instead. In the (yet to be announced release date) version 3.0 the prefixed versions will be removed. Instead the attribute @AssignedBy will communicate the information previously communicated in the prefix.

Refer to BaleReferenceType definition for any enumerations.

AssignedBy [attribute]

AssignedBy is optional. A single instance might exist.

papiNet V2R31

Identifies the type of party or the agency that has assigned the associated item, e.g. a reference of type OrderNumber.

Refer to AssignedBy for any enumerations.

BaleReferenceType [attribute]

Provides a contextual explanation of the specific reference identifier. Many items are currently prefixed by "Buyer", Forwarder", "Manufacturer", "Mill", "Seller", "Supplier", Warehouse" or Vendor". Check for an existing non-prefixed version and use the non-prefixed version instead. In the (yet to be announced release date) version 3.0 the prefixed versions will be removed. Instead the attribute AssignedBy will communicate the information previously communicated in the prefix.

BaleReferenceType
type referenceType

Refer to the [referenceType](#) entry for the list of enumerations and their definitions.

BalesPerUnit

The number of bales included on the shipping, handling, or delivery unit.

BalesPerUnit
type nni2

BaleStandardWeight

An individual mill usually produces bales of a target uniform weight to facilitate storage and stowage.

(sequence)

The sequence of items below is mandatory. A single instance is required.

BaleStandardWeight
type measurement

(sequence)

Value
type dec18-8
RangeMin
type dec18-8
RangeMax
type dec18-8

Value

Value is mandatory. A single instance is required.

A numeric value expressed in the unit of measure (UOM).

RangeMin

RangeMin is optional. A single instance might exist.

The minimum value (lower boundary) allowed for the Measurement that is the parent of this element.

RangeMax

RangeMax is optional. A single instance might exist.

The maximum value (upper boundary) allowed for the Measurement that is the parent of this element. Some elements use the RangeMax element with an extended list of unit of measures. (Note: the red colour in the picture is an artifact of how the graphic was captured and should be disregarded.)

BaleType [attribute]

Defines the type of bale being produced. A different production process is indicated by each type.

This item is restricted to the following list.

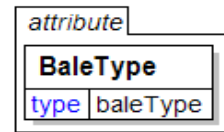

FlashDried

Fibres pressed together to form a bale.

Sheet

A dried and cut product, stacked, pressed, and packaged together.

WetLap

A pressed sheet stacked and usually placed on pallets.

BaleWidth

A measurement of one side of the bale, which, in conjunction with the BaleDepth and BaleHeight make up the three measurements of the bale.

(sequence)

The sequence of items below is mandatory. A single instance is required.

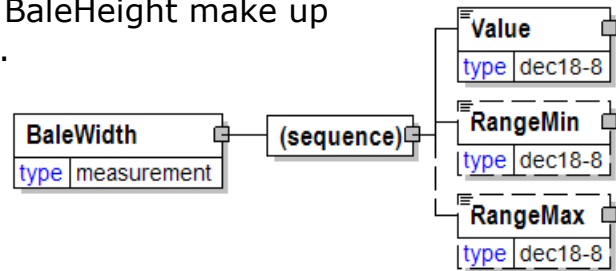

Value

Value is mandatory. A single instance is required.

A numeric value expressed in the unit of measure (UOM).

RangeMin

RangeMin is optional. A single instance might exist.

The minimum value (lower boundary) allowed for the Measurement that is the parent of this element.

RangeMax

RangeMax is optional. A single instance might exist.

The maximum value (upper boundary) allowed for the Measurement that is the parent of this element. Some elements use the RangeMax element with an extended list of unit of measures. (Note: the red colour in the picture is an artifact of how the graphic was captured and should be disregarded.)

BandCharacteristics

A group item that organises the packaging band detail information.

BandType [attribute]

BandType is optional. A single instance might exist.

Communicates the type of band to be used on the product package (metal, nylon, plastic)

Refer to BandType definition for any enumerations.

BandsRequired [attribute]

BandsRequired is optional. A single instance might exist.

Communicates whether or not bands are required or not on the product. When this optional element is not included bands are assumed not to be required.

Refer to BandsRequired definition for any enumerations.

BandDirection [attribute]

BandDirection is optional. A single instance might exist.

The direction of the binding material.

Refer to BandDirection definition for any enumerations.

(sequence)

The sequence of items below is mandatory. A single instance is required.

NumberOfBands

NumberOfBands is optional. A single instance might exist.

The number of bands to be applied to the package.

BandColour

BandColour is optional. Multiple instances might exist.

The colour of the packaging bands to be applied to the package.

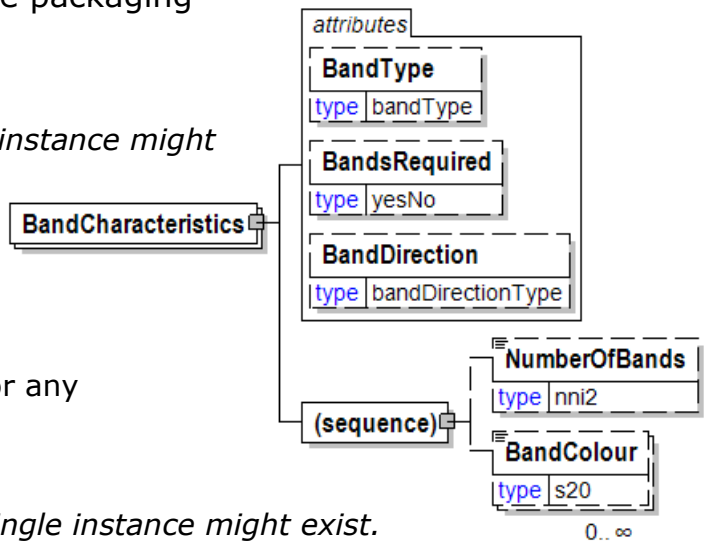

BandColour

The colour of the packaging bands to be applied to the package.

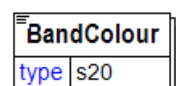

BandDirection [attribute]

The direction of the binding material.

This item is restricted to the following list.

Long

The binding material is on the long side.

Short

The binding material is on the short side.

Both

The binding material is on both the long and the short sides.

attribute	
BandDirection	
type	bandDirectionType

BandLocationType [attribute]

Band location type

This item is restricted to the following list.

Head

The band is located on the top.

Foot

The band is located on the bottom.

Both

The band is located on the top and on the bottom.

None

There is no band.

attribute	
BandLocationType	
type	bandLocationType

BandMaterial

Band material

BandMaterial	
type	s30

BandsRequired [attribute]

Communicates whether or not bands are required or not on the product. When this optional element is not included bands are assumed not to be required.

This item is restricted to the following list.

Yes

No

attribute	
BandsRequired	
type	yesNo

BandType [attribute]

Communicates the type of band to be used on the product package (metal, nylon, plastic)

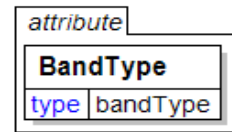

This item is restricted to the following list.

Metal

The band(s) applied to the packaging on the article is/are made of metal.

Nylon

The band(s) applied to the packaging on the article is/are made of nylon.

Plastic

The band(s) applied to the packaging on the article is/are made of plastic.

Standard

The bands used are agreed to by the trading partners involved.

BarcodeSuppliedByPublisher [attribute]

Barcode supplied by publisher

This item is restricted to the following list.



Yes

No

Bark

Used to report bark content in chips as a detail measurement.

TestMethod [attribute]

TestMethod is optional. A single instance might exist.

The method used to determine the results of the test under consideration.

TestAgency [attribute]

TestAgency is optional. A single instance might exist.

The agency that has set the parameters for the testing

Refer to TestAgency definition for any enumerations.

SampleType [attribute]

SampleType is optional. A single instance might exist.

Communicates how sampling was done to measure the product characteristics.

Refer to SampleType definition for any enumerations.

ResultSource [attribute]

ResultSource is optional. A single instance might exist.

Used to define the data source of the specified test

Refer to ResultSource definition for any enumerations.

(sequence)

The sequence of items below is mandatory. A single instance is required.

DetailValue

DetailValue is mandatory. A single instance is required.

A numeric value expressed in the unit of measure (UOM).

DetailRangeMin

DetailRangeMin is optional. A single instance might exist.

The minimum value (lower boundary) allowed for the DetailValue that is the parent of this element.

DetailRangeMax

DetailRangeMax is optional. A single instance might exist.

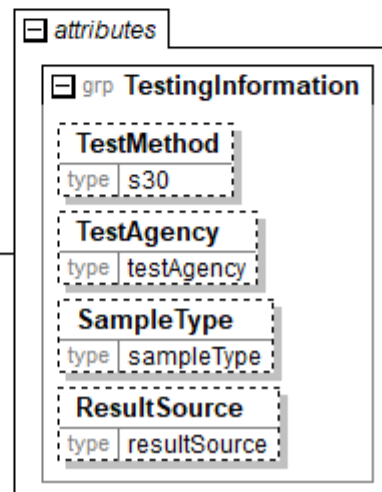
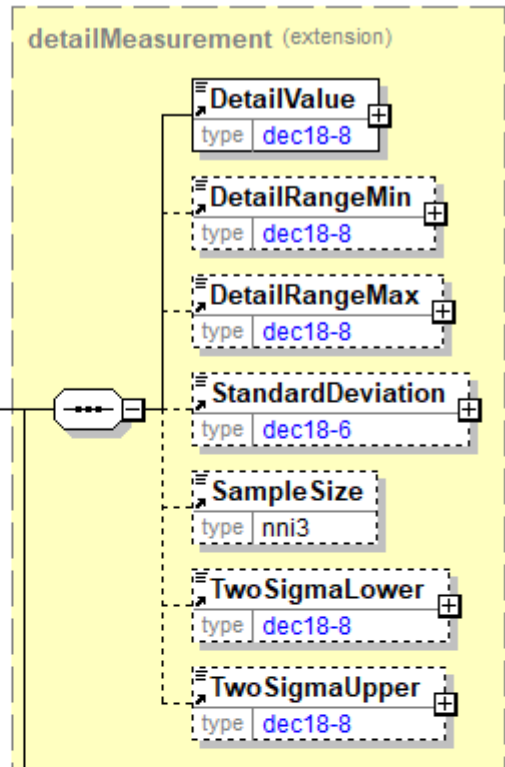

papiNet V2R31

The maximum value (upper boundary) allowed for the DetailValue that is the parent of this element.

StandardDeviation

StandardDeviation is optional. A single instance might exist.

A statistic used as a measure of dispersion in a distribution.

SampleSize

SampleSize is optional. A single instance might exist.

The number of samples used to determine the product characteristic in question.

TwoSigmaLower

TwoSigmaLower is optional. A single instance might exist.

Two sigma (a measure of dispersion associated with standard deviation) on the lower side of the standard deviation.

TwoSigmaUpper

TwoSigmaUpper is optional. A single instance might exist.

Two sigma (a measure of dispersion associated with standard deviation) on the upper side of the standard deviation.

BaseAmountInfo

A grouping element that contains information about price and base amount without any taxes.

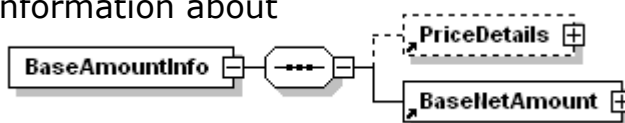

(sequence)

The sequence of items below is mandatory. A single instance is required.

PriceDetails

PriceDetails is optional. A single instance might exist.

An element that groups together price information.

BaseNetAmount

BaseNetAmount is mandatory. A single instance is required.

An element that contains the result of the calculation Quantity times the PricePerUnit. As such it does not include any taxes. The BaseNetAmount encapsulates CurrencyValue.

BaseNetAmount

An element that contains the result of the calculation Quantity times the PricePerUnit. As such it does not include any taxes. The BaseNetAmount encapsulates CurrencyValue.

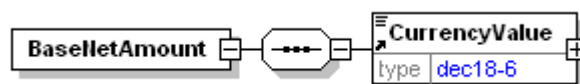

(sequence)

The sequence of items below is mandatory. A single instance is required.

CurrencyValue

papiNet V2R31

CurrencyValue is mandatory. A single instance is required.

The amount in the referenced currency as defined by the CurrencyType attribute.

BasisWeight

The weight of the paper expressed as a mass for a given surface area. In countries using the metric system, the basis weight is expressed as the weight in grams of one sheet of paper that is one square meter in area—not dependent on basic sheet size. In countries using the imperial system, the weight is expressed in pounds for a given ProductBasisSizeType.

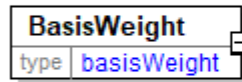

TestMethod [attribute]

TestMethod is optional. A single instance might exist.

The method used to determine the results of the test under consideration.

TestAgency [attribute]

TestAgency is optional. A single instance might exist.

The agency that has set the parameters for the testing

Refer to TestAgency definition for any enumerations.

SampleType [attribute]

SampleType is optional. A single instance might exist.

Communicates how sampling was done to measure the product characteristics.

Refer to SampleType definition for any enumerations.

ResultSource [attribute]

ResultSource is optional. A single instance might exist.

Used to define the data source of the specified test

Refer to ResultSource definition for any enumerations.

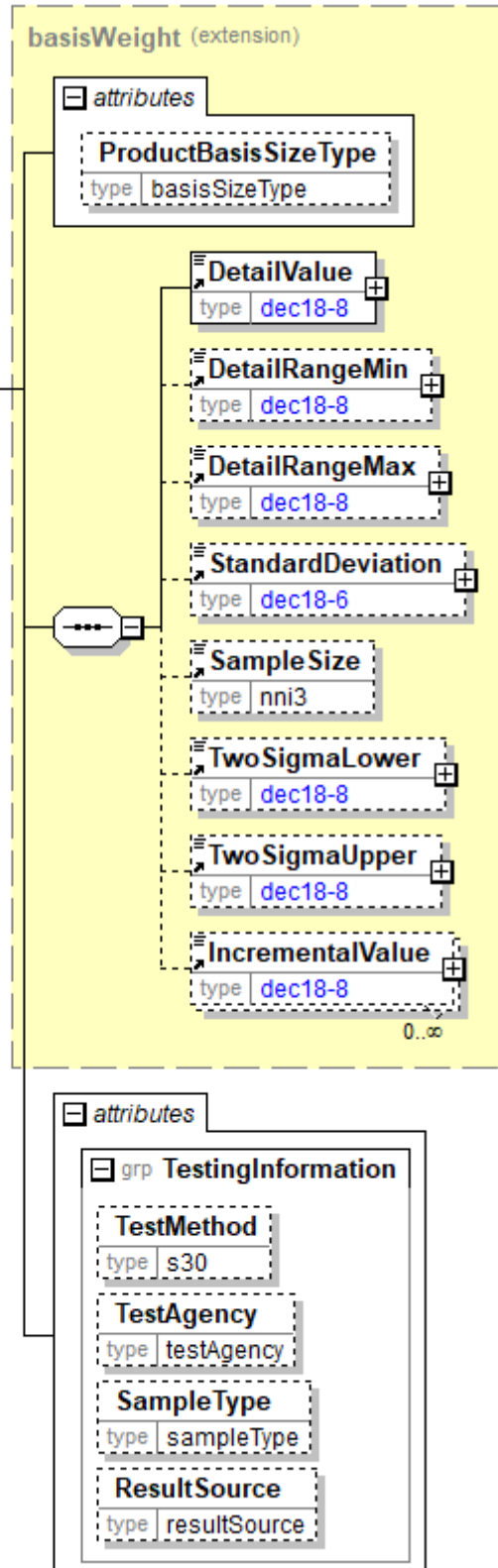

ProductBasisSizeType [attribute]

ProductBasisSizeType is optional. A single instance might exist.

An attribute list that indicates the size of paper used as the base for the basis weight calculation

Refer to ProductBasisSizeType definition for any enumerations.

(sequence)

The sequence of items below is mandatory. A single instance is required.

DetailValue

DetailValue is mandatory. A single instance is required.

A numeric value expressed in the unit of measure (UOM).

DetailRangeMin

DetailRangeMin is optional. A single instance might exist.

The minimum value (lower boundary) allowed for the DetailValue that is the parent of this element.

DetailRangeMax

DetailRangeMax is optional. A single instance might exist.

The maximum value (upper boundary) allowed for the DetailValue that is the parent of this element.

StandardDeviation

StandardDeviation is optional. A single instance might exist.

A statistic used as a measure of dispersion in a distribution.

SampleSize

SampleSize is optional. A single instance might exist.

The number of samples used to determine the product characteristic in question.

TwoSigmaLower

TwoSigmaLower is optional. A single instance might exist.

Two sigma (a measure of dispersion associated with standard deviation) on the lower side of the standard deviation.

TwoSigmaUpper

TwoSigmaUpper is optional. A single instance might exist.

Two sigma (a measure of dispersion associated with standard deviation) on the upper side of the standard deviation.

IncrementalValue

IncrementalValue is optional. Multiple instances might exist.

Many times paper is produce in BasisWeights of discreet values. This element permits the expression of those increments.

BasisWeightVariation

BasisWeightVariation is the measured difference between the mill target basis weight and the mill actual basis weight.

(sequence)

The sequence of items below is mandatory. A single instance is required.

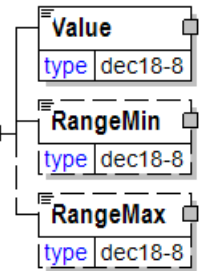
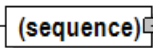
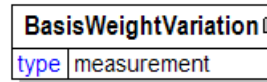

Value

Value is mandatory. A single instance is required.

A numeric value expressed in the unit of measure (UOM).

RangeMin

RangeMin is optional. A single instance might exist.

The minimum value (lower boundary) allowed for the Measurement that is the parent of this element.

RangeMax

RangeMax is optional. A single instance might exist.

The maximum value (upper boundary) allowed for the Measurement that is the parent of this element. Some elements use the RangeMax element with an extended list of unit of measures. (Note: the red colour in the picture is an artifact of how the graphic was captured and should be disregarded.)

BendingResistance

Bending resistance

TestMethod [attribute]

TestMethod is optional. A single instance might exist.

The method used to determine the results of the test under consideration.

TestAgency [attribute]

TestAgency is optional. A single instance might exist.

The agency that has set the parameters for the testing

Refer to TestAgency definition for any enumerations.

SampleType [attribute]

SampleType is optional. A single instance might exist.

Communicates how sampling was done to measure the product characteristics.

Refer to SampleType definition for any enumerations.

ResultSource [attribute]

ResultSource is optional. A single instance might exist.

Used to define the data source of the specified test

Refer to ResultSource definition for any enumerations.

(sequence)

The sequence of items below is mandatory. A single instance is required.

DetailValue

DetailValue is mandatory. A single instance is required.

A numeric value expressed in the unit of measure (UOM).

DetailRangeMin

DetailRangeMin is optional. A single instance might exist.

The minimum value (lower boundary) allowed for the DetailValue that is the parent of this element.

DetailRangeMax

DetailRangeMax is optional. A single instance might exist.

The maximum value (upper boundary) allowed for the DetailValue that is the

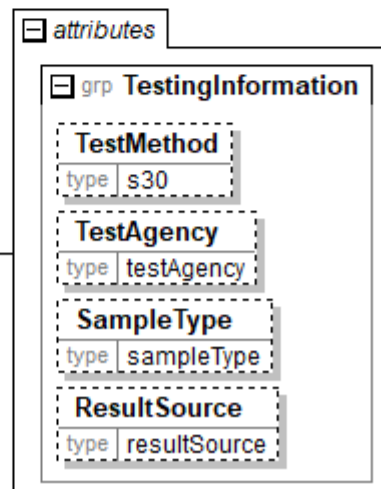
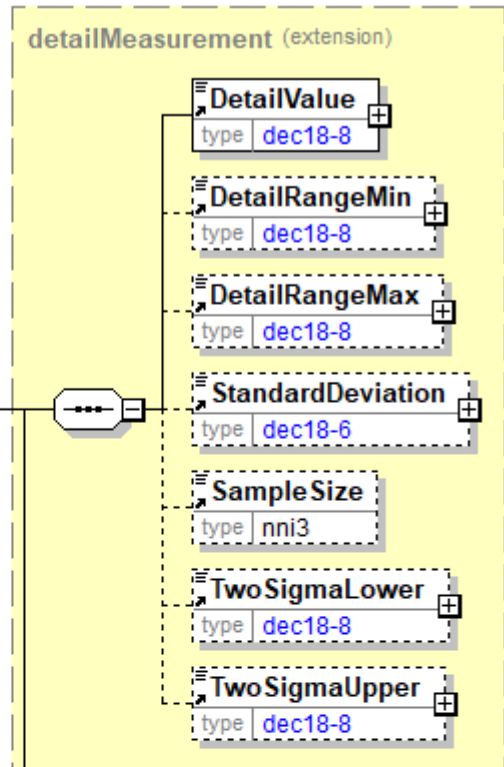

parent of this element.

StandardDeviation

StandardDeviation is optional. A single instance might exist.

A statistic used as a measure of dispersion in a distribution.

SampleSize

SampleSize is optional. A single instance might exist.

The number of samples used to determine the product characteristic in question.

TwoSigmaLower

TwoSigmaLower is optional. A single instance might exist.

Two sigma (a measure of dispersion associated with standard deviation) on the lower side of the standard deviation.

TwoSigmaUpper

TwoSigmaUpper is optional. A single instance might exist.

Two sigma (a measure of dispersion associated with standard deviation) on the upper side of the standard deviation.

BendingStiffness

BendingStiffness

TestMethod [attribute]

TestMethod is optional. A single instance might exist.

The method used to determine the results of the test under consideration.

TestAgency [attribute]

TestAgency is optional. A single instance might exist.

The agency that has set the parameters for the testing

Refer to TestAgency definition for any enumerations.

SampleType [attribute]

SampleType is optional. A single instance might exist.

Communicates how sampling was done to measure the product characteristics.

Refer to SampleType definition for any enumerations.

ResultSource [attribute]

ResultSource is optional. A single instance might exist.

Used to define the data source of the specified test

Refer to ResultSource definition for any enumerations.

(sequence)

The sequence of items below is mandatory. A single instance is required.

DetailValue

DetailValue is mandatory. A single instance is required.

A numeric value expressed in the unit of measure (UOM).

DetailRangeMin

DetailRangeMin is optional. A single instance might exist.

The minimum value (lower boundary) allowed for the DetailValue that is the parent of this element.

DetailRangeMax

DetailRangeMax is optional. A single instance might exist.

The maximum value (upper boundary) allowed for the DetailValue that is the

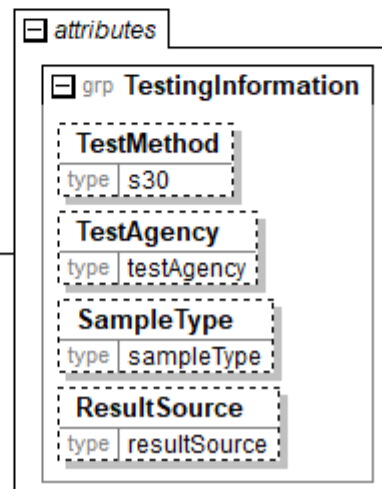
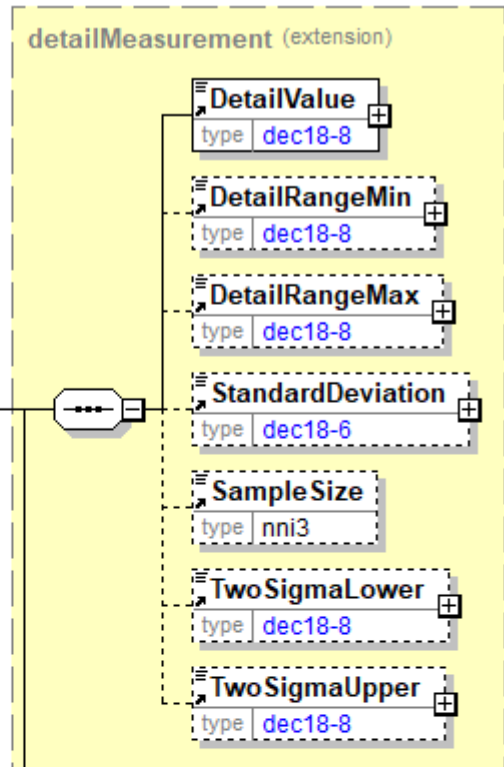

parent of this element.

StandardDeviation

StandardDeviation is optional. A single instance might exist.

A statistic used as a measure of dispersion in a distribution.

SampleSize

SampleSize is optional. A single instance might exist.

The number of samples used to determine the product characteristic in question.

TwoSigmaLower

TwoSigmaLower is optional. A single instance might exist.

Two sigma (a measure of dispersion associated with standard deviation) on the lower side of the standard deviation.

TwoSigmaUpper

TwoSigmaUpper is optional. A single instance might exist.

Two sigma (a measure of dispersion associated with standard deviation) on the upper side of the standard deviation.

BestBeforeDate

The date, prior to which, the product is suggested to be used.

(sequence)

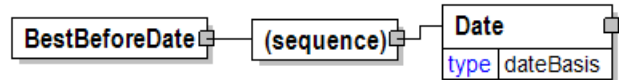

The sequence of items below is mandatory. A single instance is required.

Date

Date is mandatory. A single instance is required.

A group element that contains the specification of Year, Month, and Day.

Billable [attribute]

Either "Yes" or "No".

This item is restricted to the following list.

Yes

No



BillOfMaterials

A specification of the components and other items that are used to produce the item in question.

(sequence)

The sequence of items below is mandatory. One instance is required, multiple instances might exist.

ProductIdentifier

ProductIdentifier is mandatory. A single instance is required.

Used to communicate the code of the article, in a variety of formats designated by the type.

ProductDescription

ProductDescription is optional. Multiple instances might exist.

An element used to communicate a human readable description of the product in the language specified by the Language attribute.

Quantity

Quantity is optional. A single instance might exist.

The Quantity element contains attributes that provide information about the type of quantity that is being communicated, the context in which the particular quantity is to be viewed, and (if the quantity represents an adjustment) an adjustment type.

The Quantity element contains three child elements that enable you to communicate a range of values for the quantity and a target or actual value. It is at this level (Value, RangeMin, and RangeMax) that the unit of measure is specified. This permits the range to be specified in a different unit of measure than the target.

BookClassification

BookClassification is optional. Multiple instances might exist.

Category under which the product or a component within the product is classified.

SpecReference

SpecReference is optional. Multiple instances might exist.

Used to identify any external or associated documents, identifiers, etc.

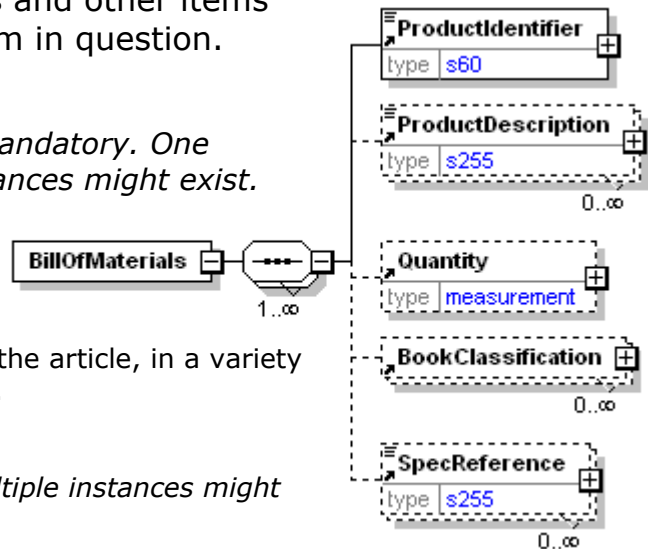

BillToParty

The address where the Invoice is to be sent.

LogisticsRole [attribute]

LogisticsRole is optional. A single instance might exist.

Communicates the nature of the logistics role, if any, the party plays in the transaction.

Refer to LogisticsRole definition for any enumerations.

(sequence)

The sequence of items below is mandatory. A single instance is required.

PartyIdentifier

PartyIdentifier is optional. Multiple instances might exist.

A unique identifier of a specific party. This element contains an attribute PartyIdentifierType that indicates the type of the identifier.

NameAddress

NameAddress is mandatory. A single instance is required.

A group item containing name and address of an organisation or business entity.

URL

URL is optional. A single instance might exist.

Universal Resource Locator. While typically a web address you could use this field to hold an email address.

CommonContact

CommonContact is optional. Multiple instances might exist.

Identifies a specific individual associated with the party.

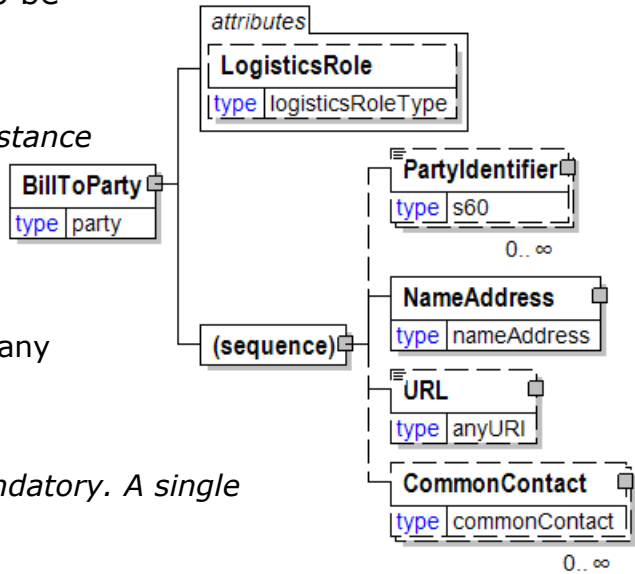

BinaryValue

A value in base-64-encoded binary format.

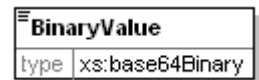

BindingBackingType [attribute]

Specifies the shape of the book spine during the binding operation.

This item is restricted to the following list.

Round

Spine shape is rounded before cover is applied; used primarily for hardcover books.



Flat

Spine shape is flattened before cover is applied, used primarily for softcover books.

BindingBackStyleType [attribute]

Specifies that the book cover is either attached or detached from the spine.

This item is restricted to the following list.

Tight

Specifies the book cover is attached to the spine.

Loose

Specifies the book cover is detached from the spine.



BindingCoverScoring [attribute]

Indicates if scoring of the front cover close to the spine allowing the cover to easily stay open is required.

This item is restricted to the following list.

Yes

Scoring is required.

No

Scoring is not required.

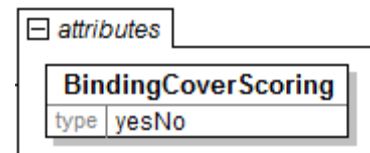

BindingExtras

Binding extras

EdgeLocationType [attribute]

EdgeLocationType is optional. A single instance might exist.

Edge location type.

Refer to EdgeLocationType definition for any enumerations.

(sequence)

The sequence of items below is mandatory. A single instance is required.

BindingExtrasDescription

BindingExtrasDescription is mandatory. A single instance is required.

Binding Extras Description

Quantity

Quantity is optional. A single instance might exist.

The Quantity element contains attributes that provide information about the type of quantity that is being communicated, the context in which the particular quantity is to be viewed, and (if the quantity represents an adjustment) an adjustment type.

The Quantity element contains three child elements that enable you to communicate a range of values for the quantity and a target or actual value. It is at this level (Value, RangeMin, and RangeMax) that the unit of measure is specified. This permits the range to be specified in a different unit of measure than the target.

UnitCharacteristics

UnitCharacteristics is optional. A single instance might exist.

Unit characteristics.

BindingMaterialCharacteristics

BindingMaterialCharacteristics is optional. Multiple instances might exist.

Binding Material Characteristics

AdditionalText

AdditionalText is optional. Multiple instances might exist.

A text field that is used to communicate information not previously defined or for special instructions. To be used only for circumstances not covered by specific elements.

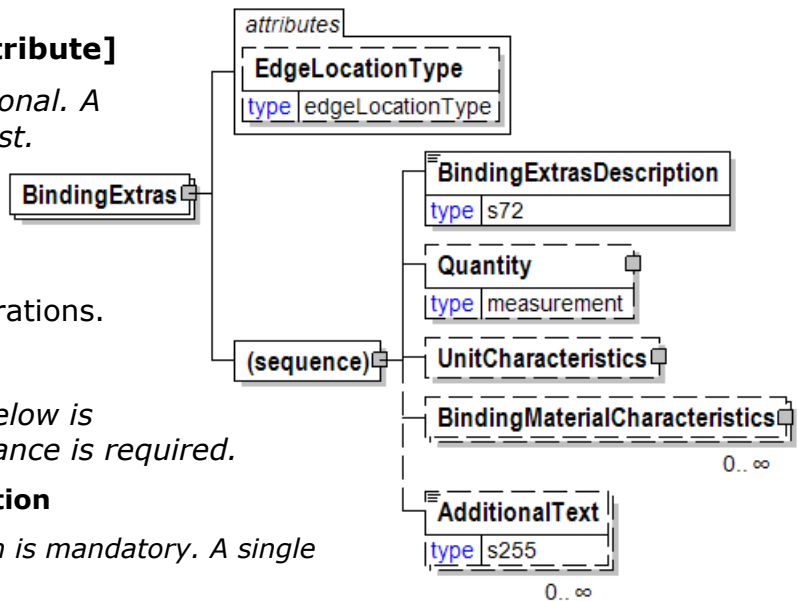

BindingExtrasDescription

Binding Extras Description

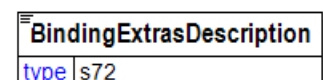

BindingMaterialCharacteristics

Binding Material Characteristics

FinishType [attribute]

FinishType is optional. A single instance might exist.

Defines the finish of a sheet of paper, which means the condition of its surface (refer to Embossing for more information).

Finishes may be produced on or off machine. Finishes that are created off-machine are called embossed. (Embossing is a child element of ReelConversionCharacteristics and SheetConversionCharacteristics.)

Note:

Embossed" as a finish type is just a generalized choice for one of the more specific choices listed.

Unsupercalendered" as a finish type would be indicated by not communicating a finish type.

Refer to FinishType definition for any enumerations.

(sequence)

The sequence of items below is mandatory. A single instance is required.

BindingMaterialDescription

BindingMaterialDescription is mandatory. A single instance is required.

Specifications for the materials used in binding.

BasisWeight

BasisWeight is optional. A single instance might exist.

The weight of the paper expressed as a mass for a given surface area. In countries using the metric system, the basis weight is expressed as the weight in grams of one sheet of paper that is one square meter in area—not dependent on basic sheet size. In countries using the imperial system, the weight is expressed in pounds for a given ProductBasisSizeType.

ColourCode

ColourCode is optional. A single instance might exist.

A code indicating the colour.

ColourDescription

ColourDescription is optional. A single instance might exist.

A free form description of the colour.

ProductIdentification

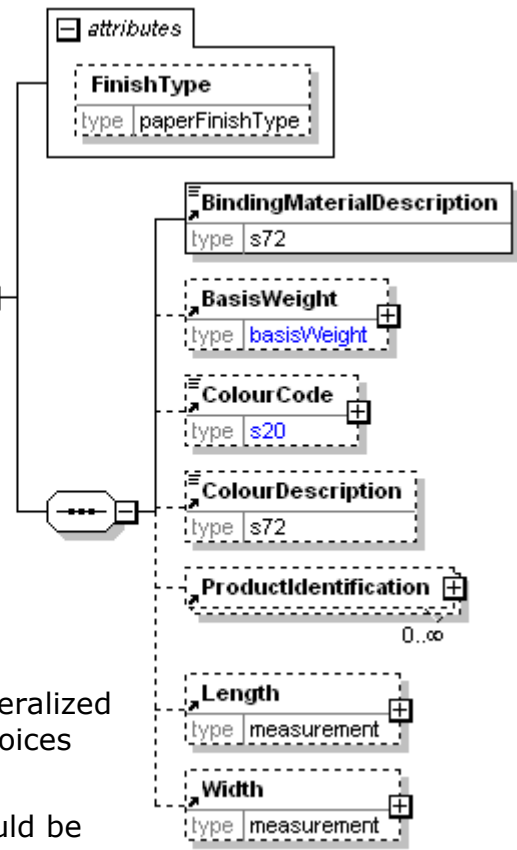

ProductIdentification is optional. Multiple instances might exist.

A grouping element designed to communicate product identification related to the parent element that contains this item.

Length

Length is optional. A single instance might exist

The length of the object.

Width

Width is optional. A single instance might exist

The width of the object.

BindingMaterialDescription

Specifications for the materials used in binding.

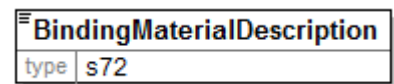

BindingReinforcement [attribute]

Specifies if spine reinforcement materials are included in the binding operation.

This item is restricted to the following list.

Yes

Reinforcement materials are required.

No

Reinforcement materials are not required.

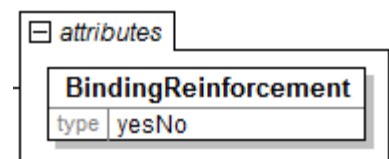

BindingRibbon [attribute]

Specifies if a ribbon (bookmark) is to be included in the binding.

This item is restricted to the following list.

Yes

Ribbons are included.

No

Ribbons are not included.

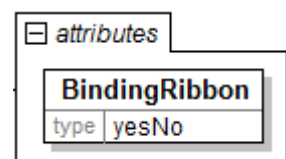

BindingStyleType [attribute]

Indicates the style of binding used.

This item is restricted to the following list.

Accordion

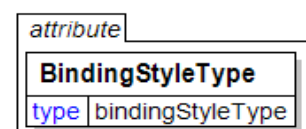

papiNet V2R31

Pages of the book are formed by folding the paper in zig-zag form and the cover is applied to each end; this type of binding allows the book to stand firmly on the head or foot edges.

Adhesive

Type of binding in which single leaves are secured together solely with an adhesive applied to the spine.

AdhesiveBurst

A line of slots is cut from the spine at the fold so that the glue adheres to the cut edge of each slot; sections are not milled before gluing.

Will be deprecated in a future version V3R00.

AdhesiveSewn

Softcover book where the pages are sewn prior to the cover being applied using with adhesives.

BoardBook

Cover and pages of the book printed on thick paperboard.

BookLock

Alternating left-right perforations along the sides of the spine, the alternating protruding flaps along the spine when the signature is folded and the casting of these alternating flaps into the spine glue.

Burst

The spine of each section is slotted or perforated during the folding operation. Glue is pushed up between the perforations during binding and the cover is then drawn on.

CombinationBinding

Will be deprecated in a future version V3R00.

Custom

Highly stylized binding in an unusual way compared to standard manufacturing.

Durasew

Will be deprecated in a future version V3R00.

FlexiBind

A system for binding books includes a flexible binding material in the form of a stud having top and bottom caps.

IMS

Will be deprecated in a future version V3R00.

LayFlatSoft

Will be deprecated in a future version V3R00.

See [LayFlatBind](#)

LayflatBind

Softcover book where the cover is glued only to the sides of the spine so that

the book can lay flat when open. A strip of gauze is glued to the spine edge of the book block to hold the signatures or pages together.

LooseLeaf

Consisting of loose leaves (pages), often collected in a binder, rather than being bound like a book or stap.

McCainSideSewn

Brand Name of the machine used for Sidesewn bookbinding; see SideSewn
Will be deprecated in a future version V3R00.

Notch

The gouging of grooves (commonly G inch wide) in the spine of a book block to facilitate the penetration of adhesive during subsequent perfect binding.

Pad

A number of sheets of paper fastened together along one edge.

Patent

Will be deprecated in a future version V3R00.

PerfectAdhesive

Will be deprecated in a future version V3R00.

See PerfectBound

PerfectBound

A process in which the binding edge of the folded sections of a book are trimmed (to separate the leaves) before being glued to the cover's spine.

PlasticComb

Mechanical binding in which the pages are bound together by means of a plastic comb consisting of a plastic strip off which extend a series of curved plastic prongs, which are inserted into drilled or punched holes along the binding edge of the pages.

Repkover

Brand Name of the machine used for layflat bookbinding; see LayflatBind
Will be deprecated in a future version V3R00.

Ring

Binding technique where the book block is trimmed on all four sides, punched or drilled at one edge and inserted into two or more metal rings held inside a stiff cover.

RoundBound

Will be deprecated in a future version V3R00.

SaddleStitch

Method of binding a small booklet by stitching it through the center fold of the sheets that comprise its pages; stitching materials can be regular binding thread, saddle wire, or staples.

SaddleWire

papiNet V2R31

SaddleStitch binding using wire staples.

SelfCover

Will be deprecated in a future version V3R00.

SemiConcealedWireO

WireO binding where the wire is partially visible in the spine of the book.

SideSewn

Compiled signatures are sewn together with stitches running top down through the book block and parallel to the binding edge.

Sidewire

Stapling through the sides of the folded sheets.

SmythSewn

Brand name for ThreadSewing equipment: see ThreadSewn.

Spiral

A continuous wire or plastic coil is threaded through holes drilled or punched along the binding side of the book including the separate front and back covers.

SpiralHardFrontHardBack

Spiral binding with separate case covers on the front and back of the book.

SpiralSoftFrontHardBack

Spiral binding with a soft /paper cover on the front and a case cover on the back.

SpiralSoftFrontSoftBack

Spiral binding with separate soft /paper covers on the front and back

SquareBackSaddleWire

Saddlewire binding method where the spine is flattened rather than folded.

Thermal

Binding method that uses a one piece cover with glue down the spine to quickly and easily bind documents.

Threadseal

The spine of each individual signature is stitched or stapled with a plastic coated thread, then the threads are sealed with an application of heat.

ThreadSewn

Binding process where all of the signatures are sewn individually together with threads going through each page several times.

Trim4SideDrill

All 4 sides of the book block are trimmed and then holepunched.

Will be deprecated in a future version V3R00.

TrimFourSides

All 4 sides of the book block are trimmed.

Will be deprecated in a future version V3R00.

UltraFan

Will be deprecated in a future version V3R00.

WireO

Punch-and-bind spiral wire binding where there are twin-loops of wire as opposed to single-loop in typical spiral binding.

WireOConcealed

WireO binding where the wire is concealed in the spine of the book

Other

BindingType [attribute]

Identifies the primary binding category of the book.

This item is restricted to the following list.

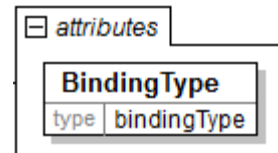

Hardcover

Method of binding where the pages are bound between rigid boards covered in cloth, paper, leather, or film.

Softcover

Having covers made of paper or thin cardboard.

Layflat

Method of perfect binding that allows a publication to lie fully open.

Loose

Finished product consists of loose pages or signatures rather than bound; example is a packet of loose leaf pages that are drilled for insertion into a ring binder.

Mechanical

Method of binding which secures pre-trimmed leaves by the insertion of wire or plastic spirals through holes drilled in the binding edge.

Self

Method of binding where the cover is comprised of the outside pages of the text.

Black

The Black component of a colour.

(sequence)

The sequence of items below is mandatory. A single instance is required.

DetailValue

DetailValue is mandatory. A single instance is required.

A numeric value expressed in the unit of measure (UOM).

DetailRangeMin

DetailRangeMin is optional. A single instance might exist.

The minimum value (lower boundary) allowed for the DetailValue that is the parent of this element.

DetailRangeMax

DetailRangeMax is optional. A single instance might exist.

The maximum value (upper boundary) allowed for the DetailValue that is the parent of this element.

StandardDeviation

StandardDeviation is optional. A single instance might exist.

A statistic used as a measure of dispersion in a distribution.

SampleSize

SampleSize is optional. A single instance might exist.

The number of samples used to determine the product characteristic in question.

TwoSigmaLower

TwoSigmaLower is optional. A single instance might exist.

Two sigma (a measure of dispersion associated with standard deviation) on the lower side of the standard deviation.

TwoSigmaUpper

TwoSigmaUpper is optional. A single instance might exist.

Two sigma (a measure of dispersion associated with standard deviation) on the upper side of the standard deviation.

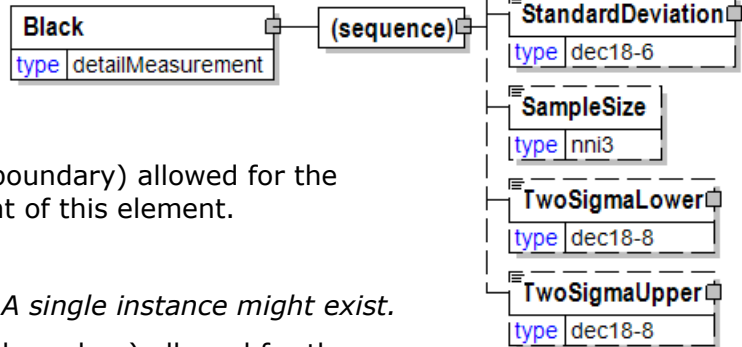

Blanket

Blanket is a group element that contains elements that describe this component of the printing process.

(sequence)

The sequence of items below is mandatory. A single instance is required.

BlanketType

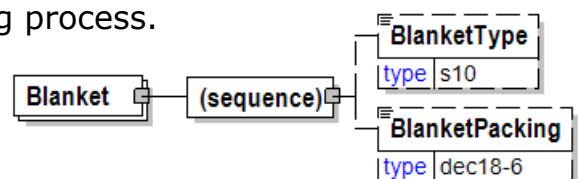

papiNet V2R31

BlanketType is optional. A single instance might exist.

Rubber coated pad mounted on the cylinder of an offset press that receives the inked image and transfers it to the print surface.

BlanketPacking

BlanketPacking is optional. A single instance might exist.

The thickness of the paper that is placed between the cylinder and the blanket to obtain the proper pressure for printing. Usually this ranges from .010 to .008 inches.

BlanketPacking

The thickness of the paper that is placed between the cylinder and the blanket to obtain the proper pressure for printing. Usually this ranges from .010 to .008 inches.

BlanketPacking	
type	dec18-6

BlanketType

Rubber coated pad mounted on the cylinder of an offset press that receives the inked image and transfers it to the print surface.

BlanketType	
type	s10

BleachingProcess [attribute]

Communicates the type of bleaching process used to make the pulp fibre

This item is restricted to the following list.

ChlorineBleached

The product is bleached using chlorine.

ElementaryChlorineFree

The product is bleached using a process that does not use chlorine in its basic or elementary form.

TotallyChlorineFree

The product is bleached using a process that does not use chlorine in either its basic (elementary form) or in its bound (compound form),

Unbleached

The product has not gone through a bleaching process.

attribute	
BleachingProcess	
type	bleachingProcess

Bleed [attribute]

Specifies if the printing of an illustration, design, or text to the edge of the page.

This item is restricted to the following list.

Yes

attributes	
Bleed	
type	yesNo

Bleeds are present in the printing.

No

Bleeds are not present in the printing.

Blue

The "Blue" portion of the method of representing colour termed RGB.

(sequence)

The sequence of items below is mandatory. A single instance is required.

DetailValue

DetailValue is mandatory. A single instance is required.

A numeric value expressed in the unit of measure (UOM).

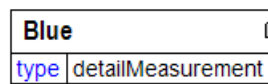

DetailRangeMin

DetailRangeMin is optional. A single instance might exist.

The minimum value (lower boundary) allowed for the DetailValue that is the parent of this element.

DetailRangeMax

DetailRangeMax is optional. A single instance might exist.

The maximum value (upper boundary) allowed for the DetailValue that is the parent of this element.

StandardDeviation

StandardDeviation is optional. A single instance might exist.

A statistic used as a measure of dispersion in a distribution.

SampleSize

SampleSize is optional. A single instance might exist.

The number of samples used to determine the product characteristic in question.

TwoSigmaLower

TwoSigmaLower is optional. A single instance might exist.

Two sigma (a measure of dispersion associated with standard deviation) on the lower side of the standard deviation.

TwoSigmaUpper

TwoSigmaUpper is optional. A single instance might exist.

Two sigma (a measure of dispersion associated with standard deviation) on the upper side of the standard deviation.

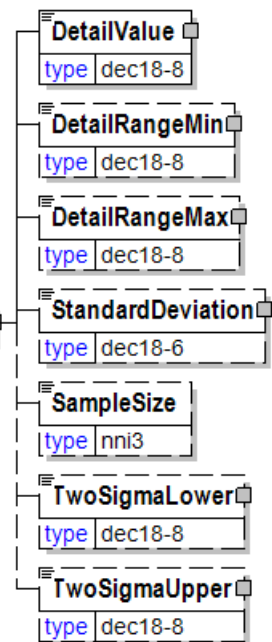

BookBlock

The text block plus the endpapers and other materials added by the binder before cover is applied.

(sequence)

The sequence of items below is mandatory. A single instance is required.

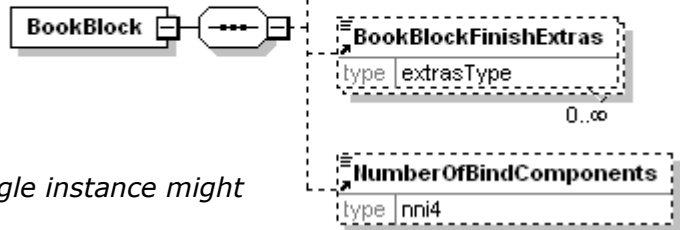

BookBlockBulk

BookBlockBulk is optional. A single instance might exist.

Measurement of the thickness of the book block.

BookBlockEdgeTrim

BookBlockEdgeTrim is optional. Multiple instances might exist.

Specifications for the trimming the edges of the book.

BookBlockFinishExtras

BookBlockFinishExtras is optional. Multiple instances might exist.

Additional instructions for finishing.

Refer to BookBlockFinishExtras definition for any enumerations.

NumberOfBindComponents

NumberOfBindComponents is optional. A single instance might exist.

Total number of components contained in the book block.

BookBlockBulk

Measurement of the thickness of the book block.

(sequence)

The sequence of items below is mandatory. A single instance is required.

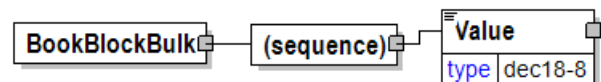

Value

Value is mandatory. A single instance is required.

A numeric value expressed in the unit of measure (UOM).

BookBlockEdgeTrim

Specifications for the trimming the edges of the book.

EdgeLocationType [attribute]

EdgeLocationType is optional. A single instance might exist.

Edge location type.

Refer to EdgeLocationType definition for any enumerations.

(sequence)

The sequence of items below is mandatory. One instance is required, multiple instances might exist.

EdgeFinish

EdgeFinish is mandatory. A single instance is required.

The finish applied to the edge.

Refer to EdgeFinish definition for any enumerations.

ColourSpecs

ColourSpecs is optional. A single instance might exist.

Colour specs

AdditionalText

AdditionalText is optional. Multiple instances might exist.

A text field that is used to communicate information not previously defined or for special instructions. To be used only for circumstances not covered by specific elements.

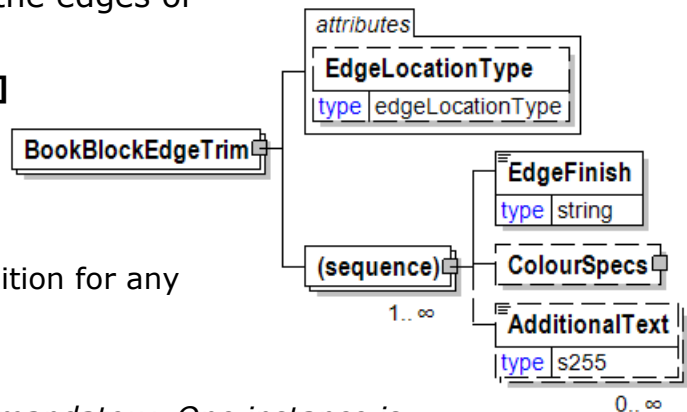

BookBlockFinishExtras

Additional instructions for finishing.

This item is restricted to the following list.

DieCut

Cut irregular shapes in paper or paperboard using a die.

RoundedCorners

Process of using a die to cut the thumb-edge corners into a rounded shape.

ThumbCuts

Notch on the open ends of a page making it easy to grasp. ThumbCuts.

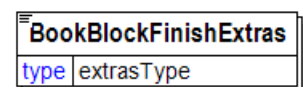

BookClassification

Category under which the product or a component within the product is classified.

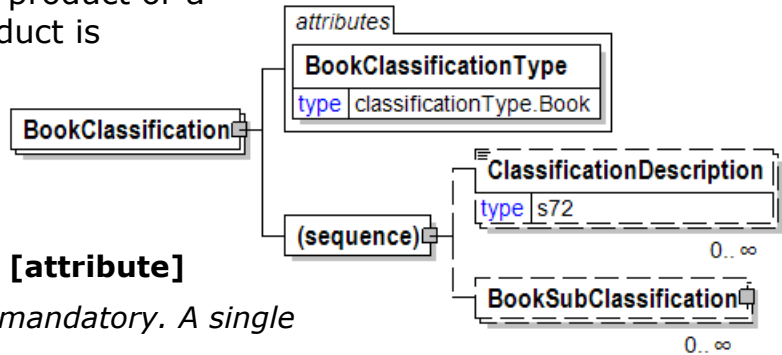

BookClassificationType [attribute]

BookClassificationType is mandatory. A single instance is required.

Category under which the product or a component within the product is classified.

Refer to *BookClassificationType* definition for any enumerations.

(sequence)

The sequence of items below is mandatory. A single instance is required.

ClassificationDescription

ClassificationDescription is optional. Multiple instances might exist.

A free form description of the classification.

BookSubClassification

BookSubClassification is optional. Multiple instances might exist.

Sub Category of the *BookClassification* under which the product or a component within the product is classified.

BookClassificationType [attribute]

Category under which the product or a component within the product is classified.

This item is restricted to the following list.

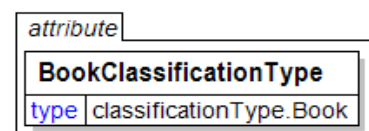

Assembly

A finished product or component consisting of components that have been fitted together.

Audio

Audio component such as an audio CD or DVD containing recording of acoustic signals.

Binding

Component used in the book binding process.

Book

Written work or composition printed on pages bound together that have been published.

Box

A container with a flat base and sides, typically square or rectangular and

having a lid or flaps that close.

Cover

Component used as a protective covering to bind together the pages of a book.

Electronic

Device or technology associated with or employing low voltage current and solid state integrated circuits or components, usually for transmission and/or processing of analog or digital data

Endsheet

The pages at the beginning and end of a volume are added to both protect the textblock and to secure it into the cover.

Envelope

A paper or cardboard wrapper used to enclose and small, flat items such as a letter for mailing.

FinishedGoods

Goods that have completed the manufacturing process but have not yet been sold or distributed to the end user.

Insert

A loose page or section that is manufactured separately from the text pages.

Jacket

A paper cover sometimes called the "dust cover" of a hardbound book.

Kit

Assembled components that comprise a finished product or package.

Label

A piece of paper, polymer, cloth, metal, or other material affixed to a container or article, on which is printed a legend, information concerning the product, addresses, etc. A label may also be printed directly on the container or article.

Material

Tangible substance that goes into the makeup of the finished product.

Media

Films, tapes, and other audio-visual materials that require the use of special listening or viewing equipment.

MediaHolder

Device specifically designed to hold the media material.

MultiVolumeSet

Product that is comprised of multiple books/volumes.

Other

Part of a finished product that is not a book component such as a toy. The ClassificationDescription can be used to describe the part in more detail.

Packaging

Materials used for the containment, protection, handling, delivery and presentation of goods and the activities of placing and securing goods in those materials.

Prep

Materials or files required in the preparation for printing.

SlipCase

Four or five-sided box, usually made of high-quality cardboard, into which binders, books or book sets are slipped for protection.

Text

The main body of a book or other piece of writing.

Video

Video component such as a CD or DVD containing moving visual images.

Wrap

The covering (usually paper or cellophane) in which something is wrapped.

BookManufacturing

BookManufacturing is a group element that contains the elements that describe the book manufacturing process.

(sequence)

The sequence of items below is mandatory. A single instance is required.

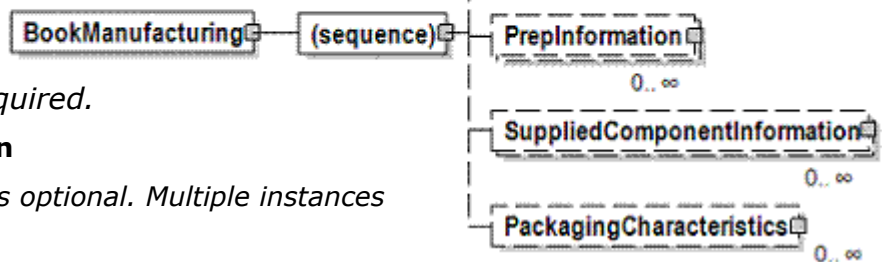

BookClassification

BookClassification is optional. Multiple instances might exist.

Category under which the product or a component within the product is classified.

ProofInformationalQuantity

ProofInformationalQuantity is optional. Multiple instances might exist.

ProofInformationalQuantity

PrepInformation

PrepInformation is optional. Multiple instances might exist.

Information related to the preparation of the Book.

SuppliedComponentInformation

SuppliedComponentInformation is optional. Multiple instances might exist.

Information about components supplied by the publisher to the vendor i.e. paper supplied to the print vendor or jackets supplied to the bind vendor.

PackagingCharacteristics

PackagingCharacteristics is optional and repeatable.

An element containing carton or pallet packing information.
PackagingCharacteristics can either have the BoxCharacteristics or PalletPackagingCharacteristics element not both.

BookPackageInformation

The purpose of the BookPackageInformation structure is to clearly identify physical handling items that constitute the delivery.

BookPackageInformation is the highest level of product packaging and describes the shipping or warehousing unit.

PackageType [attribute]

PackageType is mandatory. A single instance is required.

Communicates the configuration of the item being reported.

Refer to PackageType definition for any enumerations.

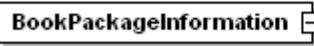

MixedProductPalletIndicator [attribute]

MixedProductPalletIndicator is optional. A single instance might exist.

Specifies whether a product can be mixed with other products on the same pallet

Refer to MixedProductPalletIndicator definition for any enumerations.

IsPartialIndicator [attribute]

IsPartialIndicator is optional. A single instance might exist.

Specifies if the container (e.g. pallet, box) is partially full or not.

Refer to IsPartialIndicator definition for any enumerations.

(sequence)

The sequence of items below is mandatory. A single instance is required.

Identifier

Identifier is mandatory. One instance is required, multiple instances might exist.

An Identifier is required for packages and items (pallets, reel packages, boxes,

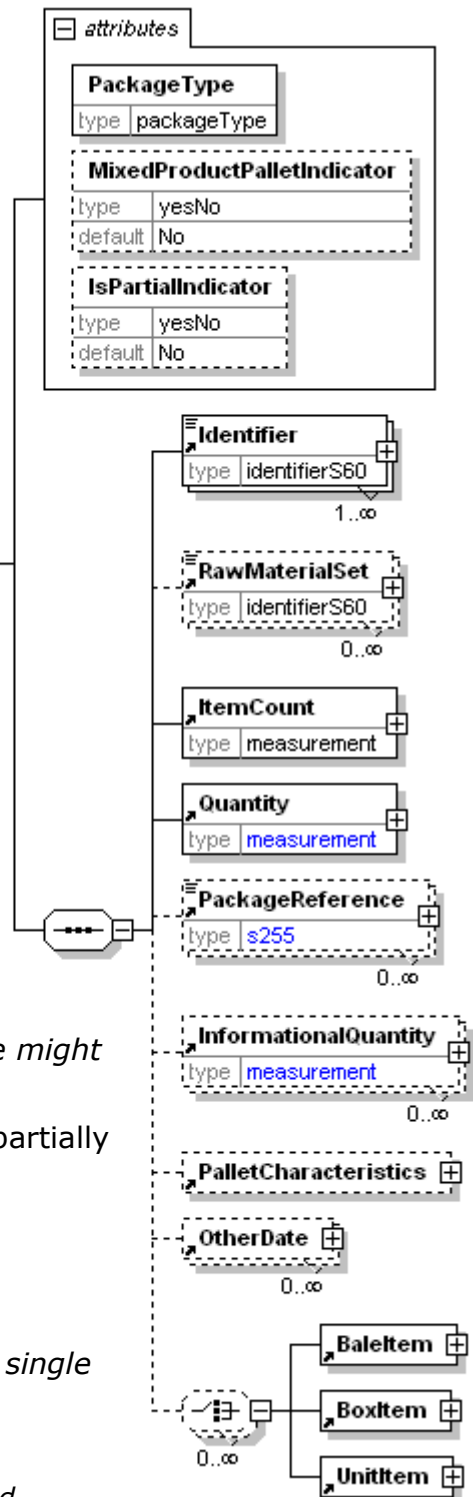

ream items, reel items, etc). The Identifier element contains the actual item identifier code. Identifier is repeatable so more than one identifier can be communicated. For example, the printed identifier on a label may be different from the barcode printed on the label.

RawMaterialSet

RawMaterialSet is optional. Multiple instances might exist.

This identifier derived element indicates a grouping of raw materials that were used to manufacture the product.

ItemCount

ItemCount is mandatory. A single instance is required.

A count of the number of items (examples: a count of the number of boxes on a pallet or of reams in a box).

Quantity

Quantity is mandatory. A single instance is required.

The Quantity element contains attributes that provide information about the type of quantity that is being communicated, the context in which the particular quantity is to be viewed, and (if the quantity represents an adjustment) an adjustment type.

The Quantity element contains three child elements that enable you to communicate a range of values for the quantity and a target or actual value. It is at this level (Value, RangeMin, and RangeMax) that the unit of measure is specified. This permits the range to be specified in a different unit of measure than the target.

PackageReference

PackageReference is optional. Multiple instances might exist.

An element detailing the relevant references pertaining to a package. The type of reference is identified by the attributes PackageReferenceType and AssignedBy.

InformationalQuantity

InformationalQuantity is optional. Multiple instances might exist.

A quantity given in a valid UOM used for information purposes only (not for calculation). For example, an ordered quantity was 100 reels as opposed to the invoice quantity of 20,000 pounds.

PalletCharacteristics

PalletCharacteristics is optional. A single instance might exist.

A group item that provides pallet detail information.

OtherDate

OtherDate is optional. Multiple instances might exist.

A date that may not be specifically detailed within a document (example: print date at the PurchaseOrderLineItem).

(choice)

[choice] is optional. Multiple instances might exist.

BaleItem

BaleItem is mandatory. A single instance is required.

An individual bale included as part of a delivery.

BoxItem

BoxItem is mandatory. A single instance is required.

A four-sided container for reams or sheet items. A pallet can contain zero or more boxes. The term Carton is a synonym for BoxItem. The term "Box" is used as constraint within the ItemType attribute of the UsageLineItemDetail to refer to a box that contains other boxes.

UnitItem

UnitItem is mandatory. A single instance is required.

Unit Item.

BookSpecIdentification

A grouping element that contains information identifying a book specification.

(sequence)

The sequence of items below is mandatory. A single instance is required.

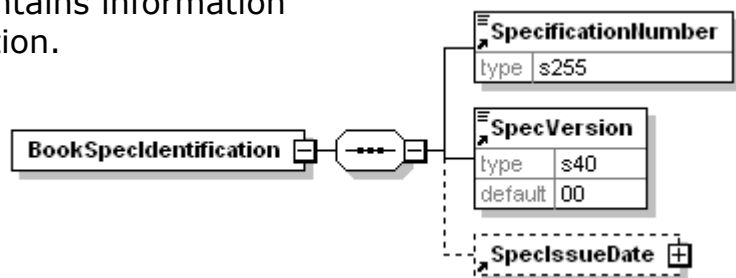

SpecificationNumber

SpecificationNumber is mandatory. A single instance is required.

The unique identifier for the BookSpecification e-Document.

SpecVersion

SpecVersion is mandatory. A single instance is required.

A value that keeps track of the version of the BookSpecification e-Document.

SpecIssueDate

SpecIssueDate is mandatory. A single instance is required.

The date and time when the BookSpecification e-Document was issued.

BookSpecification

The BookSpecification element is the root element for the BookSpecification e-Document.

The BookSpecification e-Document represents established product specifications that can be referenced by multiple transactions in the manufacturing life cycle of a product from RFQ through Invoice and subsequent reprints and/or reorders. It captures unique book manufacturing industry data elements as established by the buyer that are needed by the supplier for manufacturing.

SpecType [attribute]

SpecType is optional. A single instance might exist.

Used to identify what type of BookSpecification e-Document this transaction is.

Refer to SpecType definition for any enumerations.

SpecStatusType [attribute]

SpecStatusType is optional. A single instance might exist.

Identifies the status of the entire BookSpecification e-Document (in other words, at the root level).

Refer to SpecStatusType definition for any enumerations.

NASTA [attribute]

NASTA is optional. A single instance might exist.

Indicates if the specification must conform to the NASTA (National Association of State Textbook Administrators) requirements.

Refer to NASTA definition for any enumerations.

ChildrensTitle [attribute]

ChildrensTitle is optional. A single instance might exist.

Specifies if the book product is designated for use by children 12 and under or not.

Refer to ChildrensTitle definition for any enumerations.

Secure [attribute]

Secure is optional. A single instance might exist.

BookSpecification

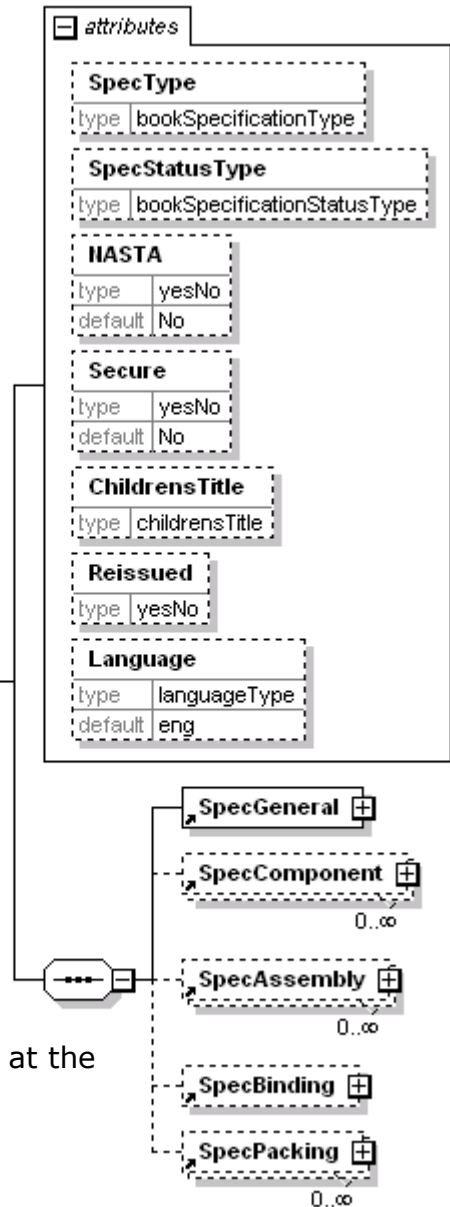

This attribute indicates that the product requires a secure manufacturing plant. For example when manufacturing ACT booklets and other testing products.

Refer to Secure definition for any enumerations.

Reissued [attribute]

Reissued is optional. A single instance might exist.

Either "Yes" or "No".

Refer to Reissued definition for any enumerations.

Language [attribute]

Language is optional. A single instance might exist.

The valid Alpha 2- and Alpha 3-character list of language codes in the ISO 639-1 and 639-2 international standards.

Information on the content of this attribute is available at:
https://www.loc.gov/standards/iso639-2/php/code_list.php

(sequence)

The sequence of items below is mandatory. A single instance is required.

SpecGeneral

SpecGeneral is mandatory. A single instance is required.

Spec General

SpecComponent

SpecComponent is optional. Multiple instances might exist.

Group element used to identify all the necessary component information for this BookSpecification.

Each occurrence of this construct identifies a single component.

SpecAssembly

SpecAssembly is optional. Multiple instances might exist.

SpecAssembly contains assemblies that are used in the manufacturing of books.

SpecBinding

SpecBinding is optional. A single instance might exist.

SpecBinding describes the binding process.

SpecPacking

SpecPacking is optional. Multiple instances might exist.

SpecPacking defines the book packaging parameters.

BookSubClassification

Sub Category of the BookClassification under which the product or a component within the product is classified.

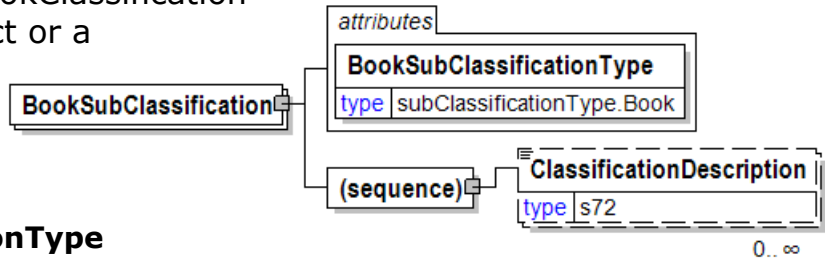

BookSubClassificationType [attribute]

BookSubClassificationType is mandatory. A single instance is required.

Sub Category of the BookClassification under which the product or a component within the product is classified.

Refer to BookSubClassificationType definition for any enumerations.

(sequence)

The sequence of items below is mandatory. A single instance is required.

ClassificationDescription

ClassificationDescription is optional. Multiple instances might exist.

A free form description of the classification.

BookSubClassificationType [attribute]

Sub Category of the BookClassification under which the product or a component within the product is classified.

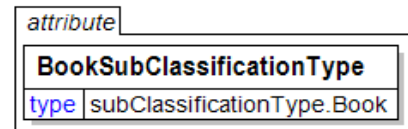

This item is restricted to the following list.

2PieceCarton

Type of box where there is a lid that is separate from the bottom.

AccessCode

A printed card or page that contains a unique code for the purpose of accessing a secure service or device

Acetate

Component produced with Acetate material which is a transparent or translucent plastic sheet material of a variety of colors, used as a basis for artwork and overlays.

AdvertisingBrochure

Component printed for purpose of advertising.

Album

Product manufactured with loose-leaf pages bound by drilling (hole punching).

Assembly

Product that requires assembly to complete the finished good that usually includes the book and other items such as CDs, toys, etc.

Audio

Audio is a form of multimedia that allows the listener to hear information.

BackCoverPanelwShrinkwrap

Component packaged on the back cover of the book by shrinkwrapping.

BackMatter

Printed matter (usually explanatory) following the main body text of a book, e.g. appendices, bibliography, index etc.

BarCode

A machine-readable code in the form of a pattern of parallel lines of varying widths identifying an item.

BellyBand

Small strip of paper that wraps around the cover of a book like a dust jacket that usually contains brief publishing information, such as price, printing statement, etc.

also known as a "book band" or "jacket band".

Binder

A cover or holder for unbound papers, pages etc.

Binding

Process of physically assembling a book from a number of folded or unfolded sheets of paper or other material; it also usually involves attaching covers to the resulting book-block.

Bind-inSleeve

Plastic or paper insert that contains a pocket for holding a CD or DVD and is bound inside of the book.

BlisterPak

Pre-formed clear plastic packaging.

BlownIn

Printed promotional piece that is inserted by machine using a "fanning" process during the final production stage of a publication.

BluRay

An optical disc storage medium designed to supersede the standard DVD format.

Book

A written work or composition that has been published (printed on pages bound together).

Bookblock

The gathered and glued or sewn signatures, inserts and other components of the book before the cover is added.

Bookmark

A marker (a piece of paper or ribbon) placed between the pages of a book to

mark the reader's place.

Bound

Secured with a cover or binding.

Box

Box describes a variety of containers and receptacles.

BoxWrap

Material for wrapping the box.

Brochure

A booklet of printed informational matter, like a pamphlet, often for promotional purposes.

BubbleBag

Bags made from bubble cushioning material constructed of pockets of air locked between a top and bottom layer of linear low density polyethylene film.

Card

Type of insert that is usually printed on heavy card stock and placed somewhere in the finished product.

Carton

A specific type of box or container usually made of paperboard and often of corrugated paperboard in which the finished product is packaged.

CaseCover

The cover of a Hardback (casebound) book, usually made of cloth or similar material and boards.

Cassette

A container that holds a magnetic tape used for recording or playing sound or video.

CassetteHolder

A holder usually made of plastic designed to hold the cassette.

CD

Compact Disc; High density storage media based on a 4.75" reflective optical disc.

CD-ROM

Version of the CD that allows the information to be stored and retrieved; once a CD-ROM is pressed, new data cannot be stored and the disc cannot be erased for reuse.

Cloth

Material used for making a casecover.

CompanyOwnedStock

Refers to material that is owned by the publisher.

Cover

Material used on the outside of the book block; refers to the front, back and spine of the book.

CoverBack

Indicates the back cover location.

CoverFront

Indicates the front cover location.

Disk

Generic term for Diskettes, CDs, DVDs.

Diskette

A flexible, oxide-coated disk used to store data.

DisketteSleeve

Plastic or paper insert that contains a pocket for holding the diskette.

Divider

Type of insert that is usually printed on heavy paper and used to divide sections or chapters of a book.

Documentation

The systematic collection of research materials via writing, interviewing, audio and video recording, and photography.

DoubleWallCarton

Corrugated card consisting of a layer of paper / corrugated paper / paper / corrugated paper and finally another layer of paper.

DVD

Digital Versatile Disk; high-capacity optical disk that looks like a CD, but can store much more information.

EconoWrap

A 'fit to book size' low cost thin layer paper container used to package a single book.

EndSheet

Four pages each at the beginning and end of a casebound book, one leaf of each being solidly pasted against the inside board of the case; stock is stronger and heavier than text stock and may be white or colored stock, printed or unprinted. Also called Endpapers, End-leaves or Lining Papers.

EndsheetBack

Specifies the Endsheets that is used to attach the back cover to the book block.

EndsheetFront

Specifies the Endsheets that is used to attach the front cover to the book block.

Envelope

Packaging product, usually made of flat, planar material such as paper or cardboard, and designed to contain a flat object, which in a postal-service context is usually a letter, card or bills.

FinishedGood

Completed products awaiting sale.

FlatSheet

State of a printed sheetfed component before the flatcut/trimming process.

FoldedAndGatheredSig

State of the signature before the trimming process.

FrontMatter

Printed matter preceding the main body text of a book, e.g. teacher's guide.

Gatefold

Flap from the fore-edge, with a fold running parallel to the spine of the book. The finished page is marginally smaller than the normal trimmed page. A double fold, usually of card or heavy board, from the two outside edges of a folder. The two folded pages meet in the centre of the page, edge to edge, rather like a double gate.

HalfJacket

Component, similar to a Jacket, placed around a book to protect the cover; the difference is that this component only partially covers the cover and is glued inside.

Handbook

A reference book that provides concise, useful data and other information on a specific subject.

HollowWrap

A 'fit to book size' low cost paperboard and fluted material container used to package a single book.

Insert

Specially printed piece for insertion in a publication.

Jacket

Component placed around a case-bound book to protect the cover.

Jcard

Paper card that forms a "J" shape when folded, similar to a Ucard, that is inserted in the plastic storage case of most pre-recorded audio cassette releases; the j-card usually contains an image of the album cover, a track listing, credits, and copyright information.

JewelCase

The hinged plastic case in which most CDs are often stored.

Jiffy

Thick envelope.

Jwrap

Cover-like wrapper that is used to wrap gathered and trimmed signatures.

Label

Piece of paper, polymer, cloth, metal, or other material affixed to a container or article, on which is printed a legend, information concerning the product, addresses, etc.; a label may also be printed directly on the container or article.

LaserDisc

A record-like storage medium that uses analogue and laser optical technology to store images.

Liner-Corrugation

Generic term for any paper that functions as a covering for other paper or board material through adhesion, making it a part of the finished product.

Loose

Insert that is not bound into the book.

MakeReady

Machine preparation for each operation in the manufacturing process.

Map

Visual representation of an area.

Material

Refers to paper, cloth or other tangible substance used in the manufacturing of the component or finished good.

Media

Storage devices for audio, video.

MediaHolder

Holder designed for storing/protection of the media.

OWrap

Wrap that fully circles the book (head to foot) and is usually used on shrinkwrapped products.

Packaging

Enclosing or protecting products for distribution, storage, sale, and use.

Paper

Material made of cellulose pulp derived mainly from wood used for the printing process.

PaperCover

Printed sheet used for the outside cover of the book.

PeelStickCD

CD package is made from an adhesive paper-backed material that is applied by removing the paper and exposing the adhesive.

Pocket

Paper, cloth, vinyl or other material made into a pocket either with or without gussets and affixed inside the front or back cover of the book.

PolyBag

papiNet V2R31

Bags are made from 100% virgin polyethylene resin.

Prep

The process of preparing electronic files for print production such as creation of printing plates or downloading to digital presses.

Preprinted

Component is printed prior to the manufacturing step.

PreprintedCaseside

Indicates a hardcover created from a printed cover vs. case material.

Proof

A facsimile of press pages for review

ReplyCard

Sender-addressed card included in a mailing on which the recipient indicates a response (positive or negative) to an offer.

RFTag

A electronic tag attached to an antenna that is packaged in a way that it can be applied to an object.

Run

"Good" copies produced in each operation in the manufacturing process.

SheetSignature

Refers to the printing of a signature on a sheetfed press.

SheetWise

Sheetfed process where the frontside of all of the components are imposed on one side of the sheet and printed; the plates are changed and then the sheets are then turned over and run back through the press thus completing both sides of the components.

Shrinkwrapping

Protective wrapping for the product made from heat-shrink polyfilm.

Signature

Folded, printed sheet or part of a sheet which forms a section of multiple pages of a book or publication in numerical sequence.

SingleWallCarton

Corrugated card consisting of an outer paper (usually kraft), a single layer of corrugated paper followed by a further layer of paper (usually test).

Skagg

A low cost thin layer paper container used to package a single book.

Sleeve

Plastic or paper insert that contains a pocket for holding another component, ususally a type of media.

Slide

Still, positive image created on a transparent base using photochemical means.

SlimPack

CD or DVD slim hinged plastic case in which CDs are stored.

SlipCase

Protective box that holds a book or set of books; slip cases can be made from any material, most often cloth or paper covered cardboard.

SlipCaseWrap

Protective wrapping for a slipcase.

SoftwareAccessCode

A printed card or page that contains a unique code for the purpose of accessing protected software.

SoftwareStyle

A folding carton with top & bottom flaps that includes a "door" on the front of the package with a velcro closure; the purpose is to allow 4 complete surfaces to hold marketing copy.

Spine

Refers to the outside edge of the book where the pages are gathered and bound, providing an anchor point and hinge that allows the book's cover and pages to open and close.

Sticker

Gummed or adhesive label.

SubAssembly

Group of components that is part of the completed project.

SuperJWrap

Same as Jwrap with the addition of a scored tab which covers the bottom portion of the spine of the book.

TCarton

A carton including a wraparound corner locking flap construction comprising a T-shaped first element joined to part of the carton and two other elements joined to another part of the carton.

Tab

Insert form where a small flap projects out from the thumb edge used for quick access.

Text

The written or printed material which forms the main body of a book.

Transparency

Piece of clear or colored plastic or film used with an overhead projector to make presentations.

Transvision

papiNet V2R31

Set of transparencies that are placed together to create a "full" image but individually contain separate images such as the human body systems.

Ucard

Paper card that forms a "U" shape when folded, similar to a Jcard, that is inserted in the plastic storage case of most pre-recorded audio cassette releases; the j-card usually contains an image of the album cover, a track listing, credits, and copyright information

Video

Series of framed images put together, one after another, to simulate motion and interactivity.

VinylPack

Vinyl material for vacuum packing.

WebSignature

Component printed on a web press.

WorkAndBack

Sheetfed process where the press contains enough units to print the front and back of each component in one press run.

WorkAndTurn

Sheetfed process where the frontside of half of the components and the backside of the remaining components are imposed on one side of the sheet and printed; the sheets are then turned over and run back through the press in the exact same position thus completing both sides of the components without changing the plates.

Wrap

The cover of a paperback book or covers of a magazine, often printed on colored paper.

ZipLockBag

Disposable, re-sealable zipper storage bags and containers.

BookUnitPacking

Book unit packing information

BookUnitType [attribute]

BookUnitType is optional. A single instance might exist.

Book unit type

Refer to BookUnitType definition for any enumerations.

PackageType [attribute]

PackageType is optional. A single instance might exist.

Communicates the configuration of the item being reported.

Refer to PackageType definition for any enumerations.

(sequence)

The sequence of items below is mandatory. A single instance is required.

UnitCharacteristics

UnitCharacteristics is optional. A single instance might exist.

Unit characteristics.

LabelCharacteristics

LabelCharacteristics is optional. Multiple instances might exist.

A group item that organises the labeling information.

StencilCharacteristics

StencilCharacteristics is optional. Multiple instances might exist.

A group element specifying attributes of a stencil to be applied to an item, and optional text.

WrapCharacteristics

WrapCharacteristics is optional. A single instance might exist.

A group element that contains elements that describe the manner in which the item is wrapped.

AdditionalText

AdditionalText is optional. Multiple instances might exist.

A text field that is used to communicate information not previously defined or for special instructions. To be used only for circumstances not covered by specific elements.

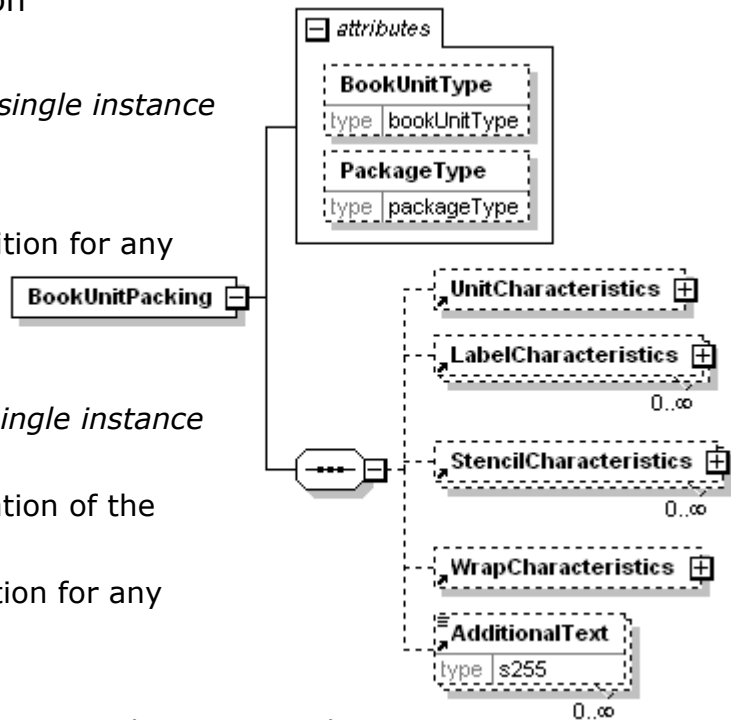

BookUnitType [attribute]

Book unit type

This item is restricted to the following list.

Unit

The book unit is free standing.

Unit pre-Assembly

The book unit requires previous assembly.

Unit post-Assembly

The book unit requires post assembly.

attribute	
BookUnitType	
type	bookUnitType

BooleanValue

A value in boolean format.

BooleanValue	
type	xs:boolean

BoxCharacteristics

BoxCharacteristics is a group element that contains information about the box (or carton)

BoxType [attribute]

BoxType is optional. A single instance might exist.

Communicates the type of carton to use. Refer to BoxType definition for any enumerations.

BoxMeasurementsAppliesTo [attribute]

BoxMeasurementsAppliesTo is optional. A single instance might exist.

Used to indicate the nature of the endpoints of the measurement type.

Refer to BoxMeasurementsAppliesTo definition for any enumerations.

IsRFTagRequired [attribute]

IsRFTagRequired is optional. A single instance might exist.

Indicates that RFTag application is required in the manufacturing and carton packaging processes.

Refer to IsRFTagRequired definition for any enumerations.

(sequence)

The sequence of items below is mandatory. A single instance is required.

ProductIdentification

ProductIdentification is optional. A single instance might exist.

A grouping element designed to communicate product identification related to the parent element that contains this item.

Height

Height is optional. A single instance might exist.

The height of the object.

Length

Length is optional. A single instance might exist.

The length of the object.

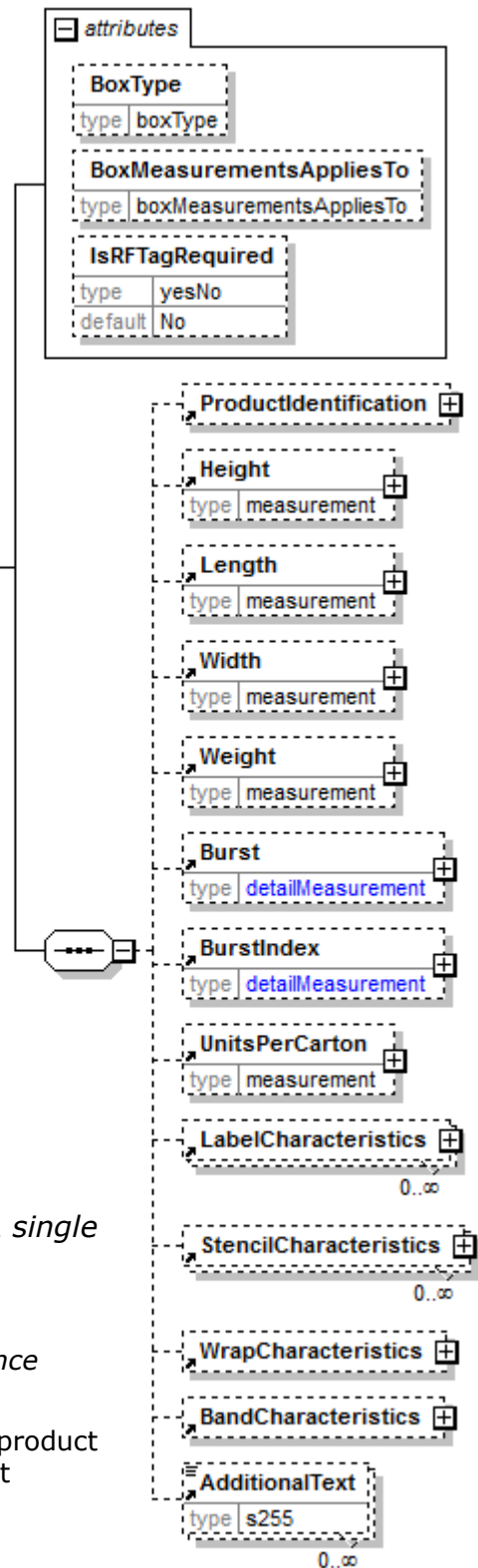

Width

Width is optional. A single instance might exist.

The width of the object.

Weight

Weight is optional. A single instance might exist.

The weight of the item.

Burst

Burst is optional. A single instance might exist.

A group item used to communicate bursting strength target or test value according to a particular TestMethod.

BurstIndex

BurstIndex is optional. A single instance might exist.

The burst index.

UnitsPerCarton

UnitsPerCarton is optional. A single instance might exist.

The number of units per box.

LabelCharacteristics

LabelCharacteristics is optional. Multiple instances might exist.

A group item that organises the labeling information.

StencilCharacteristics

StencilCharacteristics is optional. Multiple instances might exist.

A group element specifying attributes of a stencil to be applied to an item, and optional text.

WrapCharacteristics

WrapCharacteristics is optional. A single instance might exist.

A group element that contains elements that describes the manner in which the item is wrapped.

BandCharacteristics

BandCharacteristics is optional. A single instance might exist.

A group item that organises the packaging band detail information.

AdditionalText

AdditionalText is optional. Multiple instances might exist.

A text field that is used to communicate information not previously defined or for special instructions. To be used only for circumstances not covered by specific elements.

BoxItem

A four-sided container for reams or sheet items. A pallet can contain zero or more boxes. The term Carton is a synonym for BoxItem. The term "Box" is used as constraint within the ItemType attribute of the UsageLineItemDetail to refer to a box that contains other boxes.

MixProductIndicator [attribute]

MixProductIndicator is optional. A single instance might exist.

Specifies whether a product can be mixed with other products on the same shipment.

Refer to MixProductIndicator definition for any enumerations.

IsPartialIndicator [attribute]

IsPartialIndicator is optional. A single instance might exist.

Specifies if the container (e.g. pallet, box) is partially full or not.

Refer to IsPartialIndicator definition for any enumerations.

(sequence)

The sequence of items below is mandatory. A single instance is required.

Identifier

Identifier is optional. Multiple instances might exist.

An Identifier is required for packages and items (pallets, reel packages, boxes, ream items, reel items, etc). The Identifier element contains the actual item identifier code. Identifier is repeatable so more than one identifier can be communicated. For example, the printed identifier on a label may be different from the barcode printed on the label.

(sequence)

The sequence of items below is optional. A single instance might exist.

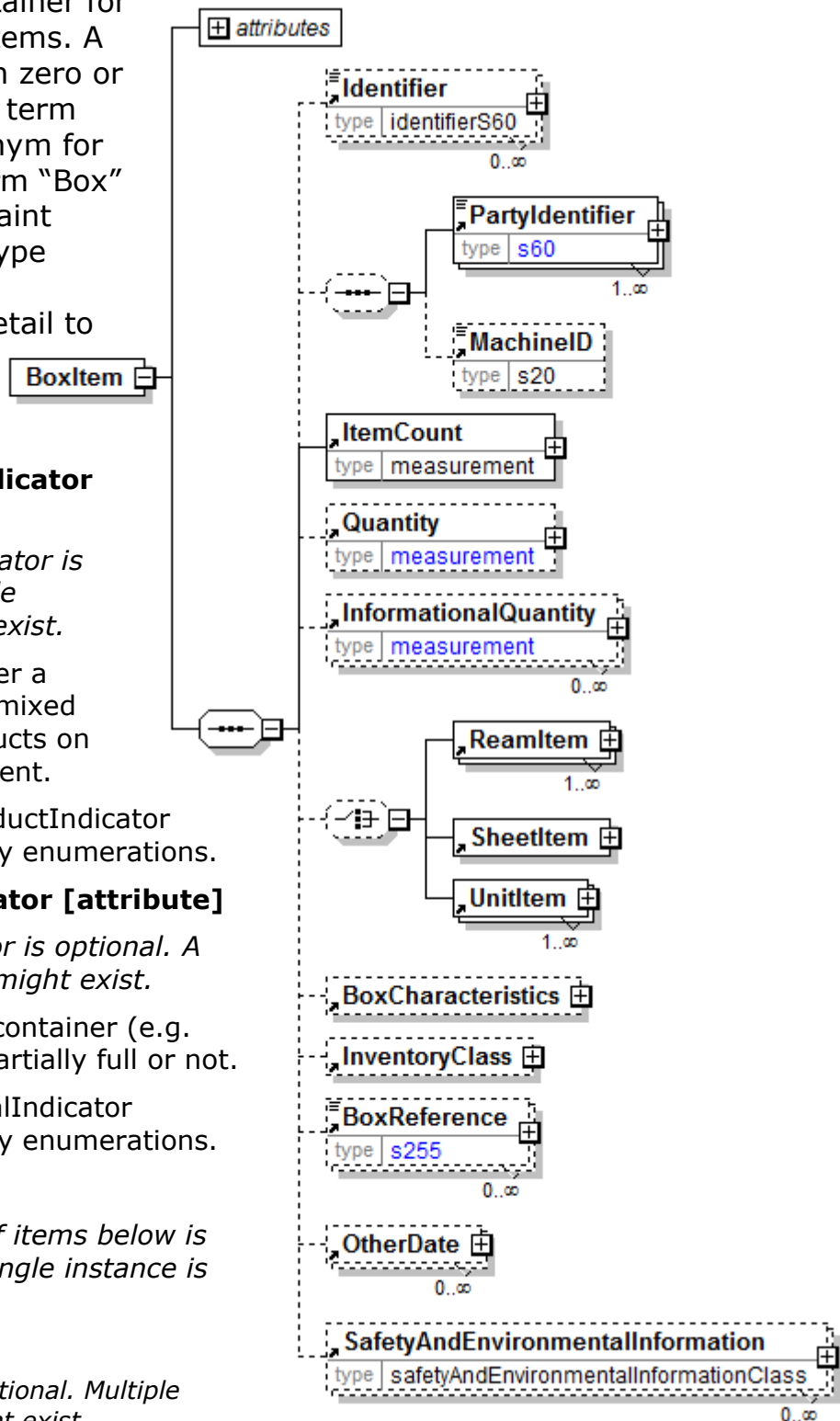

PartyIdentifier

PartyIdentifier is mandatory. One instance is required, multiple instances might exist.

A unique identifier of a specific party. This element contains an attribute PartyIdentifierType that indicates the type of the identifier.

MachineID

MachineID is optional. A single instance might exist.

An identifier assigned to the particular machine being referenced. For example, a machine could be a paper machine, an off-line coater, a sheeter, or a printing press. The particular machine being referenced will be determined by the business event being supported.

ItemCount

ItemCount is mandatory. A single instance is required.

A count of the number of items (examples: a count of the number of boxes on a pallet or of reams in a box).

Quantity

Quantity is optional. A single instance might exist.

The Quantity element contains attributes that provide information about the type of quantity that is being communicated, the context in which the particular quantity is to be viewed, and (if the quantity represents an adjustment) an adjustment type.

The Quantity element contains three child elements that enable you to communicate a range of values for the quantity and a target or actual value. It is at this level (Value, RangeMin, and RangeMax) that the unit of measure is specified. This permits the range to be specified in a different unit of measure than the target.

InformationalQuantity

InformationalQuantity is optional. Multiple instances might exist.

A quantity given in a valid UOM used for information purposes only (not for calculation). For example, an ordered quantity was 100 reels as opposed to the invoice quantity of 20,000 pounds.

(choice)

[choice] is optional. A single instance might exist.

ReamItem

ReamItem is mandatory. One instance is required, multiple instances might exist.

A wrapped quantity of SheetItem(s).

SheetItem

SheetItem is mandatory. A single instance is required.

A group item consisting potentially of the date the sheets were converted into sheets and/or packaged or finished.

UnitItem

UnitItem is mandatory. One instance is required, multiple instances might exist.

Unit Item.

BoxCharacteristics

papiNet V2R31

BoxCharacteristics is optional. A single instance might exist.

BoxCharacteristics is a group element that contains information about the box (or carton)

InventoryClass

InventoryClass is optional. A single instance might exist.

A group item containing information about status of inventory and goods items.

BoxReference

BoxReference is optional. Multiple instances might exist.

An element detailing relevant references pertaining to the Box. The type of reference is identified by the attributes BoxReferenceType and AssignedBy.

OtherDate

OtherDate is optional. Multiple instances might exist.

A date that may not be specifically detailed within a document (example: print date at the PurchaseOrderLineItem).

SafetyAndEnvironmentalInformation

SafetyAndEnvironmentalInformation is optional. Multiple instances might exist.

Name of certification type, if any, on the goods (For example, FSC, PEFC). SafetyAndEnvironmental needs a value or measurement to communicate the percentage of the product is certified (for example, 75% is certified by the indicated agency).

BoxMeasurementsAppliesTo [attribute]

Used to indicate the nature of the endpoints of the measurement type.

This item is restricted to the following list.

Inside

The measurements provided are for the inside of the box.

Outside

The measurements provided apply to the outside of the box.

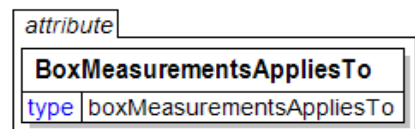

BoxReference

An element detailing relevant references pertaining to the Box. The type of reference is identified by the attributes BoxReferenceType and AssignedBy.

BoxReferenceType [attribute]

BoxReferenceType is mandatory. A single instance is required.

Provides a contextual explanation of the specific reference identifier. Many items are currently prefixed by "Buyer", "Forwarder", "Manufacturer", "Mill", "Seller", "Supplier", "Warehouse", or "Vendor". Check for an existing non-

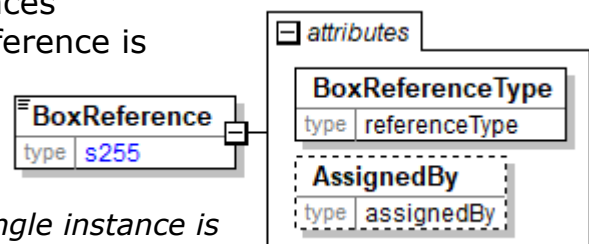

prefixed version and use the non-prefixed version instead. In the (yet to be announced release date) version 3.0 the prefixed versions will be removed. Instead the attribute @AssignedBy will communicate the information previously communicated in the prefix.

Refer to BoxReferenceType definition for any enumerations.

AssignedBy [attribute]

AssignedBy is optional. A single instance might exist.

Identifies the type of party or the agency that has assigned the associated item, e.g. a reference of type OrderNumber.

Refer to AssignedBy for any enumerations.

BoxReferenceType [attribute]

Provides a contextual explanation of the specific reference identifier. Many items are currently prefixed by "Buyer", "Forwarder", "Manufacturer", "Mill", "Seller", "Supplier", "Warehouse" or "Vendor". Check for an existing non-prefixed version and use the non-prefixed version instead. In the (yet to be announced release date) version 3.0 the prefixed versions will be removed. Instead the attribute AssignedBy will communicate the information previously communicated in the prefix.

BoxReferenceType
type referenceType

Refer to the [referenceType](#) entry for the list of enumerations and their definitions.

BoxType [attribute]

Communicates the type of carton to use

This item is restricted to the following list.

Corrugated

The carton type is grooved.

DoubleWall

The carton type has a double wall.

SingleWall

The carton type has a single wall.

TripleWall

The carton type has a triple wall.

attribute
BoxType
type boxType

Brand

Specifies a trade name for an item. E.g. the brand name of a transport vehicle, the brand name of a material etc.

Brand
type s30

BrandAndModel

A grouping element containing information about brand and model for an item.

(sequence)

The sequence of items below is mandatory. A single instance is required.

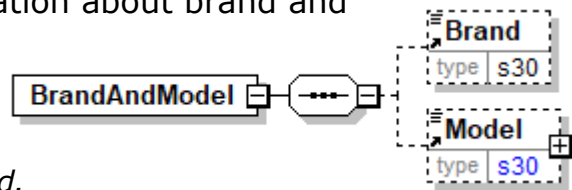

Brand

Brand is optional. A single instance might exist.

Specifies a trade name for an item. E.g. the brand name of a transport vehicle, the brand name of a material etc.

Model

Model is optional. A single instance might exist.

Specifies the model of an item. E.g. the model of a transport vehicle.

BrandName [attribute]

Specifies the trade name for the associated item.

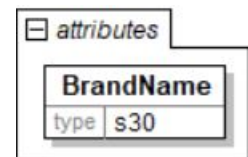

Brightness

A measurement of the degree of light reflectivity of the product.

TestMethod [attribute]

TestMethod is optional. A single instance might exist.

The method used to determine the results of the test under consideration.

TestAgency [attribute]

TestAgency is optional. A single instance might exist.

The agency that has set the parameters for the testing

Refer to TestAgency definition for any enumerations.

SampleType [attribute]

SampleType is optional. A single instance might exist.

Communicates how sampling was done to measure the product characteristics.

Refer to SampleType definition for any enumerations.

ResultSource [attribute]

ResultSource is optional. A single instance might exist.

Used to define the data source of the specified test

Refer to ResultSource definition for any enumerations.

(sequence)

The sequence of items below is mandatory. A single instance is required.

DetailValue

DetailValue is mandatory. A single instance is required.

A numeric value expressed in the unit of measure (UOM).

DetailRangeMin

DetailRangeMin is optional. A single instance might exist.

The minimum value (lower boundary) allowed for the DetailValue that is the parent of this element.

DetailRangeMax

DetailRangeMax is optional. A single instance might exist.

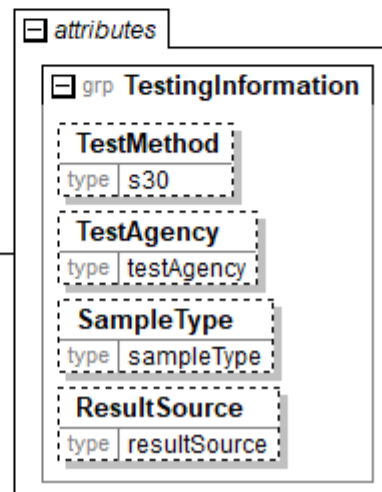
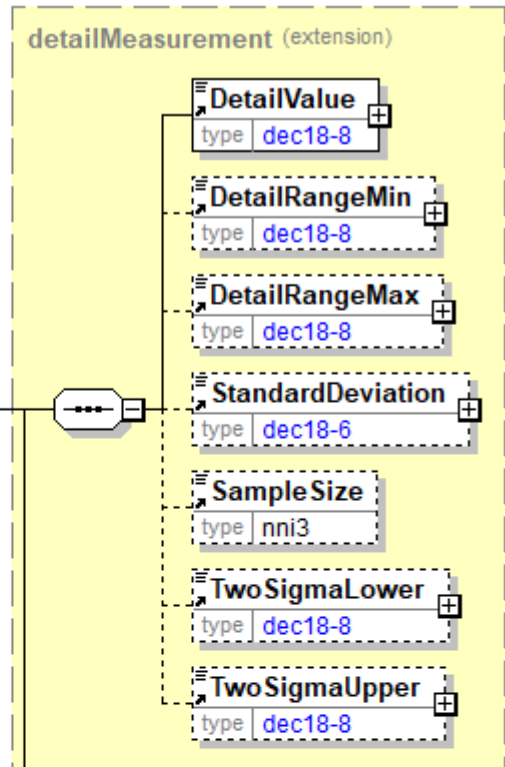

papiNet V2R31

The maximum value (upper boundary) allowed for the DetailValue that is the parent of this element.

StandardDeviation

StandardDeviation is optional. A single instance might exist.

A statistic used as a measure of dispersion in a distribution.

SampleSize

SampleSize is optional. A single instance might exist.

The number of samples used to determine the product characteristic in question.

TwoSigmaLower

TwoSigmaLower is optional. A single instance might exist.

Two sigma (a measure of dispersion associated with standard deviation) on the lower side of the standard deviation.

TwoSigmaUpper

TwoSigmaUpper is optional. A single instance might exist.

Two sigma (a measure of dispersion associated with standard deviation) on the upper side of the standard deviation.

Brilliance

Measure of brilliance in the HSB colour approach.

(sequence)

The sequence of items below is mandatory. A single instance is required.

DetailValue

DetailValue is mandatory. A single instance is required.

A numeric value expressed in the unit of measure (UOM).

DetailRangeMin

DetailRangeMin is optional. A single instance might exist.

The minimum value (lower boundary) allowed for the DetailValue that is the parent of this element.

DetailRangeMax

DetailRangeMax is optional. A single instance might exist.

The maximum value (upper boundary) allowed for the DetailValue that is the parent of this element.

StandardDeviation

StandardDeviation is optional. A single instance might exist.

A statistic used as a measure of dispersion in a distribution.

SampleSize

SampleSize is optional. A single instance might exist.

The number of samples used to determine the product characteristic in question.

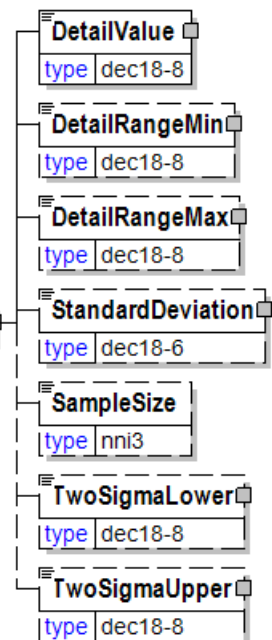
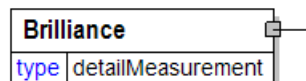

TwoSigmaLower

TwoSigmaLower is optional. A single instance might exist.

Two sigma (a measure of dispersion associated with standard deviation) on the lower side of the standard deviation.

TwoSigmaUpper

TwoSigmaUpper is optional. A single instance might exist.

Two sigma (a measure of dispersion associated with standard deviation) on the upper side of the standard deviation.

BucketStatusType [attribute]

BucketStatusType defines the availability status of the location during the indicated period.

This item is restricted to the following list.

Closed

The location is closed during the indicated period.

LimitedService

The location has limited service during the indicated period.

Open

The location is open during the indicated period.

attributes	
BucketStatusType	
type	bucketStatusType
default	Open

BucketType [attribute]

The type of planning information being communicated in the bucket.

This item is restricted to the following list.

Actual

The planning information communicates incurred values.

Demand

The planning information communicates requested values.

Forecast

The planning information communicates estimated values.

Budget

The planning information communicates budgeted values.

attribute	
BucketType	
type	planningBucketType

Bulk

A group item used to communicate bulking thickness target or test value.

TestMethod [attribute]

TestMethod is optional. A single instance might exist.

The method used to determine the results of the test under consideration.

TestAgency [attribute]

TestAgency is optional. A single instance might exist.

The agency that has set the parameters for the testing

Refer to TestAgency definition for any enumerations.

SampleType [attribute]

SampleType is optional. A single instance might exist.

Communicates how sampling was done to measure the product characteristics.

Refer to SampleType definition for any enumerations.

ResultSource [attribute]

ResultSource is optional. A single instance might exist.

Used to define the data source of the specified test

Refer to ResultSource definition for any enumerations.

(sequence)

The sequence of items below is mandatory. A single instance is required.

DetailValue

DetailValue is mandatory. A single instance is required.

A numeric value expressed in the unit of measure (UOM).

DetailRangeMin

DetailRangeMin is optional. A single instance might exist.

The minimum value (lower boundary) allowed for the DetailValue that is the parent of this element.

DetailRangeMax

DetailRangeMax is optional. A single instance might exist.

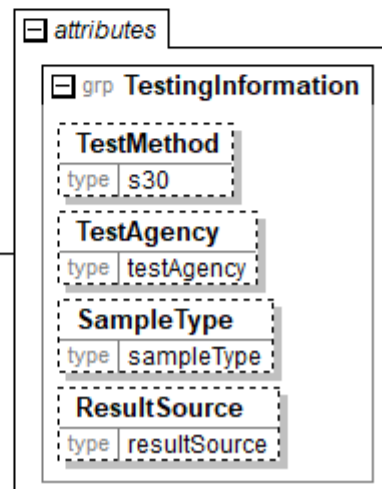
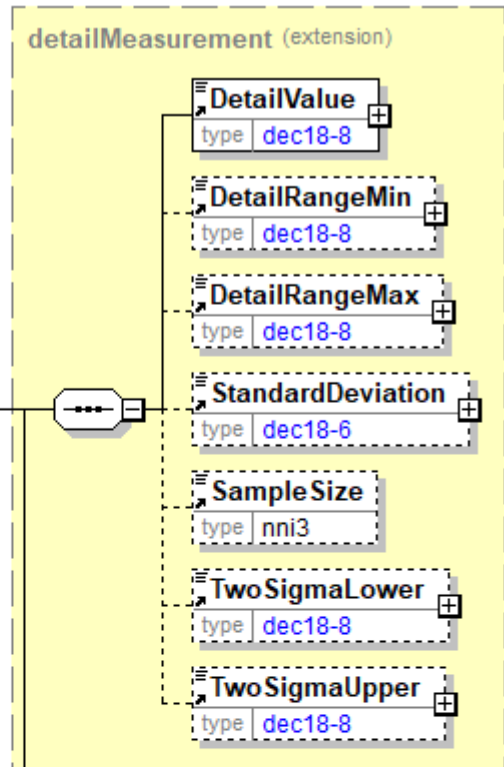

papiNet V2R31

The maximum value (upper boundary) allowed for the DetailValue that is the parent of this element.

StandardDeviation

StandardDeviation is optional. A single instance might exist.

A statistic used as a measure of dispersion in a distribution.

SampleSize

SampleSize is optional. A single instance might exist.

The number of samples used to determine the product characteristic in question.

TwoSigmaLower

TwoSigmaLower is optional. A single instance might exist.

Two sigma (a measure of dispersion associated with standard deviation) on the lower side of the standard deviation.

TwoSigmaUpper

TwoSigmaUpper is optional. A single instance might exist.

Two sigma (a measure of dispersion associated with standard deviation) on the upper side of the standard deviation.

BulkNumberOfUnits

Bulk number of units

BulkNumberOfUnits	
type	nni2

Burst

A group item used to communicate bursting strength target or test value according to a particular TestMethod.

TestMethod [attribute]

TestMethod is optional. A single instance might exist.

The method used to determine the results of the test under consideration.

TestAgency [attribute]

TestAgency is optional. A single instance might exist.

The agency that has set the parameters for the testing

Refer to TestAgency definition for any enumerations.

SampleType [attribute]

SampleType is optional. A single instance might exist.

Communicates how sampling was done to measure the product characteristics.

Refer to SampleType definition for any enumerations.

ResultSource [attribute]

ResultSource is optional. A single instance might exist.

Used to define the data source of the specified test

Refer to ResultSource definition for any enumerations.

(sequence)

The sequence of items below is mandatory. A single instance is required.

DetailValue

DetailValue is mandatory. A single instance is required.

A numeric value expressed in the unit of measure (UOM).

DetailRangeMin

DetailRangeMin is optional. A single instance might exist.

The minimum value (lower boundary) allowed for the DetailValue that is the parent of this element.

DetailRangeMax

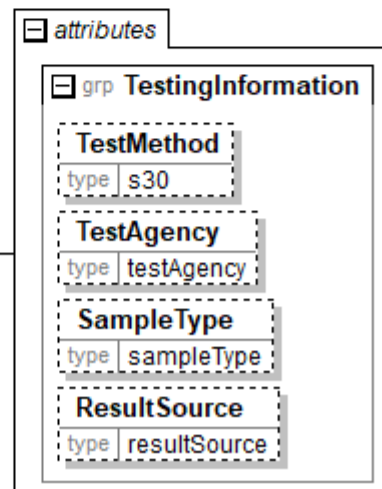
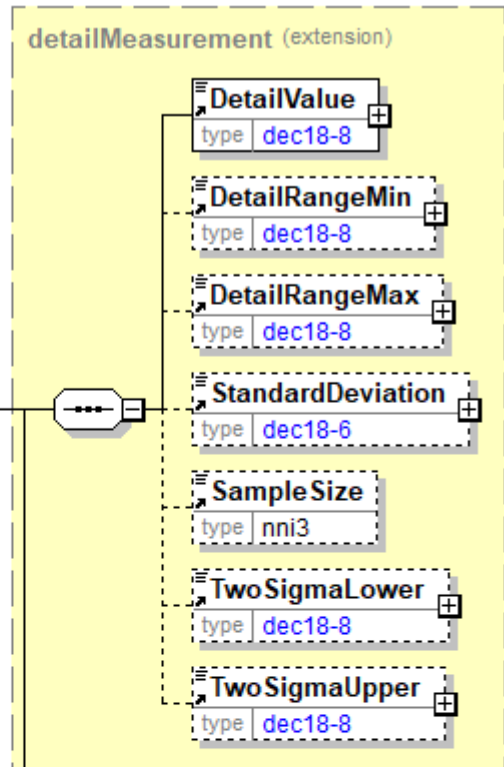

DetailRangeMax is optional. A single instance might exist.

The maximum value (upper boundary) allowed for the DetailValue that is the parent of this element.

StandardDeviation

StandardDeviation is optional. A single instance might exist.

A statistic used as a measure of dispersion in a distribution.

SampleSize

SampleSize is optional. A single instance might exist.

The number of samples used to determine the product characteristic in question.

TwoSigmaLower

TwoSigmaLower is optional. A single instance might exist.

Two sigma (a measure of dispersion associated with standard deviation) on the lower side of the standard deviation.

TwoSigmaUpper

TwoSigmaUpper is optional. A single instance might exist.

Two sigma (a measure of dispersion associated with standard deviation) on the upper side of the standard deviation.

BurstIndex

The burst index.

TestMethod [attribute]

TestMethod is optional. A single instance might exist.

The method used to determine the results of the test under consideration.

TestAgency [attribute]

TestAgency is optional. A single instance might exist.

The agency that has set the parameters for the testing

Refer to TestAgency definition for any enumerations.

SampleType [attribute]

SampleType is optional. A single instance might exist.

Communicates how sampling was done to measure the product characteristics.

Refer to SampleType definition for any enumerations.

ResultSource [attribute]

ResultSource is optional. A single instance might exist.

Used to define the data source of the specified test

Refer to ResultSource definition for any enumerations.

(sequence)

The sequence of items below is mandatory. A single instance is required.

DetailValue

DetailValue is mandatory. A single instance is required.

A numeric value expressed in the unit of measure (UOM).

DetailRangeMin

DetailRangeMin is optional. A single instance might exist.

The minimum value (lower boundary) allowed for the DetailValue that is the parent of this element.

DetailRangeMax

DetailRangeMax is optional. A single instance might exist.

The maximum value (upper boundary) allowed for the DetailValue that is the

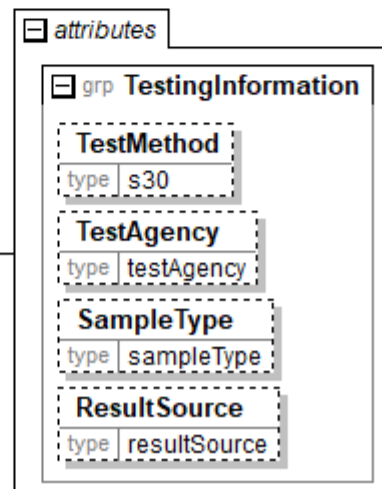
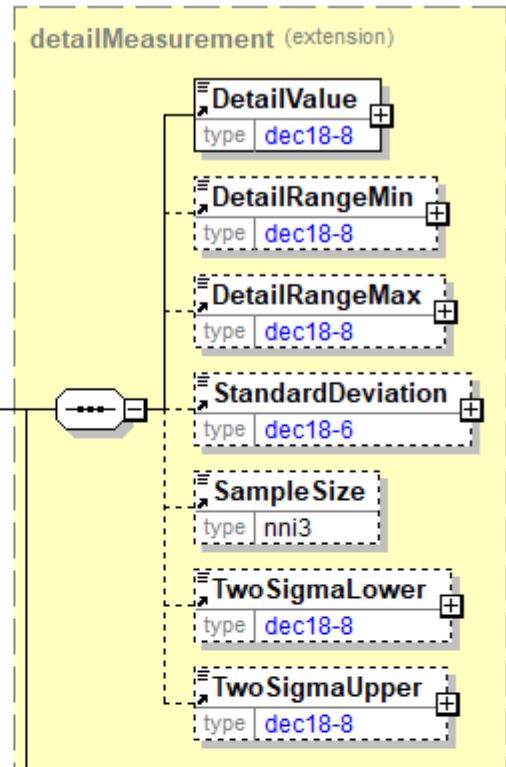
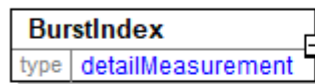

parent of this element.

StandardDeviation

StandardDeviation is optional. A single instance might exist.

A statistic used as a measure of dispersion in a distribution.

SampleSize

SampleSize is optional. A single instance might exist.

The number of samples used to determine the product characteristic in question.

TwoSigmaLower

TwoSigmaLower is optional. A single instance might exist.

Two sigma (a measure of dispersion associated with standard deviation) on the lower side of the standard deviation.

TwoSigmaUpper

TwoSigmaUpper is optional. A single instance might exist.

Two sigma (a measure of dispersion associated with standard deviation) on the upper side of the standard deviation.

BusinessAcceptance

The BusinessAcceptance element is the root element for the BusinessAcceptance e-Document.

The receiver of a document uses the BusinessAcceptance to confirm to the sender that the document is accepted or rejected after processing the document in the receiver's ERP system. Some business cases might require manual actions before the BusinessAcceptance can be issued.

The BusinessAcceptance can be used as a confirmation of acceptance when there is not a papiNet confirmation e-Document available. Although the BusinessAcceptance is optional between two trading partners, its use is strongly recommended when it is important to get a business acceptance, e.g. if a received DeliveryInstruction will be executed or not.

BusinessAcceptanceStatus [attribute]

BusinessAcceptanceStatus is mandatory. A single instance is required.

Defines if the document content has been accepted or rejected after processing in the receiver's ERP system.

Refer to BusinessAcceptanceStatus definition for any enumerations.

Language [attribute]

Language is optional. A single instance might exist.

The valid Alpha 2- and Alpha 3-character list of language codes in the ISO 639-1 and 639-2 international standards.

Information on the content of this attribute is available at:
https://www.loc.gov/standards/iso639-2/php/code_list.php

(sequence)

The sequence of items below is mandatory. A single instance is required.

BusinessAcceptanceNumber

BusinessAcceptanceNumber is mandatory. A single instance is required.

The unique identifier for the BusinessAcceptance.

BusinessAcceptanceDate

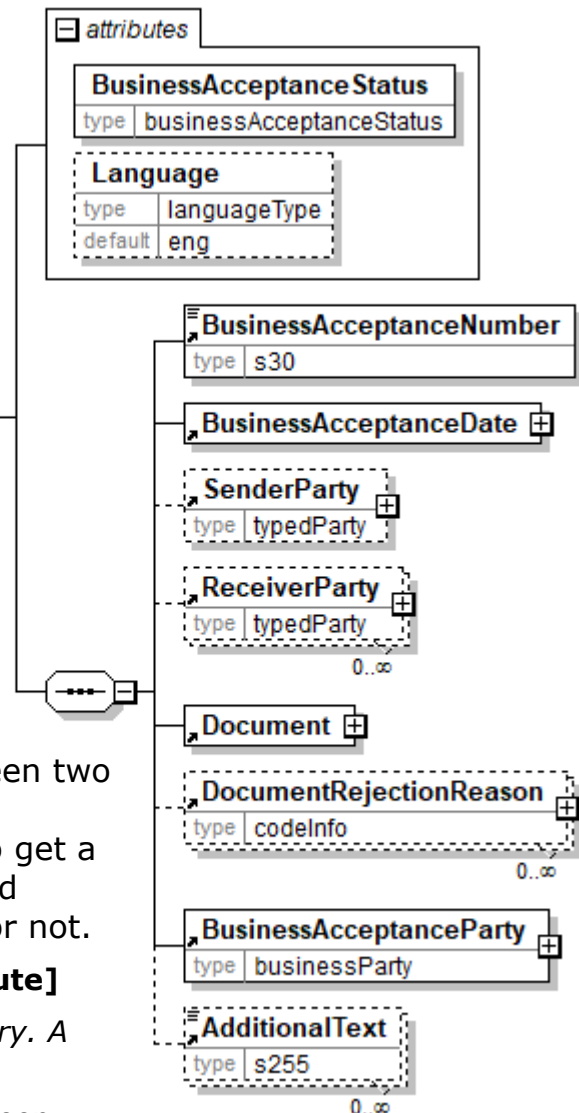

papiNet V2R31

BusinessAcceptanceDate is mandatory. A single instance is required.

The Date and Time when the BusinessAcceptance was issued.

SenderParty

SenderParty is optional. A single instance might exist.

The business entity issuing the e-Document, the source of the document.

The entity responsible for the content. If the sender party has out sourced the message service to a third party the SenderParty is the issuer of the e-Document and not the party performing the transmission service of the electronic message.

ReceiverParty

ReceiverParty is optional. Multiple instances might exist.

The business entity for whom the e-Document is intended, the destination of the document.

The entity interested in the content. If the receiver party has outsourced the message service to a third party the ReceiverParty is the intended party for the e-Document and not the party performing the receiving service of the electronic message.

Document

Document is mandatory. A single instance is required.

A group item containing information applicable to the original document.

DocumentRejectionReason

DocumentRejectionReason is optional. Multiple instances might exist.

A grouping element that contains information about the rejection reason for the document that is rejected.

BusinessAcceptanceParty

BusinessAcceptanceParty is mandatory. A single instance is required.

The organisation or legal entity authorised to accept or reject e-Document.

AdditionalText

AdditionalText is optional. Multiple instances might exist.

A text field that is used to communicate information not previously defined or for special instructions. To be used only for circumstances not covered by specific elements.

BusinessAcceptanceDate

The Date and Time when the BusinessAcceptance was issued.

(sequence)

The sequence of items below is mandatory. A single instance is required.

Date

Date is mandatory. A single instance is required.

A group element that contains the specification of Year, Month, and Day.

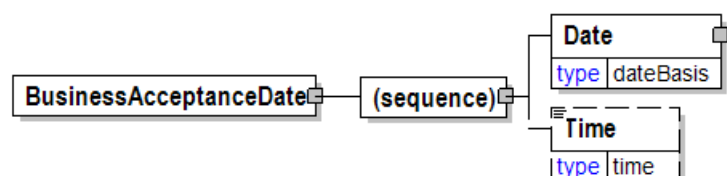

papiNet V2R31

Time

Time is optional. A single instance might exist.

Times are treated in a standard XML fashion with a special case used to indicate a generalized "local" time. The standard XML approach to time is hh:mm:ss, hh:mm:ssZ, or hh:mm:ss±hh:mm.

hh:mm:ss±hh:mm is used to represent a time with a time zone. The time zone is communicated as the number of hours offset from the Universal Time Coordinate (UTC), a.k.a. Greenwich Mean Time.

hh:mm:ssZ indicates the time at Zulu (another name for UTC).

hh:mm:ss or hh:mm indicates within papiNet the applicable local time where the associated event is taking place. Caution should be used when processing times of this nature as the papiNet approach may be in discord with other users of XML.

BusinessAcceptanceNumber

The unique identifier for the BusinessAcceptance.

BusinessAcceptanceNumber	
type	s30

BusinessAcceptanceParty

The organisation or legal entity authorised to accept or reject e-Document.

PartyType [attribute]

PartyType is mandatory. A single instance is required.

Identifies the business role associated with the particular party

Refer to PartyType definition for any enumerations.

(sequence)

The sequence of items below is mandatory. A single instance is required.

PartyIdentifier

PartyIdentifier is mandatory. One instance is required, multiple instances might exist.

A unique identifier of a specific party. This element contains an attribute PartyIdentifierType that indicates the type of the identifier.

NameAddress

NameAddress is mandatory. A single instance is required.

A group item containing name and address of an organisation or business entity.

URL

URL is optional. A single instance might exist.

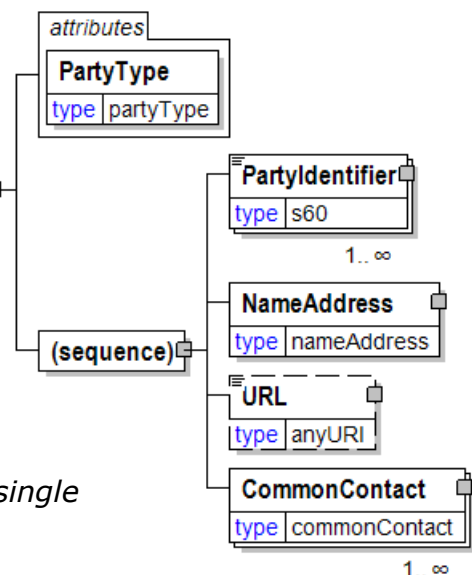

papiNet V2R31

Universal Resource Locator. While typically a web address you could use this field to hold an email address.

CommonContact

CommonContact is mandatory. One instance is required, multiple instances might exist.

Identifies a specific individual associated with the party.

BusinessAcceptanceStatus [attribute]

Defines if the document content has been accepted or rejected after processing in the receiver's ERP system.

BusinessAcceptanceStatus	
type	businessAcceptanceStatus

This item is restricted to the following list.

Accepted

Indicates that the document content has been accepted after processing in the receiver's ERP system.

Rejected

Indicates that the document content has been rejected after processing in the receiver's ERP system.

BusinessAcknowledgement

The BusinessAcknowledgement element is the root element for the BusinessAcknowledgement e-Document.

A document receiver uses the BusinessAcknowledgement to notify the sender that a document has been presented to the receiver's ERP system. The Status with value Success or Failure specifies if the document content has been validated without or with errors when presented to the receiver's ERP system. The BusinessAcknowledgement can be used to acknowledge both papiNet e-Documents and other XML documents. Although the BusinessAcknowledgement is optional between two trading partners, its use is strongly recommended since it provides positive verification of the beginning of the transaction by the receiver.

BusinessAcknowledgement

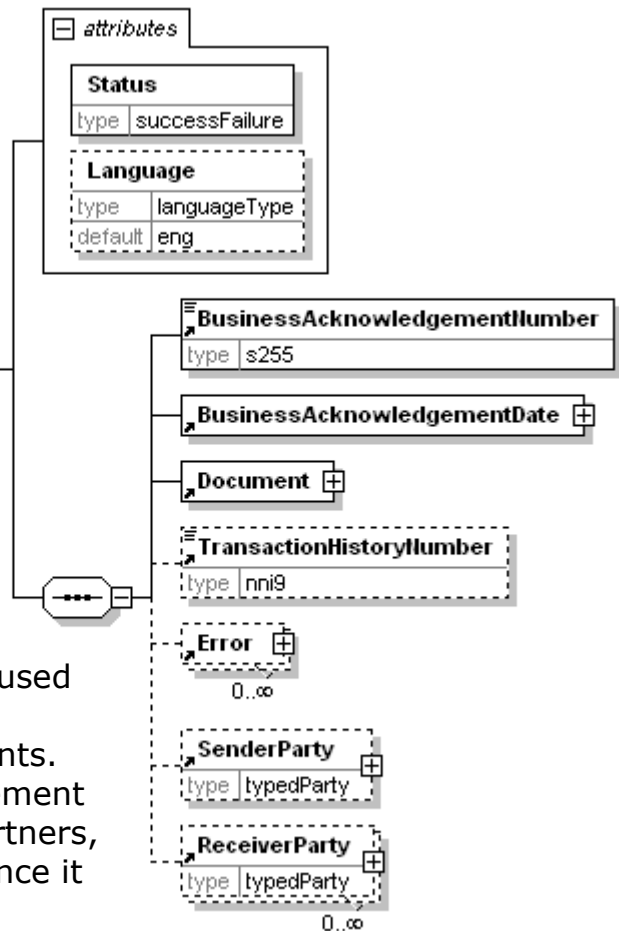

Status [attribute]

Status is mandatory. A single instance is required.

Defines if the document content has been successfully validated or not when presented to the receiver's ERP system. The validation can be carried out against the agreed specification of the document content, the papiNet Business Rules and agreed specific Business Rules applicable to the receiver's ERP system.

N.B. Validation of the document content can be successful even though processing of the document in the receiver's ERP system would fail because of deficiencies or insufficient data in the ERP system.

Refer to Status definition for any enumerations.

Language [attribute]

Language is optional. A single instance might exist.

The valid Alpha 2- and Alpha 3-character list of language codes in the ISO 639-1 and 639-2 international standards.

Information on the content of this attribute is available at:
https://www.loc.gov/standards/iso639-2/php/code_list.php

(sequence)

papiNet V2R31

The sequence of items below is mandatory. A single instance is required.

BusinessAcknowledgementNumber

BusinessAcknowledgementNumber is mandatory. A single instance is required.

The unique identifier for the BusinessAcknowledgement.

BusinessAcknowledgementDate

BusinessAcknowledgementDate is mandatory. A single instance is required.

The Date and Time when the BusinessAcknowledgement was issued.

Document

Document is mandatory. A single instance is required.

A group item containing information applicable to the original document.

TransactionHistoryNumber

TransactionHistoryNumber is optional. A single instance might exist.

TransactionHistoryNumber in BusinessAcknowledgement will be deprecated in a future version V3R00 and should not be used in new implementations.

Error

Error is optional. Multiple instances might exist.

A group item that details the errors that are delaying processing on an original document.

SenderParty

SenderParty is optional. A single instance might exist.

The business entity issuing the e-Document, the source of the document.

The entity responsible for the content. If the sender party has out sourced the message service to a third party the SenderParty is the issuer of the e-Document and not the party performing the transmission service of the electronic message.

ReceiverParty

ReceiverParty is optional. Multiple instances might exist.

The business entity for whom the e-Document is intended, the destination of the document.

The entity interested in the content. If the receiver party has outsourced the message service to a third party the ReceiverParty is the intended party for the e-Document and not the party performing the receiving service of the electronic message.

BusinessAcknowledgementDate

The Date and Time when the BusinessAcknowledgement was issued.

(sequence)

The sequence of items below is mandatory. A single instance is required.

Date

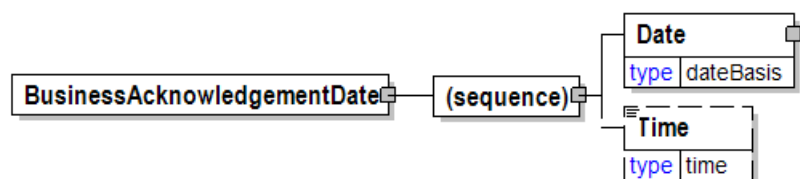

papiNet V2R31

Date is mandatory. A single instance is required.

A group element that contains the specification of Year, Month, and Day.

Time

Time is optional. A single instance might exist.

Times are treated in a standard XML fashion with a special case used to indicate a generalized "local" time. The standard XML approach to time is hh:mm:ss, hh:mm:ssZ, or hh:mm:ss±hh:mm.

hh:mm:ss±hh:mm is used to represent a time with a time zone. The time zone is communicated as the number of hours offset from the Universal Time Coordinate (UTC), a.k.a. Greenwich Mean Time.

hh:mm:ssZ indicates the time at Zulu (another name for UTC).

hh:mm:ss or hh:mm indicates within papiNet the applicable local time where the associated event is taking place. Caution should be used when processing times of this nature as the papiNet approach may be in discord with other users of XML.

BusinessAcknowledgementNumber

The unique identifier for the BusinessAcknowledgement.

BusinessAcknowledgementNumber	
type	s255

BusinessChainContextType [attribute]

Indicates the nature of what is included in the business chain.

This item is restricted to the following list.

LogisticsService

The business chain is exclusively for logistics business.

Product

The business chain is exclusively for product business.

attributes	
BusinessChainContextType	
type	businessChainContextType

BusinessChainDescription

A text describing a business chain.

BusinessChainDescription	
type	s255

BusinessChainInfo

A grouping element that contains information about parties in the business chain when products or services are traded in many levels.

The business chain starts at the sourcing end where products are provided when BusinessChainContextType = Product.

The business chain starts at the purchasing of a service from the OriginalLogisticsSupplier when BusinessChainContextType = LogisticsService.

BusinessChainContextType [attribute]

BusinessChainContextType is mandatory. A single instance is required.

Indicates the nature of what is included in the business chain.

Refer to BusinessChainContextType definition for any enumerations.

AssignedBy [attribute]

AssignedBy is optional. A single instance might exist.

Identifies the type of party or the agency that has assigned the associated item, e.g. a reference of type OrderNumber.

Refer to AssignedBy for any enumerations.

ValidityStatus [attribute]

ValidityStatus is mandatory. A single instance is required.

The validity status for a specific item.

Refer to ValidityStatus for any enumerations.

(sequence)

The sequence of items below is mandatory. A single instance is required.

BusinessChainNumber

BusinessChainNumber is optional. A single instance might exist.

The unique identifier of a business chain.

BusinessChainDescription

BusinessChainDescription is optional. Multiple instances might exist.

A text describing a business chain.

OtherParty

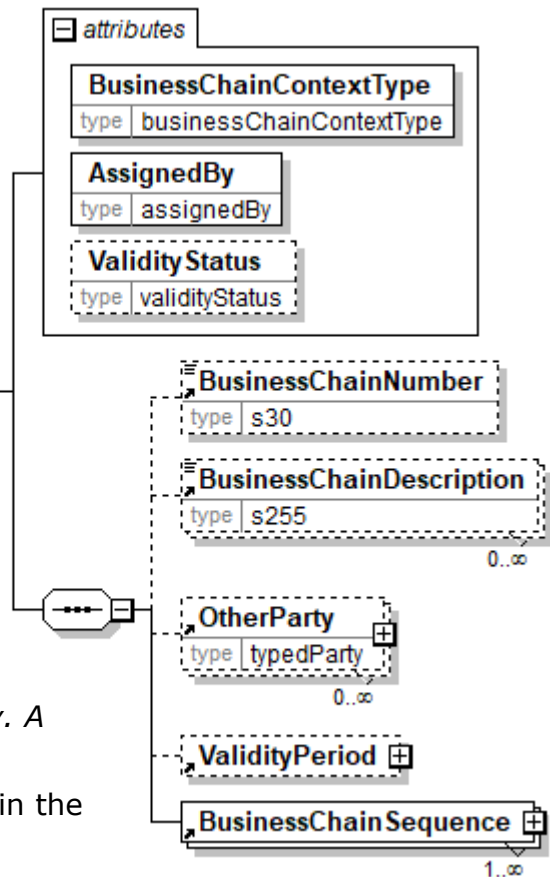

papiNet V2R31

OtherParty is optional. Multiple instances might exist.

An organisation or business entity other than those specifically detailed within an e-Document.

ValidityPeriod

ValidityPeriod is optional. A single instance might exist.

The validity period for a specific item, e.g. the validity period for an e-Document.

BusinessChainSequence

BusinessChainSequence is mandatory. One instance is required, multiple instances might exist.

A grouping element that specifies parties in a level of trade.

BusinessChainNumber

The unique identifier of a business chain.



BusinessChainReferenceID

Specifies a reference to a Business Chain.

AssignedBy [attribute]

AssignedBy is mandatory. A single instance is required.

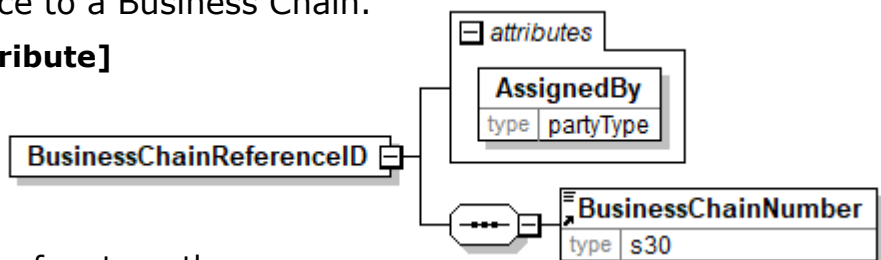

Identifies the type of party or the agency that has assigned the associated item, e.g. a reference of type OrderNumber.

Refer to AssignedBy for any enumerations.

(sequence)

The sequence of items below is mandatory. A single instance is required.

BusinessChainNumber

BusinessChainNumber is mandatory. A single instance is required.

The unique identifier of a business chain.

BusinessChainSequence

A grouping element that specifies parties in a level of trade.

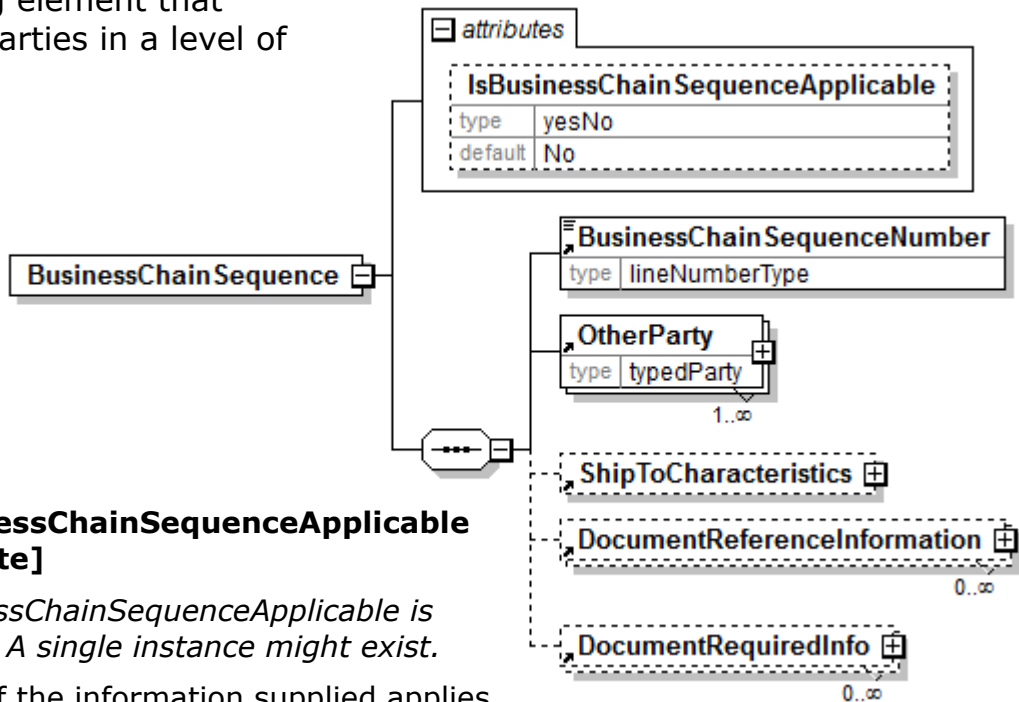

IsBusinessChainSequenceApplicable [attribute]

IsBusinessChainSequenceApplicable is optional. A single instance might exist.

Defines if the information supplied applies to the BusinessChainSequence or not.

Refer to IsBusinessChainSequenceApplicable definition for any enumerations.

(sequence)

The sequence of items below is mandatory. A single instance is required.

BusinessChainSequenceNumber

BusinessChainSequenceNumber is mandatory. A single instance is required.

A sequential number that uniquely identifies the sequence of a business chain. BusinessChainSequenceNumber has values 1, 2, 3, 4 etc.. The business chain starts at the sourcing end where products are provided.

OtherParty

OtherParty is mandatory. One instance is required, multiple instances might exist.

An organisation or business entity other than those specifically detailed within an e-Document.

ShipToCharacteristics

ShipToCharacteristics is optional. A single instance might exist.

A group item that provides information important for the Ship-To Party.

DocumentReferenceInformation

DocumentReferenceInformation is optional. Multiple instances might exist.

A group item containing reference information applicable to a document.

DocumentRequiredInfo

DocumentRequiredInfo is optional. Multiple instances might exist.

A group element that contains information about documents needed by parties in the business process.

BusinessChainSequenceNumber

A sequential number that uniquely identifies the sequence of a business chain. BusinessChainSequenceNumber has values 1, 2, 3, 4 etc.. The business chain starts at the sourcing end where products are provided.

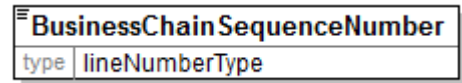

BusinessPartyProperty

A grouping element that contains a specification of a property for a business party.

Agency [attribute]

Agency is mandatory. A single instance is required.

Describes the agency maintaining the list of codes. To be included in this list the agency must be a recognized standards body or industry organisation.

- For the element that owns this attribute.
- For another attribute in the list of attributes associated with the parent element.

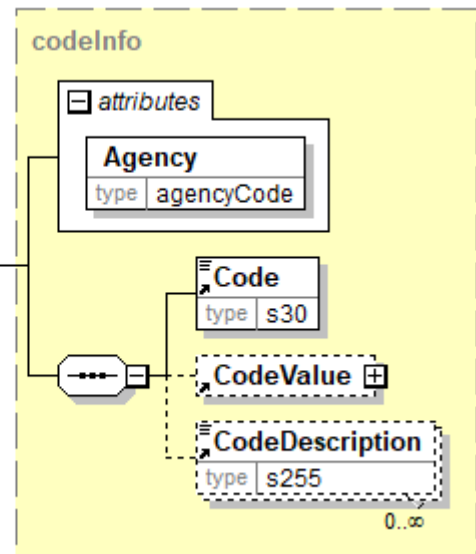

Refer to Agency definition for any enumerations.

(sequence)

The sequence of items below is mandatory. A single instance is required.

Code

Code is mandatory. A single instance is required.

Specifies a code that is defined by an agency. The agency is given for the whole construct containing the code.

CodeValue

CodeValue is optional. A single instance might exist.

A grouping element specifying a value belonging to a code that is defined by an agency.

CodeDescription

CodeDescription is optional. Multiple instances might exist.

A textual description for the meaning of a code that is defined by an agency. When the Code is associated with a CodeValue of type TextValue, then the CodeDescription is a textual description of both the Code and the TextValue.

BusinessPartyType

Identifies a business role associated with a business party.

BusinessPartyType	
type	businessPartyType

This item is restricted to the following list.

Auditor

A third party that is authorized for making audits and checkings.

Bank

The banking representative.

BillTo

The address where the invoice is to be sent. (Not to be used for logistics BillTo, see LogisticsBillTo.)

Broker

The organisation acting as a broker for the buyer or supplier.

BusinessChainParty

The organisation or business entity responsible for managing the business chain between business partners when trading of products in many levels of trade.

Buyer

The legal entity to which the product is sold. Also commonly referred to as the sold-to party or customer. If no OtherParty is defined as the "Payer", the "Buyer" is the "Payer". (Not to be used for logistics buyer, see LogisticsBuyer.)

BuyerAgent

The entity acting for the buyer in the transaction. (Not to be used for logistics BuyerAgent, see LogisticsBuyerAgent.)

Carrier

The organisation or business entity that transports goods.

CarrierAssignmentResponsible

The organisation to which the carrier has assigned some task.

ComponentVendor

Vendor producing supplied components.

Compositor

Party that formats written material and illustrations for printing or electronic display.

Consuming

The eventual consumer of the material

ContractParty

The organisation or business entity responsible for managing the contract between business partners.

Converter

The organisation responsible for changing one form of paper into another form, providing specialised functions not available to the supplier.

CreditDepartment

The party responsible for credit authorization.

CrossDock

A third party involved in the transport of goods.

Customs

Any customs agency.

CustomsForwarder

A forwarder responsible for managing the transfer of goods through customs.

DeliveryPlanningParty

The organisation responsible for planning of deliveries to delivery destinations.

DomesticForwarder

A forwarder responsible for managing the transfer of goods.

EndUser

EndUser is the party using, consuming, or converting the product. For example, a printer using paper reels to print a job for a publisher (printer is the end user). The final ShipTo destination for a product is normally to the EndUser facilities.

ExportForwarder

A forwarder responsible for managing the export process.

ForestForwarder

The party that transports forest wood products from logging areas to roadside landings.

ForestForwardingRequestor

The party requesting forest forwarding services.

ForestHarvester

The party that harvests forest wood products at logging areas.

ForestHarvestingRequestor

The party requesting forest harvesting services.

Forwarder

The party responsible for shipping arrangements.

FreightPayer

The party responsible for paying freight.

Insurer

The party providing insurance coverage for the goods.

Landowner

The party who owns the land upon which the product was produced.

LoadingOperator

A party that is carrying out loading of transport units.

LoggingArea

A geographic location in the forest where logging takes place.

LogisticsBillTo

The address where the logistics invoice is to be sent.

LogisticsBuyer

The buyer of logistics services. The legal entity to which the service is sold. Also commonly referred to as the sold-to party or customer. If no OtherParty is defined as the "LogisticsPayer", the "LogisticsBuyer" is the payer.

LogisticsBuyerAgent

The entity acting for the logistics buyer in the transaction.

LogisticsPayee

The party handling and receiving logistics payments on behalf of another party.

LogisticsPayer

The party handling and sending logistics payments of behalf of another party.

LogisticsPlanningParty

The organisation responsible for planning of logistics services.

LogisticsSeller

The seller of logistics services. LogisticsSupplier is the seller of the service, if logistics seller is not specified as OtherParty = LogisticsSeller.

LogisticsServiceProvider

A party that is responsible for a service in logistics business.

LogisticsSupplier

The party responsible for providing the logistics services. LogisticsSupplier is also the seller of the service, if logistics seller is not specified as OtherParty = LogisticsSeller.

MainCarrier

The primary carrier involved in the movement of goods.

MainForestForwarder

The party responsible for transporting forest wood products from logging areas to roadside landings.

MainForestHarvester

The party responsible for harvesting of forest wood products at logging areas.

Measurer

The party that that is carrying out the measurement of the quantity and/or quality of the products. It can be a person, a piece of equipment or a device.

MeasuringParty

The party that is responsible for the measurements at the measuring location.

Merchant

A third party buying and reselling products.

NotifyParty

A party that needs to be notified of the status of the transaction.

OnBehalfOf

The activity in question is being made on behalf of this party.

OrderParty

The organisation or business entity placing the order if different from the buyer party.

OriginalBuyer

The first buyer in a supply chain. OriginalBuyer is only used when the first buyer in a supply chain needs to be specified in other e-documents than e-documents belonging to the first level of trade. (Not to be used for the first buyer in a supply chain of logistics, see OriginalLogisticsBuyer.)

OriginalBuyerAgent

The entity acting for the OriginalBuyer in the transaction. OriginalBuyerAgent is only used when the first buyer agent in a supply chain needs to be specified in other e-documents than e-documents belonging to the first level of trade. (Not to be used for the first buyer agent in a supply chain of logistics, see OriginalLogisticsBuyerAgent.)

OriginalLogisticsBuyer

The first logistics buyer in a supply chain of logistics. OriginalLogisticsBuyer is only used when the first logistics buyer in a supply chain of logistics needs to be specified in other e-documents than e-documents belonging to the first level of logistics trade.

OriginalLogisticsBuyerAgent

The entity acting for the OriginalLogisticsBuyer in the transaction. OriginalLogisticsBuyerAgent is only used when the first logistics buyer agent in a supply chain of logistics needs to be specified in other e-documents than e-documents belonging to the first level of logistics trade.

OriginalLogisticsSeller

The first logistics seller in a supply chain of logistics. OriginalLogisticsSupplier is the OriginalLogisticsSeller of the service, if OriginalLogisticsSeller is not specified as OtherParty = OriginalLogisticsSeller. OriginalLogisticsSeller is only used when the first logistics seller in a supply chain of logistics needs to be specified in other e-documents than e-documents belonging to the first level of logistics trade.

OriginalLogisticsSupplier

The first logistics supplier in a supply chain of logistics. OriginalLogisticsSupplier is also the OriginalLogisticsSeller of the service, if OriginalLogisticsSeller is not specified as OtherParty = OriginalLogisticsSeller. OriginalLogisticsSupplier is only used when the first logistics supplier in a supply chain of logistics needs to be specified in other e-documents than e-

documents belonging to the first level of logistics trade.

OriginalOrderParty

Party which ordered the product from the Party sending the first level PurchaseOrder in an indirect purchase order process.

OriginalSeller

The first seller in a supply chain. OriginalSupplier is the OriginalSeller of the product, if OriginalSeller is not specified as OtherParty = OriginalSeller. OriginalSeller is only used when the first seller in a supply chain needs to be specified in other e-documents than e-documents belonging to the first level of trade. (Not to be used for the first seller in a supply chain of logistics, see OriginalLogisticsSeller.)

OriginalSupplier

The first supplier in a supply chain. OriginalSupplier is also the OriginalSeller of the product, if OriginalSeller is not specified as OtherParty = OriginalSeller. OriginalSupplier is only intended to identify the business party, not the origin of the product. OriginalSupplier is only used when the first supplier in a supply chain needs to be specified in other e-documents than e-documents belonging to the first level of trade. (Not to be used for the first supplier in a supply chain of logistics, see OriginalLogisticsSupplier.)

Payee

The party handling and receiving payments on behalf of another party. (Not to be used for logistics payee, see LogisticsPayee.)

Payer

The party handling and sending payments of behalf of another party. (Not to be used for logistics payer, see LogisticsPayer.)

PreCarrier

The party responsible for activities prior to carrier accepting the goods (but after shipping has taken place).

PriceListParty

The organization or business entity responsible managing for the price list between business partners.

Producer

The manufacturer of the goods.

ProductAgency

Organization responsible for defining unique product identifiers.

ProFormaInvoice

The organisation or business entity to which the pro-forma invoice will be sent.

Publisher

Individual or corporation responsible for the printing and distribution of digital or printed publications.

RemitTo

The organisation or business entity to which payment will be made.

Requestor

The originator of the original PurchaseOrder requisition (for example, a printing plant ordering through a central purchasing organisation).

RoadKeeper

The party who is responsible for the maintenance of the road.

RoadOwner

The party who is the legal owner of the road.

SalesAgent

The organisation or person responsible for product sales acting on behalf of the seller.

SalesOffice

The functional unit in an organisation or business entity that is responsible for product sales.

Seller

The seller of the product. SupplierParty is the seller of the product, if Seller is not specified as OtherParty = Seller. (Not to be used for logistics seller, see LogisticsSeller.)

ServiceProvider

The party that is responsible for a service in product business.

ShipOwner

The owner of the vessel used to ship the goods.

SubCarrier

A sub carrier of another the shipping company.

Supplier

The organisation or business entity responsible for providing the product. SupplierParty is also the seller of the product, if Seller is not specified as OtherParty = Seller. (Not to be used for logistics supplier, see LogisticsSupplier.)

SupplyRequirementPlanningParty

The organisation responsible for planning of supply requirements for industries depending on their needs.

TerminalOperator

The party providing facilities such as loading, unloading, or warehousing.

UnloadingOperator

A party that is carrying out unloading of transport units.

WarehouseOperator

The party operating a warehouse.

BuyerParty

The legal entity to which the product is sold. Also commonly referred to as the sold-to party or customer. If no OtherParty is defined as the Payer, the Buyer is the Payer.

LogisticsRole [attribute]

LogisticsRole is optional. A single instance might exist.

Communicates the nature of the logistics role, if any, the party plays in the transaction.

Refer to LogisticsRole definition for any enumerations.

(sequence)

The sequence of items below is mandatory. A single instance is required.

PartyIdentifier

PartyIdentifier is optional. Multiple instances might exist.

A unique identifier of a specific party. This element contains an attribute PartyIdentifierType that indicates the type of the identifier.

NameAddress

NameAddress is mandatory. A single instance is required.

A group item containing name and address of an organisation or business entity.

URL

URL is optional. A single instance might exist.

Universal Resource Locator. While typically a web address you could use this field to hold an email address.

CommonContact

CommonContact is optional. Multiple instances might exist.

Identifies a specific individual associated with the party.

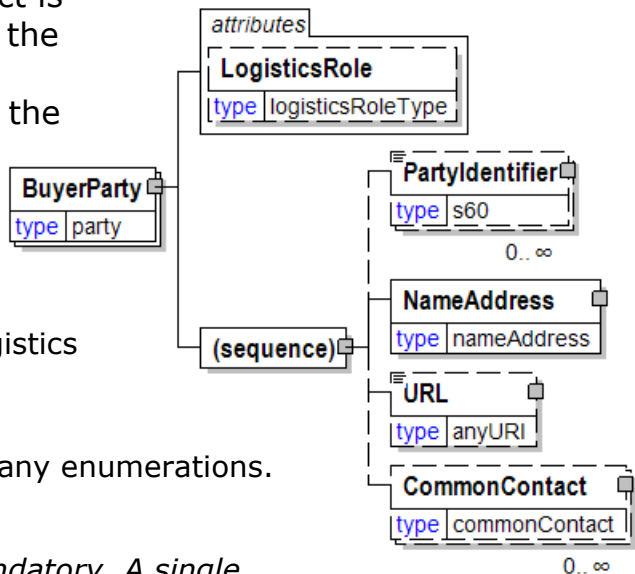

ByInvoice

Selection criteria for invoice information.

(choice)

[choice] is optional. Multiple instances might exist.

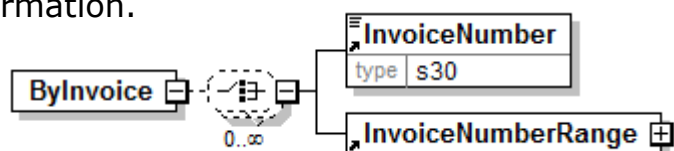

InvoiceNumber

InvoiceNumber is mandatory. A single instance is required.

The identification number of the Invoice, generated by the seller.

InvoiceNumberRange

InvoiceNumberRange is mandatory. A single instance is required.

papiNet V2R31

A range of invoices to be considered or reported on.

ByJob

Information about the job being communicated.

(sequence)

The sequence of items below is mandatory. A single instance is required.

JobID

JobID is optional. A single instance might exist.

An element used to communicate the unique identifier of the Job

JobDescription

JobDescription is optional. A single instance might exist.

A textual description of the job.

IssueOrEventID

IssueOrEventID is optional. A single instance might exist.

Used to communicate the identifier for a job.

EndUserParty

EndUserParty is optional. A single instance might exist.

The party using, consuming, or converting the product.

For example, a printer using paper reels for a print job for a publisher. The final ShipTo destination for a product is normally to the end user's facilities.

Quantity

Quantity is mandatory. A single instance is required.

The Quantity element contains attributes that provide information about the type of quantity that is being communicated, the context in which the particular quantity is to be viewed, and (if the quantity represents an adjustment) an adjustment type.

The Quantity element contains three child elements that enable you to communicate a range of values for the quantity and a target or actual value. It is at this level (Value, RangeMin, and RangeMax) that the unit of measure is specified. This permits the range to be specified in a different unit of measure than the target.

InformationalQuantity

InformationalQuantity is optional. Multiple instances might exist.

A quantity given in a valid UOM used for information purposes only (not for calculation). For example, an ordered quantity was 100 reels as opposed to the invoice quantity of 20,000 pounds.

JobDateTimeRange

JobDateTimeRange is optional. A single instance might exist.

The specification of the date range for the job.

PurchaseOrderDetail

PurchaseOrderDetail is optional. Multiple instances might exist.

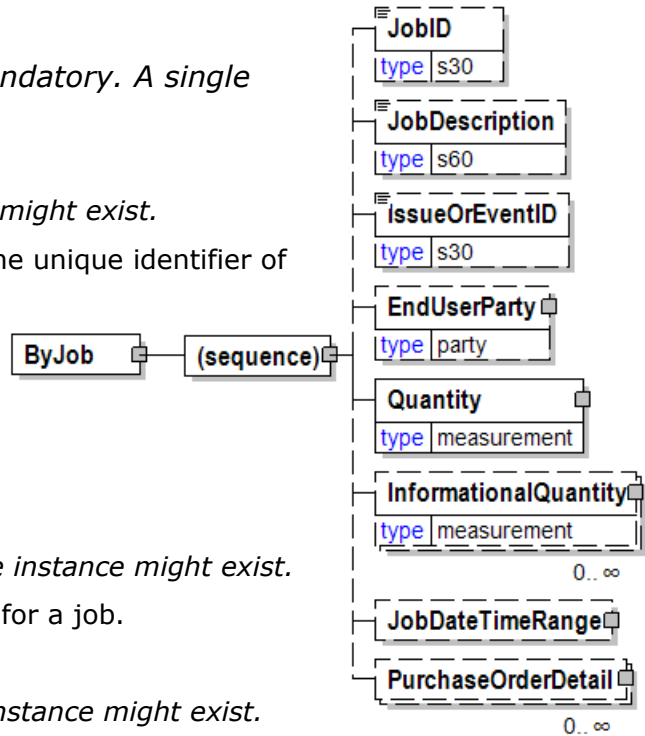

Multiple PurchaseOrderDetail instances are allowed.

ByLoad

By Load

ByLoadType [attribute]

ByLoadType is mandatory. A single instance is required.

By Load Type

Refer to ByLoadType definition for any enumerations.

(sequence)

The sequence of items below is mandatory. A single instance is required.

LoadNumber

LoadNumber is mandatory. A single instance is required.

An element used to communicate the unique identifier of the LoadNumber.

Quantity

Quantity is mandatory. A single instance is required.

The Quantity element contains attributes that provide information about the type of quantity that is being communicated, the context in which the particular quantity is to be viewed, and (if the quantity represents an adjustment) an adjustment type.

The Quantity element contains three child elements that enable you to communicate a range of values for the quantity and a target or actual value. It is at this level (Value, RangeMin, and RangeMax) that the unit of measure is specified. This permits the range to be specified in a different unit of measure than the target.

InformationalQuantity

InformationalQuantity is optional. Multiple instances might exist.

A quantity given in a valid UOM used for information purposes only (not for calculation). For example, an ordered quantity was 100 reels as opposed to the invoice quantity of 20,000 pounds.

ShipmentLoadDetails

ShipmentLoadDetails is optional. Multiple instances might exist.

A group element that containing information that relates to the shipment load details for the line item. Carrier and transport information may be detailed.

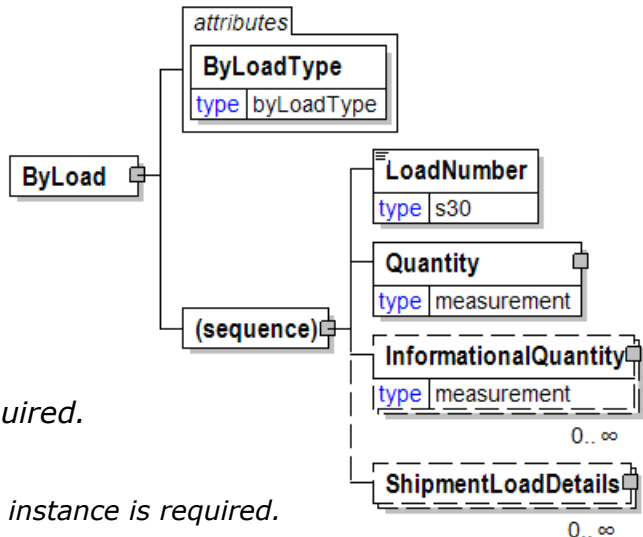

ByLoadType [attribute]

By Load Type

This item is restricted to the following list.

Forecast

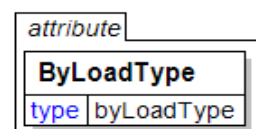

The load is projected.

Shipment

The load is actually shipped.

ByPeriod

Specifies that the information is supplied by a period.

(sequence)

The sequence of items below is mandatory. A single instance is required.

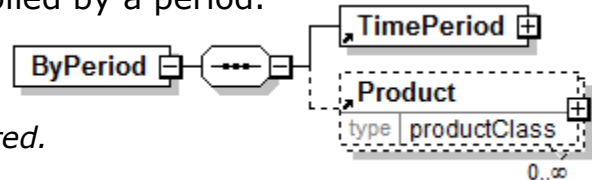

TimePeriod

TimePeriod is mandatory. A single instance is required.

The TimePeriod element is used to communicate a duration period of time as indicated in PeriodType.

Product

Product is optional. Multiple instances might exist.

Product is a group item defining the article and its characteristics. Product is used to specify product characteristics organized by ProductIdentifier, ProductDescription, and Classification. Book Manufacturing, Label Stock, Paper, Pulp, Recovered Paper, Wood Products, and Virgin Fibre market segments have defined their product characteristics and conversion features for implementation in papiNet.

ByProduct

Identification takes place by product.

(sequence)

The sequence of items below is mandatory. A single instance is required.

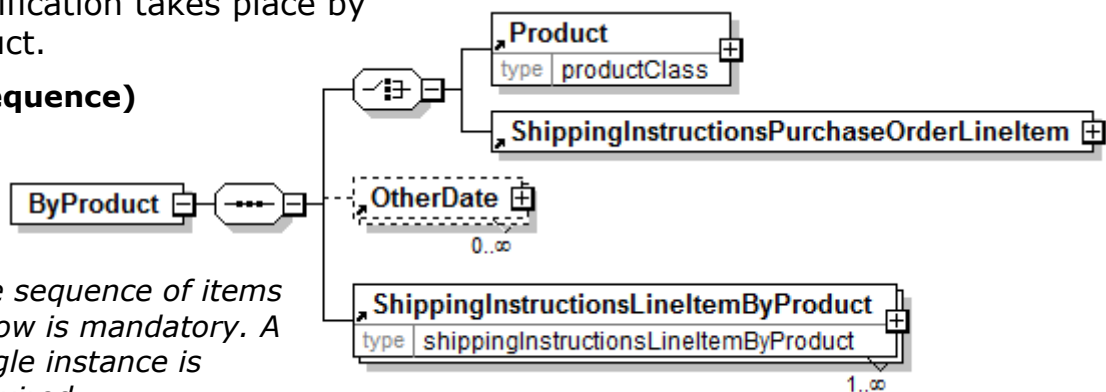

(choice)

[choice] is mandatory. A single instance is required.

Product

Product is mandatory. A single instance is required.

Product is a group item defining the article and its characteristics. Product is used to specify product characteristics organized by ProductIdentifier, ProductDescription, and Classification. Book Manufacturing, Label Stock, Paper, Pulp, Recovered Paper, Wood Products, and Virgin Fibre market segments have defined their product characteristics and conversion features for implementation in papiNet.

ShippingInstructionsPurchaseOrderLineItem

ShippingInstructionsPurchaseOrderLineItem is mandatory. A single instance is required.

PurchaseOrder line item information for purchase order being referenced in ShippingInstructions.

OtherDate

OtherDate is optional. More than one instance can occur.

A date that may not be specifically detailed within a document (example: print date at the PurchaseOrderLineItem).

ShippingInstructionsLineItemByProduct

ShippingInstructionsLineItemByProduct is mandatory. One instance is required, multiple instances might exist.

ShippingInstructionsLineItemByProduct

ByPurchaseOrder

Selection criteria for communicating purchase order

information.

(sequence)

The sequence of items below is mandatory. A single instance is required.

PurchaseOrderInformation

PurchaseOrderInformation is mandatory. A single instance is required.

A group item containing information unique to this PurchaseOrder, which is provided by the buyer. PurchaseOrderInformation can be optional in the supply chain. Invoices are created without having a PurchaseOrder in Vendor Managed Inventory. Freight invoices also will not have a PurchaseOrder number.

(choice)

[choice] is optional. Multiple instances might exist.

PurchaseOrderLineItemNumber

PurchaseOrderLineItemNumber is mandatory. A single instance is required.

The sequential number that uniquely identifies the PurchaseOrder line item.

Product

Product is mandatory. A single instance is required.

Product is a group item defining the article and its characteristics. Product is used to specify product characteristics organized by ProductIdentifier, ProductDescription, and Classification. Book Manufacturing, Label Stock, Paper, Pulp, Recovered Paper, Wood Products, and Virgin Fibre market segments have defined their product characteristics and conversion features for implementation in papiNet.

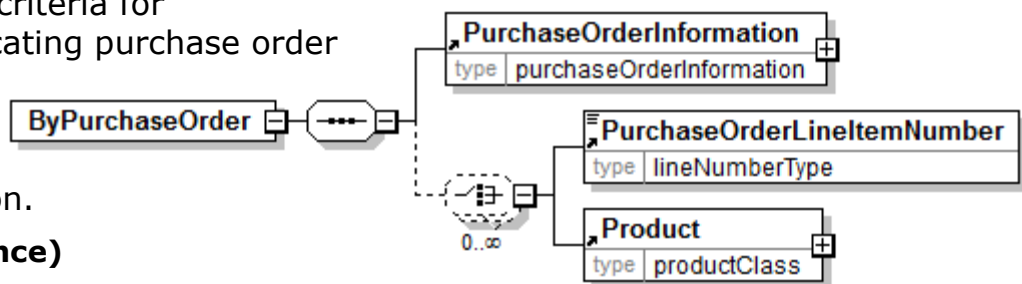

ByQualifiedDeliveryMessage

Specifies that the information is supplied by a DeliveryMessage. The use of the term “qualified” is to indicate that DeliveryMessageNumber is qualified by the use of DeliveryMessageLineNumber.

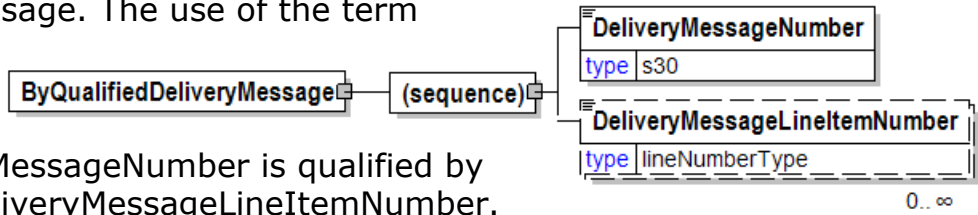

(sequence)

The sequence of items below is mandatory. A single instance is required.

DeliveryMessageNumber

DeliveryMessageNumber is mandatory. A single instance is required.

A unique delivery identifier assigned to each DeliveryMessage as agreed between the trading partners.

DeliveryMessageLineNumber

DeliveryMessageLineNumber is optional. Multiple instances might exist.

The sequential number that uniquely identifies the delivery line item.

ByQualifiedPurchaseOrderInformation

Specifies that the information is supplied by a PurchaseOrder. The use of the term

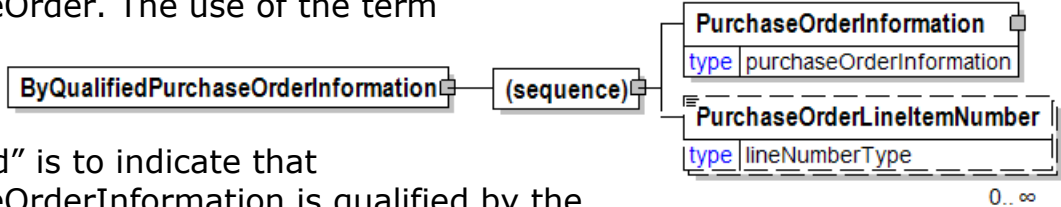

“qualified” is to indicate that PurchaseOrderInformation is qualified by the use of PurchaseOrderLineNumber.

(sequence)

The sequence of items below is mandatory. A single instance is required.

PurchaseOrderInformation

PurchaseOrderInformation is mandatory. A single instance is required.

A group item containing information unique to this PurchaseOrder, which is provided by the buyer. PurchaseOrderInformation can be optional in the supply chain. Invoices are created without having a PurchaseOrder in Vendor Managed Inventory. Freight invoices also will not have a PurchaseOrder number.

PurchaseOrderLineNumber

PurchaseOrderLineNumber is optional. Multiple instances might exist.

The sequential number that uniquely identifies the PurchaseOrder line item.

ByShipTo

ByShipTo

(sequence)

The sequence of items below is mandatory. A single instance is required.

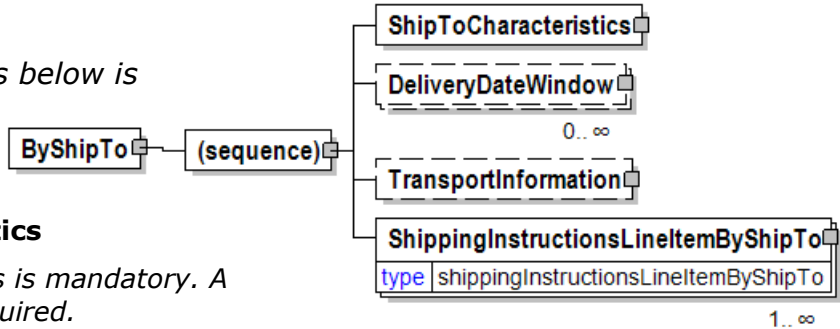

ShipToCharacteristics

ShipToCharacteristics is mandatory. A single instance is required.

A group item that provides information important for the Ship-To Party.

DeliveryDateWindow

DeliveryDateWindow is optional. Multiple instances might exist.

A group item defining the date/time interval for delivery to take place. An element which may contain the estimated date for which delivery is expected. This date is not absolute.

TransportInformation

TransportInformation is optional. A single instance might exist.

A grouping element for transport information.

ShippingInstructionsLineItemByShipTo

ShippingInstructionsLineItemByShipTo is mandatory. One instance is required, multiple instances might exist.

ShippingInstructions Line Item By Ship To

BySupplierOrder

Selection criteria for communicating Supplier Order information.

(sequence)

The sequence of items below is mandatory. A single instance is required.

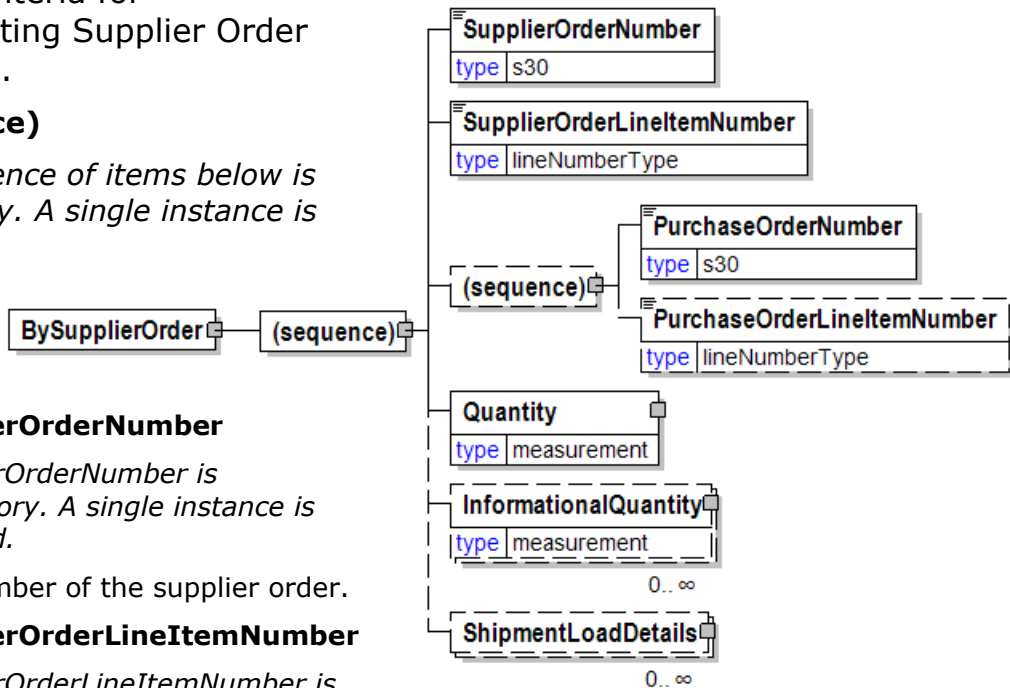

SupplierOrderNumber

SupplierOrderNumber is mandatory. A single instance is required.

The number of the supplier order.

SupplierOrderLineItemNumber

SupplierOrderLineItemNumber is

papiNet V2R31

mandatory. A single instance is required.

The number of the line item on the supplier order.

(sequence)

The sequence of items below is optional. A single instance might exist.

PurchaseOrderNumber

PurchaseOrderNumber is mandatory. A single instance is required.

The unique order identifier as designated by the customer.

PurchaseOrderLineItemNumber

PurchaseOrderLineItemNumber is optional. A single instance might exist.

The sequential number that uniquely identifies the PurchaseOrder line item.

Quantity

Quantity is mandatory. A single instance is required.

The Quantity element contains attributes that provide information about the type of quantity that is being communicated, the context in which the particular quantity is to be viewed, and (if the quantity represents an adjustment) an adjustment type.

The Quantity element contains three child elements that enable you to communicate a range of values for the quantity and a target or actual value. It is at this level (Value, RangeMin, and RangeMax) that the unit of measure is specified. This permits the range to be specified in a different unit of measure than the target.

InformationalQuantity

InformationalQuantity is optional. Multiple instances might exist.

A quantity given in a valid UOM used for information purposes only (not for calculation). For example, an ordered quantity was 100 reels as opposed to the invoice quantity of 20,000 pounds.

ShipmentLoadDetails

ShipmentLoadDetails is optional. Multiple instances might exist.

A group element that containing information that relates to the shipment load details for the line item. Carrier and transport information may be detailed.

BySupplierOrderNumber

Selection criteria for communicating Supplier Order information

(sequence)

The sequence of items below is mandatory. A single instance is required.

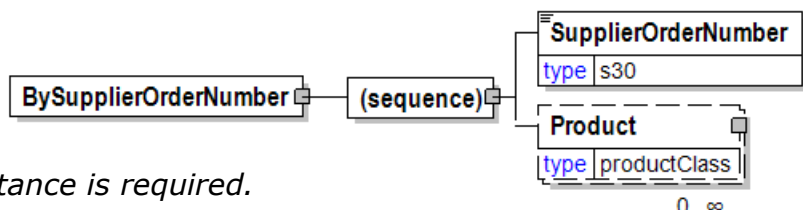

SupplierOrderNumber

SupplierOrderNumber is mandatory. A single instance is required.

The number of the supplier order.

Product

Product is optional. Multiple instances might exist.

papiNet V2R31

Product is a group item defining the article and its characteristics. Product is used to specify product characteristics organized by ProductIdentifier, ProductDescription, and Classification. Book Manufacturing, Label Stock, Paper, Pulp, Recovered Paper, Wood Products, and Virgin Fibre market segments have defined their product characteristics and conversion features for implementation in papiNet.

Calendar

The Calendar element is the root element for the Calendar e-Document.

The Calendar e-Document is intended to communicate opening times or other details for a location or locations.

CalendarType [attribute]

CalendarType is mandatory. A single instance is required.

Identifies the intention of the entire Calendar e-Document.

Refer to CalendarType definition for any enumerations.

CalendarStatus [attribute]

CalendarStatus is optional. A single instance might exist.

Identifies the status of the entire Calendar e-Document.

Refer to CalendarStatus definition for any enumerations.

Language [attribute]

Language is optional. A single instance might exist.

The valid Alpha 2- and Alpha 3-character list of language codes in the ISO 639-1 and 639-2 international standards.

Information on the content of this attribute is available at:
https://www.loc.gov/standards/iso639-2/php/code_list.php

(sequence)

The sequence of items below is mandatory. A single instance is required.

CalendarHeader

CalendarHeader is mandatory. A single instance is required.

A group item containing generic information applicable to the entire Calendar.

CalendarSequence

CalendarSequence is mandatory. One instance is required, multiple instances might exist.

A group item containing information that relates to a line on the Calendar.

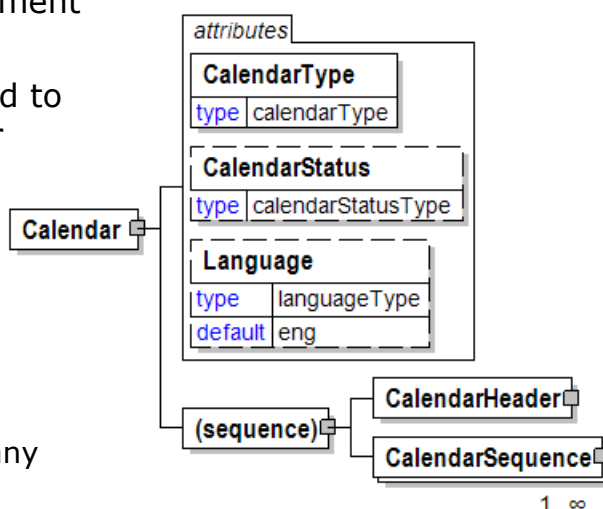

CalendarEntry

Detailed description of the times and contingencies for the given LocationParty.

CalendarEntryPeriod [attribute]

CalendarEntryPeriod is mandatory. A single instance is required.

Describes the period to which the given times and contingencies apply. This can be either a weekday or a date range. If it is a date range, the DateTimeRange element is used to specify the range.

Refer to CalendarEntryPeriod definition for any enumerations.

(sequence)

The sequence of items below is mandatory. A single instance is required.

TimeSlotInformation

TimeSlotInformation is mandatory. One instance is required, multiple instances might exist.

Description of the beginning and end of a time slot and the contingencies it contains.

DateTimeRange

DateTimeRange is optional. Multiple instances might exist.

Specifies a date and/or time range.

AdditionalText

AdditionalText is optional. Multiple instances might exist.

A text field that is used to communicate information not previously defined or for special instructions. To be used only for circumstances not covered by specific elements.

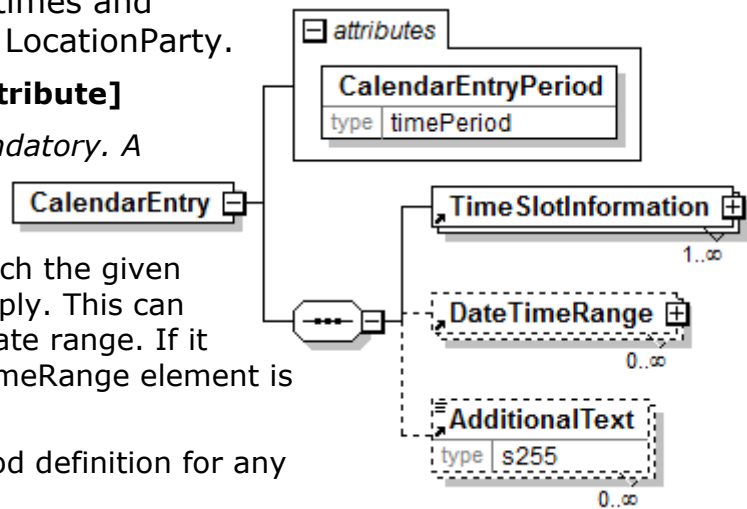

CalendarEntryPeriod [attribute]

Describes the period applicable to a time slot to which the given times and contingencies apply.

This item is restricted to the following list.

AllDays

All days

Monday

Monday

Tuesday

Tuesday

Wednesday

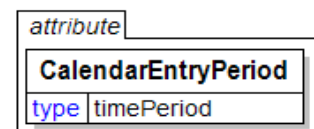

Wednesday

Thursday

Thursday

Friday

Friday

Saturday

Saturday

Sunday

Sunday

Workdays

Monday, Tuesday, Wednesday, Thursday and Friday excluding bank holidays (red days in the local calendar).

Weekend

Saturday and Sunday and bank holidays (red days in the local calendar).

DateTimeRange

To be deprecated in a future version V3R00. Use enumeration AllDays instead.

CalendarHeader

A group item containing generic information applicable to the entire Calendar.

(sequence)

The sequence of items below is mandatory. A single instance is required.

CalendarNumber

CalendarNumber is mandatory. A single instance is required.

The sequential number that uniquely identifies the Calendar e-Document.

CalendarIssueDate

CalendarIssueDate is mandatory. A single instance is required.

The date and optionally time when the Calendar e-Document was created.

TransactionHistoryNumber

TransactionHistoryNumber is optional. A single instance might exist.

A sequential number that keeps track of the version of a document.

However when the document is a confirmation document, in which case the TransactionHistoryNumber refers to the trigger transaction for the confirmation.

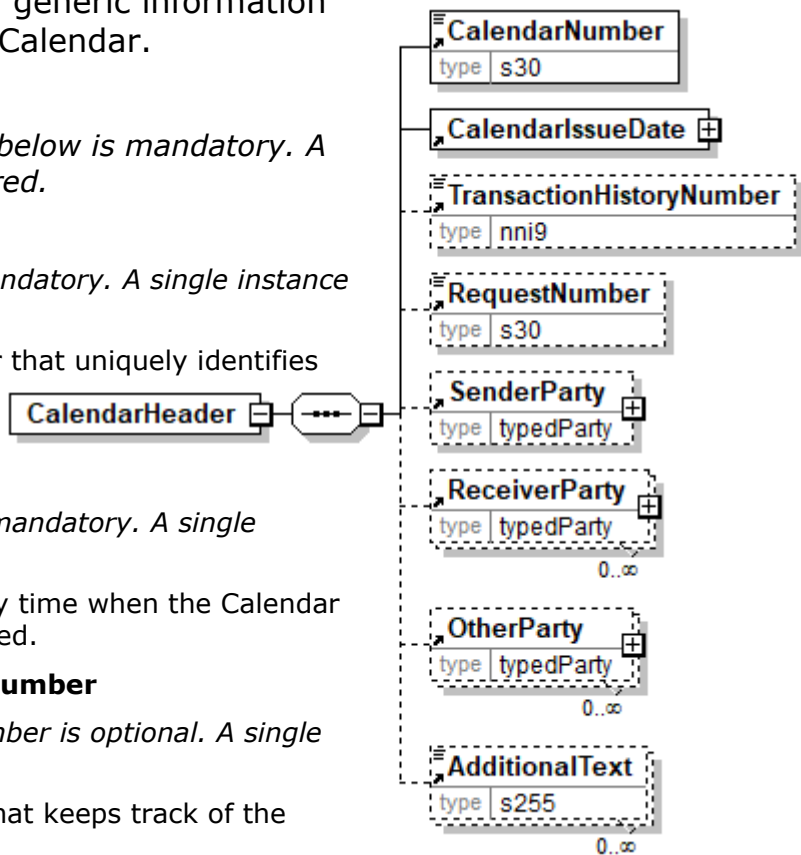

papiNet V2R31

RequestNumber

RequestNumber is optional. A single instance might exist.

A unique tracking number specifically identifying the InfoRequest e-Document to the originator. The tracking number is returned with the "information", the answer, to help match the answer to the request.

SenderParty

SenderParty is optional. A single instance might exist.

The business entity issuing the e-Document, the source of the document.

The entity responsible for the content. If the sender party has out sourced the message service to a third party the SenderParty is the issuer of the e-Document and not the party performing the transmission service of the electronic message.

ReceiverParty

ReceiverParty is optional. Multiple instances might exist.

The business entity for whom the e-Document is intended, the destination of the document.

The entity interested in the content. If the receiver party has outsourced the message service to a third party the ReceiverParty is the intended party for the e-Document and not the party performing the receiving service of the electronic message.

OtherParty

OtherParty is optional. Multiple instances might exist.

An organisation or business entity other than those specifically detailed within an e-Document.

AdditionalText

AdditionalText is optional. Multiple instances might exist.

A text field that is used to communicate information not previously defined or for special instructions. To be used only for circumstances not covered by specific elements.

CalendarIssueDate

The date and optionally time when the Calendar e-Document was created.

(sequence)

The sequence of items below is mandatory. A single instance is required.

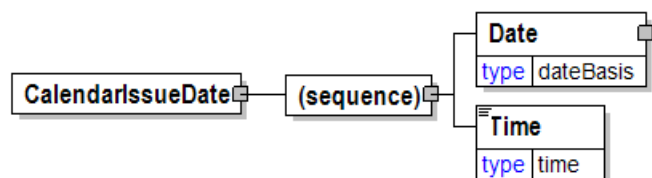

Date

Date is mandatory. A single instance is required.

A group element that contains the specification of Year, Month, and Day.

Time

Time is mandatory. A single instance is required.

Times are treated in a standard XML fashion with a special case used to indicate a generalized "local" time. The standard XML approach to time is hh:mm:ss,

papiNet V2R31

hh:mm:ssZ, or hh:mm:ss±hh:mm.

hh:mm:ss±hh:mm is used to represent a time with a time zone. The time zone is communicated as the number of hours offset from the Universal Time Coordinate (UTC), a.k.a. Greenwich Mean Time.

hh:mm:ssZ indicates the time at Zulu (another name for UTC).

hh:mm:ss or hh:mm indicates within papiNet the applicable local time where the associated event is taking place. Caution should be used when processing times of this nature as the papiNet approach may be in discord with other users of XML.

CalendarNumber

The sequential number that uniquely identifies the Calendar e-Document.

CalendarNumber
type s30

CalendarRequestDetail

A grouping element that provides the parameters to be used when responding with a Calendar e-Document.

CalendarType [attribute]

CalendarType is mandatory. A single instance is required.

Identifies the intention of the entire Calendar e-Document.

Refer to CalendarType definition for any enumerations.

(sequence)

The sequence of items below is mandatory. A single instance is required.

LocationParty

LocationParty is optional. Multiple instances might exist.

The organization or business entity where the business event took place or will take place.

SupplierParty

SupplierParty is optional. Multiple instances might exist.

The organisation or business entity responsible for providing the product. SupplierParty is also the seller of the product, if Seller is not specified as OtherParty = Seller.

CalendarNumber

CalendarNumber is optional. A single instance might exist.

The sequential number that uniquely identifies the Calendar e-Document.

CalendarIssueDate

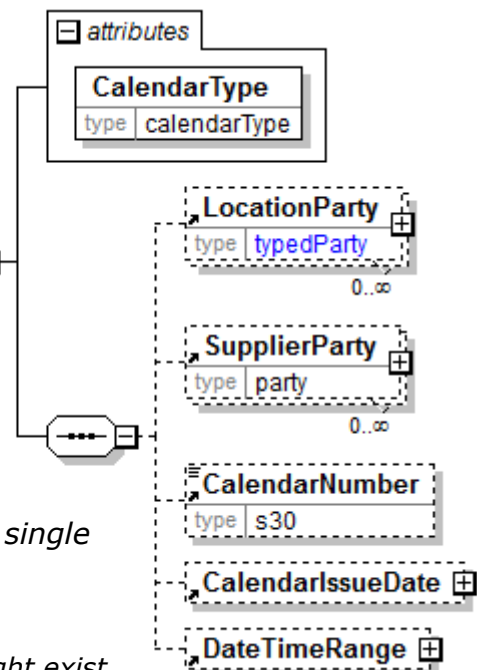

CalendarIssueDate is optional. A single instance might exist.

The date and optionally time when the Calendar e-Document was created.

DateTimeRange

DateTimeRange is optional. A single instance might exist.

Specifies a date and/or time range.

CalendarPeriod

Defines the calendar period applicable to a time slot.

This item is restricted to the following list.

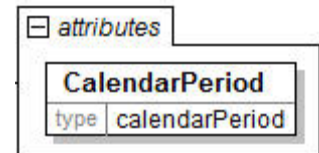

AllDays

All days

Monday

Monday

Tuesday

Tuesday

Wednesday

Wednesday

Thursday

Thursday

Friday

Friday

Saturday

Saturday

Sunday

Sunday

Workdays

Monday , Tuesday, Wednesday, Thursday and Friday excluding bank holidays (red days in the local calendar).

Weekend

Saturday and Sunday and bank holidays (red days in the local calendar).

CalendarSequence

A group item containing information that relates to a line on the Calendar.

(sequence)

The sequence of items below is mandatory. A single instance is required.

CalendarSequenceNumber

CalendarSequenceNumber is mandatory. A single instance is required.

The sequential number that uniquely identifies the Calendar sequence within the Calendar e-Document.

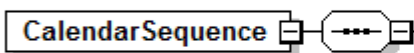

LocationParty

LocationParty is mandatory. A single instance is required.

The organization or business entity where the business event took place or will take place.

(choice)

[choice] is optional. A single instance might exist.

SupplyPoint

SupplyPoint is mandatory. One instance is required, multiple instances might exist.

Grouping element that contains items describing a supply point. A SupplyPoint belongs to a LocationParty, e.g. in a DeliveryOrigin or DeliveryDestination, and describes where goods are stored and can be loaded or unloaded. A SupplyPoint can for example be a loading or unloading gate at a warehouse or a road side landing at a logging area in the forest.

LocationCode

LocationCode is mandatory. One instance is required, multiple instances might exist.

A code used to identify a specific physical location within a site identified by a party, e.g. a loading station in a warehouse or an unloading station at a printer site.

LocationCode will be deprecated in a future version V3R00. Use SupplyPoint instead of LocationCode.

TransportInformation

TransportInformation is optional. A single instance might exist.

A grouping element for transport information.

ValidityPeriod

ValidityPeriod is optional. A single instance might exist.

The validity period for a specific item, e.g. the validity period for an e-Document.

CalendarEntry

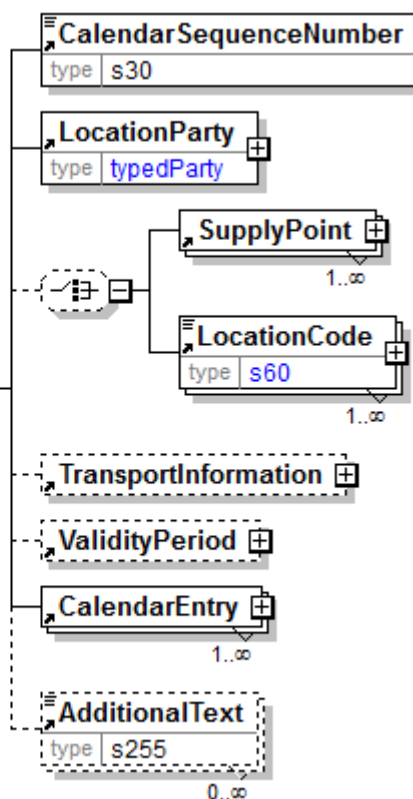

CalendarEntry is mandatory. One instance is required, multiple instances might exist.

Detailed description of the times and contingencies for the given LocationParty.

AdditionalText

AdditionalText is optional. Multiple instances might exist.

A text field that is used to communicate information not previously defined or for special instructions. To be used only for circumstances not covered by specific elements.

CalendarSequenceNumber

The sequential number that uniquely identifies the Calendar sequence within the Calendar e-Document.

CalendarSequenceNumber
type s30

CalendarStatus [attribute]

Identifies the status of the entire Calendar e-Document.

This item is restricted to the following list.

attribute
CalendarStatus
type calendarStatusType

Amended

The supplied information is changed.

Cancelled

The supplied information has been cancelled. Items that have been cancelled are not included in totals on the summary levels of the e-Document.

Original

The supplied information is the first version of that information.

CalendarType [attribute]

Identifies the intention of the entire Calendar e-Document.

This item is restricted to the following list.

attribute
CalendarType
type calendarType

LoadingSchedule

The schedule for transport vehicle loading.

OfficeSchedule

The schedule for office personnel.

SupportSchedule

The support schedule for transport operations.

UnloadingSchedule

The schedule for transport vehicle unloading.

Calibration

A grouping element that contains information about calibration of the measuring equipment.

(sequence)

The sequence of items below is mandatory. A single instance is required.

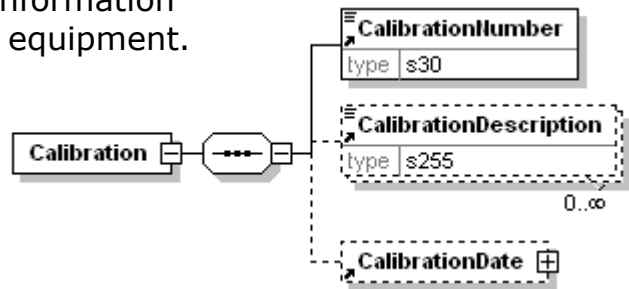

CalibrationNumber

CalibrationNumber is mandatory. A single instance is required.

A unique identifier for the calibration event.

CalibrationDescription

CalibrationDescription is optional. Multiple instances might exist.

A text element describing the calibration event.

CalibrationDate

CalibrationDate is optional. A single instance is required.

The date when calibration of the measuring equipment was done.

CalibrationDate

The date when calibration of the measuring equipment was done.

(sequence)

The sequence of items below is mandatory. A single instance is required.

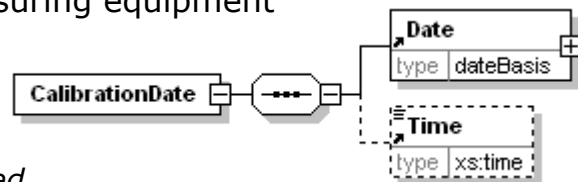

Date

Date is mandatory. A single instance is required.

A group element that contains the specification of Year, Month, and Day.

Time

Time is optional. A single instance might exist.

Times are treated in a standard XML fashion with a special case used to indicate a generalized "local" time. The standard XML approach to time is hh:mm:ss, hh:mm:ssZ, or hh:mm:ss±hh:mm.

- hh:mm:ss±hh:mm is used to represent a time with a time zone. The time zone is communicated as the number of hours offset from the Universal Time Coordinate (UTC), a.k.a. Greenwich Mean Time.
- hh:mm:ssZ indicates the time at Zulu (another name for UTC).
- hh:mm:ss or hh:mm indicates within papiNet the applicable local time where the associated event is taking place. Caution should be used when processing times of this nature as the papiNet approach may be in discord with other users of XML.

CalibrationDescription

A text element describing the calibration event.

CalibrationDescription	
type	s255

CalibrationNumber

A unique identifier for the calibration event.

CalibrationNumber	
type	s30

Caliper

The thickness of a sheet of paper under standard test conditions.

TestMethod [attribute]

TestMethod is optional. A single instance might exist.

The method used to determine the results of the test under consideration.

TestAgency [attribute]

TestAgency is optional. A single instance might exist.

The agency that has set the parameters for the testing

Refer to TestAgency definition for any enumerations.

SampleType [attribute]

SampleType is optional. A single instance might exist.

Communicates how sampling was done to measure the product characteristics.

Refer to SampleType definition for any enumerations.

ResultSource [attribute]

ResultSource is optional. A single instance might exist.

Used to define the data source of the specified test

Refer to ResultSource definition for any enumerations.

(sequence)

Caliper	
type	detailMeasurement

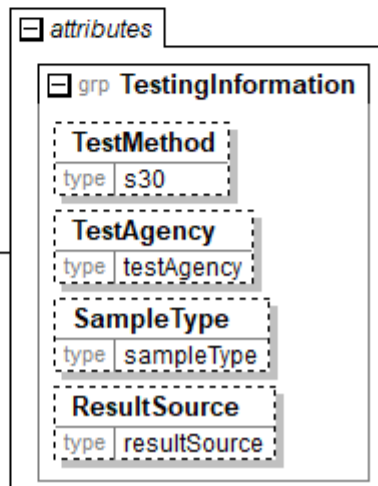
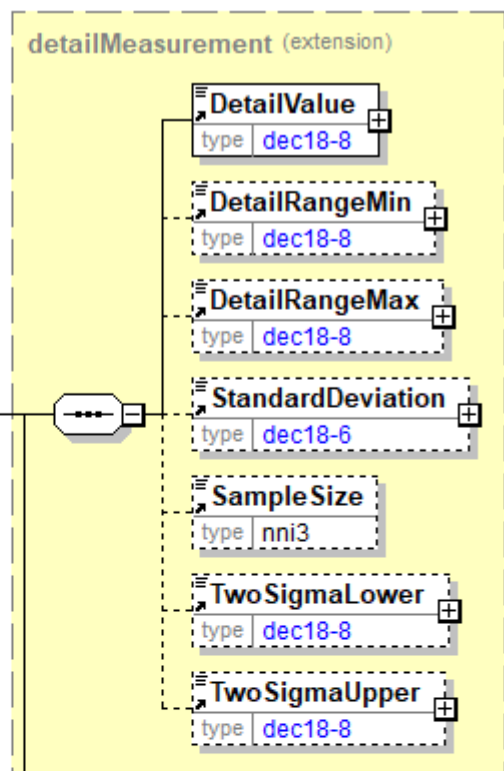

papiNet V2R31

The sequence of items below is mandatory. A single instance is required.

DetailValue

DetailValue is mandatory. A single instance is required.

A numeric value expressed in the unit of measure (UOM).

DetailRangeMin

DetailRangeMin is optional. A single instance might exist.

The minimum value (lower boundary) allowed for the DetailValue that is the parent of this element.

DetailRangeMax

DetailRangeMax is optional. A single instance might exist.

The maximum value (upper boundary) allowed for the DetailValue that is the parent of this element.

StandardDeviation

StandardDeviation is optional. A single instance might exist.

A statistic used as a measure of dispersion in a distribution.

SampleSize

SampleSize is optional. A single instance might exist.

The number of samples used to determine the product characteristic in question.

TwoSigmaLower

TwoSigmaLower is optional. A single instance might exist.

Two sigma (a measure of dispersion associated with standard deviation) on the lower side of the standard deviation.

TwoSigmaUpper

TwoSigmaUpper is optional. A single instance might exist.

Two sigma (a measure of dispersion associated with standard deviation) on the upper side of the standard deviation.

CallOff

The CallOff element is the root element for the CallOff e-Document.

A CallOff is a delivery schedule for product(s). Products to be delivered can be specified by product specifications or by purchase orders. Any party as agreed in a Trading Partner Agreement can send a CallOff. Each line item in a CallOff refers either to a product included in a PurchaseOrder or to the product specifications contained in the line item. The CallOff specifies delivery schedule(s) and quantities for product(s) to be delivered. The schedule may define a specific date and/or time for delivery or include a time range. All products covered by a CallOff must be delivered to a single location.

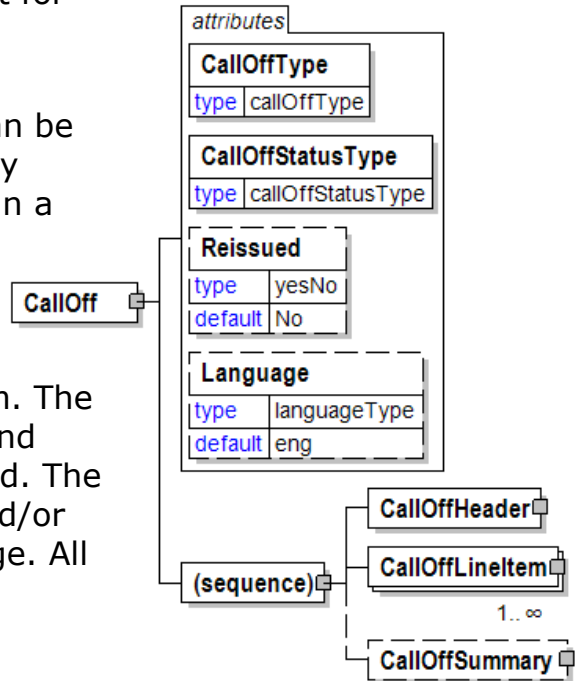

CallOffType [attribute]

CallOffType is mandatory. A single instance is required.

CallOffType defines the type of CallOff.

Refer to CallOffType definition for any enumerations.

CallOffStatusType [attribute]

CallOffStatusType is mandatory. A single instance is required.

Identifies the status of the entire CallOff (in other words, at the root level).

Refer to CallOffStatusType definition for any enumerations.

Reissued [attribute]

Reissued is optional. A single instance might exist.

Either "Yes" or "No".

Refer to Reissued definition for any enumerations.

Language [attribute]

Language is optional. A single instance might exist.

The valid Alpha 2- and Alpha 3-character list of language codes in the ISO 639-1 and 639-2 international standards.

Information on the content of this attribute is available at:
https://www.loc.gov/standards/iso639-2/php/code_list.php

(sequence)

The sequence of items below is mandatory. A single instance is required.

CallOffHeader

CallOffHeader is mandatory. A single instance is required.

A group item containing generic information applicable to the entire CallOff.

CallOffLineItem

CallOffLineItem is mandatory. One instance is required, multiple instances might exist.

A group item containing information that relates to a line on the CallOff.

CallOffSummary

CallOffSummary is optional. A single instance might exist.

Contains summary information that applies to the CallOff.

CallOffConfirmationIssuedDate

The Date and Time on which the CallOff confirmation was issued.

(sequence)

The sequence of items below is mandatory. A single instance is required.

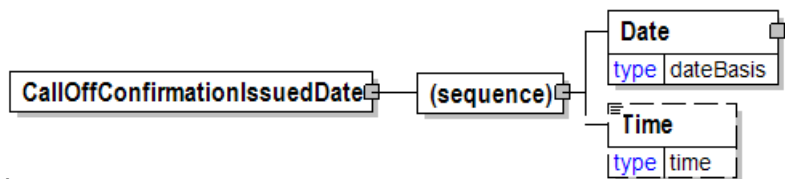

Date

Date is mandatory. A single instance is required.

A group element that contains the specification of Year, Month, and Day.

Time

Time is optional. A single instance might exist.

Times are treated in a standard XML fashion with a special case used to indicate a generalized "local" time. The standard XML approach to time is hh:mm:ss, hh:mm:ssZ, or hh:mm:ss±hh:mm.

hh:mm:ss±hh:mm is used to represent a time with a time zone. The time zone is communicated as the number of hours offset from the Universal Time Coordinate (UTC), a.k.a. Greenwich Mean Time.

hh:mm:ssZ indicates the time at Zulu (another name for UTC).

hh:mm:ss or hh:mm indicates within papiNet the applicable local time where the associated event is taking place. Caution should be used when processing times of this nature as the papiNet approach may be in discord with other users of XML.

CallOffConfirmationLineItemNumber

The sequential number that uniquely identifies the CallOff confirmation line item.

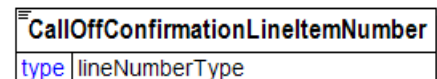

CallOffConfirmationNumber

The unique identifier given to the CallOff confirmation.

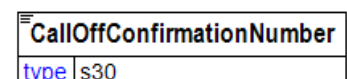

CallOffHeader

A group item containing generic information applicable to the entire CallOff.

CallOffHeaderStatusType [attribute]

CallOffHeaderStatusType is optional. A single instance might exist.

CallOffHeaderStatusType defines the status of the CallOff header.

Refer to

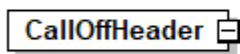

CallOffHeaderStatusType definition for any enumerations.

(sequence)

The sequence of items below is mandatory. A single instance is required.

CallOffInformation

CallOffInformation is mandatory. A single instance is required.

A group item containing information unique to the CallOff which is generated and supplied by the buyer, seller, or any party involved.

BuyerParty

BuyerParty is optional. A single instance might exist.

The legal entity to which the product is sold. Also commonly referred to as the sold-to party or customer. If no OtherParty is defined as the Payer, the Buyer is the Payer.

BillToParty

BillToParty is optional. A single instance might exist.

The address where the Invoice is to be sent.

SupplierParty

SupplierParty is mandatory. A single instance is required.

The organisation or business entity responsible for providing the product. SupplierParty is also the seller of the product, if Seller is not specified as OtherParty = Seller.

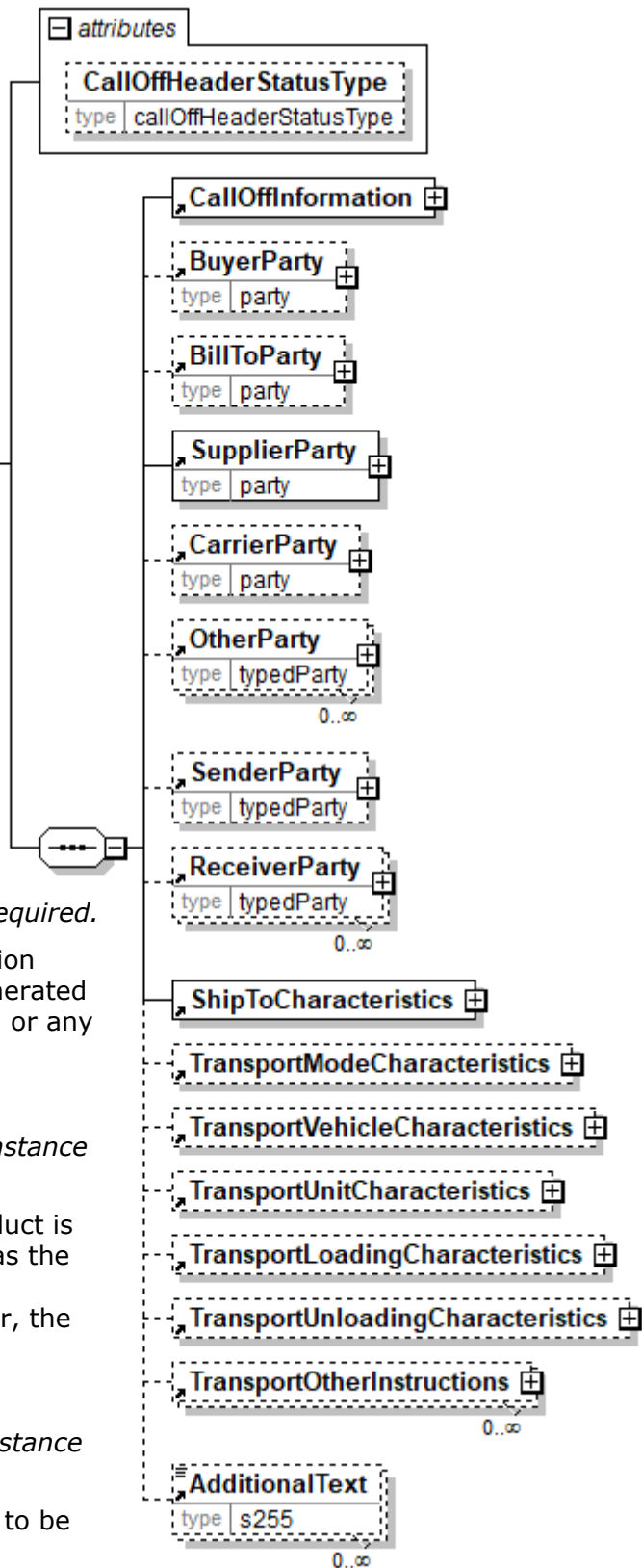

CarrierParty

CarrierParty is optional. A single instance might exist.

The party performing the transport of the product from the pickup location to the ship-to location; could be a hauler.

OtherParty

OtherParty is optional. Multiple instances might exist.

An organisation or business entity other than those specifically detailed within an e-Document.

SenderParty

SenderParty is optional. A single instance might exist.

The business entity issuing the e-Document, the source of the document.

The entity responsible for the content. If the sender party has out sourced the message service to a third party the SenderParty is the issuer of the e-Document and not the party performing the transmission service of the electronic message.

ReceiverParty

ReceiverParty is optional. Multiple instances might exist.

The business entity for whom the e-Document is intended, the destination of the document.

The entity interested in the content. If the receiver party has outsourced the message service to a third party the ReceiverParty is the intended party for the e-Document and not the party performing the receiving service of the electronic message.

ShipToCharacteristics

ShipToCharacteristics is mandatory. A single instance is required.

A group item that provides information important for the Ship-To Party.

TransportModeCharacteristics

TransportModeCharacteristics is optional. A single instance might exist.

A group item defining the primary mode of transport.

TransportVehicleCharacteristics

TransportVehicleCharacteristics is optional. A single instance might exist.

A group item containing information about a transport vehicle, e.g. a truck. A transport vehicle has its own power and can be used to pull, push, carry, or tow a transport unit loaded with goods.

TransportUnitCharacteristics

TransportUnitCharacteristics is optional. A single instance might exist.

A group item containing information about a transport unit, e.g. a trailer. Transport units contain goods and move using power from another source, the transport vehicle.

TransportLoadingCharacteristics

TransportLoadingCharacteristics is optional. A single instance might exist.

A group item defining how the transported items are to be loaded.

TransportUnloadingCharacteristics

TransportUnloadingCharacteristics is optional. A single instance might exist.

A group item defining how the transported items are to be unloaded.

TransportOtherInstructions

TransportOtherInstructions is optional. Multiple instances might exist.

A group item defining any other instructions for the transport not covered in the description of transport mode, vehicle, unit, and loading characteristics or defining an alternative description for the categories mentioned above.

AdditionalText

AdditionalText is optional. Multiple instances might exist.

A text field that is used to communicate information not previously defined or for special instructions. To be used only for circumstances not covered by specific elements.

CallOffHeaderStatusType [attribute]

CallOffHeaderStatusType defines the status of the CallOff header.

This item is restricted to the following list.

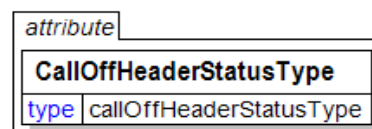

Accepted

The supplied information is accepted.

Amended

The supplied information is changed.

Cancelled

The supplied information has been cancelled. Items that have been cancelled are not included in totals on the summary levels of the e-Document.

NoAction

The supplied information has not been amended and thereby requires no action.

Original

The supplied information is the first version of that information.

Rejected

The supplied information is rejected.

CallOffInformation

A group item containing information unique to the CallOff which is generated and supplied by the buyer, seller, or any party involved.

(sequence)

The sequence of items below is mandatory. A single instance is required.

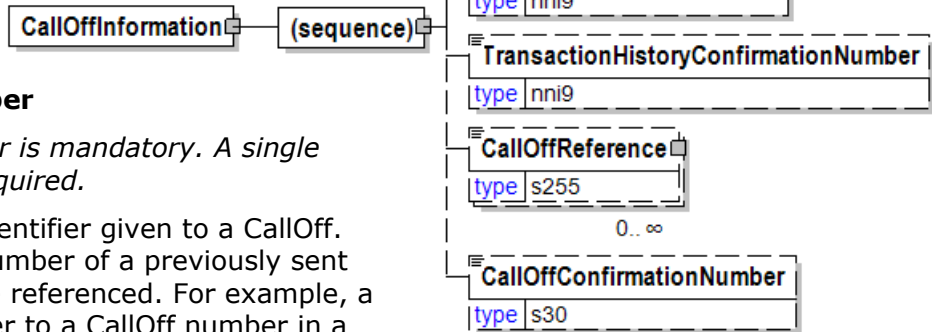

CallOffNumber

CallOffNumber is mandatory. A single instance is required.

The unique identifier given to a CallOff. The CallOff number of a previously sent CallOff can be referenced. For example, a seller can refer to a CallOff number in a DeliveryMessage.

CallOffIssuedDate

CallOffIssuedDate is mandatory. A single instance is required.

The Date and Time when the CallOff was issued.

CallOffConfirmationIssuedDate

CallOffConfirmationIssuedDate is optional. A single instance might exist.

The Date and Time on which the CallOff confirmation was issued.

TransactionHistoryNumber

TransactionHistoryNumber is optional. A single instance might exist.

A sequential number that keeps track of the version of a document.

However when the document is a confirmation document, in which case the TransactionHistoryNumber refers to the trigger transaction for the confirmation.

TransactionHistoryConfirmationNumber

TransactionHistoryConfirmationNumber is optional. A single instance might exist.

A sequential number that keeps track the version of a confirmation document.

When the document is a confirmation document, then the TransactionHistoryNumber refers to the trigger transaction for the confirmation.

CallOffReference

CallOffReference is optional. Multiple instances might exist.

An element item detailing relevant references pertaining to the CallOff. CallOffReference uses the CallOffReferenceType attribute.

CallOffConfirmationNumber

CallOffConfirmationNumber is optional. A single instance might exist.

The unique identifier given to the CallOff confirmation.

CallOffIssuedDate

The Date and Time when the CallOoff was issued.

(sequence)

The sequence of items below is mandatory. A single instance is required.

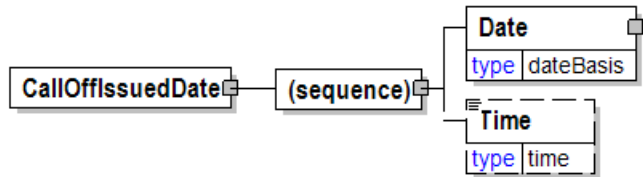

Date

Date is mandatory. A single instance is required.

A group element that contains the specification of Year, Month, and Day.

Time

Time is optional. A single instance might exist.

Times are treated in a standard XML fashion with a special case used to indicate a generalized "local" time. The standard XML approach to time is hh:mm:ss, hh:mm:ssZ, or hh:mm:ss±hh:mm.

hh:mm:ss±hh:mm is used to represent a time with a time zone. The time zone is communicated as the number of hours offset from the Universal Time Coordinate (UTC), a.k.a. Greenwich Mean Time.

hh:mm:ssZ indicates the time at Zulu (another name for UTC).

hh:mm:ss or hh:mm indicates within papiNet the applicable local time where the associated event is taking place. Caution should be used when processing times of this nature as the papiNet approach may be in discord with other users of XML.

CallOffLineItem

A group item containing information that relates to a line on the CallOff.

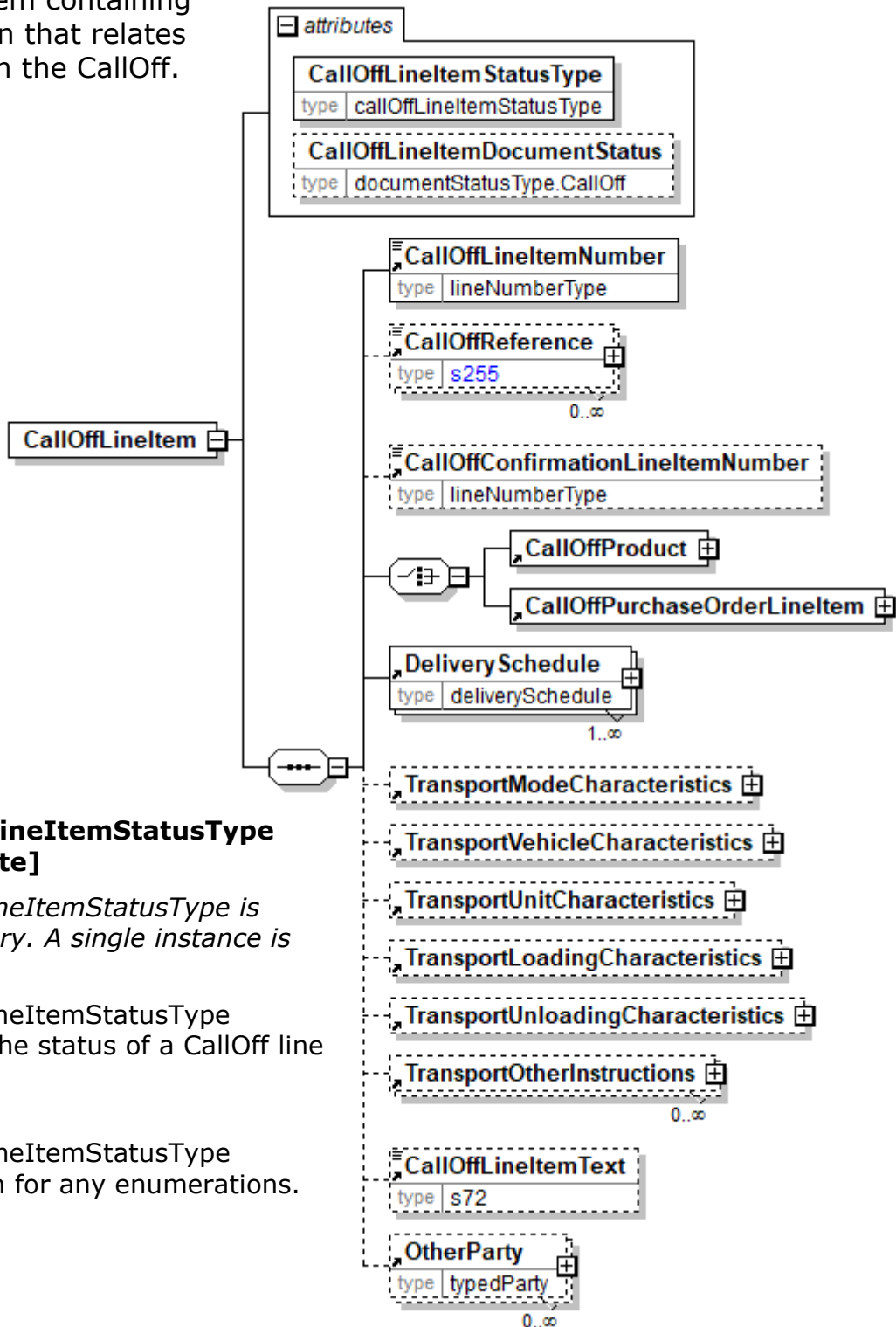

CallOffLineItemStatusType [attribute]

CallOffLineItemStatusType is mandatory. A single instance is required.

CallOffLineItemStatusType defines the status of a CallOff line item.

Refer to CallOffLineItemStatusType definition for any enumerations.

CallOffLineItemDocumentStatus [attribute]

CallOffLineItemDocumentStatus is optional. A single instance might exist.

Defines the actual document status for the CallOffLineItem.

Refer to CallOffLineItemDocumentStatus definition for any enumerations.

(sequence)

papiNet V2R31

The sequence of items below is mandatory. A single instance is required.

CallOffLineItemNumber

CallOffLineItemNumber is mandatory. A single instance is required.

The sequential number that uniquely identifies the CallOff line item.

CallOffReference

CallOffReference is optional. Multiple instances might exist.

An element item detailing relevant references pertaining to the CallOff.

CallOffReference uses the CallOffReferenceType attribute.

CallOffConfirmationLineItemNumber

CallOffConfirmationLineItemNumber is optional. A single instance might exist.

The sequential number that uniquely identifies the CallOff confirmation line item.

(choice)

[choice] is mandatory. A single instance is required.

CallOffProduct

CallOffProduct is mandatory. A single instance is required.

A group item identifying the product to be called off.

CallOffPurchaseOrderLineItem

CallOffPurchaseOrderLineItem is mandatory. A single instance is required.

A group item referring to a PurchaseOrder line item.

DeliverySchedule

DeliverySchedule is mandatory. One instance is required, multiple instances might exist.

A group item defining a series of DeliveryDateWindow(s) in which specified quantities must be delivered.

TransportModeCharacteristics

TransportModeCharacteristics is optional. A single instance might exist.

A group item defining the primary mode of transport.

TransportVehicleCharacteristics

TransportVehicleCharacteristics is optional. A single instance might exist.

A group item containing information about a transport vehicle, e.g. a truck. A transport vehicle has its own power and can be used to pull, push, carry, or tow a transport unit loaded with goods.

TransportUnitCharacteristics

TransportUnitCharacteristics is optional. A single instance might exist.

A group item containing information about a transport unit, e.g. a trailer. Transport units contain goods and move using power from another source, the transport vehicle.

TransportLoadingCharacteristics

TransportLoadingCharacteristics is optional. A single instance might exist.

A group item defining how the transported items are to be loaded.

TransportUnloadingCharacteristics

TransportUnloadingCharacteristics is optional. A single instance might exist.

A group item defining how the transported items are to be unloaded.

TransportOtherInstructions

TransportOtherInstructions is optional. Multiple instances might exist.

A group item defining any other instructions for the transport not covered in the description of transport mode, vehicle, unit, and loading characteristics or defining an alternative description for the categories mentioned above.

CallOffLineItemText

CallOffLineItemText is optional. A single instance might exist.

A free text field to be used for special item instructions.

OtherParty

OtherParty is optional. Multiple instances might exist.

An organisation or business entity other than those specifically detailed within an e-Document.

CallOffLineItemDocumentStatus [attribute]

Defines the actual document status for the CallOffLineItem.

This item is restricted to the following list.

attribute
CallOffLineItemDocumentStatus
type documentStatusType.CallOff

Cancelled

The supplied information of the document item is cancelled. Items that have been cancelled are not included in totals on the summary level of e-Documents.

Confirmed

The supplied information of the document item is agreed. If a requested change or cancellation of an existing document item can not be accepted, then the earlier agreed information of the document item will be re-confirmed.

Pending

The supplied information of the document item is being investigated.

Rejected

The supplied information of the document item can not be accepted. The document item is new or not earlier confirmed.

Requested

The supplied information of the document item is ordered.

CallOffLineItemDocumentStatus [attribute]

Defines the actual document status for the CallOffLineItem.

This item is restricted to the following list.

attribute
CallOffLineItemDocumentStatus
type documentStatusType.CallOffWood

Cancelled

The supplied information of the document item is cancelled. Items that have been cancelled are not included in totals on the summary level of e-Documents.

Confirmed

The supplied information of the document item is agreed. If a requested change or cancellation of an existing document item can not be accepted, then the earlier agreed information of the document item will be re-confirmed.

Pending

The supplied information of the document item is being investigated.

Rejected

The supplied information of the document item can not be accepted. The document item is new or not earlier confirmed.

Requested

The supplied information of the document item is ordered.

CallOffLineItemNumber

The sequential number that uniquely identifies the CallOff line item.

CallOffLineItemNumber
type lineNumberType

CallOffLineItemStatusType [attribute]

CallOffLineItemStatusType defines the status of a CallOff line item.

attribute
CallOffLineItemStatusType
type callOffLineItemStatusType

This item is restricted to the following list.

Accepted

The supplied information is accepted.

Amended

The supplied information is changed.

Cancelled

The supplied information has been cancelled. Items that have been cancelled are not included in totals on the summary levels of the e-Documents.

NoAction

The supplied information has not been amended and thereby requires no action.

Original

The supplied information is the first version of that information.

Pending

The supplied information is not complete and will be updated later.

Rejected

The supplied information is rejected.

CallOffLineItemText

A free text field to be used for special item instructions.

CallOffLineItemText
type s72

CallOffNumber

The unique identifier given to a CallOff. The CallOff number of a previously sent CallOff can be referenced. For example, a seller can refer to a CallOff number in a DeliveryMessage.

CallOffNumber
type s30

CallOffPaper

A group item containing elements that describe the paper item.

(sequence)

The sequence of items below is mandatory. A single instance is required.

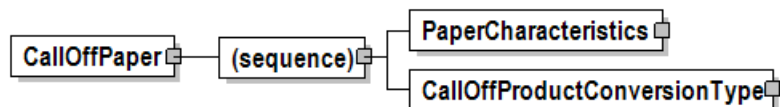

PaperCharacteristics

PaperCharacteristics is mandatory. A single instance is required.

The identifying characteristics of paper most important to the ordering of the item. These are the characteristics that, when associated with a given grade, allow the manufacturer to produce but not convert or package, the paper.

CallOffProductConversionType

CallOffProductConversionType is mandatory. A single instance is required.

A call off reel or a call off sheet.

CallOffProduct

A group item identifying the product to be called off.

(sequence)

The sequence of items below is mandatory. A single instance is required.

(sequence)

The sequence of items below is mandatory. One instance is required, multiple instances might exist.

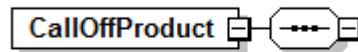

ProductIdentifier

ProductIdentifier is mandatory. A single instance is required.

Used to communicate the code of the article, in a variety of formats designated by the type.

ProductDescription

ProductDescription is optional. Multiple instances might exist.

An element used to communicate a human readable description of the product in the language specified by the Language attribute.

MillCharacteristics

MillCharacteristics is optional. A single instance might exist.

A group item defining the mill party and machine identifier where a product is or was produced.

Classification

Classification is optional. Multiple instances might exist.

A group item that details the product classification according to a particular organization's scheme. An item across multiple classifications would still be recognized as the same item. Examples of some product classifications are: Containerboard, Pulp-Dissolving, or Newsprint.

(choice)

[choice] is optional. A single instance might exist.

BookManufacturing

BookManufacturing is mandatory. A single instance is required.

BookManufacturing is a group element that contains the elements that describe the book manufacturing process.

ForestWood

ForestWood is mandatory. A single instance is required.

A grouping element with information about characteristics for Forest Wood

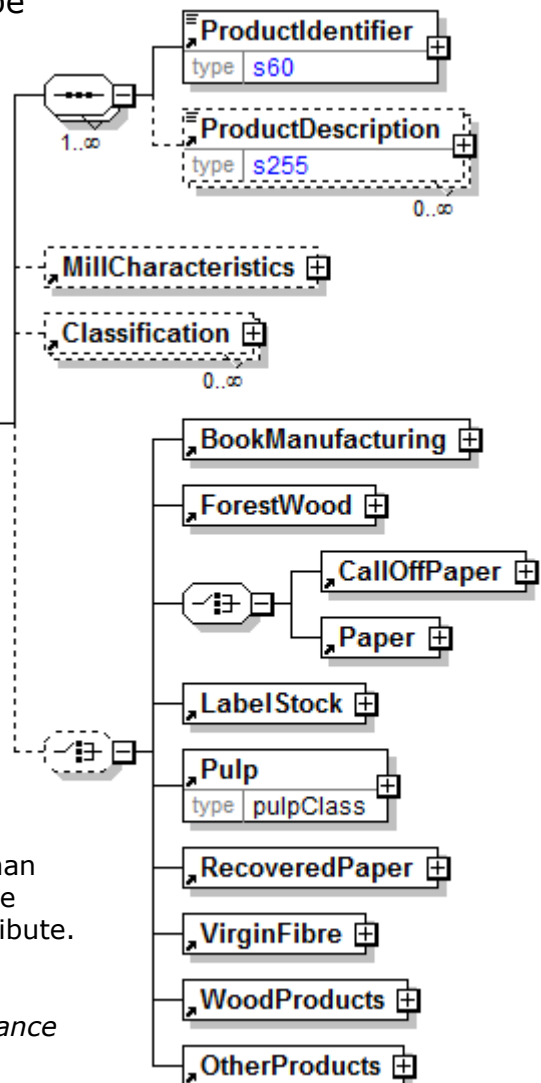

products.

(choice)

[choice] is mandatory. A single instance is required.

CallOffPaper

CallOffPaper is mandatory. A single instance is required.

A group item containing elements that describe the paper item.

Paper

Paper is mandatory. A single instance is required.

A group item defining the characteristics of the paper product.

LabelStock

LabelStock is mandatory. A single instance is required.

LabelStock contains the attributes and characteristics that define the label stock product.

Pulp

Pulp is mandatory. A single instance is required.

A group item defining the characteristics of pulp that are not dependent on a particular conversion process.

RecoveredPaper

RecoveredPaper is mandatory. A single instance is required.

A group item defining the characteristics of recycled fibre that are not dependent on a particular conversion process.

VirginFibre

VirginFibre is mandatory. A single instance is required.

Virgin Fibre

WoodProducts

WoodProducts is mandatory. A single instance is required.

A grouping element for all wood products.

OtherProducts

OtherProducts is mandatory. A single instance is required.

A group item defining the characteristics of other products.

CallOffProductConversionType

A call off reel or a call off sheet.

(choice)

[choice] is mandatory. A single instance is required.

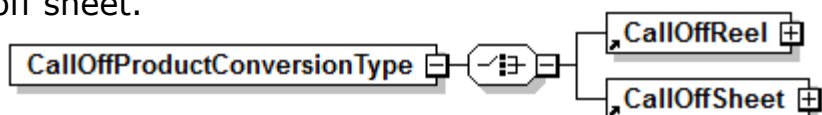

CallOffReel

CallOffReel is mandatory. A single instance is required.

A group item containing reel information for the CallOff.

CallOffSheet

CallOffSheet is mandatory. A single instance is required.

A group item containing sheet information for the CallOff.

CallOffPurchaseOrderLineItem

A group item referring to a PurchaseOrder line item.

(sequence)

The

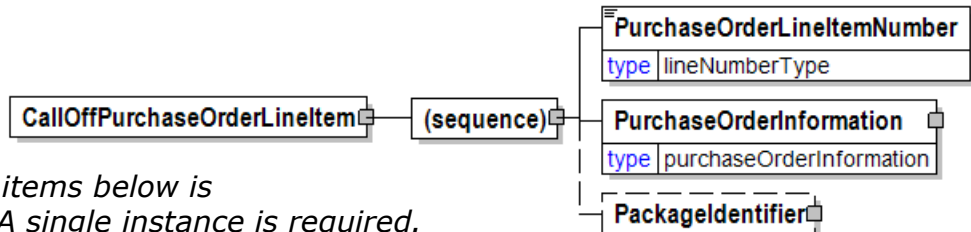

sequence of items below is mandatory. A single instance is required.

PurchaseOrderLineItemNumber

PurchaseOrderLineItemNumber is mandatory. A single instance is required.

The sequential number that uniquely identifies the PurchaseOrder line item.

PurchaseOrderInformation

PurchaseOrderInformation is mandatory. A single instance is required.

A group item containing information unique to this PurchaseOrder, which is provided by the buyer. PurchaseOrderInformation can be optional in the supply chain. Invoices are created without having a PurchaseOrder in Vendor Managed Inventory. Freight invoices also will not have a PurchaseOrder number.

PackageIdentifier

PackageIdentifier is optional. A single instance might exist.

The identifier of the productpackage (such as reel ID or pallet ID) that is used along with the PurchaseOrderLineItemNumber to call off the product.

CallOffReel

A group item containing reel information for the CallOff.

(sequence)

The sequence of items below is mandatory. A single instance is required.

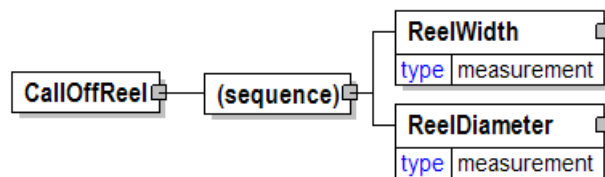

ReelWidth

ReelWidth is mandatory. A single instance is required.

The width of reel from edge to edge excluding packaging.

ReelDiameter

ReelDiameter is mandatory. A single instance is required.

The diameter measurement of reel excluding packaging.

CallOffReference

An element item detailing relevant references pertaining to the CallOff. CallOffReference uses the CallOffReferenceType attribute.

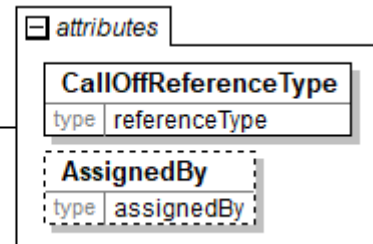
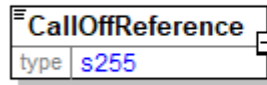

CallOffReferenceType [attribute]

CallOffReferenceType is mandatory. A single instance is required.

Provides a contextual explanation of the specific reference identifier. Many items are currently prefixed by "Buyer", "Forwarder", "Manufacturer", "Mill", "Seller", "Supplier", "Warehouse", or "Vendor". Check for an existing non-prefixed version and use the non-prefixed version instead. In the (yet to be announced release date) version 3.0 the prefixed versions will be removed. Instead the attribute @AssignedBy will communicate the information previously communicated in the prefix.

Refer to CallOffReferenceType definition for any enumerations.

AssignedBy [attribute]

AssignedBy is optional. A single instance might exist.

Identifies the type of party or the agency that has assigned the associated item, e.g. a reference of type OrderNumber.

Refer to AssignedBy for any enumerations.

CallOffReferenceType [attribute]

Provides a contextual explanation of the specific reference identifier. Many items are currently prefixed by "Buyer", "Forwarder", "Manufacturer", "Mill", "Seller", "Supplier", "Warehouse", or "Vendor". Check for an existing non-prefixed version and use the non-prefixed version instead. In the (yet to be announced release date) version 3.0 the prefixed versions will be removed. Instead the attribute @AssignedBy will communicate the information previously communicated in the prefix.

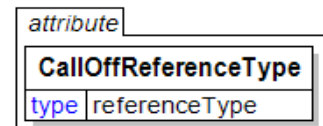

Refer to the [referenceType](#) entry for the list of enumerations and their definitions.

CallOffSheet

A group item containing sheet information for the CallOff.

(sequence)

The sequence of items below is mandatory. A single instance is required.

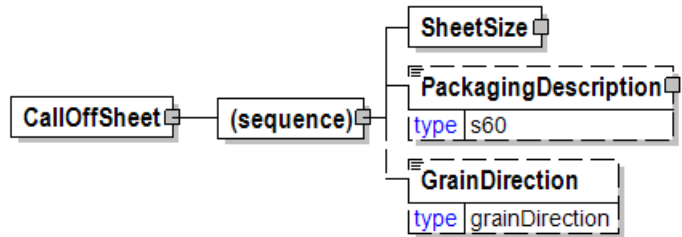

SheetSize

SheetSize is mandatory. A single instance is required.

A group item that contains elements relative to the sheet size.

PackagingDescription

PackagingDescription is optional. A single instance might exist.

A text field element describing the packaging of a product.

GrainDirection

GrainDirection is optional. A single instance might exist.

Defines the primary orientation/alignment (Long or Short) of the cellulose fibres in a sheet or web of paper, which results from the flow of fibres in a water suspension during the papermaking process.

Refer to GrainDirection definition for any enumerations.

CallOffStatusType [attribute]

Identifies the status of the entire CallOff (in other words, at the root level).

This item is restricted to the following list.

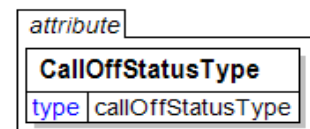

Accepted

The supplied information is accepted.

Amended

The supplied information is changed.

Cancelled

The supplied information has been cancelled. Items that have been cancelled are not included in totals on the summary levels of the e-Document.

Original

The supplied information is the first version of that information.

Rejected

The supplied information is rejected.

CallOffSummary

Contains summary information that applies to the CallOff.

(sequence)

The sequence of items below is mandatory. A single instance is required.

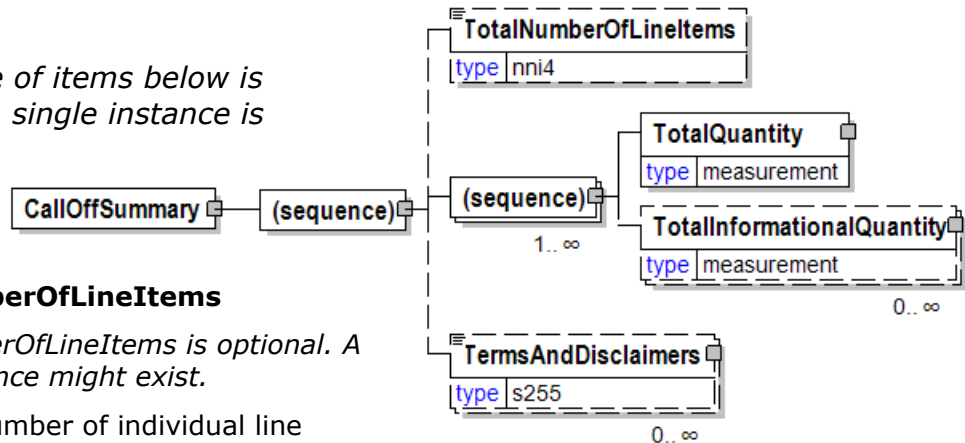

TotalNumberOfLineItems

TotalNumberOfLineItems is optional. A single instance might exist.

The total number of individual line items in the document, regardless of the status or type.

(sequence)

The sequence of items below is mandatory. One instance is required, multiple instances might exist.

TotalQuantity

TotalQuantity is mandatory. A single instance is required.

The total quantity of similar items in the e-Documents. TotalQuantity is primarily used in the summary section of documents where it is repeatable to permit totaling for different units of measure.

TotalInformationalQuantity

TotalInformationalQuantity is optional. Multiple instances might exist.

A quantity that is used to communicate related information about the parent element. This element represents a total that is derived from individual line items.

TermsAndDisclaimers

TermsAndDisclaimers is optional. Multiple instances might exist.

An element that contains legal information with an indication of what the Language is.

CallOffType [attribute]

CallOffType defines the type of CallOff.

This item is restricted to the following list.

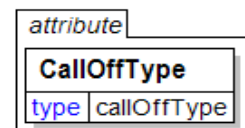

CallOff

Defines a CallOff sent by the buyer to the seller.

CallOffConfirmation

Defines a CallOff confirmation sent in response to a CallOff.

CallOffWood

The CallOffWood element is the root element for the CallOffWood e-Document.

A CallOffWood is a business transaction instructing the consignor (normally the seller) to despatch goods belonging to one or several orders. A CallOffWood contains information about how the goods are to be loaded, quantities, marking instructions etc. It may also contain information about where borders are to be crossed and information concerning transport, such as name of ship and shipping agent. In cases where the CallOffWood is not used, delivery information is included in the order.

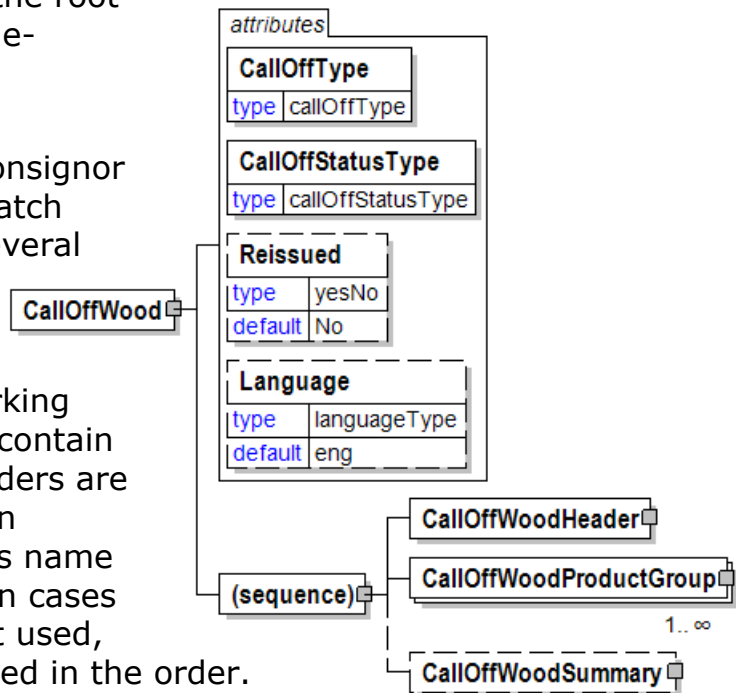

CallOffType [attribute]

CallOffType is mandatory. A single instance is required.

CallOffType defines the type of CallOff.

Refer to CallOffType definition for any enumerations.

CallOffStatusType [attribute]

CallOffStatusType is mandatory. A single instance is required.

Identifies the status of the entire CallOff (in other words, at the root level).

Refer to CallOffStatusType definition for any enumerations.

Reissued [attribute]

Reissued is optional. A single instance might exist.

Either "Yes" or "No".

Refer to Reissued definition for any enumerations.

Language [attribute]

Language is optional. A single instance might exist.

The valid Alpha 2- and Alpha 3-character list of language codes in the ISO 639-1 and 639-2 international standards.

Information on the content of this attribute is available at:
https://www.loc.gov/standards/iso639-2/php/code_list.php

(sequence)

The sequence of items below is mandatory. A single instance is required.

CallOffWoodHeader

CallOffWoodHeader is mandatory. A single instance is required.

papiNet V2R31

Information that applies to the entire Wood market segment CallOff e-Document.

CallOffWoodProductGroup

CallOffWoodProductGroup is mandatory. One instance is required, multiple instances might exist.

CallOffWoodProductGroup provides for groupings of line items in the CallOff e-Document.

This construct was introduced in version v2r30. It is recognized that the introduction of this construct is not in conformance with the papiNet policy of backward compatibility within releases of the same version.

CallOffWoodSummary

CallOffWoodSummary is optional. A single instance might exist.

Summary information that applies to the Wood market segment CallOff e-Document.

CallOffWoodHeader

Information that applies to the entire Wood market segment CallOff e-Document.

CallOffHeaderStatusType [attribute]

CallOffHeaderStatusType is optional. A single instance might exist.

CallOffHeaderStatusType defines the status of the CallOff header.

Refer to CallOffHeaderStatusType definition for any enumerations.

(sequence)

The sequence of items below is mandatory. A single instance is required.

CallOffInformation

CallOffInformation is mandatory. A single instance is required.

A group item containing information unique to the CallOff which is generated and supplied by the buyer, seller, or any party involved.

BuyerParty

BuyerParty is mandatory. A single instance is required.

The legal entity to which the product is sold. Also commonly referred to as the sold-to party or customer. If no OtherParty is defined as the Payer, the Buyer is the Payer.

BillToParty

BillToParty is optional. A single instance might exist.

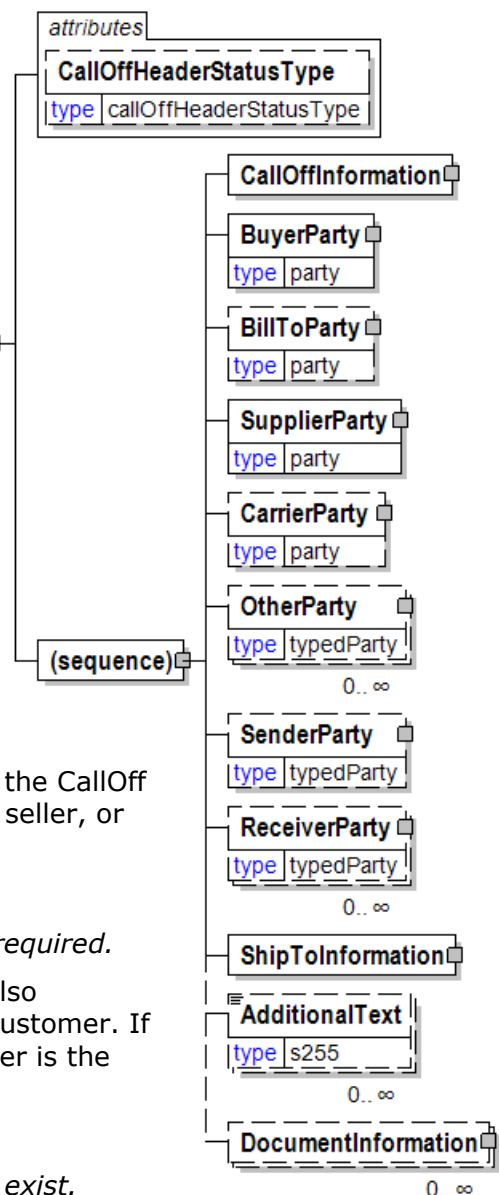

The address where the invoice is to be sent.

SupplierParty

SupplierParty is mandatory. A single instance is required.

The organisation or business entity responsible for providing the product. SupplierParty is also the seller of the product, if Seller is not specified as OtherParty = Seller.

CarrierParty

CarrierParty is optional. A single instance might exist.

The party performing the transport of the product from the pickup location to the ship-to location; could be a hauler.

OtherParty

OtherParty is optional. Multiple instances might exist.

An organisation or business entity other than those specifically detailed within an e-Document.

SenderParty

SenderParty is optional. A single instance might exist.

The business entity issuing the e-Document, the source of the document.

The entity responsible for the content. If the sender party has out sourced the message service to a third party the SenderParty is the issuer of the e-Document and not the party performing the transmission service of the electronic message.

ReceiverParty

ReceiverParty is optional. Multiple instances might exist.

The business entity for whom the e-Document is intended, the destination of the document.

The entity interested in the content. If the receiver party has outsourced the message service to a third party the ReceiverParty is the intended party for the e-Document and not the party performing the receiving service of the electronic message.

ShipToInformation

ShipToInformation is mandatory. A single instance is required.

Group element containing information about the ship to and delivery of a product.

AdditionalText

AdditionalText is optional. Multiple instances might exist.

A text field that is used to communicate information not previously defined or for special instructions. To be used only for circumstances not covered by specific elements.

DocumentInformation

DocumentInformation is optional. Multiple instances might exist.

A group element containing a specification of required documents in the business process. Additional free text to be printed on documents can also be specified.

CallOffWoodLineItem

CallOffWoodLineItem has a required attribute that indicates the status of the line item.

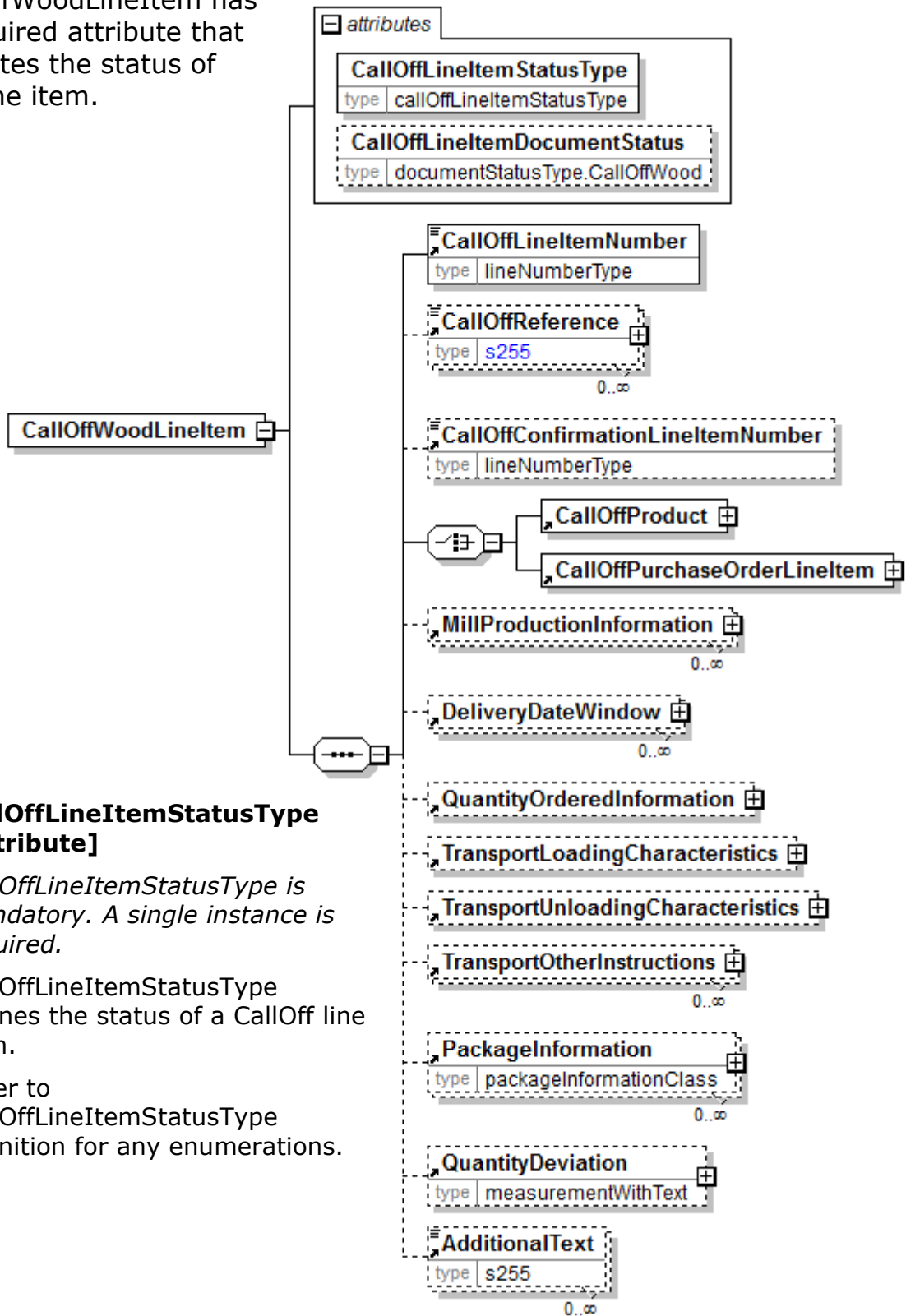

CallOffLineItemStatusType [attribute]

CallOffLineItemStatusType is mandatory. A single instance is required.

CallOffLineItemStatusType defines the status of a CallOff line item.

Refer to CallOffLineItemStatusType definition for any enumerations.

CallOffLineItemDocumentStatus [attribute]

CallOffLineItemDocumentStatus is optional. A single instance might exist.

Defines the actual document status for the CallOffLineItem.

Refer to CallOffLineItemDocumentStatus definition for any enumerations.

(sequence)

The sequence of items below is mandatory. A single instance is required.

CallOffLineItemNumber

CallOffLineItemNumber is mandatory. A single instance is required.

The sequential number that uniquely identifies the CallOff line item.

CallOffReference

CallOffReference is optional. Multiple instances might exist.

An element item detailing relevant references pertaining to the CallOff. CallOffReference uses the CallOffReferenceType attribute.

CallOffConfirmationLineItemNumber

CallOffConfirmationLineItemNumber is optional. A single instance might exist.

The sequential number that uniquely identifies the CallOff confirmation line item.

(choice)

[choice] is mandatory. A single instance is required.

CallOffProduct

CallOffProduct is mandatory. A single instance is required.

A group item identifying the product to be called off.

CallOffPurchaseOrderLineItem

CallOffPurchaseOrderLineItem is mandatory. A single instance is required.

A group item referring to a PurchaseOrder line item.

MillProductionInformation

MillProductionInformation is optional. Multiple instances might exist.

A grouping element that contains information about production at the mill.

DeliveryDateWindow

DeliveryDateWindow is optional. Multiple instances might exist.

A group item defining the date/time interval for delivery to take place. An element which may contain the estimated date for which delivery is expected. This date is not absolute.

QuantityOrderedInformation

QuantityOrderedInformation is optional. A single instance might exist.

Used to identify quantity. The construct provides via InformationalQuantity the ability to provide the Quantity in another UOM. Length is also provided to further specify the quantity.

TransportLoadingCharacteristics

TransportLoadingCharacteristics is optional. A single instance might exist.

A group item defining how the transported items are to be loaded.

TransportUnloadingCharacteristics

TransportUnloadingCharacteristics is optional. A single instance might exist.

A group item defining how the transported items are to be unloaded.

TransportOtherInstructions

TransportOtherInstructions is optional. Multiple instances might exist.

papiNet V2R31

A group item defining any other instructions for the transport not covered in the description of transport mode, vehicle, unit, and loading characteristics or defining an alternative description for the categories mentioned above.

PackageInformation

PackageInformation is optional. Multiple instances might exist.

The purpose of the PackageInformation structure is to clearly identify physical handling items that constitute the delivery.

PackageInformation is the highest level of product packaging it describes the shipping or warehousing unit.

If you are communicating a package, usually for logistics or transport purposes, you should include the PackageType, Identifier, ItemCount, and Quantity. (Note: you still have the ability to describe the item with one of the "named" items.)

If you are communicating one of the named Items there is no need to include PackageType, Identifier, ItemCount, and Quantity.

Since either of these two approaches can be used the entire contents of this element are optional even though the parent may be required. It is expected that you will fill in the appropriate details.

QuantityDeviation

QuantityDeviation is optional. A single instance might exist.

To be deprecated in a future version V3R00. Use the Quantity element with a QuantityContext of "Deviation".

AdditionalText

AdditionalText is optional. Multiple instances might exist.

A text field that is used to communicate information not previously defined or for special instructions. To be used only for circumstances not covered by specific elements.

CallOffWoodProductGroup

CallOffWoodProductGroup provides for groupings of line items in the CallOff e-Document.

This construct was introduced in version v2r30. It is recognized that the introduction of this construct is not in conformance with the papiNet policy of backward compatibility within releases of the same version.

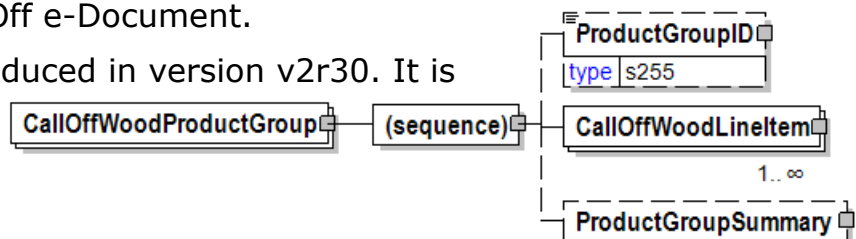

(sequence)

The sequence of items below is mandatory. A single instance is required.

ProductGroupID

ProductGroupID is optional. A single instance might exist.

Possibility to group packages or Shipments. Example: Creating temporary group ID's for logistic reasons or lot number.

CallOffWoodLineItem

CallOffWoodLineItem is mandatory. One instance is required, multiple instances might exist.

CallOffWoodLineItem has a required attribute that indicates the status of the line item.

ProductGroupSummary

ProductGroupSummary is optional. A single instance might exist.

Group of elements to provide summary information on product level.

CallOffWoodSummary

Summary information that applies to the Wood market segment CallOff e-Document.

(sequence)

The sequence of items below is mandatory. A single instance is required.

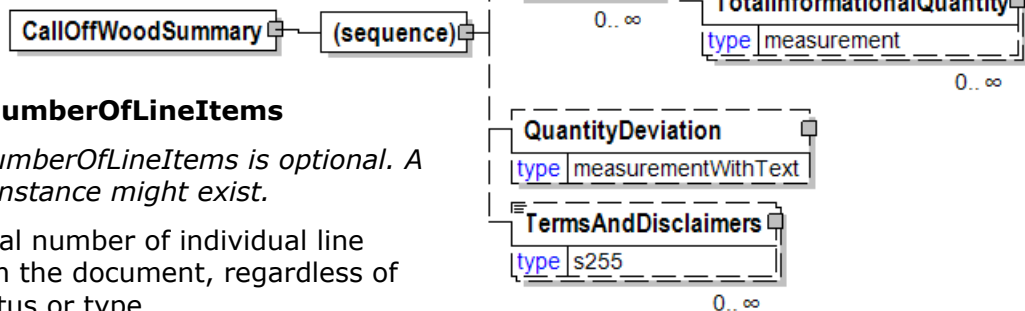

TotalNumberOfLineItems

TotalNumberOfLineItems is optional. A single instance might exist.

The total number of individual line items in the document, regardless of the status or type.

(sequence)

The sequence of items below is optional. Multiple instances might exist.

TotalQuantity

TotalQuantity is mandatory. A single instance is required.

The total quantity of similar items in the e-Document. TotalQuantity is primarily used in the summary section of documents where it is repeatable to permit totaling for different units of measure.

TotalInformationalQuantity

TotalInformationalQuantity is optional. Multiple instances might exist.

A quantity that is used to communicate related information about the parent element. This element represents a total that is derived from individual line items.

QuantityDeviation

QuantityDeviation is optional. A single instance might exist.

To be deprecated in a future version V3R00. Use the Quantity element with a QuantityContext of "Deviation".

TermsAndDisclaimers

TermsAndDisclaimers is optional. Multiple instances might exist.

An element that contains legal information with an indication of what the Language

is.

CarrierParty

The party performing the transport of the product from the pickup location to the ship-to location; could be a hauler.

LogisticsRole [attribute]

LogisticsRole is optional. A single instance might exist.

Communicates the nature of the logistics role, if any, the party plays in the transaction.

Refer to LogisticsRole definition for any enumerations.

(sequence)

The sequence of items below is mandatory. A single instance is required.

PartyIdentifier

PartyIdentifier is optional. Multiple instances might exist.

A unique identifier of a specific party. This element contains an attribute PartyIdentifierType that indicates the type of the identifier.

NameAddress

NameAddress is mandatory. A single instance is required.

A group item containing name and address of an organisation or business entity.

URL

URL is optional. A single instance might exist.

Universal Resource Locator. While typically a web address you could use this field to hold an email address.

CommonContact

CommonContact is optional. Multiple instances might exist.

Identifies a specific individual associated with the party.

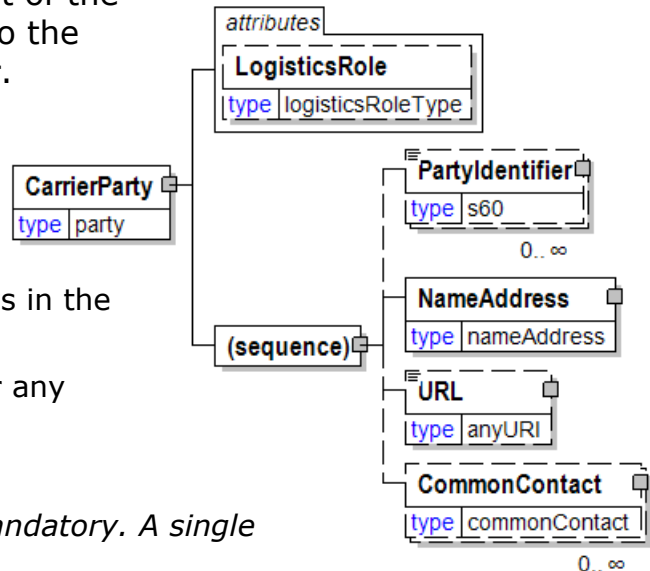

Case

Case information

BindingBackingType [attribute]

BindingBackingType is optional. A single instance might exist.

Specifies the shape of the book spine during the binding operation.

Refer to BindingBackingType definition for any enumerations.

ClothCrossCut [attribute]

ClothCrossCut is optional. A single instance might exist.

Either "Yes" or "No".

Refer to ClothCrossCut definition for any enumerations.

(sequence)

The sequence of items below is mandatory. A single instance is required.

CaseLining

CaseLining is optional. A single instance might exist.

Case lining

CaseSupers

CaseSupers is optional. A single instance might exist.

Case supers

Headband

Headband is optional. Multiple instances might exist.

Headband.

CaseMaking

CaseMaking is optional. A single instance might exist.

Case making

DecorationSpecs

DecorationSpecs is optional. Multiple instances might exist.

Decoration specifications

AdditionalText

AdditionalText is optional. Multiple instances might exist.

A text field that is used to communicate information not previously defined or for special instructions. To be used only for circumstances not covered by specific elements.

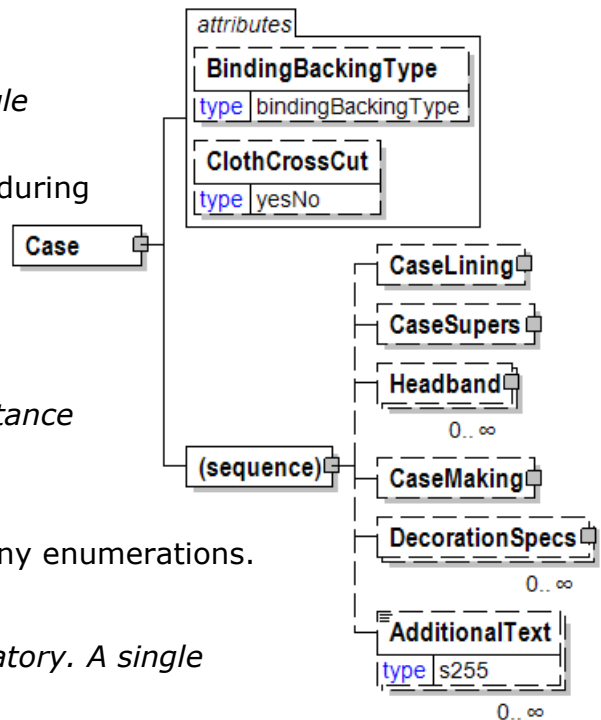

CaseBoardMaterials

Case board materials

CaseLocationType [attribute]

CaseLocationType is optional. A single instance might exist.

Case location type

Refer to
CaseLocationType
definition for any enumerations.

CaseBoardType [attribute]

CaseBoardType is optional. A single instance might exist.

The type of case board material.

Refer to CaseBoardType definition for any enumerations.

(sequence)

The sequence of items below is mandatory. A single instance is required.

Caliper

Caliper is optional. A single instance might exist.

The thickness of a sheet of paper under standard test conditions.

AdditionalText

AdditionalText is optional. Multiple instances might exist.

A text field that is used to communicate information not previously defined or for special instructions. To be used only for circumstances not covered by specific elements.

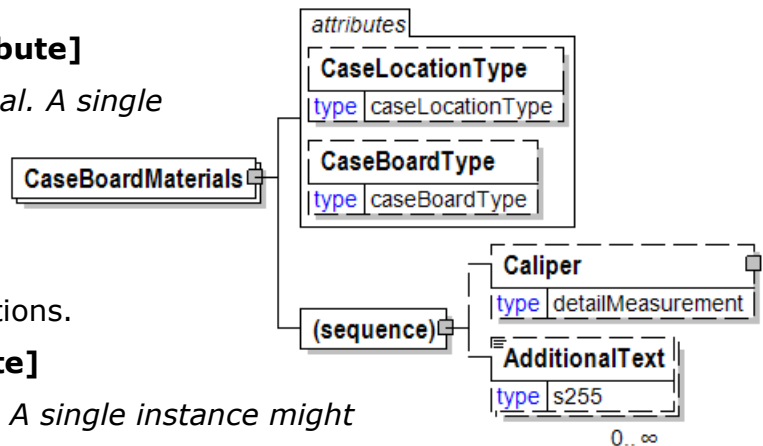

CaseBoardType [attribute]

The type of case board material.

This item is restricted to the following list.

Binders

Chipboard

Eskaboard

Fluted

Padded

PastedOak

Other

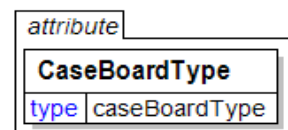

CaseFlushFoot [attribute]

Either "Yes" or "No".

This item is restricted to the following list.

Yes

No

attribute	
CaseFlushFoot	
type	yesNo

CaseLining

Case lining

(sequence)

The sequence of items below is mandatory. A single instance is required.

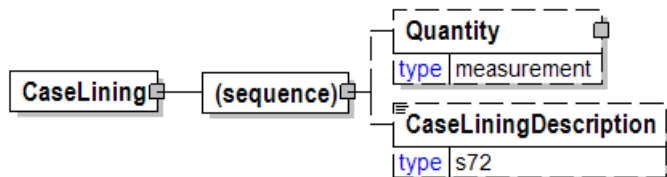

Quantity

Quantity is optional. A single instance might exist.

The Quantity element contains attributes that provide information about the type of quantity that is being communicated, the context in which the particular quantity is to be viewed, and (if the quantity represents an adjustment) an adjustment type.

The Quantity element contains three child elements that enable you to communicate a range of values for the quantity and a target or actual value. It is at this level (Value, RangeMin, and RangeMax) that the unit of measure is specified. This permits the range to be specified in a different unit of measure than the target.

CaseLiningDescription

CaseLiningDescription is optional. A single instance might exist.

Case lining description

CaseLiningDescription

Case lining description

CaseLiningDescription	
type	s72

CaseLocationType [attribute]

Case location type

This item is restricted to the following list.

Front

Back

Spine

FrontAndBack

FrontAndSpine

BackAndSpine

attribute	
CaseLocationType	
type	caseLocationType

FrontAndBackAndSpine

CaseMaking

Case making

CaseType [attribute]

CaseType is optional. A single instance might exist.

Case type

Refer to CaseType definition for any enumerations.

CaseFlushFoot [attribute]

CaseFlushFoot is optional. A single instance might exist.

Either "Yes" or "No".

Refer to CaseFlushFoot definition for any enumerations.

(sequence)

The sequence of items below is mandatory. A single instance is required.

CaseShow

CaseShow is optional. A single instance might exist.

Case show

CaseOversize

CaseOversize is optional. A single instance might exist.

Case oversize

CaseBoardMaterials

CaseBoardMaterials is optional. Multiple instances might exist.

Case board materials

CaseMaterial

CaseMaterial is optional. Multiple instances might exist.

Case material

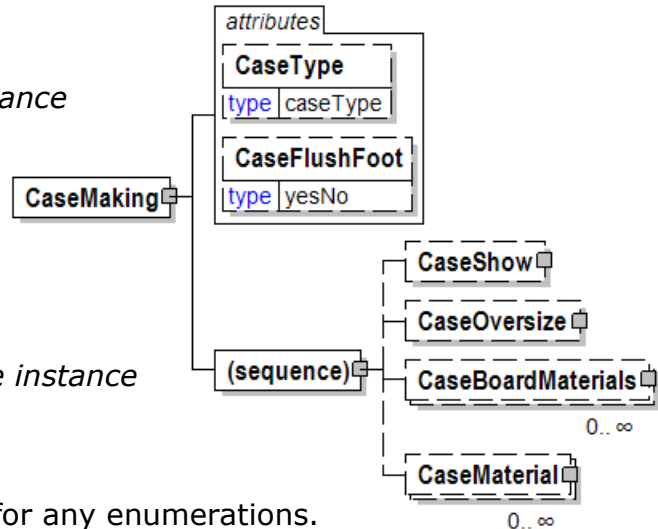

CaseMaterial

Case material

CaseLocationType [attribute]

CaseLocationType is optional. A single instance might exist.

Case location type

Refer to CaseLocationType

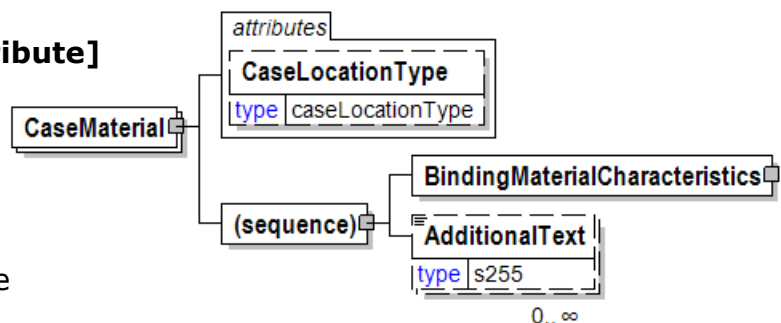

definition for any enumerations.

(sequence)

The sequence of items below is mandatory. A single instance is required.

BindingMaterialCharacteristics

BindingMaterialCharacteristics is mandatory. A single instance is required.

Binding Material Characteristics

AdditionalText

AdditionalText is optional. Multiple instances might exist.

A text field that is used to communicate information not previously defined or for special instructions. To be used only for circumstances not covered by specific elements.

CaseOversize

Case oversize

(sequence)

The sequence of items below is mandatory. A single instance is required.

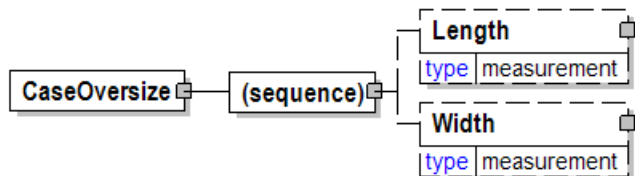

Length

Length is optional. A single instance might exist.

The length of the object.

Width

Width is optional. A single instance might exist.

The width of the object.

CaseShow

Case show

CaseShowType [attribute]

CaseShowType is optional. A single instance might exist.

Case show type

Refer to CaseShowType definition for any enumerations.

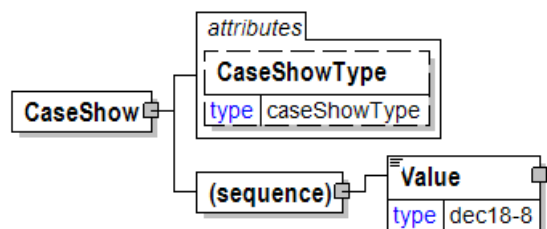

(sequence)

The sequence of items below is mandatory. A single instance is required.

Value

Value is mandatory. A single instance is required.

A numeric value expressed in the unit of measure (UOM).

CaseShowType [attribute]

Case show type

This item is restricted to the following list.

SpineOverSide

SideOverSpine

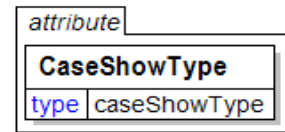

CaseSupers

Case supers

SupersType [attribute]

SupersType is optional. A single instance might exist.

Supers Type

Refer to SupersType definition for any enumerations.

(sequence)

The sequence of items below is mandatory. A single instance is required.

Quantity

Quantity is optional. A single instance might exist.

The Quantity element contains attributes that provide information about the type of quantity that is being communicated, the context in which the particular quantity is to be viewed, and (if the quantity represents an adjustment) an adjustment type.

The Quantity element contains three child elements that enable you to communicate a range of values for the quantity and a target or actual value. It is at this level (Value, RangeMin, and RangeMax) that the unit of measure is specified. This permits the range to be specified in a different unit of measure than the target.

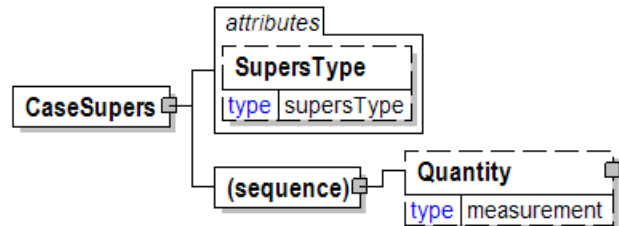

CaseType [attribute]

Case type

This item is restricted to the following list.

OnePiece

TwoPiece

ThreePiece

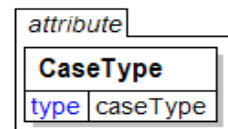

CassetteCardReference

Cassette card reference

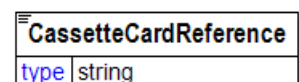

CassetteLabelCharacteristics

Cassette label characteristics

CassetteLabelSide [attribute]

CassetteLabelSide is optional. A single instance might exist.

Cassette label side

Refer to
CassetteLabelSide definition for any
enumerations.

CassetteLabelType [attribute]

CassetteLabelType is optional. A single instance might exist.

Cassette label type

Refer to CassetteLabelType definition for any enumerations.

(sequence)

The sequence of items below is mandatory. A single instance is required.

ColourSpecs

ColourSpecs is optional. A single instance might exist.

Colour specs

PressPrep

PressPrep is optional. Multiple instances might exist.

Press preparation information

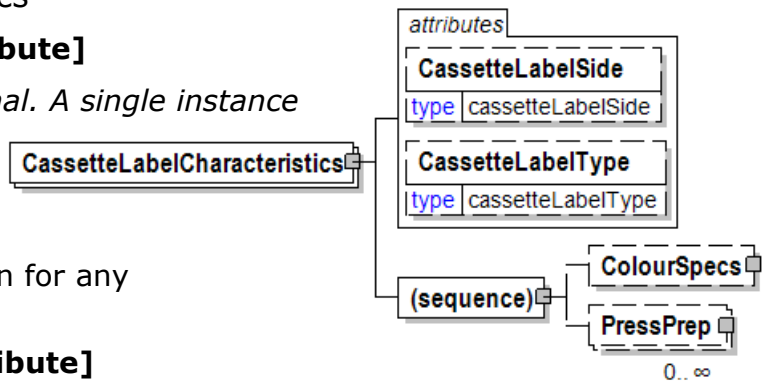

CassetteLabelSide [attribute]

Cassette label side

This item is restricted to the following list.

LabelOneSide

LabelTwoSide

SameLabelBothSide

Face

Spine

FaceAndSpine

None



CassetteLabelType [attribute]

Cassette label type

This item is restricted to the following list.

Braille



DirectImprint

PaperLabel

None

Other

CD

CD

CDFormatType [attribute]

CDFormatType is optional. A single instance might exist.

CD format type

Refer to CDFormatType definition for any enumerations.

CDManufacturingProcess [attribute]

CDManufacturingProcess is optional. A single instance might exist.

CD manufacturing process.

Any valid string.

CDRType [attribute]

CDRType is optional. A single instance might exist.

Describes the finish to be applied to the CD.

Refer to CDRType definition for any enumerations.

DiscPrinting [attribute]

DiscPrinting is optional. A single instance might exist.

Disc printing

Refer to DiscPrinting definition for any enumerations.

(sequence)

The sequence of items below is mandatory. A single instance is required.

SequenceNumber

SequenceNumber is optional. A single instance might exist.

A sequential number that uniquely identifies a sequence.

NumberOfColours

NumberOfColours is optional. A single instance might exist.

The number of colours

ColourSpecs

ColourSpecs is optional. A single instance might exist.

Colour specs

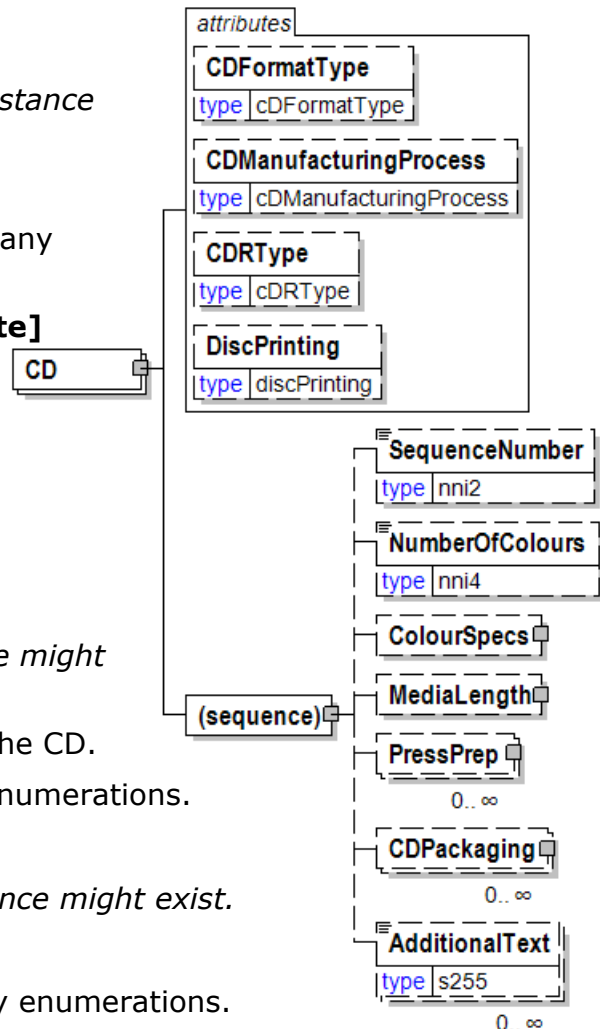

papiNet V2R31

MediaLength

MediaLength is optional. A single instance might exist.

Media length

PressPrep

PressPrep is optional. Multiple instances might exist.

Press preparation information

CDPackaging

CDPackaging is optional. Multiple instances might exist.

CD Packaging

AdditionalText

AdditionalText is optional. Multiple instances might exist.

A text field that is used to communicate information not previously defined or for special instructions. To be used only for circumstances not covered by specific elements.

CDFormatType [attribute]

CD format type

This item is restricted to the following list.

Audio

CDPhoto

CDI

Enhanced

MixedMode

ROM

Video

Other

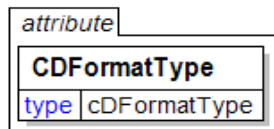

CDManufacturingProcess [attribute]

CD manufacturing process.

Any valid string.

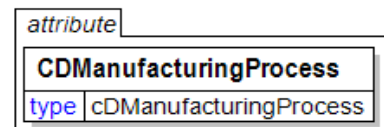

CDPackaging

CD Packaging

(choice)

[choice] is mandatory. A single instance is required.

BulkNumberOfUnits

BulkNumberOfUnits is mandatory. A single instance is required.

Bulk number of units

JewelBox

JewelBox is mandatory. A single instance is required.

Jewel box.

Sleeve

Sleeve is mandatory. A single instance is required.

Sleeve.

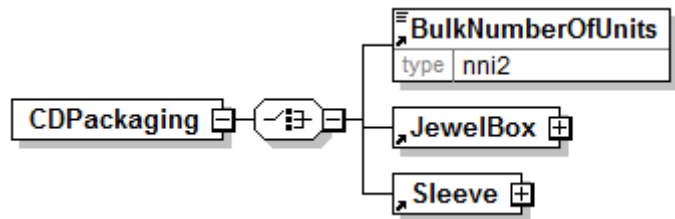

CDRType [attribute]

Describes the finish to be applied to the CD.

This item is restricted to the following list.

None

CD RCRDBL SLVR

PROMEDIA SLVR

RITEX/TDK SLVR

Other

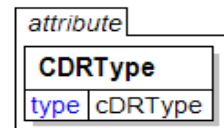

CertificationBody [attribute]

Any valid text string that specifies the entity responsible for certification.

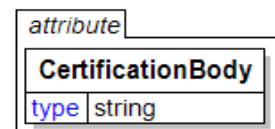

ChainOfCustody

The chain of custody.

CertificationBody [attribute]

CertificationBody is optional. A single instance might exist.

Any valid text string that specifies the entity responsible for certification.

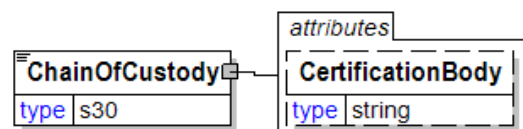

ChangeDetailType [attribute]

Specifies how a package is changed.

This item is restricted to the following list.

Add

The package is added.

Change

The package is changed.

Remove

The package is removed.

ChangeDetailType	
type	changeType
default	Change

ChangesAllowed [attribute]

Indicates if the given information is allowed to be changed or not, i.e. if a logistics partner is bound to execute as instructed or can change instructed requirements.

This item is restricted to the following list.

Yes

No

ChangesAllowed	
type	yesNo
default	Yes

Charge

Charge is a group element that contains elements that describe a charge.

ChargeType [attribute]

ChargeType is mandatory. A single instance is required.

The type of charge

Refer to ChargeType definition for any enumerations.

ChargeContext [attribute]

ChargeContext is optional. A single instance might exist.

Describes the relationship of the charge to the associated to the Complaint, generally used for statistical purposes.

Refer to ChargeContext definition for any enumerations.

Agency [attribute]

Agency is optional. A single instance might exist.

Describes the agency maintaining the list of codes. To

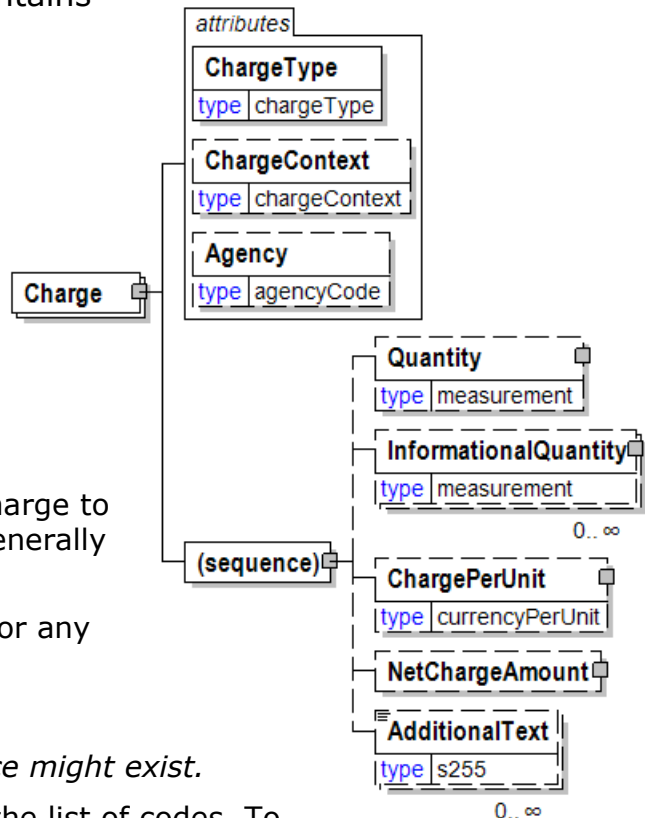

be included in this list the agency must be a recognized standards body or industry organisation.

- For the element that owns this attribute.
- For another attribute in the list of attributes associated with the parent element.

Refer to Agency definition for any enumerations.

(sequence)

The sequence of items below is mandatory. A single instance is required.

Quantity

Quantity is optional. A single instance might exist.

The Quantity element contains attributes that provide information about the type of quantity that is being communicated, the context in which the particular quantity is to be viewed, and (if the quantity represents an adjustment) an adjustment type.

The Quantity element contains three child elements that enable you to communicate a range of values for the quantity and a target or actual value. It is at this level (Value, RangeMin, and RangeMax) that the unit of measure is specified. This permits the range to be specified in a different unit of measure than the target.

InformationalQuantity

InformationalQuantity is optional. Multiple instances might exist.

A quantity given in a valid UOM used for information purposes only (not for calculation). For example, an ordered quantity was 100 reels as opposed to the invoice quantity of 20,000 pounds.

ChargePerUnit

ChargePerUnit is optional. A single instance might exist.

A group item containing a currency value and measurement to communicate a per unit charge.

NetChargeAmount

NetChargeAmount is optional. A single instance might exist.

A field containing the sum of all instances of the Complaint charges.

AdditionalText

AdditionalText is optional. Multiple instances might exist.

A text field that is used to communicate information not previously defined or for special instructions. To be used only for circumstances not covered by specific elements.

ChargeAmount

A field containing the total amount in ChargeInformation including tax (when tax is specified in ChargeInformation).

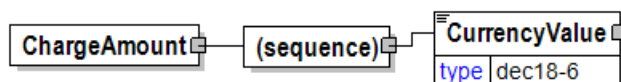

ChargeAmount is equal to the ChargeNetAmount plus the sum of the signed values of the MonetaryAdjustmentAmount for all instances of MonetaryAdjustment in

ChargeInformation.

(sequence)

The sequence of items below is mandatory. A single instance is required.

CurrencyValue

CurrencyValue is mandatory. A single instance is required.

The amount in the referenced currency as defined by the CurrencyType attribute.

ChargeContext [attribute]

Describes the relationship of the charge to the associated to the Complaint, generally used for statistical purposes.

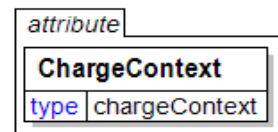

This item is restricted to the following list.

Administrative

Logistical

Production

Rework

Storage

Waste

Other

ChargeInformation

A group element that contains elements that describe a charge.

ChargeInformation is used when charge details need to be specified by using a code assigned by an agency. It is typically used for freight costs and other costs related to the supply chain.

(sequence)

The sequence of items below is mandatory. A single instance is required.

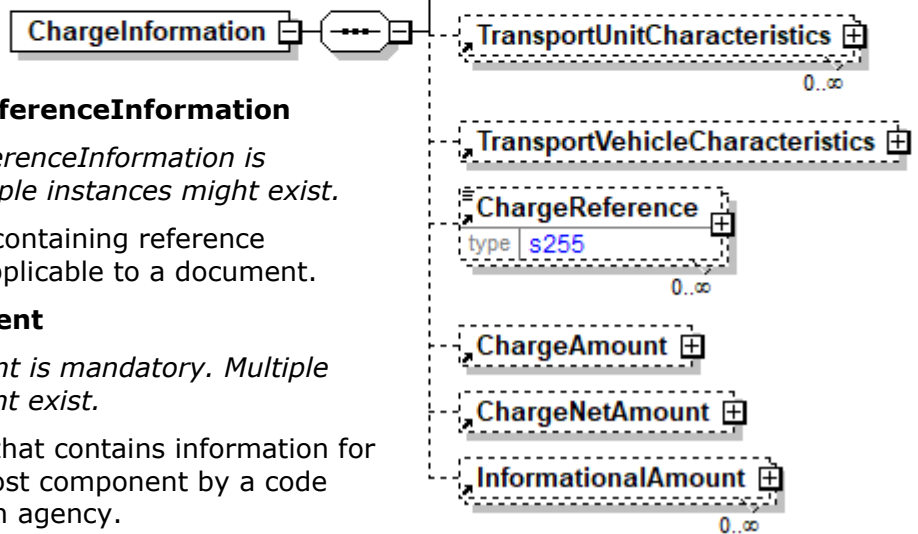

DocumentReferenceInformation

DocumentReferenceInformation is optional. Multiple instances might exist.

A group item containing reference information applicable to a document.

CostComponent

CostComponent is mandatory. Multiple instances might exist.

A group item that contains information for specifying a cost component by a code assigned by an agency.

PriceDetails

PriceDetails is optional. A single instance might exist.

An element that groups together price information.

MonetaryAdjustment

MonetaryAdjustment is optional. Multiple instances might exist.

The element containing the information necessary for the understanding, calculation, and treatment of an adjustment to a currency amount. MonetaryAdjustment contains an attribute that indicates they type of adjustment being communicated.

QuantityInformation

QuantityInformation is optional. A single instance might exist.

A group item containing information about quantity and informational quantity of similar items.

TransportUnitCharacteristics

TransportUnitCharacteristics is optional. Multiple instances might exist.

A group item containing information about a transport unit, e.g. a trailer. Transport units contain goods and move using power from another source, the transport vehicle.

TransportVehicleCharacteristics

TransportVehicleCharacteristics is optional. A single instance might exist.

A group item containing information about a transport vehicle, e.g. a truck. A transport vehicle has its own power and can be used to pull, push, carry, or tow a transport unit loaded with goods.

ChargeReference

ChargeReferences is optional. Multiple instances might exist.

An element detailing relevant references pertaining to the charge as indicated by ChargeReferenceType and AssignedBy.

ChargeReference will be deprecated in a future version V3R00 and should not be used in new implementations. Use instead DocumentReferenceInformation.

ChargeAmount

ChargeAmount is optional. A single instance might exist.

A field containing the total amount in ChargeInformation including tax (when tax is specified in ChargeInformation).

ChargeAmount is equal to the ChargeNetAmount plus the sum of the signed values of the MonetaryAdjustmentAmount for all instances of MonetaryAdjustment in ChargeInformation.

ChargeNetAmount

ChargeNetAmount is optional. A single instance might exist.

A field containing the charged amount in ChargeInformation excluding adjustments and tax.

InformationalAmount

InformationalAmount is optional. Multiple instances might exist.

A monetary amount used for information purposes only (not for calculation). For example, the invoice price adjustment subtotal is expressed in sterling pounds, and the buyer wants this information expressed in U.S. dollars.

CreditDebitNote and Invoice - The TaxAmount is displayed in the currency that is applicable throughout the e-Document. When a TaxAmount needs to be displayed in a different national currency, this field is used.

ChargeNetAmount

A field containing the charged amount in ChargeInformation excluding adjustments and tax.

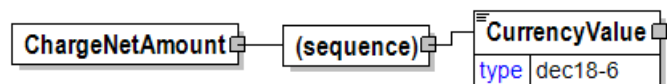

(sequence)

The sequence of items below is mandatory. A single instance is required.

CurrencyValue

CurrencyValue is mandatory. A single instance is required.

The amount in the referenced currency as defined by the CurrencyType attribute.

ChargeOrAllowance

The description of the charge or allowance; such as freight, special handling, and stop-off handling.

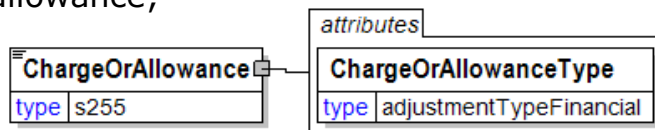

ChargeOrAllowanceType **[attribute]**

ChargeOrAllowanceType is mandatory. A single instance is required.

Defines what type of charge or allowance defines the invoice product.

Refer to ChargeOrAllowanceType definition for any enumerations.

ChargeOrAllowanceType [attribute]

Defines what type of charge or allowance defines the invoice product.

This item is restricted to the following list.

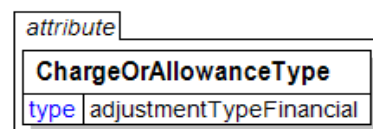

BillOfLadingCharge

An extra charge for creating a Bill of Lading.

CancellationCharge

A charge applied because a cancellation was late (after the last date of change) and all or part of the ordered product has already been made.

CashDiscount

A reduction due to a discount applied.

CertificateCharge

An extra charge for creating a certificate. Some countries requires Certificates in which different characteristics of the delivery, transport unit, route, product, and others must be proved.

There are certificates for gasen pallets, for the place of production, for the age of the ship/vessel, for not departing from one country's harbour when delivering to another.

ChargesForward

A pending Invoice amount brought forward from a previous Invoice.

ClaimAdjustment

An adjustment related to a filed complaint.

Commission

Commission costs paid to the trading agency or trader.

CompetitiveAllowance

An allowance provided for competitive reasons.

CongestionCharge

An extra fee from ports for waiting time of ships in ports, railcars on a siding, trucks at a dock. (Synonym: Demurrage.)

ConsigneeUnloadCharge

An unloading charge that is the responsibility of the consignee.

ContractAllowance

An allowance for a volume discount, usually because the agreed amount has been exceeded.

CurrencyAdjustmentCharge

An extra fee to adjust for currency variations.

DecimalRounding

Adjustments for rounding of amounts to fit the business agreement or national monetary legislation. This adjustment is typically used for decimal rounding of amounts not including tax.

N.B. Use InformationalAmount with AmountType "DecimalRounding" for specification of decimal rounding of amounts including tax.

DefectiveAllowance

An allowance provided for defective material.

DeliveryCharge

The charge for delivering the product.

DeliveryNonConformanceAllowance

An allowance due to non-conformance with the purchase agreement regarding a delivery.

DeliveryTimeBonus

A bonus given for deliveries of products within a certain time period.

EarlyShipAllowance

An allowance due to a delivery that took place earlier than planned. The seller may be charged a penalty. If this is found before issuing the Invoice, it can be handled through this allowance. If found later, it will be handled through a credit note.

EnergySurcharge

A charge related to increases in the cost of energy.

Environmental

An allowance applied due to environmental regulations.

ExpeditedShipmentCharge

An extra cost charged due to unexpected or emergency requirements (for example, breaking off a run in the mill to reach the production date for a rush order).

ExportClearanceCharge

An extra fee for customs administration.

FlatRateCharge

A general flat charge.

FreightAllowance

papiNet V2R31

The freight cost allowed by the mill. This amount is negative, and will be deducted from the Invoice (U.S. business practice, in the European Union (EU), use only Freight Charge).

FreightCharge

The actual cost incurred to deliver the product. This amount is positive, and will be added to the Invoice.

FuelAdjustmentCharge

An extra fee, usually from shipping companies, to adjust fuel prices.

HandlingCharge

A charge related to the handling of the product.

Inspection

The cost associated with performing an inspection of the product.

InterestCharge

A charge applied for interest on overdue payments.

LabourAllowance

An allowance due to additional labour required in the use or acceptance of the product.

LabourCharge

A charge due to additional labour required in the use or acceptance of the product.

LoggingDamage

An adjustment caused by logging damages on Forest Wood products. Logging damages normally cause a reduction of the product price.

LotCharge

A charge applied to the lot of material.

MetalDetection

A charge for additional metal detection applied to the goods.

ModelHomeDiscount

A discount associated with the building of the model home.

NewStoreCouponDiscount

A discount associated with entry into a new store.

OrderQuantity

A charge or allowance for small/big ordered quantities.

PalletCharge

A charge that represents the cost or rental of the pallet.

PickUpAllowance

An allowance provided to compensate for the cost of picking up the product.

PromotionalAllowance

An allowance provided for the promotion of the product.

PromotionalCharge

A charge associated with the promotion of the product.

PriceCorrection

An adjustment associated with a correction of the product's price.

ProductionSetUpCharge

A special charge applied due to specific buyer requests.

Provision

The act of making ready or equipping for use.

Rebate

A rebate accepted by the buyer and seller based on the agreed price and volume.

ReelDiscount

An allowance for purchasing reels instead of sheets.

ReturnedLoadAllowance

An allowance applied due to the return of the load.

ReturnLoadCharge

A charge applied due to the return of the load.

RoadFeeCharge

A freight charge for a special tax applied to road transports in some countries, e.g. Germany

ScrapAndDunnageCharge

A charge that represents the scrapping of the material and its removal.

ServiceCharge

A charge associated with a miscellaneous service.

SpecialConversionCharge

Additional charge for a special conversion of the product.

SpecialDeliveryCharge

A special charge for delivering the product differently from the usual or agreed-to method.

SpecialHandlingCharge

A special charge for handling the product differently from the usual or agreed-to method.

SpecialPackagingCharge

A special charge for packaging the product differently from the usual or agreed-to method, or if packaging as requested is out of spec.

StopOffAllowance

An allowance for a delivery stop-off.

StopOffCharge

A charge for a delivery stop-off.

StorageAllowance

An allowance for storing the product.

StorageCharge

An extra cost charged for storing the product on location (in the plant).

Tax

An adjustment that reflects a tax item.

TestingCharge

A charge related to testing a paper grade.

TradeDiscount

A discount based on the terms of the trade given on the agreed price. Usually a percentage.

TrialDiscount

A discount applied for a trial run of a new or improved product.

TransferCharge

A freight charge incurred by the goods transfer from one location to another location not previously agreed upon.

UnloadingAllowance

An allowance to compensate for the unloading the product.

UnloadingCharge

A charge for the unloading the product.

VolumeDiscount

A rebate accepted by the buyer and the seller based on the agreed volume

WarRiskCharge

An extra fee from transport companies for transport units that cross war zones.

Other

Any other adjustment not covered by the attribute list.

ChargePerUnit

A group item containing a currency value and measurement to communicate a per unit charge.

(sequence)

The sequence of items below is mandatory. A single instance is required.

CurrencyValue

CurrencyValue is mandatory. A single instance is required.

The amount in the referenced currency as defined by the CurrencyType attribute.

Value

Value is mandatory. A single instance is required.

A numeric value expressed in the unit of measure (UOM).

RangeMin

RangeMin is optional. A single instance might exist.

The minimum value (lower boundary) allowed for the Measurement that is the parent of this element.

RangeMax

RangeMax is optional. A single instance might exist.

The maximum value (upper boundary) allowed for the Measurement that is the parent of this element. Some elements use the RangeMax element with an extended list of unit of measures. (Note: the red colour in the picture is an artifact of how the graphic was captured and should be disregarded.)

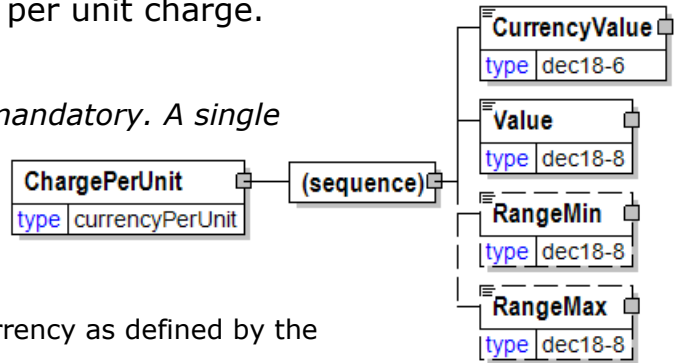

ChargeReference

An element detailing relevant references pertaining to the charge as indicated by ChargeReferenceType and AssignedBy.

ChargeReference will be deprecated in a future version V3R00 and should not be used in new implementations. Use instead DocumentReferenceInformation.

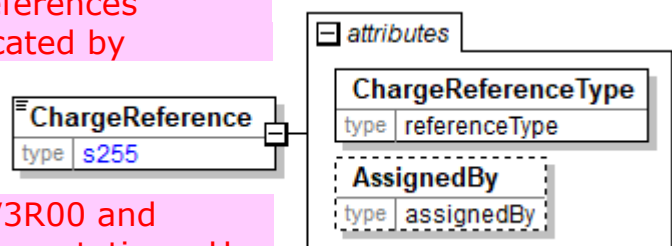

ChargeReferenceType [attribute]

ChargeReferenceType is mandatory. A single instance is required.

Provides a contextual explanation of the specific reference identifier. Many items are currently prefixed by "Buyer", "Forwarder", "Manufacturer", "Mill", "Seller", "Supplier", "Warehouse", or "Vendor". Check for an existing non-prefixed version and use the non-prefixed version instead. In the (yet to be announced release date) version 3.0 the prefixed versions will be removed. Instead the attribute AssignedBy will communicate the information previously communicated in the prefix.

Refer to ChargeReferenceType definition for any enumerations.

AssignedBy [attribute]

AssignedBy is optional. A single instance might exist.

Identifies the type of party or the agency that has assigned the associated item, e.g. a reference of type OrderNumber.

Refer to AssignedBy for any enumerations.

ChargeReferenceType [attribute]

Provides a contextual explanation of the specific reference identifier. Many items are currently prefixed by "Buyer", "Forwarder", "Manufacturer", "Mill", "Seller", "Supplier", "Warehouse" or "Vendor". Check for an existing non-prefixed version and use the non-prefixed version instead. In the (yet to be announced release date) version 3.0 the prefixed versions will be removed. Instead the attribute AssignedBy will communicate the information previously communicated in the prefix.

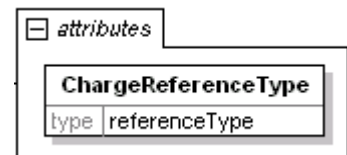

Refer to the [referenceType](#) entry for the list of enumerations and their definitions.

ChargeType [attribute]

The type of charge

This item is restricted to the following list.

AdministrativeCosts

The administrative costs involved as a result of the complaint, for instance, to sell or scrap the waste.

AgreedWasteToScrap

The agreed to quantity or amount of paper the complainer declares to scrap.

AgreedWasteToSell

The agreed to quantity or amount of paper the complainer declares to sell.

ConversionCosts

Costs associated with product conversion (i.e. slitting, rewinding, etc).

KnownProductionDowntime

Production down time associated with KnownBreaks.

LabourCosts

The labour costs involved as a result of the complaint, for instance reels that need to be cleaned because of edge cuttings.

MachineDamage

The damage suffered by the machine as a result of poor quality paper

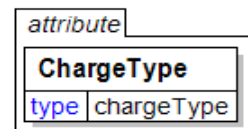

supplied.

PriceDifference

A difference in the price.

ProductionDowntime

Production downtime associated with the result of poor quality paper or a service problem.

RejectedReel

The reel(s) rejected because not workable by the converter/printer.

UnknownProductionDowntime

Production downtime associated with Breaks.

WasteToScrap

The proposed quantity or amount of paper the complainer declares to scrap.

WasteToSell

The proposed quantity or amount of paper the complainer declares to sell.

WrongQuantity

The wrong quantity was reported.

Other

Used to communicate a ChargeType that is not available in the enumerated list.

ChildrensTitle [attribute]

Specifies if the book product is designated for use by children 12 and under or not.

This item is restricted to the following list.

attribute	
ChildrensTitle	
type	childrensTitleType

NotChildrensTitle

Not a children's product; no testing required for lead or phthalates.

ChildrensWithPlayValue

Designated as a children's product and has "play value" outside of reading and writing; requires testing for lead and phthalates. (Examples of "play value" include paper doll books, sticker books, board books and bathtub books).

ChildrensWithoutPlayValue

Designated as a children's product but does not have any "play value" outside of reading and writing; requires testing for lead but not phthalates.

Chip

Chip information.

(sequence)

The sequence of items below is mandatory. A single instance is required.

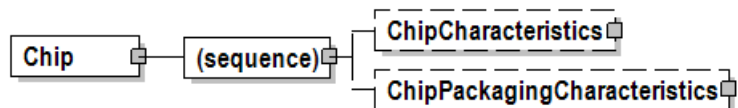

ChipCharacteristics

ChipCharacteristics is optional. A single instance might exist.

Chip characteristics

ChipPackagingCharacteristics

ChipPackagingCharacteristics is optional. A single instance might exist.

ChipPackagingCharacteristics provides information about the containerisation of the wood chips.

ChipCharacteristics

Chip characteristics

Screened [attribute]

Screened is optional. A single instance might exist.

Either "Yes" or "No".

Refer to Screened definition for any enumerations.

Debarked [attribute]

Debarked is optional. A single instance might exist.

Either "Yes" or "No".

Refer to Debarked definition for any enumerations.

(sequence)

The sequence of items below is mandatory. A single instance is required.

Thickness

Thickness is optional. A single instance might exist.

Physical dimension of a product.

Moisture

Moisture is optional. A single instance might exist.

Desired percentage, or other indicator, of water in the product at the time of shipment.

Dirt

Dirt is optional. A single instance might exist.

A group item used to communicate dirt content target or test value according to a particular TestMethod.

Bark

Bark is optional. A single instance might exist.

Used to report bark content in chips as a detail measurement.

Sawdust

Sawdust is optional. A single instance might exist.

Used to report sawdust content in chips as a detail measurement.

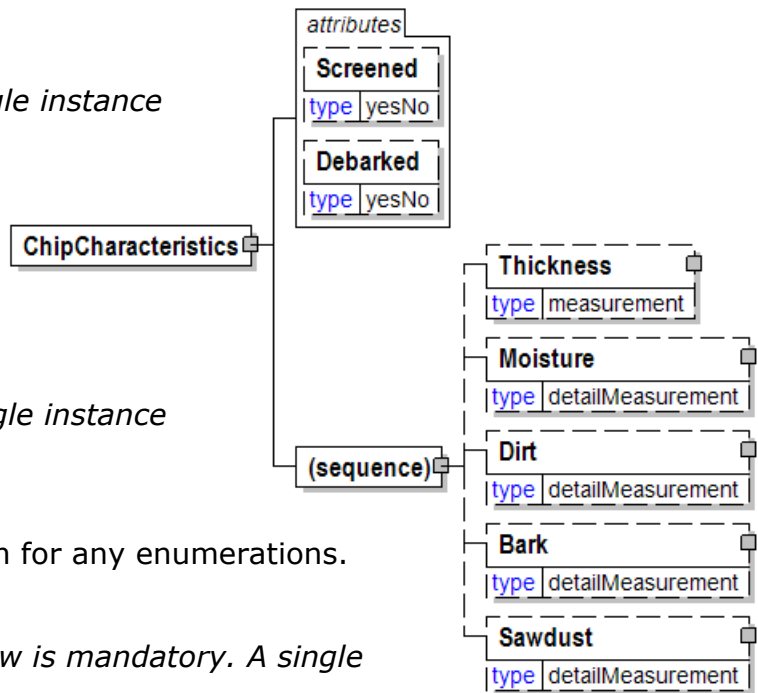

ChipFraction

A grouping element that contains information about one fraction from an analysis of chip fractions.

ChipFractionPropertyType [attribute]

ChipFractionPropertyType is mandatory. A single instance is required.

Defines the type of property for analysis of chip fractions.

Refer to ChipFractionPropertyType definition for any enumerations.

(sequence)

The sequence of items below is mandatory. A single instance is required.

ChipFractionNumber

ChipFractionNumber is mandatory. A single instance is required.

The identifier of a chip fraction.

ChipFractionDescription

ChipFractionDescription is optional. Multiple instances might exist.

A free form description of the chip fraction.

ChipFractionClass

ChipFractionClass is optional. A single instance might exist.

Specifies the class of the chip fraction.

ChipFractionValue

ChipFractionValue is mandatory. A single instance is required.

A grouping element for a chip fraction value and its statistical measures.

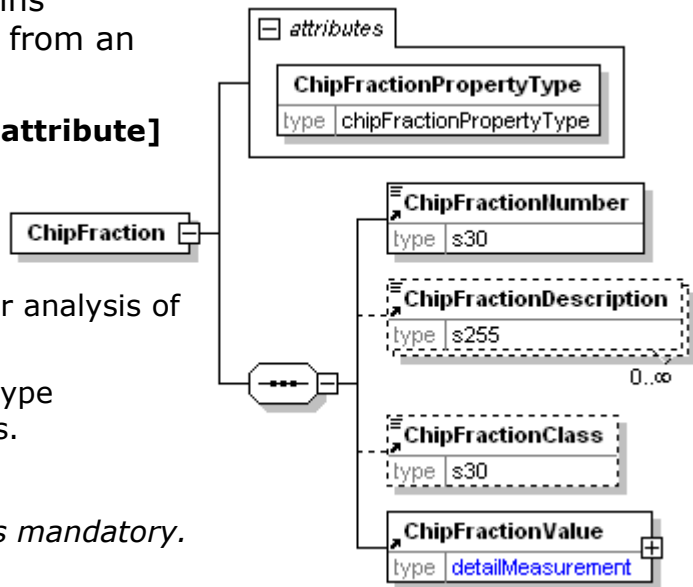

ChipFractionAnalysisDate

The date when the analysis of chip fractions was done.

(sequence)

The sequence of items below is mandatory. A single instance is required.

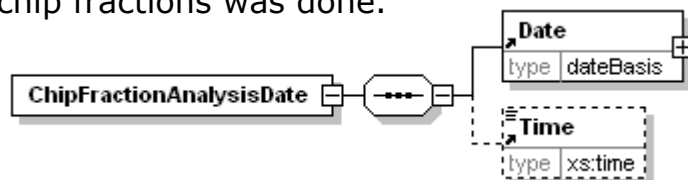

Date

Date is mandatory. A single instance is required.

A group element that contains the specification of Year, Month, and Day.

Time

Time is optional. A single instance might exist.

Times are treated in a standard XML fashion with a special case used to indicate a generalized "local" time. The standard XML approach to time is hh:mm:ss,

papiNet V2R31

hh:mm:ssZ, or hh:mm:ss±hh:mm.

- hh:mm:ss±hh:mm is used to represent a time with a time zone. The time zone is communicated as the number of hours offset from the Universal Time Coordinate (UTC), a.k.a. Greenwich Mean Time.
- hh:mm:ssZ indicates the time at Zulu (another name for UTC).
- hh:mm:ss or hh:mm indicates within papiNet the applicable local time where the associated event is taking place. Caution should be used when processing times of this nature as the papiNet approach may be in discord with other users of XML.

ChipFractionClass

Specifies the class of the chip fraction.

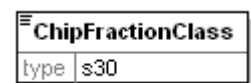

ChipFractionDescription

A free form description of the chip fraction.

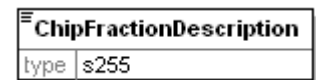

ChipFractionInfo

Grouping element that contains information about analysis of chip fractions.

TestMethod [attribute]

TestMethod is optional. A single instance might exist.

The method used to determine the results of the test under consideration.

TestAgency [attribute]

TestAgency is optional. A single instance might exist.

The agency that has set the parameters for the testing

Refer to TestAgency definition for any enumerations.

SampleType [attribute]

SampleType is optional. A single instance might exist.

Communicates how sampling was done to measure the product

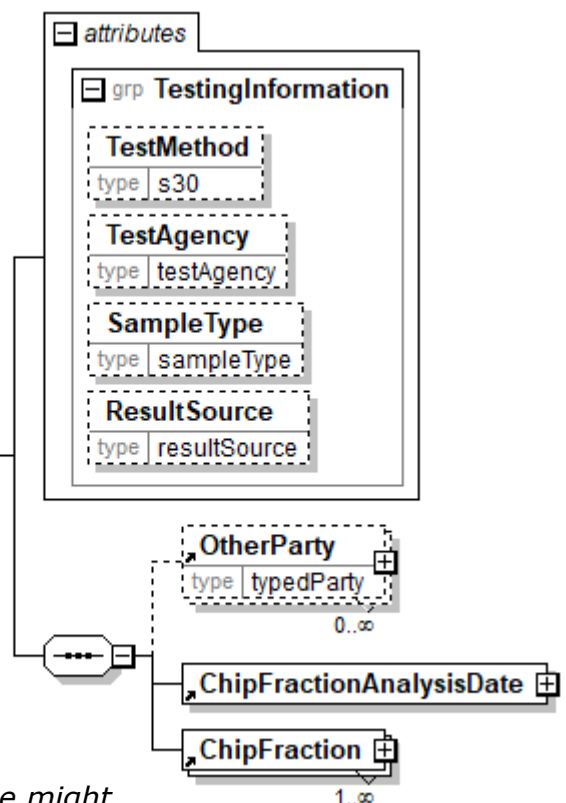
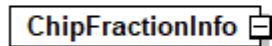

characteristics.

Refer to SampleType definition for any enumerations.

ResultSource [attribute]

ResultSource is optional. A single instance might exist.

Used to define the data source of the specified test

Refer to ResultSource definition for any enumerations.

(sequence)

The sequence of items below is mandatory. A single instance is required.

OtherParty

OtherParty is optional. Multiple instances might exist.

An organisation or business entity other than those specifically detailed within an e-Document

ChipFractionAnalysisDate

ChipFractionAnalysisDate is mandatory. A single instance is required.

The date when the analysis of chip fractions was done.

ChipFraction

ChipFraction is mandatory. Multiple instances might exist.

A grouping element that contains information about one fraction from an analysis of chip fractions.

ChipFractionNumber

The identifier of a chip fraction.

ChipFractionNumber	
type	s30

ChipFractionPropertyType [attribute]

Defines the type of property for analysis of chip fractions.

This item is restricted to the following list.

Length

Length of the chip fraction.

Size

Size of the chip fraction.

Thickness

Thickness of the chip fraction.

Width

Width of the chip fraction.

ChipFractionPropertyType	
type	chipFractionPropertyType

ChipFractionValue

A grouping element for a chip fraction value and its statistical measures.

(sequence)

The sequence of items below is mandatory. A single instance is required.

DetailValue

DetailValue is mandatory. A single instance is required.

A numeric value expressed in the unit of measure (UOM).

DetailRangeMin

DetailRangeMin is optional. A single instance might exist.

The minimum value (lower boundary) allowed for the DetailValue that is the parent of this element.

DetailRangeMax

DetailRangeMax is optional. A single instance might exist.

The maximum value (upper boundary) allowed for the DetailValue that is the parent of this element.

StandardDeviation

StandardDeviation is optional. A single instance might exist.

A statistic used as a measure of dispersion in a distribution.

SampleSize

SampleSize is optional. A single instance might exist.

The number of samples used to determine the product characteristic in question.

TwoSigmaLower

TwoSigmaLower is optional. A single instance might exist.

Two sigma (a measure of dispersion associated with standard deviation) on the lower side of the standard deviation.

TwoSigmaUpper

TwoSigmaUpper is optional. A single instance might exist.

Two sigma (a measure of dispersion associated with standard deviation) on the upper side of the standard deviation.

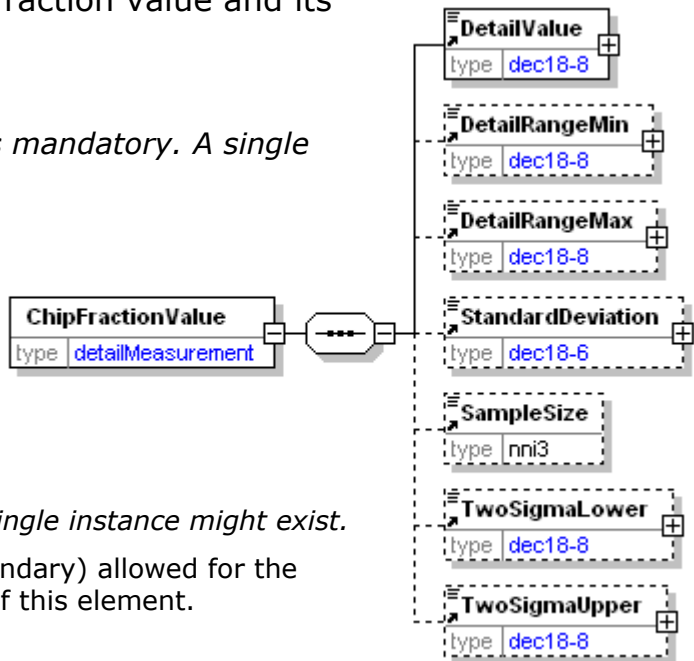

ChipPackagingCharacteristics

ChipPackagingCharacteristics provides information about the containerisation of the wood chips.

(sequence)

The sequence of items below is mandatory. A single instance is required.

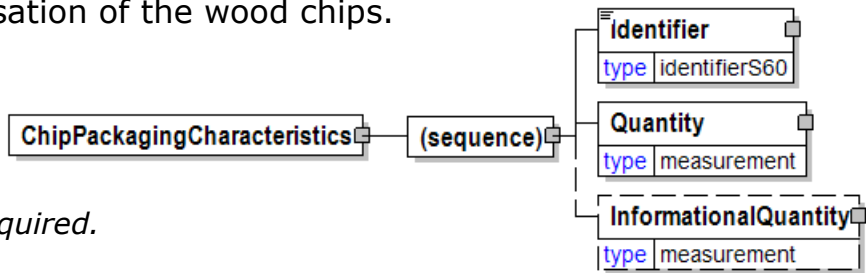

Identifier

Identifier is mandatory. A single instance is required.

An Identifier is required for packages and items (pallets, reel packages, boxes, ream items, reel items, etc). The Identifier element contains the actual item identifier code. Identifier is repeatable so more than one identifier can be communicated. For example, the printed identifier on a label may be different from the barcode printed on the label.

Quantity

Quantity is mandatory. A single instance is required.

The Quantity element contains attributes that provide information about the type of quantity that is being communicated, the context in which the particular quantity is to be viewed, and (if the quantity represents an adjustment) an adjustment type.

The Quantity element contains three child elements that enable you to communicate a range of values for the quantity and a target or actual value. It is at this level (Value, RangeMin, and RangeMax) that the unit of measure is specified. This permits the range to be specified in a different unit of measure than the target.

InformationalQuantity

InformationalQuantity is optional. A single instance might exist.

A quantity given in a valid UOM used for information purposes only (not for calculation). For example, an ordered quantity was 100 reels as opposed to the invoice quantity of 20,000 pounds.

City

Name of the city associated with the address elements.

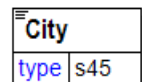

ClassCodeInfo

A group item specifying code and description for a class.

Agency [attribute]

Agency is mandatory. A single instance is required.

Describes the agency maintaining the list of codes. To be included in this list the agency must be a recognized standards body or industry organisation.

- For the element that owns this attribute.
- For another attribute in the list of attributes associated with the parent element.

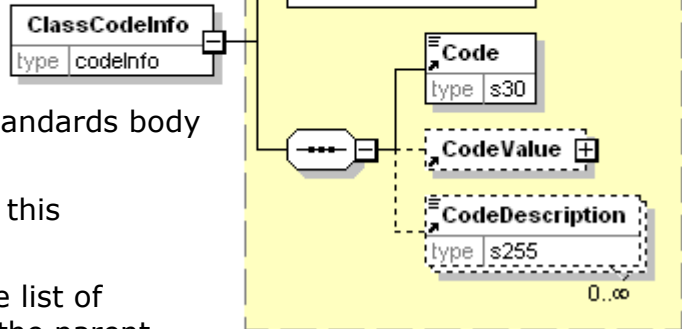

Refer to Agency definition for any enumerations.

(sequence)

The sequence of items below is mandatory. A single instance is required.

Code

Code is mandatory. A single instance is required.

Specifies a code that is defined by an agency. The agency is given for the whole construct containing the code.

CodeValue

CodeValue is optional. A single instance might exist.

A grouping element specifying a value belonging to a code that is defined by an agency.

CodeDescription

CodeDescription is optional. Multiple instances might exist.

A textual description for the meaning of a code that is defined by an agency. When the Code is associated with a CodeValue of type TextValue, then the CodeDescription is a textual description of both the Code and the TextValue.

ClassIdentifier

Standard used for product identification.

IdentifierCodeType [attribute]

IdentifierCodeType is mandatory. A single instance is required.

Defines the type of product identifier used (for example, reel number, ream number, bar code). This code type specifies how to decode the

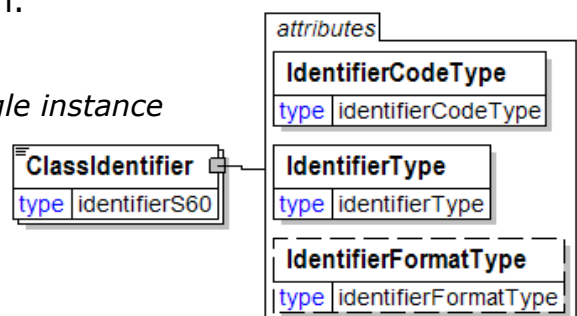

identifier value.

Refer to IdentifierCodeType definition for any enumerations.

IdentifierType [attribute]

IdentifierType is mandatory. A single instance is required.

This attribute specifies whether the Identifier is the primary way to identify the product or a secondary way. Only one of the given identifiers can be primary. In addition, this attribute also specifies the physical support used to code the identifier (for example, a Radio Frequency (RF) Tag).

Refer to IdentifierType definition for any enumerations.

IdentifierFormatType [attribute]

IdentifierFormatType is optional. A single instance might exist.

IdentifierFormatType defines the technical format used to make an IdentifierCodeType readable by technical devices or humans. The IdentifierCodeType specifies how to decode the identifier value

Refer to IdentifierFormatType definition for any enumerations.

Classification

A group item that details the product classification according to a particular organization's scheme.

An item across multiple classifications would still be

recognized as the same item. Examples of some product classifications are: Containerboard, Pulp-Dissolving, or Newsprint.

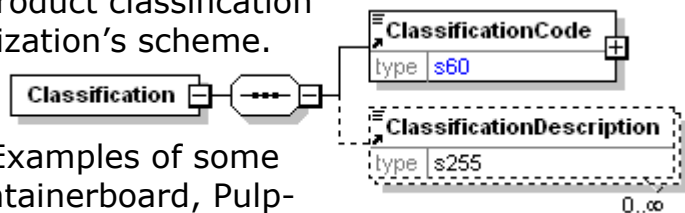

(sequence)

The sequence of items below is mandatory. A single instance is required.

ClassificationCode

ClassificationCode is mandatory. A single instance is required.

A code assigned by the indicated Agency for this particular class of product.

ClassificationDescription

ClassificationDescription is optional. Multiple instances might exist.

A free form description of the classification.

ClassificationCode

A code assigned by the indicated Agency for this particular class of product.

Agency [attribute]

Agency is mandatory. A single instance is required.

Describes the agency maintaining the list of codes. To be included in this list the agency must be a

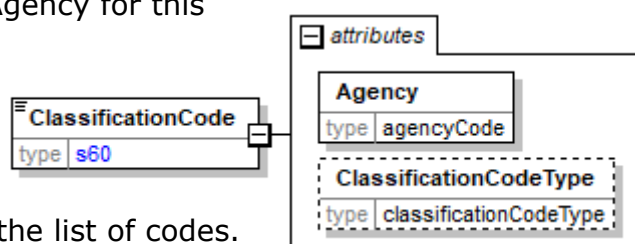

recognized standards body or industry organisation.

- For the element that owns this attribute.
- For another attribute in the list of attributes associated with the parent element.

Refer to Agency definition for any enumerations.

ClassificationCodeType [attribute]

ClassificationCodeType is optional. A single instance might exist.

Provides a contextual definition to the classification code value.

ClassificationCodeType [attribute]

Provides a contextual definition to the classification code value.

This item is restricted to the following list.



BrandName

A specific product brand for which the owner or the source is specified in the Agency attribute.

CASNumber

Chemical Abstracts Service (CAS) numbers are universally used to provide a unique, unmistakable identifier for chemical substances. A CAS number itself has no inherent chemical significance but provides an unambiguous way to identify a chemical substance or molecular structure when there are many possible systematic, generic, proprietary or trivial names. CAS numbers are created and maintained by American Chemical Society. (<http://www.cas.org>)

CatalogueNumber

A unique reference for a product in a catalogue. The owner or the source is specified in the Agency attribute.

CustomsTariffNumber

EAN8

To be deprecated in a future version V3R00. GS1 has renamed it to GTIN-8. Use GTIN8 instead.

EAN13

To be deprecated in a future version V3R00. GS1 has renamed it to GTIN-13. Use GTIN13 instead.

ExportHarmonisedSystemCode

The Harmonised System Code is an international goods classification system developed by the Customs Co-operation Council.

USA: It is a 10-digit number, the first 6 of which compose the harmonised code. The remaining 4 digits represent statistical subdivisions. The schedule is a statistical classification of domestic and foreign commodities exported from the United States.

Canada: Canadians have adopted the scheme as a basis for a new Canadian

papiNet V2R31

Tariff and Statistical Classification System. The Canadian export number consists of 8 digits prefixed by "HS" and is shown in the format HS5911.31.10, for example.

EWCNumber

The European Waste Catalogue (EWC) is a hierarchical list of waste codes established by decision (2014/955/EU) of the EU Commission. The different types of waste are fully defined by a six-digit code listed in 3 groups of 2 digits, e.g. 03 01 01 and 03 01 04*. Waste codes are communicated in papiNet as a six-digit code without spaces and ending asterisk (*), e.g. 030101 and 030104.

In EU, anyone who runs a business of recycling or disposal requiring environmental permits or operating a heating plant that is using waste as fuel must take cognizance of the wastes category that is described in the EWC list.

<https://eur-lex.europa.eu/eli/dec/2014/955/oj>

FinishedGoodIdentifier

Product Identifier assigned by an Agency, e.g. a Publisher, to identify the finished product.

GradeCode

A specific product code for which the owner or the source is specified in the Agency attribute

GradeName

A specific product name for which the owner or the source is specified in the Agency attribute (for example, ImprovedNewsprint-45-1479).

GTIN8

An 8 digit identifier GTIN-8 defined by GS1 for trade items, Earlier referred to as European Article Number EAN-8. GTIN-8s will be encoded in an EAN-8 bar code. See also GTIN14 for more information. <http://www.gs1.org/>

GTIN12

A 12 digit identifier GTIN-12 defined by GS1 for trade items, Earlier referred to as Universal Product Code. GTIN-12s can be encoded in UPC-A, UPC-E, ITF-14, or GS1-128 bar codes. GTIN-12 is primarily used in North America. See also GTIN14 for more information. <http://www.gs1us.org/>

GTIN13

A 13 digit identifier GTIN-13 defined by GS1 for trade items, Earlier referred to as European Article Number EAN-13. GTIN-13s can be encoded in EAN-13, ITF-14 or GS1-128 bar codes. See also GTIN14 for more information. <http://www.gs1.org/>

GTIN14

A 14 digit Global Trade Item Number (GTIN) defined by GS1. It is one of the main building blocks of the GS1 System and is used to uniquely identify trade items, which are products and services that are priced, ordered or invoiced at any point in the supply chain.

GTINs can be 8, 12, 13, or 14 digits in length. GS1 recommends that every GTIN be represented in software applications as 14 digits by right justifying

papiNet V2R31

and zero filling left, as appropriate. The following table demonstrates the structure of GTINs in a GTIN-compliant database

Type of GTIN	GTIN Digit													
	1	2	3	4	5	6	7	8	9	10	11	12	13	14
GTIN-8	0	0	0	0	0	0	N	N	N	N	N	N	N	C
GTIN-12	0	0	N	N	N	N	N	N	N	N	N	N	N	C
GTIN-13	0	N	N	N	N	N	N	N	N	N	N	N	N	C
GTIN-14	N	N	N	N	N	N	N	N	N	N	N	N	N	C

<http://www.gs1.org/>

ImportHarmonisedSystemCode

The Harmonised System Code is an international goods classification system developed by the Customs Co-operation Council.

USA: It is a 10-digit number, the first 6 of which compose the harmonised code. The remaining 4 digits represent statistical subdivisions. The schedule is a statistical classification of domestic and foreign commodities exported from the United States.

Canada: Canadians have adopted the scheme as a basis for a new Canadian Tariff and Statistical Classification System. The Canadian export number consists of 8 digits prefixed by "HS" and is shown in the format HS5911.31.10, for example.

ManufacturingGradeCode

A specific grade code to the actual manufactured product which may be different to the grade code under which the product is sold. These codes generally refer to a product manufactured on a pulp or paper machine. The owner or the source is specified in the Agency attribute.

ManufacturingGradeName

A specific grade name assigned to the actual manufactured product which may be different to the grade name under which the product is sold. These codes generally refer to a product manufactured on a pulp or paper machine. The owner or the source is specified in the Agency attribute.

Ondule

A product code issued by the Groupement Ondulé, which is the European Association of Corrugated Base Papers Manufacturers.

PartNumber

An equivalent to the Stock Keeping Unit (SKU) for which the owner or the source is specified in the Agency attribute. In other words, this code fully defines the product.

RFQPartNumber

The part number communicated as part of the RFQ process. This may be a form of the RFQ number itself. This field is designed to handle the situation where there is no part number assigned to the particular blend of product characteristics. The owner or the source is specified in the Agency attribute.

papiNet V2R31

SKU

The Stock Keeping Unit that is assigned by the buyer or supplier and that includes all relevant information to make an individual item ready for shipping. The owner or the source is specified in the Agency attribute.

UPC

To be deprecated in a future version V3R00. GS1 US has defined the UPC code to be a Global Trade Item Number GTIN-12. Use GTIN12 instead. See also IdentifierFormatType UPC_A for more information. <http://www.gs1us.org/>

Other

Used for any other product identifier type that is not covered by the list.

ClassificationDescription

A free form description of the classification.

ClassificationDescription	
type	s255

ClothCrossCut [attribute]

Either "Yes" or "No".

This item is restricted to the following list.

Yes

No

attribute	
ClothCrossCut	
type	yesNo

CMYK

A definition of colour using the CMYK protocol.

TestMethod [attribute]

TestMethod is optional. A single instance might exist.

The method used to determine the results of the test under consideration.

TestAgency [attribute]

TestAgency is optional. A single instance might exist.

The agency that has set the parameters for the testing

Refer to TestAgency definition for any enumerations.

SampleType [attribute]

SampleType is optional. A single instance might exist.

Communicates how sampling was done to measure the product characteristics.

Refer to SampleType definition for any enumerations.

ResultSource [attribute]

ResultSource is optional. A single instance might exist.

Used to define the data source of the specified test

Refer to ResultSource definition for any enumerations.

(sequence)

The sequence of items below is mandatory. A single instance is required.

Cyan

Cyan is mandatory. A single instance is required.

The Cyan component of a colour in the CMYK approach to colour definition.

Magenta

Magenta is mandatory. A single instance is required.

The Magenta component of a colour.

Magenta is a locally defined element used in the CMYK element.

Yellow

Yellow is mandatory. A single instance is required.

The Yellow component of a colour.

Black

Black is mandatory. A single instance is required.

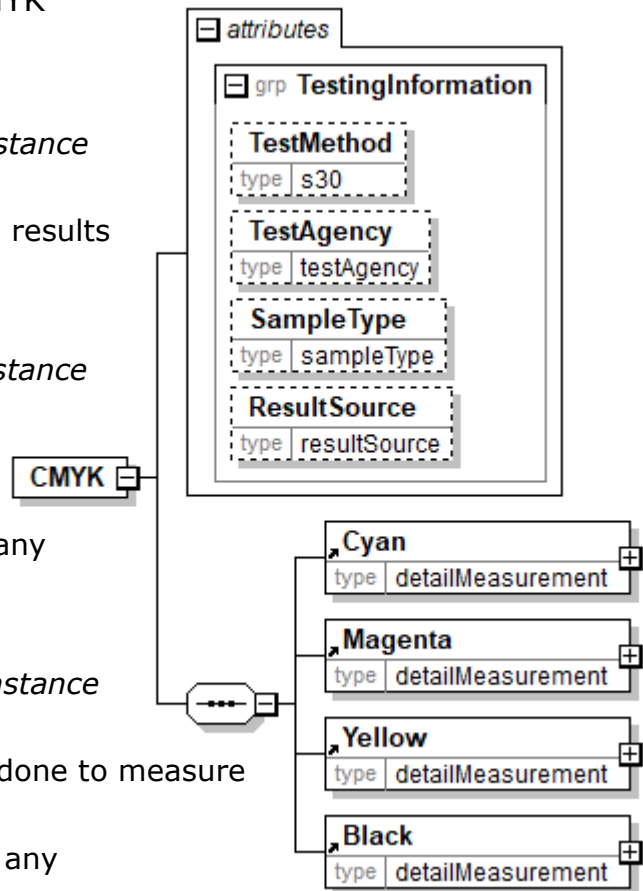

The Black component of a colour.

Coating

Coating

This item is restricted to the following list.

AnimalGlueableStampableFilm

Aqueous

Aqueous coating is a water-based sealant.

Diamond

Hard carbon coating.

DiamondUV

Duracoat

Process of applying varnish-like coating over lamination to give a multi-layer visual effect.

Film

A thin sheet of material, usually plastic and transparent.

FX

Application of ultraviolet processing to simulate embossing.

GlossUltracure

GlossUV

Gritty

GrittyMatteUV

Lacquer

Clear or coloured varnish that dries by solvent evaporation and often a curing process as well that produces a hard, durable finish, in any sheen level from ultra matte to high gloss and that can be further polished as required.

Laminate

MatteUV

MylarFilm

A thin polyester film.

MylarFilmGloss

MylarFilmMatte

MylarFilmSilver

NoFinish

Non-Standard

PHOENIXPremier

PolyesterFilm

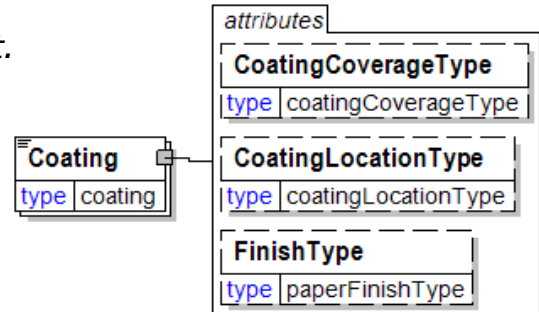

papiNet V2R31

Made of synthetic resins which are light and strong and weather resistant.

PolyesterGloss

PolyesterMatte

PolypropyleneFilm

PolypropyleneFilmGloss

PolypropyleneFilmMatte

Press

Applied by a unit of the press.

PressVarnish

PressVarnishDull

PressUV

SatinFilm

Silkscreen

A print made by forcing ink through a fine (silk) mesh.

SilkscreenGloss

SilkscreenUV

StayFlat

Contains materials to prohibit the sheet from curling.

StayFlatFilmGloss

StayFlatFilmMatte

Tint

Screening or adding white to a solid color for results of lightening that specific color.

TintVarnish

Ultracure

Ultraviolet

Ultra-violet coating is a highly reactive, cross-linking system in which the vehicle is dried by exposure to UV radiation.

Varnish

Petroleum-based sealant applied by a standard inking unit in the press.

CoatingCoverageType [attribute]

CoatingCoverageType is optional. A single instance might exist.

Communicates the degree of coating coverage.

Refer to CoatingCoverageType definition for any enumerations.

CoatingLocationType [attribute]

CoatingLocationType is optional. A single instance might exist.

Specifies which side of the product the coating should be applied.

Refer to CoatingLocationType definition for any enumerations.

FinishType [attribute]

FinishType is optional. A single instance might exist.

Defines the finish of a sheet of paper, which means the condition of its surface (refer to Embossing for more information).

Finishes may be produced on or off machine. Finishes that are created off-machine are called embossed. (Embossing is a child element of ReelConversionCharacteristics and SheetConversionCharacteristics.)

Note:

Embossed" as a finish type is just a generalized choice for one of the more specific choices listed.

Unsupercalendered" as a finish type would be indicated by not communicating a finish type.

Refer to FinishType definition for any enumerations.

CoatingBottom [attribute]

Used to specify the type of coating applied to the top or bottom of the paper sheet

This item is restricted to the following list.

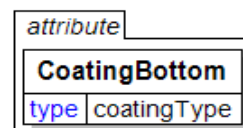

Acrylic

Flexolyn

FoilCoated

GreaseBarrier

Metallic

MetalizedPolyester

MoistureBarrier

MoldInhibitor

None

OilBarrier

OxygenBarrier

Plastic

PolyCoating

Polyethylene

Pyroxylin

Silicone

CoatingCoverageType [attribute]

Communicates the degree of coating coverage.

This item is restricted to the following list.

FullCoverage

The entire item is coated.

SpotCoverage

The item is partially coated.



CoatingLocation [attribute]

Coating location

This item is restricted to the following list.

Back

Top ply of a multi-part business form. Its upper surface is not coated. Its lower surface has a coating of microscopic capsules containing colourless dye. When pressure or impact fractures the capsules, the dye is released to react with the sheet of carbonless paper below it having a coated front top surface. The image is formed on the coated front surface.

Front

The coated front sheet is used as the bottom ply of a multi-part form. The coated front sheet can receive the image from the coated back surface of the sheet above it, but it does not transmit the image nor is there a sheet below it in the form.

FrontAndBack

The coated front and back sheet is used for all plies of a carbonless form between the top and bottom plies. The under-surface of each coated front and back sheet is coated with dye capsules (coated back coating). The upper surface (coated front) reacts with the colourless dye released from fractured capsules to produce the image.

SelfContained

Carbonless paper containing both the coated back dye capsules and the coated front receptor coating on the upper surface of the same sheet, Self-contained carbonless paper can be used to create a carbonless copy when used as a second ply below almost any kind of paper.

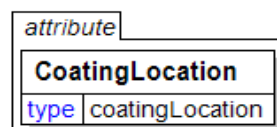

CoatingLocationType [attribute]

Specifies which side of the product the coating should be applied.

This item is restricted to the following list.

Top

Top side of a printed component

Bottom



Bottom side of a printed component

TopAndBottom

Front

Front side of a book

Back

Back of a book

FrontAndBack

Spine

Spine of a book which is where the pages are glued or sewn together

FrontAndSpine

BackAndSpine

FrontAndBackAndSpine

CoatingTop [attribute]

Used to specify the type of coating applied to the top or bottom of the paper sheet

This item is restricted to the following list.

attribute	
CoatingTop	
type	coatingType

Acrylic

Flexolyn

FoilCoated

GreaseBarrier

Metallic

MetalizedPolyester

MoistureBarrier

MoldInhibitor

None

OilBarrier

OxygenBarrier

Plastic

PolyCoating

Polyethylene

Pyroxylin

Silicone

CoatWeight

A group item used to communicate the coating thickness target or test value according to a particular TestMethod.

TestMethod [attribute]

TestMethod is optional. A single instance might exist.

The method used to determine the results of the test under consideration.

TestAgency [attribute]

TestAgency is optional. A single instance might exist.

The agency that has set the parameters for the testing

Refer to TestAgency definition for any enumerations.

SampleType [attribute]

SampleType is optional. A single instance might exist.

Communicates how sampling was done to measure the product characteristics.

Refer to SampleType definition for any enumerations.

ResultSource [attribute]

ResultSource is optional. A single instance might exist.

Used to define the data source of the specified test

Refer to ResultSource definition for any enumerations.

(sequence)

The sequence of items below is mandatory. A single instance is required.

DetailValue

DetailValue is mandatory. A single instance is required.

A numeric value expressed in the unit of measure (UOM).

DetailRangeMin

DetailRangeMin is optional. A single instance might exist.

The minimum value (lower boundary) allowed for the DetailValue that is the parent of this element.

DetailRangeMax

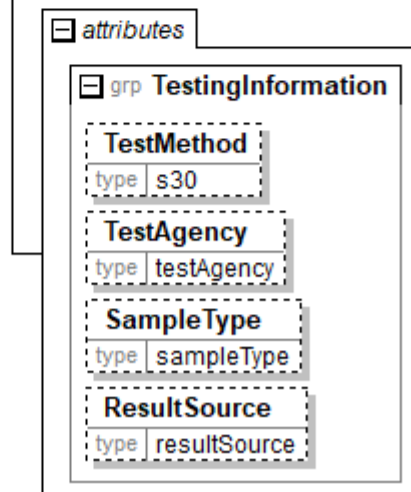
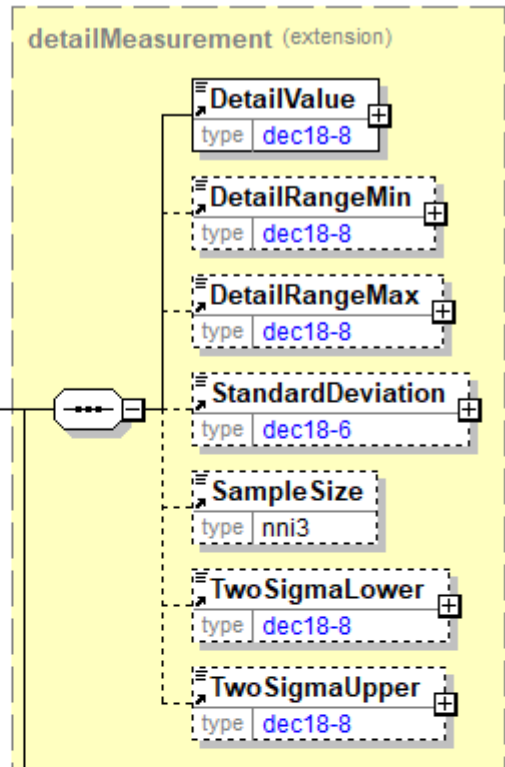

papiNet V2R31

DetailRangeMax is optional. A single instance might exist.

The maximum value (upper boundary) allowed for the DetailValue that is the parent of this element.

StandardDeviation

StandardDeviation is optional. A single instance might exist.

A statistic used as a measure of dispersion in a distribution.

SampleSize

SampleSize is optional. A single instance might exist.

The number of samples used to determine the product characteristic in question.

TwoSigmaLower

TwoSigmaLower is optional. A single instance might exist.

Two sigma (a measure of dispersion associated with standard deviation) on the lower side of the standard deviation.

TwoSigmaUpper

TwoSigmaUpper is optional. A single instance might exist.

Two sigma (a measure of dispersion associated with standard deviation) on the upper side of the standard deviation.

CoatingWithAdditionalSpecs

A grouping element that specifies coating and additional related items.

(sequence)

The sequence of items below is mandatory. A single instance is required.

Coating

*Coating is mandatory.
A single instance is required.*

Coating

Refer to Coating definition for any enumerations.

ColourCode

ColourCode is optional. A single instance might exist.

A code indicating the colour.

ColourDescription

ColourDescription is optional. A single instance might exist.

A free form description of the colour.

FinishTexture

FinishTexture is optional. A single instance might exist.

Describes the texture of the finish to be achieved such as Leatherette.

AdditionalText

AdditionalText is optional. Multiple instances might exist.

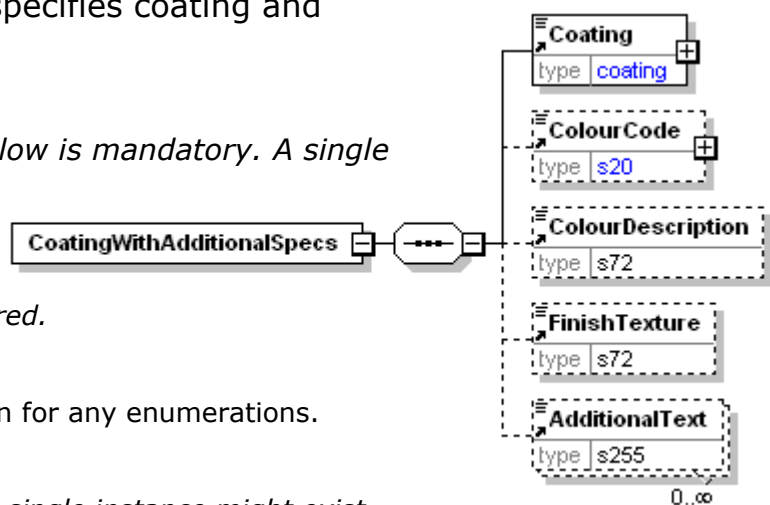

papiNet V2R31

A text field that is used to communicate information not previously defined or for special instructions. To be used only for circumstances not covered by specific elements.

Code

Specifies a code that is defined by an agency. The agency is given for the whole construct containing the code.



CodeDescription

A textual description for the meaning of a code that is defined by an agency. When the Code is associated with a CodeValue of type TextValue, then the CodeDescription is a textual description of both the Code and the TextValue.

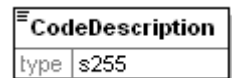

CodeValue

A grouping element specifying a value belonging to a code that is defined by an agency.

(choice)

[choice] is mandatory. A single instance is required.

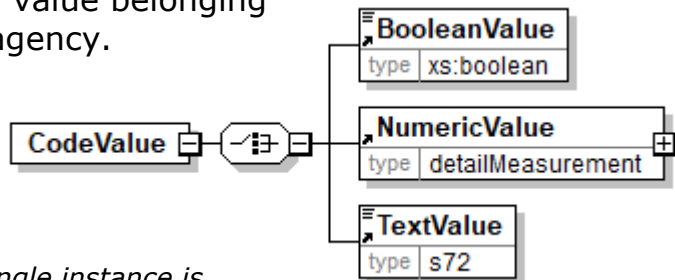

BooleanValue

BooleanValue is mandatory. A single instance is required.

A value in boolean format.

NumericValue

NumericValue is mandatory. A single instance is required.

A grouping element for a numeric value and its statistical measures.

TextValue

TextValue is mandatory. A single instance is required.

A value in text format.

Collated [attribute]

Either "Yes" or "No".

This item is restricted to the following list.

Yes

No

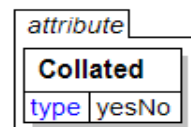

CoLoading

A group item specifying information about items to be loaded or loaded on the same transport unit.

Used to identify:

Delivery together to the drop point

Transport Orders stuffed together in a container

Transport Orders not splittable

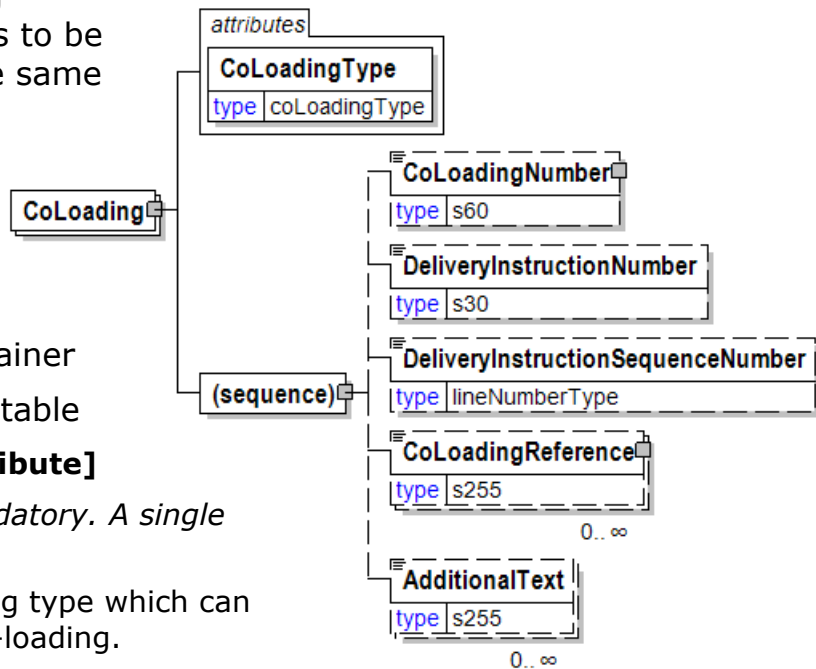

CoLoadingType [attribute]

CoLoadingType is mandatory. A single instance is required.

Provides the Co-Loading type which can control and confirm co-loading.

Refer to CoLoadingType definition for any enumerations.

(sequence)

The sequence of items below is mandatory. A single instance is required.

CoLoadingNumber

CoLoadingNumber is optional. A single instance might exist.

The identifier for the CoLoading communication.

DeliveryInstructionNumber

DeliveryInstructionNumber is optional. A single instance might exist.

The unique identifier for the DeliveryInstruction.

DeliveryInstructionSequenceNumber

DeliveryInstructionSequenceNumber is optional. A single instance might exist.

A sequential number that uniquely identifies the Sequence of a DeliveryInstruction.

CoLoadingReference

CoLoadingReference is optional. Multiple instances might exist.

An element item detailing relevant references pertaining to the coloding process.

AdditionalText

AdditionalText is optional. Multiple instances might exist.

A text field that is used to communicate information not previously defined or for special instructions. To be used only for circumstances not covered by specific elements.

CoLoadingNumber

The identifier for the CoLoading communication.

AssignedBy [attribute]

AssignedBy is mandatory. A single instance is required.

Identifies the type of party or the agency that has assigned the associated item, e.g. a reference of type OrderNumber.

Refer to AssignedBy definition for any enumerations.

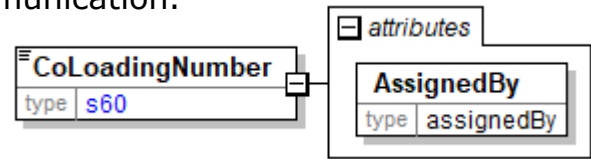

CoLoadingReference

An element item detailing relevant references pertaining to the coloding process.

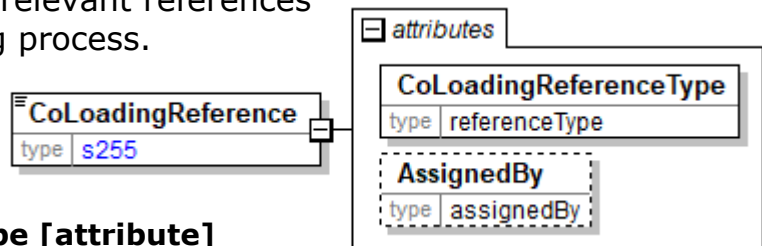

CoLoadingReferenceType [attribute]

CoLoadingReferenceType is mandatory. A single instance is required.

CoLoadingReferenceType provides a contextual explanation of the specific reference identifier. Many items are currently prefixed by "Buyer", "Customer", "Seller", and/or "Supplier". Check for an existing non-prefixed version and use the non-prefixed version instead. In the (yet to be announced release date) version 3.0 the prefixed versions will be removed. Instead the attribute @AssignedBy will communicate the information previously communicated in the prefix.

Refer to CoLoadingReferenceType definition for any enumerations.

AssignedBy [attribute]

AssignedBy is optional. A single instance might exist.

Identifies the type of party or the agency that has assigned the associated item, e.g. a reference of type OrderNumber.

Refer to AssignedBy for any enumerations

CoLoadingReferenceType [attribute]

CoLoadingReferenceType provides a contextual explanation of the specific reference identifier.

Many items are currently prefixed by "Buyer", "Customer", "Seller", and/or "Supplier". Check for an existing non-prefixed version and use the non-prefixed version instead. In the (yet to be announced release date)

version 3.0 the prefixed versions will be removed. Instead the attribute @AssignedBy will communicate the information previously communicated in the prefix.

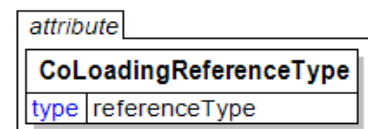

Refer to the [referenceType](#) entry for the list of enumerations and their definitions.

CoLoadingType [attribute]

Provides the Co-Loading type which can control and confirm co-loading.

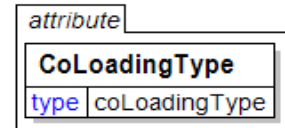

This item is restricted to the following list.

CoLoaded

The delivery is co-loaded with other goods on the same transport unit.

Requested

CoLoading is requested and should be executed if possible.

Required

CoLoading is required and should always be executed.

ColourCode

A code indicating the colour.

Agency [attribute]

Agency is optional. A single instance might exist.

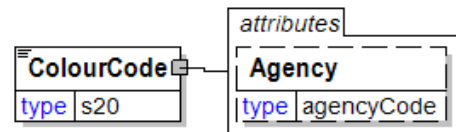

Describes the agency maintaining the list of codes. To be included in this list the agency must be a recognized standards body or industry organisation.

- For the element that owns this attribute.
- For another attribute in the list of attributes associated with the parent element.

Refer to Agency definition for any enumerations.

ColourDescription

A free form description of the colour.

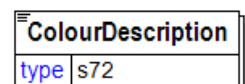

ColourDetail

A group item used to communicate details of colour according to the selected colour definition scheme.

(sequence)

The sequence of items below is mandatory. A single instance is required.

(choice)

[choice] is mandatory. A single instance is required.

CMYK

CMYK is mandatory. A single instance is required.

A definition of colour using the CMYK protocol.

ColourShade

ColourShade is mandatory. A single instance is required.

The colour shade as defined by the indicated Agency.

HSB

HSB is mandatory. A single instance is required.

A definition of colour using the HSB protocol.

All the components of the definition are required. The structure of Hue, Saturation, and Brilliance follows DetailMeasurement.

Lab

Lab is mandatory. A single instance is required.

A definition of colour using the L*a*b protocol.

L*a*b colour consists of a luminance or lightness component (L) and two chromatic components: a component (from green to red) and the b component (from blue to yellow). All the components of the definition are required. The structure of Luminance, "a", and "b" follows DetailMeasurement.

RGB

RGB is mandatory. A single instance is required.

A definition of colour using the RGB protocol.

ColourDescription

ColourDescription is optional. Multiple instances might exist.

A free form description of the colour.

ColourCode

ColourCode is optional. A single instance might exist.

A code indicating the colour.

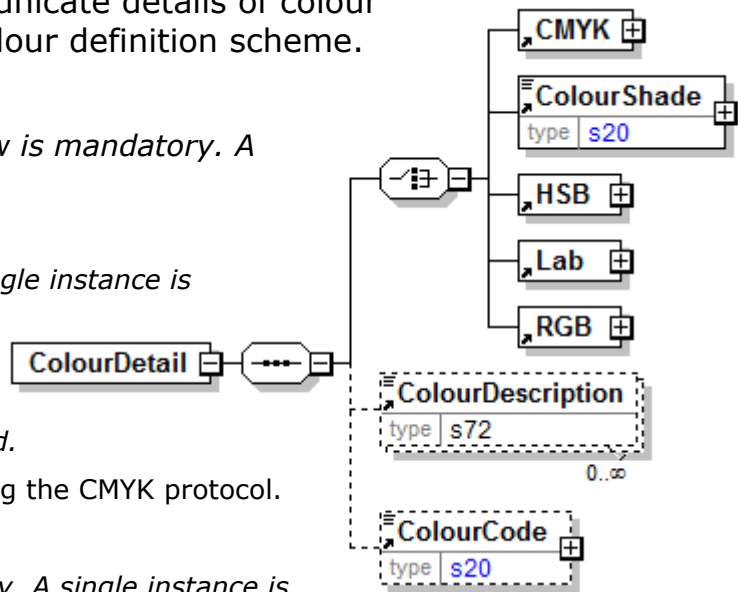

ColourLocation [attribute]

This item is restricted to the following list.

attribute	
ColourLocation	
type	colourLocation

Front

Back

Page1

Page1 is defined to be the front-outside of a 4 page component such as a cover or a endsheet.

Page2

Page2 is defined to be the front--i Inside of a 4 page component such as a cover or a endsheet.

Page3

Page3 is defined to be the back-inside of a 4 page component such as a cover or a endsheet.

Page4

Page4 is defined to be the back-outside of a 4 page component such as a cover or a endsheet.

ColourMatchDescription

Colour match description

ColourMatchDescription	
type	s72

ColourShade

The colour shade as defined by the indicated Agency.

Agency [attribute]

Agency is mandatory. A single instance is required.

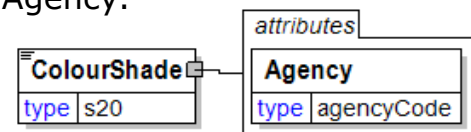

Describes the agency maintaining the list of codes. To be included in this list the agency must be a recognized standards body or industry organisation.

- For the element that owns this attribute.
- For another attribute in the list of attributes associated with the parent element.

Refer to Agency definition for any enumerations.

ColourSpecs

Colour specs

ColourLocation [attribute]

ColourLocation is optional. A single instance might exist.

Refer to ColourLocation definition for any enumerations.

(sequence)

The sequence of items below is optional. Multiple instances might exist.

ColourCode

ColourCode is optional. A single instance might exist.

A code indicating the colour.

ColourDescription

ColourDescription is mandatory. A single instance is required.

A free form description of the colour.

NumberOfColours

NumberOfColours is optional. A single instance might exist.

The number of colours.

InkTypeDescription

InkTypeDescription is optional. A single instance might exist.

Ink type description

ColourMatchDescription

ColourMatchDescription is optional. A single instance might exist.

Colour match description

ColourShade

ColourShade is optional. A single instance might exist.

The colour shade as defined by the indicated Agency.

InkCoverage

InkCoverage is optional. A single instance might exist.

Ink coverage

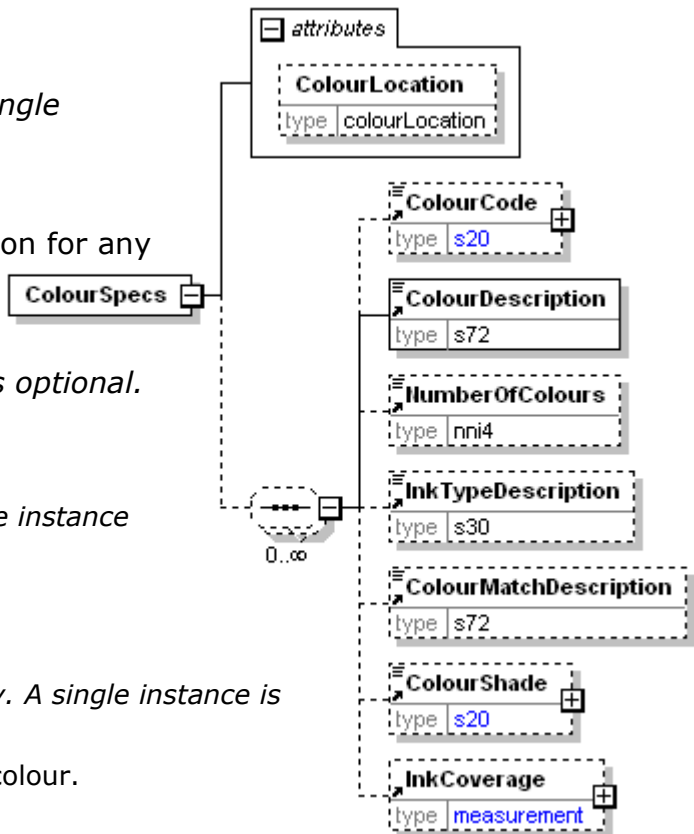

CommodityGoodsCode

A code defining the type of goods handled or traded. The Harmonized Commodity Description and Coding System (HS) of the Customs Cooperation Council

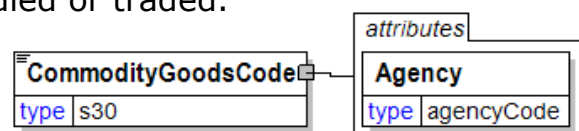

(CCC) is used worldwide as a reference for classifications of external trade statistics and for customs tariffs.

Agency [attribute]

Agency is mandatory. A single instance is required.

Describes the agency maintaining the list of codes. To be included in this list the agency must be a recognized standards body or industry organisation.

- For the element that owns this attribute.
- For another attribute in the list of attributes associated with the parent element.

Refer to Agency definition for any enumerations.

CommonContact

Identifies a specific individual associated with the party.

ContactType [attribute]

ContactType is mandatory. A single instance is required.

Identifies the role of the contact within the party.

Refer to ContactType definition for any

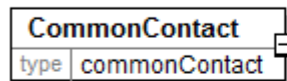

enumerations.

(sequence)

The sequence of items below is mandatory. A single instance is required.

ContactName

ContactName is mandatory. A single instance is required.

The name of the individual associated with the ContactType.

ContactIdentifier

ContactIdentifier is optional. A single instance might exist.

The identifier for the contact.

Telephone

Telephone is optional. A single instance might exist.

The business phone number of the individual associated with the ContactName.

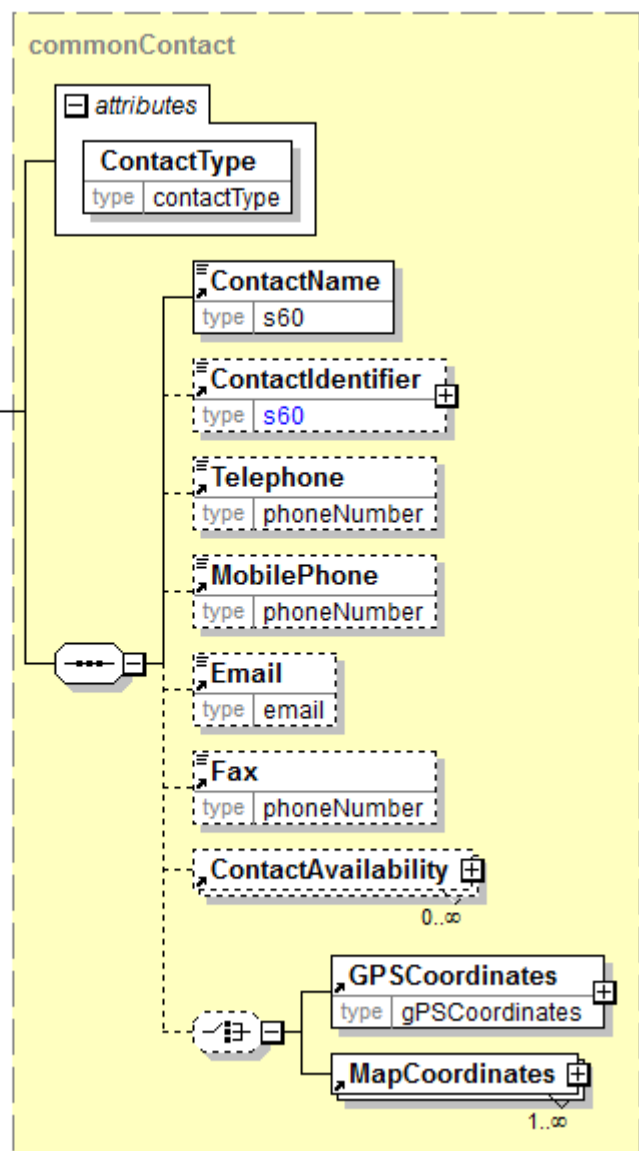

papiNet V2R31

MobilePhone

MobilePhone is optional. A single instance might exist.

The mobile phone number of the individual associated with the ContactName.

Email

Email is optional. A single instance might exist.

The primary business email address of the individual associated with the ContactName.

Fax

Fax is optional. A single instance might exist.

The primary business fax number of the individual associated with the ContactName.

ContactAvailability

ContactAvailability is optional. A multiple instances might exist.

A group element that contains information about the availability of a contact.

(choice)

[choice] is optional. A single instance might exist.

GPSCoordinates

GPSCoordinates is mandatory. A single instance is required.

The location of the party as specified using a Global Positioning System.

This element will be deprecated in a future version V3R00 and should not be used in new implementations. Use instead the MapCoordinates.

MapCoordinates

MapCoordinates is mandatory. One instance is required, multiple instances might exist.

A group item defining and containing position coordinates of a location.

CommunicationRole [attribute]

Provides information about the sender, receiver, and participants to the document communication.

This item is restricted to the following list.

From

The document originates from this party.

To

The document is destined to this party.

CC

This party is copied on the document



CompensationChainDescription

A text describing a compensation chain.

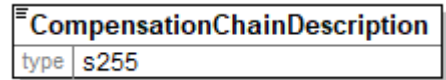

CompensationChainInfo

A group element that contains information about which parties shall have compensation for a delivery of a product to an EndUser when trading of a product in many levels of business. These parties are retrieved by referencing a Business Chain in TradingCompensationChain that contains references to the trading contract for each level of business.

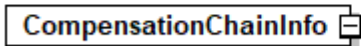

AssignedBy [attribute]

AssignedBy is mandatory. A single instance is required.

Identifies the type of party or the agency that has assigned the associated item, e.g. a reference of type OrderNumber.

Refer to AssignedBy for any enumerations.

ValidityStatus [attribute]

ValidityStatus is mandatory. A single instance is required.

The validity status for a specific item.

Refer to ValidityStatus for any enumerations.

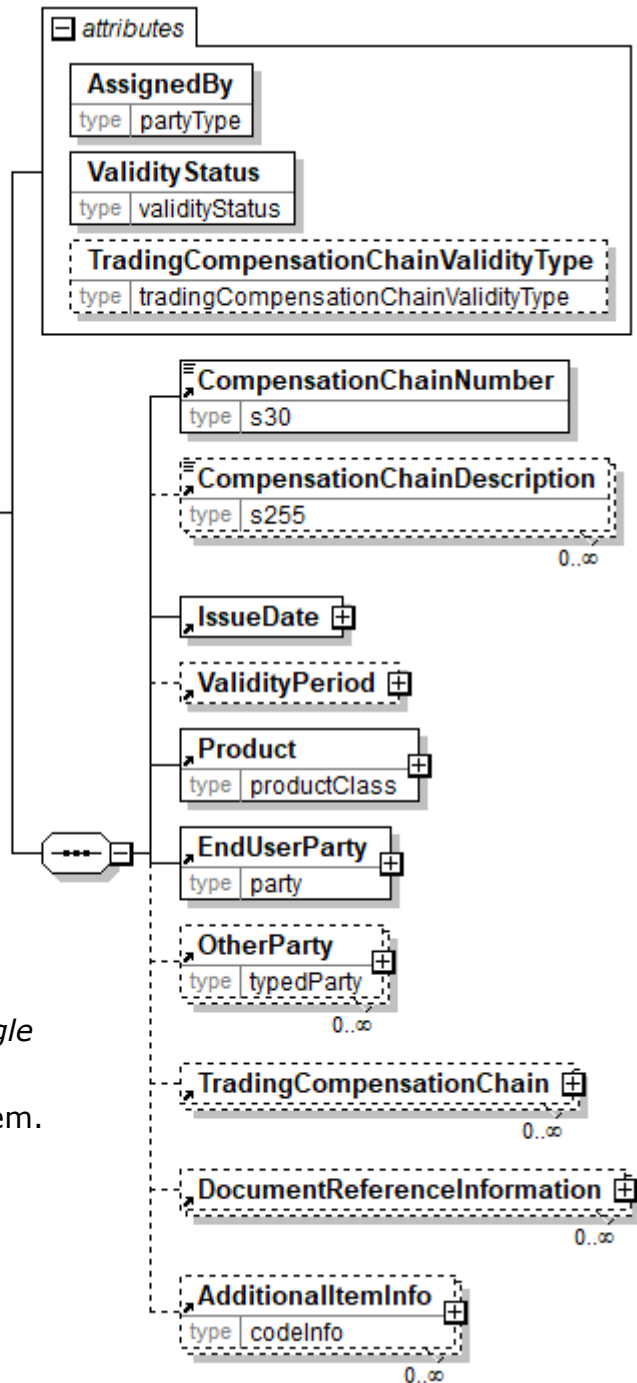

TradingCompensationChainValidityType [attribute]

TradingCompensationChainValidityType is optional. A single instance might exist.

Specifies how validity of trading compensation chains shall be determined.

Refer to TradingCompensationChainValidityType for any enumerations.

(sequence)

The sequence of items below is mandatory. A single instance is required.

CompensationChainNumber

BusinessChainNumber is mandatory. A single instance is required.

The unique identifier of a compensation chain.

CompensationChainDescription

CompensationChainDescription is optional. Multiple instances might exist.

A text describing a compensation chain.

IssueDate

IssueDate is mandatory. A single instance is required.

The date and time when the item was issued.

ValidityPeriod

ValidityPeriod is optional. A single instance might exist.

The validity period for a specific item, e.g. the validity period for an e-Document.

Product

Product is mandatory. A single instance is required.

Product is a group item defining the article and its characteristics. Product is used to specify product characteristics organized by ProductIdentifier, ProductDescription, and Classification. Book Manufacturing, Label Stock, Paper, Pulp, Recovered Paper, Wood Products, and Virgin Fibre market segments have defined their product characteristics and conversion features for implementation in papiNet.

EndUserParty

EndUserParty is optional. Multiple instances might exist.

The party using, consuming, or converting the product. For example, a printer using paper reels for a print job for a publisher. The final ShipTo destination for a product is normally to the end user's facilities.

OtherParty

OtherParty is optional. Multiple instances might exist.

An organisation or business entity other than those specifically detailed within an e-Document.

TradingCompensationChain

TradingCompensationChain is optional. Multiple instances might exist.

A group element that contains information about a business chain that defines how to calculate compensations when trading in many levels of business. The Business Chain contains references to the trading contract for each level of business. A Business Chain is valid to use for calculation of compensations as specified either by a ValidityPeriod or by a ValidityFlag.

DocumentReferenceInformation

DocumentReferenceInformation is optional. Multiple instances might exist.

A group item containing reference information applicable to a document.

AdditionalItemInfo

AdditionalItemInfo is optional. Multiple instances might exist.

A grouping element that contains information about additional items specified by an agency. Restricted use of this element is recommended.

CompensationChainNumber

The unique identifier of a compensation chain.

CompensationChainNumber	
type	s30

CompensationMeasuringType [attribute]

Specifies what kind of measuring is used for financial compensation.

This item is restricted to the following list.

attributes
CompensationMeasuringType
type compensationMeasuringType

ForestHarvester

Measuring is done by forest harvester during harvesting.

IndustrialSite

Measuring is done at the industrial sites.

StandingTree

Measuring of standing trees is done before harvesting.

StorageSite

Measuring is done at the storage sites, e.g. at roadside landings.

TransportWeightScale

Measuring is done by a weight scale mounted on a vehicle or a transport unit. E.g. measuring by a weight scale mounted on a forest forwarder or to transporting vehicle during loading or unloading.

Complaint

The Complaint element is the root element for the Complaint e-Document.

Typically, a Complaint e-Document is sent from the customer or end user to the supplier to communicate information regarding products or services. A response from the supplier is desired and corrective actions, if required. This e-Document must specify the necessary details to enable the supplier to trigger an internal process to verify whether the complaint reason corresponds to the supplier-assessed reason.

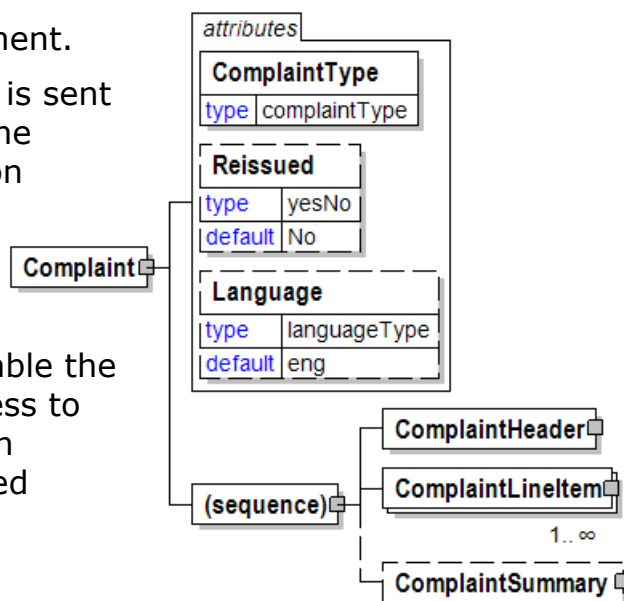

ComplaintType [attribute]

ComplaintType is mandatory. A single instance is required.

Indicates if the e-Document represents a Complaint by the sender or Feedback from the sender.

Refer to ComplaintType definition for any enumerations.

Reissued [attribute]

Reissued is optional. A single instance might exist.

Either "Yes" or "No".

Refer to Reissued definition for any enumerations.

Language [attribute]

Language is optional. A single instance might exist.

The valid Alpha 2- and Alpha 3-character list of language codes in the ISO 639-1 and 639-2 international standards.

Information on the content of this attribute is available at:
https://www.loc.gov/standards/iso639-2/php/code_list.php

(sequence)

The sequence of items below is mandatory. A single instance is required.

ComplaintHeader

ComplaintHeader is mandatory. A single instance is required.

The ComplaintHeader is required and contains information common to the Complaint.

ComplaintLineItem

ComplaintLineItem is mandatory. One instance is required, multiple instances might exist.

The detail information of one of the items on the Complaint.

ComplaintSummary

ComplaintSummary is optional. A single instance might exist.

Summary information that applies to the entire Complaint e-Document.

ComplaintHeader

The ComplaintHeader is required and contains information common to the Complaint.

(sequence)

The sequence of items below is mandatory. A single instance is required.

ComplaintNumber

ComplaintNumber is mandatory. A single instance is required.

A unique identification number of the Complaint, generated by the complainer.

ComplaintIssueDate

ComplaintIssueDate is mandatory. A single instance is required.

The date on which the Complaint was issued by the complainer

ComplaintReference

ComplaintReference is optional. Multiple instances might exist.

A group item detailing relevant references pertaining to the Complaint. ComplaintReference contains the attribute ComplaintReferenceType.

RequestedAction

RequestedAction is optional. A single instance might exist.

The element that enables the party making the complaint (i.e. SenderParty) to specify what they want done regarding the Complaint (send a credit, send disposition instructions, etc.)

SenderParty

SenderParty is optional. A single instance might exist.

The business entity issuing the e-Document, the source of the document.

The entity responsible for the content. If the sender party has out sourced the message service to a third party the SenderParty is the issuer of the e-Document and not the party performing the transmission service of the electronic message.

ReceiverParty

ReceiverParty is optional. Multiple instances might exist.

The business entity for whom the e-Document is intended, the destination of the document.

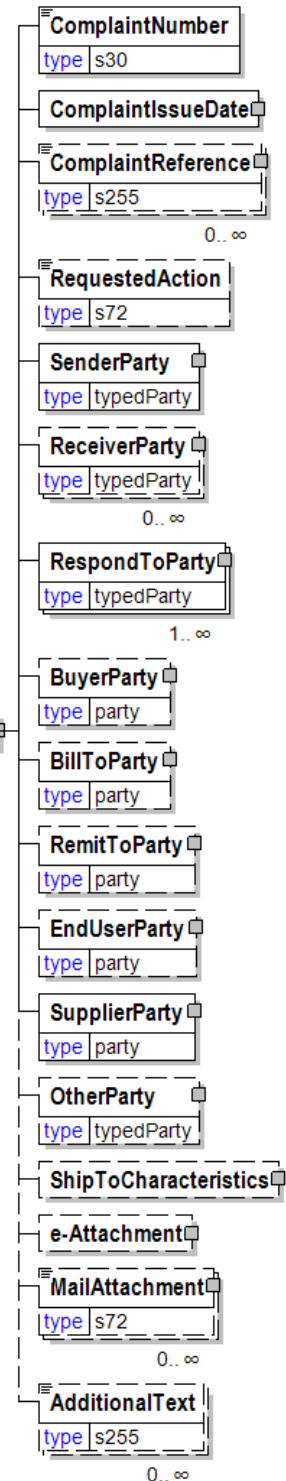
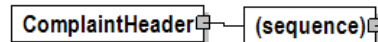

The entity interested in the content. If the receiver party has outsourced the message service to a third party the ReceiverParty is the intended party for the e-Document and not the party performing the receiving service of the electronic message.

RespondToParty

RespondToParty is mandatory. One instance is required, multiple instances might exist.

The party the document should be responded to.

BuyerParty

BuyerParty is optional. A single instance might exist.

The legal entity to which the product is sold. Also commonly referred to as the sold-to party or customer. If no OtherParty is defined as the Payer, the Buyer is the Payer.

BillToParty

BillToParty is optional. A single instance might exist.

The address where the Invoice is to be sent.

RemitToParty

RemitToParty is optional. A single instance might exist.

A group item containing details of the party to whom payment will be made. The RemitToParty contains all information related to remittance.

EndUserParty

EndUserParty is optional. A single instance might exist.

The party using, consuming, or converting the product. For example, a printer using paper reels for a print job for a publisher. The final ShipTo destination for a product is normally to the end user's facilities.

SupplierParty

SupplierParty is mandatory. A single instance is required.

The organisation or business entity responsible for providing the product. SupplierParty is also the seller of the product, if Seller is not specified as OtherParty = Seller.

OtherParty

OtherParty is optional. A single instance might exist.

An organisation or business entity other than those specifically detailed within an e-Document.

ShipToCharacteristics

ShipToCharacteristics is optional. A single instance might exist.

A group item that provides information important for the Ship-To Party.

e-Attachment

e-Attachment is optional. A single instance might exist.

e-Attachment enables the sender to provide information about attachments to the document.

Note: BizTalk users may have problems in processing this element. See the papiNet FAQs (papiNet.org) for more information.

MailAttachment

MailAttachment is optional. Multiple instances might exist.

MailAttachment enables the complainer to indicate that they are providing by mail (express courier, snail mail etc.) proof of the Complaint.

AdditionalText

AdditionalText is optional. Multiple instances might exist.

A text field that is used to communicate information not previously defined or for special instructions. To be used only for circumstances not covered by specific elements.

ComplaintInformation

ComplaintInformation is a grouping element that contains general information about the Complaint.

(sequence)

The sequence of items below is mandatory. A single instance is required.

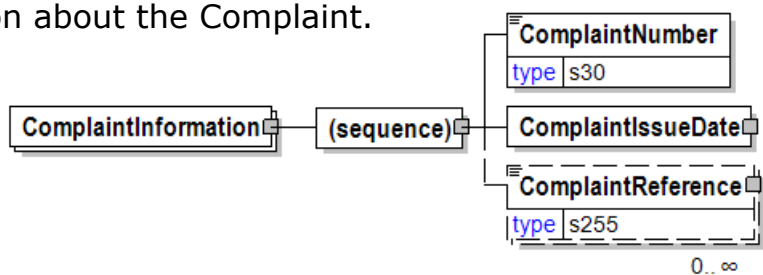

ComplaintNumber

ComplaintNumber is mandatory. A single instance is required.

A unique identification number of the Complaint, generated by the complainer.

ComplaintIssueDate

ComplaintIssueDate is mandatory. A single instance is required.

The date on which the Complaint was issued by the complainer

ComplaintReference

ComplaintReference is optional. Multiple instances might exist.

A group item detailing relevant references pertaining to the Complaint. ComplaintReference contains the attribute ComplaintReferenceType.

ComplaintIssueDate

The date on which the Complaint was issued by the complainer

(sequence)

The sequence of items below is mandatory. A single instance is required.

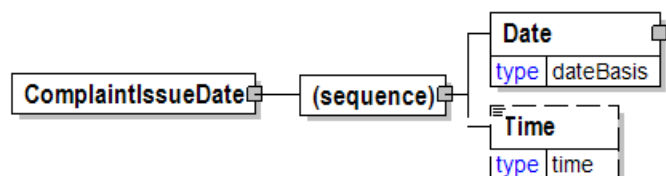

Date

Date is mandatory. A single instance is required.

A group element that contains the specification of Year, Month, and Day.

Time

Time is optional. A single instance might exist.

Times are treated in a standard XML fashion with a special case used to indicate a

generalized "local" time. The standard XML approach to time is hh:mm:ss, hh:mm:ssZ, or hh:mm:ss±hh:mm.

hh:mm:ss±hh:mm is used to represent a time with a time zone. The time zone is communicated as the number of hours offset from the Universal Time Coordinate (UTC), a.k.a. Greenwich Mean Time.

hh:mm:ssZ indicates the time at Zulu (another name for UTC).

hh:mm:ss or hh:mm indicates within papiNet the applicable local time where the associated event is taking place. Caution should be used when processing times of this nature as the papiNet approach may be in discord with other users of XML.

ComplaintLineItem

The detail information of one of the items on the Complaint.

(sequence)

The sequence of items below is mandatory. A single instance is required.

ComplaintLineItemNumber

ComplaintLineItemNumber is mandatory. A single instance is required.

The number used to identify the Complaint line item

ComplaintReason

ComplaintReason is mandatory. A single



instance is required.

A group item containing the reason for the Complaint.

RequestedAction

RequestedAction is optional. A single instance might exist.

The element that enables the party making the complaint (i.e. SenderParty) to specify what they want done regarding the Complaint (send a credit, send disposition instructions, etc.)

ConsumptionProcess

ConsumptionProcess is optional. A single instance might exist.

Identifies the process relevant to the situation being described.

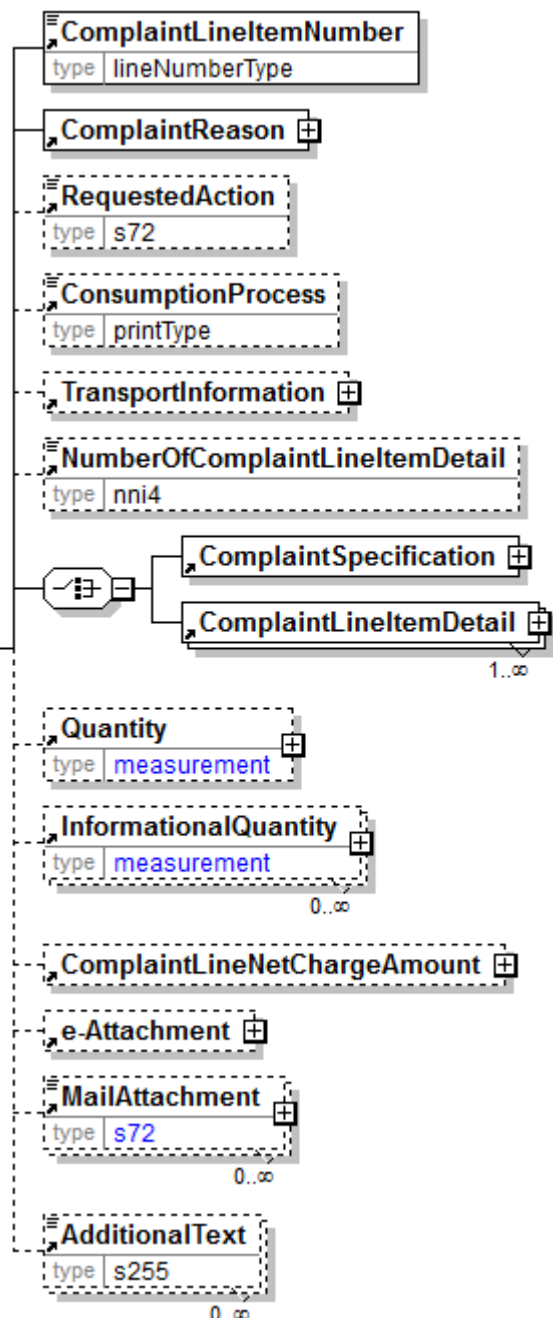

Refer to ConsumptionProcess definition for any enumerations.

TransportInformation

TransportInformation is optional. A single instance might exist.

A grouping element for transport information.

NumberOfComplaintLineItemDetail

NumberOfComplaintLineItemDetail is optional. A single instance might exist.

The number of ComplaintLineItemDetail elements for a given ComplaintLineItem (Example: the number of reels in a ComplaintLineItem)

(choice)

[choice] is mandatory. A single instance is required.

ComplaintSpecification

ComplaintSpecification is mandatory. A single instance is required.

A group item containing information necessary to identify the physical item

ComplaintLineItemDetail

ComplaintLineItemDetail is mandatory. One instance is required, multiple instances might exist.

A group item containing information necessary to identify the type of article being complained (example: pallet, reel etc.)

Quantity

Quantity is optional. A single instance might exist.

The Quantity element contains attributes that provide information about the type of quantity that is being communicated, the context in which the particular quantity is to be viewed, and (if the quantity represents an adjustment) an adjustment type.

The Quantity element contains three child elements that enable you to communicate a range of values for the quantity and a target or actual value. It is at this level (Value, RangeMin, and RangeMax) that the unit of measure is specified. This permits the range to be specified in a different unit of measure than the target.

InformationalQuantity

InformationalQuantity is optional. Multiple instances might exist.

A quantity given in a valid UOM used for information purposes only (not for calculation). For example, an ordered quantity was 100 reels as opposed to the invoice quantity of 20,000 pounds.

ComplaintLineNetChargeAmount

ComplaintLineNetChargeAmount is optional. A single instance might exist.

The total complained amount per line.

e-Attachment

e-Attachment is optional. A single instance might exist.

e-Attachment enables the sender to provide information about attachments to the document.

Note: BizTalk users may have problems in processing this element. See the papiNet FAQs (papiNet.org) for more information.

MailAttachment

MailAttachment is optional. Multiple instances might exist.

MailAttachment enables the complainer to indicate that they are providing by mail (express courier, snail mail etc.) proof of the Complaint.

AdditionalText

AdditionalText is optional. Multiple instances might exist.

A text field that is used to communicate information not previously defined or for special instructions. To be used only for circumstances not covered by specific elements.

ComplaintLineItemDetail

A group item containing information necessary to identify the type of article being complained (example: pallet, reel etc.)

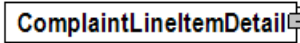

ItemType [attribute]

ItemType is mandatory. A single instance is required.

Indicates the form of the item being reported as being used. Many of the ItemType(s) indicated here have a corresponding named element equivalent, which is referenced here for definition purposes.

Refer to ItemType definition for any enumerations.

(sequence)

The sequence of items below is mandatory. A single instance is required.

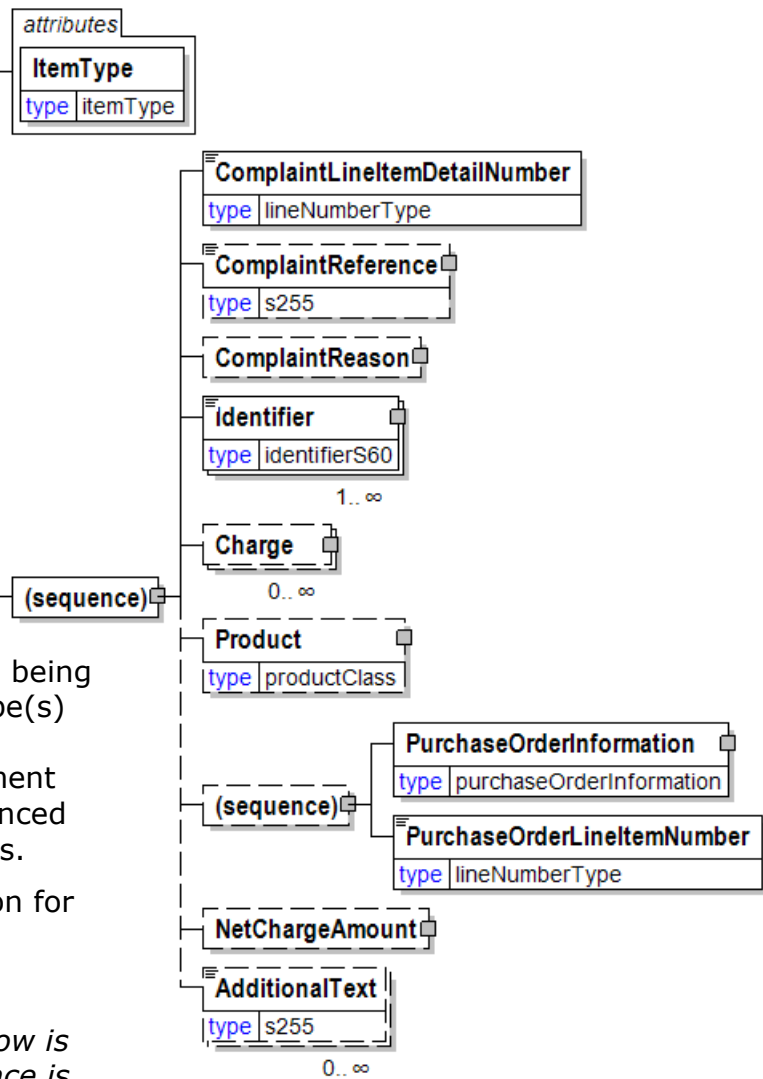

ComplaintLineItemDetailNumber

ComplaintLineItemDetailNumber is mandatory. A single instance is required.

The sequential number of an item assigned by the party making the Complaint within ComplaintLineItemDetail

ComplaintReference

ComplaintReference is optional. A single instance might exist.

papiNet V2R31

A group item detailing relevant references pertaining to the Complaint. ComplaintReference contains the attribute ComplaintReferenceType.

ComplaintReason

ComplaintReason is optional. A single instance might exist.

A group item containing the reason for the Complaint.

Identifier

Identifier is mandatory. One instance is required, multiple instances might exist.

An Identifier is required for packages and items (pallets, reel packages, boxes, ream items, reel items, etc). The Identifier element contains the actual item identifier code. Identifier is repeatable so more than one identifier can be communicated. For example, the printed identifier on a label may be different from the barcode printed on the label.

Charge

Charge is optional. Multiple instances might exist.

Charge is a group element that contains elements that describe a charge.

Product

Product is optional. A single instance might exist.

Product is a group item defining the article and its characteristics. Product is used to specify product characteristics organized by ProductIdentifier, ProductDescription, and Classification. Book Manufacturing, Label Stock, Paper, Pulp, Recovered Paper, Wood Products, and Virgin Fibre market segments have defined their product characteristics and conversion features for implementation in papiNet.

(sequence)

The sequence of items below is optional. A single instance might exist.

PurchaseOrderInformation

PurchaseOrderInformation is mandatory. A single instance is required.

A group item containing information unique to this PurchaseOrder, which is provided by the buyer. PurchaseOrderInformation can be optional in the supply chain. Invoices are created without having a PurchaseOrder in Vendor Managed Inventory. Freight invoices also will not have a PurchaseOrder number.

PurchaseOrderLineItemNumber

PurchaseOrderLineItemNumber is mandatory. A single instance is required.

The sequential number that uniquely identifies the PurchaseOrder line item.

NetChargeAmount

NetChargeAmount is optional. A single instance might exist.

A field containing the sum of all instances of the Complaint charges.

AdditionalText

AdditionalText is optional. Multiple instances might exist.

A text field that is used to communicate information not previously defined or for special instructions. To be used only for circumstances not covered by specific elements.

ComplaintLineItemDetailNumber

The sequential number of an item assigned by the party making the Complaint within ComplaintLineItemDetail

ComplaintLineItemDetailNumber	
type	lineNumberType

ComplaintLineItemNumber

The number used to identify the Complaint line item

ComplaintLineItemNumber	
type	lineNumberType

ComplaintLineNetChargeAmount

The total complained amount per line.

(sequence)

The sequence of items below is mandatory. A single instance is required.

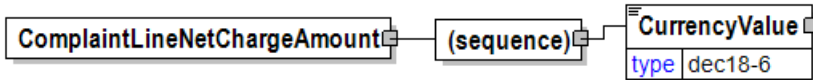

CurrencyValue

CurrencyValue is mandatory. A single instance is required.

The amount in the referenced currency as defined by the CurrencyType attribute.

CurrencyValue	
type	dec18-6

ComplaintNumber

A unique identification number of the Complaint, generated by the complainer.

ComplaintNumber	
type	s30

ComplaintReason

A group item containing the reason for the Complaint.

ComplaintReasonType [attribute]

ComplaintReasonType is optional. A single instance might exist.

The type of complaint reason.

Refer to ComplaintReasonType definition for any enumerations.

(sequence)

The sequence of items below is mandatory. A single instance is required.

ComplaintReasonCode

ComplaintReasonCode is optional. A single instance might exist.

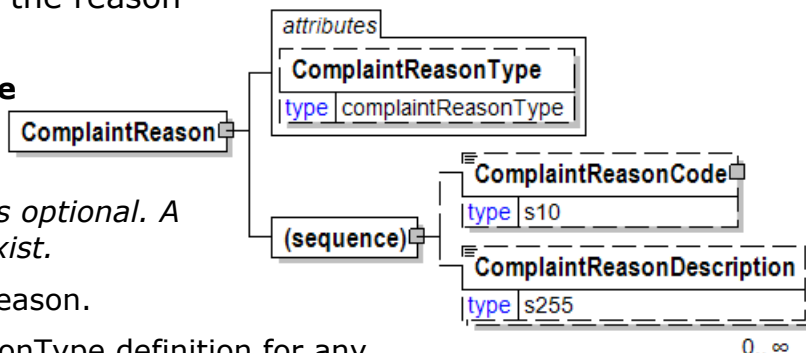

ComplaintReasonCode	
type	s10

ComplaintReasonDescription	
type	s255

0..∞

papiNet V2R31

A code for quickly communicating the type of ComplaintReason. The Agency responsible for the code can be associated with the element.

ComplaintReasonDescription

ComplaintReasonDescription is optional. Multiple instances might exist.

A text field element describing the reason for the Complaint

ComplaintReasonCode

A code for quickly communicating the type of ComplaintReason. The Agency responsible for the code can be associated with the element.

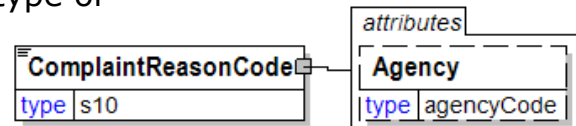

Agency [attribute]

Agency is optional. A single instance might exist.

Describes the agency maintaining the list of codes. To be included in this list the agency must be a recognized standards body or industry organisation.

- For the element that owns this attribute.
- For another attribute in the list of attributes associated with the parent element.

Refer to Agency definition for any enumerations.

ComplaintReasonDescription

A text field element describing the reason for the Complaint

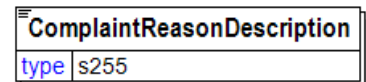

ComplaintReasonType [attribute]

The type of complaint reason.

This item is restricted to the following list.

Commercial

Logistical

Technical



ComplaintReference

A group item detailing relevant references pertaining to the Complaint.

ComplaintReference contains the attribute ComplaintReferenceType.

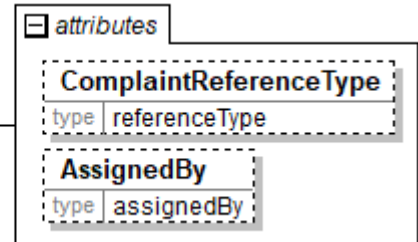
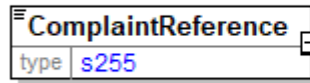

ComplaintReferenceType [attribute]

ComplaintReferenceType is optional. A single instance might exist.

Provides a contextual explanation of the specific reference identifier. Many items are currently prefixed by "Buyer", "Forwarder", "Manufacturer", "Mill", "Seller", "Supplier", "Warehouse", or "Vendor". Check for an existing non-prefixed version and use the non-prefixed version instead. In the (yet to be announced release date) version 3.0 the prefixed versions will be removed. Instead the attribute @AssignedBy will communicate the information previously communicated in the prefix.

Refer to ComplaintReferenceType definition for any enumerations.

AssignedBy [attribute]

AssignedBy is optional. A single instance might exist.

Identifies the type of party or the agency that has assigned the associated item, e.g. a reference of type OrderNumber.

Refer to AssignedBy for any enumerations.

ComplaintReferenceType [attribute]

Provides a contextual explanation of the specific reference identifier. Many items are currently prefixed by "Buyer", "Forwarder", "Manufacturer", "Mill", "Seller", "Supplier", "Warehouse", or "Vendor". Check for an existing non-prefixed version and use the non-prefixed version instead. In the (yet to be announced release date) version 3.0 the prefixed versions will be removed. Instead the attribute @AssignedBy will communicate the information previously communicated in the prefix.

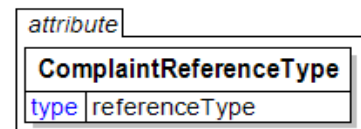

Refer to the [referenceType](#) entry for the list of enumerations and their definitions.

ComplaintResponse

The ComplaintResponse element is the root element for the ComplaintResponse e-Document.

Typically, a ComplaintResponse e-Document is sent from the supplier or sender parties to the party who has originated the Complaint, or possibly to the RespondToParty. The e-Document is sent to communicate the acceptance, partial acceptance, or rejection, of the preceding complaint(s) with supporting information. Whatever the decision, this e-Document must specify how the complaint will be processed.

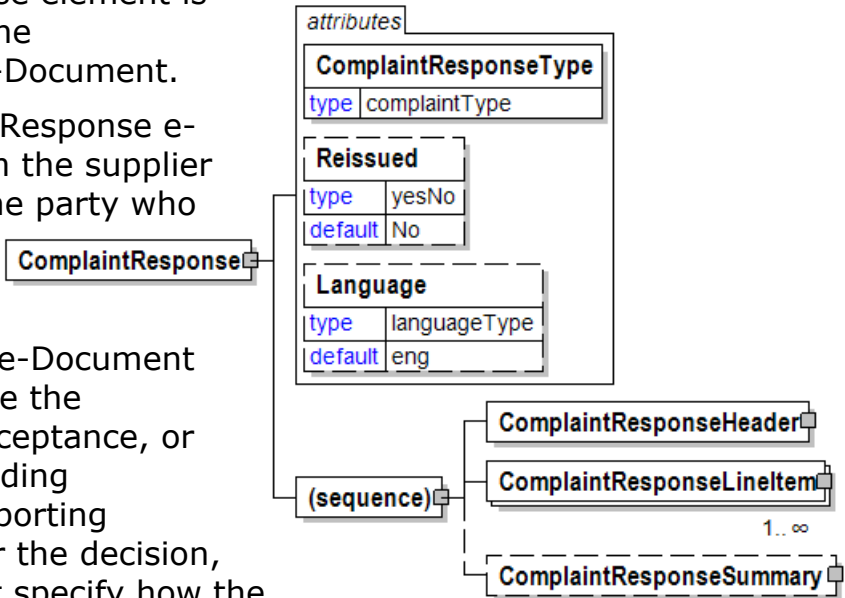

ComplaintResponseType [attribute]

ComplaintResponseType is mandatory. A single instance is required.

Indicates if the e-Document represents a Complaint by the sender or Feedback from the sender.

Refer to ComplaintResponseType definition for any enumerations.

Reissued [attribute]

Reissued is optional. A single instance might exist.

Either "Yes" or "No".

Refer to Reissued definition for any enumerations.

Language [attribute]

Language is optional. A single instance might exist.

The valid Alpha 2- and Alpha 3-character list of language codes in the ISO 639-1 and 639-2 international standards.

Information on the content of this attribute is available at:
https://www.loc.gov/standards/iso639-2/php/code_list.php

(sequence)

The sequence of items below is mandatory. A single instance is required.

ComplaintResponseHeader

ComplaintResponseHeader is mandatory. A single instance is required.

The ComplaintResponseHeader is required and contains information common to the ComplaintResponse.

ComplaintResponseLineItem

ComplaintResponseLineItem is mandatory. One instance is required, multiple instances might exist.

papiNet V2R31

The detail information about the response for a particular complaint.

Note: In version V2R30 the multiplicity of e-Attachment was changed from optional, repeatable to optional, single. It is recognized that this is not backwardly compatible. We apologize for any issues this causes.

ComplaintResponseSummary

ComplaintResponseSummary is optional. A single instance might exist.

Summary information that applies to the entire ComplaintResponse e-Document.

ComplaintResponseHeader

The ComplaintResponseHeader is required and contains information common to the ComplaintResponse.

ComplaintResponseHeaderStatusType [attribute]

ComplaintResponseHeaderStatusType is mandatory. A single instance is required.

The status of the ComplaintResponse header.

Refer to

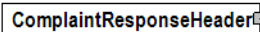

ComplaintResponseHeaderStatusType definition for any enumerations.

(sequence)

The sequence of items below is mandatory. A single instance is required.

ComplaintResponseNumber

ComplaintResponseNumber is mandatory. A single instance is required.

A unique identification number of the ComplaintResponse, generated by the issuer of the ComplaintResponse.

ComplaintResponseIssueDate

ComplaintResponseIssueDate is mandatory. A single instance is required.

The date on which the ComplaintResponse was issued within the sender's system.

ComplaintInformation

ComplaintInformation is mandatory. One instance is required, multiple instances might exist.

ComplaintInformation is a grouping element that contains general information about the Complaint.

RequestedAction

RequestedAction is optional. A single instance might exist.

The element that enables the party making the complaint (i.e. SenderParty) to specify what they want done regarding the Complaint (send a credit, send disposition instructions, etc.)

CorrectiveAction

CorrectiveAction is mandatory. A single instance is required.

This element enables the party issuing the ComplaintResponse (i.e. SupplierParty) to specify what is the corrective action they will take in order to close the Complaint (send a credit, send disposition instructions, etc.)

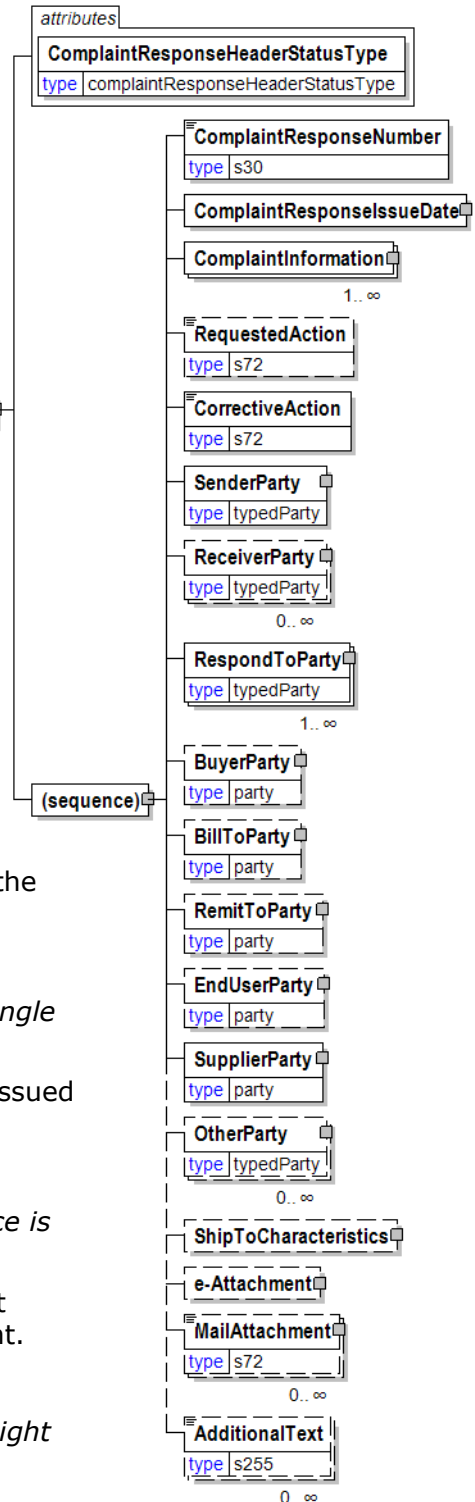

SenderParty

SenderParty is optional. A single instance might exist.

The business entity issuing the e-Document, the source of the document.

The entity responsible for the content. If the sender party has out sourced the message service to a third party the SenderParty is the issuer of the e-Document and not the party performing the transmission service of the electronic message.

ReceiverParty

ReceiverParty is optional. Multiple instances might exist.

The business entity for whom the e-Document is intended, the destination of the document.

The entity interested in the content. If the receiver party has outsourced the message service to a third party the ReceiverParty is the intended party for the e-Document and not the party performing the receiving service of the electronic message.

RespondToParty

RespondToParty is mandatory. One instance is required, multiple instances might exist.

The party the document should be responded to.

BuyerParty

BuyerParty is optional. A single instance might exist.

The legal entity to which the product is sold. Also commonly referred to as the sold-to party or customer. If no OtherParty is defined as the Payer, the Buyer is the Payer.

BillToParty

BillToParty is optional. A single instance might exist.

The address where the Invoice is to be sent.

RemitToParty

RemitToParty is optional. A single instance might exist.

A group item containing details of the party to whom payment will be made. The RemitToParty contains all information related to remittance.

EndUserParty

EndUserParty is optional. A single instance might exist.

The party using, consuming, or converting the product. For example, a printer using paper reels for a print job for a publisher. The final ShipTo destination for a product is normally to the end user's facilities.

SupplierParty

SupplierParty is mandatory. A single instance is required.

The organisation or business entity responsible for providing the product. SupplierParty is also the seller of the product, if Seller is not specified as OtherParty = Seller.

OtherParty

OtherParty is optional. Multiple instances might exist.

An organisation or business entity other than those specifically detailed within an

e-Document.

ShipToCharacteristics

ShipToCharacteristics is optional. A single instance might exist.

A group item that provides information important for the Ship-To Party.

e-Attachment

e-Attachment is optional. A single instance might exist.

e-Attachment enables the sender to provide information about attachments to the document.

Note: BizTalk users may have problems in processing this element. See the papiNet FAQs (papiNet.org) for more information.

MailAttachment

MailAttachment is optional. Multiple instances might exist.

MailAttachment enables the complainer to indicate that they are providing by mail (express courier, snail mail etc.) proof of the Complaint.

AdditionalText

AdditionalText is optional. Multiple instances might exist.

A text field that is used to communicate information not previously defined or for special instructions. To be used only for circumstances not covered by specific elements.

ComplaintResponseHeaderStatusType [attribute]

The status of the ComplaintResponse header.

This item is restricted to the following list.

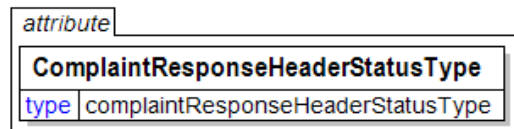

Accepted

The supplied information is accepted.

PartiallyAccepted

The supplied information is not completely accepted.

Rejected

The supplied information is rejected.

ComplaintResponseIssueDate

The date on which the ComplaintResponse was issued within the sender's system.

(sequence)

The sequence of items below is mandatory. A single instance is required.

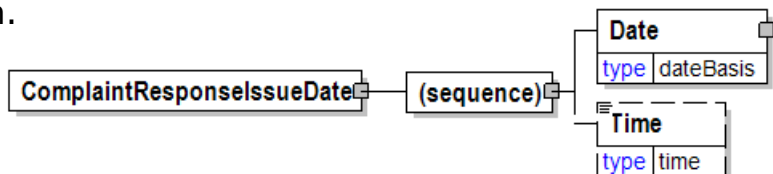

Date

papiNet V2R31

Date is mandatory. A single instance is required.

A group element that contains the specification of Year, Month, and Day.

Time

Time is optional. A single instance might exist.

Times are treated in a standard XML fashion with a special case used to indicate a generalized "local" time. The standard XML approach to time is hh:mm:ss, hh:mm:ssZ, or hh:mm:ss±hh:mm.

hh:mm:ss±hh:mm is used to represent a time with a time zone. The time zone is communicated as the number of hours offset from the Universal Time Coordinate (UTC), a.k.a. Greenwich Mean Time.

hh:mm:ssZ indicates the time at Zulu (another name for UTC).

hh:mm:ss or hh:mm indicates within papiNet the applicable local time where the associated event is taking place. Caution should be used when processing times of this nature as the papiNet approach may be in discord with other users of XML.

ComplaintResponseLineItem

The detail information about the response for a particular complaint.

Note: In version V2R30 the multiplicity of e-Attachment was changed from optional, repeatable to optional, single. It is recognized that this is not backwardly compatible.

ComplaintResponseLineItem

We apologize for any issues this causes.

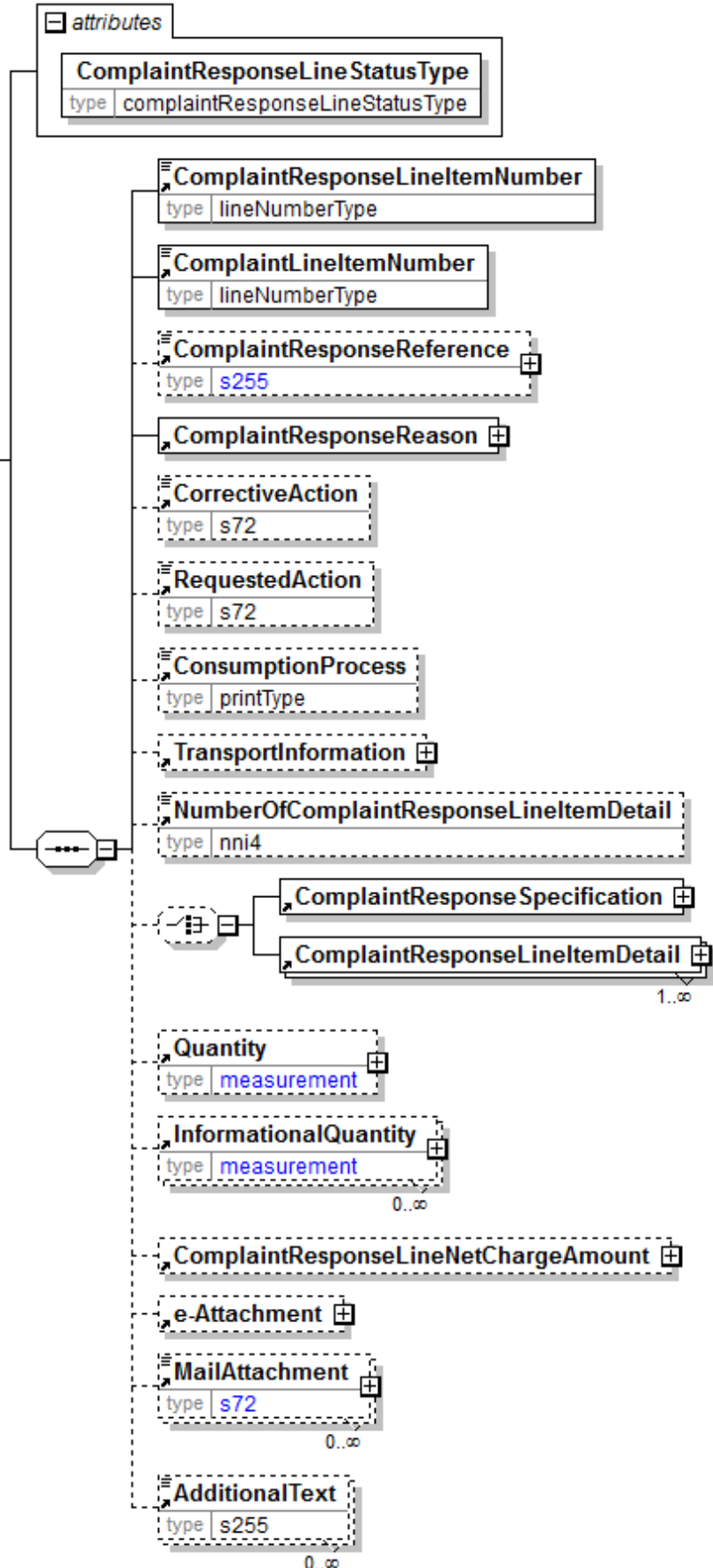

ComplaintResponseLineStyleType [attribute]

ComplaintResponseLineStyleType is mandatory. A single instance is required.

The status of the ComplaintResponse line.

Refer to ComplaintResponseLineStyleType definition for any enumerations.

(sequence)

The sequence of items below is mandatory. A single instance is required.

ComplaintResponseLineItemNumber

ComplaintResponseLineItemNumber is mandatory. A single instance is required.

The number used to identify the ComplaintResponse line item

ComplaintLineItemNumber

ComplaintLineItemNumber is mandatory. A single instance is required.

The number used to identify the Complaint line item

ComplaintResponseReference

ComplaintResponseReference is optional. A single instance might exist.

A group item detailing relevant references pertaining to the ComplaintResponse

ComplaintResponseReason

ComplaintResponseReason is mandatory. A single instance is required.

A group item containing the reason assessed by the supplier or sender parties for the ComplaintResponse

CorrectiveAction

CorrectiveAction is optional. A single instance might exist.

This element enables the party issuing the ComplaintResponse (i.e. SupplierParty) to specify what is the corrective action they will take in order to close the Complaint (send a credit, send disposition instructions, etc.)

RequestedAction

RequestedAction is optional. A single instance might exist.

The element that enables the party making the complaint (i.e. SenderParty) to specify what they want done regarding the Complaint (send a credit, send disposition instructions, etc.)

ConsumptionProcess

ConsumptionProcess is optional. A single instance might exist.

Identifies the process relevant to the situation being described.

Refer to ConsumptionProcess definition for any enumerations.

TransportInformation

TransportInformation is optional. A single instance might exist.

A grouping element for transport information.

NumberOfComplaintResponseLineItemDetail

NumberOfComplaintResponseLineItemDetail is optional. A single instance might exist.

The number of ComplaintResponseLineItemDetail elements for a given ComplaintResponseLineItem

(choice)

[choice] is optional. A single instance might exist.

ComplaintResponseSpecification

ComplaintResponseSpecification is mandatory. A single instance is required.

A group item containing information necessary to identify the physical item.

ComplaintResponseLineItemDetail

ComplaintResponseLineItemDetail is mandatory. One instance is required, multiple instances might exist.

A group item containing information necessary to identify the type of article being complained.

Quantity

Quantity is optional. A single instance might exist.

The Quantity element contains attributes that provide information about the type of quantity that is being communicated, the context in which the particular quantity is to be viewed, and (if the quantity represents an adjustment) an adjustment type.

The Quantity element contains three child elements that enable you to communicate a range of values for the quantity and a target or actual value. It is at this level (Value, RangeMin, and RangeMax) that the unit of measure is specified. This permits the range to be specified in a different unit of measure than the target.

InformationalQuantity

InformationalQuantity is optional. Multiple instances might exist.

A quantity given in a valid UOM used for information purposes only (not for calculation). For example, an ordered quantity was 100 reels as opposed to the invoice quantity of 20,000 pounds.

ComplaintResponseLineNetChargeAmount

ComplaintResponseLineNetChargeAmount is optional. A single instance might exist.

The net ComplaintResponse amount per line (excludes adjustments and tax).

e-Attachment

e-Attachment is optional. A single instance might exist.

e-Attachment enables the sender to provide information about attachments to the document.

Note: BizTalk users may have problems in processing this element. See the papiNet FAQs (papiNet.org) for more information.

MailAttachment

MailAttachment is optional. Multiple instances might exist.

MailAttachment enables the complainer to indicate that they are providing by mail (express courier, snail mail etc.) proof of the Complaint.

AdditionalText

AdditionalText is optional. Multiple instances might exist.

A text field that is used to communicate information not previously defined or for special instructions. To be used only for circumstances not covered by specific elements.

ComplaintResponseLineItemDetail

A group item containing information necessary to identify the type of article being complained.

ItemType [attribute]

ComplaintResponseLineItemDetail

ItemType is mandatory. A single instance is required.

Indicates the form of the item being reported as being used. Many of the ItemType(s) indicated here have a corresponding named element equivalent, which is referenced here for definition purposes.

Refer to ItemType definition for any enumerations.

(sequence)

The sequence of items below is mandatory. A single instance is required.

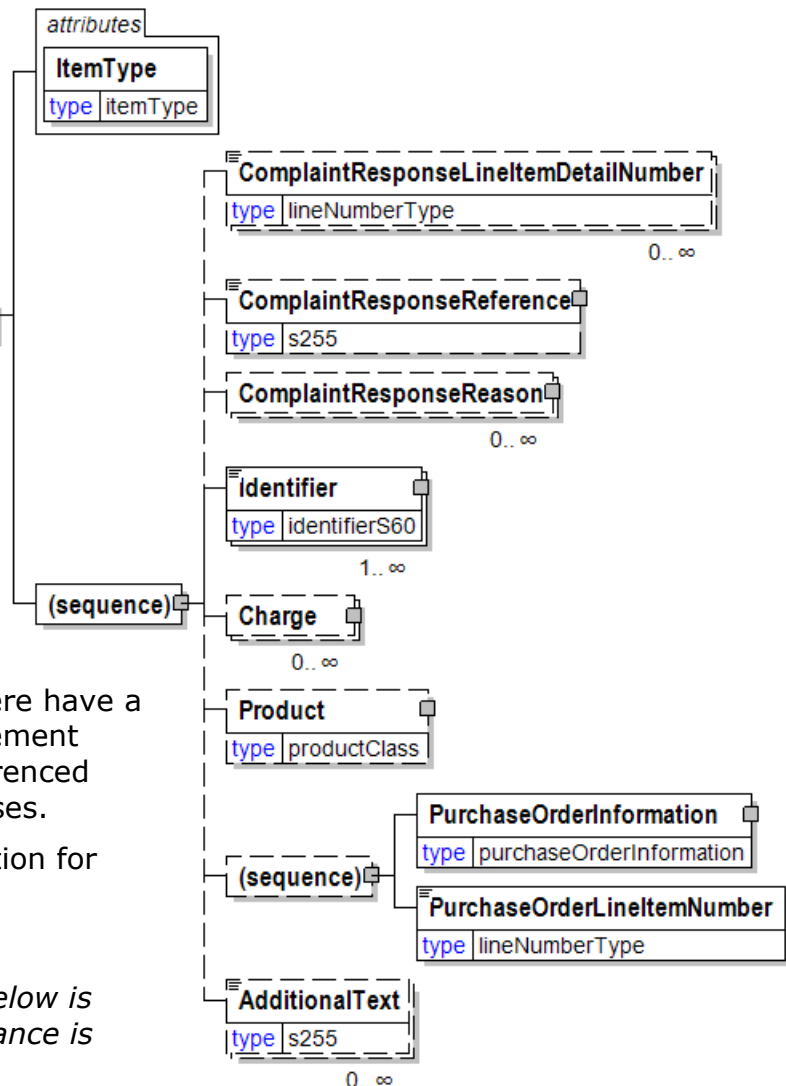

ComplaintResponseLineItemDetailNumber

ComplaintResponseLineItemDetailNumber is optional. Multiple instances might exist.

The sequential number of an item assigned by the party making the ComplaintResponse within line item detail.

ComplaintResponseReference

ComplaintResponseReference is optional. A single instance might exist.

A group item detailing relevant references pertaining to the ComplaintResponse

ComplaintResponseReason

ComplaintResponseReason is optional. Multiple instances might exist.

A group item containing the reason assessed by the supplier or sender parties for the ComplaintResponse

Identifier

Identifier is mandatory. One instance is required, multiple instances might exist.

An Identifier is required for packages and items (pallets, reel packages, boxes, ream items, reel items, etc). The Identifier element contains the actual item

papiNet V2R31

identifier code. Identifier is repeatable so more than one identifier can be communicated. For example, the printed identifier on a label may be different from the barcode printed on the label.

Charge

Charge is optional. Multiple instances might exist.

Charge is a group element that contains elements that describe a charge.

Product

Product is optional. A single instance might exist.

Product is a group item defining the article and its characteristics. Product is used to specify product characteristics organized by ProductIdentifier, ProductDescription, and Classification. Book Manufacturing, Label Stock, Paper, Pulp, Recovered Paper, Wood Products, and Virgin Fibre market segments have defined their product characteristics and conversion features for implementation in papiNet.

(sequence)

The sequence of items below is optional. A single instance might exist.

PurchaseOrderInformation

PurchaseOrderInformation is mandatory. A single instance is required.

A group item containing information unique to this PurchaseOrder, which is provided by the buyer. PurchaseOrderInformation can be optional in the supply chain. Invoices are created without having a PurchaseOrder in Vendor Managed Inventory. Freight invoices also will not have a PurchaseOrder number.

PurchaseOrderLineItemNumber

PurchaseOrderLineItemNumber is mandatory. A single instance is required.

The sequential number that uniquely identifies the PurchaseOrder line item.

AdditionalText

AdditionalText is optional. Multiple instances might exist.

A text field that is used to communicate information not previously defined or for special instructions. To be used only for circumstances not covered by specific elements.

ComplaintResponseLineItemDetailNumber

The sequential number of an item assigned by the party making the ComplaintResponse within line item detail.

ComplaintResponseLineItemDetailNumber
type lineNumberType

ComplaintResponseLineItemNumber

The number used to identify the ComplaintResponse line item

ComplaintResponseLineItemNumber
type lineNumberType

ComplaintResponseLineNetChargeAmount

The net ComplaintResponse amount per line (excludes adjustments and tax).

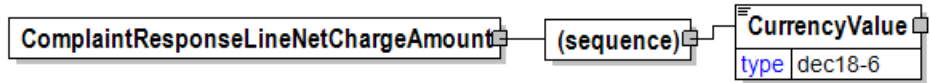

(sequence)

The sequence of items below is mandatory. A single instance is required.

CurrencyValue

CurrencyValue is mandatory. A single instance is required.

The amount in the referenced currency as defined by the CurrencyType attribute.

ComplaintResponseLineStatusType [attribute]

The status of the ComplaintResponse line.
This item is restricted to the following list.



Accepted

The supplied information is accepted.

PartiallyAccepted

The supplied information is not completely accepted.

Rejected

The supplied information is rejected.

ComplaintResponseNumber

A unique identification number of the ComplaintResponse, generated by the issuer of the ComplaintResponse.



ComplaintResponseReason

A group item containing the reason assessed by the supplier or sender parties for the

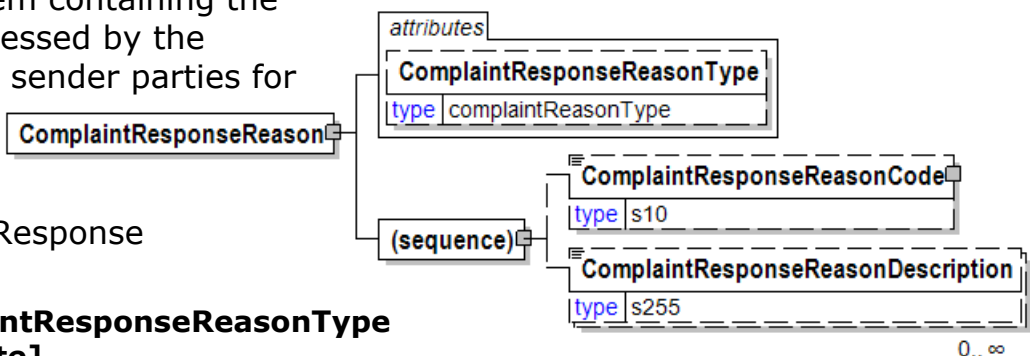

ComplaintResponse

ComplaintResponseReasonType [attribute]

ComplaintResponseReasonType is optional. A single instance might exist.

The type of complaint reason.

Refer to ComplaintResponseReasonType definition for any enumerations.

(sequence)

The sequence of items below is mandatory. A single instance is required.

ComplaintResponseReasonCode

ComplaintResponseReasonCode is optional. A single instance might exist.

The reason for the complaint in code form. Agency provides the context.

ComplaintResponseReasonDescription

ComplaintResponseReasonDescription is optional. Multiple instances might exist.

A text field element describing the reason for the ComplaintResponse

ComplaintResponseReasonCode

The reason for the complaint in code form. Agency provides the context.

Agency [attribute]

Agency is optional. A single instance might exist.

Describes the agency maintaining the list of codes. To be included in this list the agency must be a recognized standards body or industry organisation.

- For the element that owns this attribute.
- For another attribute in the list of attributes associated with the parent element.

Refer to Agency definition for any enumerations.



ComplaintResponseReasonDescription

A text field element describing the reason for the ComplaintResponse

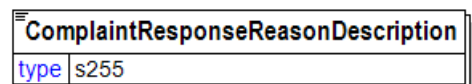

ComplaintResponseReasonType [attribute]

The type of complaint reason.

This item is restricted to the following list.

Commercial

Logistical

Technical



ComplaintResponseReference

A group item detailing relevant references pertaining to the

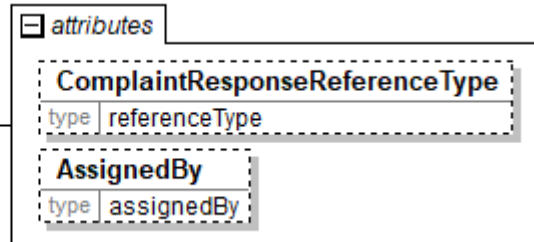
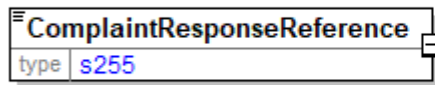

ComplaintResponse

ComplaintResponseReferenceType [attribute]

ComplaintResponseReferenceType is optional. A single instance might exist.

Provides a contextual explanation of the specific reference identifier. Many items are currently prefixed by "Buyer", "Forwarder", "Manufacturer", "Mill", "Seller", "Supplier", "Warehouse", or "Vendor". Check for an existing non-prefixed version and use the non-prefixed version instead. In the (yet to be announced release date) version 3.0 the prefixed versions will be removed. Instead the attribute @AssignedBy will communicate the information previously communicated in the prefix.

Refer to ComplaintResponseReferenceType definition for any enumerations.

AssignedBy [attribute]

AssignedBy is optional. A single instance might exist.

Identifies the type of party or the agency that has assigned the associated item, e.g. a reference of type OrderNumber.

Refer to AssignedBy for any enumerations

ComplaintResponseReferenceType [attribute]

Provides a contextual explanation of the specific reference identifier. Many items are currently prefixed by "Buyer", "Forwarder", "Manufacturer", "Mill", "Seller", "Supplier", "Warehouse", or "Vendor". Check for an

existing non-prefixed version and use the non-prefixed version instead. In the (yet to be announced release date) version 3.0 the prefixed versions will be removed. Instead the attribute @AssignedBy will communicate the information previously communicated in the prefix.

Refer to the [referenceType](#) entry for the list of enumerations and their definitions.

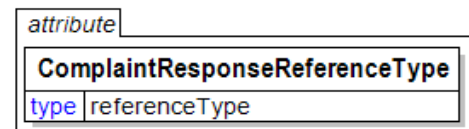

ComplaintResponseSpecification

A group item containing information necessary to identify the physical item.

(sequence)

The sequence of items below is mandatory. A single instance is required.

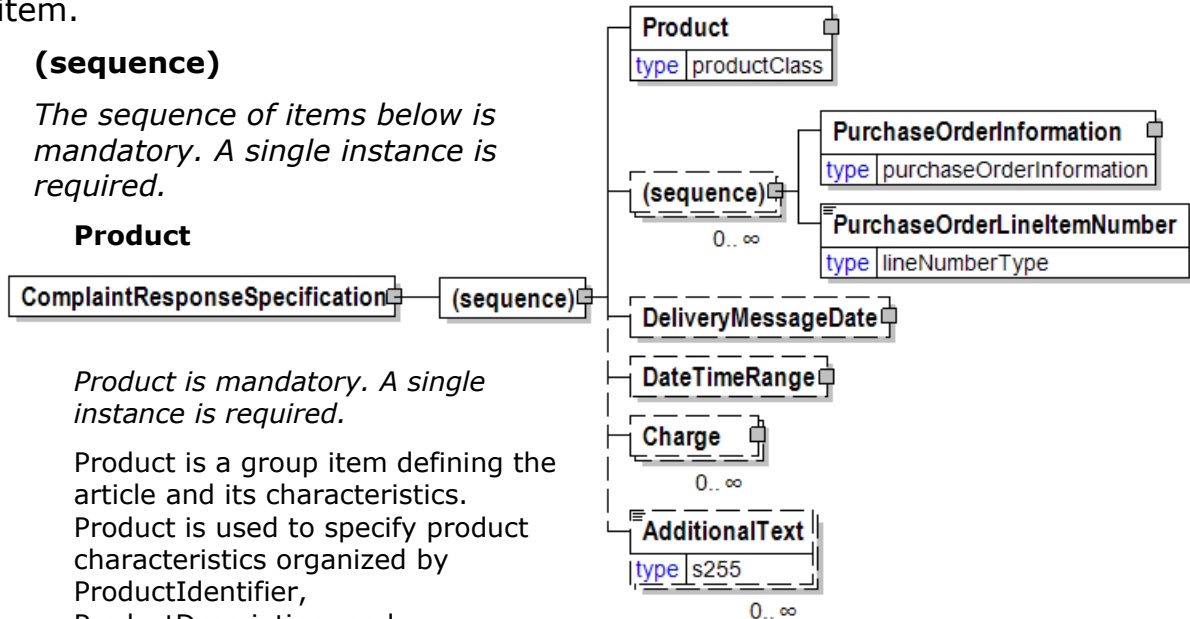

Product

Product is mandatory. A single instance is required.

Product is a group item defining the article and its characteristics. Product is used to specify product characteristics organized by ProductIdentifier, ProductDescription, and Classification. Book Manufacturing, Label Stock, Paper, Pulp, Recovered Paper, Wood Products, and Virgin Fibre market segments have defined their product characteristics and conversion features for implementation in papiNet.

(sequence)

The sequence of items below is optional. Multiple instances might exist.

PurchaseOrderInformation

PurchaseOrderInformation is mandatory. A single instance is required.

A group item containing information unique to this PurchaseOrder, which is provided by the buyer. PurchaseOrderInformation can be optional in the supply chain. Invoices are created without having a PurchaseOrder in Vendor Managed Inventory. Freight invoices also will not have a PurchaseOrder number.

PurchaseOrderLineItemNumber

PurchaseOrderLineItemNumber is mandatory. A single instance is required.

The sequential number that uniquely identifies the PurchaseOrder line item.

DeliveryMessageDate

DeliveryMessageDate is optional. A single instance might exist.

The Date and Time when the DeliveryMessage was issued.

DateTimeRange

DateTimeRange is optional. A single instance might exist.

Specifies a date and/or time range.

Charge

Charge is optional. Multiple instances might exist.

Charge is a group element that contains elements that describe a charge.

AdditionalText

AdditionalText is optional. Multiple instances might exist.

A text field that is used to communicate information not previously defined or for special instructions. To be used only for circumstances not covered by specific elements.

ComplaintResponseSummary

Summary information that applies to the entire ComplaintResponse e-Document.

(sequence)

The sequence of items below is mandatory. A single instance is required.

TotalNumberOfLineItems

TotalNumberOfLineItems is optional. A single instance might exist.

The total number of individual line items in the document, regardless of the status or type.

TotalQuantity

TotalQuantity is optional. A single instance might exist.

The total quantity of similar items in the e-Document. TotalQuantity is primarily used in the summary section of documents where it is repeatable to permit totaling for different units of measure.

TotalInformationalQuantity

TotalInformationalQuantity is optional. Multiple instances might exist.

A quantity that is used to communicate related information about the parent element. This element represents a total that is derived from individual line items.

TotalNetAmount

TotalNetAmount is optional. A single instance might exist.

A field containing total amount excluding tax. For example, in the Invoice TotalNetAmount is equal to the sum of LineItemSubTotal plus TotalAdjustments. TotalNetAmount encapsulates CurrencyValue.

TotalInformationalAmount

TotalInformationalAmount is optional. Multiple instances might exist.

A monetary amount used for information purposes only (not for calculation). For example, the invoice price adjustment subtotal is expressed in sterling pounds, and the buyer wants this information expressed in U.S. dollars.

AdditionalText

AdditionalText is optional. Multiple instances might exist.

A text field that is used to communicate information not previously defined or for special instructions. To be used only for circumstances not covered by specific elements.

TermsAndDisclaimers

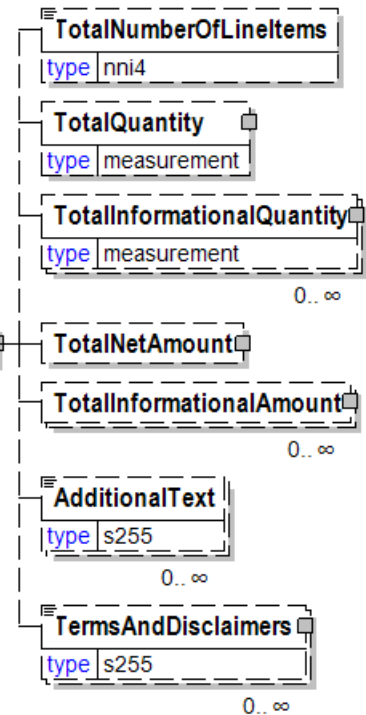

papiNet V2R31

TermsAndDisclaimers is optional. Multiple instances might exist.

An element that contains legal information with an indication of what the Language is.

ComplaintResponseType [attribute]

Indicates if the e-Document represents a Complaint by the sender or Feedback from the sender.

This item is restricted to the following list.

Claim

Feedback

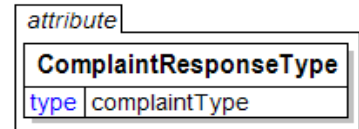

ComplaintSpecification

A group item containing information necessary to identify the physical item

(sequence)

The sequence of items below is mandatory. A single instance is required.

Product

Product is optional. A single instance might exist.

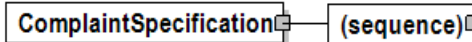

Product is a group item defining the article and its characteristics. Product is used to specify product characteristics organized by ProductIdentifier, ProductDescription, and Classification. Book Manufacturing, Label Stock, Paper, Pulp, Recovered Paper, Wood Products, and Virgin Fibre market segments have defined their product characteristics and conversion features for implementation in papiNet.

(sequence)

The sequence of items below is optional. Multiple instances might exist.

PurchaseOrderInformation

PurchaseOrderInformation is mandatory. A single instance is required.

A group item containing information unique to this PurchaseOrder, which is provided by the buyer. PurchaseOrderInformation can be optional in the supply chain. Invoices are created without having a PurchaseOrder in Vendor Managed Inventory. Freight invoices also will not have a PurchaseOrder number.

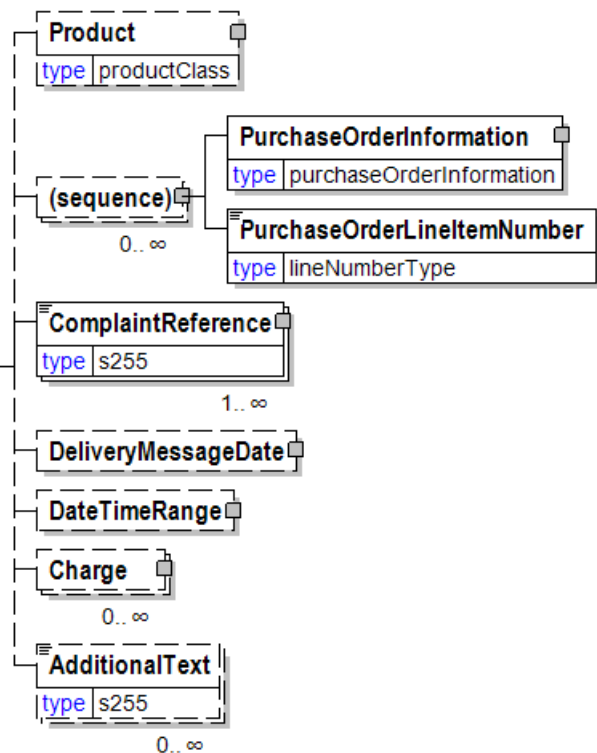

papiNet V2R31

PurchaseOrderLineItemNumber

PurchaseOrderLineItemNumber is mandatory. A single instance is required.

The sequential number that uniquely identifies the PurchaseOrder line item.

ComplaintReference

ComplaintReference is mandatory. One instance is required, multiple instances might exist.

A group item detailing relevant references pertaining to the Complaint. ComplaintReference contains the attribute ComplaintReferenceType.

DeliveryMessageDate

DeliveryMessageDate is optional. A single instance might exist.

The Date and Time when the DeliveryMessage was issued.

DateTimeRange

DateTimeRange is optional. A single instance might exist.

Specifies a date and/or time range.

Charge

Charge is optional. Multiple instances might exist.

Charge is a group element that contains elements that describe a charge.

AdditionalText

AdditionalText is optional. Multiple instances might exist.

A text field that is used to communicate information not previously defined or for special instructions. To be used only for circumstances not covered by specific elements.

ComplaintSummary

Summary information that applies to the entire complaint e-Document.

(sequence)

The sequence of items below is mandatory. A single instance is required.

TotalNumberOfLineItems

TotalNumberOfLineItems is optional. A single instance might exist.

The total number of individual line items in the document, regardless of the status or type.

TotalQuantity

TotalQuantity is optional. A single instance might exist.

The total quantity of similar items in the e-Document. TotalQuantity is primarily used in the summary section of documents where it is repeatable to permit totaling for different units of measure.

ComplaintSummary

(sequence)

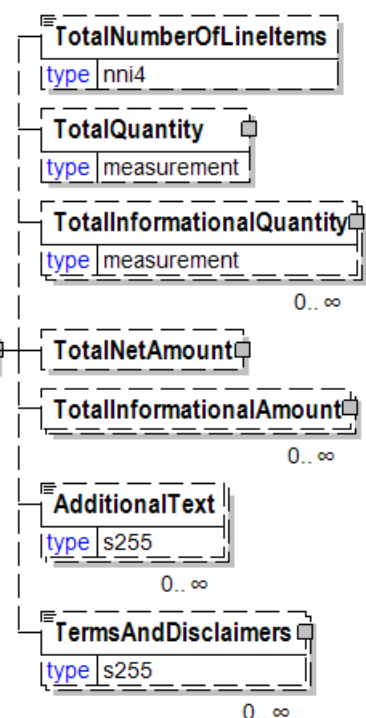

TotalInformationalQuantity

TotalInformationalQuantity is optional. Multiple instances might exist.

A quantity that is used to communicate related information about the parent element. This element represents a total that is derived from individual line items.

TotalNetAmount

TotalNetAmount is optional. A single instance might exist.

A field containing total amount excluding tax. For example, in the Invoice TotalNetAmount is equal to the sum of LineItemSubTotal plus TotalAdjustments. TotalNetAmount encapsulates CurrencyValue.

TotalInformationalAmount

TotalInformationalAmount is optional. Multiple instances might exist.

A monetary amount used for information purposes only (not for calculation). For example, the invoice price adjustment subtotal is expressed in sterling pounds, and the buyer wants this information expressed in U.S. dollars.

AdditionalText

AdditionalText is optional. Multiple instances might exist.

A text field that is used to communicate information not previously defined or for special instructions. To be used only for circumstances not covered by specific elements.

TermsAndDisclaimers

TermsAndDisclaimers is optional. Multiple instances might exist.

An element that contains legal information with an indication of what the Language is.

ComplaintType [attribute]

Indicates if the e-Document represents a Complaint by the sender or Feedback from the sender.

This item is restricted to the following list.

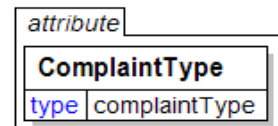

Claim

A "Claim" type is used when there is a customer reaction that includes a financial compensation.

Feedback

A "Feedback" type is used when there is a customer reaction that doesn't include any financial compensation.

ComponentDueDate

Date supplied component is expected to arrive

(sequence)

The sequence of items below is mandatory. A single instance is required.

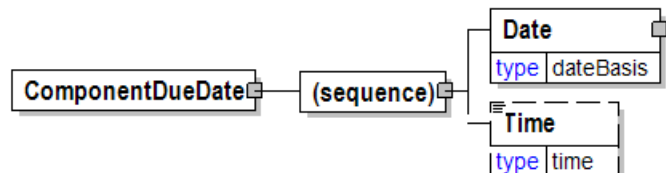

papiNet V2R31

Date

Date is mandatory. A single instance is required.

A group element that contains the specification of Year, Month, and Day.

Time

Time is optional. A single instance might exist.

Times are treated in a standard XML fashion with a special case used to indicate a generalized "local" time. The standard XML approach to time is hh:mm:ss, hh:mm:ssZ, or hh:mm:ss±hh:mm.

hh:mm:ss±hh:mm is used to represent a time with a time zone. The time zone is communicated as the number of hours offset from the Universal Time Coordinate (UTC), a.k.a. Greenwich Mean Time.

hh:mm:ssZ indicates the time at Zulu (another name for UTC).

hh:mm:ss or hh:mm indicates within papiNet the applicable local time where the associated event is taking place. Caution should be used when processing times of this nature as the papiNet approach may be in discord with other users of XML.

ComponentNeededDate

Date the supplied component is needed by the vendor in order to make the due date of the ordered product.

(sequence)

The sequence of items below is mandatory. A single instance is required.

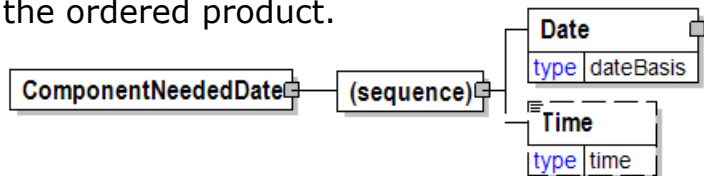

Date

Date is mandatory. A single instance is required.

A group element that contains the specification of Year, Month, and Day.

Time

Time is optional. A single instance might exist.

Times are treated in a standard XML fashion with a special case used to indicate a generalized "local" time. The standard XML approach to time is hh:mm:ss, hh:mm:ssZ, or hh:mm:ss±hh:mm.

hh:mm:ss±hh:mm is used to represent a time with a time zone. The time zone is communicated as the number of hours offset from the Universal Time Coordinate (UTC), a.k.a. Greenwich Mean Time.

hh:mm:ssZ indicates the time at Zulu (another name for UTC).

hh:mm:ss or hh:mm indicates within papiNet the applicable local time where the associated event is taking place. Caution should be used when processing times of this nature as the papiNet approach may be in discord with other users of XML.

ComponentShipDate

Date supplied component is expected to ship

(sequence)

The sequence of items below is mandatory. A single instance is required.

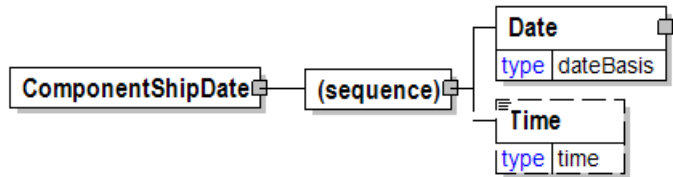

Date

Date is mandatory. A single instance is required.

A group element that contains the specification of Year, Month, and Day.

Time

Time is optional. A single instance might exist.

Times are treated in a standard XML fashion with a special case used to indicate a generalized "local" time. The standard XML approach to time is hh:mm:ss, hh:mm:ssZ, or hh:mm:ss±hh:mm.

hh:mm:ss±hh:mm is used to represent a time with a time zone. The time zone is communicated as the number of hours offset from the Universal Time Coordinate (UTC), a.k.a. Greenwich Mean Time.

hh:mm:ssZ indicates the time at Zulu (another name for UTC).

hh:mm:ss or hh:mm indicates within papiNet the applicable local time where the associated event is taking place. Caution should be used when processing times of this nature as the papiNet approach may be in discord with other users of XML.

CompositeAndVeneerWoodPanels

A grouping element that contains the timbler/lumber products that comprise composite and veneer

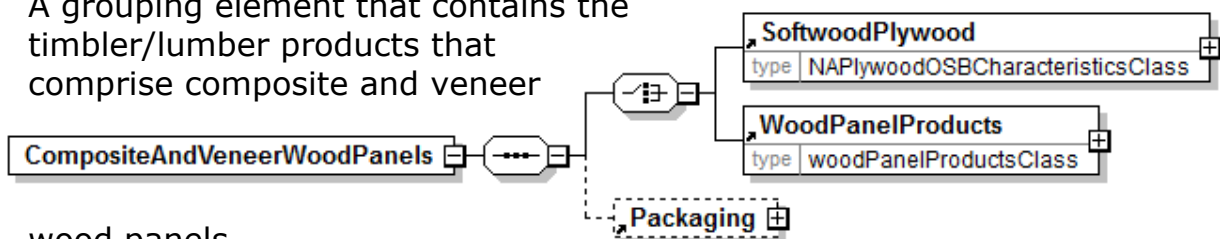

wood panels.

(sequence)

The sequence of items below is mandatory. A single instance is required.

(choice)

[choice] is mandatory. A single instance is required.

SoftwoodPlywood

SoftwoodPlywood is mandatory. A single instance is required.

Characteristics of wood panelling products.

WoodPanelProducts

WoodPanelProducts is mandatory. A single instance is required.

Characteristics of wood panelling products.

Packaging

papiNet V2R31

Packaging is optional. A single instance might exist.

Type of a package that includes individual products.

CompoundAgency [attribute]

The agency responsible for the compound coding.
Defines the trade name of the treatment.

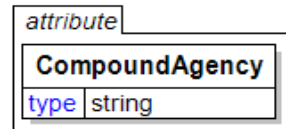

CompoundType [attribute]

Defines the type of chemical treatment used.

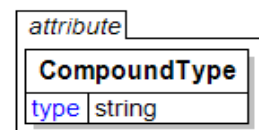

ConcernIndicatorType [attribute]

Either "Yes" or "No".

This item is restricted to the following list.

Yes

No

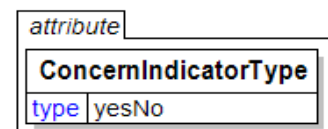

ConstructionPackagesAndPreFabPanels

A grouping element that contains the timber/lumber products that comprise construction packages and pre-fabricated panels.

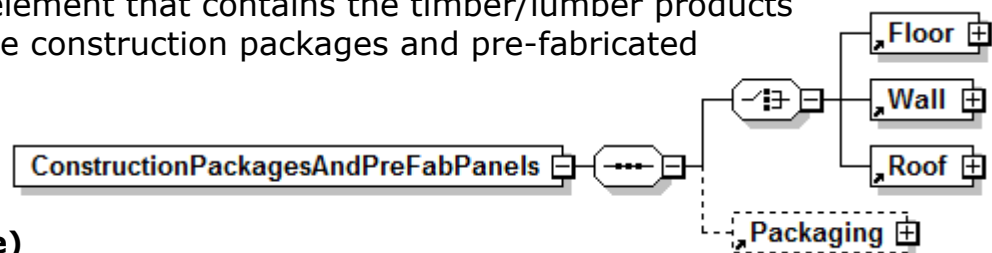

(sequence)

The sequence of items below is mandatory. A single instance is required.

(choice)

[choice] is mandatory. A single instance is required.

Floor

Floor is mandatory. A single instance is required.

Defines parts and complete flooring systems.

Wall

Wall is mandatory. A single instance is required.

Defines parts and complete wall systems.

Roof

Roof is mandatory. A single instance is required.

papiNet V2R31

Defines parts and complete roofing systems.

Packaging

Packaging is optional. A single instance might exist.

Type of a package that includes individual products.

ConsumptionProcess

Identifies the process relevant to the situation being described.

ConsumptionProcess	
type	printType

This item is restricted to the following list.

ColdsetOffset

An offset printing method suitable for newspapers, in other words, ink dries by penetration into the paper.

ContinuousForms

An offset printing method, generally without a hot drying section and suitable for reels.

Digital

An electrostatic printing method, typically a large black-and-white or multicolour printer/copier.

Flexography

A special printing method, which is a follow-up of letter print with advanced print cylinder surface. Suitable for sheets.

FoilPrint

A special printing/finishing method suitable for foils through embossed print plate/cylinder; flat/flat, or circle/flat (form to sheet).

Forms

An offset printing method, generally without a hot drying section and suitable for sheets.

Gravure

A standard printing method with embossed print cylinders. Suitable for sheets.

HeatsetOffset

An offset printing method.

InkJet

An inkjet printing method, typically a large black-and-white or multicolour printer.

InstantOffset

A standard flat printing method (for example, wet offset, or waterless offset) suitable for small print orders and small sheet sizes (for example, max. DIN A3).

Laser

A laser-based printing method, typically a large black-and-white or multicolour

printer/copier.

Letterpress

A special printing method suitable for books or newspapers (old style) with advanced letters. Suitable for sheets.

LightPrint

- A printing method similar to a facsimile print, a photo-like print with a specific prepared cylinder surface on photo basis or an artificial print.

MiniWeb

A digital printing method suitable for reels less than 20 inch wide.

RotoFlexography

RotoGravure

RotoLetterpress

RotoSilkScreen

SheetfedOffset

SilkScreen

WebOffset

ContactAvailability

A group element that contains information about the availability of a contact.

CalendarPeriod [attribute]

CalendarPeriod is mandatory. A single instance is required.

Defines the calendar period applicable to a time slot.

Refer to CalendarPeriod definition for any enumerations.

IsTimeSlotAvailable [attribute]

IsTimeSlotAvailable is mandatory. A single instance is required.

Defines if the time slot is available or not.

Refer to IsTimeSlotAvailable definition for any enumerations.

(sequence)

The sequence of items below is mandatory. A single instance is required.

TimeSlot

TimeSlot is mandatory. One instance is required, multiple instances might exist.

A period of time during which an activity can be scheduled.

DateTimeRange

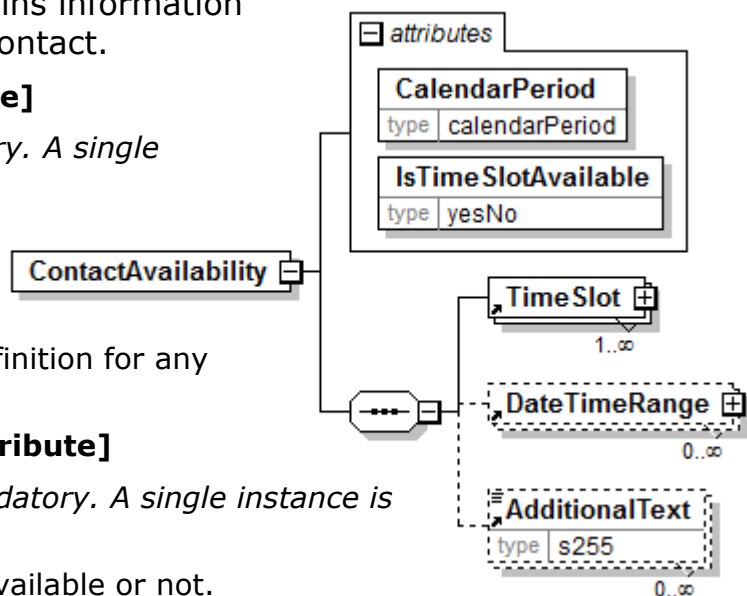

papiNet V2R31

DateTimeRange is optional. Multiple instances might exist.

Specifies a date and/or time range.

AdditionalText

AdditionalText is optional. Multiple instances might exist.

A text field that is used to communicate information not previously defined or for special instructions. To be used only for circumstances not covered by specific elements.

ContactIdentifier

The identifier for the contact.

ContactIdentifierType **[attribute]**

*ContactIdentifierType is mandatory.
A single instance is required.*

Indicates which particular identifier is being communicated.

Refer to ContactIdentifierType definition for any enumerations.

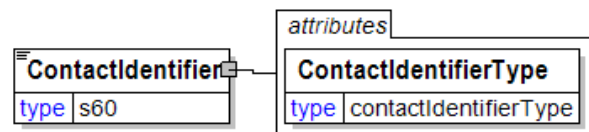

ContactIdentifierType [attribute]

Indicates which particular identifier is being communicated.

This item is restricted to the following list.

DriverLicenseID

The identifier for a driving licence.

PassportID

The identifier for a passport.

PersonalID

The identifier for a human being.

Other

PasportID

To be deprecated in a future version V3R00. Use PassportID. This enumeration had a spelling error.

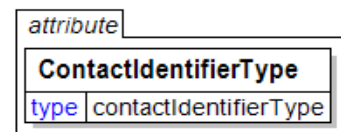

ContactName

The name of the individual associated with the ContactType.

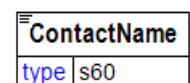

ContactType [attribute]

Identifies the role of the contact within the party.

This item is restricted to the following list.

attribute	
ContactType	
type	contactType

AccountManager

The person who manages the account for the seller or service provider.

Carrier

This contact person identified in the transaction works for a carrier.

CrossDock

This contact person identified in the transaction works at a cross-docking terminal/warehouse.

CustomerService

This contact person identified in the transaction works for the customer service department of the supplying company.

DocumentIssuer

The role or person who creates and/or updates the document.

DocumentReceiver

The role or person who receives the document

ForestForwarder

The contact that transports forest wood products from logging areas to roadside landings.

ForestForwardingRequestor

The contact requesting forest forwarding services.

ForestHarvester

The contact that harvests forest wood products at logging areas.

ForestHarvestingRequestor

The contact requesting forest harvesting services.

Forwarder

The contact for freight forwarding.

HelpDesk

The contact within the trading partner arrangement who services information related requests.

Measurer

The contact that is doing the measurements.

Merchant

This contact person identified in the transaction works for a merchant.

Mill

The paper or pulp mill involved in the transaction.

OriginalSupplier

The contact for the first supplier in a supply chain.

Plant

This contact person identified in the transaction works at the plant.

Purchaser

This contact person identified in the transaction works for the entity that is requesting the product.

RemitTo

This contact person identified in the transaction works for the entity to which payment is to be made.

RoadKeeper

A contact that is responsible for the maintenance of roads.

SalesOffice

This contact person identified in the transaction works for a sales office.

Supervisor

A contact that direct or oversee performance or operation.

Supplier

The contact for the organisation or business entity responsible for providing the product.

TransportPlanner

The person responsible for planning the transports.

TransportVehicle

Contact information for the transport vehicle involved in the transaction.

Warehouse

This contact person identified in the transaction works at a warehouse.

Other

This contact person identified in the transaction works for someone other than the entity types defined in the attribute list.

ContentOrderOfMatter

The ContentOrderOfMatter element is the root element for the ContentOrderOfMatter e-Document.

The ContentOrderOfMatter

e-Document accompanies the prep content files for the sole purpose of specifying the page sequence in the book and the associated folio information.

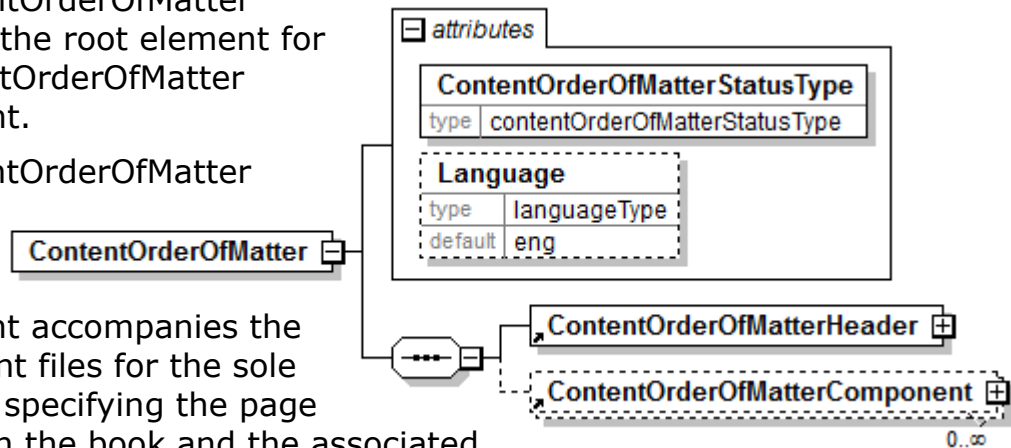

ContentOrderOfMatterStatusType [attribute]

ContentOrderOfMatterStatusType is mandatory. A single instance is required.

Identifies the status of the entire ContentOrderOfMatter e-Document.

Refer to ContentOrderOfMatterStatusType definition for any enumerations.

Language [attribute]

Language is optional. A single instance might exist.

The valid Alpha 2- and Alpha 3-character list of language codes in the ISO 639-1 and 639-2 international standards.

Information on the content of this attribute is available at:
https://www.loc.gov/standards/iso639-2/php/code_list.php

(sequence)

The sequence of items below is mandatory. A single instance is required.

ContentOrderOfMatterHeader

ContentOrderOfMatterHeader is mandatory. A single instance is required.

Information that applies to the entire ContentOrderOfMatter e-Document.

ContentOrderOfMatterComponent

ContentOrderOfMatterComponent is optional. Multiple instances might exist.

Group element used to identify all the necessary component information for the ContentOrderOfMatter e-Document.

ContentOrderOfMatterComponent

Group element used to identify all the necessary component information for

ContentOrderOfMatter.

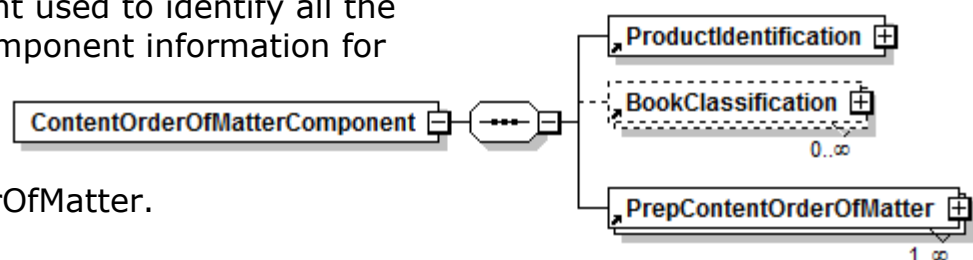

(sequence)

The sequence of items below is mandatory. A single instance is required.

ProductIdentification

ProductIdentification is mandatory. A single instance is required.

A grouping element designed to communicate product identification related to the parent element that contains this item.

BookClassification

BookClassification is optional. Multiple instances might exist.

Category under which the product or a component within the product is classified.

PrepContentOrderOfMatter

PrepContentOrderOfMatter is mandatory. One instance is required, multiple instances might exist.

Group element used to identify all of the necessary sequencing and pagination requirements for the component.

ContentOrderOfMatterHeader

Information that applies to the entire ContentOrderOfMatter e-Document.

(sequence)

The sequence of items below is mandatory. A single instance is required.

DocumentNumber

DocumentNumber mandatory. A single instance is required.

The unique identifier of a document.

DocumentIssueDate

DocumentIssueDate is mandatory. A single instance is required.

The date and time when the e-Document was issued.

DocumentVersionNumber

DocumentVersionNumber is optional. A single instance might exist.

The assigned version number of documents or other information items. For example version 2.12 of a price list on paper or the version number of a Measuring Information identified by a MeasuringNumber.

N.B. TransactionHistoryNumber keeps track of the version of a papiNet e-Document. A separate DocumentVersionNumber may also be assigned to an e-Document.

SenderParty

SenderParty is optional. A single instance might exist.

The business entity issuing the e-Document, the source of the document.

The entity responsible for the content. If the sender party has outsourced the message service to a third party the SenderParty is the issuer of the e-Document and not the party performing the transmission service of the electronic message.

ReceiverParty

ReceiverParty is optional. Multiple instances might exist.

The business entity for whom the e-Document is intended, the destination of the document.

The entity interested in the content. If the receiver party has outsourced the message service to a third party the ReceiverParty is the intended party for the e-Document and not the party performing the receiving service of the

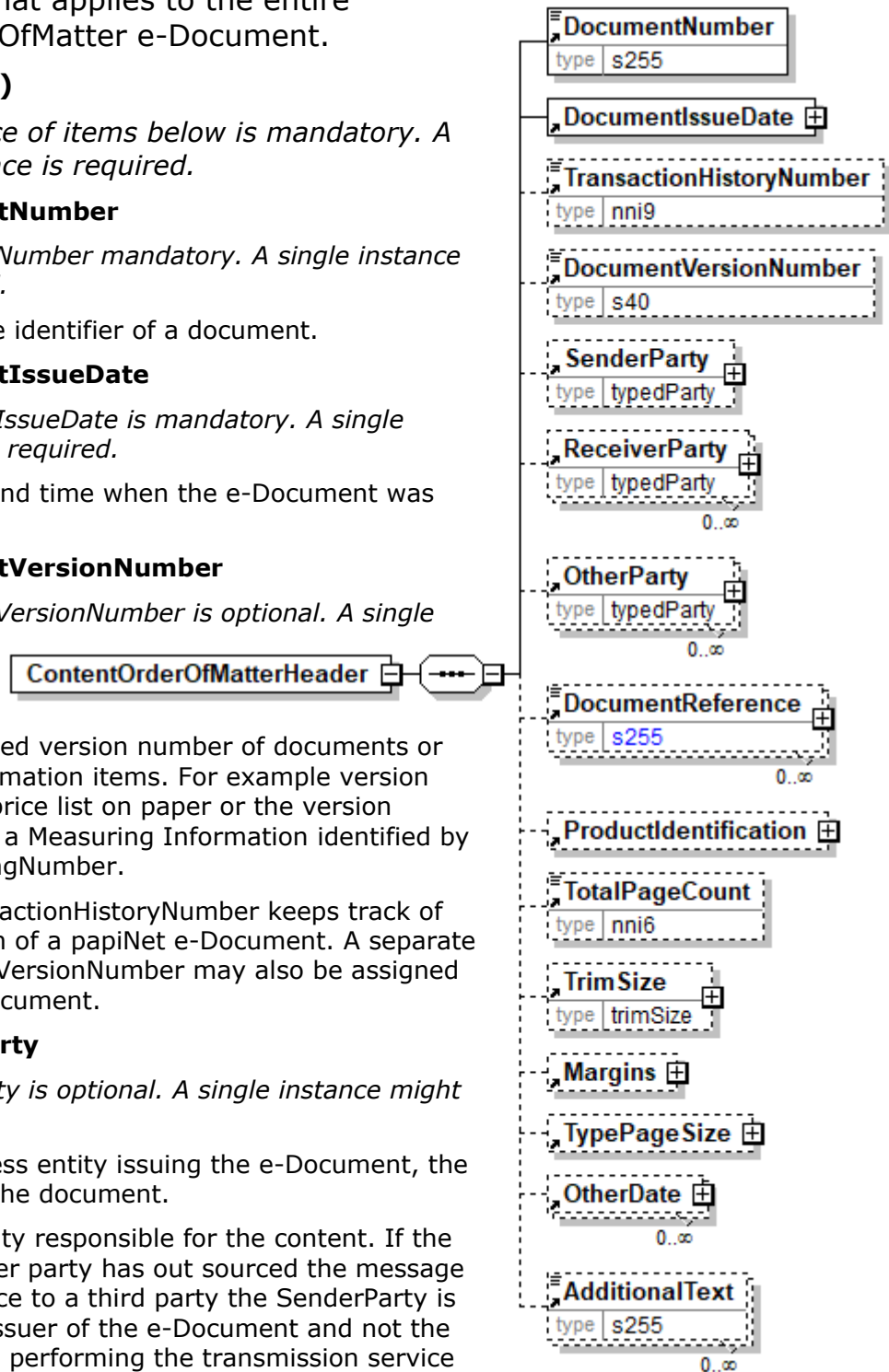

electronic message.

OtherParty

OtherParty is optional. Multiple instances might exist.

An organisation or business entity other than those specifically detailed within an e-Document.

DocumentReference

DocumentReference is optional. Multiple instances might exist.

An element detailing relevant references pertaining to the papiNet e-Document as indicated by the DocumentReferenceType and AssignedBy.

ProductIdentification

ProductIdentification is optional. A single instance might exist.

A grouping element designed to communicate product identification related to the parent element that contains this item.

TotalPageCount

TotalPageCount is optional. A single instance might exist.

Element used to communicate the book's approximate total number of pages within each unit of the book. Total page count is more or less a reference to the "size" of the book that the customer designates. For instance, they will refer to a book as 800 pages when in fact it is 792 actual text pages with 8 pages of various inserts. This value should not be used to drive any of the other values for the component parts, but may in fact be exactly equal to the number of pages in one of the components designated as "Text".

TrimSize

TrimSize is optional. A single instance might exist.

A grouping element designed to communicate the finished page size of the book product that includes the length, width, Bulk and Spine thickness elements.

Margins

Margins is optional. A single instance might exist.

A grouping element designed to communicate the size of the "white space" that surrounds the content of a page.

TypePageSize

TypePageSize is optional. A single instance might exist.

A grouping element designed to communicate the dimensions of the page content that includes the length and width elements.

OtherDate

OtherDate is optional. Multiple instances might exist.

A date that may not be specifically detailed within a document (example: print date at the PurchaseOrderLineItem).

AdditionalText

AdditionalText is optional. Multiple instances might exist.

A text field that is used to communicate information not previously defined or for special instructions. To be used only for circumstances not covered by specific elements.

ContentOrderOfMatterStatusType [attribute]

Identifies the status of the entire ContentOrderOfMatter e-Document.

This item is restricted to the following list.

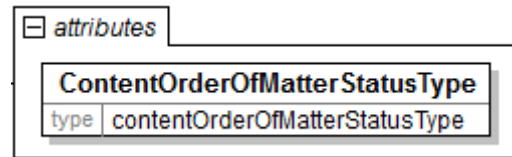

Cancelled

The supplied information has been cancelled. Items that have been cancelled are not included in totals on the summary levels of the e-Document.

Original

The supplied information is the first version of that information.

Replaced

The supplied information is replacing earlier supplied information. The receiver should revalidate the information in their system based upon the entire information received.

Contract

The Contract element is the root element for the Contract e-Document.

The Contract e-Document can be used by business partners to communicate business agreements. Contracts are managed by a ContractParty that normally is the seller or the buyer. The Contract e-Document can also be sent to service providers that need the contract information for carrying out their services.

ContractType [attribute]

ContractType is mandatory. A single instance is required.

ContractType defines the type of the Contract e-Document.

Refer to ContractType definition for any enumerations.

ContractStatusType [attribute]

ContractStatusType is mandatory. A single instance is required.

Identifies the status of the entire Contract e-Document.

Refer to ContractStatusType definition for any enumerations.

ContractContextType [attribute]

ContractContextType is mandatory. A single instance is required.

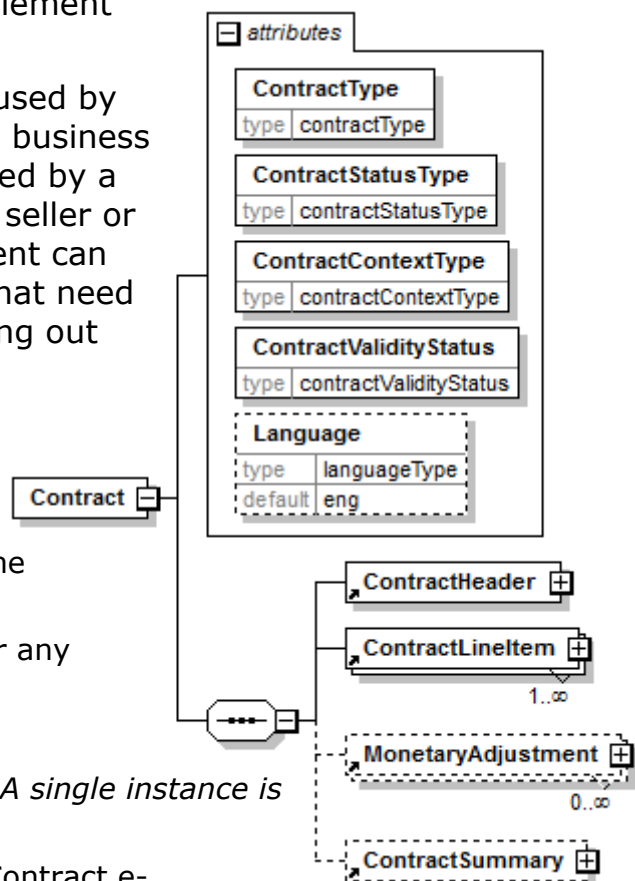

papiNet V2R31

Indicates the nature of what is included in the Contract e-Document.

Refer to ContractContextType definition for any enumerations.

ContractValidityStatus [attribute]

ContractValidityStatus is mandatory. A single instance is required.

The validity status for the Contract e-Document.

Refer to ContractValidityStatus definition for any enumerations.

Language [attribute]

Language is optional. A single instance might exist.

The valid Alpha 2- and Alpha 3-character list of language codes in the ISO 639-1 and 639-2 international standards.

Information on the content of this attribute is available at:

https://www.loc.gov/standards/iso639-2/php/code_list.php

(sequence)

The sequence of items below is mandatory. A single instance is required.

ContractHeader

ContractHeader is mandatory. A single instance is required.

The ContractHeader contains information common to the entire Contract e-Document.

ContractLineItem

ContractLineItem is mandatory. One instance is required, multiple instances might exist.

A grouping element that contains information for a line item of the Contract e-Document. The line item specifies detail information associated with a product.

MonetaryAdjustment

MonetaryAdjustment is optional. Multiple instances might exist.

The element containing the information necessary for the understanding, calculation, and treatment of an adjustment to a currency amount. MonetaryAdjustment contains an attribute that indicates they type of adjustment being communicated.

ContractSummary

ContractSummary is optional. A single instance might exist.

A grouping element that contains summary information that applies to the entire Contract e-Document.

ContractConditions

A grouping element that contains information about business conditions agreed for the contract.

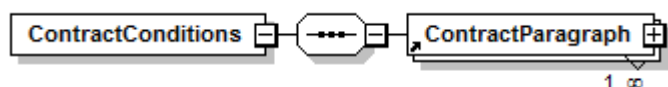

(sequence)

The sequence of items below is mandatory. A single instance is required.

ContractParagraph

ContractParagraph is mandatory. One instance is required, multiple instances might exist.

A grouping element that contains information about paragraphs of the contract.

ContractContextType [attribute]

Indicates the nature of what is included in the Contract e-Document.

This item is restricted to the following list.

LogisticsService

The contract is exclusively for logistics services.

Product

The contract is exclusively for product business.



ContractDate

The date when the business agreement was agreed.

(sequence)

The sequence of items below is mandatory. A single instance is required.

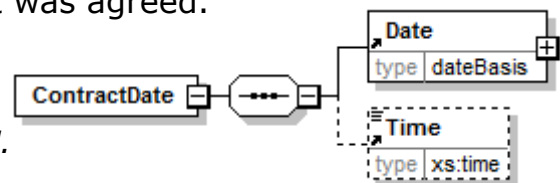

Date

Date is mandatory. A single instance is required.

A group element that contains the specification of Year, Month, and Day.

Time

Time is optional. A single instance might exist.

Times are treated in a standard XML fashion with a special case used to indicate a generalized "local" time. The standard XML approach to time is hh:mm:ss, hh:mm:ssZ, or hh:mm:ss±hh:mm.

hh:mm:ss±hh:mm is used to represent a time with a time zone. The time zone is communicated as the number of hours offset from the Universal Time Coordinate (UTC), a.k.a. Greenwich Mean Time.

hh:mm:ssZ indicates the time at Zulu (another name for UTC).

hh:mm:ss or hh:mm indicates within papiNet the applicable local time where the associated event is taking place. Caution should be used when processing times of this nature as the papiNet approach may be in discord with other users of XML.

ContractHeader

The ContractHeader contains information common to the entire Contract e-Document.

(sequence)

The sequence of items below is mandatory. A single instance is required.

DocumentNumber

DocumentNumber mandatory. A single instance is required.

The unique identifier of a papiNet e-Document.

DocumentIssueDate

DocumentIssueDate is mandatory. A single instance is required.

The date and time when the e-Document was issued.

TransactionHistoryNumber

TransactionHistoryNumber is optional. A single instance might exist.

A sequential number that keeps track of the version of a document.

However when the document is a confirmation document, in which case the

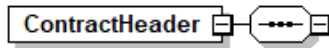

TransactionHistoryNumber refers to the trigger transaction for the confirmation.

ContractTitle

ContractTitle is optional. Multiple instances might exist.

A text describing the context of the contract.

SenderParty

SenderParty is optional. A single instance might exist.

The business entity issuing the e-Document, the source of the document.

The entity responsible for the content. If the sender party has out sourced the message service to a third party the SenderParty is the issuer of the e-Document and not the party performing the transmission service of the electronic message.

ReceiverParty

ReceiverParty is optional. Multiple instances might exist.

The business entity for whom the e-Document

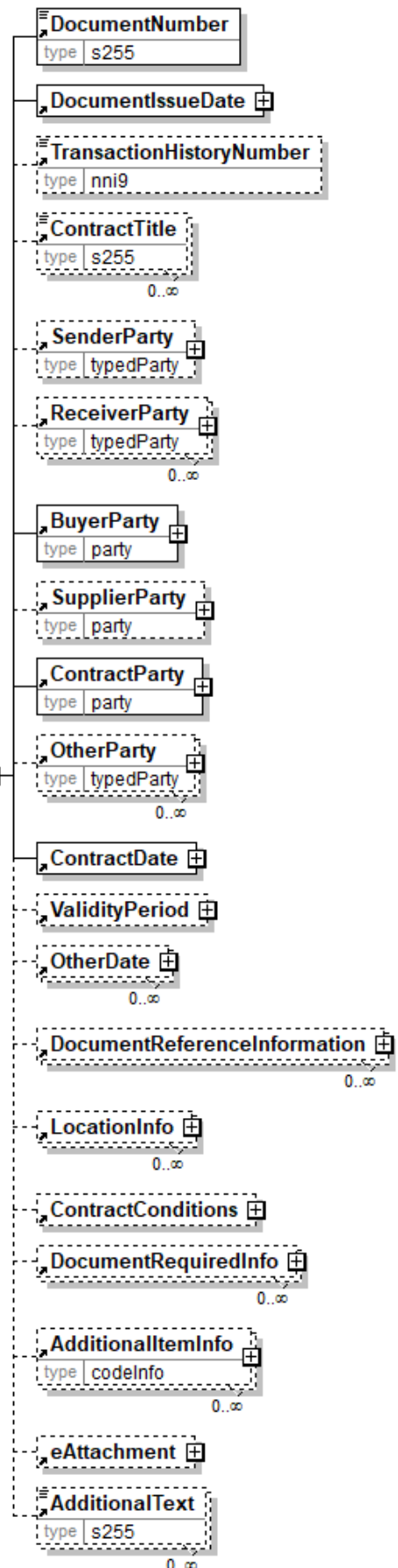

is intended, the destination of the document.

The entity interested in the content. If the receiver party has outsourced the message service to a third party the ReceiverParty is the intended party for the e-Document and not the party performing the receiving service of the electronic message.

BuyerParty

BuyerParty is mandatory. A single instance is required.

The legal entity to which the product is sold. Also commonly referred to as the sold-to party or customer. If no OtherParty is defined as the Payer, the Buyer is the Payer.

SupplierParty

SupplierParty is optional. A single instance might exist.

The organisation or business entity responsible for providing the product. SupplierParty is also the seller of the product, if Seller is not specified as OtherParty = Seller.

ContractParty

ContractParty is mandatory. A single instance is required.

The organisation or business entity responsible for managing the contract between business partners.

OtherParty

OtherParty is optional. Multiple instances might exist.

An organisation or business entity other than those specifically detailed within an e-Document.

ContractDate

ContractDate is mandatory. A single instance is required.

The date when the business agreement was agreed.

ValidityPeriod

ValidityPeriod is optional. A single instance might exist.

The validity period for a specific item, e.g. the validity period for an e-Document.

OtherDate

OtherDate is optional. Multiple instances might exist.

A date that may not be specifically detailed within a document (example: print date at the PurchaseOrderLineItem).

DocumentReferenceInformation

DocumentReferenceInformation is optional. Multiple instances might exist.

A group item containing reference information applicable to a document.

LocationInfo

LocationInfo is optional. Multiple instances might exist.

A grouping element that contains information about a geographical location.

ContractConditions

ContractConditions is optional. A single instance might exist.

A grouping element that contains information about business conditions agreed for the contract.

DocumentRequiredInfo

DocumentRequiredInfo is optional. Multiple instances might exist.

A group element that contains information about documents needed by parties in the business process.

AdditionalItemInfo

AdditionalItemInfo is optional. Multiple instances might exist.

A grouping element that contains information about additional items specified by an agency. Restricted use of this element is recommended.

eAttachment

eAttachment is optional. A single instance might exist.

eAttachment enables the sender to provide information about attachments to the document.

- Note: An element "e-Attachment" also exists. papiNet will no longer use hyphens in our element and attribute names as this causes issues with BizTalk.

AdditionalText

AdditionalText is optional. Multiple instances might exist.

A text field that is used to communicate information not previously defined or for special instructions. To be used only for circumstances not covered by specific elements.

ContractLineItem

A grouping element that contains information for a line item of the Contract e-Document. The line item specifies detail information associated with a product.

(sequence)

The sequence of items below is mandatory. A single instance is required.

ContractLineItemNumber

ContractLineItemNumber is mandatory. A single instance is required.

A sequential number that uniquely identifies the line item of the Contract e-Document.

Product

Product is mandatory. A single instance is required.

Product is a group item defining the article and its characteristics. Product is used to specify product characteristics organized by ProductIdentifier, ProductDescription, and Classification. Book Manufacturing, Forest Wood, Label Stock, Paper, Pulp, Recovered Paper, Wood Products, and Virgin Fibre market segments have defined their product characteristics and conversion features for implementation in papiNet.

DocumentReferenceInformation

DocumentReferenceInformation is optional. Multiple instances might exist.

A group item containing reference information applicable to a document.

PriceDetails

PriceDetails is optional. A single instance might exist.

An element that groups together price information.

QuantityInformation

QuantityInformation is optional. A single instance might exist.

A group item containing information about quantity and informational quantity of similar items.

BaseNetAmount

BaseNetAmount is optional. A single instance might exist.

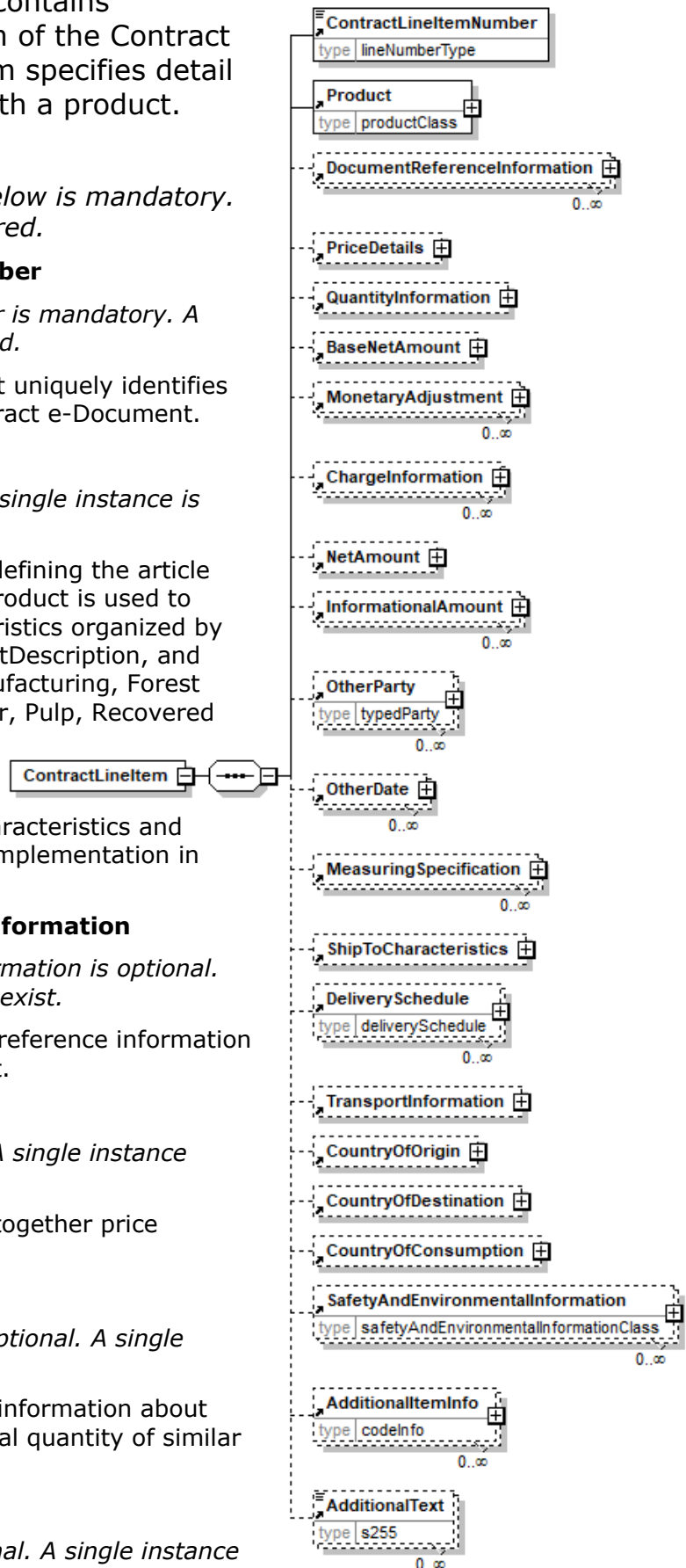

An element that contains the result of the calculation Quantity times the PricePerUnit. As such it does not include any taxes. The BaseNetAmount encapsulates CurrencyValue.

MonetaryAdjustment

MonetaryAdjustment is optional. Multiple instances might exist.

The element containing the information necessary for the understanding, calculation, and treatment of an adjustment to a currency amount. MonetaryAdjustment contains an attribute that indicates the type of adjustment being communicated.

ChargeInformation

ChargeInformation is optional. Multiple instances might exist.

A group element that contains elements that describe a charge. ChargeInformation is used when charge details need to be specified by using a code assigned by an agency. It is typically used for freight costs and other costs related to the supply chain.

NetAmount

NetAmount is optional. A single instance might exist.

An element that contains the net amount excluding tax. NetAmount encapsulates CurrencyValue.

InformationalAmount

InformationalAmount is optional. Multiple instances might exist.

A monetary amount used for information purposes only (not for calculation). For example, the invoice price adjustment subtotal is expressed in sterling pounds, and the buyer wants this information expressed in U.S. dollars.

CreditDebitNote and Invoice - The TaxAmount is displayed in the currency that is applicable throughout the e-Document. When a TaxAmount needs to be displayed in a different national currency, this field is used.

OtherParty

OtherParty is optional. Multiple instances might exist.

An organisation or business entity other than those specifically detailed within an e-Document.

OtherDate

OtherDate is optional. Multiple instances might exist.

A date that may not be specifically detailed within a document (example: print date at the PurchaseOrderLineItem).

MeasuringSpecification

MeasuringSpecification is optional. Multiple instances might exist.

A grouping element that contains a specification for measurement procedures for a measuring party at a measuring location.

ShipToCharacteristics

ShipToCharacteristics is optional. A single instance might exist.

A group item that provides information important for the Ship-To Party.

DeliverySchedule

DeliverySchedule is optional. Multiple instances might exist.

papiNet V2R31

A group item defining a series of DeliveryDateWindow(s) in which specified quantities must be delivered.

TransportInformation

TransportInformation is optional. A single instance might exist.

A grouping element for transport information.

CountryOfOrigin

CountryOfOrigin is optional. A single instance might exist.

The country of origin for the material.

CountryOfDestination

CountryOfDestination is optional. A single instance might exist.

The country where the goods will be, or were, shipped to.

CountryOfConsumption

CountryOfConsumption is optional. A single instance might exist.

The country of consumption for the material.

SafetyAndEnvironmentalInformation

SafetyAndEnvironmentalInformation is optional. Multiple instances might exist.

Name of certification type, if any, on the goods (For example, FSC, PEFC). SafetyAndEnvironmental needs a value or measurement to communicate the percentage of the product is certified (for example, 75% is certified by the indicated agency).

AdditionalItemInfo

AdditionalItemInfo is optional. Multiple instances might exist.

A grouping element that contains information about additional items specified by an agency. Restricted use of this element is recommended.

AdditionalText

AdditionalText is optional. Multiple instances might exist.

A text field that is used to communicate information not previously defined or for special instructions. To be used only for circumstances not covered by specific elements.

ContractLineItemNumber

A sequential number that uniquely identifies the line item of the Contract e-Document.

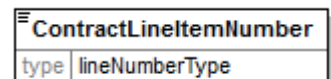

ContractParagraph

A grouping element that contains information about paragraphs of the contract.

(sequence)

The sequence of items below is mandatory. A

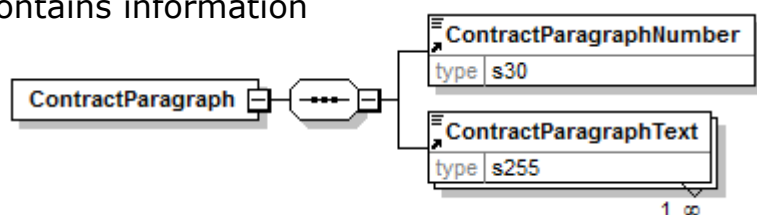

single instance is required.

ContractParagraphNumber

ContractParagraph is mandatory. One instance is required.

A sequential number that uniquely identifies the paragraph of the contract.

ContractParagraphText

ContractParagraphText is mandatory. One instance is required, multiple instances might exist.

A text that specifies a paragraph of the contract.

ContractParagraphNumber

A sequential number that uniquely identifies the paragraph of the contract.

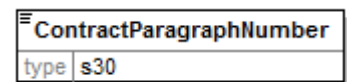

ContractParagraphText

A text that specifies a paragraph of the contract.

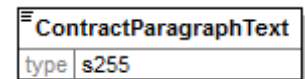

ContractParty

The organisation or business entity responsible for managing the contract between business partners.

LogisticsRole [attribute]

LogisticsRole is optional. A single instance might exist.

Communicates the nature of the logistics role, if any, the party plays in the transaction.

Refer to LogisticsRole definition for any enumerations.

(sequence)

The sequence of items below is mandatory. A single instance is required.

PartyIdentifier

PartyIdentifier is optional. Multiple instances might exist.

A unique identifier of a specific party. This element contains an attribute PartyIdentifierType that indicates the type of the identifier.

NameAddress

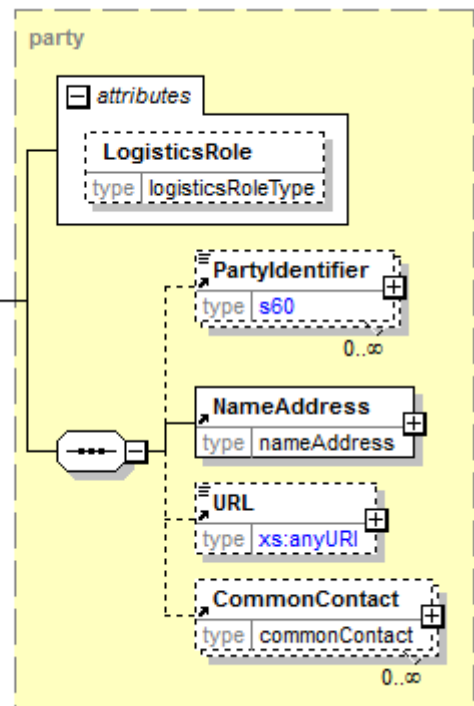
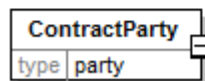

NameAddress is mandatory. A single instance is required.

A group item containing name and address of an organisation or business entity.

URL

URL is optional. A single instance might exist.

Universal Resource Locator. While typically a web address you could use this field to hold an email address.

CommonContact

CommonContact is optional. Multiple instances might exist.

Identifies a specific individual associated with the party.

ContractStatusType [attribute]

Identifies the status of the entire Contract e-Document

This item is restricted to the following list.

Cancelled

The supplied information has been cancelled.

Items that have been cancelled are not included in totals on the summary levels of the e-Document.

Original

The supplied information is the first version of that information.

Replaced

The supplied information is replacing earlier supplied information. The receiver should revalidate the information in their system based upon the entire information received.



ContractSummary

A grouping element that contains summary information that applies to the entire Contract e-Document.

(sequence)

The sequence of items below is mandatory. A single instance is required.

TotalNumberOfLineItems

TotalNumberOfLineItems is optional. A single instance might exist.

The total number of individual line items in the document, regardless of the status or type.

TotalQuantityInformation

TotalQuantityInformation is optional. A single instance might exist.

A group item containing information about the total quantity and total informational quantity of similar items in the document.

LineItemSubTotal

LineItemSubTotal is optional. A single instance might exist.

The total amount of all base amounts on e-Document line items. The base amount contains the result of the calculation quantity times the base unit price. As such it does not include any taxes. For example, in an Invoice LineItemSubTotal is equal to the sum of all InvoiceLineBaseAmount.

TotalAdjustments

TotalAdjustments is optional. A single instance might exist.

The CurrencyValue of TotalAdjustments contains the total of all adjustments and charges excluding tax. For example, in the Invoice TotalAdjustments is equal to the sum of the signed values of the MonetaryAdjustmentAmount for all instances of MonetaryAdjustment with PriceAdjustment and FlatAmountAdjustment and plus the sum of the signed values of the ChargeNetAmount for all instances of ChargeInformation.

TotalNetAmount

TotalNetAmount is optional. A single instance might exist.

A field containing total amount excluding tax. For example, in the Invoice TotalNetAmount is equal to the sum of LineItemSubTotal plus TotalAdjustments. TotalNetAmount encapsulates CurrencyValue.

InformationalAmount

InformationalAmount is optional. Multiple instances might exist.

A monetary amount used for information purposes only (not for calculation). For example, the invoice price adjustment subtotal is expressed in sterling pounds, and the buyer wants this information expressed in U.S. dollars.

CreditDebitNote and Invoice - The TaxAmount is displayed in the currency that is applicable throughout the e-Document. When a TaxAmount needs to be

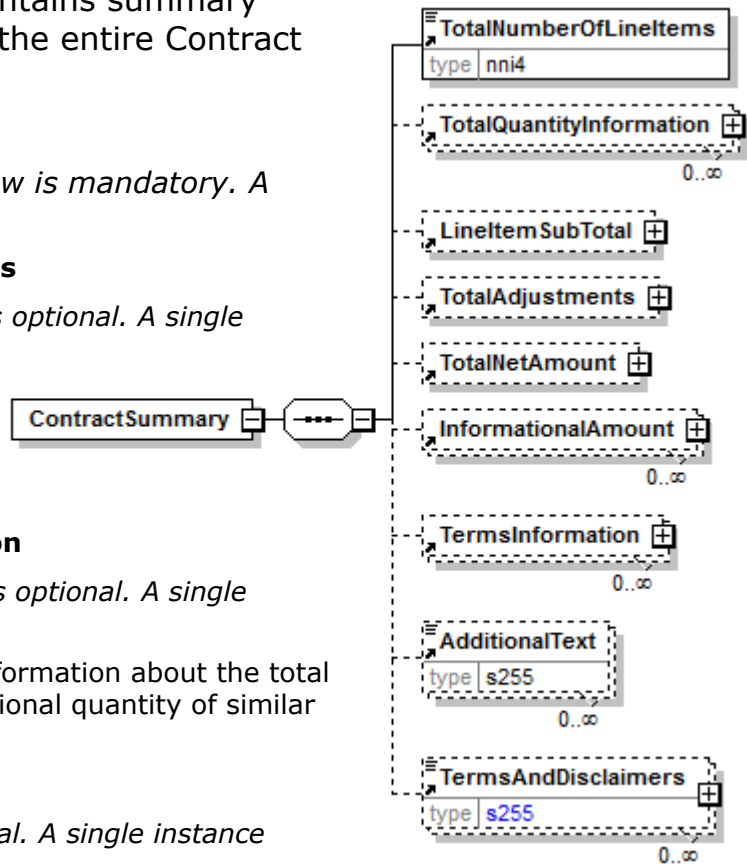

displayed in a different national currency, this field is used.

TermsInformation

TermsInformation is optional. Multiple instances might exist.

An element that contains the term related information.

AdditionalText

AdditionalText is optional. Multiple instances might exist.

A text field that is used to communicate information not previously defined or for special instructions. To be used only for circumstances not covered by specific elements.

TermsAndDisclaimers

TermsAndDisclaimers is optional. Multiple instances might exist.

An element that contains legal information with an indication of what the Language is.

ContractTitle

A text describing the context of the contract.



ContractType [attribute]

ContractType defines the type of the Contract e-Document.

This item is restricted to the following list.

OriginalContract

A contract between the first seller and the first buyer in a supply chain. For example a contract when a forest owner sells roundwood to a forest company.

TradingContract

A contract between a seller and a buyer, when products (or services specified as products) bought by the seller are resold to a buyer in a supply chain. For example a contract when a forest company sells roundwood bought from a forest owner or another forest company to a buyer.



ContractValidityStatus [attribute]

The validity status for the Contract e-Document.

This item is restricted to the following list.

Active

The contract is active. Business transactions can be executed with reference to the contract during the validity period.

Closed



The contract is terminated or completed. Business transactions cannot be executed with reference to the contract.

Pending

The contract is preliminary or unfinished. Business transactions cannot be executed with reference to the contract.

ConversionCode

A code, as assigned by an Agency, used to identify a group of conversion characteristics.

Agency [attribute]

Agency is mandatory. A single instance is required.

Describes the agency maintaining the list of codes. To be included in this list the agency must be a recognized standards body or industry organisation.

- For the element that owns this attribute.
- For another attribute in the list of attributes associated with the parent element.

Refer to Agency definition for any enumerations.

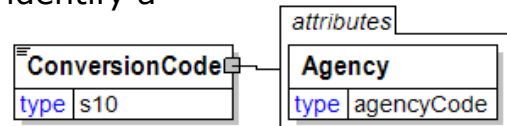

CoordinateDisplayOrder [attribute]

A sequential number that controls the order for how multiple coordinates are processed and displayed on maps by map applications, e.g. for a MapPoint of type LinePoint how coordinates are connected together to form a line on a map.

Coordinates are processed and displayed in consecutive order if CoordinateDisplayOrder is not given.



CoordinateFormatType [attribute]

CoordinateFormatType defines the format of the string containing the coordinates.

This item is restricted to the following list.

Degrees

Latitude and longitude given in decimal degrees according to ISO Standard 6709. Format: $\pm DD.DDDD \pm DDD.DDDD$ where

$\pm DD$ = three-digit integer degrees part of latitude
(through -90 ~ -00 ~ +90)

$\pm DDD$ = four-digit integer degrees part of longitude
(through -180 ~ -000 ~ +180)

.DDDD = variable-length fraction part in degrees

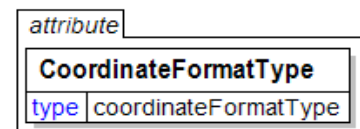

papiNet V2R31

Latitude comes before longitude. North latitude is positive and south latitude is negative. East longitude is positive and west longitude is negative. Plus and minus signs in the format must be supplied. The integer part is a fixed length respectively. Padding character is "0".

For example <Coordinates CoordinateFormatType="Degrees">+60.062893+018.595290</Coordinates>

More info at

http://www.iso.org/iso/home/store/catalogue_tc/catalogue_detail.htm?csnumber=39242

DegreesMinutes

Latitude and Longitude given in degrees and decimal minutes according to ISO Standard 6709. Format: $\pm DDMM.MMMM \pm DDDMM.MMMM$ where

- $\pm DD$ = three-digit integer degrees part of latitude (through -90 ~ -00 ~ +90)
- $\pm DDD$ = four-digit integer degrees part of longitude (through -180 ~ -000 ~ +180)
- MM = two-digit integer minutes part (00 through 59)
- .MMMM = variable-length fraction part in minutes

Latitude comes before longitude. North latitude is positive and south latitude is negative. East longitude is positive and west longitude is negative. Plus and minus signs in the format must be supplied. The integer part is a fixed length respectively. Padding character is "0".

For example <Coordinates CoordinateFormatType="DegreesMinutes">+6003.77358+01835.7174</Coordinates>

More info at

http://www.iso.org/iso/home/store/catalogue_tc/catalogue_detail.htm?csnumber=39242

DegreesMinutesSeconds

Latitude and Longitude given in degrees, minutes and decimal seconds according to ISO Standard 6709.

Format: $\pm DDMMSS.SSSS \pm DDDMMSS.SSSS$ where

- $\pm DD$ = three-digit integer degrees part of latitude (through -90 ~ -00 ~ +90)
- $\pm DDD$ = four-digit integer degrees part of longitude (through -180 ~ -000 ~ +180)
- MM = two-digit integer minutes part (00 through 59)
- SS = two-digit integer seconds part (00 through 59)
- .SSSS = variable-length fraction part in seconds

Latitude comes before longitude. North latitude is positive and south latitude is negative. East longitude is positive and west longitude is negative. Plus and minus signs in the format must be supplied. The integer part is a fixed length respectively. Padding character is "0".

For example <Coordinates CoordinateFormatType=

"DegreesMinutesSeconds">+600346.4148+0183543.0440"</Coordinates>

More info at

http://www.iso.org/iso/home/store/catalogue_tc/catalogue_detail.htm?csnumber=39242

XY

X- and Y- coordinates separated by the space character.

ZoneXY

Zone, X- and Y- coordinates separated by space characters.

Coordinates

Contains the position coordinates of a location.

CoordinateFormatType [attribute]

CoordinateFormatType is mandatory. A single instance is required.

CoordinateFormatType defines the format of the string containing the coordinates.

Refer to CoordinateFormatType definition for any enumerations.

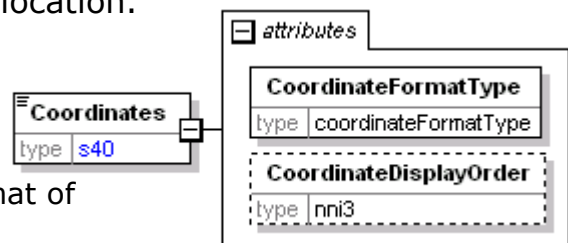

CoordinateDisplayOrder

CoordinateDisplayOrder is optional. A single instance might exist.

A sequential number that controls the order for how multiple coordinates are processed and displayed on maps by map applications, e.g. for a MapPoint of type LinePoint how coordinates are connected together to form a line on a map. Coordinates are processed and displayed in consecutive order if CoordinateDisplayOrder is not given.

CoreCharacteristics

A group item that details information used to fully define a core.

CoreEndType [attribute]

CoreEndType is optional. A single instance might exist.

Describes how the core ends are made.

Refer to CoreEndType definition for any enumerations.

CoreMaterialType [attribute]

CoreMaterialType is optional. A single instance might exist.

Specifies the material out of which the core is made.

Refer to CoreMaterialType definition for any

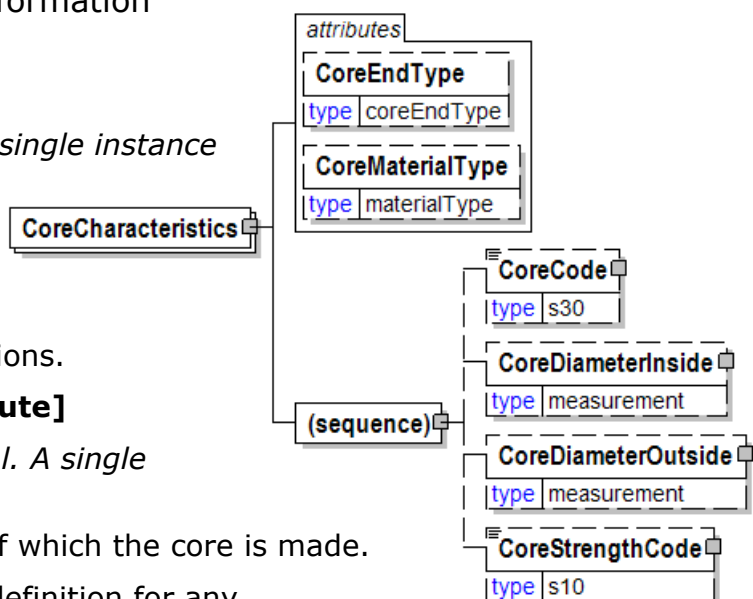

enumerations.

(sequence)

The sequence of items below is mandatory. A single instance is required.

CoreCode

CoreCode is optional. A single instance might exist.

A code defining details for a core

CoreDiameterInside

CoreDiameterInside is optional. A single instance might exist.

The diameter of the core's inner circle.

CoreDiameterOutside

CoreDiameterOutside is optional. A single instance might exist.

The diameter of the core's outer circle.

CoreStrengthCode

CoreStrengthCode is optional. A single instance might exist.

CoreStrengthCode is a composite of critical speed, flexural and crush strength of a fibre core, as defined by the indicated Agency.

CoreCode

A code defining details for a core

Agency [attribute]

Agency is mandatory. A single instance is required.

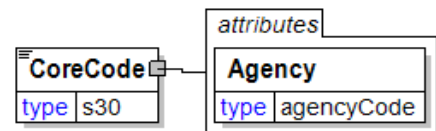

Describes the agency maintaining the list of codes. To be included in this list the agency must be a recognized standards body or industry organisation.

- For the element that owns this attribute.
- For another attribute in the list of attributes associated with the parent element.

Refer to Agency definition for any enumerations.

CoreDiameterInside

The diameter of the core's inner circle.

(sequence)

The sequence of items below is mandatory. A single instance is required.

Value

Value is mandatory. A single instance is required.

A numeric value expressed in the unit of measure (UOM).

RangeMin

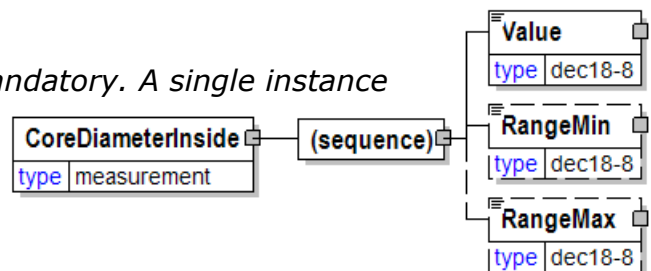

papiNet V2R31

RangeMin is optional. A single instance might exist.

The minimum value (lower boundary) allowed for the Measurement that is the parent of this element.

RangeMax

RangeMax is optional. A single instance might exist.

The maximum value (upper boundary) allowed for the Measurement that is the parent of this element. Some elements use the RangeMax element with an extended list of unit of measures. (Note: the red colour in the picture is an artifact of how the graphic was captured and should be disregarded.)

CoreDiameterOutside

The diameter of the core's outer circle.

(sequence)

The sequence of items below is mandatory. A single instance is required.

Value

Value is mandatory. A single instance is required.

A numeric value expressed in the unit of measure (UOM).

RangeMin

RangeMin is optional. A single instance might exist.

The minimum value (lower boundary) allowed for the Measurement that is the parent of this element.

RangeMax

RangeMax is optional. A single instance might exist.

The maximum value (upper boundary) allowed for the Measurement that is the parent of this element. Some elements use the RangeMax element with an extended list of unit of measures. (Note: the red colour in the picture is an artifact of how the graphic was captured and should be disregarded.)

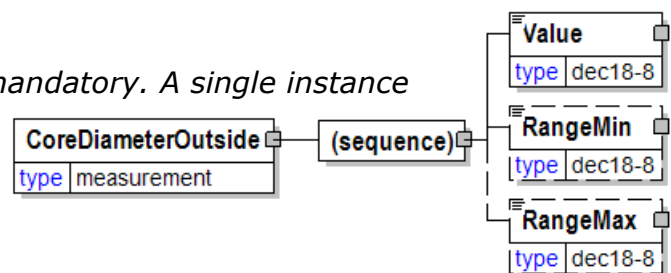

CoreEndType [attribute]

Describes how the core ends are made.

This item is restricted to the following list.

Adaptor

The Adaptor type is where the end type is adaptable to a 6 inch or 3 inch core diameter. (Spelling validated with core manufacturers.)

Bevelled

The core end is beveled. A grinding wheel has been used to grind down the inside of the core right at the end to enable an easier mounting of the core onto the shaft or the chucks. This is also called a beveled end cut. (Improper spelling noted but will be retained as enumeration choice for backward compatibility.)

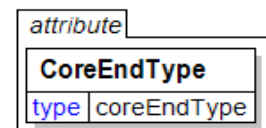

papiNet V2R31

Bridge

The core end has a notch that is cut on the inside of the core that is tapered and does not go through the core to edge; this is done so the core can be grasped by a particular type of core chuck on a reel arm on a press. Similar to a tapered core.

HalfMetal

The core is half metal.

Notched

The core end has a notch. Notch can be used to drive the core by the press operator or by manufacturing.

NotchedFullMetal

The core end has a notch. Core end is reinforced with metal cap.

Plain

The core end is smooth, not notched.

PlainFullMetal

The core end has no notch; end is reinforced with a metal tip.

Tapered

The core end is tapered.

CoreMaterialType [attribute]

Specifies the material out of which the core is made.

This item is restricted to the following list.



Aluminium

The reel core is made of aluminium.

Composite

The reel core is made up of a composite of materials, not entirely of fibre content.

Fibre

The reel core is made of fibre.

Iron

The reel core is made of iron.

Paper

The reel core is made of paper.

Plastic

The reel core is made of plastic.

Steel

The reel core is made of steel.

CorePlugs

An element that indicates if plugs are to be inserted into the ends of the core. Core plugs can be made of various materials and are used to protect the core ends.

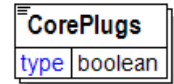

Note: A conversion error took place between Version 1.0 of papiNet and Version 2.0 of papiNet and this item was inadvertently converted from true/false (1.0) to nni1 (2.0). this item has been reinstated to a boolean value. However, please note that for reasons of backward compatibility it is highly recommended that you use the 1/0 approach to communicating true or false where 1 = true and 0 = false. Our apologies for any issues.

CoreStrengthCode

CoreStrengthCode is a composite of critical speed, flexural and crush strength of a fibre core, as defined by the indicated Agency.

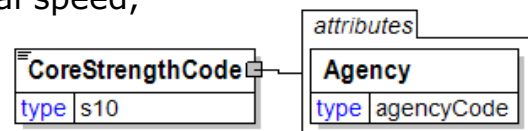

Agency [attribute]

Agency is mandatory. A single instance is required.

Describes the agency maintaining the list of codes. To be included in this list the agency must be a recognized standards body or industry organisation.

- For the element that owns this attribute.
- For another attribute in the list of attributes associated with the parent element.

Refer to Agency definition for any enumerations.

CorrectiveAction

This element enables the party issuing the ComplaintResponse (i.e. SupplierParty) to specify what is the corrective action they will take in order to close the Complaint (send a credit, send disposition instructions, etc.)

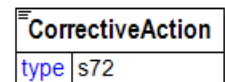

CostComponent

A group item that contains information for specifying a cost component by a code assigned by an agency.

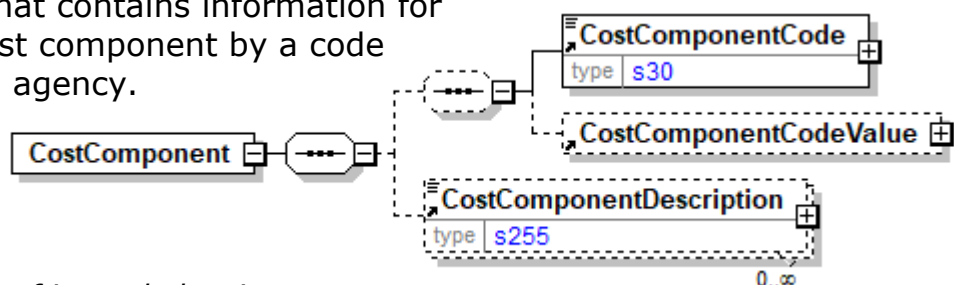

(sequence)

The sequence of items below is

mandatory. A single instance is required.

(sequence)

The sequence of items below is optional. A single instance might exist.

CostComponentCode

CostComponentCode is mandatory. A single instance is required.

An element that communicates a code for the cost component.

CostComponentCodeValue

CostComponentCodeValue is optional. A single instance might exist.

A grouping element specifying a value belonging to a cost component code.

CostComponentDescription

CostComponentDescription is optional. Multiple instances might exist.

The description of the cost component. When a CostComponentCode is associated with a CostComponentCodeValue of type TextValue, then the CostComponentDescription is a textual description of both the CostComponentCode and the TextValue.

CostComponentCode

An element that communicates a code for the cost component.

Agency [attribute]

Agency is mandatory. A single instance is required.

Describes the agency maintaining the list of codes. To be included in this list the agency must be a recognized standards body or industry organisation.

- For the element that owns this attribute.
- For another attribute in the list of attributes associated with the parent element.

Refer to Agency definition for any enumerations.

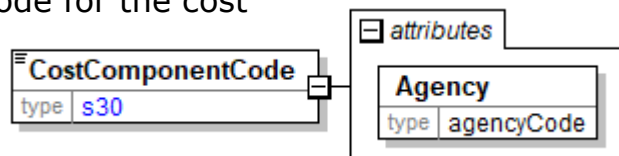

CostComponentCodeValue

A grouping element specifying a value belonging to a cost component code.

(choice)

[choice] is mandatory. A single instance is required.

NumericValue

NumericValue is mandatory. A single instance is required.

A grouping element for a numeric value and its statistical measures.

TextValue

TextValue is mandatory. A single instance is required.

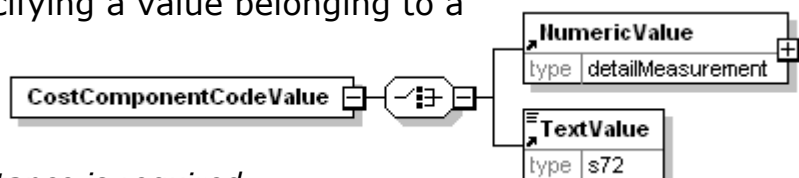

A value in text format.

CostComponentDescription

The description of the cost component. When a CostComponentCode is associated with a CostComponentCodeValue of type TextValue, then the CostComponentDescription is a textual description of both the CostComponentCode and the TextValue.

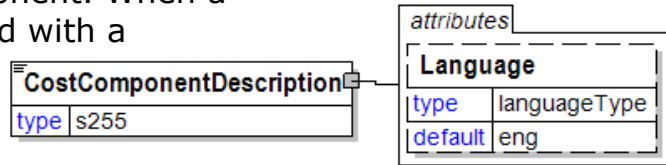

Language [attribute]

Language is optional. A single instance might exist.

The valid Alpha 2- and Alpha 3-character list of language codes in the ISO 639-1 and 639-2 international standards.

Information on the content of this attribute is available at:
https://www.loc.gov/standards/iso639-2/php/code_list.php

Country

The name of the country associated with the address elements. To ensure reliable matching of addresses, it is suggested to use the attribute ISOCountryCode as well.

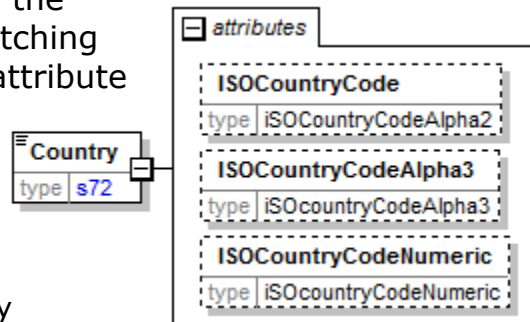

ISOCountryCode [attribute]

ISOCountryCode is optional. A single instance might exist.

The valid Alpha 2-character list of officially assigned country codes in the ISO 3166-1 international standard.

Information on the content of this attribute is available at:
<https://www.iso.org/obp/ui/#search>

ISOCountryCodeAlpha3 [attribute]

ISOCountryCodeAlpha3 is optional. A single instance might exist.

The valid Alpha 3-character list of officially assigned country codes in the ISO 3166-1 international standard.

Information on the content of this attribute is available at:
<https://www.iso.org/obp/ui/#search>

ISOCountryCodeNumeric [attribute]

ISOCountryCodeNumeric is optional. A single instance might exist.

The valid Numeric 3-digit list of officially assigned country codes in the ISO 3166-1 international standard.

Information on the content of this attribute is available at:
<https://www.iso.org/obp/ui/#search>

CountryAssociatedWithProduct

Specifies the country associated with the product.

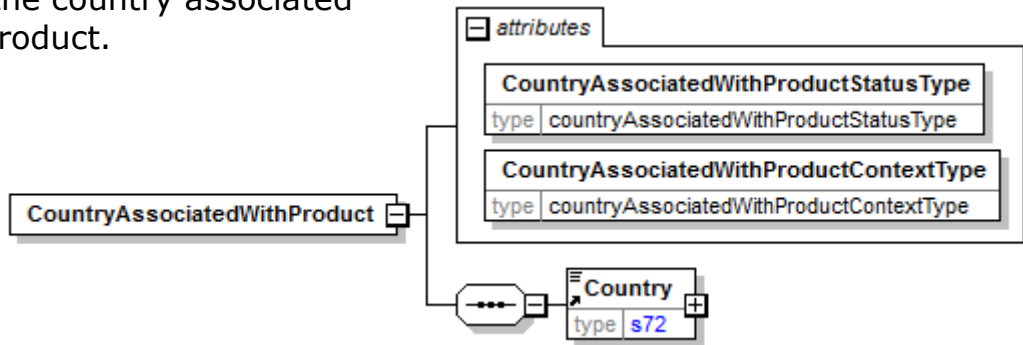

CountryAssociatedWithProductStatusType [attribute]

CountryAssociatedWithProductStatusType is mandatory. A single instance is required.

Specifies the status type of the country associated with the product.

Refer to CountryAssociatedWithProductStatusType definition for any enumerations.

CountryAssociatedWithProductContextType [attribute]

CountryAssociatedWithProductContextType is mandatory. A single instance is required.

Specifies in what context the country is associated with the product.

Refer to CountryAssociatedWithProductContextType definition for any enumerations.

(sequence)

The sequence of items below is mandatory. A single instance is required.

Country

Country is mandatory. A single instance is required.

The name of the country associated with the address elements. To ensure reliable matching of addresses, it is suggested to use the attribute ISOCountryCode as well.

CountryAssociatedWithProductContextType [attribute]

Specifies in what context the country is associated with the product.

This item is restricted to the following list.



Distribution

Country in which the product is distributed.

Manufacture

Country in which the product is manufactured. Manufacture is the process of procuring raw materials from outside to make the final product process;

conversion of raw materials into finished product by using various processes, machines and energy.

Production

Country in which the product is produced. Production is the process of converting inputs into outputs through various operations without procuring raw materials from the outside.

Publication

Country in which the product is published.

CountryAssociatedWithProductStatusType [attribute]

Specifies the status type of the country associated with the product.

This item is restricted to the following list.



CurrentCountry:

Country in which the product is being produced, published, manufactured or distributed.

OriginalCountry:

Country in which the product was originally produced, published, manufactured or distributed.

CountryOfConsumption

The country of consumption for the material.

(sequence)

The sequence of items below is mandatory. A single instance is required.

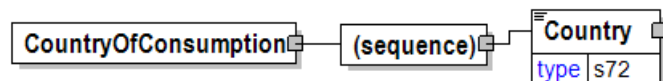

Country

Country is mandatory. A single instance is required.

The name of the country associated with the address elements. To ensure reliable matching of addresses, it is suggested to use the attribute ISOCountryCode as well.

CountryOfDestination

The country where the goods will be, or were, shipped to.

(sequence)

The sequence of items below is mandatory. A single instance is required.

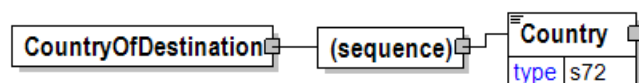

Country

Country is mandatory. A single instance is required.

The name of the country associated with the address elements. To ensure reliable matching of addresses, it is suggested to use the attribute ISOCountryCode as well.

CountryOfOrigin

The country of origin for the material.

(sequence)

The sequence of items below is mandatory. A single instance is required.

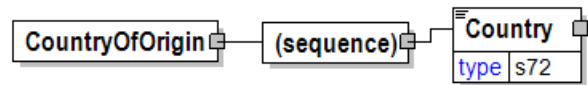

Country

Country is mandatory. A single instance is required.

The name of the country associated with the address elements. To ensure reliable matching of addresses, it is suggested to use the attribute ISOCountryCode as well.

County

The name of the county that the address is in.

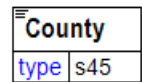

CreditDebitNote

The CreditDebitNote element is the root element for the CreditDebitNote e-Document.

The CreditDebitNote e-Document is generally used by the SupplierParty to compensate or charge the trading parties (ShipToParty, BuyerParty, OtherParty, etc.) for matters outside the scope of the Invoice.

CreditDebitNote e-Document will be deprecated in a future version V3R00 and should not be used in new implementations. Use instead Invoice e-Document with attribute InvoiceType having enumerations CreditNote or DebitNote.

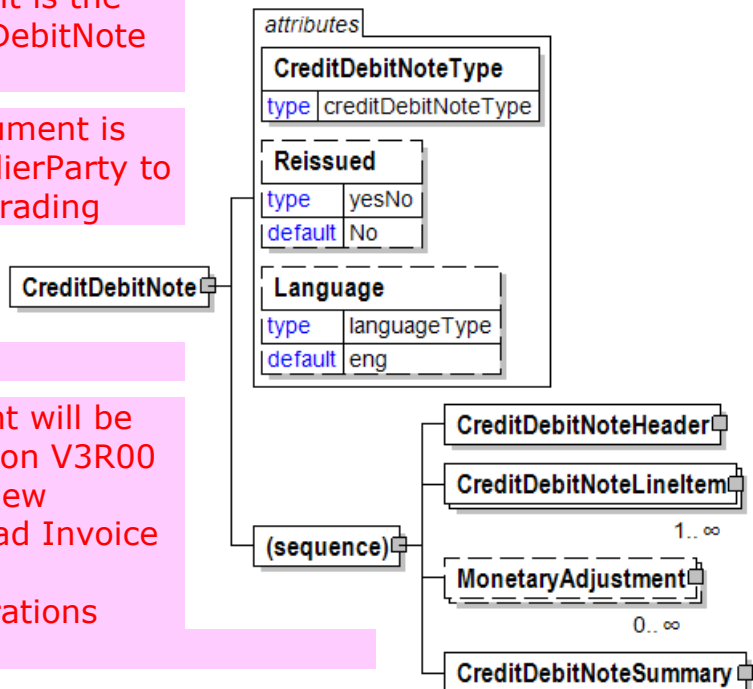

CreditDebitNoteType [attribute]

CreditDebitNoteType is mandatory. A single instance is required.

Defines the type of the CreditDebitNote e-Document. There are two types of CreditDebitNote Messages:

Refer to CreditDebitNoteType definition for any enumerations.

Reissued [attribute]

Reissued is optional. A single instance might exist.

Either "Yes" or "No".

Refer to Reissued definition for any enumerations.

Language [attribute]

Language is optional. A single instance might exist.

The valid Alpha 2- and Alpha 3-character list of language codes in the ISO 639-1 and 639-2 international standards.

Information on the content of this attribute is available at:
https://www.loc.gov/standards/iso639-2/php/code_list.php

(sequence)

The sequence of items below is mandatory. A single instance is required.

CreditDebitNoteHeader

CreditDebitNoteHeader is mandatory. A single instance is required.

The CreditDebitNoteHeader contains information common to the CreditDebitNote

CreditDebitNoteLineItem

CreditDebitNoteLineItem is mandatory. One instance is required, multiple instances might exist.

CreditDebitLineItem contains the information about the Credit or Debit being issued.

MonetaryAdjustment

MonetaryAdjustment is optional. Multiple instances might exist.

The element containing the information necessary for the understanding, calculation, and treatment of an adjustment to a currency amount. MonetaryAdjustment contains an attribute that indicates they type of adjustment being communicated.

CreditDebitNoteSummary

CreditDebitNoteSummary is mandatory. A single instance is required.

Contains summary information that applies to the entire e-Document.

CreditDebitNoteAmountSubtotal

A field that contains the result of the calculation Quantity at the

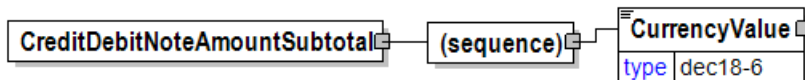

CreditDebitNoteLineItem level times the PricePerUnit.

(sequence)

The sequence of items below is mandatory. A single instance is required.

CurrencyValue

CurrencyValue is mandatory. A single instance is required.

The amount in the referenced currency as defined by the CurrencyType attribute.

CreditDebitNoteBaseAmountInformation

A group item containing the price per unit and the CreditDebitNote amount subtotal.

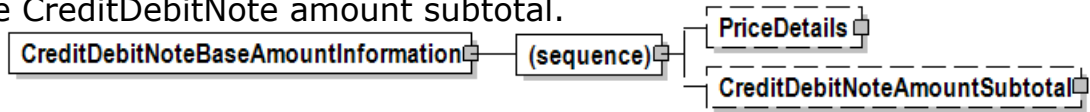

(sequence)

The sequence of items below is mandatory. A single instance is required.

PriceDetails

PriceDetails is optional. A single instance might exist.

An element that groups together price information.

CreditDebitNoteAmountSubtotal

CreditDebitNoteAmountSubtotal is optional. A single instance might exist.

A field that contains the result of the calculation Quantity at the CreditDebitNoteLineItem level times the PricePerUnit.

CreditDebitNoteDate

The issue date of the CreditDebitNote. This date often drives payment terms. Note that this date is not necessarily the same as the creation date of the CreditDebitNote.

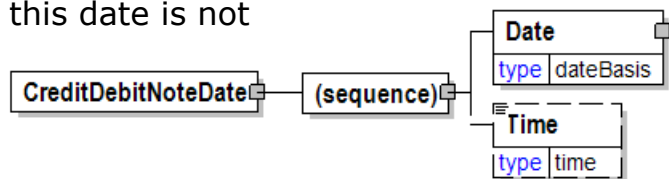

(sequence)

The sequence of items below is mandatory. A single instance is required.

Date

Date is mandatory. A single instance is required.

A group element that contains the specification of Year, Month, and Day.

Time

Time is optional. A single instance might exist.

Times are treated in a standard XML fashion with a special case used to indicate a generalized "local" time. The standard XML approach to time is hh:mm:ss, hh:mm:ssZ, or hh:mm:ss±hh:mm.

hh:mm:ss±hh:mm is used to represent a time with a time zone. The time zone is communicated as the number of hours offset from the Universal Time Coordinate (UTC), a.k.a. Greenwich Mean Time.

hh:mm:ssZ indicates the time at Zulu (another name for UTC).

hh:mm:ss or hh:mm indicates within papiNet the applicable local time where the associated event is taking place. Caution should be used when processing times of this nature as the papiNet approach may be in discord with other users of XML.

CreditDebitNoteHeader

The CreditDebitNoteHeader contains information common to the CreditDebitNote

(sequence)

The sequence of items below is mandatory. A single instance is required.

CreditDebitNoteNumber

CreditDebitNoteNumber is mandatory. A single instance is required.

The unique CreditDebitNote identifier as agreed to by the trading partners.

CreditDebitNoteDate

CreditDebitNoteDate is mandatory. A single instance is required.

The issue date of the CreditDebitNote. This date often drives payment terms. Note that this date is not necessarily the same as the creation date of the CreditDebitNote.

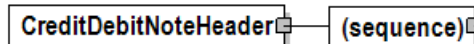

CreditDebitNoteReference

CreditDebitNoteReference is optional. Multiple instances might exist.

An element detailing relevant references pertaining to the CreditDebitNote. CreditDebitNoteReference uses the CreditDebitNoteReferenceType attribute.

CreditDebitNoteReason

CreditDebitNoteReason is mandatory. A single instance is required.

A group item containing the reason for the entire CreditDebitNote.

BillToParty

BillToParty is mandatory. A single instance is required.

The address where the Invoice is to be sent.

SupplierParty

SupplierParty is mandatory. A single instance is required.

The organisation or business entity responsible for providing the product. SupplierParty is also the seller of the product, if Seller is not specified as OtherParty = Seller.

BuyerParty

BuyerParty is optional. A single instance might exist.

The legal entity to which the product is sold. Also commonly referred to as the sold-to party or customer. If no OtherParty is defined as the Payer, the Buyer is the Payer.

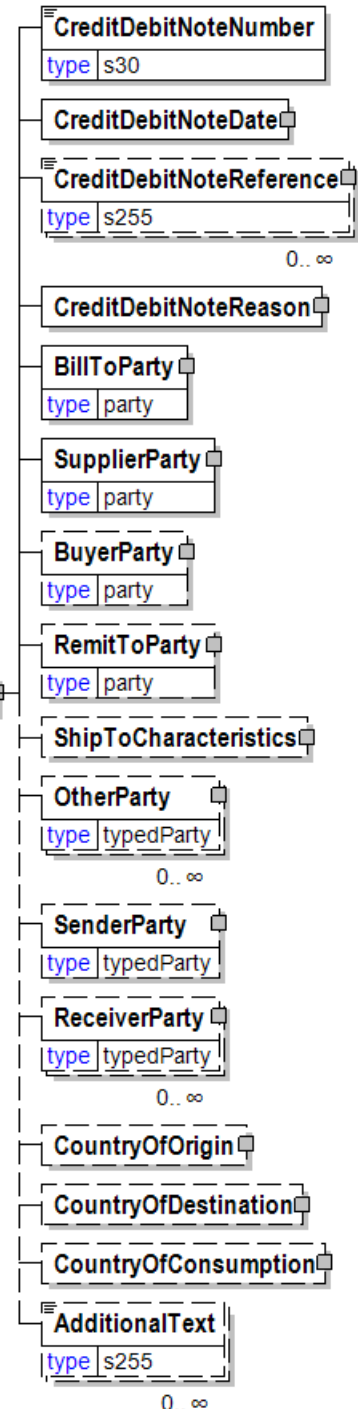

RemitToParty

RemitToParty is optional. A single instance might exist.

A group item containing details of the party to whom payment will be made. The RemitToParty contains all information related to remittance.

ShipToCharacteristics

ShipToCharacteristics is optional. A single instance might exist.

A group item that provides information important for the Ship-To Party.

OtherParty

OtherParty is optional. Multiple instances might exist.

An organisation or business entity other than those specifically detailed within an e-Document.

SenderParty

SenderParty is optional. A single instance might exist.

The business entity issuing the e-Document, the source of the document.

The entity responsible for the content. If the sender party has out sourced the message service to a third party the SenderParty is the issuer of the e-Document and not the party performing the transmission service of the electronic message.

ReceiverParty

ReceiverParty is optional. Multiple instances might exist.

The business entity for whom the e-Document is intended, the destination of the document.

The entity interested in the content. If the receiver party has outsourced the message service to a third party the ReceiverParty is the intended party for the e-Document and not the party performing the receiving service of the electronic message.

CountryOfOrigin

CountryOfOrigin is optional. A single instance might exist.

The country of origin for the material.

CountryOfDestination

CountryOfDestination is optional. A single instance might exist.

The country where the goods will be, or were, shipped to.

CountryOfConsumption

CountryOfConsumption is optional. A single instance might exist.

The country of consumption for the material.

AdditionalText

AdditionalText is optional. Multiple instances might exist.

A text field that is used to communicate information not previously defined or for special instructions. To be used only for circumstances not covered by specific elements.

CreditDebitNoteLineAmount

The total CreditDebitNote amount per line (includes adjustments and tax)

(sequence)

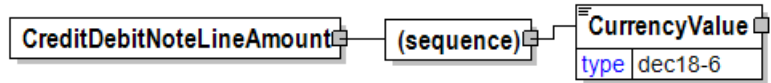

The sequence of items below is mandatory. A single instance is required.

CurrencyValue

CurrencyValue is mandatory. A single instance is required.

The amount in the referenced currency as defined by the CurrencyType attribute.

CreditDebitNoteLineItem

CreditDebitLineItem contains the information about the Credit or Debit being issued.

(sequence)

The sequence of items below is mandatory. A single instance is required.

CreditDebitNoteLineItemNumber

CreditDebitNoteLineItemNumber is mandatory. A single instance is required.

A sequential number that uniquely identifies the CreditDebitNote line item.

(sequence)

The sequence of items below is optional. Multiple instances might exist.

PurchaseOrderInformation

PurchaseOrderInformation is mandatory. A single instance is required.

A group item containing information unique to this PurchaseOrder, which is provided by the buyer.

PurchaseOrderInformation can be optional in the supply chain. Invoices are created without having a PurchaseOrder in Vendor Managed Inventory. Freight invoices also will not have a PurchaseOrder number.

PurchaseOrderLineItemNumber

PurchaseOrderLineItemNumber is optional. Multiple instances might exist.

The sequential number that uniquely identifies the PurchaseOrder line item.

ChargeOrAllowance

ChargeOrAllowance is optional. A single instance might exist.

The description of the charge or allowance; such as freight, special handling, and stop-off handling.

Product

Product is optional. A single instance might exist.

Product is a group item defining the article and its characteristics. Product is used to specify product characteristics organized by ProductIdentifier, ProductDescription, and Classification. Book Manufacturing, Label Stock, Paper, Pulp, Recovered Paper,

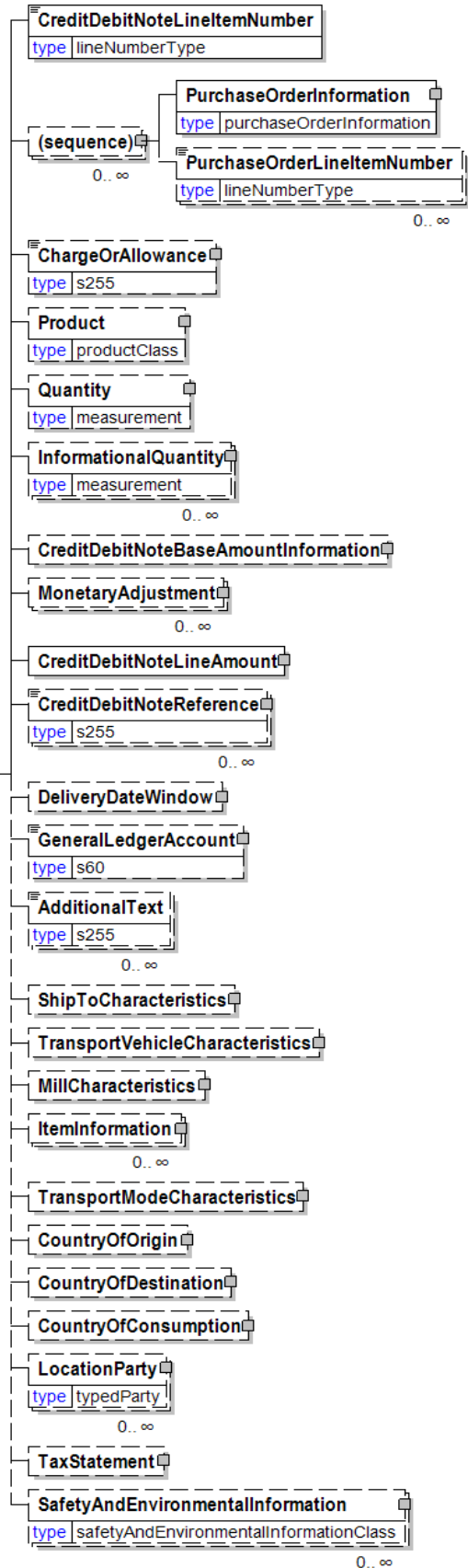

Wood Products, and Virgin Fibre market segments have defined their product characteristics and conversion features for implementation in papiNet.

Quantity

Quantity is optional. A single instance might exist.

The Quantity element contains attributes that provide information about the type of quantity that is being communicated, the context in which the particular quantity is to be viewed, and (if the quantity represents an adjustment) an adjustment type.

The Quantity element contains three child elements that enable you to communicate a range of values for the quantity and a target or actual value. It is at this level (Value, RangeMin, and RangeMax) that the unit of measure is specified. This permits the range to be specified in a different unit of measure than the target.

InformationalQuantity

InformationalQuantity is optional. Multiple instances might exist.

A quantity given in a valid UOM used for information purposes only (not for calculation). For example, an ordered quantity was 100 reels as opposed to the invoice quantity of 20,000 pounds.

CreditDebitNoteBaseAmountInformation

CreditDebitNoteBaseAmountInformation is optional. A single instance might exist.

A group item containing the price per unit and the CreditDebitNote amount subtotal.

MonetaryAdjustment

MonetaryAdjustment is optional. Multiple instances might exist.

The element containing the information necessary for the understanding, calculation, and treatment of an adjustment to a currency amount. MonetaryAdjustment contains an attribute that indicates they type of adjustment being communicated.

CreditDebitNoteLineAmount

CreditDebitNoteLineAmount is mandatory. A single instance is required.

The total CreditDebitNote amount per line (includes adjustments and tax)

CreditDebitNoteReference

CreditDebitNoteReference is optional. Multiple instances might exist.

An element detailing relevant references pertaining to the CreditDebitNote. CreditDebitNoteReference uses the CreditDebitNoteReferenceType attribute.

DeliveryDateWindow

DeliveryDateWindow is optional. A single instance might exist.

A group item defining the date/time interval for delivery to take place. An element which may contain the estimated date for which delivery is expected. This date is not absolute.

GeneralLedgerAccount

GeneralLedgerAccount is optional. A single instance might exist.

The general ledger account to be referenced for the item.

AdditionalText

AdditionalText is optional. Multiple instances might exist.

A text field that is used to communicate information not previously defined or for special instructions. To be used only for circumstances not covered by specific elements.

ShipToCharacteristics

ShipToCharacteristics is optional. A single instance might exist.

A group item that provides information important for the Ship-To Party.

TransportVehicleCharacteristics

TransportVehicleCharacteristics is optional. A single instance might exist.

A group item containing information about a transport vehicle, e.g. a truck. A transport vehicle has its own power and can be used to pull, push, carry, or tow a transport unit loaded with goods.

MillCharacteristics

MillCharacteristics is optional. A single instance might exist.

A group item defining the mill party and machine identifier where a product is or was produced.

ItemInformation

ItemInformation is optional. Multiple instances might exist.

The purpose of the ItemInformation structure is to clearly identify physical items. The attribute ItemType defines the type of physical item. Physical items can be handling units like packages as well as items contained in packages.

TransportModeCharacteristics

TransportModeCharacteristics is optional. A single instance might exist.

A group item defining the primary mode of transport.

CountryOfOrigin

CountryOfOrigin is optional. A single instance might exist.

The country of origin for the material.

CountryOfDestination

CountryOfDestination is optional. A single instance might exist.

The country where the goods will be, or were, shipped to.

CountryOfConsumption

CountryOfConsumption is optional. A single instance might exist.

The country of consumption for the material.

LocationParty

LocationParty is optional. Multiple instances might exist.

The organization or business entity where the business event took place or will take place.

TaxStatement

TaxStatement is optional. A single instance might exist.

A group element for declaration of exception from normal charges of tax and the reason for tax exemption.

SafetyAndEnvironmentalInformation

SafetyAndEnvironmentalInformation is optional. Multiple instances might exist.

Name of certification type, if any, on the goods (For example, FSC, PEFC). SafetyAndEnvironmental needs a value or measurement to communicate the percentage of the product is certified (for example, 75% is certified by the indicated agency).

CreditDebitNoteLineItemNumber

A sequential number that uniquely identifies the CreditDebitNote line item.

CreditDebitNoteLineItemNumber
type lineNumberType

CreditDebitNoteNumber

The unique CreditDebitNote identifier as agreed to by the trading partners.

CreditDebitNoteNumber
type s30

CreditDebitNoteReason

A group item containing the reason for the entire CreditDebitNote.

(sequence)

The sequence of items below is mandatory. A single instance is required.

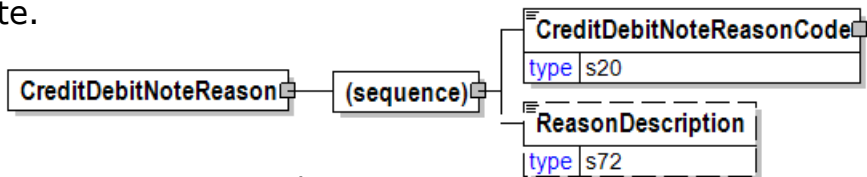

CreditDebitNoteReasonCode

CreditDebitNoteReasonCode is mandatory. A single instance is required.

A selection of one of the valid reasons for creating a CreditDebitNote.

ReasonDescription

ReasonDescription is optional. A single instance might exist.

Text associated with a particular ReasonIdentifier

CreditDebitNoteReasonCode

A selection of one of the valid reasons for creating a CreditDebitNote.

CreditDebitNoteReasonCode
type s20

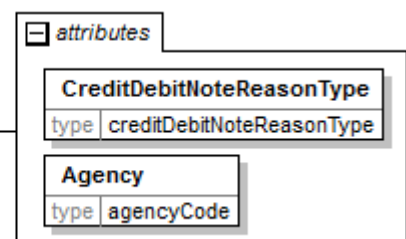

CreditDebitNoteReasonType [attribute]

CreditDebitNoteReasonType is mandatory. A single instance is required.

Describes the type of reasons associated with the CreditDebitNote.

Refer to CreditDebitNoteReasonType definition for any enumerations.

Agency [attribute]

Agency is mandatory. A single instance is required.

Describes the agency maintaining the list of codes. To be included in this list the agency must be a recognized standards body or industry organisation.

- For the element that owns this attribute.
- For another attribute in the list of attributes associated with the parent element.

Refer to Agency definition for any enumerations.

CreditDebitNoteReasonType [attribute]

Describes the type of reasons associated with the CreditDebitNote.

This item is restricted to the following list.

Claim

Commission

InvoiceAsCreditNote

When during invoicing the TotalAmount turns out to be negative, then a credit note is created instead of an invoice. This type of credit note has no reference to any original invoice.

InvoiceError

Rebate

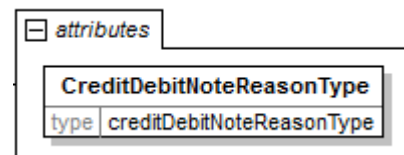

CreditDebitNoteReference

An element detailing relevant references pertaining to the CreditDebitNote.

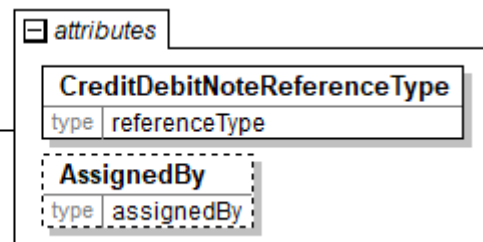
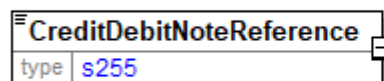

CreditDebitNoteReference uses the CreditDebitNoteReferenceType attribute.

CreditDebitNoteReferenceType [attribute]

CreditDebitNoteReferenceType is mandatory. A single instance is required.

Provides a contextual explanation of the specific reference identifier. Many items are currently prefixed by "Buyer", "Forwarder", "Manufacturer", "Mill", "Seller", "Supplier", "Warehouse", or "Vendor". Check for an existing non-prefixed version and use the non-prefixed version instead. In the (yet to be announced release date) version 3.0 the prefixed versions will be removed. Instead the attribute @AssignedBy will communicate the information previously communicated in the prefix.

Refer to CreditDebitNoteReferenceType definition for any enumerations.

AssignedBy [attribute]

AssignedBy is optional. A single instance might exist.

Identifies the type of party or the agency that has assigned the associated item, e.g. a reference of type OrderNumber.

Refer to AssignedBy for any enumerations.

CreditDebitNoteReferenceType [attribute]

Provides a contextual explanation of the specific reference identifier. Many items are currently prefixed by "Buyer", "Forwarder", "Manufacturer", "Mill", "Seller", "Supplier", "Warehouse", or "Vendor". Check for an existing non-prefixed version and use the non-prefixed version instead. In the (yet to be announced release date) version 3.0 the prefixed versions will be removed. Instead the attribute @AssignedBy will communicate the information previously communicated in the prefix.

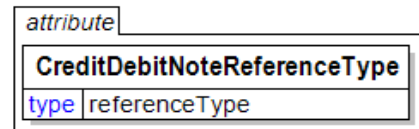

Refer to the [referenceType](#) entry for the list of enumerations and their definitions.

CreditDebitNoteSummary

Contains summary information that applies to the entire e-Document.

(sequence)

The sequence of items below is mandatory. A single instance is required.

TotalNumberOfLineItems

TotalNumberOfLineItems is optional. A single instance might exist.

The total number of individual line items in the document, regardless of the status or type.

(sequence)

The sequence of items below is optional. Multiple instances might exist.

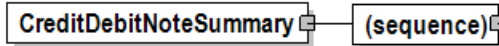

TotalQuantity

TotalQuantity is mandatory. A single instance is required.

The total quantity of similar items in the e-Document. TotalQuantity is primarily used in the summary section of documents where it is repeatable to permit totaling for different units of measure.

TotalInformationalQuantity

TotalInformationalQuantity is optional. Multiple instances might exist.

A quantity that is used to communicate related information about the parent element. This element represents a total that is derived from individual line items.

LineItemSubTotal

LineItemSubTotal is optional. A single instance might exist.

The total amount of all base amounts on e-Document line items. The base amount contains the result of the calculation quantity times the base unit price. As such it does not include any taxes. For example, in an Invoice claiming payment for products LineItemSubTotal is equal to the sum of all InvoiceLineBaseAmount.

TotalAdjustments

TotalAdjustments is optional. A single instance might exist.

The CurrencyValue of TotalAdjustments contains the total of all adjustments and charges excluding tax. For example, in the Invoice TotalAdjustments is equal to the sum of the signed values of the MonetaryAdjustmentAmount for all instances of MonetaryAdjustment with PriceAdjustment and FlatAmountAdjustment and plus the sum of the signed values of the ChargeNetAmount for all instances of ChargeInformation.

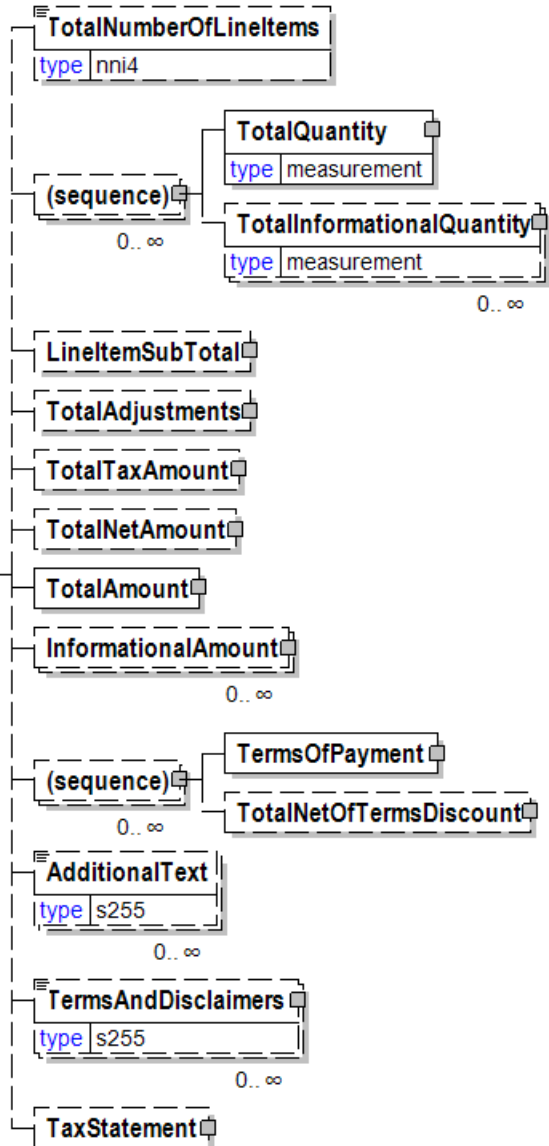

TotalTaxAmount

TotalTaxAmount is optional. A single instance might exist.

The CurrencyValue of TotalTaxAmount contains the sum of all instances of TaxAdjustment in the document. TotalTaxAmount contains the sum of all instances of the MonetaryAdjustmentAmount for tax adjustments.

TotalNetAmount

TotalNetAmount is optional. A single instance might exist.

A field containing total amount excluding tax. For example, in the Invoice TotalNetAmount is equal to the sum of LineItemSubTotal plus TotalAdjustments. TotalNetAmount encapsulates CurrencyValue.

TotalAmount

TotalAmount is mandatory. A single instance is required.

The total amount including tax (when tax is specified in the e-Document).

In e-Documents claiming payment this is the amount due for payment based on the terms of payment. Decimal rounding might be applied to this amount.

InformationalAmount

InformationalAmount is optional. Multiple instances might exist.

A monetary amount used for information purposes only (not for calculation). For example, the invoice price adjustment subtotal is expressed in sterling pounds, and the buyer wants this information expressed in U.S. dollars.

CreditDebitNote and Invoice - The TaxAmount is displayed in the currency that is applicable throughout the e-Document. When a TaxAmount needs to be displayed in a different national currency, this field is used.

(sequence)

The sequence of items below is optional. Multiple instances might exist.

TermsOfPayment

TermsOfPayment is mandatory. A single instance is required.

A group item that contains agreed-to terms defining when, how, and under what conditions the payment is to be made.

When TermsOfPayment is optional; if omitted, TermsOfPayment is controlled through previous negotiation.

TotalNetOfTermsDiscount

TotalNetOfTermsDiscount is optional. A single instance might exist.

The components of the amount to be paid if prompt payment discount terms are met, including the amount that is subject to the payment terms discount, the discount amount, and the amount due after prompt payment discount.

AdditionalText

AdditionalText is optional. Multiple instances might exist.

A text field that is used to communicate information not previously defined or for special instructions. To be used only for circumstances not covered by specific elements.

TermsAndDisclaimers

TermsAndDisclaimers is optional. Multiple instances might exist.

An element that contains legal information with an indication of what the Language

is.

TaxStatement

TaxStatement is optional. A single instance might exist.

A group element for declaration of exception from normal charges of tax and the reason for tax exemption.

CreditDebitNoteType [attribute]

Defines the type of the CreditDebitNote e-Document. There are two types of CreditDebitNote Messages:



This item is restricted to the following list.

CreditNote

Credits that are provided for amount reductions and complaints. A CreditNode will normally have a reference to an earlier issued Invoice.

DebitNote

A DebitNote claims payment for additional charges. A DebitNote normally has a reference to an earlier issued Invoice.

CurrencyFromType [attribute]

The from currency in an exchange.

A three-character ISO 4217 currency code in capital letters. The ISO standard classification for currencies. Refer to the ISO standard for information about the choices for the attribute's enumerations.

<https://www.iso.org/iso-4217-currency-codes.html>



CurrencyType [attribute]

A three-character ISO 4217 currency code in capital letters. The ISO standard classification for currencies. Refer to the ISO standard for information about the choices for the attribute's enumerations.

<https://www.iso.org/iso-4217-currency-codes.html>

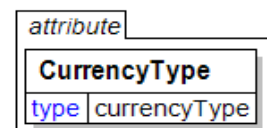

CurrencyValue

The amount in the referenced currency as defined by the CurrencyType attribute.

CurrencyType [attribute]

CurrencyType is mandatory. A single instance is required.

A three-character ISO 4217 currency code in capital letters. The ISO standard

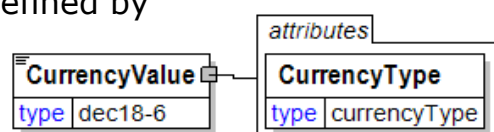

classification for currencies. Refer to the ISO standard for information about the choices for the attribute's enumerations.

<https://www.iso.org/iso-4217-currency-codes.html>

CustomerMarks

The text that the buyer wants the seller to print on the package label or elsewhere.

CustomerMarksType **[attribute]**

CustomerMarksType is optional.

Specifies the content type of customer marks.

Refer to CustomerMarksType definition for any enumerations.

AssignedBy [attribute]

AssignedBy is optional.

Identifies the type of party or the agency that has assigned the associated item, e.g. a reference of type OrderNumber.

Refer to AssignedBy definition for any enumerations.

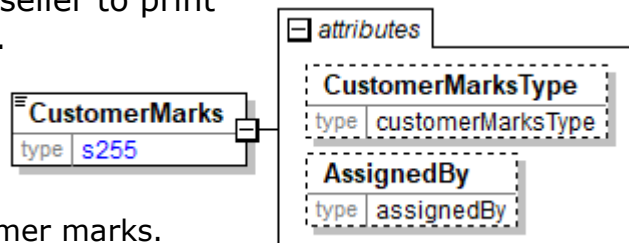

CustomerMarksType [attribute]

Specifies the content type of customer marks.

This item is restricted to the following list.

Author

Name of the author of the product or book

BasisWeight

The weight of the paper expressed as a mass for a given surface area.

BoxWeight

Weight of the filled box.

BookVolumeNumber

A number assigned to a book that denotes the sequential order when several books are either bound in an identical format or are part of a series or set.

BrandName

A specific product brand name for which the owner or source is specified in the "@AssignedBy" attribute

Copyright

The year of publication copyright.

Edition

Identifies the version of the product for which copies were printed and published at one time; For example in book manufacturing values might be 1st, 2nd, etc



ExportShipMark

An export shipment mark for identification.

GradeCode

A specific product code for which the owner or source is specified in the "@AssignedBy" attribute

GradeName

A specific product name for which the owner or source is specified in the "@AssignedBy" attribute (for example, ImprovedNewsprint-45-1479)

Identifier

Identifier of the individual item.

ISBN10

10 digit ISBN code without dashes.

ISBN10Dash

10 digit ISBN code with dashes.

ISBN13

13 digit ISBN code.

ISBN13Dash

A 13 character ISBN with dashes.

LotIdentifier

A unique code used to identify a grouping of product with one set of quality statistics common to all members of that group. Synonym: Lot Number.

PartNumber

An equivalent to the Stock Keeping Unit (SKU) for which the owner or source is specified in the "@AssignedBy" attribute. In other words, this code fully defines the product.

PrintingNumber

A reference to the sequential print run number.

ProfitCenter

Profit Center identifier.

PublisherName

Name of the publisher of a document.

PubName

The publication name.

PurchaseOrderNumber

The unique order identifier as designated by the customer.

ReferenceNumber

An informational reference (either textual or numeric) for which the owner or source is specified in the "@AssignedBy" attribute.

RetailPrice

Cover price of the finished product.

TambourID

The unique identifier of the jumbo reel (also called mother reel or Tambour).

Title

Proper title of a book product.

TitleAlias

Alternate title description for book products, usually for security purposes.

UnitsPerCarton

Number of units per box.

UniversalProductIdentifier

Unique identifier for the book, component of a book product, and many other products.

CustomsParty

The party responsible for customs arrangements.

LogisticsRole [attribute]

LogisticsRole is optional. A single instance might exist.

Communicates the nature of the logistics role, if any, the party plays in the transaction.

Refer to LogisticsRole definition for any enumerations.

(sequence)

The sequence of items below is mandatory. A single instance is required.

PartyIdentifier

PartyIdentifier is optional. Multiple instances might exist.

A unique identifier of a specific party. This element contains an attribute PartyIdentifierType that indicates the type of the identifier.

NameAddress

NameAddress is mandatory. A single instance is required.

A group item containing name and address of an organisation or business entity.

URL

URL is optional. A single instance might exist.

Universal Resource Locator. While typically a web address you could use this field to hold an email address.

CommonContact

CommonContact is optional. Multiple instances might exist.

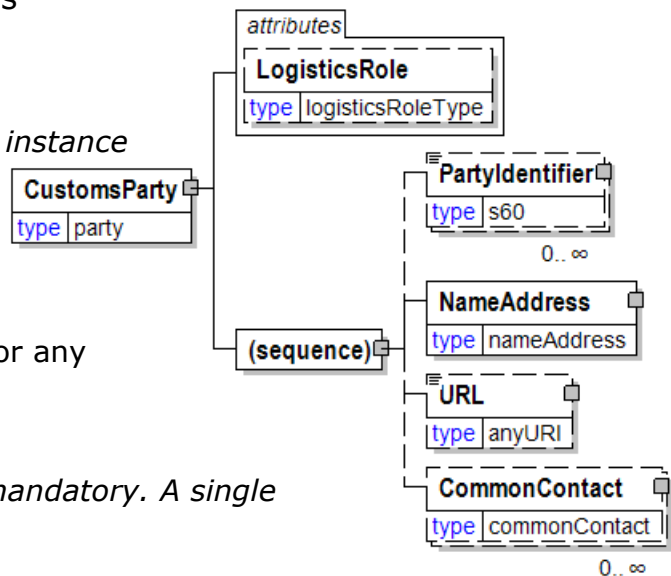

Identifies a specific individual associated with the party.

CustomsReferenceNumber

A reference that applies to customs arrangements.

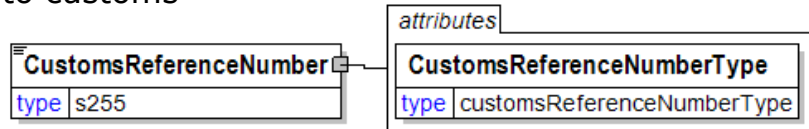

CustomsReferenceNumberType [attribute]

CustomsReferenceNumberType is mandatory. A single instance is required.

The type of customs reference number.

Refer to CustomsReferenceNumberType definition for any enumerations.

CustomsReferenceNumberType [attribute]

The type of customs reference number.

This item is restricted to the following list.

T2L

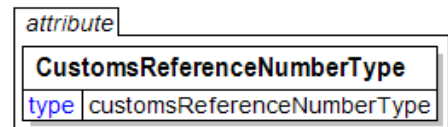

SimplifiedCustomsClearanceLicenseNumber

CustomsStampDate

The date of the customs stamp.

(sequence)

The sequence of items below is mandatory. A single instance is required.

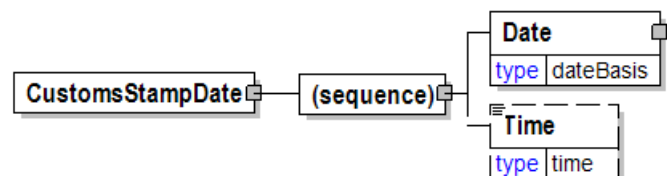

Date

Date is mandatory. A single instance is required.

A group element that contains the specification of Year, Month, and Day.

Time

Time is optional. A single instance might exist.

Times are treated in a standard XML fashion with a special case used to indicate a generalized "local" time. The standard XML approach to time is hh:mm:ss, hh:mm:ssZ, or hh:mm:ss±hh:mm.

hh:mm:ss±hh:mm is used to represent a time with a time zone. The time zone is communicated as the number of hours offset from the Universal Time Coordinate (UTC), a.k.a. Greenwich Mean Time.

hh:mm:ssZ indicates the time at Zulu (another name for UTC).

hh:mm:ss or hh:mm indicates within papiNet the applicable local time where the associated event is taking place. Caution should be used when processing times of this nature as the papiNet approach may be in discord with other users of XML.

CustomsStampHeaderText

Text to be applied prior to the customs stamp.



CustomsStampInformation

A grouping element that organises the information for customs.

(sequence)

The sequence of items below is mandatory. A single instance is required.

CustomsStampHeaderText

CustomsStampHeaderText is optional. Multiple instances might exist.

Text to be applied prior to the customs stamp.

CustomsParty

CustomsParty is optional. A single instance might exist.

The party responsible for customs arrangements.

CustomsStampDate

CustomsStampDate is optional. A single instance might exist.

The date of the customs stamp.

CustomsReferenceNumber

CustomsReferenceNumber is optional. A single instance might exist.

A reference that applies to customs arrangements.

SupplierCustomsReference

SupplierCustomsReference is optional. A single instance might exist.

Supplier Customs Reference

MillParty

MillParty is optional. A single instance might exist.

The organisation or business entity that actually produces the product.

CustomsStampTrailerText

CustomsStampTrailerText is optional. Multiple instances might exist.

Text to be applied after the customs stamp.

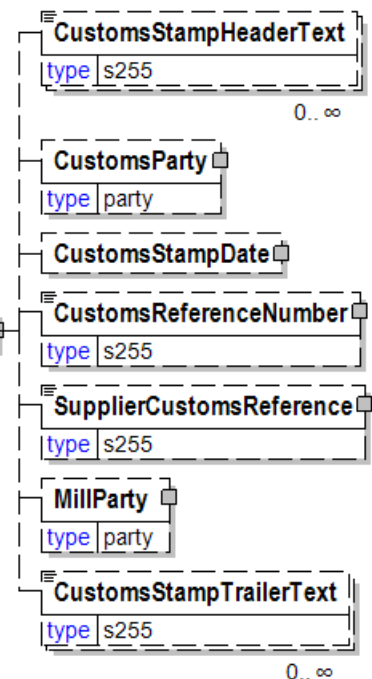

CustomsStampTrailerText

Text to be applied after the customs stamp.

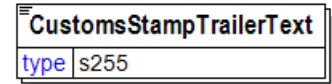

CustomsTariffCode

The tariff code for customs purposes.

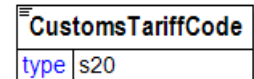

CustomsTotals

A grouping element for customs total information.

(sequence)

The sequence of items below is mandatory. A single instance is required.

CustomsTariffCode

CustomsTariffCode is mandatory. A single instance is required.

The tariff code for customs purposes.

TotalQuantity

TotalQuantity is mandatory. A single instance is required.

The total quantity of similar items in the e-Document. TotalQuantity is primarily used in the summary section of documents where it is repeatable to permit totaling for different units of measure.

InformationalQuantity

InformationalQuantity is optional. Multiple instances might exist.

A quantity given in a valid UOM used for information purposes only (not for calculation). For example, an ordered quantity was 100 reels as opposed to the invoice quantity of 20,000 pounds.

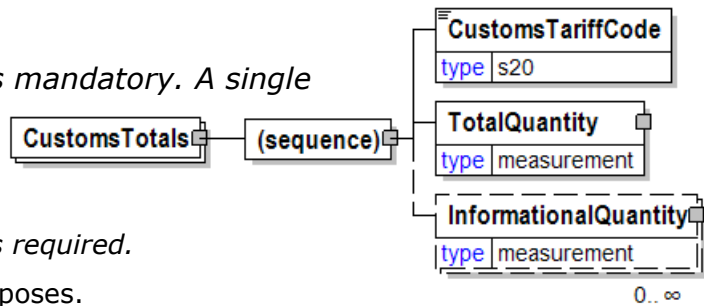

CuttingDetails

Cutting Details provides information on how to cut the sheet.

(sequence)

The sequence of items below is mandatory. A single instance is required.

CuttingTemplateCode

CuttingTemplateCode is optional. A single instance might exist.

Cutting Template Code contains the reference to previously defined instructions on

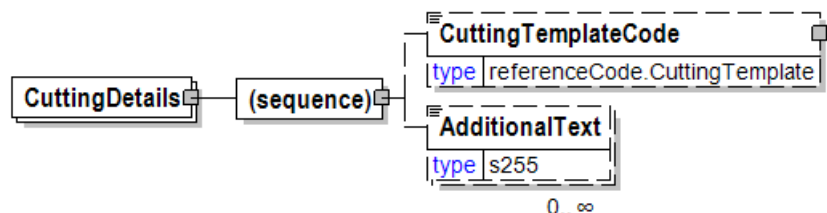

how to cut the sheet.

AdditionalText

AdditionalText is optional. Multiple instances might exist.

A text field that is used to communicate information not previously defined or for special instructions. To be used only for circumstances not covered by specific elements.

CuttingTemplateCode

Cutting Template Code contains the reference to previously defined instructions on how to cut the sheet.

AssignedBy [attribute]

AssignedBy is optional. A single instance might exist.

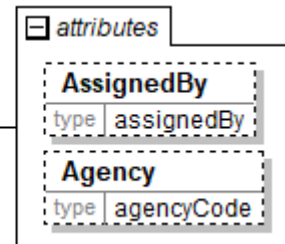
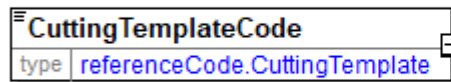

Identifies the type of party or the agency that has assigned the associated item, e.g. a reference of type OrderNumber. Refer to AssignedBy definition for any enumerations.

Refer to AssignedBy definition for any enumerations.

Agency [attribute]

Agency is optional. A single instance might exist.

Describes the agency maintaining the list of codes. To be included in this list the agency must be a recognized standards body or industry organisation.

- For the element that owns this attribute.
- For another attribute in the list of attributes associated with the parent element.

Refer to Agency definition for any enumerations.

Cyan

The Cyan component of a colour in the CMYK approach to colour definition.

(sequence)

The sequence of items below is mandatory. A single instance is required.

DetailValue

DetailValue is mandatory. A single instance is required.

A numeric value expressed in the unit of measure (UOM).

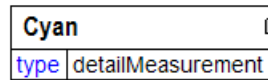

DetailRangeMin

DetailRangeMin is optional. A single instance might exist.

The minimum value (lower boundary) allowed for the DetailValue that is the parent of this element.

DetailRangeMax

DetailRangeMax is optional. A single instance might exist.

The maximum value (upper boundary) allowed for the DetailValue that is the parent of this element.

StandardDeviation

StandardDeviation is optional. A single instance might exist.

A statistic used as a measure of dispersion in a distribution.

SampleSize

SampleSize is optional. A single instance might exist.

The number of samples used to determine the product characteristic in question.

TwoSigmaLower

TwoSigmaLower is optional. A single instance might exist.

Two sigma (a measure of dispersion associated with standard deviation) on the lower side of the standard deviation.

TwoSigmaUpper

TwoSigmaUpper is optional. A single instance might exist.

Two sigma (a measure of dispersion associated with standard deviation) on the upper side of the standard deviation.

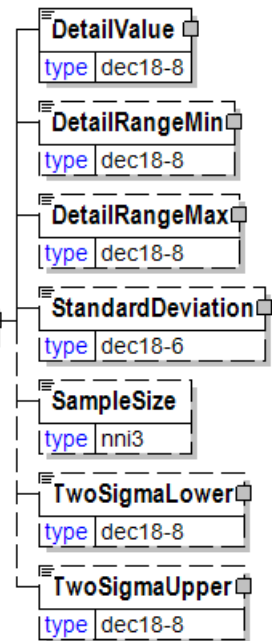

Date

A group element that contains the specification of Year, Month, and Day.

(sequence)

The sequence of items below is mandatory. A single instance is required.

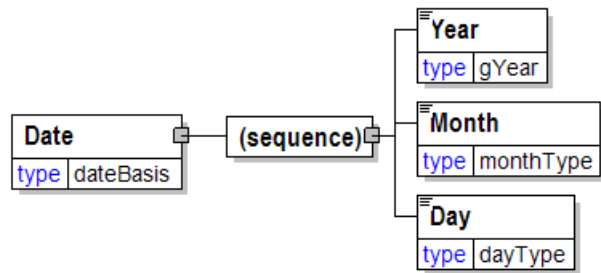

Year

Year is mandatory. A single instance is required.

Identifies the year number when communicating a Calendar date.

Month

Month is mandatory. A single instance is required.

Identifies the month number when communicating a Calendar date. Month is an integer between 1 and 12 without leading zeros.

Day

Day is mandatory. A single instance is required.

Identifies the day of the month when communicating a Calendar date. Day is an integer between 1 and 31 without leading zeros.

DateFinished

The Date and optionally the Time that an item was finished. For example, this could be the wrapping date for a reel or ream or the date the sheet(s) were packaged in preparation for shipment

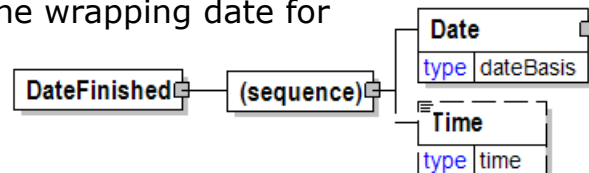

(sequence)

The sequence of items below is mandatory. A single instance is required.

Date

Date is mandatory. A single instance is required.

A group element that contains the specification of Year, Month, and Day.

Time

Time is optional. A single instance might exist.

Times are treated in a standard XML fashion with a special case used to indicate a generalized "local" time. The standard XML approach to time is hh:mm:ss, hh:mm:ssZ, or hh:mm:ss±hh:mm.

hh:mm:ss±hh:mm is used to represent a time with a time zone. The time zone is communicated as the number of hours offset from the Universal Time Coordinate (UTC), a.k.a. Greenwich Mean Time.

hh:mm:ssZ indicates the time at Zulu (another name for UTC).

hh:mm:ss or hh:mm indicates within papiNet the applicable local time where the associated event is taking place. Caution should be used when processing times of this nature as the papiNet approach may be in discord with other users of XML.

DateMade

The Date and optionally the Time when an item was produced. DateMade is normally a date before the wrapping and labelling date of the item.

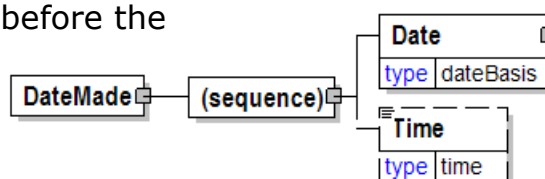

(sequence)

The sequence of items below is mandatory. A single instance is required.

Date

Date is mandatory. A single instance is required.

A group element that contains the specification of Year, Month, and Day.

Time

Time is optional. A single instance might exist.

Times are treated in a standard XML fashion with a special case used to indicate a generalized "local" time. The standard XML approach to time is hh:mm:ss, hh:mm:ssZ, or hh:mm:ss±hh:mm.

hh:mm:ss±hh:mm is used to represent a time with a time zone. The time zone is communicated as the number of hours offset from the Universal Time Coordinate (UTC), a.k.a. Greenwich Mean Time.

hh:mm:ssZ indicates the time at Zulu (another name for UTC).

hh:mm:ss or hh:mm indicates within papiNet the applicable local time where the associated event is taking place. Caution should be used when processing times of this nature as the papiNet approach may be in discord with other users of XML.

DateSheeted

The Date and optionally the Time that the paper was sheeted.

(sequence)

The sequence of items below is mandatory. A single instance is required.

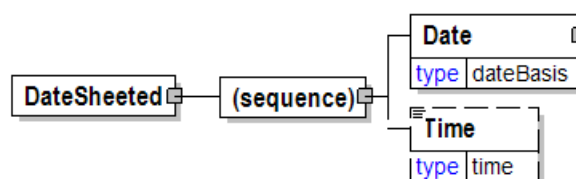

Date

Date is mandatory. A single instance is required.

A group element that contains the specification of Year, Month, and Day.

Time

Time is optional. A single instance might exist.

Times are treated in a standard XML fashion with a special case used to indicate a generalized "local" time. The standard XML approach to time is hh:mm:ss, hh:mm:ssZ, or hh:mm:ss±hh:mm.

hh:mm:ss±hh:mm is used to represent a time with a time zone. The time zone is communicated as the number of hours offset from the Universal Time Coordinate (UTC), a.k.a. Greenwich Mean Time.

papiNet V2R31

hh:mm:ssZ indicates the time at Zulu (another name for UTC).

hh:mm:ss or hh:mm indicates within papiNet the applicable local time where the associated event is taking place. Caution should be used when processing times of this nature as the papiNet approach may be in discord with other users of XML.

DateTimeFrom

The start or beginning Date and Time of a date range.

(sequence)

The sequence of items below is mandatory. A single instance is required.

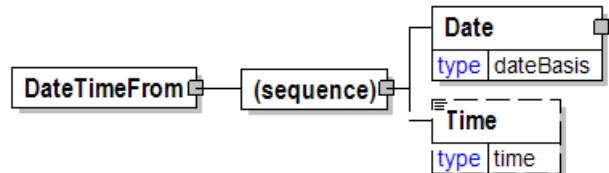

Date

Date is mandatory. A single instance is required.

A group element that contains the specification of Year, Month, and Day.

Time

Time is optional. A single instance might exist.

Times are treated in a standard XML fashion with a special case used to indicate a generalized "local" time. The standard XML approach to time is hh:mm:ss, hh:mm:ssZ, or hh:mm:ss±hh:mm.

hh:mm:ss±hh:mm is used to represent a time with a time zone. The time zone is communicated as the number of hours offset from the Universal Time Coordinate (UTC), a.k.a. Greenwich Mean Time.

hh:mm:ssZ indicates the time at Zulu (another name for UTC).

hh:mm:ss or hh:mm indicates within papiNet the applicable local time where the associated event is taking place. Caution should be used when processing times of this nature as the papiNet approach may be in discord with other users of XML.

DateTimeRange

Specifies a date and/or time range.

(sequence)

The sequence of items below is mandatory. A single instance is required.

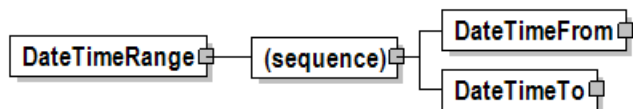

DateTimeFrom

DateTimeFrom is mandatory. A single instance is required.

The start or beginning Date and Time of a date range.

DateTimeTo

DateTimeTo is mandatory. A single instance is required.

The ending Date and Time of a date/time range.

DateTimeTo

The ending Date and Time of a date/time range.

(sequence)

The sequence of items below is mandatory. A single instance is required.

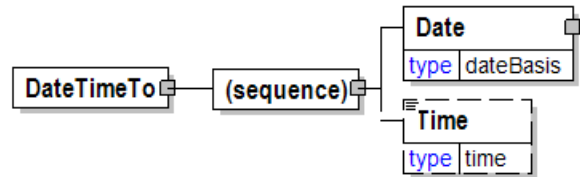

Date

Date is mandatory. A single instance is required.

A group element that contains the specification of Year, Month, and Day.

Time

Time is optional. A single instance might exist.

Times are treated in a standard XML fashion with a special case used to indicate a generalized "local" time. The standard XML approach to time is hh:mm:ss, hh:mm:ssZ, or hh:mm:ss±hh:mm.

hh:mm:ss±hh:mm is used to represent a time with a time zone. The time zone is communicated as the number of hours offset from the Universal Time Coordinate (UTC), a.k.a. Greenwich Mean Time.

hh:mm:ssZ indicates the time at Zulu (another name for UTC).

hh:mm:ss or hh:mm indicates within papiNet the applicable local time where the associated event is taking place. Caution should be used when processing times of this nature as the papiNet approach may be in discord with other users of XML.

DateTimeValue

A Date and Time value in the standard W3C xs:dateTime format.

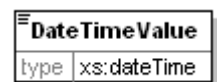

DateType [attribute]

Provides a context for the other date used in the document.

This item is restricted to the following list.

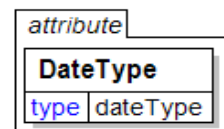

ActualArrivalDate

The date when a product and/or a transport arrived at a location.

ActualBorderCrossingDate

The date the product has crossed the border between countries. The date is specified based on the forwarding or customs operations at the border.

ActualDeliveryCompletedDate

The date when a vehicle left a delivery destination after fulfilling a delivery, e.g. when an empty vehicle left the weighbridge or passed through the exit gate of the delivery destination.

ActualDepartureDate

papiNet V2R31

The date when a product and/or a transport departed from a location.

AvailableToShipDate

The date the product needs to be available to ship.

BoundBookDate

Date the book is to be bound

CancelAfterDate

An action defined by the context is to be cancelled after the specified date.

ComponentDueDate

The date the component is due at the manufacturing or assembly location.

ComponentShipDate

The date the component has shipped or should ship.

ConsumptionDate

The date the item was or should be consumed.

DateOfLastChange

The last date that changes are permitted.

DateOfTrading

A date or date range when the supply of goods or services were made or completed. Normally this is the date of delivery but it can be other dates depending on terms of delivery; for example, despatch date.

DeliveryNotAllowed

Delivery must not take place during the dates specified.

DeliveryDate

The date the product is to be delivered.

DeliveryPriorToDate

The delivery must take place prior to this date.

DeliveryReceptionMeasurementsCompletedDate

The date and time on which the reception process concerning the delivery of the product is completed with all required measurements done and all data saved in the business system.

DeliveryRequestedDate

The date on which the buyer requests goods to be delivered. Delivery will happen at this date on a "best endeavours" basis.

DespatchDate

The date the product is to be despatched.

DoNotDeliverAfterDate

The delivery must not take place after the date specified.

DoNotShipAfterDate

The shipment must not take place after the date specified.

DrawDate

The date removed from stock.

EarliestDate

The earliest date that an activity is allowed to be done.

EndCallOffDate

The date that call offs should end.

EndJobDate

The date and time when a job was completed. For example when a forest machine completed the work in a logging area.

EndOfDeliveryMonth

The end of the month that delivery has taken place.

EndOfDespatchMonth

The end of the month that despatch has taken place.

EndOfInvoiceMonth

The end of the month that Invoice has taken place.

EstimatedTimeOfArrival

The date and time that the shipment is expected to arrive.

EstimatedTimeOfDeparture

The date and time that the shipment is expected to leave.

ExMillDate

Goods are ready at the mill.

ForestForwardingDate

The date when transporting of forest wood products take place from logging areas to roadside landings.

InvoiceDate

A date that is qualifying the invoicing period. This date often drives payment terms. Note that this date is not necessarily the same as the issue date of the Invoice.

LastChangeDate

The most recent date the document was changed.

LatestPickUpDate

The latest date that the product has to be picked-up.

LatestProductionDate

The latest date that the product has to be produced.

LoadingDate

The date when the goods are loaded on a transport unit.

LoadingSlotDate

LoadingSlotDate informs the date and time window when loading is scheduled.

MeasuringDate

The date when measuring is performed.

OnPressDate

Date printing will commence.

OnSalesDate

Publicised sales date

OrderConfirmationDate

The date that OrderConfirmation took place.

OrderFirmedDate

The date that the order will be consider firm unless additional information is received.

PickUpDate

The date the material will be, or is available to be, picked-up from the shipping location.

PlannedMeasuringDate

The date when measuring is planned to take place.

PlannedMeasuringDate (misspelt with an ending space)

The item is misspelt ending with a space. It will be deprecated in a future version V3R00. Use instead the correctly spelt enumeration PlannedMeasuringDate.

PlannedProductionDate

The date when production is planned to take place.

PlannedShipDate

The anticipated date of shipment.

PostingDate

The posting date determines the booking period and defines in which fiscal period the document will be booked.

PrepDate

Specifies the date applied to the preparation process.

PriceListDate

Defines what date the price in a business agreement is based on.

PrintDate

The date on which a job is planned to go on the press to be printed. The ordered product needs to be available before this date.

ProductionDate

The date the product is produced.

ProofDueBackDate

Date the return of the proof is due back or the review process is to be completed.

ProofOutDate

Date the proof is mailed or made available to the buyer for review.

PublicationDate

Date the book will be published.

PurchaseOrderDate

The date when the PurchaseOrder was issued.

ReferencePeriod

A period of time covered by the object, e.g. an e-Document.

RequiredByDate

The date by which the activity must be completed. In the context of a PurchaseOrder this date refers to the date by which the material must be at the buyer's location of use.

ResourceDeliveryDate

The date and time when the resource is expected to be delivered.

ResourceRequestedDate

The date and time when the resource is requested to be delivered.

ShipEvenlyThroughout

Distribute shipment of product in relatively even shipments throughout the date range indicated

ShipmentPriorToDate

The shipment (despatch) must take place prior to this date—in other words, the goods have to leave the terminal.

ShipmentRequestedDate

The date shipment is requested.

SnowRemovalActualDate

The date that snow removal has taken place.

SnowRemovalRequestedDate

The requested date that snow removal is to take place.

SpecificationVersionDate

Date of version of a specification.

StandingTreeMarkingDate

The date that standing trees are marked.

StanForDFileTransmissionDate

The date and time when a StanForD file was transmitted by a forest machine.

StartCallOffDate

The date on which the first CallOff can be placed.

StartJobDate

The date and time when a job was started. For example when a forest

machine started the work in a logging area.

TheWeekBeginning

The delivery is to be made at the beginning of the week that is mentioned in the Date construct.

TheWeekEnding

The delivery is to be made at the end of the week that is mentioned in the Date construct.

UnloadingSlotDate

UnloadingSlotDate informs the date and time window when unloading is scheduled.

WarehouseDate

Depending on the e-Document context this can communicate the date that items are due in the warehouse or have been placed in the warehouse. For example:

Date books are due in the publisher's warehouse

Date reels were unloaded and put into the warehouse

Other

Any other type of date that is not contained in the attribute list.

DateWound

The Date and optionally the Time that a reel was wound or produced from its parent. RewoundIndicator indicates if the reel has been rewound.

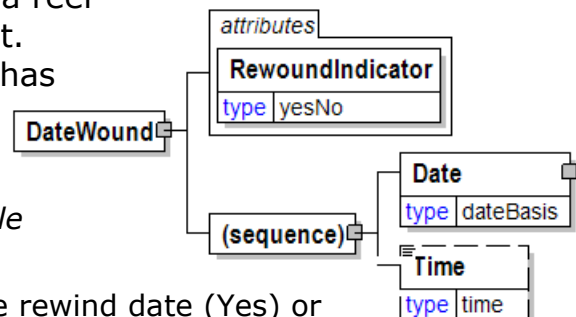

RewoundIndicator [attribute]

RewoundIndicator is mandatory. A single instance is required.

Is the date being communicated the the rewind date (Yes) or the date of original winding (No)?

Refer to RewoundIndicator definition for any enumerations.

(sequence)

The sequence of items below is mandatory. A single instance is required.

Date

Date is mandatory. A single instance is required.

A group element that contains the specification of Year, Month, and Day.

Time

Time is optional. A single instance might exist.

Times are treated in a standard XML fashion with a special case used to indicate a generalized "local" time. The standard XML approach to time is hh:mm:ss, hh:mm:ssZ, or hh:mm:ss±hh:mm.

papiNet V2R31

hh:mm:ss±hh:mm is used to represent a time with a time zone. The time zone is communicated as the number of hours offset from the Universal Time Coordinate (UTC), a.k.a. Greenwich Mean Time.

hh:mm:ssZ indicates the time at Zulu (another name for UTC).

hh:mm:ss or hh:mm indicates within papiNet the applicable local time where the associated event is taking place. Caution should be used when processing times of this nature as the papiNet approach may be in discord with other users of XML.

Day

Identifies the day of the month when communicating a Calendar date. Day is an integer between 1 and 31 without leading zeros.

Day
type dayType

Days

The qualifier of DeliveryTransitTime. More generally used to communicate duration in days.

Days
type nni3

Debarked [attribute]

Either "Yes" or "No".

This item is restricted to the following list.

Yes

No

attribute
Debarked
type yesNo

DeckAndPorchFlooringMaterials-NaturalWood

Deck and porch flooring materials that are used in natural wood

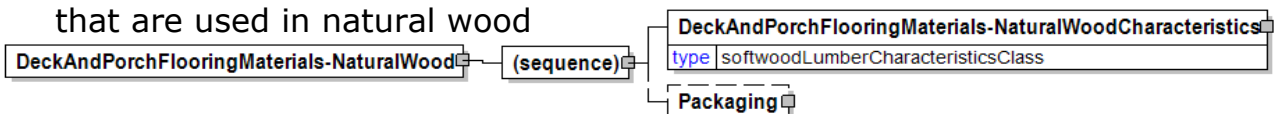

products.

(sequence)

The sequence of items below is mandatory. A single instance is required.

DeckAndPorchFlooringMaterials-NaturalWoodCharacteristics

DeckAndPorchFlooringMaterials-NaturalWoodCharacteristics is mandatory. A single instance is required.

Natural wood characteristics of deck and porch flooring materials.

Packaging

Packaging is optional. A single instance might exist.

Type of a package that includes individual products.

DeckAndPorchFlooringMaterials-NaturalWoodCharacteristics

Natural wood characteristics of deck and porch flooring materials.

(sequence)

The sequence of items below is mandatory. A single instance is required.

LumberSpecies

LumberSpecies is mandatory. One instance is required, multiple instances might exist.

Specifies the raw material species.

LumberGrade

LumberGrade is mandatory. A single instance is required.

Defines quality characteristics achieved by selecting pieces based on a grading rule.

Length

Length is optional.

The length of the object.

Width

Width is optional.

The width of the object.

Thickness

Thickness is optional.

Physical dimension of a product.

Seasoning

Seasoning is optional. A single instance might exist.

Describes drying/ moisture control method.

MoistureContent

MoistureContent is optional. A single instance might exist.

Defines the moisture content percentage of the product.

HeatTreatment

HeatTreatment is optional. A single instance might exist.

Defines the heat treatment method.

ManufacturingProcess

ManufacturingProcess is optional. Multiple instances might exist.

Defines the different machining and processes made for the product.

PatternProfile

PatternProfile is optional. A single instance might exist.

Defines the pattern used in machining the product.

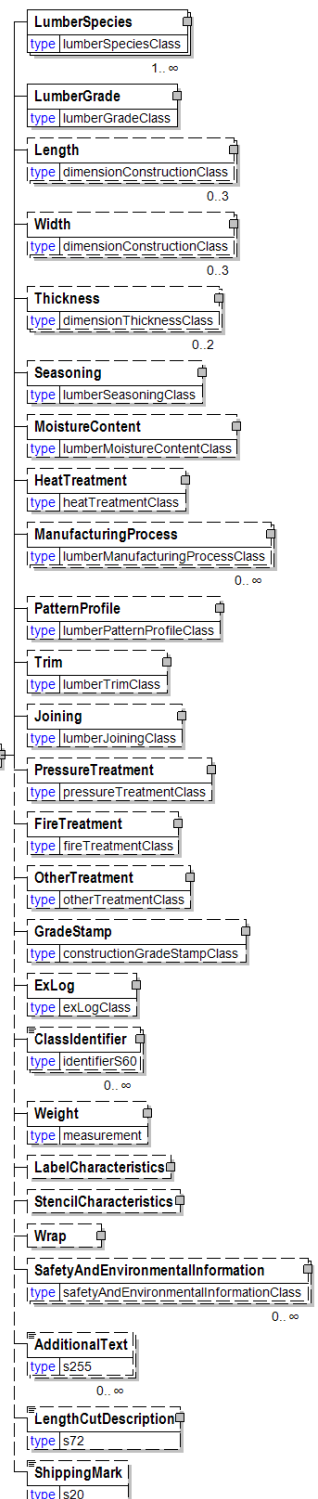
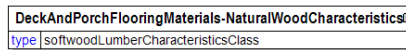

Trim

Trim is optional. A single instance might exist.

Trim

Joining

Joining is optional. A single instance might exist.

Defines the method used to join pieces of wood.

PressureTreatment

PressureTreatment is optional. A single instance might exist.

Method and parameter values of pressure treatment.

FireTreatment

FireTreatment is optional. A single instance might exist.

Fire treatment

OtherTreatment

OtherTreatment is optional. A single instance might exist.

Other treatment

GradeStamp

GradeStamp is optional. A single instance might exist.

Grade stamp information

ExLog

ExLog is optional. A single instance might exist.

Describes the cutting pattern of the log.

ClassIdentifier

ClassIdentifier is optional. Multiple instances might exist.

Standard used for product identification.

Weight

Weight is optional. A single instance might exist.

The weight of the item.

LabelCharacteristics

LabelCharacteristics is optional. A single instance might exist.

A group item that organises the labeling information.

StencilCharacteristics

StencilCharacteristics is optional. A single instance might exist.

A group element specifying attributes of a stencil to be applied to an item, and optional text.

Wrap

Wrap is optional. A single instance might exist.

A group item that organises wrapping detail information.

SafetyAndEnvironmentalInformation

SafetyAndEnvironmentalInformation is optional. Multiple instances might exist.

papiNet V2R31

Name of certification type, if any, on the goods (For example, FSC, PEFC). SafetyAndEnvironmental needs a value or measurement to communicate the percentage of the product is certified (for example, 75% is certified by the indicated agency).

AdditionalText

AdditionalText is optional. Multiple instances might exist.

A text field that is used to communicate information not previously defined or for special instructions. To be used only for circumstances not covered by specific elements.

LengthCutDescription

LengthCutDescription is optional. A single instance might exist.

Length Cut Description

ShippingMark

ShippingMark is optional. A single instance might exist.

A shipping mark identifies the producer and quality on the end side of the product. Not to be mixed with company code/logo or other product marking.

DecorationCoverage

Decoration coverage.

(sequence)

The sequence of items below is mandatory. A single instance is required.

Value

Value is mandatory. A single instance is required.

A numeric value expressed in the unit of measure (UOM).

RangeMin

RangeMin is optional. A single instance might exist.

The minimum value (lower boundary) allowed for the Measurement that is the parent of this element.

RangeMax

RangeMax is optional. A single instance might exist.

The maximum value (upper boundary) allowed for the Measurement that is the parent of this element. Some elements use the RangeMax element with an extended list of unit of measures. (Note: the red colour in the picture is an artifact of how the graphic was captured and should be disregarded.)

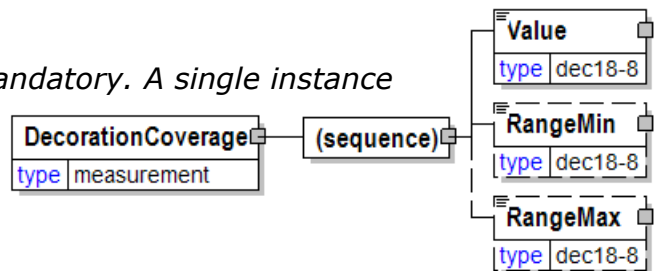

DecorationLocationType [attribute]

Decoration location type

This item is restricted to the following list.

Front



Back

Spine

FrontAndBack

FrontAndSpine

BackAndSpine

FrontAndBackAndSpine

DecorationSpecs

Decoration specifications

DecorationType [attribute]

DecorationType is optional. A single instance might exist.

Describes the finishing process.

Refer to DecorationType definition for any enumerations.

DecorationLocationType [attribute]

DecorationLocationType is optional. A single instance might exist.

Decoration location type

Refer to DecorationLocationType definition for any enumerations.

(sequence)

The sequence of items below is mandatory. A single instance is required.

ColourCode

ColourCode is optional. A single instance might exist.

A code indicating the colour.

ColourDescription

ColourDescription is optional. A single instance might exist.

A free form description of the colour.

NumberOfHits

NumberOfHits is optional. A single instance might exist.

The number of hits

DecorationCoverage

DecorationCoverage is optional. A single instance might exist.

Decoration coverage.

ProductIdentification

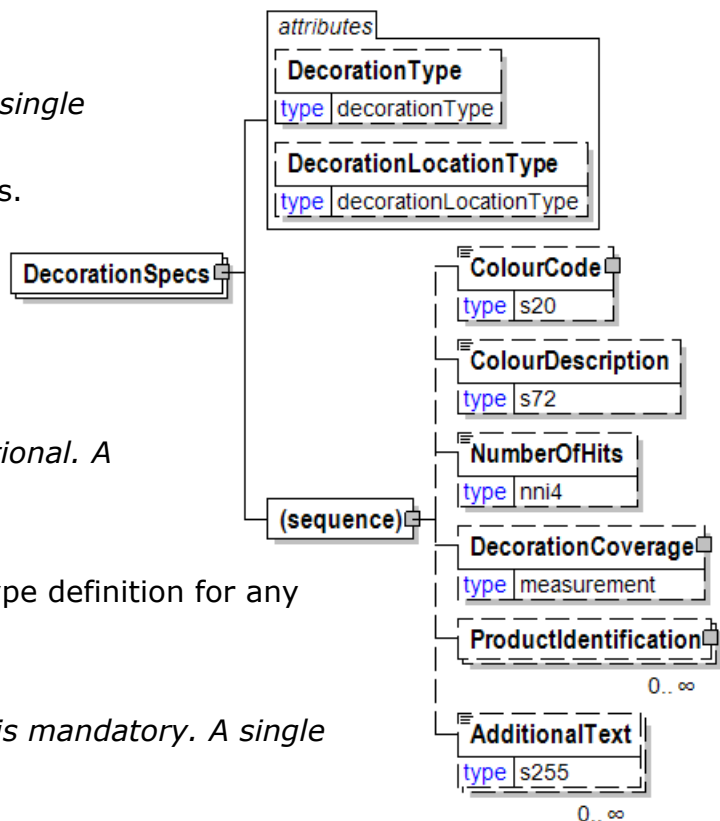

ProductIdentification is optional. Multiple instances might exist.

A grouping element designed to communicate product identification related to the parent element that contains this item.

AdditionalText

AdditionalText is optional. Multiple instances might exist.

A text field that is used to communicate information not previously defined or for special instructions. To be used only for circumstances not covered by specific elements.

DecorationType [attribute]

Describes the finishing process.

This item is restricted to the following list.

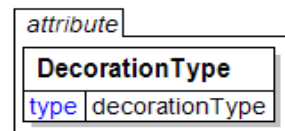

Debossing

DieCuts

Emboss

FoilStamping

Pressing a design onto a book cover using metallic or pigment foil.

Hubbing

InkStamping

Pressing a design onto a book cover using ink

RaisedBands

RaisedUV

Raised bumps obtained via an ultra-violet process.

Stamping

DeductionInfo

A grouping element that contains information about deductions of quantities.

(sequence)

The sequence of items below is mandatory. A single instance is required.

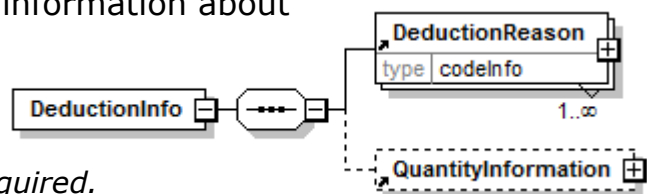

DeductionReason

DeductionReason is mandatory. One instance is required, multiple instances might exist.

A grouping element that contains the reason for the deduction.

QuantityInformation

QuantityInformation is optional. A single instance might exist.

A group item containing information about quantity and informational quantity of similar items.

DeductionReason

A grouping element that contains the reason for the deduction.

Agency [attribute]

Agency is mandatory. A single instance is required.

Describes the agency maintaining the list of codes. To be included in this list the agency must be a recognized standards body or industry organisation.

- For the element that owns this attribute.
- For another attribute in the list of attributes associated with the parent element.

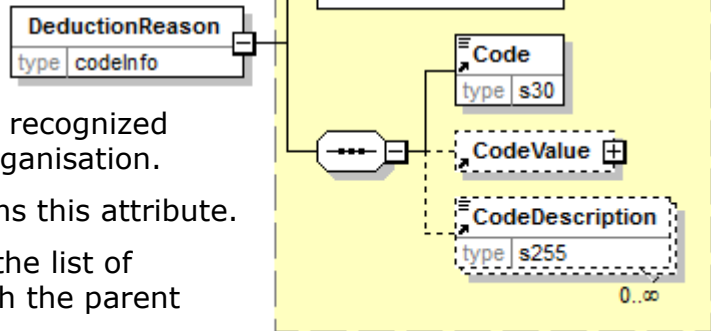

Refer to Agency definition for any enumerations.

(sequence)

The sequence of items below is mandatory. A single instance is required.

Code

Code is mandatory. A single instance is required.

Specifies a code that is defined by an agency. The agency is given for the whole construct containing the code.

CodeValue

CodeValue is optional. A single instance might exist.

A grouping element specifying a value belonging to a code that is defined by an agency.

CodeDescription

CodeDescription is optional. Multiple instances might exist.

A textual description for the meaning of a code that is defined by an agency. When the Code is associated with a CodeValue of type TextValue, then the CodeDescription is a textual description of both the Code and the TextValue.

DeliveryDate

The Date and optionally the Time that the partners agree is the date upon which deliveries will be recognised.

Possible choices for this date are either the date despatched or the date received.

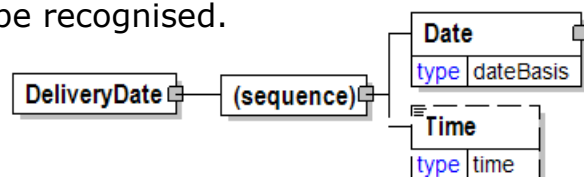

(sequence)

The sequence of items below is mandatory. A single instance is required.

Date

papiNet V2R31

Date is mandatory. A single instance is required.

A group element that contains the specification of Year, Month, and Day.

Time

Time is optional. A single instance might exist.

Times are treated in a standard XML fashion with a special case used to indicate a generalized "local" time. The standard XML approach to time is hh:mm:ss, hh:mm:ssZ, or hh:mm:ss±hh:mm.

hh:mm:ss±hh:mm is used to represent a time with a time zone. The time zone is communicated as the number of hours offset from the Universal Time Coordinate (UTC), a.k.a. Greenwich Mean Time.

hh:mm:ssZ indicates the time at Zulu (another name for UTC).

hh:mm:ss or hh:mm indicates within papiNet the applicable local time where the associated event is taking place. Caution should be used when processing times of this nature as the papiNet approach may be in discord with other users of XML.

DeliveryDateType [attribute]

Provides a context for the delivery date window.

This item is restricted to the following list.



ActualArrivalDate

The date when a product and/or a transport arrived at a location.

ActualBorderCrossingDate

The date the product has crossed the border between countries. The date is specified based on the forwarding or customs operations at the border.

ActualDeliveryCompletedDate

The date when a vehicle left a delivery destination after fulfilling a delivery, e.g. when an empty vehicle left the weighbridge or passed through the exit gate of the delivery destination.

ActualDepartureDate

The date when a product and/or a transport departed from a location.

AvailableToShipDate

The date that the material is available for shipment. That is, the material can be picked up on this date.

CancelAfterDate

The delivery is to be cancelled if not delivered by this date.

DateOfLastChange

The latest date at which an amendment versus cancellation is allowed to take place. The seller in the e-Document confirmation communicates this date.

DateOfTrading

A date or date range when the supply of goods or services were made or completed. Normally this is the date of delivery but it can be other dates

papiNet V2R31

depending on terms of delivery (for example the despatch date).

DeliveryNotAllowed

Delivery must not take place during the dates specified.

DeliveryRequestedDate

The date on which a buyer requests goods to be delivered. Delivery will happen at this date on a "best endeavours" basis.

DoNotDeliverAfterDate

The delivery must not take place after the date specified.

DoNotShipAfterDate

The shipment must not take place after the date specified.

EndCallOffDate

The date on which the last CallOff can be placed.

EndJobDate

The date and time when a job was completed. For example when a forest machine completed the work in a logging area.

EstimatedTimeOfArrival

The expected time that the goods will arrive. Receiving facilities should be available.

EstimatedTimeOfDeparture

The date and time that the shipment is expected to leave.

LastChangeDate

The most recent date the document was changed.

LoadingDate

The date on which loading should or is planned to take place.

LoadingSlotDate

LoadingSlotDate informs the date and time window when loading is scheduled.

PostingDate

The posting date determines the booking period and defines in which fiscal period the document will be booked.

PickUpDate

The date the material will be, or is available to be, picked-up from the shipping location.

PlannedShipDate

The date on which shipment is planned to take place.

ResourceDeliveryDate

The date and time when the resource is expected to be delivered.

ResourceRequestedDate

The date and time when the resource is requested to be delivered.

ReferencePeriod

A period of time covered by the object, e.g. an e-Document.

ShipmentPriorToDate

The shipment (despatch) must take place prior to this date—in other words; the goods have to leave the terminal.

ShipmentRequestedDate

The date on which shipment is requested to take place.

StanForDFileTransmissionDate

The date and time when a StanForD file was transmitted by a forest machine.

StartCalloffDate

The date on which the first Calloff can be placed.

StartJobDate

The date and time when a job was started. For example when a forest machine started the work in a logging area.

UnloadingSlotDate

UnloadingSlotDate informs the date and time window when unloading is scheduled.

DeliveryDateWindow

A group item defining the date/time interval for delivery to take place. An element which may contain the estimated date for which delivery is expected. This date is not absolute.

DeliveryDateType [attribute]

DeliveryDateType is mandatory. A single instance is required.

Provides a context for the delivery date window.

Refer to DeliveryDateType definition for any enumerations.

(choice)

[choice] is mandatory. A single instance is required.

DateTimeRange

DateTimeRange is mandatory. A single instance is required.

Specifies a date and/or time range.

Year

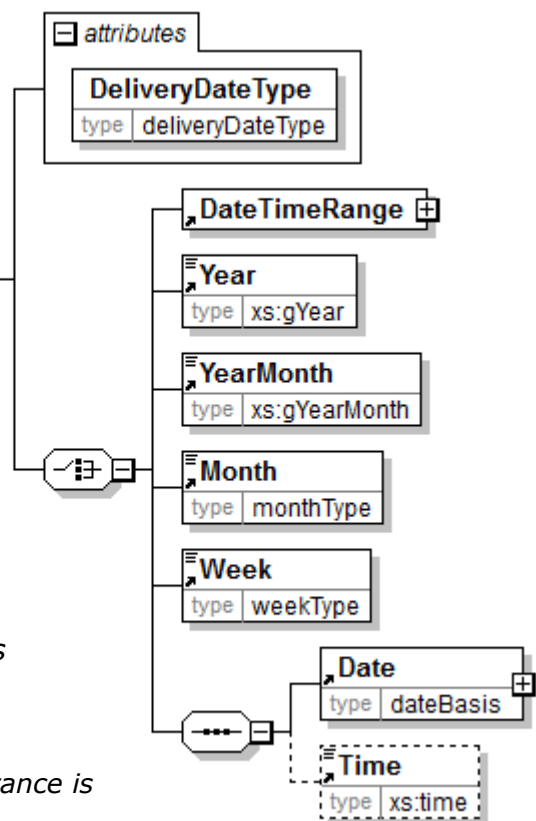

papiNet V2R31

Year is mandatory. A single instance is required.

Identifies the year number when communicating a Calendar date.

YearMonth

YearMonth is mandatory. A single instance is required.

Identifies the month of the calendar year according to format specified by ISO 8601, The ISO 8601 format for the month of the calendar year is YYYY-MM, for example 2016-10.

Month

Month is mandatory. A single instance is required.

Identifies the month number when communicating a Calendar date. Month in DeliveryDateWindow will be deprecated in a future version V3R00. Use YearMonth instead of Month.

Week

Week is mandatory. A single instance is required.

A field defining the week number of the calendar year. ISO 8601 is used as the basis for this element, "Week 01 of a year is the first week that has the Thursday in this year, which is equivalent to the week that contains the fourth day of January." The ISO week starts on Monday. The ISO 8601 extended format of the week number is yyyy-Www, for example 2016-W51.

(sequence)

The sequence of items below is mandatory. A single instance is required.

Date

Date is mandatory. A single instance is required.

A group element that contains the specification of Year, Month, and Day.

Time

Time is optional. A single instance might exist.

Times are treated in a standard XML fashion with a special case used to indicate a generalized "local" time. The standard XML approach to time is hh:mm:ss, hh:mm:ssZ, or hh:mm:ss±hh:mm.

hh:mm:ss±hh:mm is used to represent a time with a time zone. The time zone is communicated as the number of hours offset from the Universal Time Coordinate (UTC), a.k.a. Greenwich Mean Time.

hh:mm:ssZ indicates the time at Zulu (another name for UTC).

hh:mm:ss or hh:mm indicates within papiNet the applicable local time where the associated event is taking place. Caution should be used when processing times of this nature as the papiNet approach may be in discord with other users of XML.

DeliveryDestination

The DeliveryDestination specifies the end of one leg of the delivery. In order to comply with the US Trade Act of 2002 you would use this element with a LocationParty/@PartyType of Port.

IsOptionalDestination [attribute]

IsOptionalDestination is optional. A single instance might exist.

Specifies if the Destination is optional or not. The default value is "No".

Refer to IsOptionalDestination definition for any enumerations.

PriorityOrder [attribute]

PriorityOrder is optional. A single instance might exist.

Specifies the priority order of the item as a two digit positive integer. Value 1 is the highest priority.

(sequence)

The sequence of items below is mandatory. A single instance is required.

Date

Date is optional. A single instance might exist.

A group element that contains the specification of Year, Month, and Day.

Time

Time is optional. A single instance might exist.

Times are treated in a standard XML fashion with a special case used to indicate a generalized "local" time. The standard XML approach to time is hh:mm:ss, hh:mm:ssZ, or hh:mm:ss±hh:mm.

hh:mm:ss±hh:mm is used to represent a time with a time zone. The time zone is communicated as the number of hours offset from the Universal Time Coordinate (UTC), a.k.a. Greenwich Mean Time.

hh:mm:ssZ indicates the time at Zulu (another name for UTC).

hh:mm:ss or hh:mm indicates within papiNet the applicable local time where the associated event is taking place. Caution should be used when processing times of this nature as the papiNet approach may be in discord with other users of XML.

LocationParty

LocationParty is mandatory. A single instance is required.

The organization or business entity where the business event took place or will take

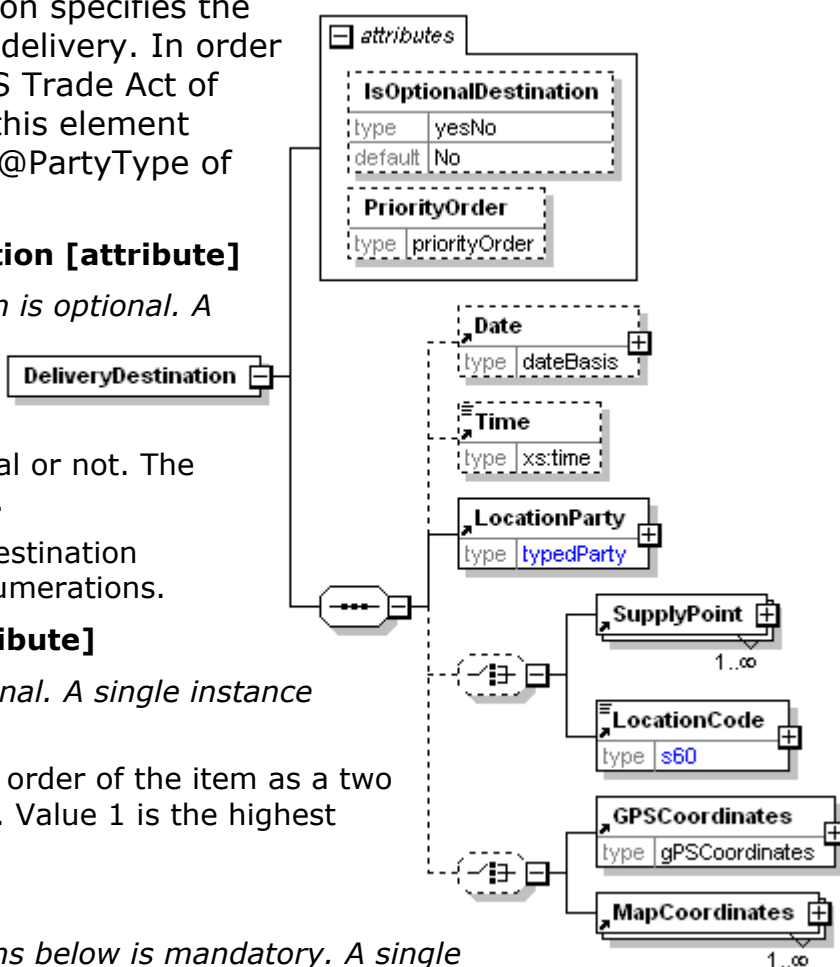

place.

(choice)

[choice] is optional. A single instance might exist.

SupplyPoint

SupplyPoint is mandatory. One instance is required, multiple instances might exist.

Grouping element that contains items describing a supply point. A SupplyPoint belongs to a LocationParty, e.g. in a DeliveryOrigin or DeliveryDestination, and describes where goods are stored and can be loaded or unloaded. A SupplyPoint can for example be a loading or unloading gate at a warehouse or a road side landing at a logging area in the forest.

LocationCode

LocationCode is mandatory. A single instance is required.

A code used to identify a specific physical location within a site identified by a party, e.g. a loading station in a warehouse or an unloading station at a printer site.

LocationCode will be deprecated in a future version V3R00. Use SupplyPoint instead of LocationCode.

(choice)

[choice] is optional. A single instance might exist.

GPSCoordinates

GPSCoordinates is mandatory. A single instance is required.

The location of the party as specified using a Global Positioning System.

This element will be deprecated in a future version V3R00 and should not be used in new implementations. Use instead the MapCoordinates.

MapCoordinates

MapCoordinates is mandatory. One instance is required, multiple instances might exist.

A group item defining and containing position coordinates of a location.

DeliveryIndicator

Indicates if delivery should take place or not.

This item is restricted to the following list.

Deliver

DoNotDeliver

DeliveryIndicator
type deliveryIndicator

DeliveryInfo

Information about the delivery.

(sequence)

The sequence of items below is mandatory. A single instance is required.

TermsOfDelivery

TermsOfDelivery is optional. A single instance might exist.

A group item defining the terms under which the delivery of goods will take place. These terms determine when and under what conditions the transfer of ownership will occur. Generally speaking, the Incoterms are primarily used in Europe, whereas the ShipmentMethodOfPayment is primarily used in North America.

CarrierParty

CarrierParty is optional. A single instance might exist.

The party performing the transport of the product from the pickup location to the ship-to location; could be a hauler.

TransportVehicleCharacteristics

TransportVehicleCharacteristics is optional. A single instance might exist.

A group item containing information about a transport vehicle, e.g. a truck. A transport vehicle has its own power and can be used to pull, push, carry, or tow a transport unit loaded with goods.

TransportModeCharacteristics

TransportModeCharacteristics is optional. A single instance might exist.

A group item defining the primary mode of transport.

TransportUnitCharacteristics

TransportUnitCharacteristics is optional. Multiple instances might exist.

A group item containing information about a transport unit, e.g. a trailer. Transport units contain goods and move using power from another source, the transport vehicle.

DeliveryOrigin

DeliveryOrigin is optional. A single instance might exist.

A group item that represents the start of one leg in a route. Compare to DeliveryDestination.

The DeliveryOrigin specifies the start of one leg of the delivery.

In order to comply with the US Trade Act of 2002 you would use this element with a LocationParty/@PartyType of Port.

DeliveryDestination

DeliveryDestination is optional. A single instance might exist.

The DeliveryDestination specifies the end of one leg of the delivery. In order to comply with the US Trade Act of 2002 you would use this element with a LocationParty/@PartyType of Port.

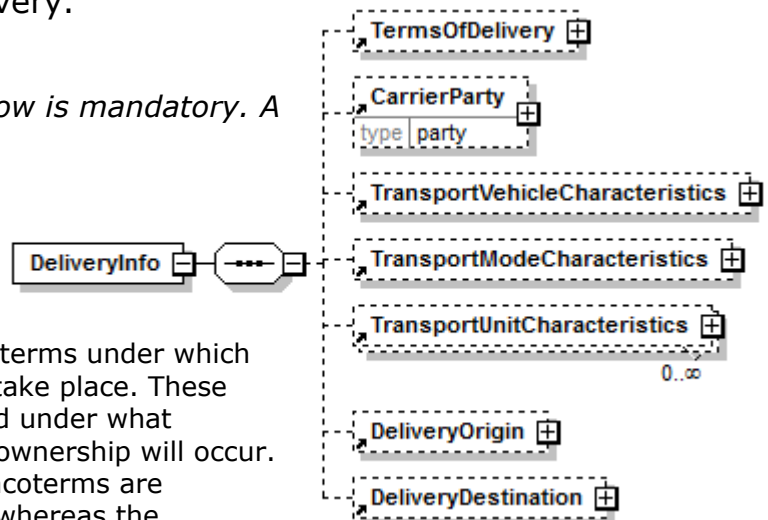

DeliveryInstruction

A DeliveryInstruction element is the root element for the DeliveryInstruction e-Document.

A DeliveryInstruction can be used to instruct movement of goods to warehouses and movement of goods to virtual locations within warehouses as well as deliveries to customers. The DeliveryInstruction e-Document is designed to fulfil supply chain requirements regarding instruction for goods deliveries to Mills, Suppliers, Forwarders, Warehouse Operators, Customers, and End-Users. The DeliveryInstruction is load oriented which is very efficient when mills and suppliers move goods in large quantities between warehouses.

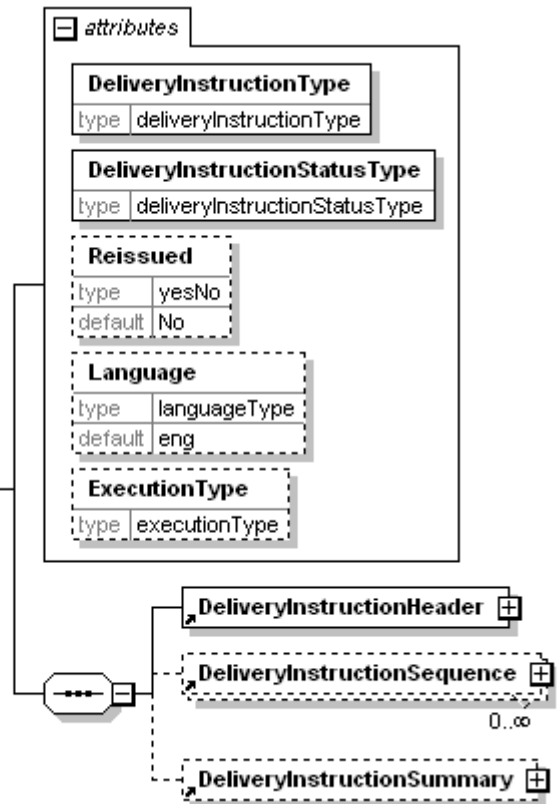

DeliveryInstructionType [attribute]

DeliveryInstructionType is mandatory. A single instance is required.

DeliveryInstructionType defines the type of DeliveryInstruction.

Refer to DeliveryInstructionType definition for any enumerations.

DeliveryInstructionStatusType [attribute]

DeliveryInstructionStatusType is mandatory. A single instance is required.

Identifies the status of the entire DeliveryInstruction (in other words, at the root level).

Refer to DeliveryInstructionStatusType definition for any enumerations.

Reissued [attribute]

Reissued is optional. A single instance might exist.

Either "Yes" or "No".

Refer to Reissued definition for any enumerations.

Language [attribute]

Language is optional. A single instance might exist.

The valid Alpha 2- and Alpha 3-character list of language codes in the ISO 639-1 and 639-2 international standards.

Information on the content of this attribute is available at:
https://www.loc.gov/standards/iso639-2/php/code_list.php

ExecutionType [attribute]

Communicates the type of content of a DeliveryInstruction e-Document.
Refer to ExecutionType definition for any enumerations.

(sequence)

The sequence of items below is mandatory. A single instance is required.

DeliveryInstructionHeader

DeliveryInstructionHeader is mandatory. A single instance is required.

The DeliveryInstruction Header provides information that applies to the entire DeliveryInstruction.

DeliveryInstructionSequence

DeliveryInstructionSequence is optional. Multiple instances might exist.

The DeliveryInstruction Sequence contains information about a loading or delivery event, depending on the type of DeliveryInstruction being communicated.

DeliveryInstructionSummary

DeliveryInstructionSummary is optional. A single instance might exist.

The DeliveryInstruction Summary provides summary information used to verify the contents of the e-Document.

DeliveryInstructionDate

The Date and Time when the DeliveryInstruction was issued.

(sequence)

The sequence of items below is mandatory. A single instance is required.

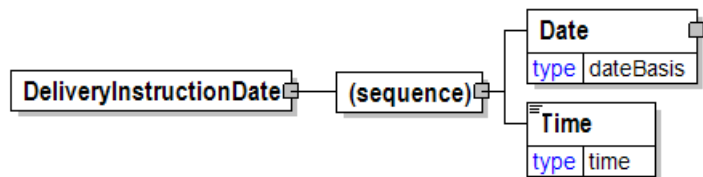

Date

Date is mandatory. A single instance is required.

A group element that contains the specification of Year, Month, and Day.

Time

Time is mandatory. A single instance is required.

Times are treated in a standard XML fashion with a special case used to indicate a generalized "local" time. The standard XML approach to time is hh:mm:ss, hh:mm:ssZ, or hh:mm:ss±hh:mm.

hh:mm:ss±hh:mm is used to represent a time with a time zone. The time zone is communicated as the number of hours offset from the Universal Time Coordinate (UTC), a.k.a. Greenwich Mean Time.

hh:mm:ssZ indicates the time at Zulu (another name for UTC).

hh:mm:ss or hh:mm indicates within papiNet the applicable local time where the associated event is taking place. Caution should be used when processing times of this nature as the papiNet approach may be in discord with other users of XML.

DeliveryInstructionHeader

The DeliveryInstruction Header provides information that applies to the entire DeliveryInstruction.

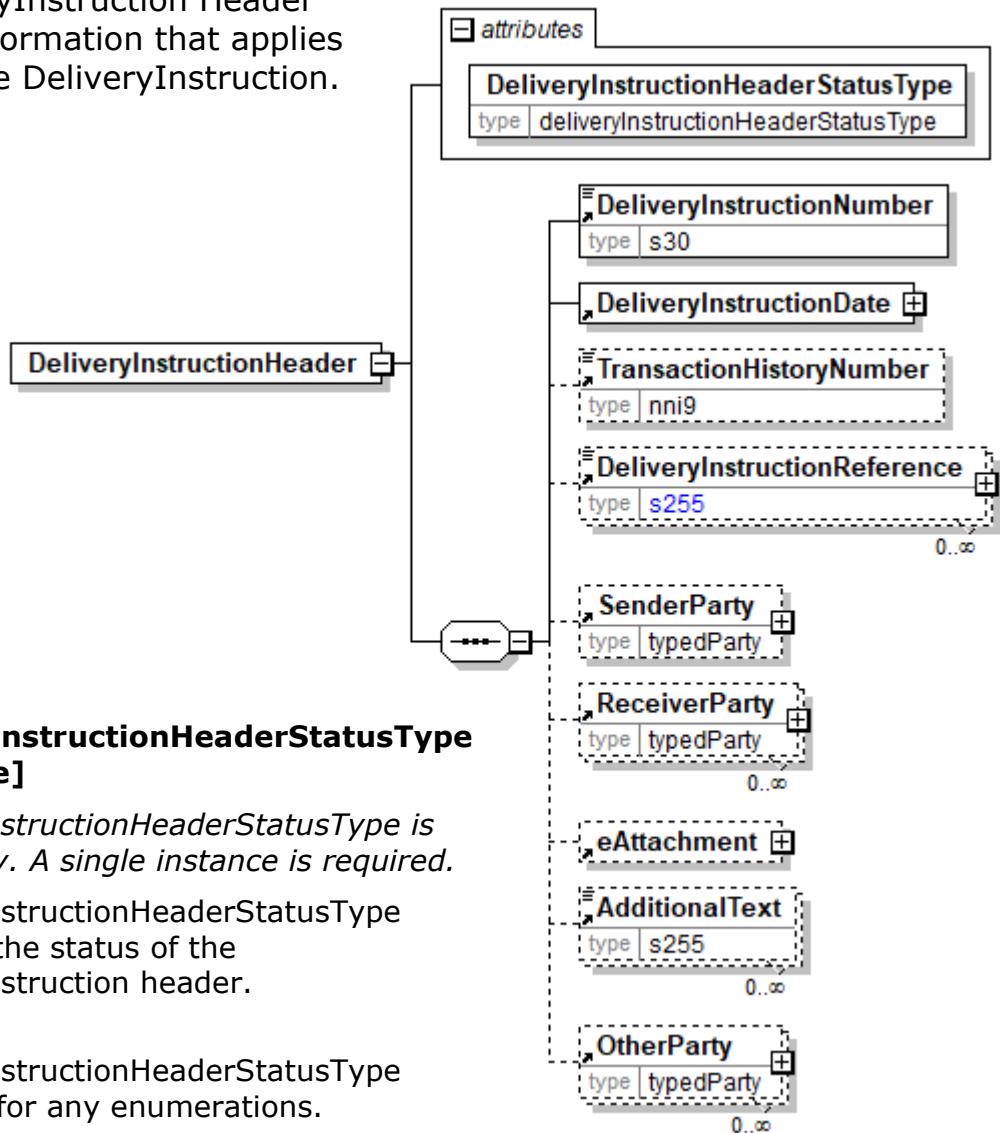

DeliveryInstructionHeaderStatusType [attribute]

DeliveryInstructionHeaderStatusType is mandatory. A single instance is required.

DeliveryInstructionHeaderStatusType identifies the status of the DeliveryInstruction header.

Refer to DeliveryInstructionHeaderStatusType definition for any enumerations.

(sequence)

The sequence of items below is mandatory. A single instance is required.

DeliveryInstructionNumber

DeliveryInstructionNumber is mandatory. A single instance is required.

The unique identifier for the DeliveryInstruction.

DeliveryInstructionDate

DeliveryInstructionDate is mandatory. A single instance is required.

The Date and Time when the DeliveryInstruction was issued.

TransactionHistoryNumber

TransactionHistoryNumber is optional. A single instance might exist.

A sequential number that keeps track of the version of a document.

However when the document is a confirmation document, in which case the TransactionHistoryNumber refers to the trigger transaction for the confirmation.

DeliveryInstructionReference

papiNet V2R31

DeliveryInstructionReference is optional. Multiple instances might exist.

An element detailing relevant references pertaining to the DeliveryInstruction, as indicated by the DeliveryInstructionReferenceType and AssignedBy.

SenderParty

SenderParty is optional. A single instance might exist.

The business entity issuing the e-Document, the source of the document.

The entity responsible for the content. If the sender party has out sourced the message service to a third party the SenderParty is the issuer of the e-Document and not the party performing the transmission service of the electronic message.

ReceiverParty

ReceiverParty is optional. Multiple instances might exist.

The business entity for whom the e-Document is intended, the destination of the document.

The entity interested in the content. If the receiver party has outsourced the message service to a third party the ReceiverParty is the intended party for the e-Document and not the party performing the receiving service of the electronic message.

eAttachment

eAttachment is optional. A single instance might exist.

eAttachment enables the sender to provide information about attachments to the document.

Note: An element "e-Attachment" also exists. papiNet will no longer use hyphens in our element and attribute names as this causes issues with BizTalk.

AdditionalText

AdditionalText is optional. Multiple instances might exist.

A text field that is used to communicate information not previously defined or for special instructions. To be used only for circumstances not covered by specific elements.

OtherParty

OtherParty is optional. Multiple instances might exist.

An organisation or business entity other than those specifically detailed within an e-Document.

DeliveryInstructionHeaderStatusType [attribute]

DeliveryInstructionHeaderStatusType identifies the status of the DeliveryInstruction header.

This item is restricted to the following list.

Amended

The supplied information is changed.

Cancelled

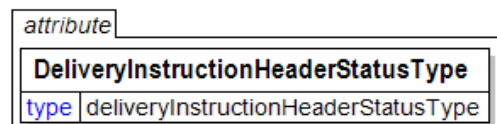

papiNet V2R31

The supplied information has been cancelled. Items that have been cancelled are not included in totals on the summary levels of the e-Document.

New

The supplied information is new and supplied for the first time.

NoAction

The supplied information has not been amended and thereby requires no action.

DeliveryInstructionNumber

The unique identifier for the DeliveryInstruction.

DeliveryInstructionNumber	
type	s30

DeliveryInstructionReference

An element detailing relevant references pertaining to the

DeliveryInstructionReference	
type	s255

attributes	
DeliveryInstructionReferenceType	
type	referenceType
AssignedBy	
type	assignedBy

DeliveryInstruction, as indicated by the DeliveryInstructionReferenceType and AssignedBy.

DeliveryInstructionReferenceType [attribute]

DeliveryInstructionReferenceType is mandatory. A single instance is required.

Provides a contextual explanation of the specific reference identifier. Many items are currently prefixed by "Buyer", "Forwarder", "Manufacturer", "Mill", "Seller", "Supplier", "Warehouse", or "Vendor". Check for an existing non-prefixed version and use the non-prefixed version instead. In the (yet to be announced release date) version 3.0 the prefixed versions will be removed. Instead the attribute @AssignedBy will communicate the information previously communicated in the prefix.

Refer to DeliveryInstructionReferenceType definition for any enumerations.

AssignedBy [attribute]

AssignedBy is optional. A single instance might exist.

Identifies the type of party or the agency that has assigned the associated item, e.g. a reference of type OrderNumber.

Refer to AssignedBy for any enumerations.

DeliveryInstructionReferenceType [attribute]

Provides a contextual explanation of the specific reference identifier. Many items are currently prefixed by "Buyer", "Forwarder", "Manufacturer", "Mill", "Seller", "Supplier", "Warehouse", or "Vendor". Check for an existing non-prefixed version and use the non-prefixed version instead. In the (yet to be announced release date) version 3.0 the prefixed versions will be removed. Instead the attribute @AssignedBy will communicate the information previously communicated in the prefix.

Refer to the [referenceType](#) entry for the list of enumerations and their definitions.

attribute	
DeliveryInstructionReferenceType	
type	referenceType

DeliveryInstructionSequence

The DeliveryInstruction Sequence contains information about a loading or delivery event, depending on the type of DeliveryInstruction being communicated.

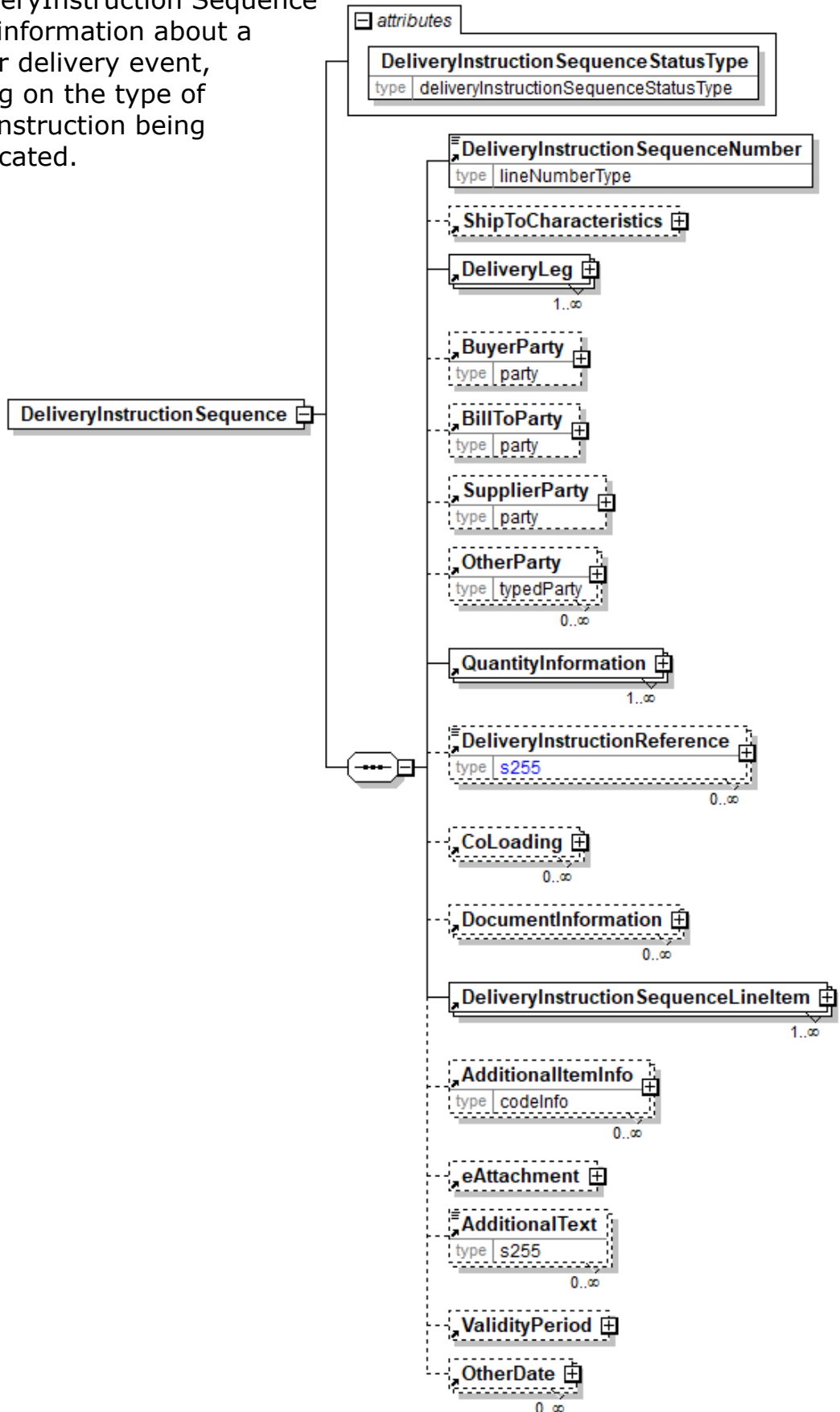

DeliveryInstructionSequenceStatusType [attribute]

DeliveryInstructionSequenceStatusType is mandatory. A single instance is required.

DeliveryInstruction sequence status type identifies the status of the DeliveryInstruction sequence

Refer to DeliveryInstructionSequenceStatusType definition for any enumerations.

(sequence)

The sequence of items below is mandatory. A single instance is required.

DeliveryInstructionSequenceNumber

DeliveryInstructionSequenceNumber is mandatory. A single instance is required.

A sequential number that uniquely identifies the Sequence of a DeliveryInstruction.

ShipToCharacteristics

ShipToCharacteristics is optional. A single instance might exist.

A group item that provides information important for the Ship-To Party.

DeliveryLeg

DeliveryLeg is mandatory. One instance is required, multiple instances might exist.

A DeliveryLeg details the sequence, origin, transportation, and destination of each part of the delivery. More than one leg may be required if there is a change of mode, vehicle, or carrier.

Although transportation information is optional, it is strongly recommended that any transportation information available be sent.

BuyerParty

BuyerParty is optional. A single instance might exist.

The legal entity to which the product is sold. Also commonly referred to as the sold-to party or customer. If no OtherParty is defined as the Payer, the Buyer is the Payer.

BillToParty

BillToParty is optional. A single instance might exist.

The address where the Invoice is to be sent.

SupplierParty

SupplierParty is optional. A single instance might exist.

The organisation or business entity responsible for providing the product. SupplierParty is also the seller of the product, if Seller is not specified as OtherParty = Seller.

OtherParty

OtherParty is optional. Multiple instances might exist.

An organisation or business entity other than those specifically detailed within an e-Document.

QuantityInformation

QuantityInformation is mandatory. One instance is required, multiple instances might exist.

A group item containing information about quantity and informational quantity of similar items.

DeliveryInstructionReference

DeliveryInstructionReference is optional. Multiple instances might exist.

An element detailing relevant references pertaining to the DeliveryInstruction, as indicated by the DeliveryInstructionReferenceType and AssignedBy.

CoLoading

CoLoading is optional. Multiple instances might exist.

A group item specifying information about items to be loaded or loaded on the same transport unit.

Used to identify:

- Delivery together to the drop point
- Transport Orders stuffed together in a container
- Transport Orders not splittable

DocumentInformation

DocumentInformation is optional. Multiple instances might exist.

A group element containing a specification of required documents in the business process. Additional free text to be printed on documents can also be specified.

DeliveryInstructionSequenceLineItem

DeliveryInstructionSequenceLineItem is mandatory. One instance is required, multiple instances might exist.

The group item DeliveryInstructionSequenceLineItem contains information for a line item of a DeliveryInstruction sequence. The line item specifies detail information about product quantities, loading and unloading characteristics, order numbers and other references.

AdditionalItemInfo

AdditionalItemInfo is optional. Multiple instances might exist.

A grouping element that contains information about additional items specified by an agency. Restricted use of this element is recommended.

eAttachment

eAttachment is optional. A single instance might exist.

eAttachment enables the sender to provide information about attachments to the document.

Note: An element "e-Attachment" also exists. papiNet will no longer use hyphens in our element and attribute names as this causes issues with BizTalk.

AdditionalText

AdditionalText is optional. Multiple instances might exist.

A text field that is used to communicate information not previously defined or for special instructions. To be used only for circumstances not covered by specific elements.

ValidityPeriod

ValidityPeriod is optional. A single instance might exist.

The validity period for a specific item, e.g. the validity period for an e-Document.

OtherDate

OtherDate is optional. Multiple instances might exist.

papiNet V2R31

A date that may not be specifically detailed within a document (example: print date at the PurchaseOrderLineItem).

DeliveryInstructionSequenceLineItem

The group item DeliveryInstructionSequenceLineItem contains information for a line item of a DeliveryInstruction sequence. The line item specifies detail information about product quantities, loading and unloading characteristics, order numbers and other references.

InstructionByType [attribute]

InstructionByType is mandatory. A single instance is required.

Provides the type for how goods are identified on group level when instructed for loading or delivery.

Refer to InstructionByType definition for any enumerations.

(sequence)

The sequence of items below is mandatory. A single instance is required.

DeliveryInstructionSequenceLineItemNumber

DeliveryInstructionSequenceLineItemNumber is mandatory. A single instance is required.

A sequential number that uniquely identifies the line item of a DeliveryInstructionSequence.

PurchaseOrderInformation

PurchaseOrderInformation is optional. A single instance might exist.

A group item containing information unique to this PurchaseOrder, which is provided by the buyer. PurchaseOrderInformation can be optional in the supply chain. Invoices are created without having a PurchaseOrder in Vendor Managed Inventory. Freight invoices also will not have a PurchaseOrder number.

PurchaseOrderLineItemNumber

PurchaseOrderLineItemNumber is optional. A single instance might exist.

The sequential number that uniquely identifies the PurchaseOrder line item.

MillOrderNumber

MillOrderNumber is optional. A single instance might exist.

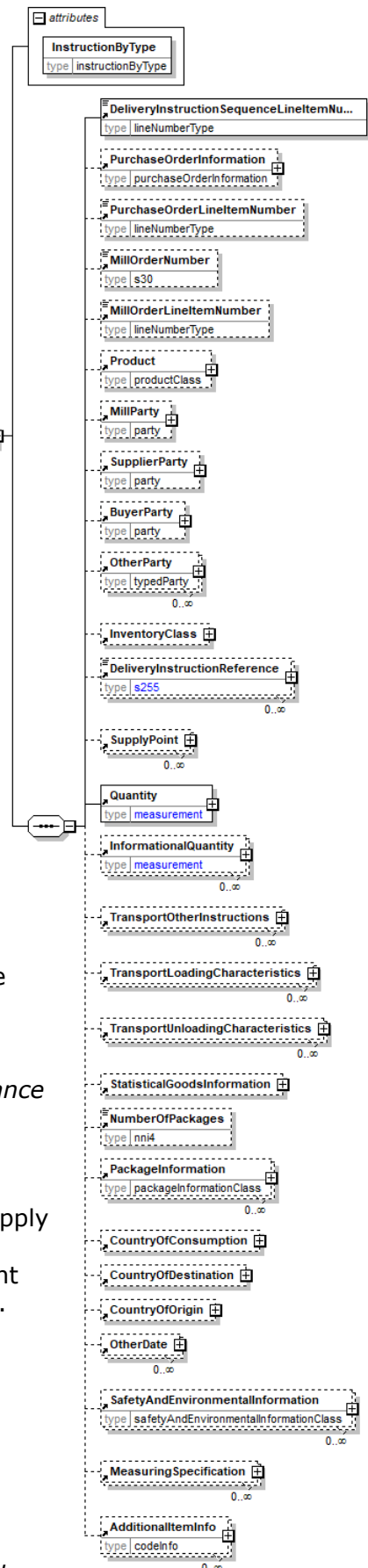

The manufacturing order number the mill uses.

MillOrderLineItemNumber

MillOrderLineItemNumber is optional. A single instance might exist.

A number that uniquely identifies the line items of the Mill Order.

Product

Product is optional. A single instance might exist.

Product is a group item defining the article and its characteristics. Product is used to specify product characteristics organized by ProductIdentifier, ProductDescription, and Classification. Book Manufacturing, Label Stock, Paper, Pulp, Recovered Paper, Wood Products, and Virgin Fibre market segments have defined their product characteristics and conversion features for implementation in papiNet.

MillParty

MillParty is optional. A single instance might exist.

The organisation or business entity that actually produces the product.

SupplierParty

SupplierParty is optional. A single instance might exist.

The organisation or business entity responsible for providing the product. SupplierParty is also the seller of the product, if Seller is not specified as OtherParty = Seller.

BuyerParty

BuyerParty is optional. A single instance might exist.

The legal entity to which the product is sold. Also commonly referred to as the sold-to party or customer. If no OtherParty is defined as the Payer, the Buyer is the Payer.

OtherParty

OtherParty is optional. Multiple instances might exist.

An organisation or business entity other than those specifically detailed within an e-Document.

InventoryClass

InventoryClass is optional. A single instance might exist.

A group item containing information about status of inventory and goods items.

DeliveryInstructionReference

DeliveryInstructionReference is optional. Multiple instances might exist.

An element detailing relevant references pertaining to the DeliveryInstruction, as indicated by the DeliveryInstructionReferenceType and AssignedBy.

SupplyPoint

SupplyPoint is optional. Multiple instances might exist.

Grouping element that contains items describing a supply point. A SupplyPoint belongs to a LocationParty, e.g. in a DeliveryOrigin or DeliveryDestination, and describes where goods are stored and can be loaded or unloaded. A SupplyPoint can for example be a loading or unloading gate at a warehouse or a road side landing at a logging area in the forest.

Quantity

Quantity is mandatory. A single instance is required.

The Quantity element contains attributes that provide information about the type of quantity that is being communicated, the context in which the particular quantity is to be viewed, and (if the quantity represents an adjustment) an adjustment type.

The Quantity element contains three child elements that enable you to communicate a range of values for the quantity and a target or actual value. It is at this level (Value, RangeMin, and RangeMax) that the unit of measure is specified. This permits the range to be specified in a different unit of measure than the target.

InformationalQuantity

InformationalQuantity is optional. Multiple instances might exist.

A quantity given in a valid UOM used for information purposes only (not for calculation). For example, an ordered quantity was 100 reels as opposed to the invoice quantity of 20,000 pounds.

TransportOtherInstructions

TransportOtherInstructions is optional. Multiple instances might exist.

A group item defining any other instructions for the transport not covered in the description of transport mode, vehicle, unit, and loading characteristics or defining an alternative description for the categories mentioned above.

TransportLoadingCharacteristics

TransportLoadingCharacteristics is optional. Multiple instances might exist.

A group item defining how the transported items are to be loaded.

TransportUnloadingCharacteristics

TransportUnloadingCharacteristics is optional. Multiple instances might exist.

A group item defining how the transported items are to be unloaded.

StatisticalGoodsInformation

StatisticalGoodsInformation is optional. A single instance might exist.

A group item containing statistical information about handled or traded goods.

NumberOfPackages

NumberOfPackages is optional. A single instance might exist.

The number of packages in the delivery.

PackageInformation

PackageInformation is optional. Multiple instances might exist.

The purpose of the PackageInformation structure is to clearly identify physical handling items that constitute the delivery.

PackageInformation is the highest level of product packaging it describes the shipping or warehousing unit.

If you are communicating a package, usually for logistics or transport purposes, you should include the PackageType, Identifier, ItemCount, and Quantity. (Note: you still have the ability to describe the item with one of the "named" items.)

If you are communicating one of the named Items there is no need to include PackageType, Identifier, ItemCount, and Quantity.

Since either of these two approaches can be used the entire contents of this element are optional even though the parent may be required. It is expected that

papiNet V2R31

you will fill in the appropriate details.

CountryOfConsumption

CountryOfConsumption is optional. A single instance might exist.

The country of consumption for the material.

CountryOfDestination

CountryOfDestination is optional. A single instance might exist.

The country where the goods will be, or were, shipped to.

CountryOfOrigin

CountryOfOrigin is optional. A single instance might exist.

The country of origin for the material.

OtherDate

OtherDate is optional. Multiple instances might exist.

A date that may not be specifically detailed within a document (example: print date at the PurchaseOrderLineItem).

SafetyAndEnvironmentalInformation

SafetyAndEnvironmentalInformation is optional. Multiple instances might exist.

Name of certification type, if any, on the goods (For example, FSC, PEFC). SafetyAndEnvironmental needs a value or measurement to communicate the percentage of the product is certified (for example, 75% is certified by the indicated agency).

MeasuringSpecification

MeasuringSpecification is optional. Multiple instances might exist.

A grouping element that contains a specification for measurement procedures for a measuring party at a measuring location.

AdditionalItemInfo

AdditionalItemInfo is optional. Multiple instances might exist.

A grouping element that contains information about additional items specified by an agency. Restricted use of this element is recommended.

DeliveryInstructionSequenceLineItemNumber

A sequential number that uniquely identifies the line item of a DeliveryInstructionSequence.

DeliveryInstructionSequenceLineItemNumber	
type	lineNumberType

DeliveryInstructionSequenceNumber

A sequential number that uniquely identifies the Sequence of a DeliveryInstruction.

DeliveryInstructionSequenceNumber	
type	lineNumberType

DeliveryInstructionSequenceStatusType [attribute]

DeliveryInstruction sequence status type identifies the status of the DeliveryInstruction sequence

attribute

DeliveryInstructionSequenceStatusType

type deliveryInstructionSequenceStatusType

This item is restricted to the following list.

Cancelled

The supplied information has been cancelled. Items that have been cancelled are not included in totals on the summary levels of the e-Document.

New

The supplied information is new and supplied for the first time.

NoAction

The supplied information has not been amended and thereby requires no action.

Replaced

The supplied information is replacing earlier supplied information. The receiver should revalidate the information in their system based upon the entire information received.

DeliveryInstructionStatusType [attribute]

Identifies the status of the entire DeliveryInstruction (in other words, at the root level).

attribute

DeliveryInstructionStatusType

type deliveryInstructionStatusType

This item is restricted to the following list.

Amended

The supplied information is changed

Cancelled

The supplied information has been cancelled. Items that have been cancelled are not included in totals on the summary levels of the e-Document.

Original

The supplied information is the first version of that information.

DeliveryInstructionSummary

The DeliveryInstruction Summary provides summary information used to verify the contents of the e-Document.

(sequence)

The sequence of items below is mandatory. A single instance is required.

DeliveryInstructionSummary

(sequence)

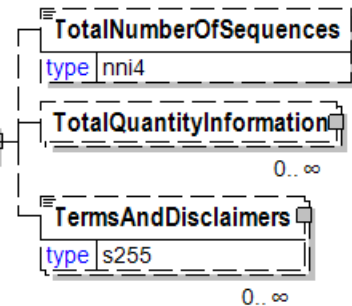

TotalNumberOfSequences

TotalNumberOfSequences is optional. A single instance might exist.

The total number of sequences in the document.

TotalQuantityInformation

TotalQuantityInformation is optional. Multiple instances might exist.

A group item containing information about the total quantity and total informational quantity of similar items in the document. TotalQuantityInformation is primarily used in the summary section of e-Documents where it is repeatable to permit totalling for different units of measure.

TermsAndDisclaimers

TermsAndDisclaimers is optional. Multiple instances might exist.

An element that contains legal information with an indication of what the Language is.

DeliveryInstructionType [attribute]

DeliveryInstructionType defines the type of DeliveryInstruction.

This item is restricted to the following list.



AvailabilityInstruction

An AvailabilityInstruction can specify many delivery events. Each event can contain quantity for one or many loads, but does not specify the load. A DeliveryInstruction type DeliveryInstruction specifies more details for the events in an AvailabilityInstruction. AvailabilityInstruction can also be handled by the company responsible for the delivery independently if so agreed.

DeliveryInstruction

A DeliveryInstruction can specify many delivery events. Each event can contain quantity for one or many loads. A sequence in a DeliveryInstruction specifies all details for one event. The receiver of a DeliveryInstruction can generate many Loading Instructions from one DeliveryInstruction.

LoadingInstruction

A Loading Instruction specifies loading of transport units. A Forwarder receiving a DeliveryInstruction from a supplier can convert it into many Loading Instructions, which are sent to a Warehouse Operator. A sequence in a Loading Instruction specifies all details how to load one transport unit. A Loading Instruction can include goods from many delivery instructions and

also goods belonging to many suppliers.

DeliveryLastDateOfChange

The final Date and optionally Time that a line item or delivery line may be amended or cancelled by the buyer.

The final Date and optionally Time that a line item or delivery line

may be amended or cancelled by the buyer. For example, the buyer can cancel each a delivery line before the DeliveryLastDateOfChange received from the seller on the OrderConfirmation.

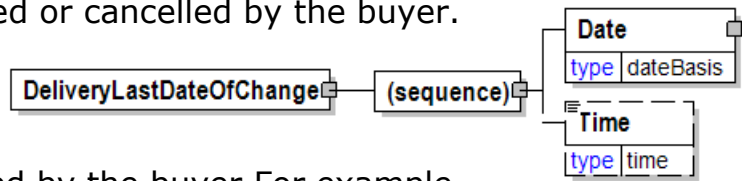

(sequence)

The sequence of items below is mandatory. A single instance is required.

Date

Date is mandatory. A single instance is required.

A group element that contains the specification of Year, Month, and Day.

Time

Time is optional. A single instance might exist.

Times are treated in a standard XML fashion with a special case used to indicate a generalized "local" time. The standard XML approach to time is hh:mm:ss, hh:mm:ssZ, or hh:mm:ss±hh:mm.

hh:mm:ss±hh:mm is used to represent a time with a time zone. The time zone is communicated as the number of hours offset from the Universal Time Coordinate (UTC), a.k.a. Greenwich Mean Time.

hh:mm:ssZ indicates the time at Zulu (another name for UTC).

hh:mm:ss or hh:mm indicates within papiNet the applicable local time where the associated event is taking place. Caution should be used when processing times of this nature as the papiNet approach may be in discord with other users of XML.

DeliveryLeg

A DeliveryLeg details the sequence, origin, transportation, and destination of each part of the delivery. More than one leg may be required if there is a change of mode, vehicle, or carrier.

Although transportation information is optional, it is strongly recommended that any transportation information available be sent.

DeliveryModeType [attribute]

DeliveryModeType is optional. A single instance might exist.

Provides delivery mode type that specifies if transport arrangement is needed or not.

Refer to DeliveryModeType definition for any enumerations.

DeliveryLegType [attribute]

DeliveryLegType is optional. A single instance might exist.

Provides the delivery leg type that specifies if delivery schedule is supplied or not.

Refer to DeliveryLegType definition for any enumerations.

EventType [attribute]

EventType is optional. A single instance might exist.

The type of transportation event that the DeliveryLeg represents.

Refer to EventType definition for any enumerations.

LegStageType [attribute]

LegStageType is optional. A single instance might exist.

LegStageType is used to identify whether this is the primary transportation process or a transportation process that comes before or after the main transportation process.

Refer to LegStageType definition for any enumerations.

TransportContextType [attribute]

TransportContextType is optional. A single instance might exist.

Provides information about the reason for the

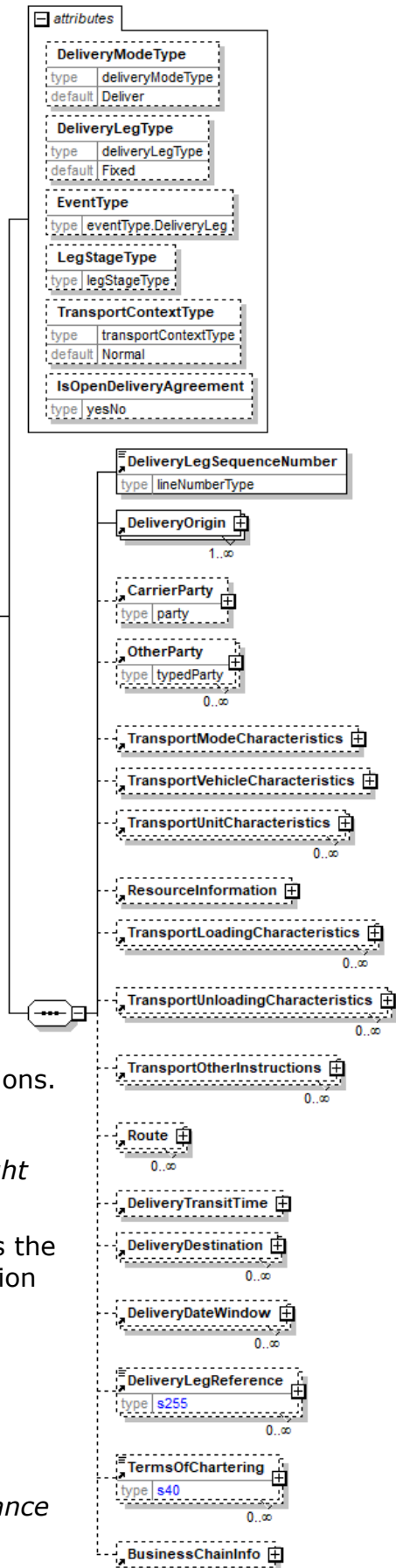

transport.

Refer to TransportContextType definition for any enumerations.

IsOpenDeliveryAgreement [attribute]

IsOpenDeliveryAgreement is optional. A single instance might exist.

Provides information about the reason for the transport.

Refer to IsOpenDeliveryAgreement definition for any enumerations.

(sequence)

The sequence of items below is mandatory. A single instance is required.

DeliveryLegSequenceNumber

DeliveryLegSequenceNumber is mandatory. A single instance is required.

The sequential number of the delivery leg. Applicable to multiple delivery segments.

DeliveryOrigin

DeliveryOrigin is mandatory. One instance is required, multiple instances might exist.

A group item that represents the start of one leg in a route. Compare to DeliveryDestination.

The DeliveryOrigin specifies the start of one leg of the delivery.

In order to comply with the US Trade Act of 2002 you would use this element with a LocationParty/@PartyType of Port.

CarrierParty

CarrierParty is optional. A single instance might exist.

The party performing the transport of the product from the pickup location to the ship-to location; could be a hauler.

OtherParty

OtherParty is optional. Multiple instances might exist.

An organisation or business entity other than those specifically detailed within an e-Document.

TransportModeCharacteristics

TransportModeCharacteristics is optional. A single instance might exist.

A group item defining the primary mode of transport.

TransportVehicleCharacteristics

TransportVehicleCharacteristics is optional. A single instance might exist.

A group item containing information about a transport vehicle, e.g. a truck. A transport vehicle has its own power and can be used to pull, push, carry, or tow a transport unit loaded with goods.

TransportUnitCharacteristics

TransportUnitCharacteristics is optional. Multiple instances might exist.

A group item containing information about a transport unit, e.g. a trailer. Transport units contain goods and move using power from another source, the transport vehicle.

ResourceInformation

papiNet V2R31

ResourceInformation is optional. A single instance might exist.

A group item that contains information for specification of resources.

TransportLoadingCharacteristics

TransportLoadingCharacteristics is optional. Multiple instances might exist.

A group item defining how the transported items are to be loaded.

TransportUnloadingCharacteristics

TransportUnloadingCharacteristics is optional. Multiple instances might exist.

A group item defining how the transported items are to be unloaded.

TransportOtherInstructions

TransportOtherInstructions is optional. Multiple instances might exist.

A group item defining any other instructions for the transport not covered in the description of transport mode, vehicle, unit, and loading characteristics or defining an alternative description for the categories mentioned above.

Route

Route is optional. Multiple instances might exist.

Route defines directions and characteristics for how to transport goods between two locations. A route starts at delivery origin or at the supplypoint belonging to the delivery origin.

DeliveryTransitTime

DeliveryTransitTime is optional. A single instance might exist.

A group item representing the number of Days and optionally Hours and Minutes between origin and destination for a DeliveryLeg.

DeliveryDestination

DeliveryDestination is optional. A Multiple instances might exist.

The DeliveryDestination specifies the end of one leg of the delivery. In order to comply with the US Trade Act of 2002 you would use this element with a LocationParty/@PartyType of Port.

DeliveryDateWindow

DeliveryDateWindow is optional. Multiple instances might exist.

A group item defining the date/time interval for delivery to take place. An element which may contain the estimated date for which delivery is expected. This date is not absolute.

DeliveryLegReference

DeliveryLegReference is optional. Multiple instances might exist.

A reference that applies to the delivery leg.

TermsOfChartering

TermsOfChartering is optional. Multiple instances might exist.

The terms of the vessel chartering. There are multiple types of TermsOfChartering that need to be specified. E.g.: Loading Terms and Unloading Terms

BusinessChainInfo

BusinessChainInfo is optional. A single instance might exist.

A grouping element that contains information about parties in the business chain when products or services are traded in many levels.

The business chain starts at the sourcing end where products are provided when BusinessChainContextType = Product.

The business chain starts at the purchasing of a service from the OriginalLogisticsSupplier when BusinessChainContextType = LogisticsService.

DeliveryLegReference

A reference that applies to the delivery leg.

DeliveryLegReferenceType [attribute]

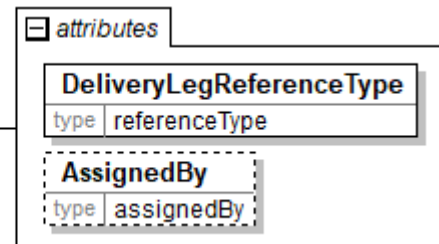

DeliveryLegReferenceType is mandatory. A single instance is required.

Provides a contextual explanation of the specific reference identifier. Many items are currently prefixed by "Buyer", "Forwarder", "Manufacturer", "Mill", "Seller", "Supplier", "Warehouse", or "Vendor". Check for an existing non-prefixed version and use the non-prefixed version instead. In the (yet to be announced release date) version 3.0 the prefixed versions will be removed. Instead the attribute @AssignedBy will communicate the information previously communicated in the prefix.

Refer to DeliveryLegReferenceType definition for any enumerations.

AssignedBy [attribute]

AssignedBy is optional. A single instance might exist.

Identifies the type of party or the agency that has assigned the associated item, e.g. a reference of type OrderNumber.

Refer to AssignedBy for any enumerations.

DeliveryLegReferenceType [attribute]

Provides a contextual explanation of the specific reference identifier. Many items are currently prefixed by "Buyer", "Forwarder",

"Manufacturer", "Mill", "Seller", "Supplier",

"Warehouse", or "Vendor". Check for an existing

non-prefixed version and use the non-prefixed version instead. In the (yet to be announced release date) version 3.0 the prefixed versions will be removed. Instead the attribute @AssignedBy will communicate the information previously communicated in the prefix.

Refer to the [referenceType](#) entry for the list of enumerations and their definitions.

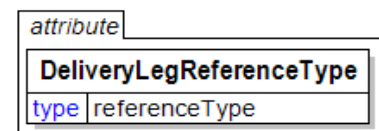

DeliveryLegSequenceNumber

The sequential number of the delivery leg.
Applicable to multiple delivery segments.

DeliveryLegSequenceNumber	
type	lineNumberType

DeliveryLegType [attribute]

Provides the delivery leg type that specifies if delivery schedule is supplied or not.

This item is restricted to the following list.

Fixed

The delivery schedule is supplied and defined.

Open

The delivery schedule is open and will be given later by other party. This type is often used when goods are picked-up at the warehouse by customer.

DeliveryLegType	
type	deliveryLegType
default	Fixed

DeliveryLineNumber

A sequential number that uniquely identifies a delivery line of the DeliverySchedule; a delivery line consists of a quantity and a date range for the delivery to take place.

DeliveryLineNumber	
type	lineNumberType

DeliveryMessage

The DeliveryMessage element is the root element for the DeliveryMessage e-Document.

The DeliveryMessage e-Document enables the sender to describe the contents and configuration of a shipment at various levels of detail.

DeliveryMessageType [attribute]

DeliveryMessageType is mandatory. A single instance is required.

DeliveryMessageType defines the type of DeliveryMessage.

Refer to DeliveryMessageType definition for any enumerations.

DeliveryMessageStatusType [attribute]

DeliveryMessageStatusType is mandatory. A single instance is required.

Identifies the status of the entire DeliveryMessage (in other words, at the root level).

Refer to DeliveryMessageStatusType definition for any enumerations.

DeliveryMessageContextType [attribute]

DeliveryMessageContextType is optional. A single instance might exist.

Communicates the reason for this delivery. If not present then this is a standard, typical delivery.

Refer to DeliveryMessageContextType definition for any enumerations.

Reissued [attribute]

Reissued is optional. A single instance might exist.

Either "Yes" or "No".

Refer to Reissued definition for any enumerations.

Language [attribute]

Language is optional. A single instance might exist.

The valid Alpha 2- and Alpha 3-character list of language codes in the ISO 639-1 and 639-2 international standards.

Information on the content of this attribute is available at:
https://www.loc.gov/standards/iso639-2/php/code_list.php

(sequence)

The sequence of items below is mandatory. A single instance is required.

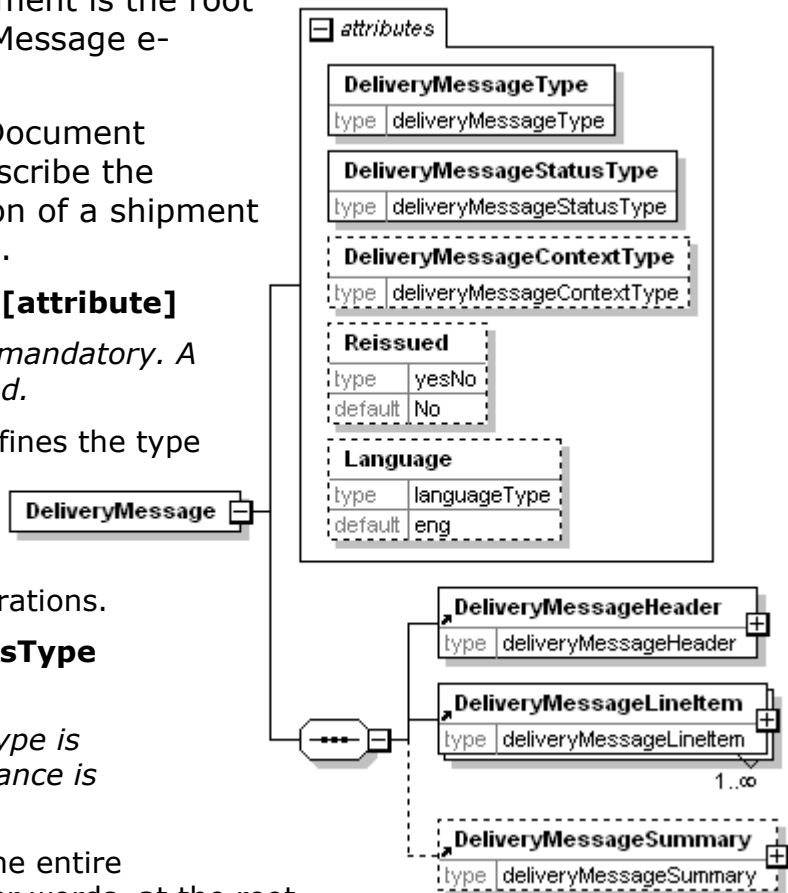

DeliveryMessageHeader

DeliveryMessageHeader is mandatory. A single instance is required.

The DeliveryMessageHeader contains information common to the entire delivery.

DeliveryMessageLineItem

DeliveryMessageLineItem is mandatory. One instance is required, multiple instances might exist.

The DeliveryMessageLineItem specifies details for an individual delivery line.

DeliveryMessageSummary

DeliveryMessageSummary is optional. A single instance might exist.

Summary information that applies to the entire DeliveryMessage.

DeliveryMessageBook

The DeliveryMessageBook element is the root element for the DeliveryMessageBook e-Document.

The DeliveryMessageBook e-Document enables the sender to describe the contents and configuration of a shipment at various levels of detail.

DeliveryMessageBook

DeliveryMessageType [attribute]

DeliveryMessageType is mandatory. A single instance is required.

DeliveryMessageType defines the type of DeliveryMessage.

Refer to DeliveryMessageType definition for any enumerations.

DeliveryMessageStatusType [attribute]

DeliveryMessageStatusType is mandatory. A single instance is required.

Identifies the status of the entire DeliveryMessage (in other words, at the root level).

Refer to DeliveryMessageStatusType definition for any enumerations.

DeliveryMessageContextType [attribute]

DeliveryMessageContextType is optional. A single instance might exist.

Communicates the reason for this delivery. If not present then this is a standard, typical delivery.

Refer to DeliveryMessageContextType definition for any enumerations.

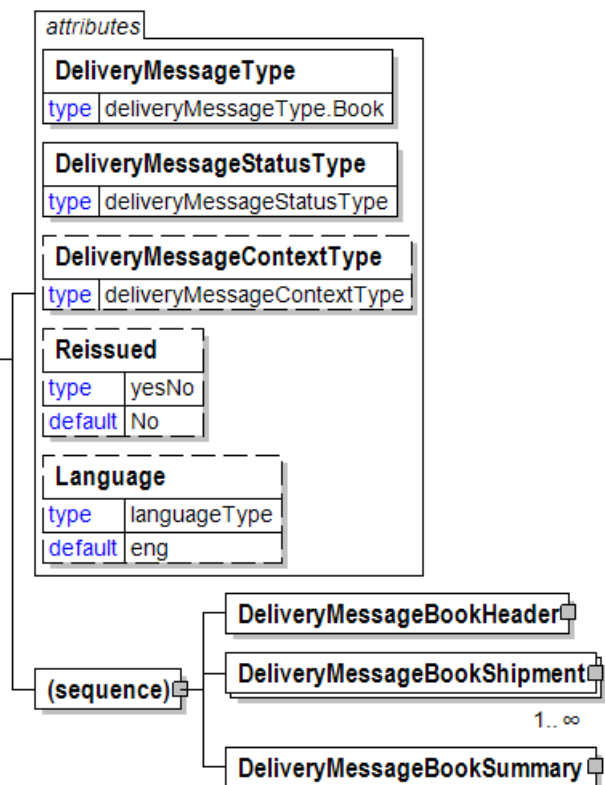

Reissued [attribute]

Reissued is optional. A single instance might exist.

Either "Yes" or "No".

Refer to Reissued definition for any enumerations.

Language [attribute]

Language is optional. A single instance might exist.

The valid Alpha 2- and Alpha 3-character list of language codes in the ISO 639-1 and 639-2 international standards.

Information on the content of this attribute is available at:
https://www.loc.gov/standards/iso639-2/php/code_list.php

(sequence)

The sequence of items below is mandatory. A single instance is required.

DeliveryMessageBookHeader

DeliveryMessageBookHeader is mandatory. A single instance is required.

The DeliveryMessageBookHeader is required and contains information common to the entire delivery.

DeliveryMessageBookShipment

DeliveryMessageBookShipment is mandatory. One instance is required, multiple instances might exist.

DeliveryMessageBookShipment is required. The DeliveryMessageBookShipment specifies an individual shipment. It may contain many shipment line items.

DeliveryMessageBookSummary

DeliveryMessageBookSummary is mandatory. A single instance is required.

DeliveryMessageBookSummary is a required element.

DeliveryMessageBookHeader

The DeliveryMessageBookHeader is required and contains information common to the entire delivery.

(sequence)

The sequence of items below is mandatory. A single instance is required.

DeliveryMessageNumber

DeliveryMessageNumber is mandatory. A single instance is required.

A unique delivery identifier assigned to each DeliveryMessage as agreed between the trading partners.

TransactionHistoryNumber

TransactionHistoryNumber is optional. A single instance might exist.

A sequential number that keeps track of the version of a document.

However when the document is a confirmation document, in which case the TransactionHistoryNumber refers to the trigger transaction for the

confirmation.

DeliveryMessageDate

DeliveryMessageDate is mandatory. A single instance is required.

The Date and Time when the DeliveryMessage was issued.

DeliveryMessageReference

DeliveryMessageReference is optional. Multiple instances might exist.

An element that identifies the relevant references pertaining to the DeliveryMessage, identified by DeliveryMessageReferenceType.

BuyerParty

BuyerParty is mandatory. A single instance is required.

The legal entity to which the product is sold. Also commonly referred to as the sold-to party or customer. If no OtherParty is defined as the Payer, the Buyer is the Payer.

BillToParty

BillToParty is optional. A single instance might exist.

The address where the Invoice is to be sent.

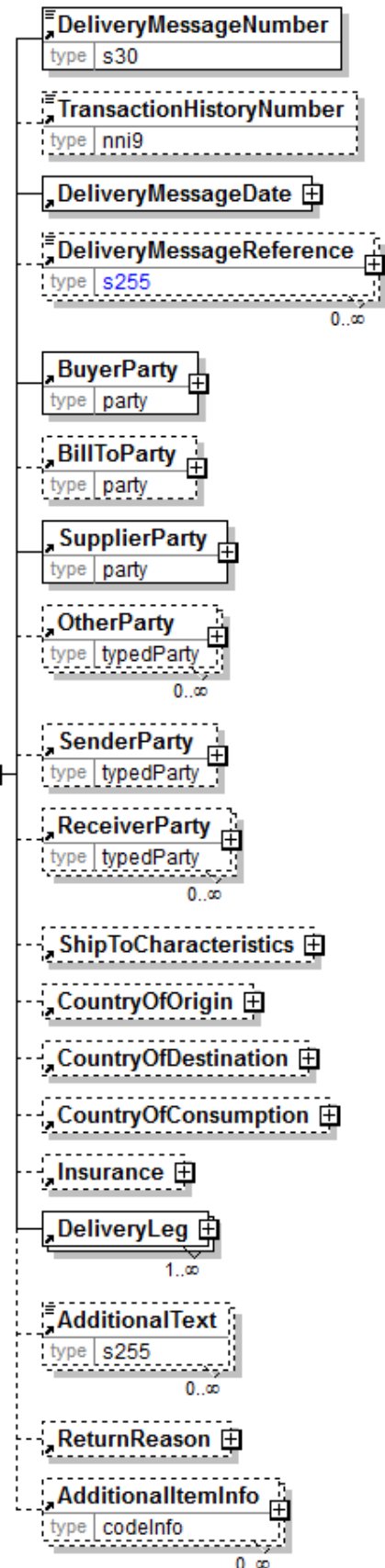

SupplierParty

SupplierParty is mandatory. A single instance is required.

The organisation or business entity responsible for providing the product. SupplierParty is also the seller of the product, if Seller is not specified as OtherParty = Seller.

OtherParty

OtherParty is optional. Multiple instances might exist.

An organisation or business entity other than those specifically detailed within an e-Document.

SenderParty

SenderParty is optional. A single instance might exist.

The business entity issuing the e-Document, the source of the document.

The entity responsible for the content. If the sender party has out sourced the message service to a third party the SenderParty is the issuer of the e-Document and not the party performing the transmission service of the electronic message.

ReceiverParty

ReceiverParty is optional. Multiple instances might exist.

The business entity for whom the e-Document is intended, the destination of the document.

The entity interested in the content. If the receiver party has outsourced the message service to a third party the ReceiverParty is the intended party for the e-Document and not the party performing the receiving service of the electronic message.

ShipToCharacteristics

ShipToCharacteristics is optional. A single instance might exist.

A group item that provides information important for the Ship-To Party.

CountryOfOrigin

CountryOfOrigin is optional. A single instance might exist.

The country of origin for the material.

CountryOfDestination

CountryOfDestination is optional. A single instance might exist.

The country where the goods will be, or were, shipped to.

CountryOfConsumption

CountryOfConsumption is optional. A single instance might exist.

The country of consumption for the material.

Insurance

Insurance is optional. A single instance might exist.

Group element containing information about insurance

DeliveryLeg

DeliveryLeg is mandatory. One instance is required, multiple instances might exist.

A DeliveryLeg details the sequence, origin, transportation, and destination of each part of the delivery. More than one leg may be required if there is a change of

mode, vehicle, or carrier.

Although transportation information is optional, it is strongly recommended that any transportation information available be sent.

AdditionalText

AdditionalText is optional. Multiple instances might exist.

A text field that is used to communicate information not previously defined or for special instructions. To be used only for circumstances not covered by specific elements.

ReturnReason

ReturnReason is optional. A single instance might exist.

A group item containing the reason for the Return

AdditionalItemInfo

AdditionalItemInfo is optional. Multiple instances might exist.

A grouping element that contains information about additional items specified by an agency. Restricted use of this element is recommended.

DeliveryMessageBookShipment

DeliveryMessageBookShipment is required.
The DeliveryMessageBookShipment specifies an individual shipment. It may contain many shipment line items.

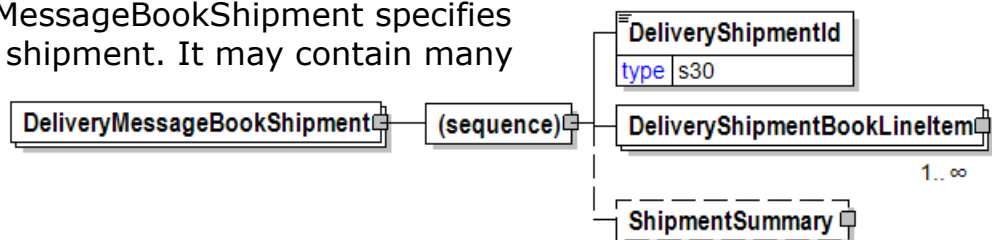

(sequence)

The sequence of items below is mandatory. A single instance is required.

DeliveryShipmentId

DeliveryShipmentId is mandatory. A single instance is required.

Unique identifier for the shipment

DeliveryShipmentBookLineItem

DeliveryShipmentBookLineItem is mandatory. One instance is required, multiple instances might exist.

DeliveryShipmentBookLineItem is required. The DeliveryShipmentBookLineItem specifies an individual shipment delivery line for one PurchaseOrder and PurchaseOrder line item.

ShipmentSummary

ShipmentSummary is optional. A single instance might exist.

Summary information for an entire shipment

DeliveryMessageBookSummary

DeliveryMessageBookSummary is a required element.

(sequence)

The sequence of items below is mandatory. A single instance is required.

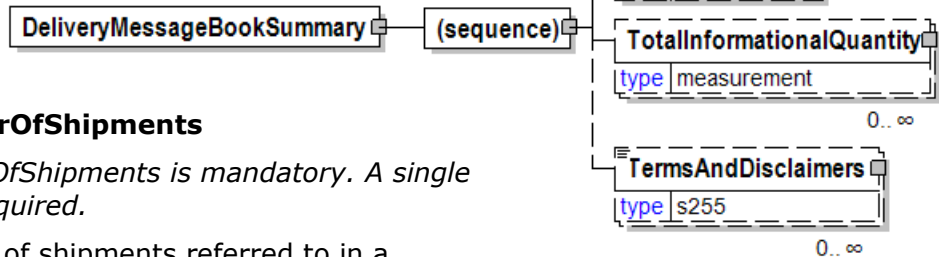

TotalNumberOfShipments

TotalNumberOfShipments is mandatory. A single instance is required.

Total number of shipments referred to in a DeliveryMessage.

TotalQuantity

TotalQuantity is optional. A single instance might exist.

The total quantity of similar items in the e-Document. TotalQuantity is primarily used in the summary section of documents where it is repeatable to permit totaling for different units of measure.

TotalInformationalQuantity

TotalInformationalQuantity is optional. Multiple instances might exist.

A quantity that is used to communicate related information about the parent element. This element represents a total that is derived from individual line items.

TermsAndDisclaimers

TermsAndDisclaimers is optional. Multiple instances might exist.

An element that contains legal information with an indication of what the Language is.

DeliveryMessageContextType [attribute]

Communicates the reason for this delivery. If not present then this is a standard, typical delivery.

This item is restricted to the following list.

Return

The delivery supports the goods return process.

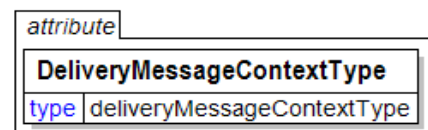

DeliveryMessageDate

The Date and Time when the DeliveryMessage was issued.

(sequence)

The sequence of items below is mandatory. A single instance is required.

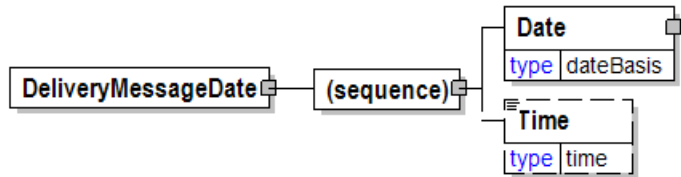

Date

Date is mandatory. A single instance is required.

A group element that contains the specification of Year, Month, and Day.

Time

Time is optional. A single instance might exist.

Times are treated in a standard XML fashion with a special case used to indicate a generalized "local" time. The standard XML approach to time is hh:mm:ss, hh:mm:ssZ, or hh:mm:ss±hh:mm.

hh:mm:ss±hh:mm is used to represent a time with a time zone. The time zone is communicated as the number of hours offset from the Universal Time Coordinate (UTC), a.k.a. Greenwich Mean Time.

hh:mm:ssZ indicates the time at Zulu (another name for UTC).

hh:mm:ss or hh:mm indicates within papiNet the applicable local time where the associated event is taking place. Caution should be used when processing times of this nature as the papiNet approach may be in discord with other users of XML.

DeliveryMessageHeader

The DeliveryMessageHeader contains information common to the entire delivery.

(sequence)

The sequence of items below is mandatory. A single instance is required.

DeliveryMessageNumber

DeliveryMessageNumber is mandatory. A single instance is required.

A unique delivery identifier assigned to each DeliveryMessage as agreed between the trading partners.

TransactionHistoryNumber

TransactionHistoryNumber is optional. A single instance might exist.

A sequential number that keeps track of the version of a document.

However when the document is a confirmation document, in which case the TransactionHistoryNumber refers to the trigger transaction for the confirmation.



DeliveryMessageDate

DeliveryMessageDate is mandatory. A single instance is required.

The Date and Time when the DeliveryMessage was issued.

DeliveryMessageReason

DeliveryMessageReason is optional. Multiple instances might exist.

A group item containing the reason for issuing the DeliveryMessage e-Document.

DeliveryMessageReference

DeliveryMessageReference is optional. Multiple instances might exist.

An element that identifies the relevant references pertaining to the DeliveryMessage, identified by DeliveryMessageReferenceType.

BuyerParty

BuyerParty is optional. A single instance might exist.

The legal entity to which the product is sold.

Also commonly referred to as the sold-to party or customer. If no OtherParty is

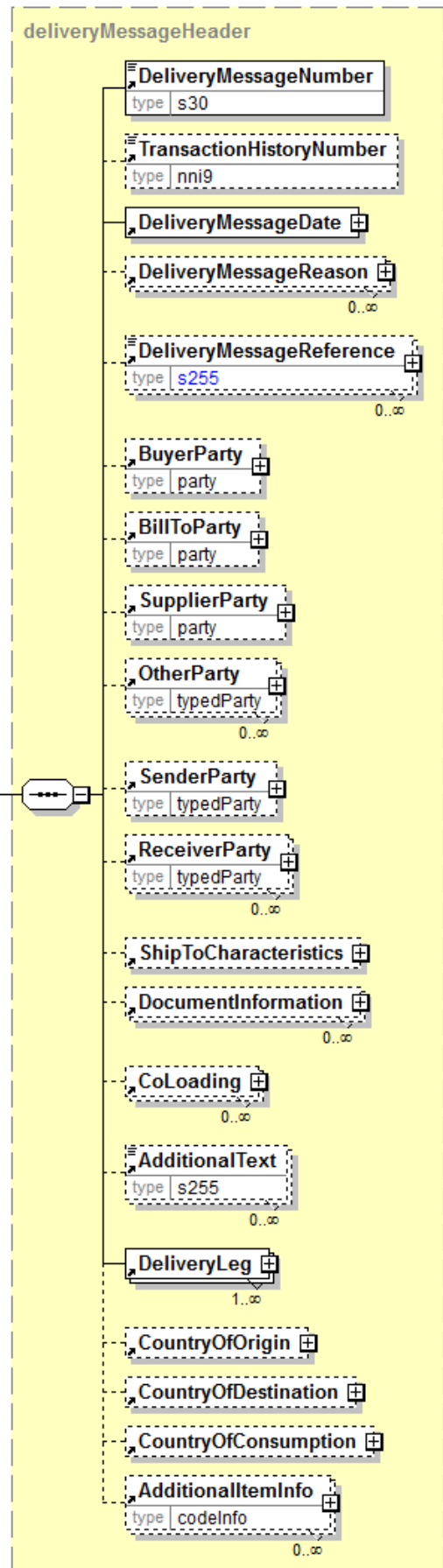

defined as the Payer, the Buyer is the Payer.

BillToParty

BillToParty is optional. A single instance might exist.

The address where the Invoice is to be sent.

SupplierParty

SupplierParty is optional. A single instance might exist.

The organisation or business entity responsible for providing the product.

SupplierParty is also the seller of the product, if Seller is not specified as OtherParty = Seller.

OtherParty

OtherParty is optional. Multiple instances might exist.

An organisation or business entity other than those specifically detailed within an e-Document.

SenderParty

SenderParty is optional. A single instance might exist.

The business entity issuing the e-Document, the source of the document.

The entity responsible for the content. If the sender party has out sourced the message service to a third party the SenderParty is the issuer of the e-Document and not the party performing the transmission service of the electronic message.

ReceiverParty

ReceiverParty is optional. Multiple instances might exist.

The business entity for whom the e-Document is intended, the destination of the document.

The entity interested in the content. If the receiver party has outsourced the message service to a third party the ReceiverParty is the intended party for the e-Document and not the party performing the receiving service of the electronic message.

ShipToCharacteristics

ShipToCharacteristics is optional. A single instance might exist.

A group item that provides information important for the Ship-To Party.

DocumentInformation

DocumentInformation is optional. Multiple instances might exist.

A group element containing a specification of required documents in the business process. Additional free text to be printed on documents can also be specified.

CoLoading

CoLoading is optional. Multiple instances might exist.

A group item specifying information about items to be loaded or loaded on the same transport unit.

Used to identify:

Delivery together to the drop point

Transport Orders stuffed together in a container

Transport Orders not splittable

AdditionalText

AdditionalText is optional. Multiple instances might exist.

A text field that is used to communicate information not previously defined or for special instructions. To be used only for circumstances not covered by specific elements.

DeliveryLeg

DeliveryLeg is mandatory. One instance is required, multiple instances might exist.

A DeliveryLeg details the sequence, origin, transportation, and destination of each part of the delivery. More than one leg may be required if there is a change of mode, vehicle, or carrier.

Although transportation information is optional, it is strongly recommended that any transportation information available be sent.

CountryOfOrigin

CountryOfOrigin is optional. A single instance might exist.

The country of origin for the material.

CountryOfDestination

CountryOfDestination is optional. A single instance might exist.

The country where the goods will be, or were, shipped to.

CountryOfConsumption

CountryOfConsumption is optional. A single instance might exist.

The country of consumption for the material.

AdditionalItemInfo

AdditionalItemInfo is optional. Multiple instances might exist.

A grouping element that contains information about additional items specified by an agency. Restricted use of this element is recommended.

DeliveryMessageLineItem

The DeliveryMessageLineItem specifies details for an individual delivery line.

ShipmentComplete [attribute]

ShipmentComplete is optional. A single instance might exist.

Indicates that all shipments for the particular delivery item are complete

Refer to ShipmentComplete definition for any enumerations.

InstructionByType [attribute]

InstructionByType is optional. A single instance might exist.

Provides the type for how goods are identified on group level when instructed for loading or delivery.

Refer to InstructionByType definition for any enumerations.

(sequence)

The sequence of items below is mandatory. A single instance is required.

DeliveryMessageLineItem Number

DeliveryMessageLineItemNumber is mandatory. A single instance is required.

The sequential number that uniquely identifies the delivery line item.

PurchaseOrderInformation

PurchaseOrderInformation is optional. A single instance might exist.

A group item containing information unique to this PurchaseOrder, which is provided by the buyer. PurchaseOrderInformation can be optional in the supply chain. Invoices are created without having a PurchaseOrder in Vendor Managed Inventory. Freight invoices also will not have a PurchaseOrder number.

PurchaseOrderLineItemNumber

PurchaseOrderLineItemNumber is optional. A single instance might exist.

The sequential number that uniquely identifies the PurchaseOrder line item.

DeliveryMessageReference

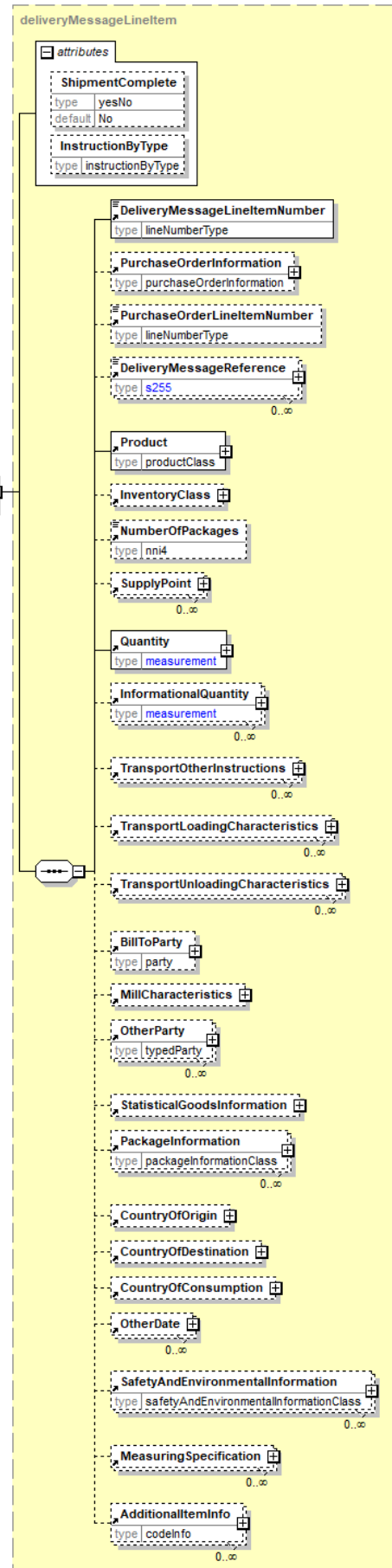
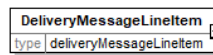

papiNet V2R31

DeliveryMessageReference is optional. Multiple instances might exist.

An element that identifies the relevant references pertaining to the DeliveryMessage, identified by DeliveryMessageReferenceType.

Product

Product is mandatory. A single instance is required.

Product is a group item defining the article and its characteristics. Product is used to specify product characteristics organized by ProductIdentifier, ProductDescription, and Classification. Book Manufacturing, Label Stock, Paper, Pulp, Recovered Paper, Wood Products, and Virgin Fibre market segments have defined their product characteristics and conversion features for implementation in papiNet.

InventoryClass

InventoryClass is optional. A single instance might exist.

A group item containing information about status of inventory and goods items.

NumberOfPackages

NumberOfPackages is optional. A single instance might exist.

The number of packages in the delivery.

SupplyPoint

SupplyPoint is optional. Multiple instances might exist.

Grouping element that contains items describing a supply point. A SupplyPoint belongs to a LocationParty, e.g. in a DeliveryOrigin or DeliveryDestination, and describes where goods are stored and can be loaded or unloaded. A SupplyPoint can for example be a loading or unloading gate at a warehouse or a road side landing at a logging area in the forest.

Quantity

Quantity is mandatory. A single instance is required.

The Quantity element contains attributes that provide information about the type of quantity that is being communicated, the context in which the particular quantity is to be viewed, and (if the quantity represents an adjustment) an adjustment type.

The Quantity element contains three child elements that enable you to communicate a range of values for the quantity and a target or actual value. It is at this level (Value, RangeMin, and RangeMax) that the unit of measure is specified. This permits the range to be specified in a different unit of measure than the target.

InformationalQuantity

InformationalQuantity is optional. Multiple instances might exist.

A quantity given in a valid UOM used for information purposes only (not for calculation). For example, an ordered quantity was 100 reels as opposed to the invoice quantity of 20,000 pounds.

TransportOtherInstructions

TransportOtherInstructions is optional. Multiple instances might exist.

A group item defining any other instructions for the transport not covered in the description of transport mode, vehicle, unit, and loading characteristics or defining an alternative description for the categories mentioned above.

TransportLoadingCharacteristics

TransportLoadingCharacteristics is optional. Multiple instances might exist.

A group item defining how the transported items are to be loaded.

TransportUnloadingCharacteristics

*TransportUnloadingCharacteristics is optional. Multiple instances might exist
A group item defining how the transported items are to be unloaded.*

BillToParty

BillToParty is optional. A single instance might exist.

The address where the Invoice is to be sent.

MillCharacteristics

MillCharacteristics is optional. A single instance might exist.

A group item defining the mill party and machine identifier where a product is or was produced.

OtherParty

OtherParty is optional. Multiple instances might exist.

An organisation or business entity other than those specifically detailed within an e-Document.

StatisticalGoodsInformation

StatisticalGoodsInformation is optional. A single instance might exist.

A group item containing statistical information about handled or traded goods.

PackageInformation

PackageInformation is optional. Multiple instances might exist.

The purpose of the PackageInformation structure is to clearly identify physical handling items that constitute the delivery.

PackageInformation is the highest level of product packaging it describes the shipping or warehousing unit.

If you are communicating a package, usually for logistics or transport purposes, you should include the PackageType, Identifier, ItemCount, and Quantity. (Note: you still have the ability to describe the item with one of the "named" items.)

If you are communicating one of the named Items there is no need to include PackageType, Identifier, ItemCount, and Quantity.

Since either of these two approaches can be used the entire contents of this element are optional even though the parent may be required. It is expected that you will fill in the appropriate details.

CountryOfOrigin

CountryOfOrigin is optional. A single instance might exist.

The country of origin for the material.

CountryOfDestination

CountryOfDestination is optional. A single instance might exist.

The country where the goods will be, or were, shipped to.

CountryOfConsumption

CountryOfConsumption is optional. A single instance might exist.

The country of consumption for the material.

OtherDate

OtherDate is optional. Multiple instances might exist.

A date that may not be specifically detailed within a document (example: print date at the PurchaseOrderLineItem).

SafetyAndEnvironmentalInformation

SafetyAndEnvironmentalInformation is optional. Multiple instances might exist.

Name of certification type, if any, on the goods (For example, FSC, PEFC). SafetyAndEnvironmental needs a value or measurement to communicate the percentage of the product is certified (for example, 75% is certified by the indicated agency).

MeasuringSpecification

MeasuringSpecification is optional. Multiple instances might exist.

A grouping element that contains a specification for measurement procedures for a measuring party at a measuring location.

AdditionalItemInfo

AdditionalItemInfo is optional. Multiple instances might exist.

A grouping element that contains information about additional items specified by an agency. Restricted use of this element is recommended.

DeliveryMessageLineItemNumber

The sequential number that uniquely identifies the delivery line item.

DeliveryMessageLineItemNumber	
type	lineNumberType

DeliveryMessageNumber

A unique delivery identifier assigned to each DeliveryMessage as agreed between the trading partners.

DeliveryMessageNumber	
type	s30

DeliveryMessageProductGroup

The DeliveryMessageProductGroup permits the organization of a shipment by a product grouping.

(sequence)

The sequence of items below is mandatory. A single instance is required.

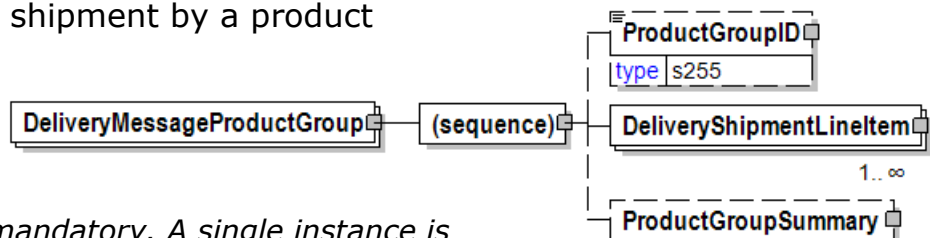

ProductGroupID

ProductGroupID is optional. A single instance might exist.

Possibility to group packages or Shipments. Example: Creating temporary group ID's for logistic reasons or lot number.

DeliveryShipmentLineItem

DeliveryShipmentLineItem is mandatory. One instance is required, multiple instances might exist.

The DeliveryShipmentLineItem specifies an individual delivery line for one order and order line item.

ProductGroupSummary

ProductGroupSummary is optional. A single instance might exist.

Group of elements to provide summary information on product level.

DeliveryMessageReason

A group item containing the reason for issuing the DeliveryMessage e-Document.

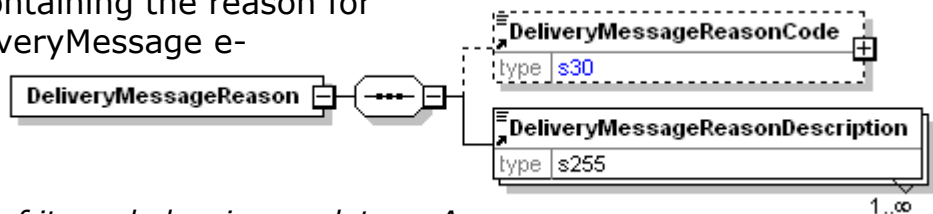

(sequence)

The sequence of items below is mandatory. A single instance is required.

DeliveryMessageReasonCode

DeliveryMessageReasonCode is optional. A single instance might exist.

A code specifying the reason for issuing the DeliveryMessage e-Document.

DeliveryMessageReasonDescription

DeliveryMessageReasonDescription is mandatory. One instance is required, multiple instances might exist.

A text describing the reason for issuing the DeliveryMessage e-Document.

DeliveryMessageReasonCode

A code specifying the reason for issuing the DeliveryMessage e-Document.

Agency [attribute]

Agency is mandatory. A single instance is required.

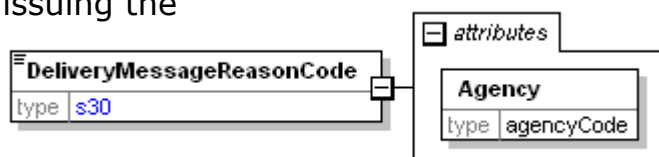

Describes the agency maintaining the list of codes. To be included in this list the agency must be a recognized standards body or industry organisation.

- For the element that owns this attribute.
- For another attribute in the list of attributes associated with the parent element.

Refer to Agency definition for any enumerations.

DeliveryMessageReasonDescription

A text describing the reason for issuing the DeliveryMessage e-Document.

DeliveryMessageReasonDescription
type s255

DeliveryMessageReelCharacteristics

A group item for actual measurement and manufacturing characteristics. DeliveryMessageReelCharacteristics is intended to indicate the actual measurements that apply to a reel.

(sequence)

The sequence of items below is mandatory. A single instance is required.

ReelWidth

ReelWidth is optional. A single instance might exist.

The width of reel from edge to edge excluding packaging.

ReelDiameter

ReelDiameter is optional. A single instance might exist.

The diameter measurement of reel excluding packaging.

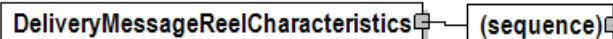

ReelLength

ReelLength is optional. A single instance might exist.

The total length of the paper on the reel.

MachineID

MachineID is optional. A single instance might exist.

An identifier assigned to the particular machine being referenced. For example, a machine could be a paper machine, an off-line coater, a sheeter, or a printing press. The particular machine being referenced will be determined by the business event being supported.

TambourID

TambourID is optional. A single instance might exist.

The unique identifier of the jumbo reel (also called mother reel or Tambour).

SetNumber

SetNumber is optional. A single instance might exist.

The part of the radius of the Tambour that constitutes the reel.

SetPosition

SetPosition is optional. A single instance might exist.

The position of the reel in relation to the reels cut across the Tambour.

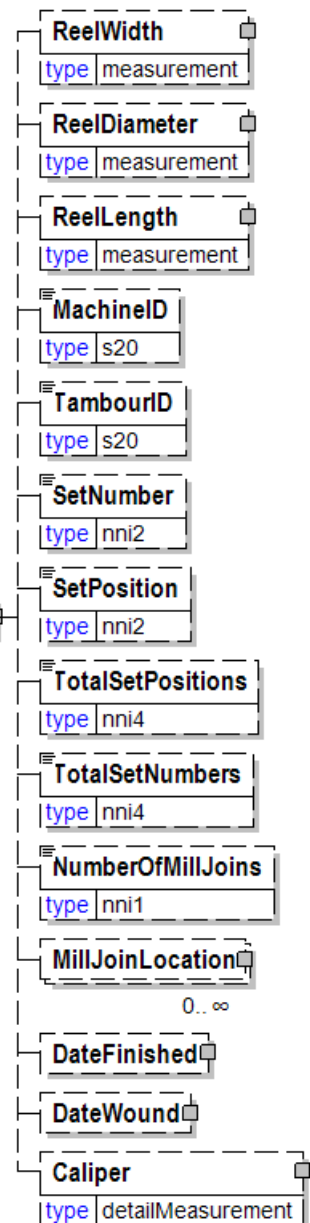

TotalSetPositions

TotalSetPositions is optional. A single instance might exist.

The total number of reels cut across the Tambour (in the width direction). Tambour is also called jumbo reel or mother reel.

TotalSetNumbers

TotalSetNumbers is optional. A single instance might exist.

The total number of sets wound from the Tambour (in the radial direction). Tambour is also called jumbo reel or mother reel.

NumberOfMillJoins

NumberOfMillJoins is optional. A single instance might exist.

The number of joins in the reel.

MillJoinLocation

MillJoinLocation is optional. Multiple instances might exist.

A group element detailing the location of each mill join in a reel. The element `DeliveryMessageReelCharacteristics/NumberOfMillJoins` gives the total number of joins in a reel. `DeliveryMessageReelCharacteristics/MillJoinLocation` would be repeated the `NumberOfMillJoin` times.

DateFinished

DateFinished is optional. A single instance might exist.

The Date and optionally the Time that an item was finished. For example, this could be the wrapping date for a reel or ream or the date the sheet(s) were packaged in preparation for shipment

DateWound

DateWound is optional. A single instance might exist.

The Date and optionally the Time that a reel was wound or produced from its parent. `RewoundIndicator` indicates if the reel has been rewound.

Caliper

Caliper is optional. A single instance might exist.

The thickness of a sheet of paper under standard test conditions.

DeliveryMessageReference

An element that identifies the relevant references pertaining to the

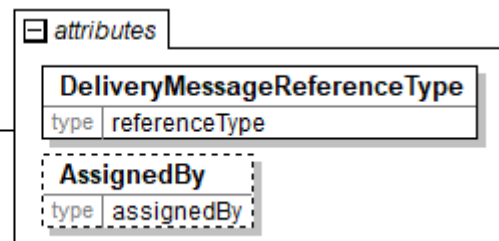

DeliveryMessage, identified by `DeliveryMessageReferenceType`.

DeliveryMessageReferenceType [attribute]

DeliveryMessageReferenceType is mandatory. A single instance is required.

Provides a contextual explanation of the specific reference identifier. Many items are currently prefixed by "Buyer", "Forwarder", "Manufacturer", "Mill",

"Seller", "Supplier", "Warehouse", or "Vendor". Check for an existing non-prefixed version and use the non-prefixed version instead. In the (yet to be announced release date) version 3.0 the prefixed versions will be removed. Instead the attribute @AssignedBy will communicate the information previously communicated in the prefix.

Refer to DeliveryMessageReferenceType definition for any enumerations.

AssignedBy [attribute]

AssignedBy is optional. A single instance might exist.

Identifies the type of party or the agency that has assigned the associated item, e.g. a reference of type OrderNumber.

Refer to AssignedBy for any enumerations.

DeliveryMessageReferenceType [attribute]

Provides a contextual explanation of the specific reference identifier. Many items are currently prefixed by "Buyer", "Forwarder", "Manufacturer", "Mill", "Seller", "Supplier", "Warehouse", or "Vendor". Check for an existing non-prefixed version and use the non-prefixed version instead. In the (yet to be announced release date) version 3.0 the prefixed versions will be removed. Instead the attribute @AssignedBy will communicate the information previously communicated in the prefix.

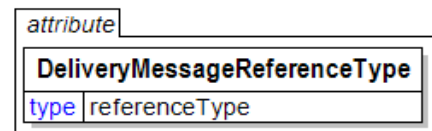

Refer to the [referenceType](#) entry for the list of enumerations and their definitions.

DeliveryMessageShipment

The DeliveryMessageShipment specifies an individual delivery shipment. It may contain product grouping within the shipment.

(sequence)

The sequence of items below is mandatory. A single instance is required.

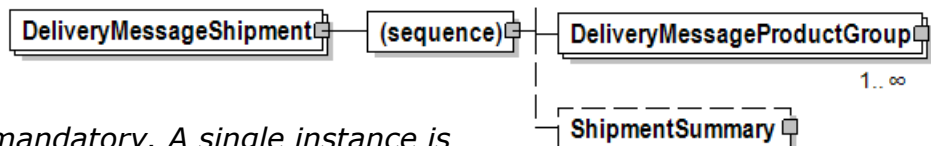

ShipmentID

ShipmentID is optional. A single instance might exist.

The ShipmentID may be a Bill of Lading Marking, which is customer's reference mark on each package used for logistic purposes. Should not be mixed up with Bill of Lading number. Another example of ShipmentID is grouping by a ContainerID.

DeliveryMessageProductGroup

DeliveryMessageProductGroup is mandatory. One instance is required, multiple instances might exist.

The DeliveryMessageProductGroup permits the organization of a shipment by a

product grouping.

ShipmentSummary

ShipmentSummary is optional. A single instance might exist.

Summary information for an entire shipment

DeliveryMessageStatusType [attribute]

Identifies the status of the entire DeliveryMessage (in other words, at the root level).



This item is restricted to the following list.

Cancelled

The supplied information has been cancelled. Items that have been cancelled are not included in totals on the summary levels of the e-Document.

Original

The supplied information is the first version of that information.

Replaced

The supplied information is replacing earlier supplied information. The receiver should revalidate the information in their system based upon the entire information received.

DeliveryMessageSummary

Summary information that applies to the entire DeliveryMessage.

(sequence)

The sequence of items below is mandatory. A single instance is required.

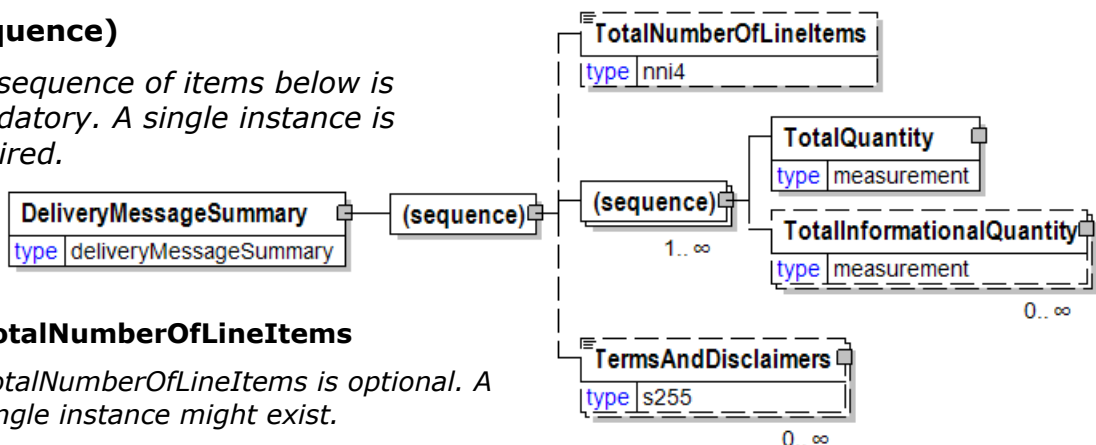

TotalNumberOfLineItems

TotalNumberOfLineItems is optional. A single instance might exist.

The total number of individual line items in the document, regardless of the status or type.

(sequence)

The sequence of items below is mandatory. One instance is required, multiple instances might exist.

TotalQuantity

TotalQuantity is mandatory. A single instance is required.

The total quantity of similar items in the e-Document. TotalQuantity is primarily used in the summary section of documents where it is repeatable to permit

totaling for different units of measure.

TotalInformationalQuantity

TotalInformationalQuantity is optional. Multiple instances might exist.

A quantity that is used to communicate related information about the parent element. This element represents a total that is derived from individual line items.

TermsAndDisclaimers

TermsAndDisclaimers is optional. Multiple instances might exist.

An element that contains legal information with an indication of what the Language is.

DeliveryMessageType (Book) [attribute]

DeliveryMessageType defines the type of DeliveryMessageBook.

This item is restricted to the following list.

attribute
DeliveryMessageType
type deliveryMessageType.Book

DeliveryMessage

A DeliveryMessage type that contains optional routing information, quantities at the DeliveryMessageLineItem level, and details at the DeliveryMessageLineItemDetail level. The seller uses a DeliveryMessage to provide delivery details to the ship-to party and tracking information.

InitialShipmentAdvice

A DeliveryMessage type that contains detailed routing information, quantities at the DeliveryMessageLineItem level and optionally details at the DeliveryMessageLineItemDetail level. The seller uses the InitialShipmentAdvice to provide preliminary notification of shipment routing and quantities (can be used as an advanced notice of delivery). The quantities indicated may not necessarily be delivered—for example, if there is damage in transit or the delivery is rerouted to another destination.

LoadedSpecification

A DeliveryMessage type that contains a specification of loaded goods on a transport unit (e.g. container, rail wagon). A loading specification (LoadedSpecification) can contain goods belonging to many suppliers and buyers and is normally referring to a Loading Instruction.

ShipmentAdvice

A DeliveryMessage type that contains a specification of goods, that are dispatched and will be delivered to a warehouse. A ShipmentAdvice can refer to a DeliveryInstruction Sequence or a CallOff, but is normally also used for notifying a receiving warehouse operator of shipments to the warehouse.

ThirdPartyShipmentAdvice

Notification of a shipment from a warehouse to a party other than the party that ordered the product from the supplier

Waybill

The forwarding agreement or carrying agreement that is used as a receipt for

cargo and as a contract of carriage.

DeliveryMessageType [attribute]

DeliveryMessageType defines the type of DeliveryMessage.

This item is restricted to the following list.



DeliveryMessage

A DeliveryMessage type that contains optional routing information, quantities at the DeliveryMessageLineItem level, and details at the DeliveryMessageLineItemDetail level. The seller uses a DeliveryMessage to provide delivery details to the ship-to party and tracking information.

InitialShipmentAdvice

A DeliveryMessage type that contains detailed routing information, quantities at the DeliveryMessageLineItem level and optionally details at the DeliveryMessageLineItemDetail level. The seller uses the InitialShipmentAdvice to provide preliminary notification of shipment routing and quantities (can be used as an advanced notice of delivery). The quantities indicated may not necessarily be delivered—for example, if there is damage in transit or the delivery is rerouted to another destination.

LoadedSpecification

A DeliveryMessage type that contains a specification of loaded goods on a transport unit (e.g. container, rail wagon). A loading specification (LoadedSpecification) can contain goods belonging to many suppliers and buyers and is normally referring to a Loading Instruction.

ShipmentAdvice

A DeliveryMessage type that contains a specification of goods, that are dispatched and will be delivered to a warehouse. A ShipmentAdvice can refer to a DeliveryInstruction Sequence or a CallOff, but is normally also used for notifying a receiving warehouse operator of shipments to the warehouse.

Waybill

The forwarding agreement or carrying agreement that is used as a receipt for cargo and as a contract of carriage.

DeliveryMessageType (Wood) [attribute]

DeliveryMessageType defines the type of DeliveryMessageWood.

This item is restricted to the following list.

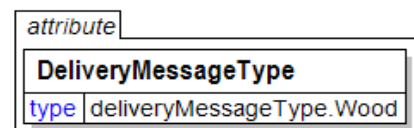

DeliveryMessage

A DeliveryMessage type that contains optional routing information, quantities at the DeliveryMessageLineItem level, and details at the DeliveryMessageLineItemDetail level. The seller uses a DeliveryMessage to provide delivery details to the ship-to party and tracking information.

InitialShipmentAdvice

A DeliveryMessage type that contains detailed routing information, quantities at the DeliveryMessageLineItem level and optionally details at the DeliveryMessageLineItemDetail level. The seller uses the InitialShipmentAdvice to provide preliminary notification of shipment routing and quantities (can be used as an advanced notice of delivery). The quantities indicated may not necessarily be delivered—for example, if there is damage in transit or the delivery is rerouted to another destination.

LoadingOrder

Specifies delivery schedule, the transport booking requirements and shipping instructions, as well as the internal work order for the shipment.

LoadedSpecification

A DeliveryMessage type that contains a specification of loaded goods on a transport unit (e.g. container, rail wagon). A loading specification (LoadedSpecification) can contain goods belonging to many suppliers and buyers and is normally referring to a Loading Instruction.

PackingSpecification

A Packing Specification is a business transaction specifying the complete consignment being shipped from a consignor to a consignee. The specification describes in detail what is being shipped and how it is packed and marked.

ShipmentAdvice

A DeliveryMessage type that contains a specification of goods, that are dispatched and will be delivered to a warehouse. A ShipmentAdvice can refer to a DeliveryInstruction Sequence or a CallOff, but is normally also used for notifying a receiving warehouse operator of shipments to the warehouse.

Waybill

The forwarding agreement or carrying agreement that is used as a receipt for cargo and as a contract of carriage.

DeliveryMessageWood

The DeliveryMessageWood element is the root element for the DeliveryMessageWood e-Document.

The DeliveryMessageWood e-Document enables the sender to describe the contents and configuration of a shipment at various levels of detail.

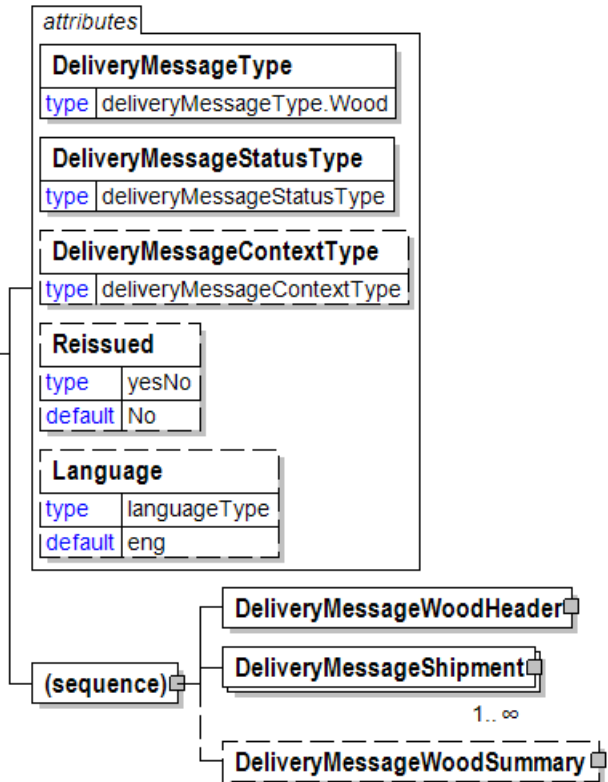

DeliveryMessageType [attribute]

DeliveryMessageType is mandatory. A single instance is required.

DeliveryMessageType defines the type of DeliveryMessage.

Refer to DeliveryMessageType definition for any enumerations.

DeliveryMessageStatusType [attribute]

DeliveryMessageStatusType is mandatory. A single instance is required.

Identifies the status of the entire DeliveryMessage (in other words, at the root level).

Refer to DeliveryMessageStatusType definition for any enumerations.

DeliveryMessageContextType [attribute]

DeliveryMessageContextType is optional. A single instance might exist.

Communicates the reason for this delivery. If not present then this is a standard, typical delivery.

Refer to DeliveryMessageContextType definition for any enumerations.

Reissued [attribute]

Reissued is optional. A single instance might exist.

Either "Yes" or "No".

Refer to Reissued definition for any enumerations.

Language [attribute]

Language is optional. A single instance might exist.

The valid Alpha 2- and Alpha 3-character list of language codes in the ISO 639-1 and 639-2 international standards.

Information on the content of this attribute is available at:
https://www.loc.gov/standards/iso639-2/php/code_list.php

(sequence)

papiNet V2R31

The sequence of items below is mandatory. A single instance is required.

DeliveryMessageWoodHeader

DeliveryMessageWoodHeader is mandatory. A single instance is required.

This element contains the information that is consistent for the entire DeliveryMessageWood document.

Note: DocumentReferenceInformation will be removed from this element in the next version of papiNet. Use the DocumentInformation element instead.

DeliveryMessageShipment

DeliveryMessageShipment is mandatory. One instance is required, multiple instances might exist.

The DeliveryMessageShipment specifies an individual delivery shipment. It may contain product grouping within the shipment.

DeliveryMessageWoodSummary

DeliveryMessageWoodSummary is optional. A single instance might exist.

The DeliveryMessageWoodSummary contains summary information based on the line items contained in the DeliveryMessageWood document.

DeliveryMessageWoodHeader

This element contains the information that is consistent for the entire DeliveryMessageWood document.

Note: DocumentReferenceInformation will be removed from this element in the next version of papiNet. Use the DocumentInformation element instead.

(sequence)

The sequence of items below is mandatory. A single instance is required.

DeliveryMessageNumber

DeliveryMessageNumber is mandatory. A single instance is required.

A unique delivery identifier assigned to each DeliveryMessage as agreed between the trading partners.

TransactionHistoryNumber

TransactionHistoryNumber is optional. A single instance might exist.

A sequential number that keeps track of

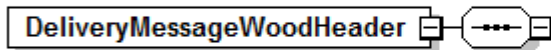

the version of a document.

However when the document is a confirmation document, in which case the TransactionHistoryNumber refers to the trigger transaction for the confirmation.

DeliveryMessageDate

DeliveryMessageDate is mandatory. A single instance is required.

The Date and Time when the DeliveryMessage was issued.

DeliveryMessageReference

DeliveryMessageReference is optional. Multiple instances might exist.

An element that identifies the relevant references pertaining to the DeliveryMessage, identified by DeliveryMessageReferenceType.

DocumentReferenceInformation

DocumentReferenceInformation is optional. Multiple instances might exist.

A group item containing reference information applicable to a document.



BuyerParty

BuyerParty is mandatory. A single instance is required.

The legal entity to which the product is sold. Also commonly referred to as the sold-to party or customer. If no OtherParty is defined as the Payer, the Buyer is the Payer.

BillToParty

BillToParty is optional. A single instance might exist.

The address where the Invoice is to be sent.

SupplierParty

SupplierParty is mandatory. A single instance is required.

The organisation or business entity responsible for providing the product. SupplierParty is also the seller of the product, if Seller is not specified as OtherParty = Seller.

OtherParty

OtherParty is optional. Multiple instances might exist.

An organisation or business entity other than those specifically detailed within an e-Document.

SenderParty

SenderParty is optional. A single instance might exist.

The business entity issuing the e-Document, the source of the document.

The entity responsible for the content. If the sender party has out sourced the message service to a third party the SenderParty is the issuer of the e-Document and not the party performing the transmission service of the electronic message.

ReceiverParty

ReceiverParty is optional. Multiple instances might exist.

The business entity for whom the e-Document is intended, the destination of the document.

The entity interested in the content. If the receiver party has outsourced the message service to a third party the ReceiverParty is the intended party for the e-Document and not the party performing the receiving service of the electronic message.

ShipToInformation

ShipToInformation is optional. A single instance might exist.

Group element containing information about the ship to and delivery of a product.

CountryOfOrigin

CountryOfOrigin is optional. A single instance might exist.

The country of origin for the material.

CountryOfDestination

CountryOfDestination is optional. A single instance might exist.

The country where the goods will be, or were, shipped to.

CountryOfConsumption

CountryOfConsumption is optional. A single instance might exist.

The country of consumption for the material.

Insurance

Insurance is optional. A single instance might exist.

Group element containing information about insurance

AdditionalText

AdditionalText is optional. Multiple instances might exist.

A text field that is used to communicate information not previously defined or for special instructions. To be used only for circumstances not covered by specific elements.

DocumentInformation

DocumentInformation is optional. Multiple instances might exist.

A group element containing a specification of required documents in the business process. Additional free text to be printed on documents can also be specified.

DeliveryMessageWoodSummary

The DeliveryMessageWoodSummary contains summary information based on the line items contained in the DeliveryMessageWood document.

(sequence)

The sequence of items below is mandatory. A single instance is required.

TotalNumberOfShipments

TotalNumberOfShipments is mandatory. A single instance is

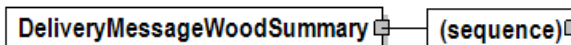

required.

Total number of shipments referred to in a DeliveryMessage.

(sequence)

The sequence of items below is optional. Multiple instances might exist.

TotalQuantity

TotalQuantity is mandatory. A single instance is required.

The total quantity of similar items in the e-Document. TotalQuantity is primarily used in the summary section of documents where it is repeatable to permit totaling for different units of measure.

TotalInformationalQuantity

TotalInformationalQuantity is optional. Multiple instances might exist.

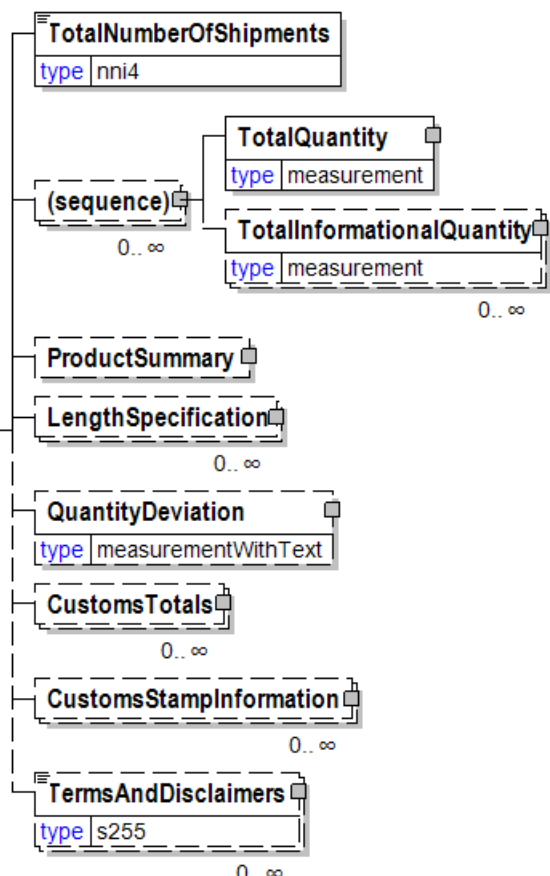

papiNet V2R31

A quantity that is used to communicate related information about the parent element. This element represents a total that is derived from individual line items.

ProductSummary

ProductSummary is optional. A single instance might exist.

Group of elements to provide summary information on product level.

LengthSpecification

LengthSpecification is optional. Multiple instances might exist.

Length specification of the wood product.

QuantityDeviation

QuantityDeviation is optional. A single instance might exist.

To be deprecated in a future version V3R00. Use the Quantity element with a QuantityContext of "Deviation".

CustomsTotals

CustomsTotals is optional. Multiple instances might exist.

A grouping element for customs total information.

CustomsStampInformation

CustomsStampInformation is optional. Multiple instances might exist.

A grouping element that organises the information for customs.

TermsAndDisclaimers

TermsAndDisclaimers is optional. Multiple instances might exist.

An element that contains legal information with an indication of what the Language is.

DeliveryModeType [attribute]

Provides delivery mode type that specifies if transport arrangement is needed or not.

This item is restricted to the following list.

Deliver

Transport arrangement to be done and goods to be delivered.

PickUp

Goods to be picked up; no transport arrangements are needed.

attribute	
DeliveryModeType	
type	deliveryModeType
default	Deliver

DeliveryOrigin

A group item that represents the start of one leg in a route.

Compare to DeliveryDestination.

The DeliveryOrigin specifies the start of one leg of the delivery.

In order to comply with the US Trade Act of 2002 you would use this element with a

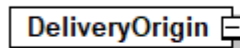

LocationParty/@PartyType of Port.

IsOptionalDeliveryOrigin [attribute]

IsOptionalDeliveryOrigin is optional. A single instance might exist.

Specifies if the DeliveryOrigin is optional or not. The default value is "No".

Refer to IsOptionalDeliveryOrigin definition for any enumerations.

PriorityOrder [attribute]

PriorityOrder is optional. A single instance might exist.

Specifies the priority order of the item as a two digit positive integer. Value 1 is the highest priority.

(sequence)

The sequence of items below is mandatory. A single instance is required.

Date

Date is optional. A single instance might exist.

A group element that contains the specification of Year, Month, and Day.

Time

Time is optional. A single instance might exist.

Times are treated in a standard XML fashion with a special case used to indicate a generalized "local" time. The standard XML approach to time is hh:mm:ss, hh:mm:ssZ, or hh:mm:ss±hh:mm.

hh:mm:ss±hh:mm is used to represent a time with a time zone. The time zone is communicated as the number of hours offset from the Universal Time Coordinate (UTC), a.k.a. Greenwich Mean Time.

hh:mm:ssZ indicates the time at Zulu (another name for UTC).

hh:mm:ss or hh:mm indicates within papiNet the applicable local time where the associated event is taking place. Caution should be used when processing times of this nature as the papiNet approach may be in discord with other

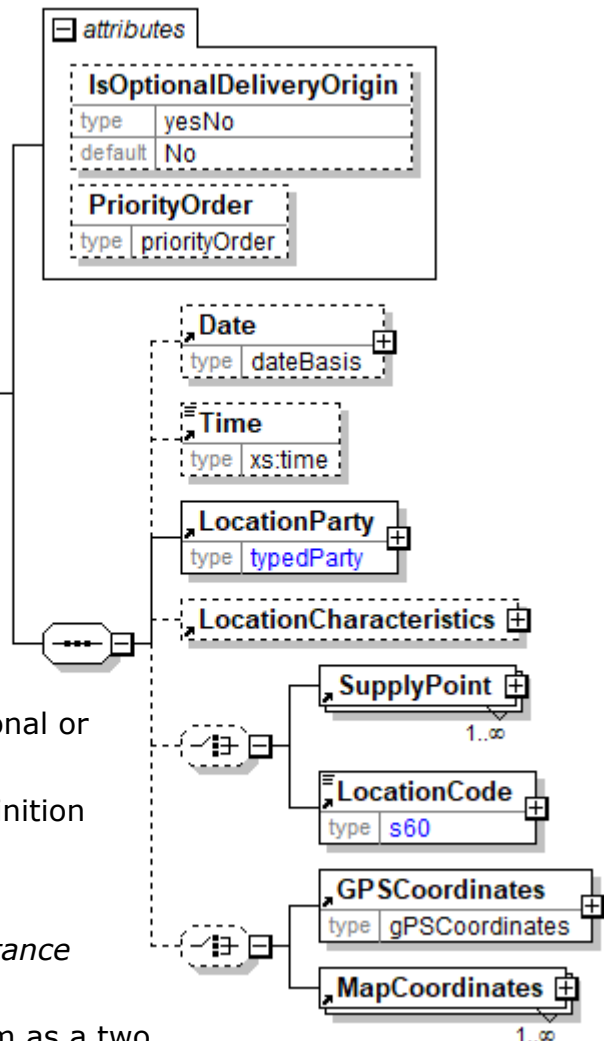

users of XML.

LocationParty

LocationParty is mandatory. A single instance is required.

The organization or business entity where the business event took place or will take place.

LocationCharacteristics

LocationCharacteristics is optional. A single instance might exist.

A grouping element that contains information related to a geographical location.

(choice)

[choice] is optional. A single instance might exist.

SupplyPoint

SupplyPoint is mandatory. One instance is required, multiple instances might exist.

Grouping element that contains items describing a supply point. A SupplyPoint belongs to a LocationParty, e.g. in a DeliveryOrigin or DeliveryDestination, and describes where goods are stored and can be loaded or unloaded. A SupplyPoint can for example be a loading or unloading gate at a warehouse or a road side landing at a logging area in the forest.

LocationCode

LocationCode is mandatory. A single instance is required.

A code used to identify a specific physical location within a site identified by a party, e.g. a loading station in a warehouse or an unloading station at a printer site.

LocationCode will be deprecated in a future version V3R00. Use SupplyPoint instead of LocationCode.

(choice)

[choice] is optional. A single instance might exist.

GPSCoordinates

GPSCoordinates is mandatory. A single instance is required.

The location of the party as specified using a Global Positioning System.

This element will be deprecated in a future version V3R00 and should not be used in new implementations. Use instead the MapCoordinates.

MapCoordinates

MapCoordinates is mandatory. One instance is required, multiple instances might exist.

A group item defining and containing position coordinates of a location.

DeliveryPlanning

The DeliveryPlanning element is the root element for the DeliveryPlanning e-Document.

The DeliveryPlanning e-Document provides a tool for trading partners to exchange information about logistics planning for deliveries, transports and resources. Information can be specified for various levels such as a Budget, a Forecast, a Demand or a detail Plan for a certain period. Actual outcome to date related to a plan can also be reported.

Reason for deviation between a plan and the actual outcome can be reported. Opening times and/or contingencies can be specified for locations for a given day or period.

The DeliveryPlanning e-Document can supply a complete sourcing plan for a certain planning region containing for example many mills. Origin and destination for products can be specified as well as various transport modes and other transport details.

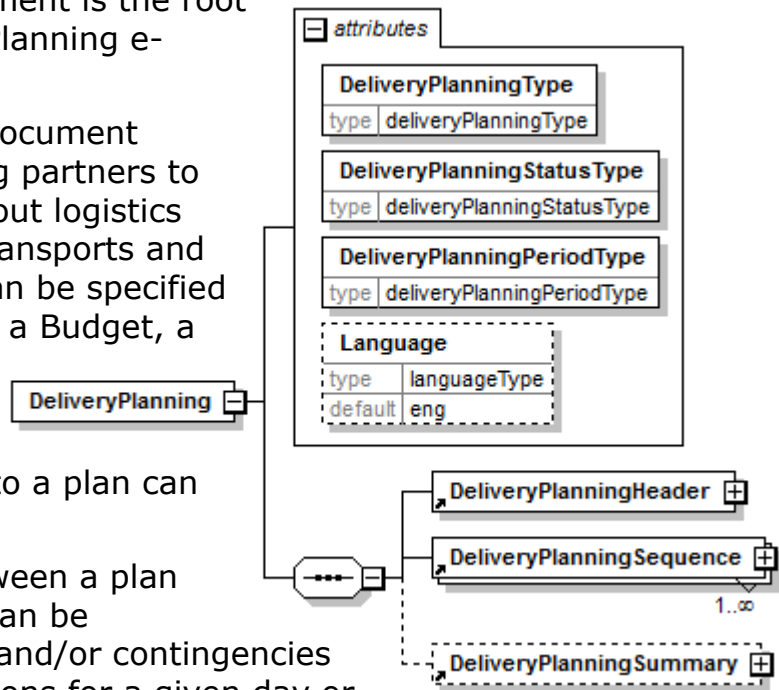

DeliveryPlanningType [attribute]

DeliveryPlanningType is mandatory. A single instance is required.

DeliveryPlanningType defines the type of DeliveryPlanning.

Refer to DeliveryPlanningType definition for any enumerations.

DeliveryPlanningStatusType [attribute]

DeliveryPlanningStatusType is mandatory. A single instance is required.

Identifies the status of the entire DeliveryPlanning e-Document.

Refer to DeliveryPlanningStatusType definition for any enumerations.

DeliveryPlanningPeriodType [attribute]

DeliveryPlanningPeriodType is mandatory. A single instance is required.

Indicates the used planning period in the entire DeliveryPlanning e-Document.

Refer to DeliveryPlanningPeriodType definition for any enumerations.

Language [attribute]

Language is optional. A single instance might exist.

The valid Alpha 2- and Alpha 3-character list of language codes in the ISO 639-1 and 639-2 international standards.

Information on the content of this attribute is available at:
https://www.loc.gov/standards/iso639-2/php/code_list.php

(sequence)

The sequence of items below is mandatory. A single instance is required.

DeliveryPlanningHeader

DeliveryPlanningHeader is mandatory. A single instance is required.

The DeliveryPlanningHeader contains information common to the entire DeliveryPlanning e-Document.

DeliveryPlanningSequence

DeliveryPlanningSequence is mandatory. One instance is required, multiple instances might exist.

A grouping element that contains information for planned deliveries, transports or resources. For example a monthly delivery plan of products to a mill.

DeliveryPlanningSummary

DeliveryPlanningSummary is optional. A single instance might exist.

A grouping element that contains summary information that applies to the entire DeliveryPlanning e-Document.

DeliveryPlanningHeader

The DeliveryPlanningHeader contains information common to the entire DeliveryPlanning e-Document.

(sequence)

The sequence of items below is mandatory. A single instance is required.

DeliveryPlanningNumber

DeliveryPlanningNumber is mandatory. A single instance is required.

The unique identifier for the DeliveryPlanning e-Document.

DeliveryPlanningIssueDate

DeliveryPlanningIssueDate is mandatory. A single instance is required.

The date and time when the DeliveryPlanning e-Document was issued.

TransactionHistoryNumber

TransactionHistoryNumber is optional. A single instance might exist.

A sequential number that keeps track of the version of a document.

However when the document is a confirmation document, in which case the TransactionHistoryNumber refers to the trigger transaction for the confirmation.

SenderParty

SenderParty is optional. A single instance might exist.

The business entity issuing the e-Document, the source of the document.

- The entity responsible for the content. If the sender party has outsourced the message service to a third party the SenderParty is the issuer of the e-Document and not the party performing the transmission service of the electronic message.

ReceiverParty

ReceiverParty is optional. Multiple instances might exist.

The business entity for whom the e-Document is intended, the destination of the document.

- The entity interested in the content. If the receiver party has outsourced the message service to a third party the ReceiverParty is the intended party for the e-Document and not the party performing the receiving service of the electronic message.

PlanningReferenceInformation

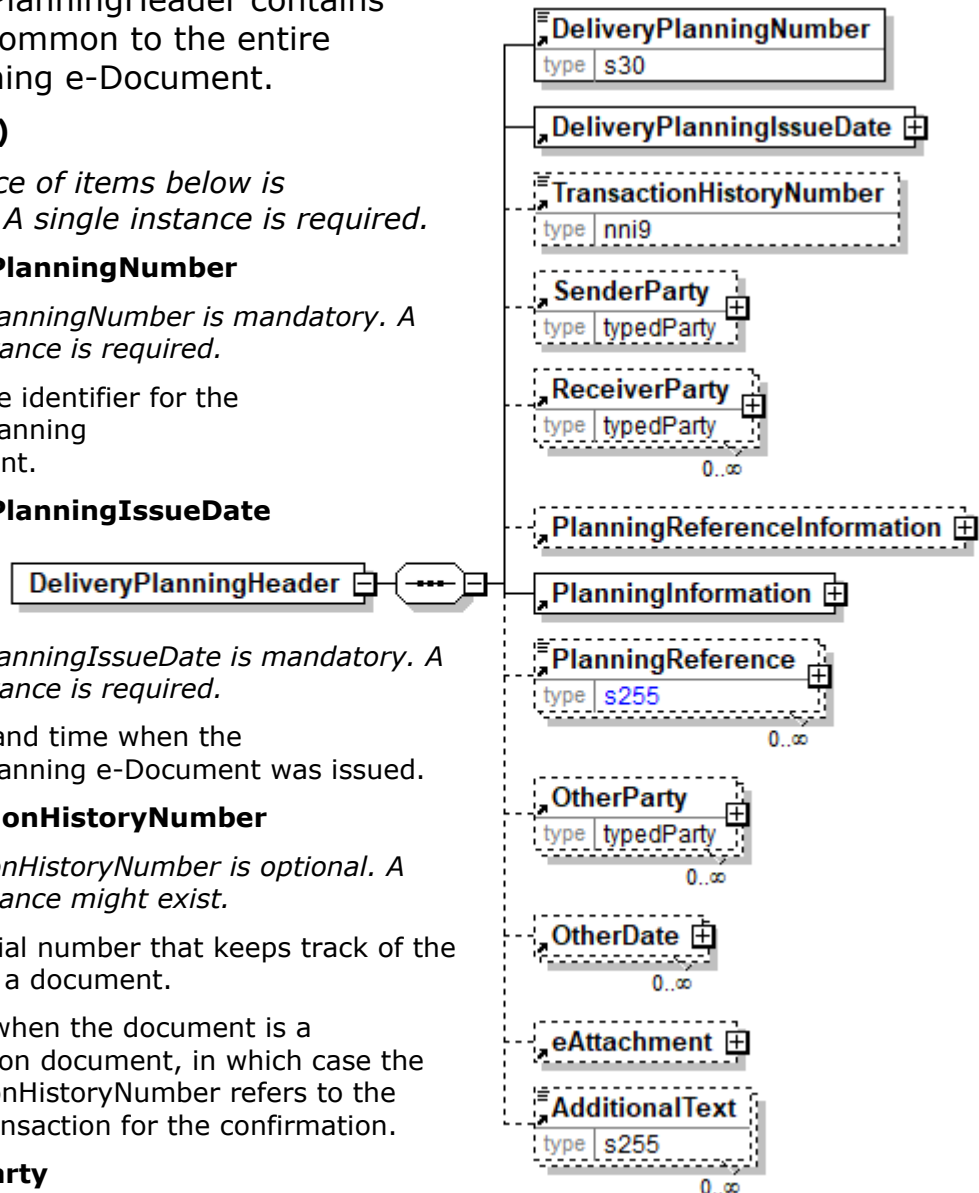

PlanningReferenceInformation is optional. A single instance might exist.

A grouping element specifying detailed reference information used for the supplied plan in the e-Document. For example if a transport plan is created as a response to a requested delivery plan, then the delivery plan can be referenced with document details such as document date and version.

PlanningInformation

PlanningInformation is mandatory. A single instance is required.

A grouping element that provides information about the planning period and details of the plan.

PlanningReference

PlanningReference is optional. Multiple instances might exist.

An element detailing relevant references pertaining to the Planning and DeliveryPlanning e-Documents.

OtherParty

OtherParty is optional. Multiple instances might exist.

An organisation or business entity other than those specifically detailed within an e-Document.

OtherDate

OtherDate is optional. Multiple instances might exist.

A date that may not be specifically detailed within a document (example: print date at the PurchaseOrderLineItem).

eAttachment

eAttachment is optional. A single instance might exist.

eAttachment enables the sender to provide information about attachments to the document.

- Note: An element "e-Attachment" also exists. papiNet will no longer use hyphens in our element and attribute names as this causes issues with BizTalk.

AdditionalText

AdditionalText is optional. Multiple instances might exist.

A text field that is used to communicate information not previously defined or for special instructions. To be used only for circumstances not covered by specific elements.

DeliveryPlanningIssueDate

The date and time when the DeliveryPlanning e-Document was issued.

(sequence)

The sequence of items

below is mandatory. A single instance is required.

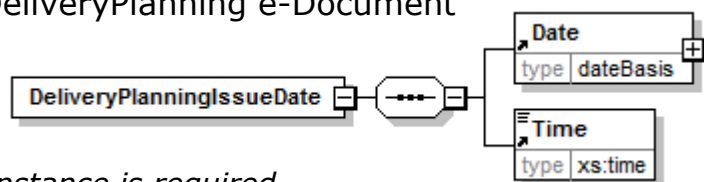

Date

Date is mandatory. A single instance is required.

A group element that contains the specification of Year, Month, and Day.

Time

papiNet V2R31

Time is mandatory. A single instance is required.

Times are treated in a standard XML fashion with a special case used to indicate a generalized "local" time. The standard XML approach to time is hh:mm:ss, hh:mm:ssZ, or hh:mm:ss±hh:mm.

- hh:mm:ss±hh:mm is used to represent a time with a time zone. The time zone is communicated as the number of hours offset from the Universal Time Coordinate (UTC), a.k.a. Greenwich Mean Time.
- hh:mm:ssZ indicates the time at Zulu (another name for UTC).
- hh:mm:ss or hh:mm indicates within papiNet the applicable local time where the associated event is taking place. Caution should be used when processing times of this nature as the papiNet approach may be in discord with other users of XML.

DeliveryPlanningNumber

The unique identifier for the DeliveryPlanning e-Document.

DeliveryPlanningNumber
type s30

DeliveryPlanningPeriodType [attribute]

Indicates the used planning period in the entire DeliveryPlanning e-Document.

This item is restricted to the following list.

Day

Daily period

Month

Monthly period

Week

Weekly period.

Year

Yearly period.

attributes
DeliveryPlanningPeriodType
type deliveryPlanningPeriodType

DeliveryPlanningSequence

A grouping element that contains information for planned deliveries, transports or resources. For example a monthly delivery plan of products to a mill.

(sequence)

The sequence of items below is mandatory. A single instance is required.

DeliveryPlanningSequenceNumber

DeliveryPlanningSequenceNumber is mandatory. A single instance is required.

A sequential number that uniquely identifies the sequence of a DeliveryPlanning.

DeliveryOrigin

DeliveryOrigin is optional. Multiple

instances might exist.

A group item that represents the start of one leg in a route. Compare to DeliveryDestination.

The DeliveryOrigin specifies the start of one leg of the delivery.

In order to comply with the US Trade Act of 2002 you would use this element with a LocationParty/@PartyType of Port.

DeliveryDestination

DeliveryDestination is optional. Multiple instances might exist.

The DeliveryDestination specifies the end of one leg of the delivery. In order to comply with the US Trade Act of 2002 you would use this element with a LocationParty/@PartyType of Port.

PlanningReference

PlanningReference is optional. Multiple instances might exist.

An element detailing relevant references pertaining to the Planning and DeliveryPlanning e-Documents.

TransportInformation

TransportInformation is optional. A single instance might exist.

A grouping element for transport information.

PlanningPeriodInfo

PlanningPeriodInfo is optional. A single instance might exist.

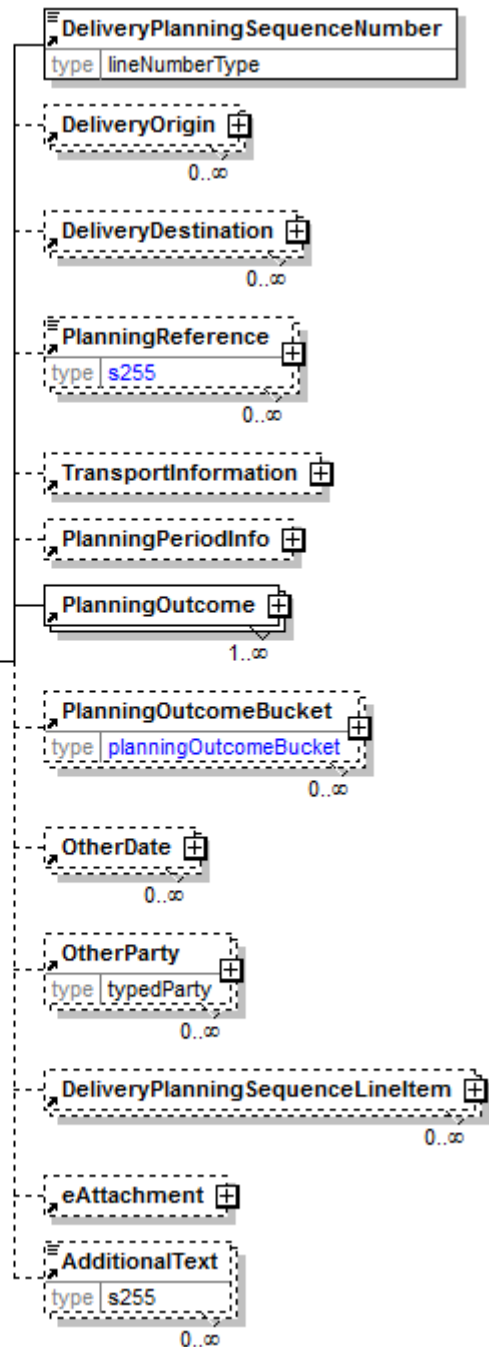

A grouping element detailing the information about the planning period.

PlanningOutcome

PlanningOutcome is mandatory. One instance is required, multiple instances might exist.

A grouping element that communicates the planned, actual, forecasted etc. quantities or resources. Also the deviations and reasons for these can be given.

PlanningOutcomeBucket

PlanningOutcomeBucket is optional. Multiple instances might exist.

PlanningOutcomeBucket groups together the elements required to communicate the time and quantity for a planning bucket.

OtherDate

OtherDate is optional. Multiple instances might exist.

A date that may not be specifically detailed within a document (example: print date at the PurchaseOrderLineItem).

OtherParty

OtherParty is optional. Multiple instances might exist.

An organisation or business entity other than those specifically detailed within an e-Document.

DeliveryPlanningSequenceLineItem

DeliveryPlanningSequenceLineItem is optional. Multiple instances might exist.

The group item DeliveryPlanningSequenceLineItem contains information for a line item of a DeliveryInstruction sequence. The line item specifies detail information about product and quantities.

eAttachment

eAttachment is optional. A single instance might exist.

eAttachment enables the sender to provide information about attachments to the document.

- Note: An element "e-Attachment" also exists. papiNet will no longer use hyphens in our element and attribute names as this causes issues with BizTalk.

AdditionalText

AdditionalText is optional. Multiple instances might exist.

A text field that is used to communicate information not previously defined or for special instructions. To be used only for circumstances not covered by specific elements.

DeliveryPlanningSequenceLineItem

The group item DeliveryPlanningSequenceLineItem contains information for a line item of a DeliveryInstruction sequence. The line item specifies detail information about product and quantities.

(sequence)

The sequence of items below is

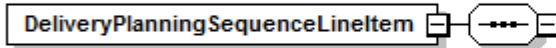

mandatory. A single instance is required.

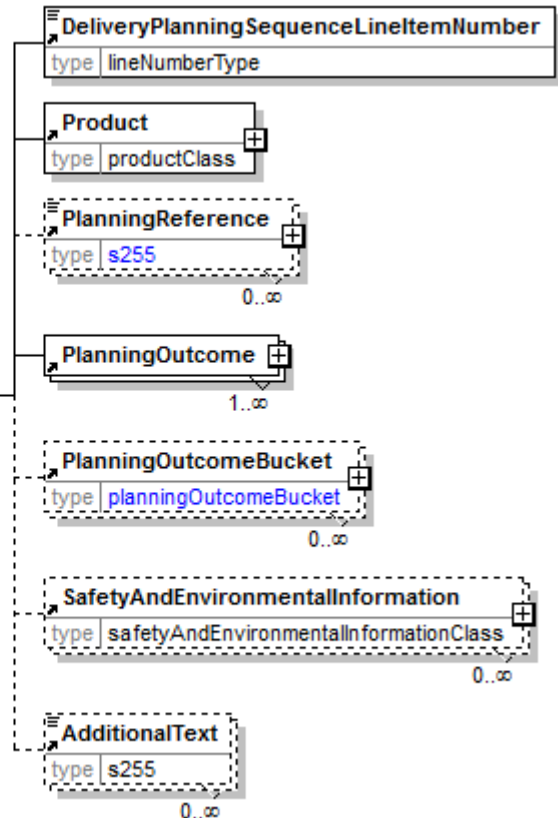

DeliveryPlanningSequenceLineItemNumber

DeliveryPlanningSequenceLineItemNumber is mandatory. A single instance is required.

A sequential number that uniquely identifies the line item of a DeliveryPlanningSequence.

Product

Product is mandatory. A single instance is required.

Product is a group item defining the article and its characteristics. Product is used to specify product characteristics organized by ProductIdentifier, ProductDescription, and Classification. Book Manufacturing, Label Stock, Paper, Pulp, Recovered Paper, Wood Products, and Virgin Fibre market segments have defined their product characteristics and conversion features for implementation in papiNet.

PlanningReference

PlanningReference is optional. Multiple instances might exist.

An element detailing relevant references pertaining to the Planning and DeliveryPlanning e-Documents.

PlanningOutcome

PlanningOutcome is mandatory. One instance is required, multiple instances might exist.

A grouping element that communicates the planned, actual, forecasted etc. quantities or resources. Also the deviations and reasons for these can be given.

PlanningOutcomeBucket

PlanningOutcomeBucket is optional. Multiple instances might exist.

PlanningOutcomeBucket groups together the elements required to communicate the time and quantity for a planning bucket.

SafetyAndEnvironmentalInformation

SafetyAndEnvironmentalInformation is optional. Multiple instances might exist.

Name of certification type, if any, on the goods (For example, FSC, PEFC). SafetyAndEnvironmental needs a value or measurement to communicate the percentage of the product is certified (for example, 75% is certified by the indicated agency).

AdditionalText

AdditionalText is optional. Multiple instances might exist.

A text field that is used to communicate information not previously defined or for special instructions. To be used only for circumstances not covered by specific elements.

DeliveryPlanningSequenceLineNumber

A sequential number that uniquely identifies the line item of a DeliveryPlanningSequence.

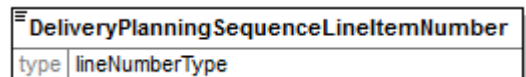

DeliveryPlanningSequenceNumber

A sequential number that uniquely identifies the sequence of a DeliveryPlanning e-Document.

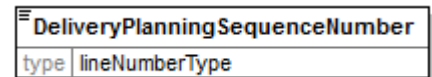

DeliveryPlanningStatusType [attribute]

Identifies the status of the entire DeliveryPlanning e-Document.

This item is restricted to the following list.

Cancelled

The supplied information has been cancelled. Items that have been cancelled are not included in totals on the summary levels of the e-Document.

Original

The supplied information is the first version of that information.

Replaced

The supplied information is replacing earlier supplied information. The receiver should revalidate the information in their system based upon the entire information received.

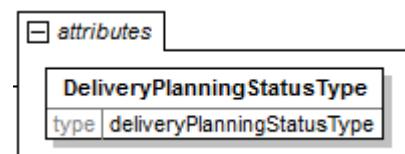

DeliveryPlanningSummary

A grouping element that contains summary information that applies to the entire DeliveryPlanning e-Document.

(sequence)

The sequence of items below is mandatory. A single instance is required.

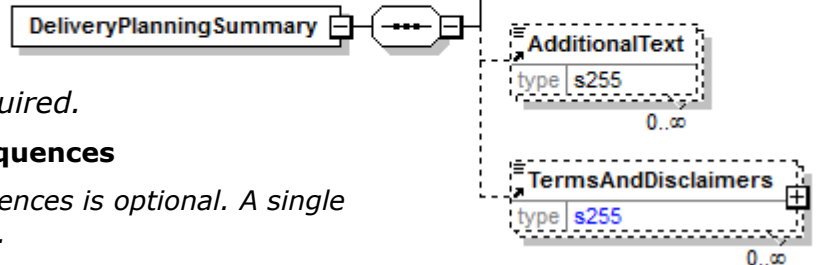

TotalNumberOfSequences

TotalNumberOfSequences is optional. A single instance might exist.

The total number of sequences in the document.

PlanningOutcome

PlanningOutcome is optional. Multiple instances might exist.

A grouping element that communicates the planned, actual, forecasted etc. quantities or resources. Also the deviations and reasons for these can be given.

AdditionalText

AdditionalTexts is optional. Multiple instances might exist.

A text field that is used to communicate information not previously defined or for special instructions. To be used only for circumstances not covered by specific elements.

TermsAndDisclaimers

TermsAndDisclaimers is optional. Multiple instances might exist.

An element that contains legal information with an indication of what the Language is.

DeliveryPlanningType [attribute]

DeliveryPlanningType defines the type of DeliveryPlanning.

This item is restricted to the following list.

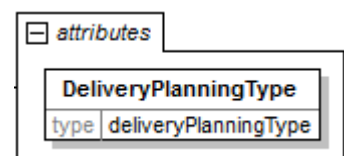

DeliveryPlan

A DeliveryPlanningType used to inform about quantities and times for the planned deliveries to the delivery destinations.

ResourcePlan

A DeliveryPlanningType used to inform about planned resource availability.

TransportPlan

A DeliveryPlanningType used to inform about quantities and times for the planned transports to the delivery destinations.

which may contain the estimated date for which delivery is expected. This date is not absolute.

Quantity

Quantity is mandatory. A single instance is required.

The Quantity element contains attributes that provide information about the type of quantity that is being communicated, the context in which the particular quantity is to be viewed, and (if the quantity represents an adjustment) an adjustment type.

The Quantity element contains three child elements that enable you to communicate a range of values for the quantity and a target or actual value. It is at this level (Value, RangeMin, and RangeMax) that the unit of measure is specified. This permits the range to be specified in a different unit of measure than the target.

InformationalQuantity

InformationalQuantity is optional. Multiple instances might exist.

A quantity given in a valid UOM used for information purposes only (not for calculation). For example, an ordered quantity was 100 reels as opposed to the invoice quantity of 20,000 pounds.

PriceDetails

PriceDetails is optional. A single instance might exist.

An element that groups together price information.

MonetaryAdjustment

MonetaryAdjustment is optional. Multiple instances might exist.

The element containing the information necessary for the understanding, calculation, and treatment of an adjustment to a currency amount. MonetaryAdjustment contains an attribute that indicates the type of adjustment being communicated.

DeliveryLeg

DeliveryLeg is optional. Multiple instances might exist.

A DeliveryLeg details the sequence, origin, transportation, and destination of each part of the delivery. More than one leg may be required if there is a change of mode, vehicle, or carrier.

Although transportation information is optional, it is strongly recommended that any transportation information available be sent.

DeliveryScheduleReference

DeliveryScheduleReference is optional. Multiple instances might exist.

An element detailing relevant references pertaining to the delivery schedule as indicated by DeliveryScheduleReferenceType.

AdditionalText

AdditionalText is optional. Multiple instances might exist.

A text field that is used to communicate information not previously defined or for special instructions. To be used only for circumstances not covered by specific elements.

DeliveryScheduleReference

An element detailing relevant references pertaining to the delivery schedule as indicated by

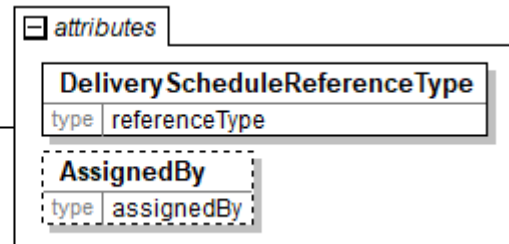
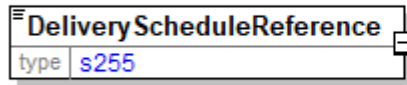

DeliveryScheduleReferenceType.

DeliveryScheduleReferenceType [attribute]

DeliveryScheduleReferenceType is mandatory. A single instance is required.

Provides a contextual explanation of the specific reference identifier. Many items are currently prefixed by "Buyer", "Forwarder", "Manufacturer", "Mill", "Seller", "Supplier", "Warehouse", or "Vendor". Check for an existing non-prefixed version and use the non-prefixed version instead. In the (yet to be announced release date) version 3.0 the prefixed versions will be removed. Instead the attribute @AssignedBy will communicate the information previously communicated in the prefix.

Refer to DeliveryScheduleReferenceType definition for any enumerations.

AssignedBy [attribute]

AssignedBy is optional. A single instance might exist.

Identifies the type of party or the agency that has assigned the associated item, e.g. a reference of type OrderNumber.

Refer to AssignedBy for any enumerations.

DeliveryScheduleReferenceType [attribute]

Provides a contextual explanation of the specific reference identifier. Many items are currently prefixed by "Buyer", "Forwarder", "Manufacturer", "Mill", "Seller", "Supplier", "Warehouse", or "Vendor". Check for an existing non-prefixed version and use the non-prefixed version instead. In the (yet to be announced release date) version 3.0 the prefixed versions will be removed. Instead the attribute @AssignedBy will communicate the information previously communicated in the prefix.

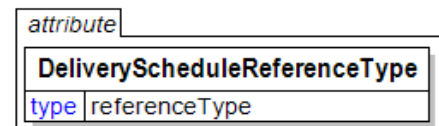

Refer to the [referenceType](#) entry for the list of enumerations and their definitions.

DeliveryShipmentBookLineItem

DeliveryShipmentBookLineItem is required. The DeliveryShipmentBookLineItem specifies an individual shipment delivery line for one PurchaseOrder and PurchaseOrder line item.

ShipmentComplete [attribute]

ShipmentComplete is optional. A single instance might exist.

Indicates that all shipments for the particular delivery item are complete.

Refer to

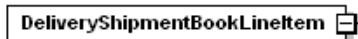

ShipmentComplete definition for any enumerations.

InstructionByType [attribute]

InstructionByType is optional. A single instance might exist.

Provides the type for how goods are identified on group level when instructed for loading or delivery.

Refer to InstructionByType definition for any enumerations.

(sequence)

The sequence of items below is mandatory. A single instance is required.

DeliveryShipmentLineNumber

DeliveryShipmentLineNumber is mandatory. A single instance is required.

Sequential number to identify individual line items within a shipment

PurchaseOrderInformation

PurchaseOrderInformation is optional. A single instance might exist.

A group item containing information unique to this PurchaseOrder, which is provided by the buyer. PurchaseOrderInformation can be optional in the supply chain. Invoices are created without having a PurchaseOrder in Vendor Managed Inventory. Freight invoices also will not have a PurchaseOrder number.

PurchaseOrderLineItemNumber

PurchaseOrderLineItemNumber is optional. A single instance might exist.



The sequential number that uniquely identifies the PurchaseOrder line item.

DeliveryMessageReference

DeliveryMessageReference is optional. Multiple instances might exist.

An element that identifies the relevant references pertaining to the DeliveryMessage, identified by DeliveryMessageReferenceType.

DocumentReferenceInformation

DocumentReferenceInformation is optional. Multiple instances might exist.

A group item containing reference information applicable to a document.

CountryOfOrigin

CountryOfOrigin is optional. A single instance might exist.

The country of origin for the material.

CountryOfDestination

CountryOfDestination is optional. A single instance might exist.

The country where the goods will be, or were, shipped to.

CountryOfConsumption

CountryOfConsumption is optional. A single instance might exist.

The country of consumption for the material.

Quantity

Quantity is optional. A single instance might exist.

The Quantity element contains attributes that provide information about the type of quantity that is being communicated, the context in which the particular quantity is to be viewed, and (if the quantity represents an adjustment) an adjustment type.

The Quantity element contains three child elements that enable you to communicate a range of values for the quantity and a target or actual value. It is at this level (Value, RangeMin, and RangeMax) that the unit of measure is specified. This permits the range to be specified in a different unit of measure than the target.

InformationalQuantity

InformationalQuantity is optional. Multiple instances might exist.

A quantity given in a valid UOM used for information purposes only (not for calculation). For example, an ordered quantity was 100 reels as opposed to the invoice quantity of 20,000 pounds.

TransportLoadingCharacteristics

TransportLoadingCharacteristics is optional. Multiple instances might exist.

A group item defining how the transported items are to be loaded.

TransportUnloadingCharacteristics

TransportUnloadingCharacteristics is optional. A single instance might exist.

A group item defining how the transported items are to be unloaded.

TransportOtherInstructions

TransportOtherInstructions is optional. Multiple instances might exist.

A group item defining any other instructions for the transport not covered in the description of transport mode, vehicle, unit, and loading characteristics or defining an alternative description for the categories mentioned above.

papiNet V2R31

BillToParty

BillToParty is optional. A single instance might exist.

The address where the Invoice is to be sent.

BookPackageInformation

BookPackageInformation is optional. Multiple instances might exist.

The purpose of the BookPackageInformation structure is to clearly identify physical handling items that constitute the delivery.

BookPackageInformation is the highest level of product packaging and describes the shipping or warehousing unit.

Product

Product is optional. A single instance might exist.

Product is a group item defining the article and its characteristics. Product is used to specify product characteristics organized by ProductIdentifier, ProductDescription, and Classification. Book Manufacturing, Label Stock, Paper, Pulp, Recovered Paper, Wood Products, and Virgin Fibre market segments have defined their product characteristics and conversion features for implementation in papiNet.

OtherDate

OtherDate is optional. Multiple instances might exist.

A date that may not be specifically detailed within a document (example: print date at the PurchaseOrderLineItem).

SafetyAndEnvironmentalInformation

SafetyAndEnvironmentalInformation is optional. Multiple instances might exist.

Name of certification type, if any, on the goods (For example, FSC, PEFC). SafetyAndEnvironmental needs a value or measurement to communicate the percentage of the product is certified (for example, 75% is certified by the indicated agency).

DeliveryShipmentId

Unique identifier for the shipment

DeliveryShipmentId	
type	s30

DeliveryShipmentLineItem

The DeliveryShipmentLineItem specifies an individual delivery line for one order and order line item.

(sequence)

The sequence of items below is mandatory. A single instance is required.

DeliveryShipmentLineItemNumber

DeliveryShipmentLineItemNumber is mandatory. A single instance is required.

Sequential number to identify individual line items within a shipment

PurchaseOrderInformation

PurchaseOrderInformation is optional. A single instance might exist.

A group item containing information unique to this PurchaseOrder, which is provided by the buyer. PurchaseOrderInformation can be optional in the supply chain. Invoices are created without having a PurchaseOrder in Vendor Managed Inventory. Freight invoices also will not have a PurchaseOrder number.



PurchaseOrderLineItemNumber

PurchaseOrderLineItemNumber is optional. A single instance might exist.

The sequential number that uniquely identifies the PurchaseOrder line item.

DeliveryMessageReference

DeliveryMessageReference is optional. Multiple instances might exist.

An element that identifies the relevant references pertaining to the DeliveryMessage, identified by DeliveryMessageReferenceType.

DocumentReferenceInformation

DocumentReferenceInformation is optional. Multiple instances might exist.

A group item containing reference information applicable to a document.

CountryOfOrigin

CountryOfOrigin is optional. A single instance might exist.

The country of origin for the material.

CountryOfDestination



papiNet V2R31

CountryOfDestination is optional. A single instance might exist.

The country where the goods will be, or were, shipped to.

CountryOfConsumption

CountryOfConsumption is optional. A single instance might exist.

The country of consumption for the material.

TotalNumberOfUnits

TotalNumberOfUnits is optional. A single instance might exist.

The total number of units.

DeliveryDateWindow

DeliveryDateWindow is optional. Multiple instances might exist.

A group item defining the date/time interval for delivery to take place. An element which may contain the estimated date for which delivery is expected. This date is not absolute.

MillProductionInformation

MillProductionInformation is optional. A single instance might exist.

A grouping element that contains information about production at the mill.

QuantityOrderedInformation

QuantityOrderedInformation is optional. A single instance might exist.

Used to identify quantity. The construct provides via InformationalQuantity the ability to provide the Quantity in another UOM. Length is also provided to further specify the quantity.

TransportLoadingCharacteristics

TransportLoadingCharacteristics is optional. Multiple instances might exist.

A group item defining how the transported items are to be loaded.

TransportUnloadingCharacteristics

TransportUnloadingCharacteristics is optional. A single instance might exist.

A group item defining how the transported items are to be unloaded.

TransportOtherInstructions

TransportOtherInstructions is optional. Multiple instances might exist.

A group item defining any other instructions for the transport not covered in the description of transport mode, vehicle, unit, and loading characteristics or defining an alternative description for the categories mentioned above.

SafetyAndEnvironmentalInformation

SafetyAndEnvironmentalInformation is optional. Multiple instances might exist.

Name of certification type, if any, on the goods (For example, FSC, PEFC). SafetyAndEnvironmental needs a value or measurement to communicate the percentage of the product is certified (for example, 75% is certified by the indicated agency).

BillToParty

BillToParty is optional. A single instance might exist.

The address where the Invoice is to be sent.

Product

papiNet V2R31

Product is optional. A single instance might exist.

Product is a group item defining the article and its characteristics. Product is used to specify product characteristics organized by ProductIdentifier, ProductDescription, and Classification. Book Manufacturing, Label Stock, Paper, Pulp, Recovered Paper, Wood Products, and Virgin Fibre market segments have defined their product characteristics and conversion features for implementation in papiNet.

(choice)

[choice] is optional. A single instance might exist.

PackageInformation

PackageInformation is mandatory. One instance is required, multiple instances might exist.

The purpose of the PackageInformation structure is to clearly identify physical handling items that constitute the delivery.

PackageInformation is the highest level of product packaging it describes the shipping or warehousing unit.

- If you are communicating a package, usually for logistics or transport purposes, you should include the PackageType, Identifier, ItemCount, and Quantity. (Note: you still have the ability to describe the item with one of the "named" items.)
- If you are communicating one of the named Items there is no need to include PackageType, Identifier, ItemCount, and Quantity.

Since either of these two approaches can be used the entire contents of this element are optional even though the parent may be required. It is expected that you will fill in the appropriate details.

PackageInformation in DeliveryShipmentLineItem will be deprecated in a future version V3R00. Use instead TransportPackageInformation.

TransportPackageInformation

TransportPackageInformation is mandatory. One instance is required, multiple instances might exist.

Information of a package used in transportation, can include several normal packages.

ProductSummary

ProductSummary is optional. A single instance might exist.

Group of elements to provide summary information on product level.

LengthSpecification

LengthSpecification is optional. Multiple instances might exist.

Length specification of the wood product.

QuantityDeviation

QuantityDeviation is optional. A single instance might exist.

To be deprecated in a future version V3R00. Use the Quantity element with a QuantityContext of "Deviation".

DeliveryShipmentLineItemNumber

Sequential number to identify individual line items within a shipment

DeliveryShipmentLineItemNumber	
type	nni4

DeliverySource

A grouping element with information that identifies and specifies the source of a delivery, e.g. a logging area.

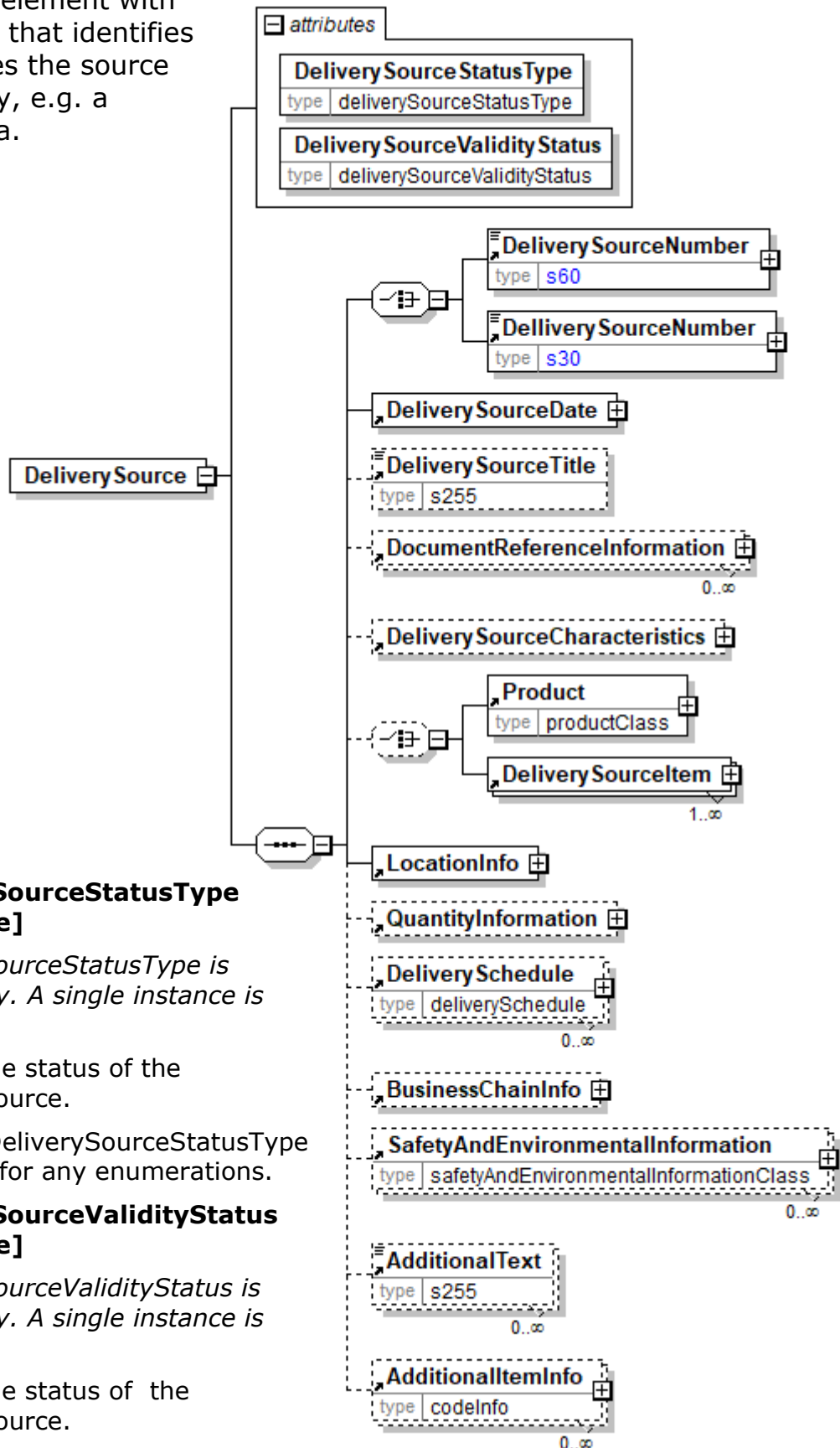

DeliverySourceStatusType [attribute]

DeliverySourceStatusType is mandatory. A single instance is required.

Defines the status of the DeliverySource.

Refer to DeliverySourceStatusType definition for any enumerations.

DeliverySourceValidityStatus [attribute]

DeliverySourceValidityStatus is mandatory. A single instance is required.

Defines the status of the DeliverySource.

Refer to DeliverySourceValidityStatus definition for any enumerations.

(sequence)

The sequence of items below is mandatory. A single instance is required.

(choice)

Choice is mandatory. A single instance is required.

DeliverySourceNumber

DeliverySourceNumber is mandatory. A single instance is required.

The identifier of the delivery source in the supply chain.

DelliverySourceNumber

DelliverySourceNumber is mandatory. A single instance is required.

The item is misspelt. It will be deprecated in a future version V3R00. Use instead DeliverySourceNumber.

DeliverySourceDate

DeliverySourceDate is mandatory. A single instance is required.

The date and time when the DeliverySource is created or updated.

DeliverySourceTitle

DeliverySourceTitle is optional. A single instance might exist.

A text describing the context of the DeliverySource.

DocumentReferenceInformation

DocumentReferenceInformation is optional. Multiple instances might exist.

A group item containing reference information applicable to a document.

DeliverySourceCharacteristics

DeliverySourceCharacteristics is optional. A single instance might exist.

A grouping element that contains information related to the DeliverySource.

(choice)

Choice is optional. A single instance might exist.

Product

Product is mandatory. A single instance is required.

Will be deprecated in a future version V3R00 and should not be used in new integrations. Use instead Product in DeliverySourceItem.

DeliverySourceItem

DeliverySourceItem is mandatory. A single instance is required.

A grouping element that contains information about a source product and its associated information.

LocationInfo

LocationInfo is mandatory. A single instance is required.

A grouping element that contains information about a geographical location.

QuantityInformation

QuantityInformation is optional. A single instance might exist.

A group item containing information about quantity and informational quantity of similar items.

DeliverySchedule

DeliverySchedule is optional. Multiple instances might exist.

A group item defining a series of DeliveryDateWindow(s) in which specified quantities must be delivered.

BusinessChainInfo

BusinessChainInfo is optional. A single instance might exist.

A grouping element that contains information about parties in the business chain when products or services are traded in many levels.

The business chain starts at the sourcing end where products are provided when BusinessChainContextType = Product.

The business chain starts at the purchasing of a service from the OriginalLogisticsSupplier when BusinessChainContextType = LogisticsService.

SafetyAndEnvironmentalInformation

SafetyAndEnvironmentalInformation is optional. Multiple instances might exist.

Name of certification type, if any, on the goods (For example, FSC, PEFC). SafetyAndEnvironmental needs a value or measurement to communicate the percentage of the product is certified (for example, 75% is certified by the indicated agency).

AdditionalText

AdditionalText is optional. Multiple instances might exist.

A text field that is used to communicate information not previously defined or for special instructions. To be used only for circumstances not covered by specific elements.

AdditionalItemInfo

AdditionalItemInfo is optional. Multiple instances might exist.

A grouping element that contains information about additional items specified by an agency. Restricted use of this element is recommended.

DeliverySourceCharacteristics

A grouping element that contains information related to the DeliverySource.

(sequence)

The sequence of items below is mandatory. A single instance is required.

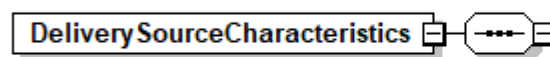

DeliverySourceProperty

DeliverySourceProperty is optional. Multiple instances might exist.

A grouping element that contains a specification of a property for a DeliverySource.

ValidityPeriod

ValidityPeriod is optional. A single instance might exist.

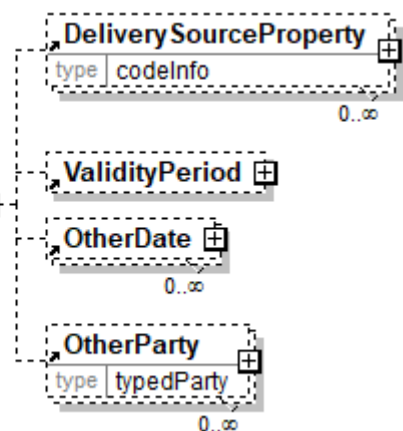

papiNet V2R31

The validity period for a specific item, e.g. the validity period for an e-Document.

OtherDate

OtherDate is optional. Multiple instances might exist.

A date that may not be specifically detailed within a document (example: print date at the PurchaseOrderLineItem).

OtherParty

OtherParty is optional. Multiple instances might exist.

An organisation or business entity other than those specifically detailed within an e-Document.

DeliverySourceDate

The date and time when the DeliverySource is created or updated.

(sequence)

The sequence of items below is mandatory. A single instance is required.

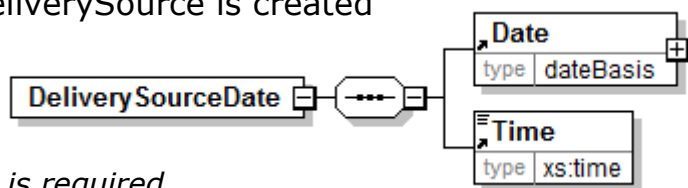

Date

Date is mandatory. A single instance is required.

A group element that contains the specification of Year, Month, and Day.

Time

Time is mandatory. A single instance is required.

Times are treated in a standard XML fashion with a special case used to indicate a generalized "local" time. The standard XML approach to time is hh:mm:ss, hh:mm:ssZ, or hh:mm:ss±hh:mm.

hh:mm:ss±hh:mm is used to represent a time with a time zone. The time zone is communicated as the number of hours offset from the Universal Time Coordinate (UTC), a.k.a. Greenwich Mean Time.

hh:mm:ssZ indicates the time at Zulu (another name for UTC).

hh:mm:ss or hh:mm indicates within papiNet the applicable local time where the associated event is taking place. Caution should be used when processing times of this nature as the papiNet approach may be in discord with other users of XML.

DeliverySourceItem

A grouping element that contains information about a source product and its associated information.

(sequence)

The sequence of items below is mandatory. A single instance is required.

DeliverySourceItemNumber



DeliverySourceItemNumber is optional. A single instance might exist.

A sequential number that uniquely identifies a DeliverySourceItem of a DeliverySource.

Product

Product is mandatory. A single instance is required.

Product is a group item defining the article and its characteristics. Product is used to specify product characteristics organized by ProductIdentifier, ProductDescription, and Classification. Book Manufacturing, Label Stock, Paper, Pulp, Recovered Paper, Wood Products, and Virgin Fibre market segments have defined their product characteristics and conversion features for implementation in papiNet.

QuantityInformation

QuantityInformation is optional. A single instance might exist.

A group item containing information about quantity and informational quantity of similar items.

DeliverySchedule

DeliverySchedule is optional. Multiple instances might exist.

A group item defining a series of DeliveryDateWindow(s) in which specified quantities must be delivered.

OtherParty

OtherParty is optional. Multiple instances might exist.

An organisation or business entity other than those specifically detailed within an e-Document.

DocumentReferenceInformation

DocumentReferenceInformation is optional. Multiple instances might exist.

A group item containing reference information applicable to a document.

SafetyAndEnvironmentalInformation

SafetyAndEnvironmentalInformation is optional. Multiple instances might exist.

Name of certification type, if any, on the goods (For example, FSC, PEFC). SafetyAndEnvironmental needs a value or measurement to communicate the percentage of the product is certified (for example, 75% is certified by the

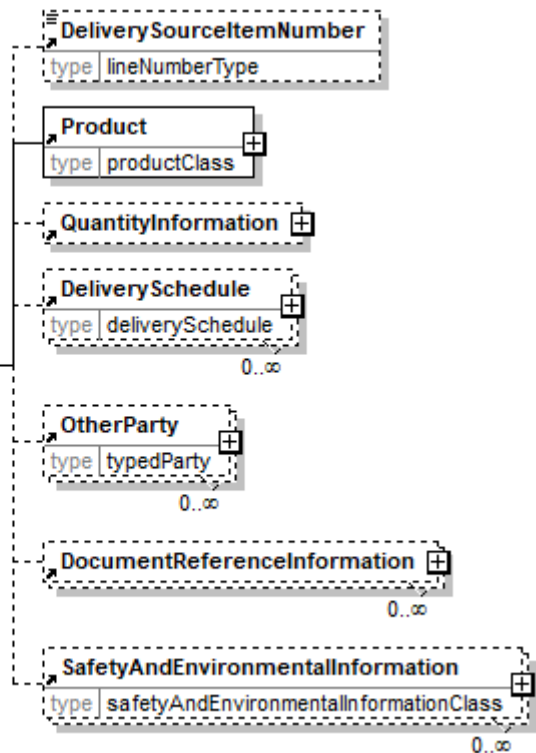

indicated agency).

DeliverySourceItemNumber

A sequential number that uniquely identifies a DeliverySourceItem of a DeliverySource.

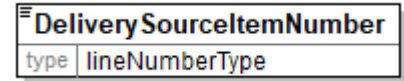

DeliverySourceNumber

The identifier of the delivery source in the supply chain.

AssignedBy [attribute]

AssignedBy is optional. A single instance might exist.

Identifies the type of party or the agency that has assigned the associated item, e.g. a reference of type OrderNumber.

Refer to AssignedBy for any enumerations.

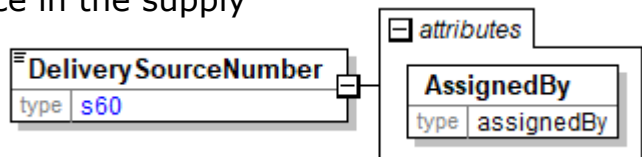

DeliverySourceProperty

A grouping element that contains a specification of a property for a DeliverySource.

Agency [attribute]

Agency is mandatory. A single instance is required.

Describes the agency maintaining the list of codes. To be included in this list the agency must be a recognized standards body or industry organisation.

- For the element that owns this attribute.
- For another attribute in the list of attributes associated with the parent element.

Refer to Agency definition for any enumerations.

(sequence)

The sequence of items below is mandatory. A single instance is required.

Code

Code is mandatory. A single instance is required.

Specifies a code that is defined by an agency. The agency is given for the whole construct containing the code.

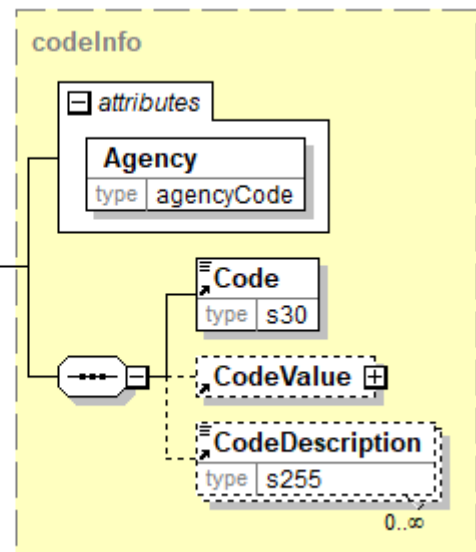

CodeValue

CodeValue is optional. A single instance might exist.

A grouping element specifying a value belonging to a code that is defined by an agency.

CodeDescription

CodeDescription is optional. Multiple instances might exist.

A textual description for the meaning of a code that is defined by an agency. When the Code is associated with a CodeValue of type TextValue, then the CodeDescription is a textual description of both the Code and the TextValue.

DeliverySourceStatusType [attribute]

Defines the status of the DeliverySource.

This item is restricted to the following list.

Amended

The supplied information is changed.

Cancelled

The supplied information has been cancelled. Items that have been cancelled are not included in totals on the summary levels of the e-Document.

New

The supplied information is new and supplied for the first time.

NoAction

The supplied information has not been amended and thereby requires no action.

DeliverySourceTitle

A text describing the context of the DeliverySource.

Delivery Source Title	
type	s255

DeliverySourceValidityStatus [attribute]

Defines the validity status of the DeliverySource.

This item is restricted to the following list.

Active

The DeliverySource is active.

Closed

The DeliverySource is terminated or annulled.

attributes
Delivery Source Validity Status
type deliverySourceValidityStatus

DeliveryStatus

Used to communicate whether the delivery date indicated is a final date or subject to change. If subject to change the last date of change may be communicated.

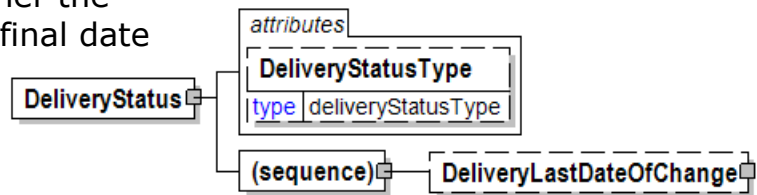

DeliveryStatusType [attribute]

DeliveryStatusType is optional. A single instance might exist.

Indicates whether or not you are allowed to take action on the delivery or if more information is required

Refer to DeliveryStatusType definition for any enumerations.

(sequence)

The sequence of items below is mandatory. A single instance is required.

DeliveryLastDateOfChange

DeliveryLastDateOfChange is optional. A single instance might exist.

The final Date and optionally Time that a line item or delivery line may be amended or cancelled by the buyer.

The final Date and optionally Time that a line item or delivery line may be amended or cancelled by the buyer. For example, the buyer can cancel each a delivery line before the DeliveryLastDateOfChange received from the seller on the OrderConfirmation.

DeliveryStatusType [attribute]

Indicates whether or not you are allowed to take action on the delivery or if more information is required

This item is restricted to the following list.

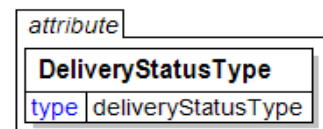

Cancelled

The delivery has been cancelled. You are not allowed to deliver this product.

Free

You are allowed to deliver this product

NotFree

You are not allowed to deliver this product. More information is required from the receiver.

DeliveryTransitTime

A group item representing the number of Days and optionally Hours and Minutes between origin and destination for a DeliveryLeg.

(sequence)

The sequence of items below is mandatory. A single instance is required.

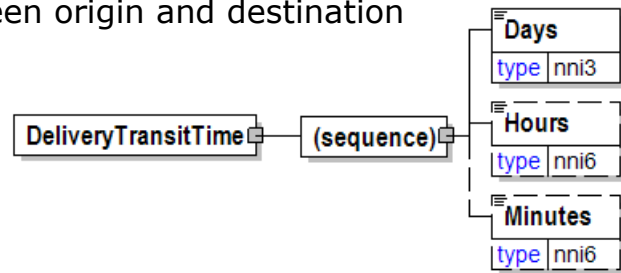

Days

Days is mandatory. A single instance is required.

The qualifier of DeliveryTransitTime. More generally used to communicate duration in days.

Hours

Hours is optional. A single instance might exist.

A qualifier of DeliveryTransitTime.

Minutes

Minutes is optional. A single instance might exist.

A qualifier for the DeliveryTransitTime.

DelliverySourceNumber

The item is misspelt. It will be deprecated in a future version V3R00.

Use instead DeliverySourceNumber.

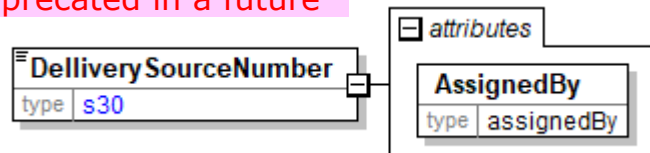

Density

A group item used to communicate density target or test value according to a particular TestMethod.

TestMethod [attribute]

TestMethod is optional. A single instance might exist.

The method used to determine the results of the test under consideration.

TestAgency [attribute]

TestAgency is optional. A single instance might exist.

The agency that has set the parameters for the testing

Refer to TestAgency definition for any enumerations.

SampleType [attribute]

SampleType is optional. A single instance might exist.

Communicates how sampling was done to measure the product characteristics.

Refer to SampleType definition for any enumerations.

ResultSource [attribute]

ResultSource is optional. A single instance might exist.

Used to define the data source of the specified test

Refer to ResultSource definition for any enumerations.

(sequence)

The sequence of items below is mandatory. A single instance is required.

DetailValue

DetailValue is mandatory. A single instance is required.

A numeric value expressed in the unit of measure (UOM).

DetailRangeMin

DetailRangeMin is optional. A single instance might exist.

The minimum value (lower boundary) allowed for the DetailValue that is the parent of this element.

DetailRangeMax

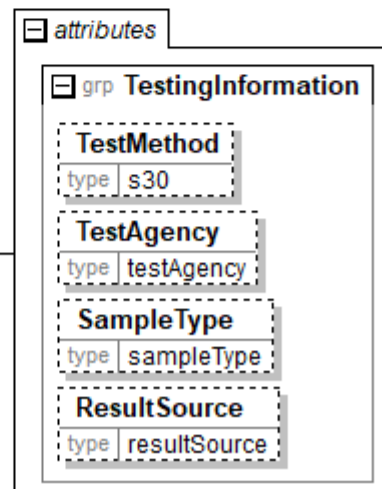
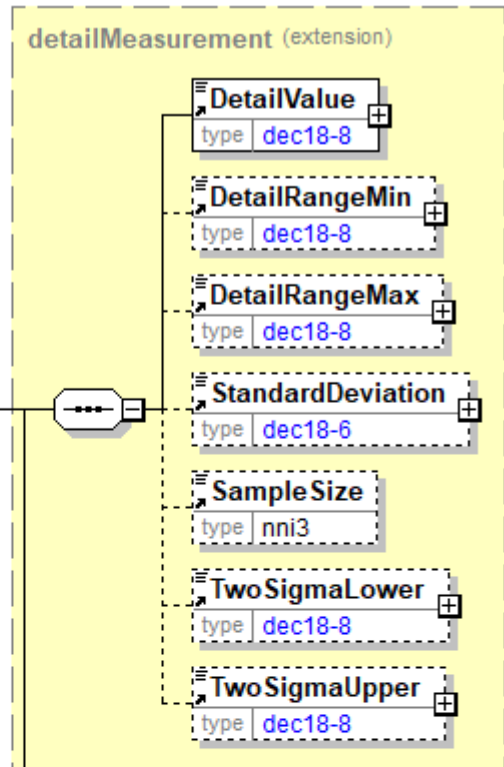

papiNet V2R31

DetailRangeMax is optional. A single instance might exist.

The maximum value (upper boundary) allowed for the DetailValue that is the parent of this element.

StandardDeviation

StandardDeviation is optional. A single instance might exist.

A statistic used as a measure of dispersion in a distribution.

SampleSize

SampleSize is optional. A single instance might exist.

The number of samples used to determine the product characteristic in question.

TwoSigmaLower

TwoSigmaLower is optional. A single instance might exist.

Two sigma (a measure of dispersion associated with standard deviation) on the lower side of the standard deviation.

TwoSigmaUpper

TwoSigmaUpper is optional. A single instance might exist.

Two sigma (a measure of dispersion associated with standard deviation) on the upper side of the standard deviation.

DepartureDate

The required or actual date of departure.

(sequence)

The sequence of items below is mandatory. A single instance is required.

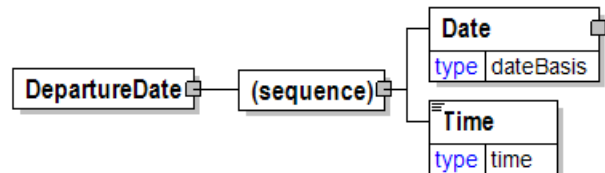

Date

Date is mandatory. A single instance is required.

A group element that contains the specification of Year, Month, and Day.

Time

Time is mandatory. A single instance is required.

Times are treated in a standard XML fashion with a special case used to indicate a generalized "local" time. The standard XML approach to time is hh:mm:ss, hh:mm:ssZ, or hh:mm:ss±hh:mm.

hh:mm:ss±hh:mm is used to represent a time with a time zone. The time zone is communicated as the number of hours offset from the Universal Time Coordinate (UTC), a.k.a. Greenwich Mean Time.

hh:mm:ssZ indicates the time at Zulu (another name for UTC).

hh:mm:ss or hh:mm indicates within papiNet the applicable local time where the associated event is taking place. Caution should be used when processing times of this nature as the papiNet approach may be in discord with other users of XML.

DetailRangeMax

The maximum value (upper boundary) allowed for the DetailValue that is the parent of this element.

UOM [attribute]

UOM is mandatory. A single instance is required.

Defines the unit of measure for the value.

Refer to UOM definition for any enumerations.

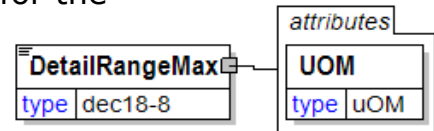

DetailRangeMin

The minimum value (lower boundary) allowed for the DetailValue that is the parent of this element.

UOM [attribute]

UOM is mandatory. A single instance is required.

Defines the unit of measure for the value.

Refer to UOM definition for any enumerations.

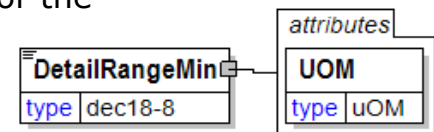

DetailValue

A numeric value expressed in the unit of measure (UOM).

UOM [attribute]

UOM is mandatory. A single instance is required.

Defines the unit of measure for the value.

Refer to UOM definition for any enumerations.

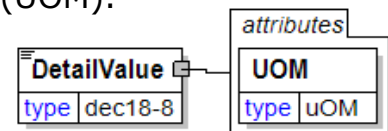

DeviationReason

A group item containing the reason for deviation from the plan.

(sequence)

The sequence of items below is mandatory. A single instance is required.

DeviationReasonCode

DeviationReasonCode is optional. A single instance might exist.

A code specifying the reason for deviation from the plan.

DeviationReasonDescription

DeviationReasonDescription is mandatory. One instance is required, multiple instances might exist.

A text describing the reason for the deviation from the plan.

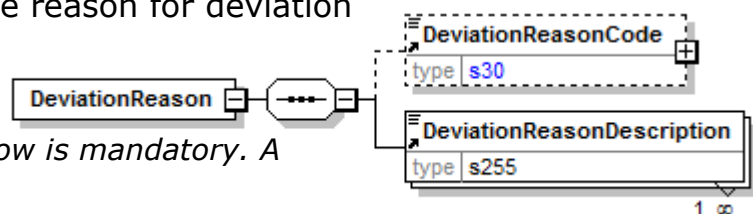

DeviationReasonCode

A code specifying the reason for deviation from the plan.

Agency [attribute]

Agency is mandatory. A single instance is required.

Describes the agency maintaining the list of codes. To be included in this list the agency must be a recognized standards body or industry organisation.

- For the element that owns this attribute.
- For another attribute in the list of attributes associated with the parent element.

Refer to Agency definition for any enumerations.

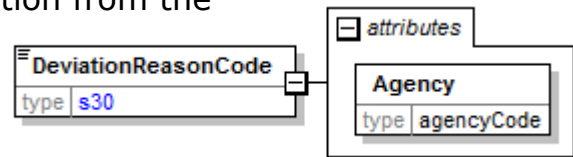

DeviationReasonDescription

A text describing the reason for the deviation from the plan.

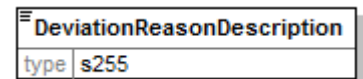

DiameterBreastHeight

Used to report the log diameter 4.5 feet from the butt end as a measurement. Used with the LogConversionRule attribute to determine log's volume conversion to board-feet or other measure.

(sequence)

The sequence of items below is mandatory. A single instance is required.

Value

Value is mandatory. A single instance is required.

A numeric value expressed in the unit of measure (UOM).

RangeMin

RangeMin is optional. A single instance might exist.

The minimum value (lower boundary) allowed for the Measurement that is the parent of this element.

RangeMax

RangeMax is optional. A single instance might exist.

The maximum value (upper boundary) allowed for the Measurement that is the parent of this element. Some elements use the RangeMax element with an extended list of unit of measures. (Note: the red colour in the picture is an artifact of how the graphic was captured and should be disregarded.)

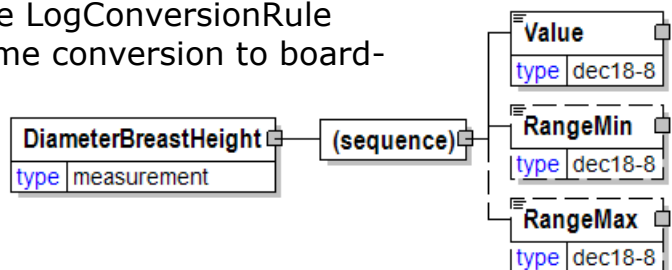

DieCut [attribute]

Either "Yes" or "No".

This item is restricted to the following list.

Yes

No

attribute	
DieCut	
type	yesNo

DieCutDescription

Die cut description

DieCutDescription	
type	s255

DirectLoading [attribute]

Specifies if the transport unit should be loaded directly with goods received on another transport unit.

This item is restricted to the following list.

Yes

No

attribute	
DirectLoading	
type	yesNo
default	No

DirectUnloading [attribute]

Specifies if the transport unit should be unloaded directly on to a new transport unit. Certain transport units, e.g. cassettes, can be stored in warehouses a short period waiting for direct unloading.

This item is restricted to the following list.

Yes

No

attribute	
DirectUnloading	
type	yesNo
default	No

Dirt

A group item used to communicate dirt content target or test value according to a particular TestMethod.

TestMethod [attribute]

TestMethod is optional. A single instance might exist.

The method used to determine the results of the test under consideration.

TestAgency [attribute]

TestAgency is optional. A single instance might exist.

The agency that has set the parameters for the testing

Refer to TestAgency definition for any enumerations.

SampleType [attribute]

SampleType is optional. A single instance might exist.

Communicates how sampling was done to measure the product characteristics.

Refer to SampleType definition for any enumerations.

ResultSource [attribute]

ResultSource is optional. A single instance might exist.

Used to define the data source of the specified test

Refer to ResultSource definition for any enumerations.

(sequence)

The sequence of items below is mandatory. A single instance is required.

DetailValue

DetailValue is mandatory. A single instance is required.

A numeric value expressed in the unit of measure (UOM).

DetailRangeMin

DetailRangeMin is optional. A single instance might exist.

The minimum value (lower boundary) allowed for the DetailValue that is the parent of this element.

DetailRangeMax

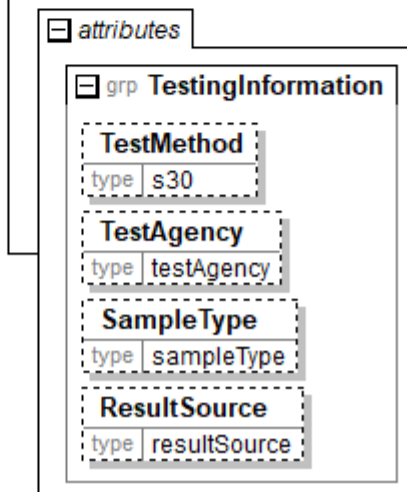
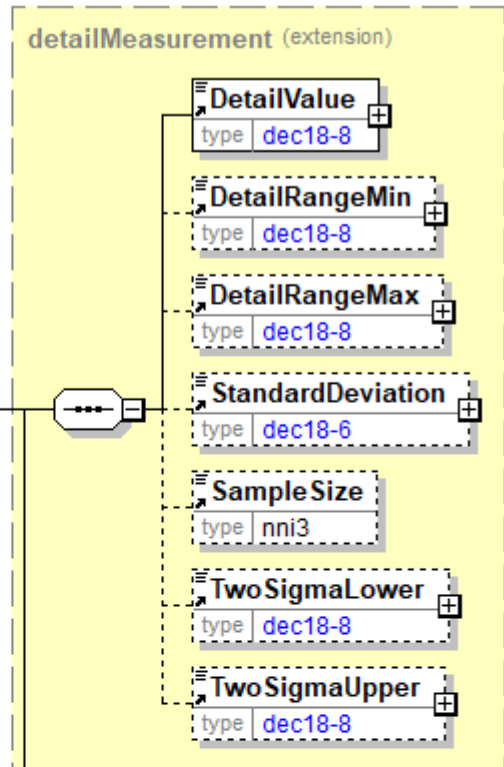

papiNet V2R31

DetailRangeMax is optional. A single instance might exist.

The maximum value (upper boundary) allowed for the DetailValue that is the parent of this element.

StandardDeviation

StandardDeviation is optional. A single instance might exist.

A statistic used as a measure of dispersion in a distribution.

SampleSize

SampleSize is optional. A single instance might exist.

The number of samples used to determine the product characteristic in question.

TwoSigmaLower

TwoSigmaLower is optional. A single instance might exist.

Two sigma (a measure of dispersion associated with standard deviation) on the lower side of the standard deviation.

TwoSigmaUpper

TwoSigmaUpper is optional. A single instance might exist.

Two sigma (a measure of dispersion associated with standard deviation) on the upper side of the standard deviation.

DiscPrinting [attribute]

Disc printing

This item is restricted to the following list.

Screen

Thermal



DistanceFromCore

The distance from the radius of the core. This element can be used to communicate where a mill join is located.

Compare to LengthFromCore.

(sequence)

The sequence of items below is mandatory. A single instance is required.

Value

Value is mandatory. A single instance is required.

A numeric value expressed in the unit of measure (UOM).

RangeMin

RangeMin is optional. A single instance might exist.

The minimum value (lower boundary) allowed for the Measurement that is the parent of this element.

RangeMax

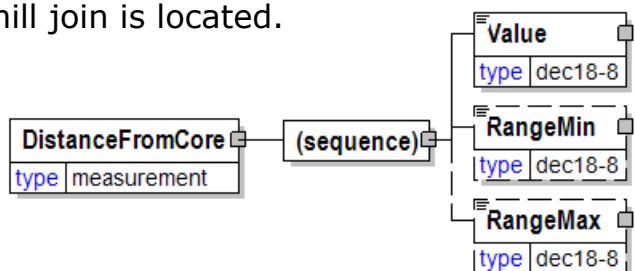

RangeMax is optional. A single instance might exist.

The maximum value (upper boundary) allowed for the Measurement that is the parent of this element. Some elements use the RangeMax element with an extended list of unit of measures. (Note: the red colour in the picture is an artifact of how the graphic was captured and should be disregarded.)

DistanceFromEdge

The distance from the edge of the paper. This element is used to communicate where the hole is.

EdgeType [attribute]

EdgeType is optional. A single instance might exist.

Edge type (paper)

Refer to EdgeType definition for any enumerations.

DisanceMeasuredTo [attribute]

DistanceMeasuredTo is optional.

Defines how the distance is measured from the edge of the paper to the hole.

This item is restricted to the following list.

Edge

Distance is measured to the edge of the hole.

Middle

Distance is measured to the middle of the hole.

(sequence)

The sequence of items below is mandatory. A single instance is required.

Value

Value is mandatory. A single instance is required.

A numeric value expressed in the unit of measure (UOM).

RangeMin

RangeMin is optional. A single instance might exist.

The minimum value (lower boundary) allowed for the Measurement that is the parent of this element.

RangeMax

RangeMax is optional. A single instance might exist.

The maximum value (upper boundary) allowed for the Measurement that is the parent of this element. Some elements use the RangeMax element with an extended list of unit of measures. (Note: the red colour in the picture is an artifact of how the graphic was captured and should be disregarded.)

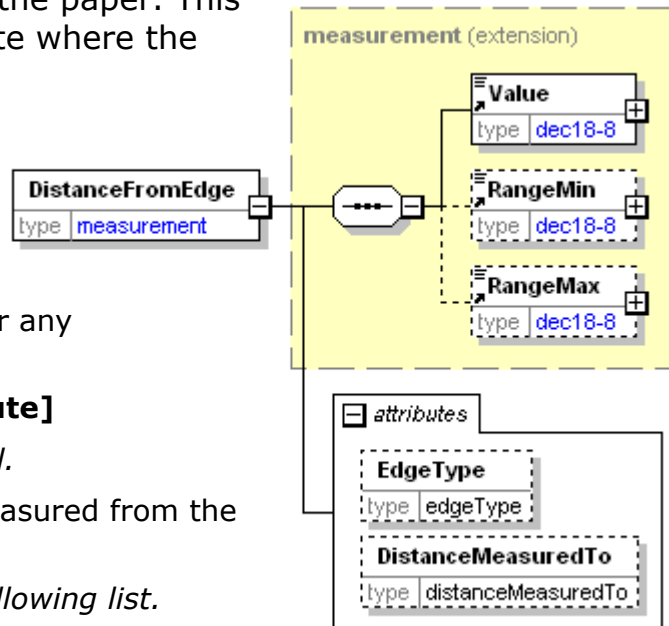

DistanceMeasuredTo [attribute]

Defines how the distance is measured from the edge of the paper to the hole.

This item is restricted to the following list:

Edge

Distance is measured to the edge of the hole.

Middle

Distance is measured to the middle of the hole.



DistanceToNextStop

The distance to the next transportation node.

(sequence)

The sequence of items below is mandatory. A single instance is required.

Value

Value is mandatory. A single instance is required.

A numeric value expressed in the unit of measure (UOM).

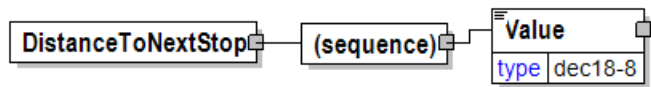

Document

A group item containing information applicable to the original document.

DocumentName [attribute]

DocumentName is mandatory. A single instance is required.

Defines the name of e-Documents defined by papiNet.

Refer to DocumentName definition for any enumerations.

DocumentType [attribute]

DocumentType is optional. A single instance might exist.

The type of e-Document being communicated.

Refer to DocumentType definition for any enumerations.

OtherDocumentName [attribute]

OtherDocumentName is optional. A single instance might exist.

Defines the document name for documents that are not papiNet e-Documents. These documents are defined in element Document by OtherDocumentName when attribute DocumentName has the value "Other".

OtherDocumentType [attribute]

OtherDocumentType is optional. A single instance might exist.

Defines the document type for a document that is not a papiNet e-Document.

(sequence)

The sequence of items below is mandatory. A single instance is required.

DocumentNumber

DocumentNumber is mandatory. A single instance is required.

The unique identifier of a document.

DocumentVersionNumber

DocumentVersionNumber is optional. A single instance might exist.

The assigned version number of documents or other information items. For example version 2.12 of a price list on paper or the version number of a Measuring Information identified by a MeasuringNumber.

N.B. TransactionHistoryNumber keeps track of the version of a papiNet e-Document. A separate DocumentVersionNumber may also be assigned to an e-Document.

DocumentDate

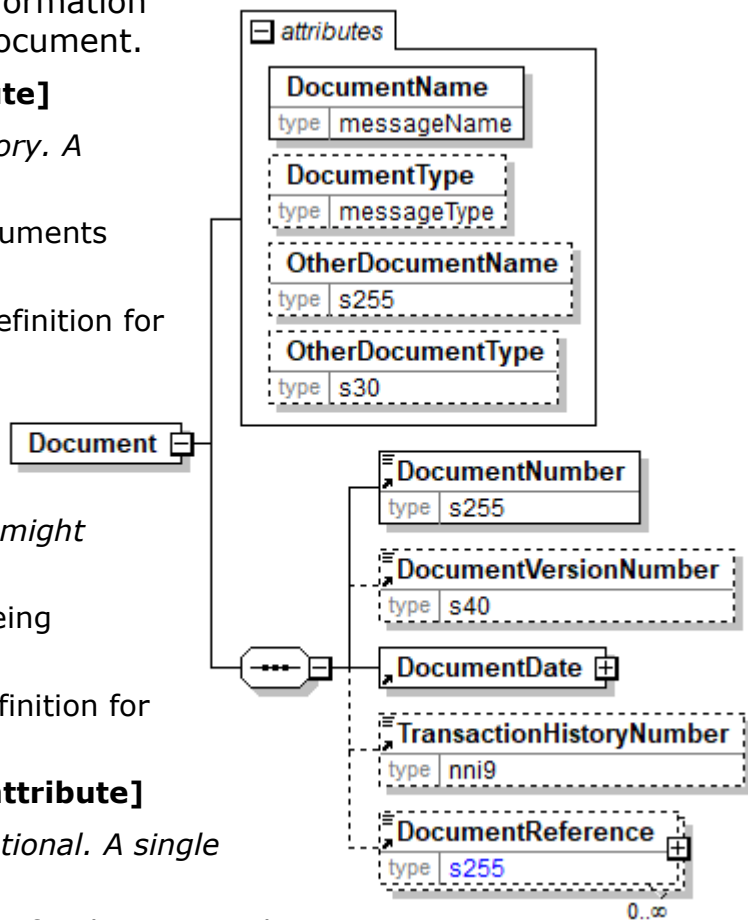

papiNet V2R31

DocumentDate is mandatory. A single instance is required.

The Date and optionally Time when the document that is referred to was issued.

TransactionHistoryNumber

TransactionHistoryNumber is optional. A single instance might exist.

A sequential number that keeps track of the version of a document.

However when the document is a confirmation document, in which case the TransactionHistoryNumber refers to the trigger transaction for the confirmation.

DocumentReference

DocumentReference is optional. Multiple instances might exist.

An element detailing relevant references pertaining to the papiNet e-Document as indicated by the DocumentReferenceType and AssignedBy.

DocumentContent

A grouping element specifying information contained in a document.

DocumentContentType [attribute]

DocumentContentType is mandatory. A single instance is required.

Specifies the type of information contained in a document.

Refer to DocumentContentType definition for any enumerations.

AssignedBy [attribute]

AssignedBy is mandatory. A single instance is required.

Identifies the type of party or the agency that has assigned the associated item, e.g. a reference of type OrderNumber.

Refer to AssignedBy for any enumerations.

(sequence)

The sequence of items below is mandatory. A single instance is required.

DocumentContentText

DocumentContentTextt is optional. Multiple instances might exist.

Text that is printed on a document.

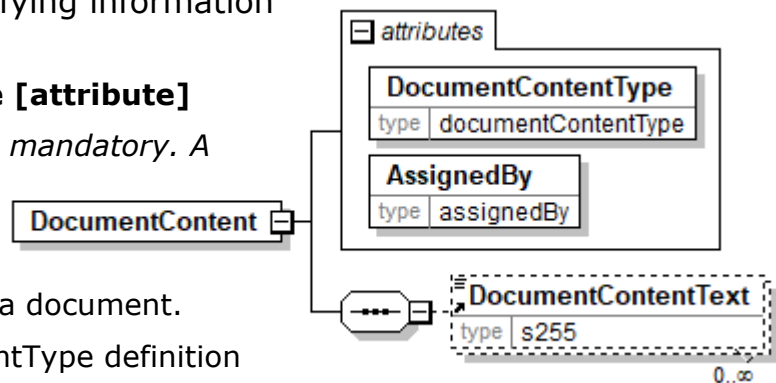

DocumentContentText

Text that is printed on a document.

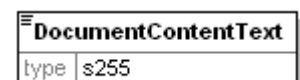

DocumentContentType [attribute]

Specifies the type of information contained in a document.

This item is restricted to the following list.

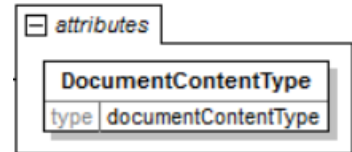

Author

Name of the author of the product or book

BasisWeight

The weight of the paper expressed as a mass for a given surface area.

BoxWeight

Weight of the filled box.

BookVolumeNumber

A number assigned to a book that denotes the sequential order when several books are either bound in an identical format or are part of a series or set.

BrandName

A specific product brand name for which the owner or source is specified in the "@AssignedBy" attribute.

Copyright

The year of publication copyright.

Edition

Identifies the version of the product for which copies were printed and published at one time; For example in book manufacturing values might be 1st, 2nd, etc

ExportShipMark

An export shipment mark for identification.

GradeCode

A specific product code for which the owner or source is specified in the "@AssignedBy" attribute.

GradeName

A specific product name for which the owner or source is specified in the "@AssignedBy" attribute (for example, ImprovedNewsprint-45-1479).

Identifier

Identifier of the individual item.

ISBN10

10 digit ISBN code without dashes.

ISBN10Dash

10 digit ISBN code with dashes.

ISBN13

13 digit ISBN code.

ISBN13Dash

papiNet V2R31

A 13 character ISBN with dashes.

LotIdentifier

A unique code used to identify a grouping of product with one set of quality statistics common to all members of that group. Synonym: Lot Number.

PartNumber

An equivalent to the Stock Keeping Unit (SKU) for which the owner or source is specified in the "@AssignedBy" attribute. In other words, this code fully defines the product.

PlainText

To be deprecated in a future version V3R00. Use instead "ReferenceNumber".

PrintingNumber

A reference to the sequential print run number.

ProductIdentifier

To be deprecated in a future version V3R00. Use instead specific product identifier types such as BrandName, GradeCode, GradeName and PartNumber.

ProfitCenter

Profit Center identifier.

PublisherName

Name of the publisher of a document.

PubName

The publication name.

PurchaseOrderNumber

The unique order identifier as designated by the customer.

PurchaseOrderReference

To be deprecated in a future version V3R00. Use instead "ReferenceNumber".

ReferenceNumber

An informational reference (either textual or numeric) for which the owner or source is specified in the "@AssignedBy" attribute

RetailPrice

Cover price of the finished product.

TambourID

The unique identifier of the jumbo reel (also called mother reel or Tambour).

Title

Proper title of a book product.

TitleAlias

Alternate title description for book products, usually for security purposes.

UnitsPerCarton

Number of units per box.

papiNet V2R31

UniversalProductIdentifier

Unique identifier for the book, component of a book product, and many other products.

VendorBrandName

To be deprecated in a future version V3R00. Use instead "BrandName" and specify owner or source is in the "@AssignedBy" attribute with enumeration "Seller".

VendorGradeCode

To be deprecated in a future version V3R00. Use instead "GradeCode" and specify owner or source is in the "@AssignedBy" attribute with enumeration "Seller".

VendorGradeName

To be deprecated in a future version V3R00. Use instead "GradeName" and specify owner or source is in the "@AssignedBy" attribute with enumeration "Seller".

DocumentDate

The Date and optionally Time when the document that is referred to was issued.

(sequence)

The sequence of items below is mandatory. A single instance is required.

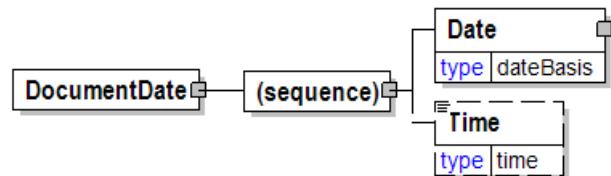

Date

Date is mandatory. A single instance is required.

A group element that contains the specification of Year, Month, and Day.

Time

Time is optional. A single instance might exist.

Times are treated in a standard XML fashion with a special case used to indicate a generalized "local" time. The standard XML approach to time is hh:mm:ss, hh:mm:ssZ, or hh:mm:ss±hh:mm.

hh:mm:ss±hh:mm is used to represent a time with a time zone. The time zone is communicated as the number of hours offset from the Universal Time Coordinate (UTC), a.k.a. Greenwich Mean Time.

hh:mm:ssZ indicates the time at Zulu (another name for UTC).

hh:mm:ss or hh:mm indicates within papiNet the applicable local time where the associated event is taking place. Caution should be used when processing times of this nature as the papiNet approach may be in discord with other users of XML.

DocumentExchangeType [attribute]

Defines how a document is communicated.

This item is restricted to the following list.

ByEmail

The document is sent by electronic mail (e-mail).

ByMessageService

The document is sent electronically by an agreed message service other than e-mail.

ByPost

The document is sent by post.



DocumentFormatType [attribute]

Defines the format of a document.

This item is restricted to the following list.

papiNetXML

XML-files according to the papiNet standard.

PDF

Portable Digital Format (PDF) is a digital document format developed by Adobe Systems.

Printout

A business document printed on paper in a readable format.

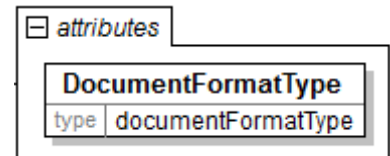

DocumentInformation

A group element containing a specification of required documents in the business process. Additional free text to be printed on documents can also be specified.

DocumentType [attribute]

DocumentType is mandatory. A single instance is required.

Identifies the type of a document

Refer to DocumentType definition for any enumerations.

(sequence)

The sequence of items below is mandatory. A single instance is required.

NumberOfDocuments

NumberOfDocuments is optional. Multiple instances might exist.

Specifies the number of documents needed.

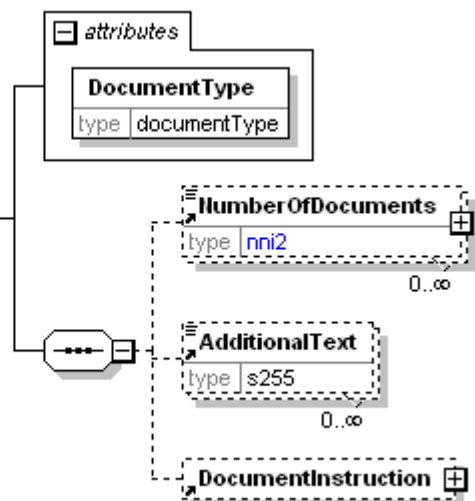

AdditionalText

AdditionalText is optional. Multiple instances might exist.

A text field that is used to communicate information not previously defined or for special instructions. To be used only for circumstances not covered by specific elements.

DocumentInstruction

DocumentInstruction is optional. A single instance might exist.

A grouping element that specifies instructions and contents related to the creation and use of a document.

DocumentInstruction

A grouping element that specifies instructions and contents related to the creation and use of a document.

(sequence)

The sequence of items below is mandatory. A single instance is required.

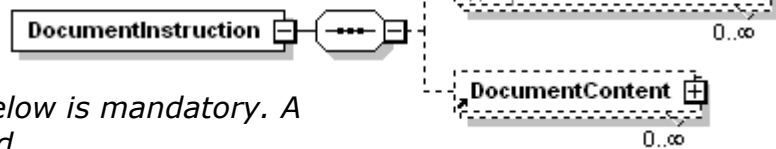

DocumentInstructionText

DocumentInstructionText is optional. Multiple instances might exist.

Text that is describing instructions related to the creation and use of a document.

DocumentContent

DocumentContent is optional. Multiple instances might exist.

A grouping element specifying information contained in a document.

DocumentInstructionText

Text that is describing instructions related to the creation and use of a document.

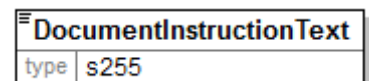

DocumentIssueDate

The date and time when the e-Document was issued.

(sequence)

The sequence of items below is mandatory. A single instance is required.

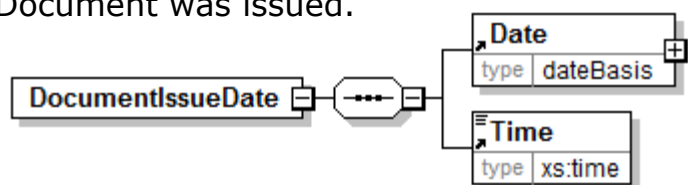

Date

Date is mandatory. A single instance is required.

A group element that contains the specification of Year, Month, and Day.

Time

Time is mandatory. A single instance is required.

papiNet V2R31

Times are treated in a standard XML fashion with a special case used to indicate a generalized "local" time. The standard XML approach to time is hh:mm:ss, hh:mm:ssZ, or hh:mm:ss±hh:mm.

hh:mm:ss±hh:mm is used to represent a time with a time zone. The time zone is communicated as the number of hours offset from the Universal Time Coordinate (UTC), a.k.a. Greenwich Mean Time.

hh:mm:ssZ indicates the time at Zulu (another name for UTC).

hh:mm:ss or hh:mm indicates within papiNet the applicable local time where the associated event is taking place. Caution should be used when processing times of this nature as the papiNet approach may be in discord with other users of XML.

DocumentName [attribute]

Defines the name of e-Documents defined by papiNet.

This item is restricted to the following list.

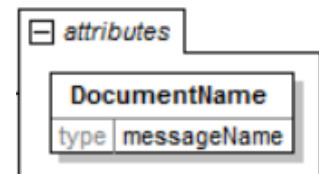

Availability

The purpose of the Availability e-Document is to provide a means to ask about the availability of the specified product. The amount of the product immediately available (on-hand) is anticipated to be returned. Optionally, the anticipated availability of the product at a point in future can be communicated.

BookSpecification

The BookSpecification e-Document represents established product specifications that can be referenced by multiple transactions in the manufacturing life cycle of a product from RFQ through Invoice and subsequent reprints and/or reorders. It captures unique book manufacturing industry data elements as established by the buyer that are needed by the supplier for manufacturing.

BusinessAcceptance

The receiver of a document uses the BusinessAcceptance to confirm to the sender that the document is accepted or rejected. The BusinessAcceptance can be used as a confirmation of acceptance when there is not a papiNet-designed confirmation e-Document available. Although the BusinessAcceptance is optional between two trading partners, its use is strongly recommended when it is important to get a BusinessAcceptance.

BusinessAcknowledgement

An e-Document receiver uses the BusinessAcknowledgement to notify the sender that a document has been successfully presented to the receiver's ERP system. The BusinessAcknowledgement can be used to acknowledge any papiNet e-Document. Although the BusinessAcknowledgement is optional between two trading partners, its use is strongly recommended since it provides positive verification of the beginning of the transaction by the receiver.

Calendar

The Calendar e-Document is intended to communicate opening times or other

details for a location or locations

CallOff

A CallOff is a delivery schedule for product(s). Products to be delivered can be specified by product specifications or by purchase orders. Any party as agreed in a Trading Partner Agreement can send a CallOff. Each line item in a CallOff refers either to a product included in a PurchaseOrder or to the product specifications contained in the line item. The CallOff specifies delivery schedule(s) and quantities for product(s) to be delivered. The schedule may define a specific date and/or time for delivery or include a time range. All products covered by a CallOff must be delivered to a single location.

CallOffWood

A CallOffWood is a business transaction instructing the consignor (normally the seller) to despatch goods belonging to one or several orders. A CallOffWood contains information about how the goods are to be loaded, quantities, marking instructions etc. It may also contain information about where borders are to be crossed and information concerning transport, such as name of ship and shipping agent. In cases where the CallOffWood is not used, delivery information is included in the order.

Complaint

Typically, a Complaint e-Document is sent from the customer or end user to the supplier to communicate information regarding products or services. A response from the supplier is desired and corrective actions, if required. This e-Document must specify the necessary details to enable the supplier to trigger an internal process to verify whether the complaint reason corresponds to the supplier-assessed reason.

ComplaintResponse

Typically, a ComplaintResponse e-Document is sent from the supplier or sender parties to the party who has originated the Complaint, or possibly to the RespondToParty. The e-Document is sent to communicate the acceptance, partial acceptance, or rejection, of the preceding complaint(s) with supporting information. Whatever the decision, this e-Document must specify how the complaint will be processed.

ContentOrderOfMatter

The ContentOrderOfMatter e-Document accompanies the prep content files for the sole purpose of specifying the page sequence in the book and the associated folio information.

Contract

The Contract e-Document can be used by business partners to communicate business agreements. Contracts are managed by a ContractParty that normally is the seller or the buyer. The Contract e-Document can also be sent to service providers that need the contract information for carrying out their services.

CreditDebitNote

The CreditDebitNote e-Document is generally used by the SupplierParty to compensate or charge the trading parties (ShipToParty, BuyerParty, OtherParty, etc.) for matters outside the scope of the Invoice.

DeliveryInstruction

A DeliveryInstruction can be used to instruct movement of goods to warehouses and movement of goods to virtual locations within warehouses as well as deliveries to customers. The DeliveryInstruction e-Document is designed to fulfil supply chain requirements regarding instruction for goods deliveries to Mills, Suppliers, Forwarders, Warehouse Operators, Customers, and End-Users. The DeliveryInstruction is load oriented which is very efficient when mills and suppliers move goods in large quantities between warehouses.

DeliveryMessage

The DeliveryMessage e-Document enables the sender to describe the contents and configuration of a shipment at various levels of detail.

DeliveryMessageBook

The DeliveryMessageBook e-Document enables the sender to describe the contents and configuration of a shipment at various levels of detail.

DeliveryMessageWood

The DeliveryMessageWood e-Document enables the sender to describe the contents and configuration of a shipment at various levels of detail.

DeliveryPlanning

The DeliveryPlanning e-Document provides a tool for trading partners to exchange information about logistics planning for deliveries, transports and resources. Information can be specified for various levels such as a Budget, a Forecast, a Demand or a detail Plan for a certain period. Actual outcome to date related to a plan can also be reported.

Reason for deviation between a plan and the actual outcome can be reported. Opening times and/or contingencies can be specified for locations for a given day or period.

The DeliveryPlanning e-Document can supply a complete sourcing plan for a certain planning region containing for example many mills. Origin and destination for products can be specified as well as various transport modes and other transport details.

GoodsReceipt

The ShipTo party, or authorised agent, sends a GoodsReceipt e-Document to the Supplier and/or to the Buyer acknowledging that a specific delivery or a number of deliveries in a given time period have been received and their status.

InfoRequest

The purpose of InfoRequest e-Document is to allow the requesting party to request from the receiver party an update. The e-Documents that may be returned in response to an InfoRequest are the Availability, Calendar, InventoryStatus, OrderStatus, Planning, ProductQuality, ShipmenStatus, ShippingInstructions or Statement.

InventoryChange

The purpose of the InventoryChange e-Document is to inform involved parties about changes in the inventory at a specific location. The e-Document provides information allowing the receiving party to update their systems for

cost tracking, performance, and financial reporting.

InventoryDispositionInstructions

The InventoryDispositionInstructions e-Document permits the owner of inventory stored at a third party location to request the inventory be destroyed, shipped to another location, held in inventory, or physically changed. The receiving party makes the requested changes to the inventory and sends an InventoryChange and ShippingInstructions, if required, to the requestor so their systems can be updated.

InventoryStatus

The InventoryStatus e-Document informs involved parties about physical inventory levels at specific stock locations (warehouse, terminal, printer etc.) at a certain time (snapshot).

Invoice

An Invoice e-Document can handle both debits and credits. Typically a seller sends an Invoice to a buyer after delivering the products or services specified in a PurchaseOrder or as part of an automatic replenishment agreement. Alternatively, an Invoice can be prepared by the buyer as part of a self-billing process. The Invoice is a list of the goods shipped and their quantities, or services rendered, indicating the price, terms of sale, supplemental charges, allowances, and communicates the payment required for the indicated items.

InvoiceWood

An InvoiceWood e-Document can handle both debits and credits. Typically a seller sends an InvoiceWood to a buyer after delivering the products or services specified in a PurchaseOrder or as part of an automatic replenishment agreement. Alternatively, an InvoiceWood can be prepared by the buyer as part of a self-billing process. The InvoiceWood is a list of the goods shipped and their quantities, or services rendered, indicating the price, terms of sale, supplemental charges, allowances, and communicates the payment required for the indicated items.

LoadAvailable

The Supplier party or authorized agent sends a LoadAvailable e-Document to the BuyerParty (consuming mill) indicating that load(s) for specific product is (are) ready on a specific date for acceptance and pickup. The LoadAvailable e-Document from the supplier may include a Shipper Load Number. This number may be used as the consuming mill's release number. The Shipper Load Number is used for authorization for pick-up of load at supplier point.

LoadTender

The LoadTender e-Document supports the transport booking process. Transport booking includes the following steps:

- LoadTender – more than one carrier has been informed about the upcoming transport.
- Booking – identifies a transport booking that is part of a detail transport plan, the load has been booked with a single carrier.

LoadTenderResponse

The LoadTenderResponse e-Document supports the transport booking process and is used as a response e-Document to LoadTender e-Document. Transport

booking includes the following steps:

- LoadTenderResponse – more than one carrier has been informed about the upcoming transport.
- BookingConfirmation – identifies a transport booking that is part of a detail transport plan, the load has been booked with a single carrier.

MeasuringInstruction

The MeasuringInstruction e-Document can be used to instruct a measuring party what to measure and how to measure it. Packages and loads as well as individual items can be measured.

MeasuringTicket

The MeasuringTicket e-Document specifies the details from measuring of items. Packages and loads can be measured as well as individual items in packages and loads. Products, Quantities and various measured properties can be reported. These measurements can be used as a base for calculation of billable products.

OrderConfirmation

A seller sends an OrderConfirmation e-Document to a buyer after receiving a PurchaseOrder from that buyer. The e-Document contains a response to the conditions specified in the PurchaseOrder. A supplier may also send an OrderConfirmation e-Document to convey changes that the supplier has made in the order or to convey new information such as a Supplier Reference Number or Job Number.

OrderConfirmationWood

A seller sends an OrderConfirmationWood e-Document to a buyer after receiving a PurchaseOrder from that buyer. The e-Document contains a response to the conditions specified in the PurchaseOrder. A supplier may also send an OrderConfirmationWood e-Document to convey changes that the supplier has made in the order or to convey new information such as a Supplier Reference Number or Job Number.

OrderStatus

The OrderStatus e-Document permits the sender to report the current status of an order, specific order line items, or to report status of multiple orders based upon some specified criteria. The e-Document enables the sender to indicate a primary status as well as an additional secondary status at the order level as well as for each line and component.

PackingList

The PackingList e-Document specifies the details of a shipment that is being despatched. The seller should send the PackingList e-Document in sufficient time so that the recipient can process the information before the goods arrive. The recipient can then prepare efficiently for the receipt of the goods.

Planning

The Planning e-Document provides a tool for trading partners to exchange forecasted or planned information for a specific product or event within a specified timeframe. The e-Document is designed to support a variety of business processes, which may include securing needed supplies or simply the exchange of information.

Preflight

The Preflight e-Document reports the status of prep content files separately, by product or by Purchase Order or to report status of multiple files based upon some specified criteria. The e-Document enables the sender to indicate a primary status as well as an additional secondary status as needed.

ProductAttributes

The ProductAttributes e-Document provides the means to communicate information about products between business partners.

ProductPerformance

The ProductPerformance e-Document is created by the product consumer in order to communicate back to the manufacturer the performance of the product. This e-Document will enable the manufacturer to focus on improvements related to product defects that create inefficiency during performance. The aggregation of performance factors by product will provide the mechanism for achieving the value aspect of the e-Document. The goal is to keep the products of the Pulp & Paper Industry attractive versus competing alternatives.

ProductQuality

The ProductQuality e-Document supports the exchange of quality data for individual items. The agreed properties of the product that are exchanged can include statistical values such as minimum and maximum, standard deviation, sample size, two sigma (lower-limit, upper-limit).

PurchaseOrder

A buyer sends a PurchaseOrder e-Document to a supplier to initiate a trade transaction. This e-Document, which is a request for product, usually represents a firm commitment to buy. (For one type of PurchaseOrder, called a reservation order, the PurchaseOrder is not a firm commitment to buy).

PurchaseOrderWood

A PurchaseOrderWood e-Document is set up between a buyer and a seller. In some cases an agent acts on behalf of the seller or the buyer when setting up the contract. However, the contract is not valid until signed by the buyer and the seller. A PurchaseOrderWood may cover one delivery of merchandise on one occasion or cover a time period with several deliveries. This PurchaseOrderWood refers to a standardised contract form containing all legal details.

QR

QR (Quick Response) is a light weight papiNet e-Document that is designed to be carried by Quick Response Codes. Multiple document types can be defined in the QR e-Document supporting different contents of QR Codes.

RFQ

A buyer sends an RFQ e-Document to a supplier to initiate a request for quotation. This e-Document, which is a request for product information, represents a request for the supplier to provide a quotation for product availability, shipping, and price.

RFQResponse

papiNet V2R31

A supplier sends an RFQResponse e-Document to a buyer as a response to an RFQ e-Document from the buyer. The e-Document specifies a quotation for product availability, shipping, and price.

ScaleTicket

The ScaleTicket e-Document provides wood or fibre suppliers with a means to electronically incorporate scale system receiving data into their accounting systems from buying entities' back office systems.

ServiceInstruction

The ServiceInstruction e-Document can be used to instruct a party to carry out a service. Characteristics for the service can be specified.

Instructions for deliveries and measuring of products have dedicated e-Documents DeliveryInstruction and MeasuringInstruction.

ShipmentStatus

The ShipmentStatus e-Document is sent to communicate the status of a shipment or consignment with references to other documents. Typically, a ShipmentStatus e-Document is sent from the forwarder or carrier to the consignor / forwarder.

ShippingInstructions

The ShippingInstructions e-Document communicates delivery information for product(s) supported by a PurchaseOrder.

Statement

The Statement e-Document permits the manufacturer or supplier to report the current status of an invoice, or a list of invoices based upon specified criteria. The e-Document enables the sender to indicate payment status for the invoice.

Usage

The Usage e-Document is used to notify a supplier or buyer that material has been consumed within the end user's manufacturing process.

Other

Other e-documents not specified by papiNet.

DocumentNumber

The unique identifier of a document.

DocumentNumber	
type	s255

DocumentReference

An element detailing relevant references pertaining to the papiNet e-Document as indicated by the DocumentReferenceType and AssignedBy.

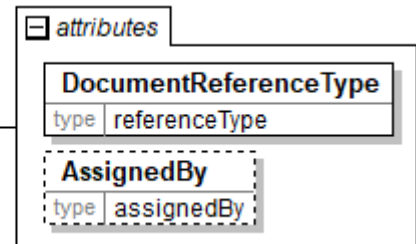
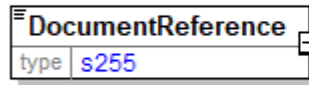

DocumentReferenceType [attribute]

DocumentReferenceType is mandatory. A single instance is required.

DocumentReferenceType provides a contextual explanation of the specific reference identifier. Many items are currently prefixed by "Buyer", "Customer", "Seller", and/or "Supplier". Check for an existing non-prefixed version and use the non-prefixed version instead. In the (yet to be announced release date) version 3.0 the prefixed versions will be removed. Instead the attribute @AssignedBy will communicate the information previously communicated in the prefix.

Refer to DocumentReferenceType definition for any enumerations.

AssignedBy [attribute]

AssignedBy is optional. A single instance might exist.

Identifies the type of party or the agency that has assigned the associated item, e.g. a reference of type OrderNumber.

Refer to AssignedBy definition for any enumerations.

DocumentReferenceID

Identification for the item being referenced.

DocumentReferenceIDType [attribute]

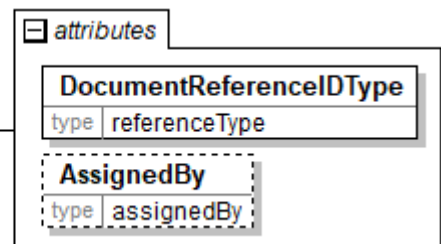
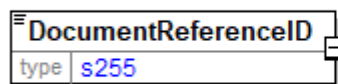

DocumentReferenceIDType is mandatory. A single instance is required.

Provides a contextual explanation of the specific reference identifier. Many items are currently prefixed by "Buyer", "Forwarder", "Manufacturer", "Mill", "Seller", "Supplier", "Warehouse", or "Vendor". Check for an existing non-prefixed version and use the non-prefixed version instead. In the (yet to be announced release date) version 3.0 the prefixed versions will be removed. Instead the attribute @AssignedBy will communicate the information previously communicated in the prefix.

Refer to DocumentReferenceIDType definition for any enumerations.

AssignedBy [attribute]

AssignedBy is optional. A single instance might exist.

Identifies the type of party or the agency that has assigned the associated item, e.g. a reference of type OrderNumber.

papiNet V2R31

Refer to AssignedBy definition for any enumerations.

DocumentReferenceIDLineItemNumber

Line item number for a specific line of the document being referenced

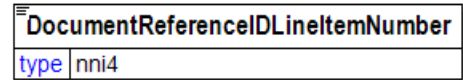

DocumentReferenceIDType [attribute]

Provides a contextual explanation of the specific reference identifier. Many items are currently prefixed by "Buyer", "Forwarder", "Manufacturer", "Mill", "Seller", "Supplier", "Warehouse", or "Vendor". Check for an existing non-prefixed version and use the non-prefixed version instead. In the (yet to be announced release date) version 3.0 the prefixed versions will be removed. Instead, the attribute @AssignedBy will communicate the information previously communicated in the prefix.

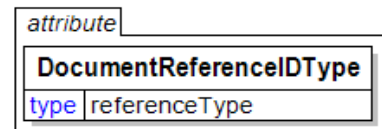

Refer to the [referenceType](#) entry for the list of enumerations and their definitions.

DocumentReferenceInformation

A group item containing reference information applicable to a document.

(sequence)

The sequence of items below is mandatory. A single instance is required.

DocumentReferenceID

DocumentReferenceID is mandatory. A

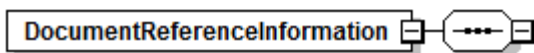

single instance is required.

Identification for the item being referenced.

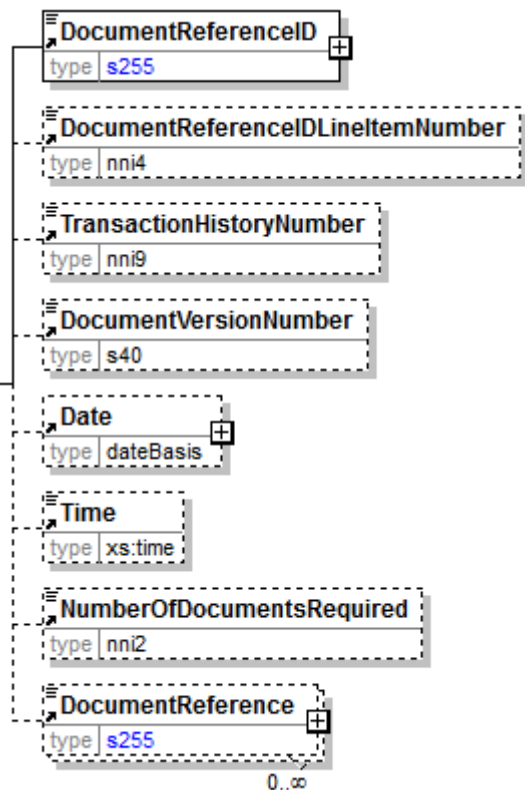

DocumentReferenceIDLineItemNumber

DocumentReferenceIDLineItemNumber is optional. A single instance might exist.

papiNet V2R31

Line item number for a specific line of the document being referenced.

TransactionHistoryNumber

TransactionHistoryNumber is optional. A single instance might exist.

A sequential number that keeps track of the version of a document.

However when the document is a confirmation document, in which case the TransactionHistoryNumber refers to the trigger transaction for the confirmation.

DocumentVersionNumber

DocumentVersionNumber is optional. A single instance might exist.

The assigned version number of documents or other information items. For example version 2.12 of a price list on paper or the version number of a Measuring Information identified by a MeasuringNumber.

N.B. TransactionHistoryNumber keeps track of the version of a papiNet e-Document. A separate DocumentVersionNumber may also be assigned to an e-Document.

Date

Date is optional. A single instance might exist.

A group element that contains the specification of Year, Month, and Day.

Time

Time is optional. A single instance might exist.

Times are treated in a standard XML fashion with a special case used to indicate a generalized "local" time. The standard XML approach to time is hh:mm:ss, hh:mm:ssZ, or hh:mm:ss±hh:mm.

hh:mm:ss±hh:mm is used to represent a time with a time zone. The time zone is communicated as the number of hours offset from the Universal Time Coordinate (UTC), a.k.a. Greenwich Mean Time.

hh:mm:ssZ indicates the time at Zulu (another name for UTC).

hh:mm:ss or hh:mm indicates within papiNet the applicable local time where the associated event is taking place. Caution should be used when processing times of this nature as the papiNet approach may be in discord with other users of XML.

NumberOfDocumentsRequired

NumberOfDocumentsRequired is optional. A single instance might exist.

The number of copies of the document required.

DocumentReference

DocumentReference is optional. Multiple instances might exist.

An element detailing relevant references pertaining to the papiNet e-Document as indicated by the DocumentReferenceType and AssignedBy.

DocumentReferenceType [attribute]

DocumentReferenceType provides a contextual explanation of the specific reference identifier. Many items are currently prefixed by "Buyer", "Customer", "Seller", and/or "Supplier". Check for an existing non-prefixed version and use the non-

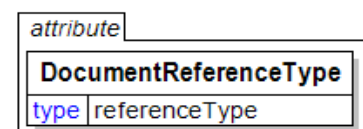

prefixed version instead. In the (yet to be announced release date) version 3.0 the prefixed versions will be removed. Instead the attribute @AssignedBy will communicate the information previously communicated in the prefix.

Refer to the [referenceType](#) entry for the list of enumerations and their definitions.

DocumentRejectionReason

A grouping element that contains information about the rejection reason for the document that is rejected.

Agency [attribute]

Agency is mandatory. A single instance is required.

Describes the agency maintaining the list of codes. To be included in this list the agency must be a recognized standards body or industry organisation.

- For the element that owns this attribute.
- For another attribute in the list of attributes associated with the parent element.

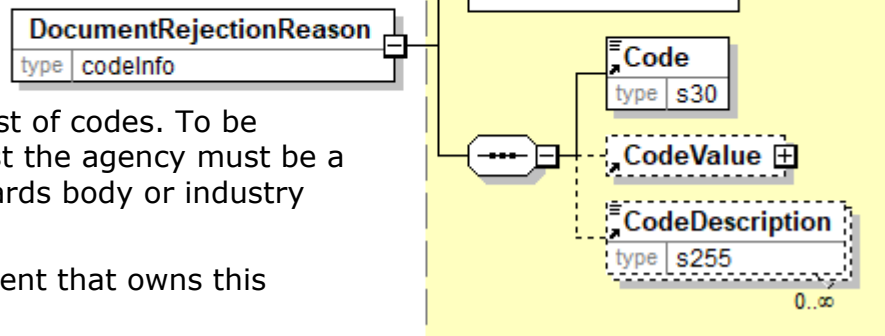

Refer to Agency definition for any enumerations.

(sequence)

The sequence of items below is mandatory. A single instance is required.

Code

Code is mandatory. A single instance is required.

Specifies a code that is defined by an agency. The agency is given for the whole construct containing the code.

CodeValue

CodeValue is optional. A single instance might exist.

A grouping element specifying a value belonging to a code that is defined by an agency.

CodeDescription

CodeDescription is optional. Multiple instances might exist.

A textual description for the meaning of a code that is defined by an agency. When the Code is associated with a CodeValue of type TextValue, then the CodeDescription is a textual description of both the Code and the TextValue.

DocumentRequired

An element that permits the listing of the documents required.

DocumentRequiredType [attribute]

DocumentRequiredType is mandatory. A single instance is required.

Indicates which documents are required.

Refer to DocumentRequiredType definition for any enumerations.

AssignedBy [attribute]

AssignedBy is optional. A single instance might exist.

Identifies the type of party or the agency that has assigned the associated item, e.g. a reference of type OrderNumber.

Refer to AssignedBy definition for any enumerations.

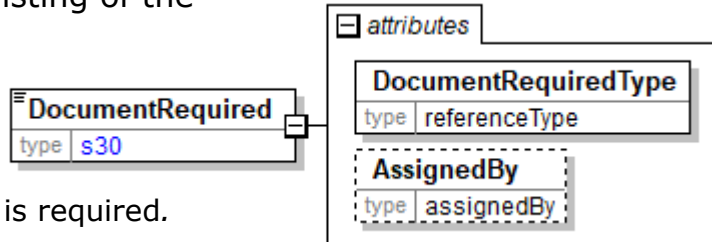

DocumentRequiredInfo

A group element that contains information about documents needed by parties in the business process.

DocumentName [attribute]

DocumentName is mandatory. A single instance is required.

Defines the name of e-Documents defined by papiNet.

Refer to DocumentName definition for any enumerations.

DocumentType [attribute]

DocumentType is optional. A single instance might exist.

The type of e-Document being communicated.

Refer to DocumentType definition for any enumerations.

DocumentFormatType [attribute]

DocumentFormatType is optional. A single instance might exist.

Defines the format of a document.

Refer to DocumentFormatType definition for any enumerations.

DocumentExchangeType [attribute]

DocumentExchangeType is optional. A single instance might exist.

Defines how a document is communicated.

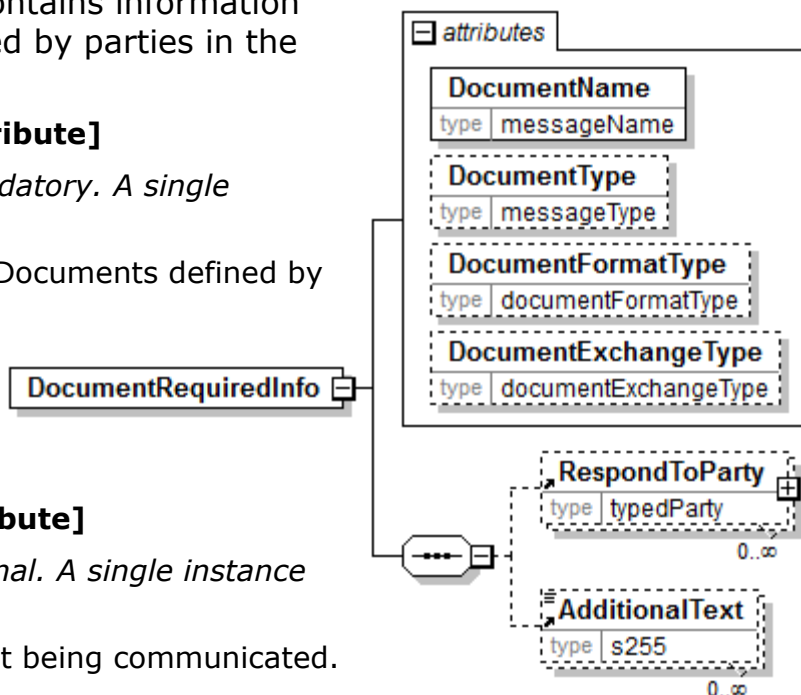

papiNet V2R31

Refer to DocumentExchangeType definition for any enumerations.

(sequence)

The sequence of items below is mandatory. A single instance is required.

RespondToParty

RespondToParty is optional. Multiple instances might exist.

The party the document should be responded to.

AdditionalText

AdditionalText is optional. Multiple instances might exist.

A text field that is used to communicate information not previously defined or for special instructions. To be used only for circumstances not covered by specific elements.

DocumentRequiredType [attribute]

Indicates which documents are required.

Many items are currently prefixed by "Buyer", "Customer", "Seller", and/or "Supplier". Check for an existing non-prefixed version and use the non-prefixed version instead. In the (yet to be announced release date) version 3.0 the prefixed versions will be removed. Instead the attribute @AssignedBy will communicate the information previously communicated in the prefix.

Refer to the [referenceType](#) entry for the list of enumerations and their definitions.

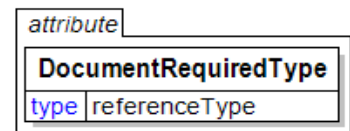

DocumentType [attribute]

Identifies the type of a document.
Used by DocumentInformation element

This item is restricted to the following list.

ATR

BillOfLading

CertificateForPackaging

CIM

CMR

DeliveryNote

EUR1

Invoice

PackingList

The PackingList e-Document specifies the details of a shipment that is being

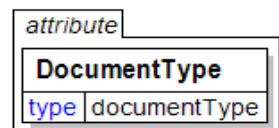

despatched. The seller should send the PackingList e-Document in sufficient time so that the recipient can process the information before the goods arrive. The recipient can then prepare efficiently for the receipt of the goods.

PowerOfAttorney

TORG12

T2

T2L

UnitPaper

WayBill

DocumentType [attribute]

The type of e-Document being communicated.
Used by Document element

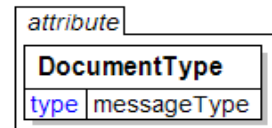

This item is restricted to the following list.

Agreement

A legally binding exchange of promises between parties that the law will enforce.

Approximate

An Invoice that is created to record ownership transfer without the material physically being moved. Typically what occurs is that the buyer has agreed to take ownership of the item at a certain point in time but has not arranged for transportation. Approximate invoices are invoices that are claiming payment.

ArrivalTicket

A MeasuringTicketType that contains information about rough measurements done upon arrival of a transport vehicle to a measuring location. For example used for updating physical location of the load and calculating compensation to the carrier.

AvailabilityInstruction

An AvailabilityInstruction can specify many delivery events. Each event can contain quantity for one or many loads, but does not specify the load. A DeliveryInstruction type DeliveryInstruction specifies more details for the events in an AvailabilityInstruction. AvailabilityInstruction can also be handled by the company responsible for the delivery independently if so agreed.

BlanketOrder

An order that communicates the same information as a StandardOrder but also indicates that the order may be completed over a period of time or, until a certain volume is achieved or, until a certain currency amount is spent.

Booking

An indication that time for a service is required. For example a booking that is part of a detail transport plan.

BookingConfirmation

A communication affirming the placement of the booking with a particular

party.

CalibrationCheckLog

A MeasuringTicketType that contains a check log with information about calibration of measuring equipment.

CallOff

Defines a CallOff sent by the buyer to the seller.

CallOffConfirmation

Defines a CallOff confirmation sent in response to a CallOff.

Claim

A "Claim" type is used when there is a customer reaction that includes a financial compensation.

ConfirmingOrder

A confirming order is used to electronically confirm an order that has not been placed electronically by the customer that is, it was placed using another mean such as fax, phone or email.

ConsumptionOrder

A PurchaseOrder that is based upon consumption for a particular period of time or instance.

CreditNote

Credits that are provided for amount reductions and complaints. A CreditNote will normally have a reference to an earlier issued Invoice.

DebitNote

A DebitNote claims payment for additional charges. A DebitNote normally has a reference to an earlier issued Invoice.

DeliveryInstruction

A DeliveryInstruction can specify many delivery events. Each event can contain quantity for one or many loads. A sequence in a DeliveryInstruction specifies all details for one event. The receiver of a DeliveryInstruction can generate many Loading Instructions from one DeliveryInstruction.

DeliveryMessage

A DeliveryMessage type that contains optional routing information, quantities at the DeliveryMessageLineItem level, and details at the DeliveryMessageLineItemDetail level. The seller uses a DeliveryMessage to provide delivery details to the ship-to party and tracking information.

DeliveryPlan

A DeliveryPlanningType used to inform about quantities and times for the planned deliveries to the delivery destinations.

Duplicate

To be deprecated in a future version V3R00. When an Invoice is reissued as a duplicate the Invoice type should be the same as on the original Invoice. Use attribute Reissued = Yes to indicate a duplicate.

Feedback

A "Feedback" type is used when there is a customer reaction that doesn't include any financial compensation.

ForestLoggingInstruction

An instruction specifying what products to produce in a forest logging and forwarding operation.

InitialShipmentAdvice

A DeliveryMessage type that contains detailed routing information, quantities at the DeliveryMessageLineItem level and optionally details at the DeliveryMessageLineItemDetail level. The seller uses the InitialShipmentAdvice to provide preliminary notification of shipment routing and quantities (can be used as an advanced notice of delivery). The quantities indicated may not necessarily be delivered—for example, if there is damage in transit or the delivery is rerouted to another destination.

Invoice

A regular Invoice (referred to as an Invoice) is claims payment for products, services, and charges supplied under conditions agreed to between seller and buyer. The Invoice communicates, among other things, payment terms, payment method, and the payment amount required for one or more deliveries.

InvoiceSpecification

A MeasuringTicketType that contains information about measured products including prices and amounts. This MeasuringTicketType is normally used as a detailed specification of billable or invoiced products.

LoadAvailable

LoadAvailable indicates the e-Document is from the company with the load.

LoadAvailableConfirmation

LoadAvailableConfirmation indicates the e-Document is from the company to whom the load was offered.

LoadedSpecification

A DeliveryMessage type that contains a specification of loaded goods on a transport unit (e.g. container, rail wagon). A loading specification (LoadedSpecification) can contain goods belonging to many suppliers and buyers and is normally referring to a Loading Instruction.

LoadingInstruction

A Loading Instruction specifies loading of transport units. A Forwarder receiving a DeliveryInstruction from a supplier can convert it into many Loading Instructions, which are sent to a Warehouse Operator. A sequence in a Loading Instruction specifies all details how to load one transport unit. A Loading Instruction can include goods from many delivery instructions and also goods belonging to many suppliers.

LoadingOrder

Specifies delivery schedule, the transport booking requirements and shipping instructions, as well as the internal work order for the shipment

LoadingSchedule

The schedule for transport vehicle loading.

LoadTender

More than one carrier has been informed about the upcoming transport requirement (the load).

LoadTenderResponse

Indicates the ability of the respondent to fulfil the load tender request.

MeasuringInstruction

An instruction to measure products. Normally a measurement includes both quantity and quality.

MeasuringTicket

A MeasuringTicketType that contains detailed information about measured products and items. This information can be used as a base for calculation of billable products.

OfficeSchedule

The schedule for office personnel.

OriginalContract

A contract between the first seller and the first buyer in a supply chain. For example a contract when a forest owner sells roundwood to a forest company.

PackingSpecification

A Packing Specification is a business transaction specifying the complete consignment being shipped from a consignor to a consignee. The specification describes in detail what is being shipped and how it is packed and marked.

PreBooking

A requirement for a transport vehicle or unit reservation that has risen from a rough transport plan.

PreBookingConfirmation

A communication of the requirement for a transport vehicle or unit reservation that has risen from a rough transport plan.

PrePayment

A prepayment Invoice is used as a notification of amounts to be paid in advance. It is not a legal Invoice claiming payment for provided products or services.

PriceList

Used when sending a pricelist

ProductCrossReference

Used in the exchange of ProductIdentifier cross-references for the product codes used by two trading partners.

ProductDestiningInstruction

An instruction requesting the receiver to destine product(s) to end users.

ProductionTicket

A MeasuringTicketType that contains information about produced products and items. A ProductionTicket can also contain measuring information for produced items.

ProductProperties

Used when sending a list of ProductAttributes

ProForma

A proforma debit note.

A proforma debit note is not a legal invoice claiming payment. A proforma debit note is an e-Document serving as a preliminary invoice, containing on the whole the same information as the final invoice, but not actually claiming payment. Proforma debit notes are typically used in a cross-border shipment for customs purposes. Can travel with the product or be sent to a broker.

ProFormaCreditNote

A proforma credit note.

A proforma credit note is not a legal invoice for credits. A proforma credit note is an e-Document serving as a preliminary credit note, containing on the whole the same information as a final credit note. A proforma credit note will normally have a reference to an earlier issued proforma debit note.

PropertyTicket

A MeasuringTicketType that contains detailed information about calculated or measured properties of a SourceProduct not related to a specific delivery.

It typically consolidates property information over a time period, measuring location and other attributes defined in an InfoRequest or otherwise agreed between partners.

QR_DMM

Contains information needed by a measuring party to be able to start measurement of products for a delivery. It is condensed information from information normally found in a papiNet DeliveryMessage.

ReceptionTicket

A MeasuringTicketType that contains information about reception verification done upon arrival of a transport. For example, the load can be verified that it only contains proper products and that it doesn't contain any forbidden foreign objects. Based on the verification the load can be accepted or rejected.

ReleaseOrder

A release order is used to release a product to be made. This type of order refers to a previous order or agreement, such as a reservation order, a contract, or a blanket order. A release number version, which is an incremented number, is used in this type.

ReservationOrder

A reservation order is used to book a paper supplier's capacity for specific quantities of specific products, but it is not yet a firm commitment to buy. Consequently, all line items of a reservation order have a ProductionStatusType of NotFree. To release one or more PurchaseOrder line items of a reservation order, a buyer can use a standard order or a release

order.

ResourcePlan

A DeliveryPlanning type that contains information about all the planned resources available for a certain period. The resources can be for example vehicles or personnel.

SalesCatalogue

A MeasuringTicketType that contains information about measurements of products for sale. For example used for sending information about logs at roadside or standing trees for sale.

SampleMeasuringInstruction

An instruction to measure samples to check the original measurements or to measure specific properties in for example a laboratory.

SampleMeasuringTicket

A MeasuringTicketType that contains detailed information about measured samples taken from e.g. a delivery.

SelfBillingStatement

A SelfBillingStatement is an Invoice that is prepared by the buyer of the product (or the consumer of the service) for the provider of the product or service. The preparer will pay the Invoice.

Typically, logistics cost-charges are the services that are communicated. They are incurred during a certain period of time between the party who provides the logistics services (typically the party with a LogisticsRole of "LogisticsProvider") and the requestor of such services (typically the party with a LogisticsRole of "Consignor").

Raw materials, maintenance, repair, and operating supplies are examples of products that can be entered on a self billing statement for products. This type of Invoice is also referred to as an invoice for "evaluated receipts" because it developed from the receiving department's evaluation of their receipts and from that creating the Invoice.

The SelfBillingStatement process exists when there is a great deal of trust between the trading partners that permits this cost savings business process.

ShipmentAdvice

A DeliveryMessage type that contains a specification of goods, that are dispatched and will be delivered to a warehouse. A ShipmentAdvice can refer to a DeliveryInstruction Sequence or a CallOff, but is normally also used for notifying a receiving warehouse operator of shipments to the warehouse.

ShippingInstructionsConfirmation

Confirmation of the Shipping Instruction.

ShippingInstructionsDistribution

Shipping Instruction serves as a billable order for shipping product that was produced under a previous manufacturing order.

ShippingInstructionsPackaging

To be deprecated in a future version V3R00. Guidance will be given to trading

partners not to use this enumeration.

ShippingInstructionsRouting

Shipping instructions issued in conjunction with a PurchaseOrder for shipping the product.

SpecContent

Indicates that BookSpecification should only be used in the content file verification process.

SpecOrder

Used when the BookSpecification e-Document is intended for use with the PurchaseOrder transaction.

SpecRFQ

Used when the BookSpecification e-Document is intended for use with the Request for Quote (Estimate) transaction.

StandardOrder

A standard order is a regular one-time order. It defines quantities for one or more products to be purchased and may also define a delivery location and date. A standard order may reference a previous agreement (for example, a quotation, a contract, or a reservation order) for information.

StandardRFQ

SupplierSpec

Will be deprecated in a future version V3R00. Recommended not to be used. (Old definition: Used when the BookSpecification e-Document is intended for use by the Supplier only and is not generated by, or transmitted to the Buyer).

SupportSchedule

The support schedule for transport operations.

ThirdPartyShipmentAdvice

Notification of a shipment from a warehouse to a party other than the party that ordered the product from the supplier.

TradingContract

A contract between a seller and a buyer, when products (or services specified as products) bought by the seller are resold to a buyer in a supply chain. For example a contract when a forest company sells roundwood bought from a forest owner or another forest company to a buyer.

TransportPlan

A DeliveryPlanningType used to inform about quantities and times for the planned transports to the delivery destinations.

TrialOrder

A trial order is used whenever a seller has agreed to have a buyer sample a product. The seller needs to process this order differently from other orders, because a trial order may include a product sold at a discounted rate or even provided for free. A trial order typically is for small quantities.

UniqueProductIdentifier

papiNet V2R31

The information contains unique product identifiers.

UnloadingSchedule

The schedule for transport vehicle unloading.

Waybill

The forwarding agreement or carrying agreement that is used as a receipt for cargo and as a contract of carriage.

DocumentVersionNumber

The assigned version number of documents or other information items. For example version 2.12 of a price list on paper or the version number of a Measuring Information identified by a MeasuringNumber.

DocumentVersionNumber	
type	s40

N.B. TransactionHistoryNumber keeps track of the version of a papiNet e-Document. A separate DocumentVersionNumber may also be assigned to an e-Document.

DominantWavelength

Dominant wavelength

TestMethod [attribute]

TestMethod is optional. A single instance might exist.

The method used to determine the results of the test under consideration.

TestAgency [attribute]

TestAgency is optional. A single instance might exist.

The agency that has set the parameters for the testing

Refer to TestAgency definition for any enumerations.

SampleType [attribute]

SampleType is optional. A single instance might exist.

Communicates how sampling was done to measure the product characteristics.

Refer to SampleType definition for any enumerations.

ResultSource [attribute]

ResultSource is optional. A single instance might exist.

Used to define the data source of the specified test

Refer to ResultSource definition for any enumerations.

(sequence)

The sequence of items below is mandatory. A single instance is required.

DetailValue

DetailValue is mandatory. A single instance is required.

A numeric value expressed in the unit of measure (UOM).

DetailRangeMin

DetailRangeMin is optional. A single instance might exist.

The minimum value (lower boundary) allowed for the DetailValue that is the parent of this element.

DetailRangeMax

DetailRangeMax is optional. A single instance might exist.

The maximum value (upper boundary) allowed for the DetailValue that is the

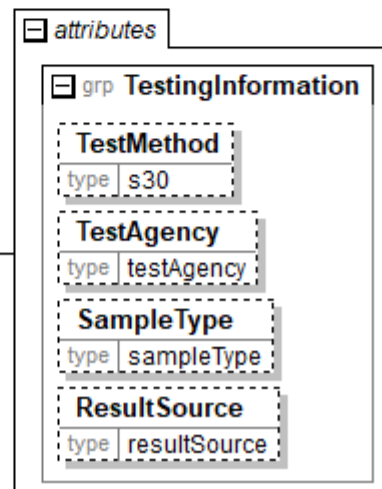
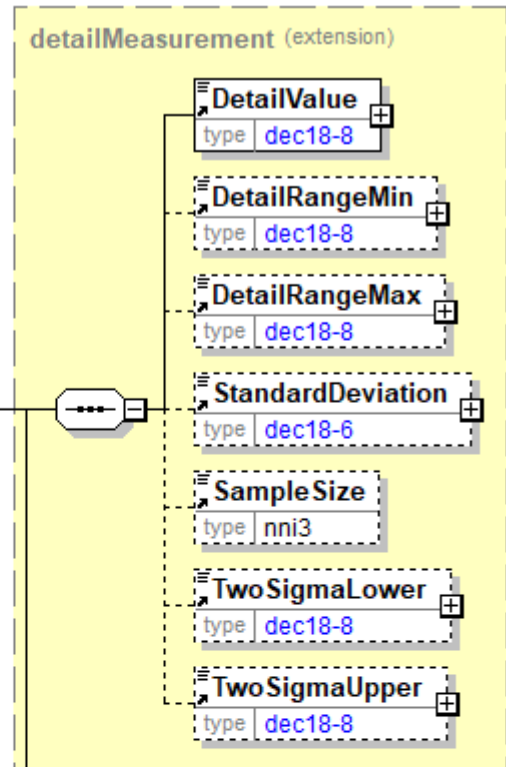
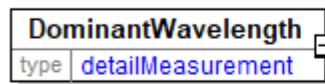

parent of this element.

StandardDeviation

StandardDeviation is optional. A single instance might exist.

A statistic used as a measure of dispersion in a distribution.

SampleSize

SampleSize is optional. A single instance might exist.

The number of samples used to determine the product characteristic in question.

TwoSigmaLower

TwoSigmaLower is optional. A single instance might exist.

Two sigma (a measure of dispersion associated with standard deviation) on the lower side of the standard deviation.

TwoSigmaUpper

TwoSigmaUpper is optional. A single instance might exist.

Two sigma (a measure of dispersion associated with standard deviation) on the upper side of the standard deviation.

DoubleBunked [attribute]

Either "Yes" or "No".

This item is restricted to the following list.

Yes

No

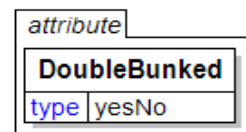

DownGradingInfo

A grouping element that contains information about downgrading of products.

(sequence)

The sequence of items below is mandatory. A single instance is required.

FromProduct

FromProduct is optional. A single instance might exist.

Defines from which product the item is downgraded.

ToProduct

ToProduct is optional. A single instance might exist.

Defines to which product the item is downgraded.

DownGradingReason

DownGradingReason is mandatory. Multiple instances might exist.

A grouping element that contains the reason for downgrading.

QuantityInformation

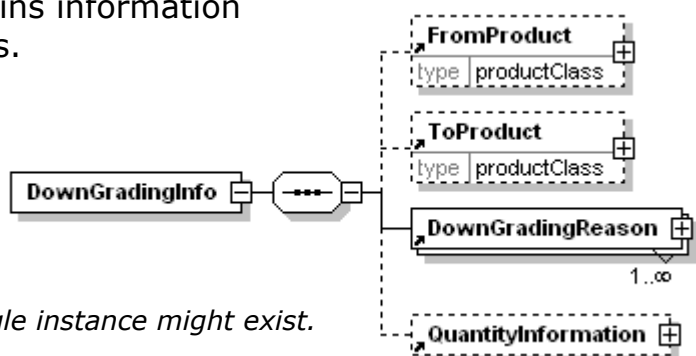

QuantityInformation is optional. A single instance might exist.

A group item containing information about quantity and informational quantity of similar items.

DownGradingReason

A grouping element that contains the reason for downgrading.

(sequence)

The sequence of items below is mandatory. A single instance is required.

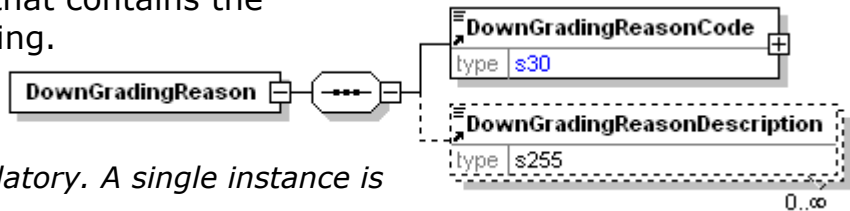

DownGradingReasonCode

DownGradingReasonCode is mandatory. A single instance is required.

A code that specifies the reason for downgrading. The Agency responsible for the code is associated with the element.

DownGradingReasonDescription

DownGradingReasonDescription is optional. Multiple instances might exist.

A free form description of the reason for downgrading.

DownGradingReasonCode

A code that specifies the reason for downgrading. The Agency responsible for the code is associated with the element.

Agency [attribute]

Agency is mandatory. A single instance is required.

Describes the agency maintaining the list of codes. To be included in this list the agency must be a recognized standards body or industry organisation.

- For the element that owns this attribute.
- For another attribute in the list of attributes associated with the parent element.

Refer to Agency definition for any enumerations.

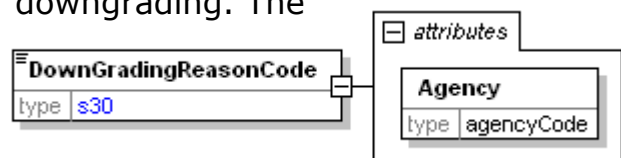

DownGradingReasonDescription

A free form description of the reason for downgrading.

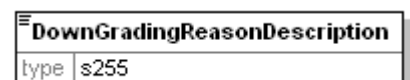

Downtime

An element used to communicate when equipment is not available for manufacturing purposes.

(sequence)

The sequence of items below is mandatory. A single instance is required.

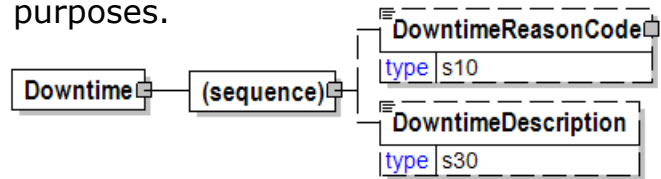

DowntimeReasonCode

DowntimeReasonCode is optional. A single instance might exist.

A reason code created by the indicated agency for downtime.

DowntimeDescription

DowntimeDescription is optional. A single instance might exist.

The description of the downtime.

DowntimeDescription

The description of the downtime.

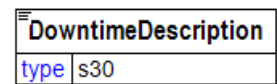

DowntimeReasonCode

A reason code created by the indicated agency for downtime.

Agency [attribute]

Agency is mandatory. A single instance is required.

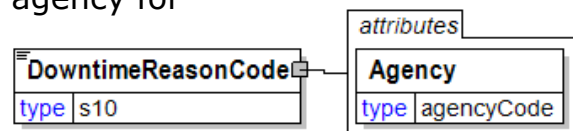

Describes the agency maintaining the list of codes. To be included in this list the agency must be a recognized standards body or industry organisation.

- For the element that owns this attribute.
- For another attribute in the list of attributes associated with the parent element.

Refer to Agency definition for any enumerations.

DrainageResistance

A group item used to communicate drainage resistance target or test value.

TestMethod [attribute]

TestMethod is optional. A single instance might exist.

The method used to determine the results of the test under consideration.

TestAgency [attribute]

TestAgency is optional. A single instance might exist.

The agency that has set the parameters for the testing

Refer to TestAgency definition for any enumerations.

SampleType [attribute]

SampleType is optional. A single instance might exist.

Communicates how sampling was done to measure the product characteristics.

Refer to SampleType definition for any enumerations.

ResultSource [attribute]

ResultSource is optional. A single instance might exist.

Used to define the data source of the specified test

Refer to ResultSource definition for any enumerations.

(sequence)

The sequence of items below is mandatory. A single instance is required.

DetailValue

DetailValue is mandatory. A single instance is required.

A numeric value expressed in the unit of measure (UOM).

DetailRangeMin

DetailRangeMin is optional. A single instance might exist.

The minimum value (lower boundary) allowed for the DetailValue that is the parent of this element.

DetailRangeMax

DetailRangeMax is optional. A single instance might exist.

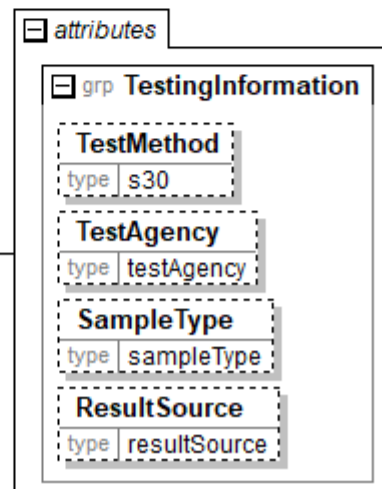
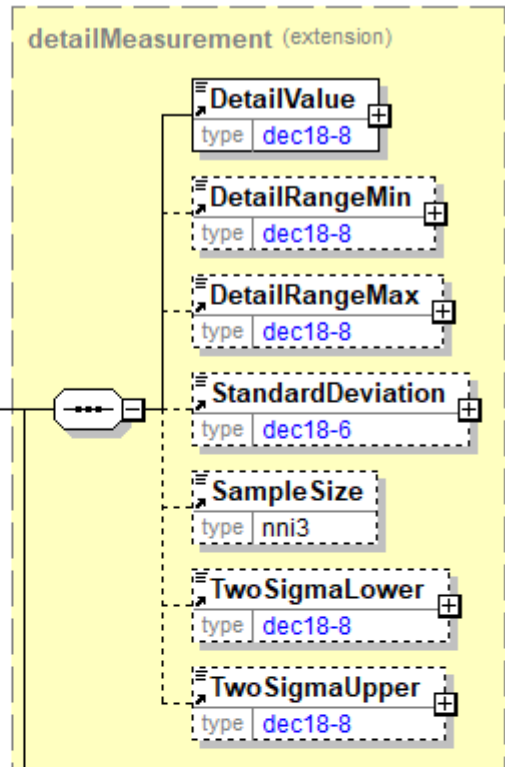

papiNet V2R31

The maximum value (upper boundary) allowed for the DetailValue that is the parent of this element.

StandardDeviation

StandardDeviation is optional. A single instance might exist.

A statistic used as a measure of dispersion in a distribution.

SampleSize

SampleSize is optional. A single instance might exist.

The number of samples used to determine the product characteristic in question.

TwoSigmaLower

TwoSigmaLower is optional. A single instance might exist.

Two sigma (a measure of dispersion associated with standard deviation) on the lower side of the standard deviation.

TwoSigmaUpper

TwoSigmaUpper is optional. A single instance might exist.

Two sigma (a measure of dispersion associated with standard deviation) on the upper side of the standard deviation.

Drilled [attribute]

Either "Yes" or "No".

This item is restricted to the following list.

Yes

No

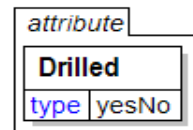

DuplicationRatio [attribute]

Duplication ratio.

Any valid string

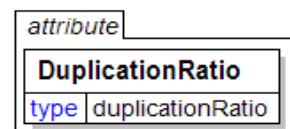

Duration

A grouping element that contains information about a time interval and its target date.

(sequence)

The sequence of items below is mandatory. A single instance is required.

DurationValue

DurationValue is mandatory. A single instance is required.

Specifies a time interval in the format of the data type "duration" defined in the XML standard. https://www.w3schools.com/xml/schema_dtypes_date.asp

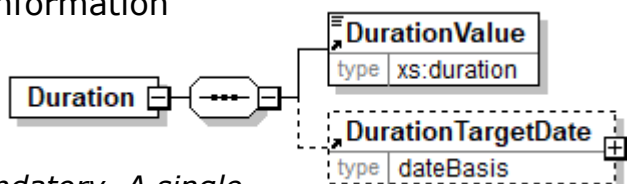

DurationTargetDate

DurationTargetDate is optional. A single instance might exist.

Specifies a target date within a time interval.

DurationTargetDate [attribute]

Specifies a target date within a time interval.

(sequence)

The sequence of items below is mandatory. A single instance is required.

Year

Year is mandatory. A single instance is required.

Identifies the year number when communicating a Calendar date.

Month

Month is mandatory. A single instance is required.

Identifies the month number when communicating a Calendar date. Month is an integer between 1 and 12 without leading zeros.

Day

Day is mandatory. A single instance is required.

Identifies the day of the month when communicating a Calendar date. Day is an integer between 1 and 31 without leading zeros.

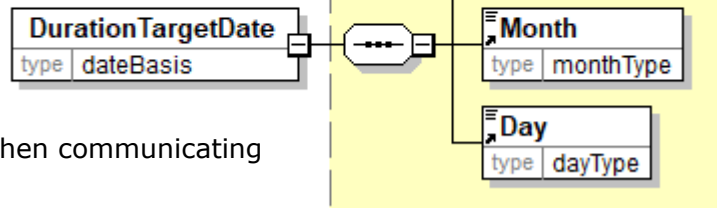

DurationType [attribute]

Type of duration of the planning period.

This item is restricted to the following list.

Calendar

Duration in calendar time.

Workday

Duration in working time

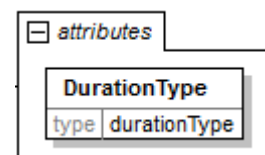

DurationValue

Specifies a time interval in the format of the data type "duration" defined in the XML standard.

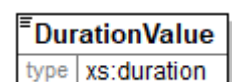

https://www.w3schools.com/xml/schema_dtypes_date.asp

DVD

DVD

DVDFormatType [attribute]

DVDFormatType is optional. A single instance might exist.

DVD format type

Refer to DVDFormatType definition for any enumerations.

DiscPrinting [attribute]

DiscPrinting is optional. A single instance might exist.

Disc printing

Refer to DiscPrinting definition for any enumerations.

(sequence)

The sequence of items below is mandatory. A single instance is required.

SequenceNumber

SequenceNumber is optional. A single instance might exist.

A sequential number that uniquely identifies a sequence.

NumberOfColours

NumberOfColours is optional. A single instance might exist.

The number of colours

ColourSpecs

ColourSpecs is optional. A single instance might exist.

Colour specs

MediaLength

MediaLength is optional. A single instance might exist.

Media length

PressPrep

PressPrep is optional. Multiple instances might exist.

Press preparation information

CDPackaging

CDPackaging is mandatory. One instance is required, multiple instances might exist.

CD Packaging

AdditionalText

AdditionalText is optional. Multiple instances might exist.

A text field that is used to communicate information not previously defined or for special instructions. To be used only for circumstances not covered by specific elements.

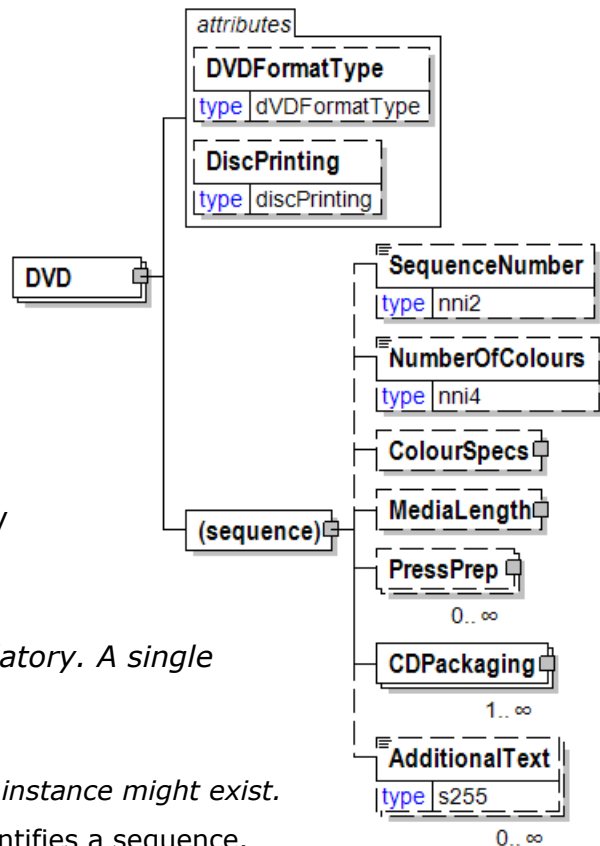

DVDFormatType [attribute]

DVD format type

This item is restricted to the following list.

- 1
- 2
- 3
- 4
- 5
- 6
- 7
- 8

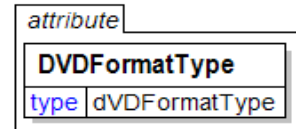

eAttachment

eAttachment enables the sender to provide information about attachments to the document.

Note: An element "e-Attachment" also exists. papiNet will no longer use hyphens in our element and attribute names as this causes issues with BizTalk.

(sequence)

The sequence of items below is mandatory. A single instance is required.

AttachmentFileName

AttachmentFileName is optional. Multiple instances might exist.

The name of the attached file.

NumberOfAttachments

NumberOfAttachments is optional. A single instance might exist.

NumberOfAttachments indicates the number of attachments enclosed in the e-Document

URL

URL is optional. Multiple instances might exist.

Universal Resource Locator. While typically a web address you could use this field to hold an email address.

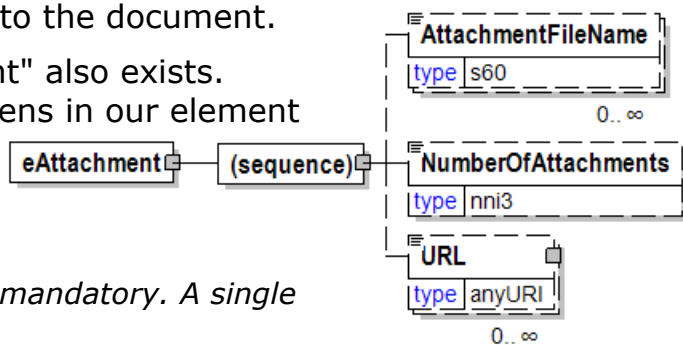

e-Attachment

e-Attachment enables the sender to provide information about attachments to the document.

Note: BizTalk users may have problems in processing this element. See the papiNet FAQs (papiNet.org) for more information.

(sequence)

The sequence of items below is mandatory. A single instance is required.

AttachmentFileName

AttachmentFileName is optional. Multiple instances might exist.

The name of the attached file.

NumberOfAttachments

NumberOfAttachments is optional. A single instance might exist.

NumberOfAttachments indicates the number of attachments enclosed in the e-Document

URL

URL is optional. Multiple instances might exist.

Universal Resource Locator. While typically a web address you could use this field to hold an email address.

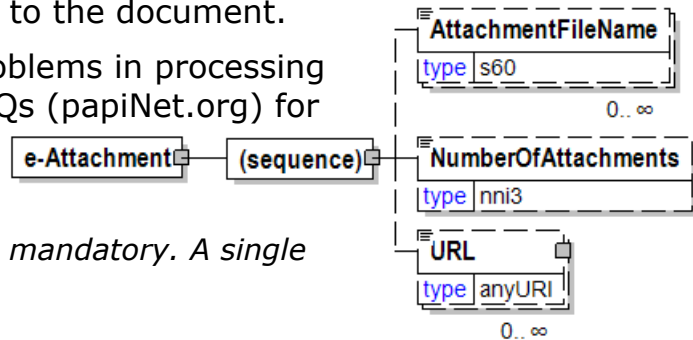

Edge

Describes the finishing of the edge of the board.

EdgeType [attribute]

EdgeType is optional. A single instance might exist.

Edge type (plywood)

Refer to EdgeType definition for any enumerations.

EdgeLocation [attribute]

EdgeLocation is optional. A single instance might exist.

Location of edge of a sheet or board, (e.g. top/bottom/left/right).

Refer to EdgeLocation definition for any enumerations.

(sequence)

The sequence of items below is mandatory. A single instance is required.

EdgeMachiningProfile

EdgeMachiningProfile is optional. A single instance might exist.

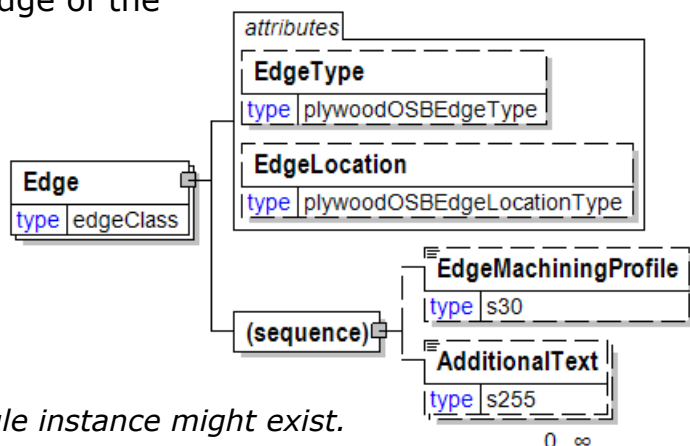

papiNet V2R31

The edge machining profile.

AdditionalText

AdditionalText is optional. Multiple instances might exist.

A text field that is used to communicate information not previously defined or for special instructions. To be used only for circumstances not covered by specific elements.

Edge

Describes the finishing of the edge of the board.

EdgeType [attribute]

EdgeType is optional. A single instance might exist.

Edge type (plywood)

Refer to EdgeType definition for any enumerations.

EdgeLocation [attribute]

EdgeLocation is optional. A single instance might exist.

Location of edge of a sheet or board, (e.g. top/bottom/left/right).

Refer to EdgeLocation definition for any enumerations.

(sequence)

The sequence of items below is mandatory. A single instance is required.

EdgeMachiningProfile

EdgeMachiningProfile is optional. A single instance might exist.

The edge machining profile.

AdditionalText

AdditionalText is optional. Multiple instances might exist.

A text field that is used to communicate information not previously defined or for special instructions. To be used only for circumstances not covered by specific elements.

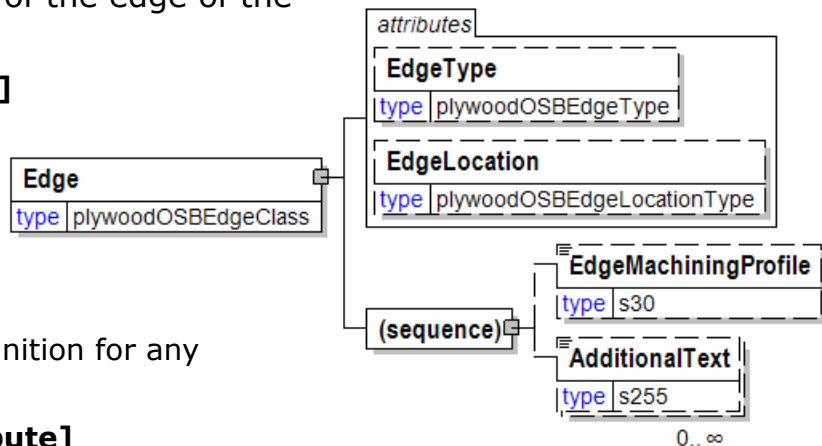

EdgeFinish

The finish applied to the edge.

This item is restricted to the following list.

Trimmed

Rough

Deco

Stained



Guided

EdgeLocation [attribute]

Location of edge of a sheet or board, (e.g. top/bottom/left/right).

This item is restricted to the following list.

North

Top

South

Bottom

East

Right

West

Left

attribute
EdgeLocation
type plywoodOSBEdgeLocationType

EdgeLocationType [attribute]

Edge location type.

This item is restricted to the following list.

Foot

Lowest part of the book.

Head

Top part of the book.

Margin

The blank space bordering the written part of a book.

Spine

Hinged back of the book.

Thumb

Front edge of the book.

attribute
EdgeLocationType
type edgeLocationType

EdgeMachiningProfile

The edge machining profile.

EdgeMachiningProfile
type s30

papiNet V2R31

EdgePaddable [attribute]

Refers to the process of applying edge padding glue or adhesive (Yes) or not (No). A liquid adhesive mixture which when brushed or sprayed onto the side of a pile of paper binds the sheets together along one edge, thus forming a pad.

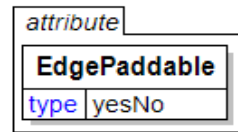

This item is restricted to the following list.

Yes

No

EdgeType [attribute]

Edge type (paper)

This item is restricted to the following list.

Bottom

Foot

Head

Left

Margin

Right

Spine

Thumb

Top

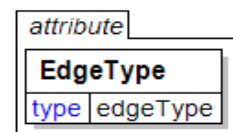

EdgeType [attribute]

Edge type (plywood)

This item is restricted to the following list.

ShipLap

SquareEdge

TongueAndGroove-FullFace

TongueAndGroove-ScantFace

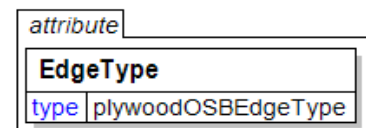

ElapsedPercentageOfPlanningPeriod

The percentage of time that has elapsed within planning period.

DurationType
[attribute]

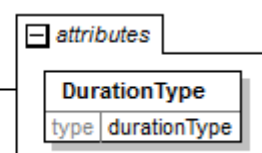
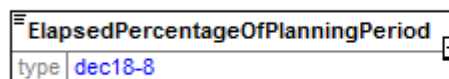

DurationType is mandatory. A single instance is required.

Type of duration of the planning period.

Refer to DurationType definition for any enumerations.

ElapsedTimeOfPlanningPeriod

Time that has elapsed within planning period.

DurationType [attribute]

DurationType is mandatory. A single instance is required.

Type of duration of the planning period.

Refer to DurationType definition for any enumerations.

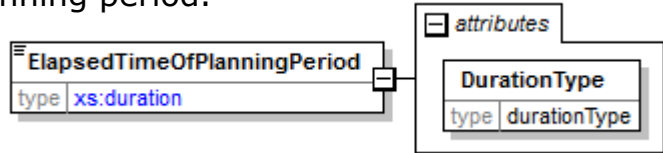

Email

The primary business email address of the individual associated with the ContactName.

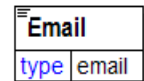

Embossing

Embossing requirements for sheets and reels. Embossing involves a physical deformation of the paper surface as part of the conversion process. Embossing is applied either in-line (directly after the paper machine) or off-line. Refer to the attribute FinishType for additional information.

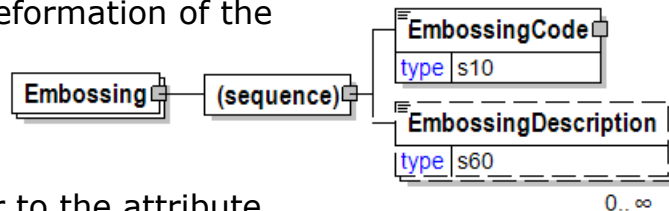

(sequence)

The sequence of items below is mandatory. A single instance is required.

EmbossingCode

EmbossingCode is mandatory. A single instance is required.

A code to identify the type of Embossing.

EmbossingDescription

EmbossingDescription is optional. Multiple instances might exist.

A description of the embossing.

EmbossingCode

A code to identify the type of Embossing.

Agency [attribute]

Agency is mandatory. A single instance is required.

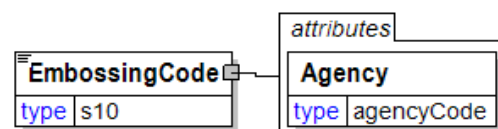

papiNet V2R31

Describes the agency maintaining the list of codes. To be included in this list the agency must be a recognized standards body or industry organisation.

- For the element that owns this attribute.
- For another attribute in the list of attributes associated with the parent element.

Refer to Agency definition for any enumerations.

EmbossingDescription

A description of the embossing.

EmbossingDescription
type s60

EndCaps

A cover to protect the ends of the reel, usually circle shaped and made from Kraft paper or plywood.

EndCaps
type s20

EndIdentifierRange

A group element that identifies the ending item identifier in the range of items that contributed to the aggregated measurements for the range.

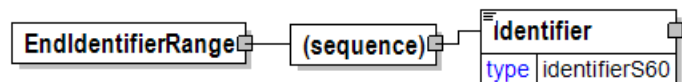

(sequence)

The sequence of items below is mandatory. A single instance is required.

Identifier

Identifier is mandatory. A single instance is required.

An Identifier is required for packages and items (pallets, reel packages, boxes, ream items, reel items, etc). The Identifier element contains the actual item identifier code. Identifier is repeatable so more than one identifier can be communicated. For example, the printed identifier on a label may be different from the barcode printed on the label.

EndsDiscountInformation

Rule for calculating the ends discount, expressed by a code.

EndsDiscountRule [attribute]

EndsDiscountRule is optional. A single instance might exist.

The rule applied for price reduction for product ends

Refer to EndsDiscountRule definition for any enumerations.

(sequence)

The sequence of items below is mandatory. A single instance is required.

EndsLengthMax

EndsLengthMax is optional. A single instance might exist.

Maximum length to be considered as ends.

EndsPermittedPercent

EndsPermittedPercent is optional. A single instance might exist.

The amount of the goods in percentage to be considered as ends.

EndsDiscountPercent

EndsDiscountPercent is optional. A single instance might exist.

The discount percentage agreed between the seller and the buyer.

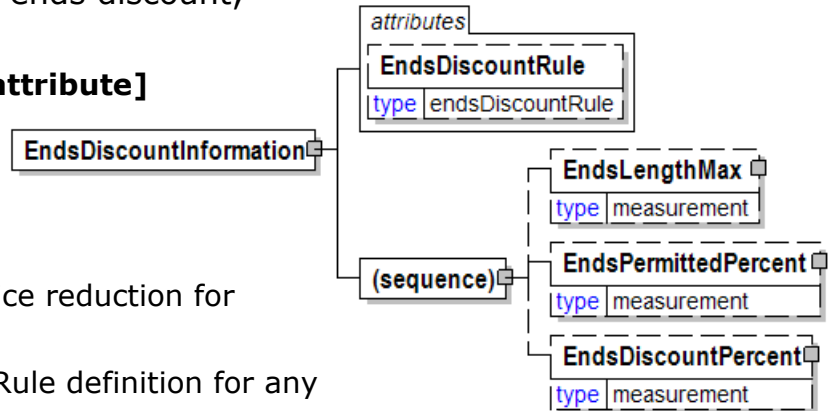

EndsDiscountPercent

The discount percentage agreed between the seller and the buyer.

(sequence)

The sequence of items below is mandatory. A single instance is required.

Value

Value is mandatory. A single instance is required.

A numeric value expressed in the unit of measure (UOM).

RangeMin

RangeMin is optional. A single instance might exist.

The minimum value (lower boundary) allowed for the Measurement that is the parent of this element.

RangeMax

RangeMax is optional. A single instance might exist.

The maximum value (upper boundary) allowed for the Measurement that is the

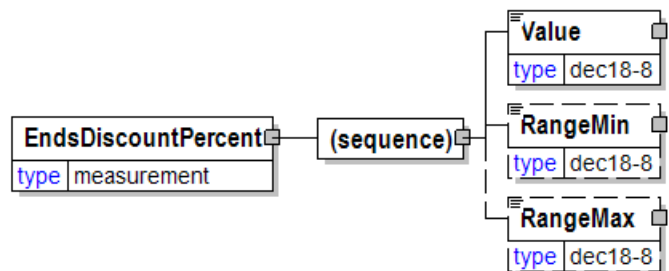

parent of this element. Some elements use the RangeMax element with an extended list of unit of measures. (Note: the red colour in the picture is an artifact of how the graphic was captured and should be disregarded.)

EndsDiscountRule [attribute]

The rule applied for price reduction for product ends
This item is restricted to the following list.

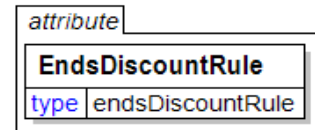

NoDiscount

No Discount

TotalVolume

Discount based on total volume of product

TotalVolumeOverPermittedPercent

Discount based on total volume of product in excess of a permitted percent

EndsheetCopyDescription

End sheet copy description

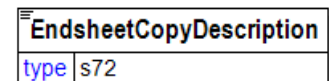

EndsheetInformation

End sheet information.

EndsheetType [attribute]

EndsheetType is optional. A single instance might exist.

End sheet type

Refer to
 EndsheetsType
 definition for any enumerations.

EndsheetLocationType [attribute]

EndsheetLocationType is optional. A single instance might exist.

End sheet location type

Refer to EndsheetsLocationType definition for any enumerations.

(sequence)

The sequence of items below is mandatory. A single instance is required.

EndsheetCopyDescription

EndsheetCopyDescription is optional. A single instance might exist.

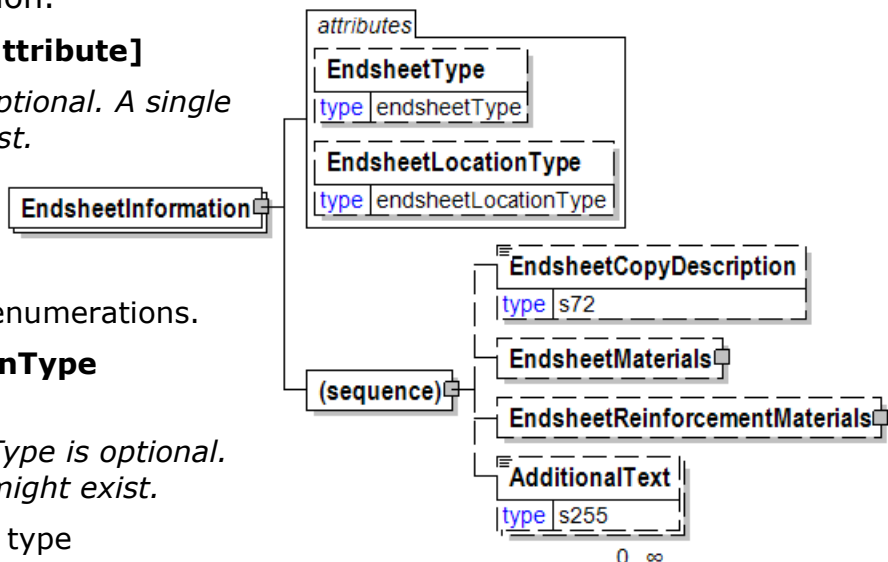

End sheet copy description

EndsheetMaterials

EndsheetMaterials is optional. A single instance might exist.

End sheet materials.

EndsheetReinforcementMaterials

EndsheetReinforcementMaterials is optional. A single instance might exist.

End sheet reinforcement materials

AdditionalText

AdditionalText is optional. Multiple instances might exist.

A text field that is used to communicate information not previously defined or for special instructions. To be used only for circumstances not covered by specific elements.

EndsheetLocationType [attribute]

End sheet location type

This item is restricted to the following list.

Front

End sheet is located only in the front of the ream

Back

End sheet is located only in the back of the ream

FrontAndBack

End sheet is located at both the front and the back of the ream

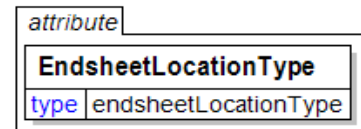

EndsheetMaterials

End sheet materials.

(sequence)

The sequence of items below is mandatory. A single instance is required.

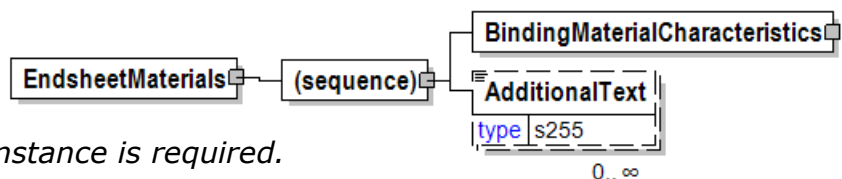

BindingMaterialCharacteristics

BindingMaterialCharacteristics is mandatory. A single instance is required.

Binding Material Characteristics

AdditionalText

AdditionalText is optional. Multiple instances might exist.

A text field that is used to communicate information not previously defined or for special instructions. To be used only for circumstances not covered by specific elements.

EndsheetReinforcementMaterials

End sheet reinforcement materials

EndsheetReinforcementType

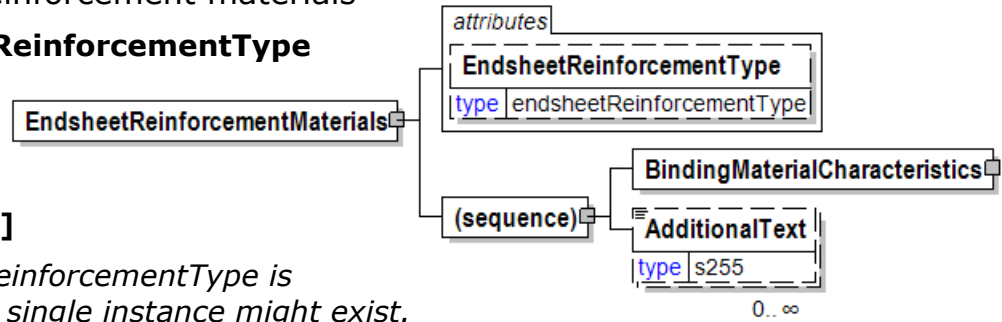

[attribute]

EndsheetReinforcementType is optional. A single instance might exist.

End sheet reinforcement type

Refer to EndsheetReinforcementType definition for any enumerations.

(sequence)

The sequence of items below is mandatory. A single instance is required.

BindingMaterialCharacteristics

BindingMaterialCharacteristics is mandatory. A single instance is required.

Binding Material Characteristics

AdditionalText

AdditionalText is optional. Multiple instances might exist.

A text field that is used to communicate information not previously defined or for special instructions. To be used only for circumstances not covered by specific elements.

EndsheetReinforcementType [attribute]

End sheet reinforcement type

This item is restricted to the following list.

Concealed

End sheet reinforcement is hidden

Exposed

End sheet reinforcement is visible



EndsheetType [attribute]

End sheet type

This item is restricted to the following list.

Blank

Printed

SelfEnding

UniformStateLabel

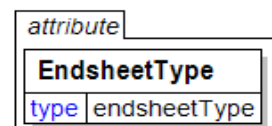

EndsLengthMax

Maximum length to be considered as ends.

(sequence)

The sequence of items below is mandatory. A single instance is required.

Value

Value is mandatory. A single instance is required.

A numeric value expressed in the unit of measure (UOM).

RangeMin

RangeMin is optional. A single instance might exist.

The minimum value (lower boundary) allowed for the Measurement that is the parent of this element.

RangeMax

RangeMax is optional. A single instance might exist.

The maximum value (upper boundary) allowed for the Measurement that is the parent of this element. Some elements use the RangeMax element with an extended list of unit of measures. (Note: the red colour in the picture is an artifact of how the graphic was captured and should be disregarded.)

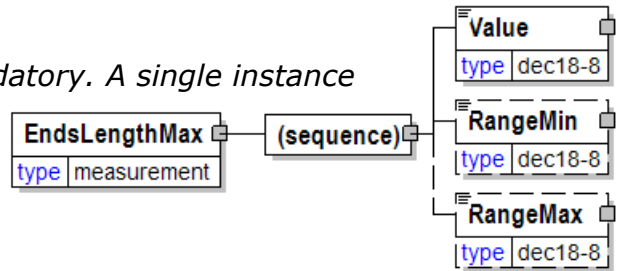

EndsPermittedPercent

The amount of the goods in percentage to be considered as ends.

(sequence)

The sequence of items below is mandatory. A single instance is required.

Value

Value is mandatory. A single instance is required.

A numeric value expressed in the unit of measure (UOM).

RangeMin

RangeMin is optional. A single instance might exist.

The minimum value (lower boundary) allowed for the Measurement that is the parent of this element.

RangeMax

RangeMax is optional. A single instance might exist.

The maximum value (upper boundary) allowed for the Measurement that is the parent of this element. Some elements use the RangeMax element with an extended list of unit of measures. (Note: the red colour in the picture is an artifact of how the graphic was captured and should be disregarded.)

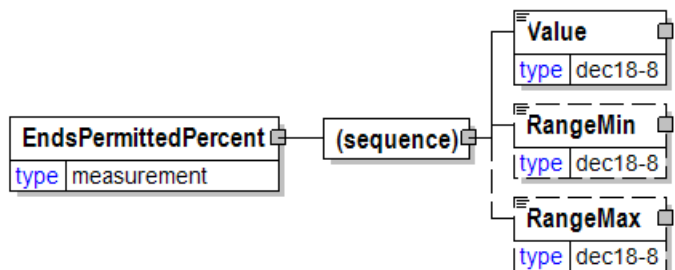

EndUserParty

The party using, consuming, or converting the product. For example, a printer using paper reels for a print job for a publisher. The final ShipTo destination for a product is normally to the end user's facilities.

LogisticsRole [attribute]

LogisticsRole is optional. A single instance might exist.

Communicates the nature of the logistics role, if any, the party plays in the transaction.

Refer to LogisticsRole definition for any enumerations.

(sequence)

The sequence of items below is mandatory. A single instance is required.

PartyIdentifier

PartyIdentifier is optional. Multiple instances might exist.

A unique identifier of a specific party. This element contains an attribute PartyIdentifierType that indicates the type of the identifier.

NameAddress

NameAddress is mandatory. A single instance is required.

A group item containing name and address of an organisation or business entity.

URL

URL is optional. A single instance might exist.

Universal Resource Locator. While typically a web address you could use this field to hold an email address.

CommonContact

CommonContact is optional. Multiple instances might exist.

Identifies a specific individual associated with the party.

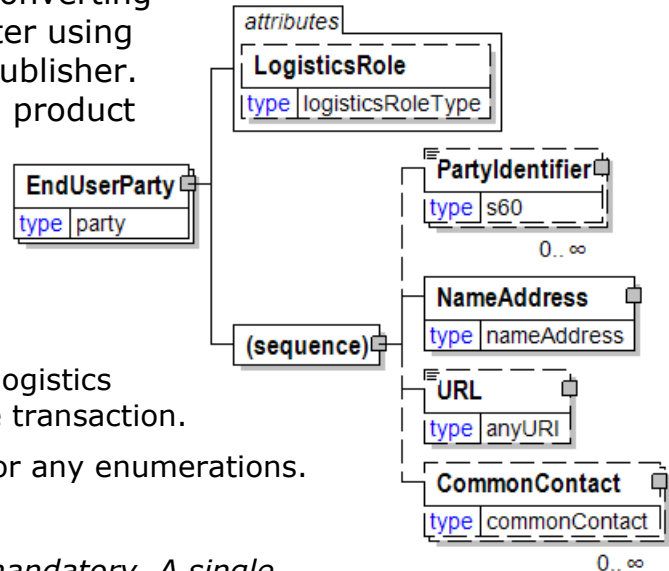

EndUses

A text element used to express in human readable form a list of applicable end uses for a product.

Examples of end uses are:

Magazine

Book

Commercial print

etc

Language [attribute]

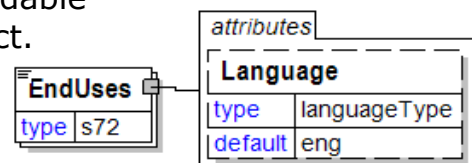

Language is optional. A single instance might exist.

The valid Alpha 2- and Alpha 3-character list of language codes in the ISO 639-1 and 639-2 international standards.

Information on the content of this attribute is available at:
https://www.loc.gov/standards/iso639-2/php/code_list.php

EquipmentPropertyValue

Specifies a value for a property of equipment. The property is defined by the attribute EquipmentPropertyType.

EquipmentPropertyType [attribute]

EquipmentPropertyType is mandatory. A single instance is required.

Defines the type of property for equipment.

Refer to EquipmentPropertyType definition for any enumerations.

AppliesTo [attribute]

AppliesTo is mandatory. A single instance is required.

Specifies the type of item to which measurements apply to.

Refer to AppliesTo definition for any enumerations.

IsAverageValue [attribute]

IsAverageValue is optional. A single instance might exist.

Indicates if the value is an average value or not.

Refer to IsAverageValue definition for any enumerations.

(sequence)

The sequence of items below is mandatory. A single instance is required.

PositionOnItem

PositionOnItem is optional. A single instance might exist.

Specifies a position on an item. The attribute PositionMeasuredFrom defines the reference point for the position

(choice)

Choice is mandatory. A single instance is required.

BinaryValue

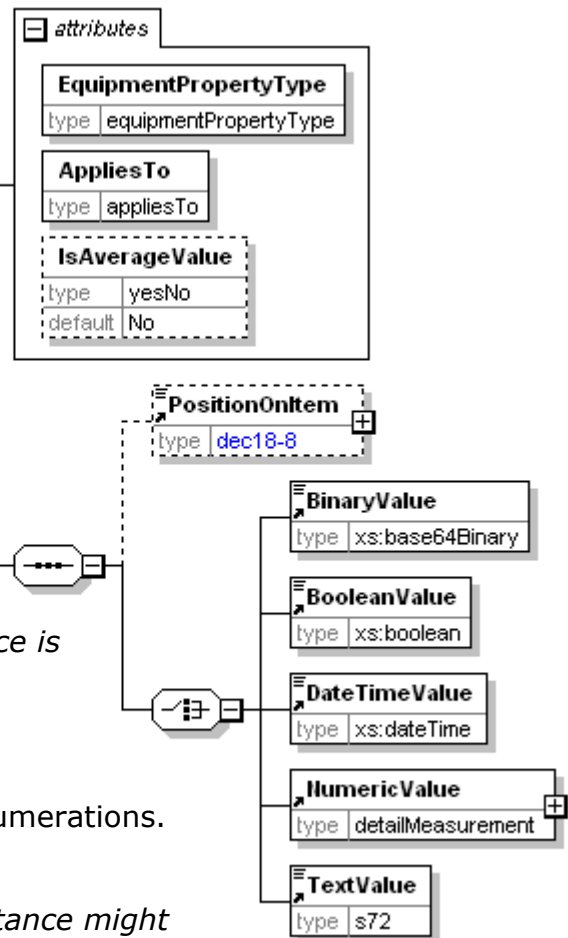

BinaryValue is mandatory. A single instance is required.

A value in base-64-encoded binary format.

BooleanValue

BooleanValue is mandatory. A single instance is required.

A value in boolean format.

DateTimeValue

DateTimeValue is mandatory. A single instance is required.

A Date and Time value in the standard W3C xs:dateTime format.

NumericValue

NumericValue is mandatory. A single instance is required.

A grouping element for a numeric value and its statistical measures.

TextValue

TextValue is mandatory. A single instance is required.

A value in text format.

EquipmentPropertyType [attribute]

Defines the type of property for equipment.

This item is restricted to the following list.

Capacity

The capacity, e.g. available volume in a tank.

Height

The height.

Length

The length.

Weight

The weight.

Width

The width.

NumberOfLoadingPositionsInHeight

Number of loading positions in height for the load carrying equipment.

NumberOfLoadingPositionsInLength

Number of loading positions in length for the load carrying equipment.

NumberOfLoadingPositionsInWidth

Number of loading positions in width for the load carrying equipment



Error

A group item that details the errors that are delaying processing on an original document.

(sequence)

The sequence of items below is mandatory. A single instance is required.

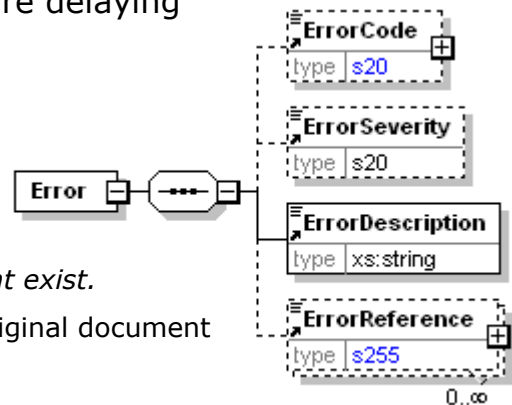

ErrorCode

ErrorCode is optional. A single instance might exist.

An optional code used to describe why an original document could not be processed

ErrorSeverity

ErrorSeverity is optional. A single instance might exist.

An optional indicator as to whether an error is business content related or whether it is technical in nature. Use of this item is governed by a Trading Partner agreement.

ErrorDescription

ErrorDescription is mandatory. A single instance is required.

A textual description of why an original document could not be processed

ErrorReference

ErrorReference is optional. Multiple instances might exist.

An item detailing relevant references (such as a PurchaseOrder Line Item) pertaining to the error. The type of reference is identified by the ErrorReferenceType attribute.

ErrorCode

An optional code used to describe why an original document could not be processed

Agency [attribute]

Agency is optional. A single instance might exist.

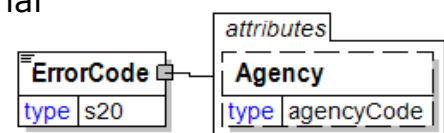

Describes the agency maintaining the list of codes. To be included in this list the agency must be a recognized standards body or industry organisation.

- For the element that owns this attribute.
- For another attribute in the list of attributes associated with the parent element.

Refer to Agency definition for any enumerations.

ErrorDescription

A textual description of why an original document could not be processed

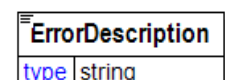

ErrorReference

An item detailing relevant references (such as a PurchaseOrder Line Item) pertaining to the error. The type of reference is identified by the ErrorReferenceType attribute.

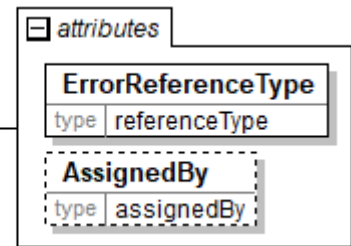
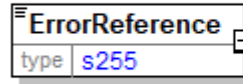

ErrorReferenceType [attribute]

ErrorReferenceType is mandatory. A single instance is required.

Provides a contextual explanation of the specific reference identifier.

Refer to ErrorReferenceType for any enumerations.

AssignedBy [attribute]

AssignedBy is optional. A single instance might exist.

Identifies the type of party or the agency that has assigned the associated item, e.g. a reference of type OrderNumber.

Refer to AssignedBy for any enumerations.

ErrorReferenceType [attribute]

Provides a contextual explanation of the specific reference identifier. Many items are currently prefixed by "Buyer", "Forwarder", "Manufacturer", "Mill", "Seller", "Supplier", "Warehouse", or "Vendor". Check for an existing non-prefixed version and use the non-prefixed version instead. In the (yet to be announced release date) version 3.0 the prefixed versions will be removed. Instead the attribute @AssignedBy will communicate the information previously communicated in the prefix.



Refer to the [referenceType](#) entry for the list of enumerations and their definitions.

ErrorSeverity

An optional indicator as to whether an error is business content related or whether it is technical in nature. Use of this item is governed by a Trading Partner agreement.

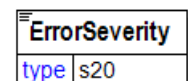

EstimatedArrivalDate

An estimation of the arrival date.

(sequence)

The sequence of items below is mandatory. A single instance is required.

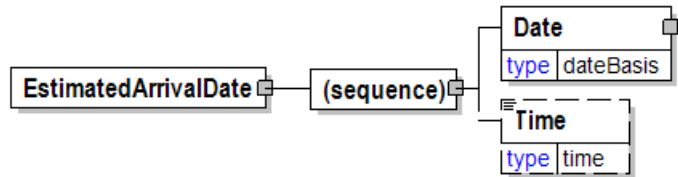

Date

Date is mandatory. A single instance is required.

A group element that contains the specification of Year, Month, and Day.

Time

Time is optional. A single instance might exist.

Times are treated in a standard XML fashion with a special case used to indicate a generalized "local" time. The standard XML approach to time is hh:mm:ss, hh:mm:ssZ, or hh:mm:ss±hh:mm.

hh:mm:ss±hh:mm is used to represent a time with a time zone. The time zone is communicated as the number of hours offset from the Universal Time Coordinate (UTC), a.k.a. Greenwich Mean Time.

hh:mm:ssZ indicates the time at Zulu (another name for UTC).

hh:mm:ss or hh:mm indicates within papiNet the applicable local time where the associated event is taking place. Caution should be used when processing times of this nature as the papiNet approach may be in discord with other users of XML.

EvenSpacing

The EvenSpacing element is used to communicate the hole-spacing that is equivalent between the holes. The initial spacing between the paper edge and the first hole is handled using the DistanceFromEdge element.

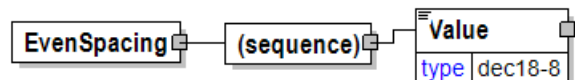

(sequence)

The sequence of items below is mandatory. A single instance is required.

Value

Value is mandatory. A single instance is required.

A numeric value expressed in the unit of measure (UOM).

EventDate

The date the incident or delay on press was recorded.

(sequence)

The sequence of items below is mandatory. A single instance is required.

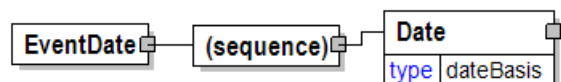

Date

Date is mandatory. A single instance is required.

papiNet V2R31

A group element that contains the specification of Year, Month, and Day.

EventType [attribute]

The type of transportation event that the DeliveryLeg represents.

This item is restricted to the following list.

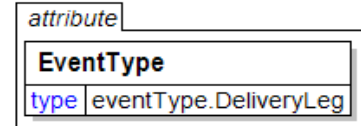

Historical

A historical transport.

Current

A current transport.

Future

A future transport.

OnHold

Delivery of the goods are temporary not possible. Delivery schedule will be given later by other party.

Return

To be deprecated in a future version V3R00. Use instead attribute TransportContextType for Return transports.

ExchangeRate

The exchange rate as of the date included in the element.

ExchangeRateType [attribute]

ExchangeRateType is mandatory. A single instance is required.

instance is required.

Defines the nature of the exchange rate

Refer to ExchangeRateType definition for any enumerations.

CurrencyFromType [attribute]

CurrencyFromType is optional. A single instance might exist.

The from currency in an exchange.

A three-character ISO 4217 currency code in capital letters. The ISO standard classification for currencies. Refer to the ISO standard for information about

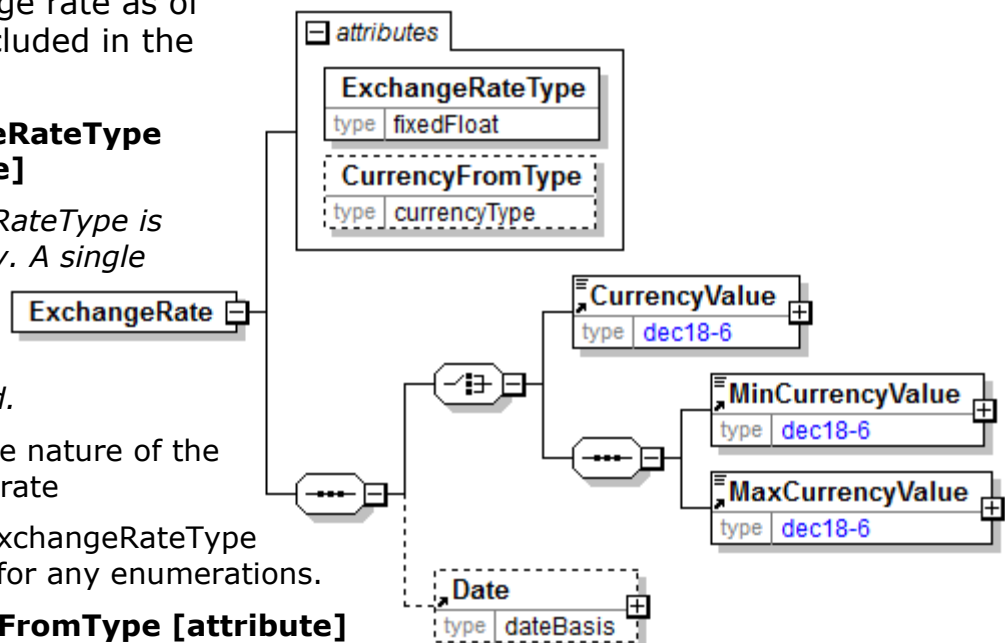

the choices for the attribute's enumerations.

<https://www.iso.org/iso-4217-currency-codes.html>

(sequence)

The sequence of items below is mandatory. A single instance is required.

(choice)

[choice] is mandatory. A single instance is required.

CurrencyValue

CurrencyValue is mandatory. A single instance is required.

The amount in the referenced currency as defined by the CurrencyType attribute.

(sequence)

The sequence of items below is mandatory. A single instance is required.

MinCurrencyValue

MinCurrencyValue is mandatory. A single instance is required.

The lower range of the allowed currency amount.

MaxCurrencyValue

MaxCurrencyValue is mandatory. A single instance is required.

The upper range of the allowed currency amount.

Date

Date is optional. A single instance might exist.

A group element that contains the specification of Year, Month, and Day.

ExchangeRateType [attribute]

Defines the nature of the exchange rate

This item is restricted to the following list.

Fixed

A fixed exchange rate

Float

an exchange rate that floats and is locked in at a particular point in time.

attribute
ExchangeRateType
type fixedFloat

ExcitationPurity

Excitation purity

TestMethod [attribute]

TestMethod is optional. A single instance might exist.

The method used to determine the results of the test under consideration.

TestAgency [attribute]

TestAgency is optional. A single instance might exist.

The agency that has set the parameters for the testing

Refer to TestAgency definition for any enumerations.

SampleType [attribute]

SampleType is optional. A single instance might exist.

Communicates how sampling was done to measure the product characteristics.

Refer to SampleType definition for any enumerations.

ResultSource [attribute]

ResultSource is optional. A single instance might exist.

Used to define the data source of the specified test

Refer to ResultSource definition for any enumerations.

(sequence)

The sequence of items below is mandatory. A single instance is required.

DetailValue

DetailValue is mandatory. A single instance is required.

A numeric value expressed in the unit of measure (UOM).

DetailRangeMin

DetailRangeMin is optional. A single instance might exist.

The minimum value (lower boundary) allowed for the DetailValue that is the parent of this element.

DetailRangeMax

DetailRangeMax is optional. A single instance might exist.

The maximum value (upper boundary) allowed for the DetailValue that is the

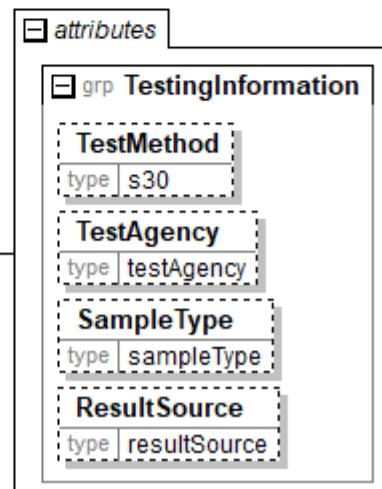
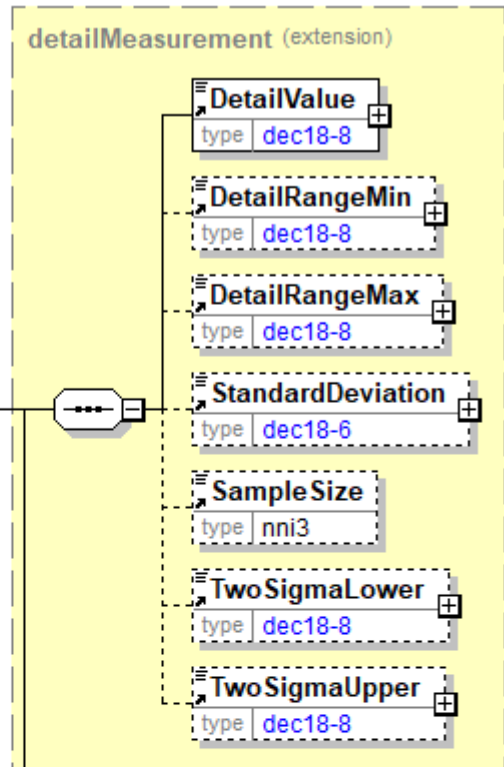

parent of this element.

StandardDeviation

StandardDeviation is optional. A single instance might exist.

A statistic used as a measure of dispersion in a distribution.

SampleSize

SampleSize is optional. A single instance might exist.

The number of samples used to determine the product characteristic in question.

TwoSigmaLower

TwoSigmaLower is optional. A single instance might exist.

Two sigma (a measure of dispersion associated with standard deviation) on the lower side of the standard deviation.

TwoSigmaUpper

TwoSigmaUpper is optional. A single instance might exist.

Two sigma (a measure of dispersion associated with standard deviation) on the upper side of the standard deviation.

ExecutionType [attribute]

Communicates the type of content of a DeliveryInstruction e-Document.

This item is restricted to the following list.

Fixed

Detailed specification of the delivery is given.

Open

Detailed specification of the delivery is not given. Quantities and delivery schedules will be specified by other means depending on the business process.

ExLog

Describes the cutting pattern of the log.

(sequence)

The sequence of items below is mandatory. A single instance is required.

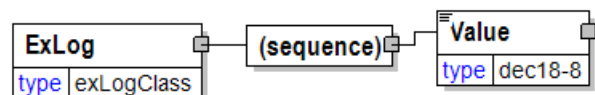

Value

Value is mandatory. A single instance is required.

A numeric value expressed in the unit of measure (UOM).

ExtraFeature

A special or extra feature that the label has or needs.

(sequence)

The sequence of items below is mandatory. A single instance is required.

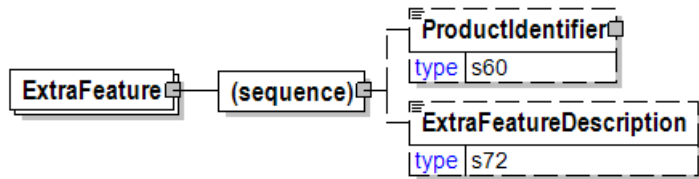

ProductIdentifier

ProductIdentifier is optional. A single instance might exist.

Used to communicate the code of the article, in a variety of formats designated by the type.

ExtraFeatureDescription

ExtraFeatureDescription is optional. A single instance might exist.

The definition of the extra feature.

ExtraFeatureDescription

The definition of the extra feature.

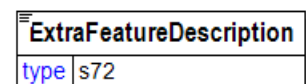

Face [attribute]

Used to describe which side (or face) of the product that the grade is applicable to.

This item is restricted to the following list.

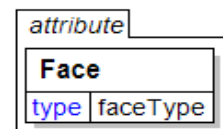

Face1

The grade is applicable to the top side of the product.

Face2

The grade is applicable to the bottom side of the product.

Both

The grade is applicable to both the top and the bottom side of the product.

Fax

The primary business fax number of the individual associated with the ContactName.

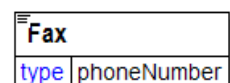

FibreClassification

A group item used to communicate fibre classification according to the specified classification scheme.

TestMethod [attribute]

TestMethod is optional. A single instance might exist.

The method used to determine the results of the test under consideration.

TestAgency [attribute]

TestAgency is optional. A single instance might exist.

The agency that has set the parameters for the testing

Refer to TestAgency definition for any enumerations.

SampleType [attribute]

SampleType is optional. A single instance might exist.

Communicates how sampling was done to measure the product characteristics.

Refer to SampleType definition for any enumerations.

ResultSource [attribute]

ResultSource is optional. A single instance might exist.

Used to define the data source of the specified test

Refer to ResultSource definition for any enumerations.

(sequence)

The sequence of items below is mandatory. A single instance is required.

DetailValue

DetailValue is mandatory. A single instance is required.

A numeric value expressed in the unit of measure (UOM).

DetailRangeMin

DetailRangeMin is optional. A single instance might exist.

The minimum value (lower boundary) allowed for the DetailValue that is the parent of this element.

DetailRangeMax

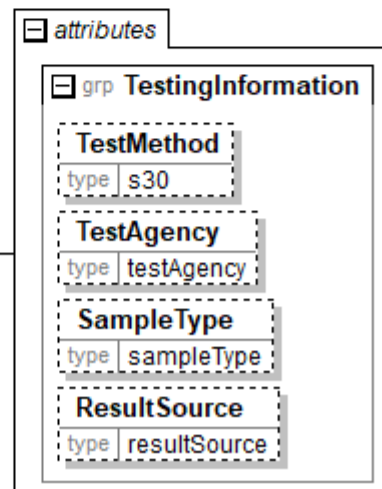
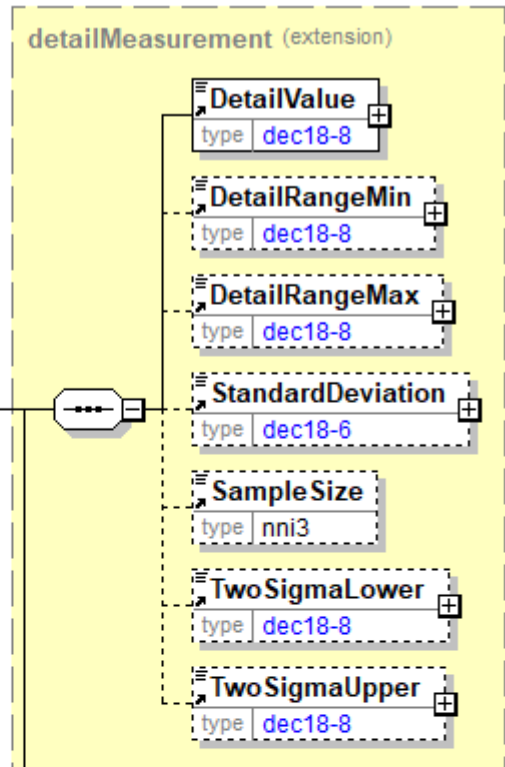

DetailRangeMax is optional. A single instance might exist.

The maximum value (upper boundary) allowed for the DetailValue that is the parent of this element.

StandardDeviation

StandardDeviation is optional. A single instance might exist.

A statistic used as a measure of dispersion in a distribution.

SampleSize

SampleSize is optional. A single instance might exist.

The number of samples used to determine the product characteristic in question.

TwoSigmaLower

TwoSigmaLower is optional. A single instance might exist.

Two sigma (a measure of dispersion associated with standard deviation) on the lower side of the standard deviation.

TwoSigmaUpper

TwoSigmaUpper is optional. A single instance might exist.

Two sigma (a measure of dispersion associated with standard deviation) on the upper side of the standard deviation.

FibreLength

A group item used to communicate fibre length target or test value according to a particular TestMethod.

TestMethod [attribute]

TestMethod is optional. A single instance might exist.

The method used to determine the results of the test under consideration.

TestAgency [attribute]

TestAgency is optional. A single instance might exist.

The agency that has set the parameters for the testing

Refer to TestAgency definition for any enumerations.

SampleType [attribute]

SampleType is optional. A single instance might exist.

Communicates how sampling was done to measure the product characteristics.

Refer to SampleType definition for any enumerations.

ResultSource [attribute]

ResultSource is optional. A single instance might exist.

Used to define the data source of the specified test

Refer to ResultSource definition for any enumerations.

(sequence)

The sequence of items below is mandatory. A single instance is required.

DetailValue

DetailValue is mandatory. A single instance is required.

A numeric value expressed in the unit of measure (UOM).

DetailRangeMin

DetailRangeMin is optional. A single instance might exist.

The minimum value (lower boundary) allowed for the DetailValue that is the parent of this element.

DetailRangeMax

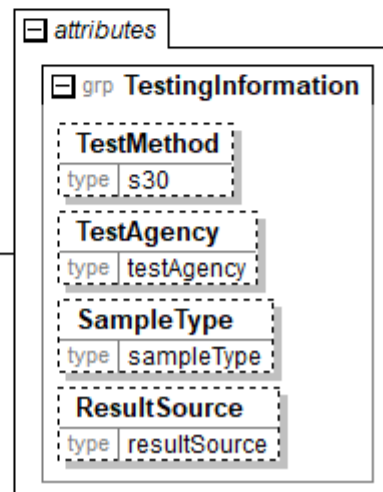
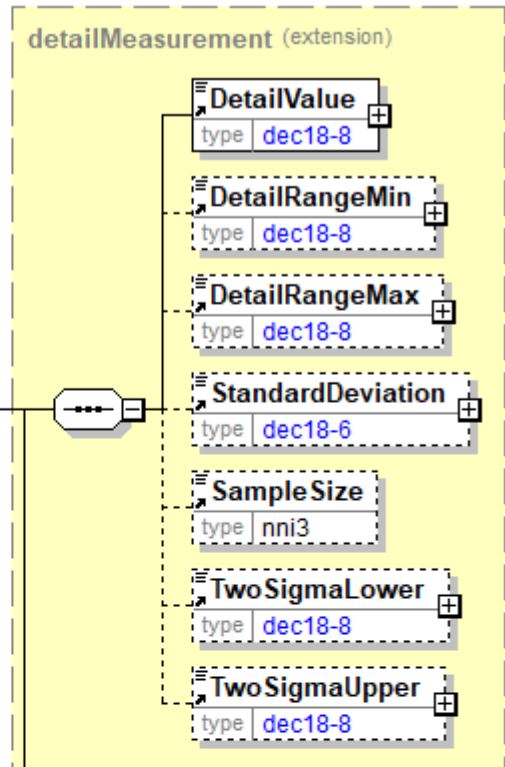
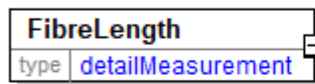

papiNet V2R31

DetailRangeMax is optional. A single instance might exist.

The maximum value (upper boundary) allowed for the DetailValue that is the parent of this element.

StandardDeviation

StandardDeviation is optional. A single instance might exist.

A statistic used as a measure of dispersion in a distribution.

SampleSize

SampleSize is optional. A single instance might exist.

The number of samples used to determine the product characteristic in question.

TwoSigmaLower

TwoSigmaLower is optional. A single instance might exist.

Two sigma (a measure of dispersion associated with standard deviation) on the lower side of the standard deviation.

TwoSigmaUpper

TwoSigmaUpper is optional. A single instance might exist.

Two sigma (a measure of dispersion associated with standard deviation) on the upper side of the standard deviation.

FibreSource [attribute]

Communicates the source of the pulp fibre

This item is restricted to the following list.

Acacia

Ash

Aspen

Bagasse

Bamboo

Basswood

Beech

Birch

Blackgum

Buckeye

Butternut

Cedar

Cherry

Cottonwood

Cypress

DouglasFir

Elm

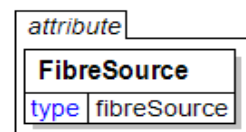

Esparto
Eucalyptus
Fir
Flax
Hemlock
Hemp
Hickory
Jute
Larch
Locust
Magnolia
Manilkara
Maple
MixedTropicalHardwood
NorthernMixedHardwood
Paulonia
Persea
Pine
Poplar
Radiata
Rag
RedOak
Redwood
Rope
SouthernMixedHardwood
SouthernSoftwood
Spruce
Sycamore
Straw
Tanoak
Walnut
WhiteOak
Other

FinishedSize

Finished size

(sequence)

The sequence of items below is mandatory. A single instance is required.

Length

Length is optional. A single instance might exist.

The length of the object.

Width

Width is optional. A single instance might exist.

The width of the object.

Height

Height is optional. A single instance might exist.

The height of the object.

FlapWidth

FlapWidth is optional.

The width of a flap.

AdditionalText

AdditionalText is optional. Multiple instances might exist.

A text field that is used to communicate information not previously defined or for special instructions. To be used only for circumstances not covered by specific elements.

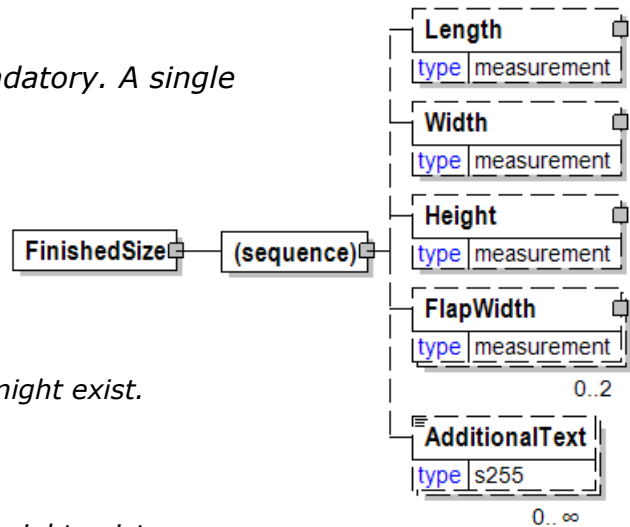

FinishPrep

Finish prep

FinishPrepOutputType [attribute]

FinishPrepOutputType is optional. A single instance might exist.

Finish Prep Output Type

Refer to FinishPrepOutputType definition for any enumerations.

(sequence)

The sequence of items below is mandatory. A single instance is required.

FinishPrepInput

FinishPrepInput is mandatory. One instance is required, multiple instances might exist.

Finish prep input

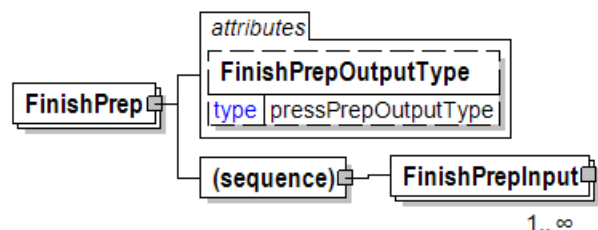

FinishPrepInput

Finish prep input

MediaType [attribute]

MediaType is optional. A single instance might exist.

The type of media

Refer to MediaType definition for any enumerations.

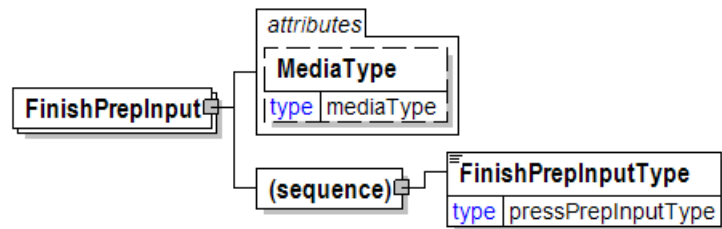

(sequence)

The sequence of items below is mandatory. A single instance is required.

FinishPrepInputType

FinishPrepInputType is mandatory. A single instance is required.

Finish Prep Input Type

Refer to FinishPrepInputType definition for any enumerations.

FinishPrepInputType

Finish Prep Input Type

This item is restricted to the following list.

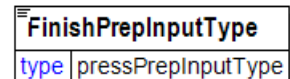

4PageImposedFilm

8PageImposedFilm

ApplicationFiles

Bookmap

CameraCopy

CopyBook

DuplicateStrip

ElectronicFiles

ElectronicGraphic

Film

FilmPageNegatives

FilmPagePositives

IllustrationFilm

NegativeImposedPlateMakingFilm

Originals

OriginalArt

Other

Overtakes

PageProof

PDF

PositiveImposedPlateMakingFilm

RachwalFilm

ReflectiveArtBoard

ReproProof

RestripSuppliedFlats

TearSheet

Transparencies

FinishPrepOutputType [attribute]

Finish Prep Output Type

This item is restricted to the following list.

DirectToFilm

DirectToPlate

DirectToPress

Film

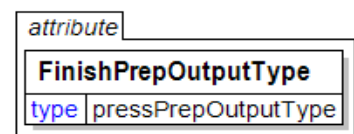

FinishSpecs

Finish specifications

(sequence)

The sequence of items below is mandatory. A single instance is required.

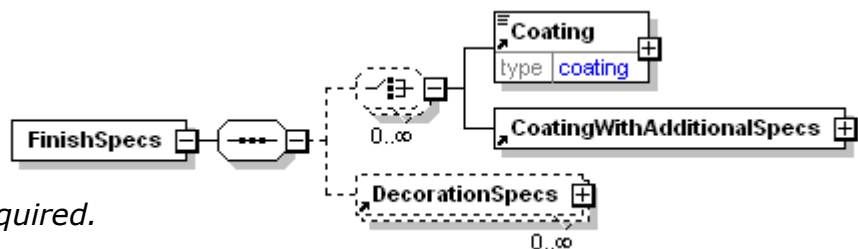

(choice)

[choice] is optional. Multiple instances might exist.

Coating

Coating is mandatory. A single instance is required.

Coating

Refer to Coating definition for any enumerations.

CoatingWithAdditionalSpecs

CoatingWithAdditionalSpecs is mandatory. A single instance is required.

A grouping element that specifies coating and additional related items.

DecorationSpecs

DecorationSpecs is optional. Multiple instances might exist.

Decoration specifications

FinishTexture

Describes the texture of the finish to be achieved such as Leatherette.

FinishTexture	
type	s72

FinishType [attribute]

Defines the finish of a sheet of paper, which means the condition of its surface (refer to Embossing for more information).

attribute	
FinishType	
type	paperFinishType

Finishes may be produced on or off machine. Finishes that are created off-machine are called embossed. (Embossing is a child element of ReelConversionCharacteristics and SheetConversionCharacteristics.)

Note:

Embossed" as a finish type is just a generalized choice for one of the more specific choices listed.

Unsupercalendered" as a finish type would be indicated by not communicating a finish type.

This item is restricted to the following list.

Bond

Grade of writing or printing paper where strength, durability, and permanence are essential requirements.

Clear

Finish process results in a clear coating.

CustomTint

Requires the manufacturer to add a color to the coating process in order to create a custom colored coating.

Dull

A paper surface finish lacking gloss and/or lustre; generally refers to an intermediate gloss of coated papers or to printed ink films.

English

A surface finish for book papers with a smoother, more uniform surface than machine finish.

Gloss

A paper surface finish that is highly reflective.

GlowInTheDark

Additive to Ultraviolet application to achieve a Glow-in-the-Dark effect

Hazy

Finish process results in a hazy coating.

HighGloss

papiNet V2R31

Sheen on dry finish that is full gloss.

Laid

A paper surface finish that has a watermark pattern resulting in parallel lines in both the machine and cross machine directions of the web of paper.

Linen

An embossed finish to simulate the pattern originally obtained by pressing paper between sheets of linen cloths.

Machine

A paper surface that has no special finish—in other words, the paper is as it comes off the machine.

Matte

A non-glossy paper surface finish found on an uncoated sheet of paper or attained by coating without super calendering; this is the least glossy paper surface available.

Metalized

Finish process uses a custom metallic coating.

PeelOff

Coating that when peeled reveals writing, numbers, scent, etc.

Satin

Paper surfaces finish lacking gloss, generally intermediate to a matte finish and a dull finish.

SCA

A super-calendered (SC) Grade A finish is the highest level of print gloss and smoothness of the super-calendered types.

SCB

A super-calendered (SC) Grade B finish with a mid level of print gloss and smoothness of the super-calendered types.

SCC

A super-calendered (SC) Grade C finish is the lowest level of print gloss and smoothness of the super-calendered types.

ScratchOff

Coating that when scratched reveals writing, numbers, scent, etc.

ScuffResistant

Wear-resistant finish to prevent scratching and marring.

Silk

A smooth, delicately embossed finished paper with sheen. Also called Satin.

Silver

Finish process uses a silver-color metallic coating.

Smooth

A paper surface finish mostly free of roughness.

SoftGloss

A paper surface finish similar to a matte but with a higher printed gloss; smoother than a matte finish.

Sparkle

Additive to Ultraviolet application to achieve a sparkle effect.

TransparentBlue

Finish process adds the color blue to the clear coating material.

Vellum

A full toothy, relatively rough finish surface for uncoated text or book papers; generally intermediate in smoothness to an antique (very rough) finish and a regular or smooth finish.

Velvet

A smooth, delicately embossed finished paper with sheen. Similar to silk.

FireTreatment

Fire treatment

FireTreatmentType [attribute]

FireTreatmentType is optional. A single instance might exist.

Fire treatment type. Define the class (surface spread of flame) of fire treatment.

Refer to FireTreatmentType definition for any enumerations.

(sequence)

The sequence of items below is mandatory. A single instance is required.

AdditionalText

AdditionalText is optional. Multiple instances might exist.

A text field that is used to communicate information not previously defined or for special instructions. To be used only for circumstances not covered by specific elements.

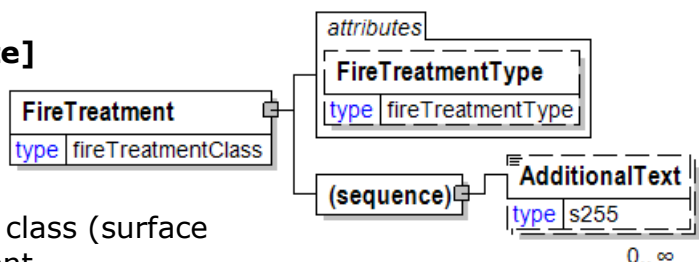

FireTreatmentType [attribute]

Fire treatment type. Define the class (surface spread of flame) of fire treatment.

This item is restricted to the following list.

FireTreated

Other

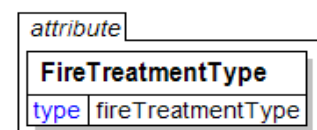

FlapLocation [attribute]

Flap location

This item is restricted to the following list.

Back

Flap is located at the back

Front

Flap is located at the front

FrontAndBack

Flap is located at the back and at the front

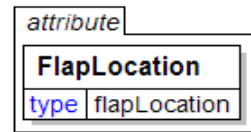

FlapWidth

The width of a flap.

FlapLocation [attribute]

FlapLocation is mandatory. A single instance is required.

Flap location

Refer to FlapLocation definition for any enumerations.

(sequence)

The sequence of items below is mandatory. A single instance is required.

Value

Value is mandatory. A single instance is required.

A numeric value expressed in the unit of measure (UOM).

RangeMin

RangeMin is optional. A single instance might exist.

The minimum value (lower boundary) allowed for the Measurement that is the parent of this element.

RangeMax

RangeMax is optional. A single instance might exist.

The maximum value (upper boundary) allowed for the Measurement that is the parent of this element. Some elements use the RangeMax element with an extended list of unit of measures. (Note: the red colour in the picture is an artifact of how the graphic was captured and should be disregarded.)

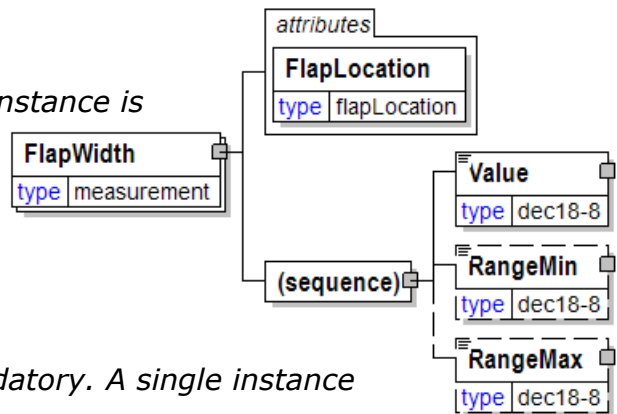

FlatAmountAdjustment

A group item that contains flat adjustment amount information.

(sequence)

The sequence of items below is mandatory. A single instance is required.

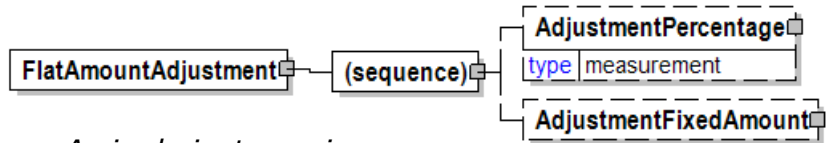

AdjustmentPercentage

AdjustmentPercentage is optional. A single instance might exist.

A percentage, either negative or positive, that is applied to either the price, or a starting amount to determine the value of the particular MonetaryAdjustment.

AdjustmentFixedAmount

AdjustmentFixedAmount is optional. A single instance might exist.

A fixed monetary amount, either negative or positive, that is the value of the adjustment being applied in an instance of the MonetaryAdjustment structure.

FlatSize

Flat size

(sequence)

The sequence of items below is mandatory. A single instance is required.

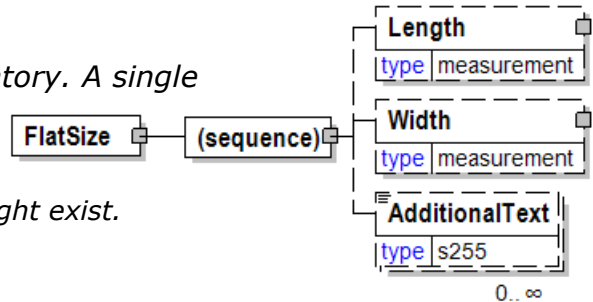

Length

Length is optional. A single instance might exist.

The length of the object.

Width

Width is optional. A single instance might exist.

The width of the object.

AdditionalText

AdditionalText is optional. Multiple instances might exist.

A text field that is used to communicate information not previously defined or for special instructions. To be used only for circumstances not covered by specific elements.

Floor

Defines parts and complete flooring systems.

(choice)

[choice] is mandatory. A single instance is required.

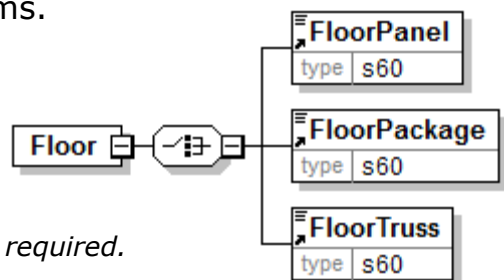

FloorPanel

FloorPanel is mandatory. A single instance is required.

papiNet V2R31

Describes the flooring surface.

FloorPackage

FloorPackage is mandatory. A single instance is required.

Describes the combination of flooring surface and supporting structures.

FloorTruss

FloorTruss is mandatory. A single instance is required.

Describes the supporting material under flooring surface.

FloorLocationType [attribute]

Floor Location Type

This item is restricted to the following list.

Above

The floor is located above the product

Below

The floor is located below the product

attribute
FloorLocationType
type aboveBelow

FloorPackage

Describes the combination of flooring surface and supporting structures.

FloorPackage
type s60

FloorPanel

Describes the flooring surface.

FloorPanel
type s60

FloorTruss

Describes the supporting material under flooring surface.

FloorTruss
type s60

Folded [attribute]

Either "Yes" or "No".

This item is restricted to the following list.

Yes

No

attribute
Folded
type yesNo

Folding

A group item used to communicate folding endurance target or test value according to a particular TestMethod.

TestMethod [attribute]

TestMethod is optional. A single instance might exist.

The method used to determine the results of the test under consideration.

TestAgency [attribute]

TestAgency is optional. A single instance might exist.

The agency that has set the parameters for the testing

Refer to TestAgency definition for any enumerations.

SampleType [attribute]

SampleType is optional. A single instance might exist.

Communicates how sampling was done to measure the product characteristics.

Refer to SampleType definition for any enumerations.

ResultSource [attribute]

ResultSource is optional. A single instance might exist.

Used to define the data source of the specified test

Refer to ResultSource definition for any enumerations.

(sequence)

The sequence of items below is mandatory. A single instance is required.

DetailValue

DetailValue is mandatory. A single instance is required.

A numeric value expressed in the unit of measure (UOM).

DetailRangeMin

DetailRangeMin is optional. A single instance might exist.

The minimum value (lower boundary) allowed for the DetailValue that is the parent of this element.

DetailRangeMax

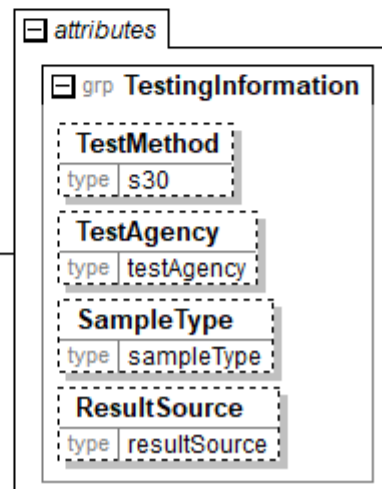
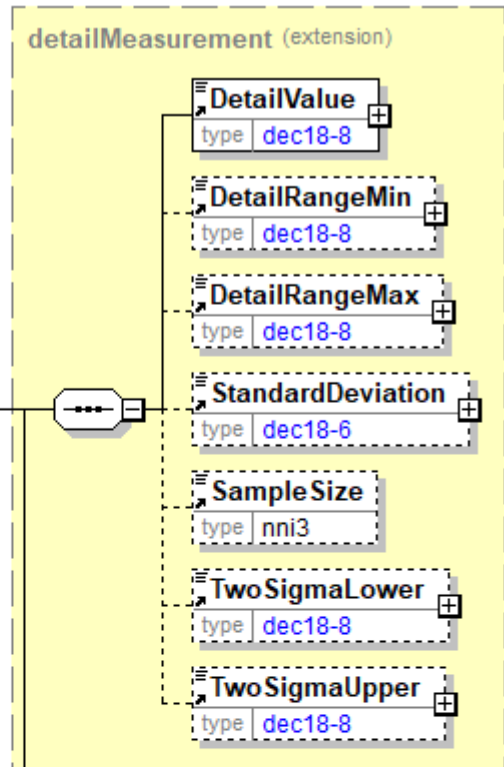

papiNet V2R31

DetailRangeMax is optional. A single instance might exist.

The maximum value (upper boundary) allowed for the DetailValue that is the parent of this element.

StandardDeviation

StandardDeviation is optional. A single instance might exist.

A statistic used as a measure of dispersion in a distribution.

SampleSize

SampleSize is optional. A single instance might exist.

The number of samples used to determine the product characteristic in question.

TwoSigmaLower

TwoSigmaLower is optional. A single instance might exist.

Two sigma (a measure of dispersion associated with standard deviation) on the lower side of the standard deviation.

TwoSigmaUpper

TwoSigmaUpper is optional. A single instance might exist.

Two sigma (a measure of dispersion associated with standard deviation) on the upper side of the standard deviation.

FolioNumber

The page number in a book that may not be the same as the sequential location of the page.

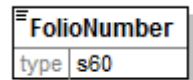

FolioPosition [attribute]

Indicator that the Folio is the first or last page in the associated prep content file.

This item is restricted to the following list.

First

First page

Last

Last page



Foot

Foot

Bleed [attribute]

Bleed is optional. A single instance might exist.

Specifies if the printing of an illustration, design, or text to the edge of the page.

Refer to Bleed definition for any enumerations.

(sequence)

The sequence of items below is mandatory. A single instance is required.

Value

Value is mandatory. A single instance is required.

A numeric value expressed in the unit of measure (UOM).

RangeMin

RangeMin is optional. A single instance might exist.

The minimum value (lower boundary) allowed for the Measurement that is the parent of this element.

RangeMax

RangeMax is optional. A single instance might exist.

The maximum value (upper boundary) allowed for the Measurement that is the parent of this element. Some elements use the RangeMax element with an extended list of unit of measures. (Note: the red colour in the picture is an artifact of how the graphic was captured and should be disregarded.)

AdditionalText

AdditionalText is optional. A single instance might exist.

A text field that is used to communicate information not previously defined or for special instructions. To be used only for circumstances not covered by specific elements.

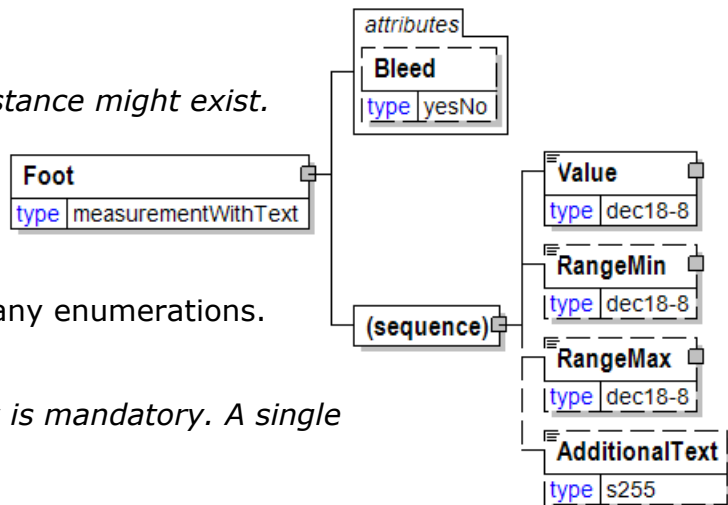

ForestWood

A grouping element with information about characteristics for Forest Wood products.

ForestWoodType [attribute]

ForestWoodType is mandatory. A single instance is required.

Defines the type of product for Forest Wood.
Refer to ForestWoodType definition for any enumerations.

ForestWoodItemType [attribute]

ForestWoodItemType is optional. A single instance might exist.

Defines detail type of items for Forest Wood product types.

Refer to ForestWoodItemType definition for any enumerations.

IsForestWoodReject [attribute]

IsForestWoodReject is optional. A single instance might exist.

Defines the type of product for Forest Wood.

Refer to IsForestWoodReject definition for any enumerations.

(sequence)

The sequence of items below is mandatory. A single instance is required.

TreeSpeciesGroup

TreeSpeciesGroup is optional. Multiple instances might exist.

A grouping element that details information used for describing tree species.

ForestWoodClass

ForestWoodClass is optional. Five instances might exist.

A grouping element that details information used for describing classes of Forest Wood based on some product properties.

ForestWoodCharacteristics

ForestWoodCharacteristics is optional. A single instance might exist.

A grouping element that contains characteristics of the Forest Wood product.

ForestWoodPackagingCharacteristics

ForestWoodPackagingCharacteristics is optional. A single instance might exist.

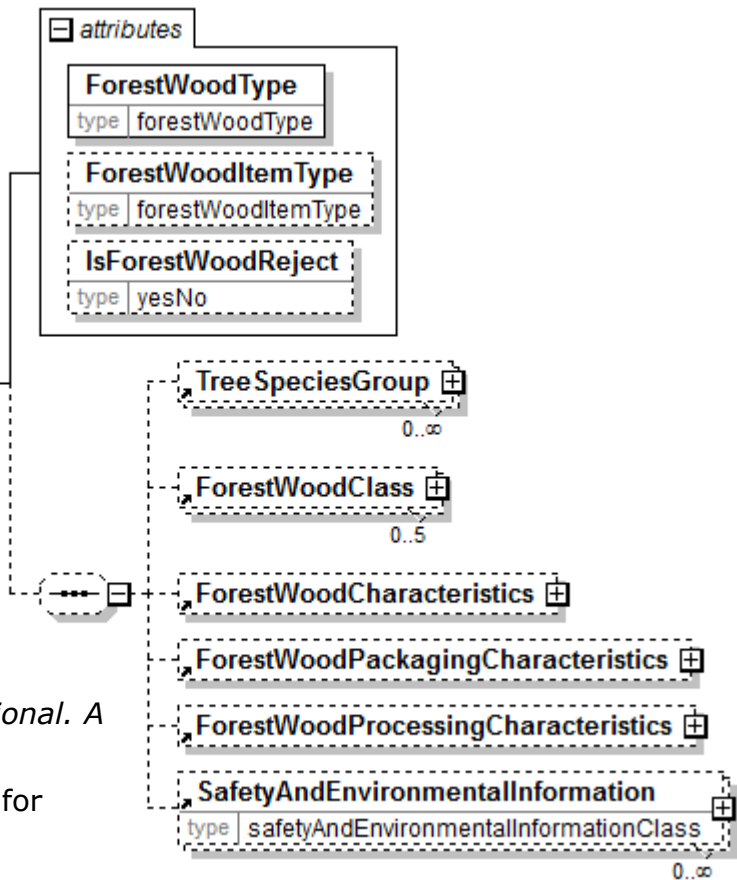

A grouping element that contains information about packaging of the Forest Wood product.

ForestWoodProcessingCharacteristics

ForestWoodProcessingCharacteristics is optional. A single instance might exist.

A grouping element that contains information about processing of the Forest Wood product.

SafetyAndEnvironmentalInformation

SafetyAndEnvironmentalInformation is optional. Multiple instances might exist.

Name of certification type, if any, on the goods (For example, FSC, PEFC). SafetyAndEnvironmental needs a value or measurement to communicate the percentage of the product is certified (for example, 75% is certified by the indicated agency).

ForestWoodCharacteristics

A grouping element that contains characteristics of the Forest Wood product.

(sequence)

The sequence of items below is mandatory. A single instance is required.

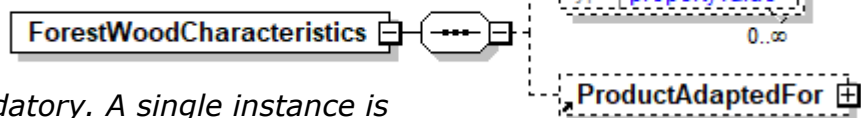

PropertyValue

PropertyValue is optional. Multiple instances might exist.

Specifies a value for a property of an item. The property is defined by the attribute PropertyType. The attribute MeasuringMethod and MeasuringAgency can be used to clarify details for a how a property is measured or calculated, e.g. Diameter for a saw log can be measured "Under Bark" or "Over Bark". The attribute MeasuringMethodType defines how the value is created, e.g. measured automatically, calculated etc. The attribute IsAverageValue indicates if the value is an average value or not.

PropertySubValue can specify a value for a property related to the property specified by the attribute PropertyType of PropertyValue. PropertyValueOfWhichMax and PropertyValueOfWhichMin can specify maximum and minimum values for properties that are part of the property specified by the attribute PropertyType of PropertyValue.

ProductAdaptedFor

ProductAdaptedFor is optional. A single instance might exist.

A group element containing information about a specific business party for which the product is adapted.

ForestWoodClass

A grouping element that details information used for describing classes of Forest Wood based on some product properties.

ForestWoodClassType [attribute]

ForestWoodClassType is mandatory. A single instance is required.

Defines the type of class for Forest Wood.

Refer to ForestWoodClassType definition for any enumerations.

(sequence)

The sequence of items below is mandatory. A single instance is required.

ForestWoodClassCode

ForestWoodClassCode is mandatory. A single instance is required.

A code defining the class of Forest Wood.

ForestWoodClassDescription

ForestWoodClassDescription is optional. Multiple instances might exist.

A text description of the class for Forest Wood.

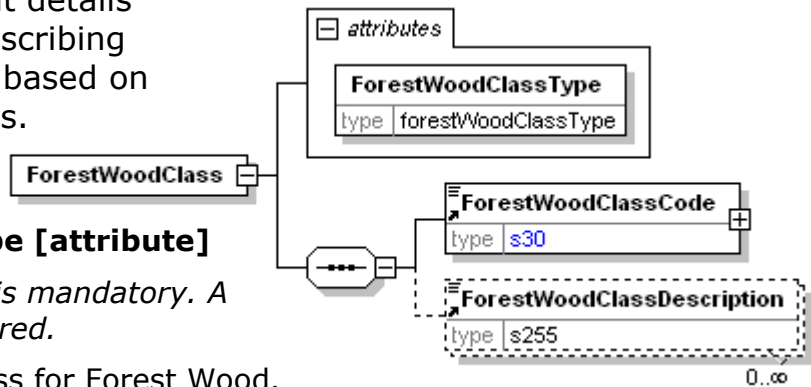

ForestWoodClassCode

A code defining the class of Forest Wood.

Agency [attribute]

Agency is mandatory. A single instance is required.

Describes the agency maintaining the list of codes. To be included in this list the agency must be a recognized standards body or industry organisation.

- For the element that owns this attribute.
- For another attribute in the list of attributes associated with the parent element.

Refer to Agency definition for any enumerations.

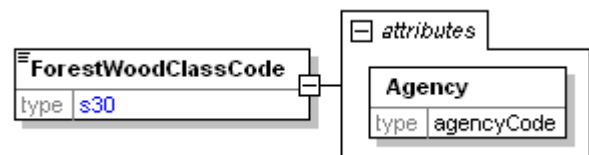

ForestWoodClassDescription

A text description of the class for Forest Wood.

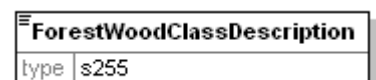

ForestWoodClassType [attribute]

Defines the type of class for Forest Wood.

This item is restricted to the following list.

ForestWoodClassType	
type	forestWoodClassType

DiameterClass

The class is based on the diameter of items.

LengthClass

The class is based on the length of items.

QualityClass

The class is based on the quality of items.

ReasonClass

The class is based on the reason assigned to items. Typically it is used for specifying the reason why an item has been downgraded to a lower quality.

UsageClass

The class of usage for a product. For example saw timber, pulp wood or bioenergy wood in Forest Wood Supply business.

ForestWoodItemType [attribute]

Defines detail type of items for Forest Wood product types.

This item is restricted to the following list.

ForestWoodItemType	
type	forestWoodItemType

LongLog

A cut portion of a stem that is classified as being long.

ShortLog

A cut portion of a stem that is classified as being short.

Stem

A felled tree crosscut at the top with all branches removed.

ForestWoodPackagingCharacteristics

A grouping element that

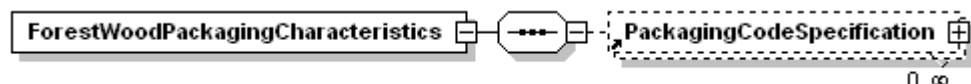

contains information about packaging of the Forest Wood product.

(sequence)

The sequence of items below is mandatory. A single instance is required.

PackagingCodeSpecification

PackagingCodeSpecification is optional. Multiple instances might exist.

A grouping element specifying code and description for packaging details.

ForestWoodProcessingCharacteristics

A grouping element

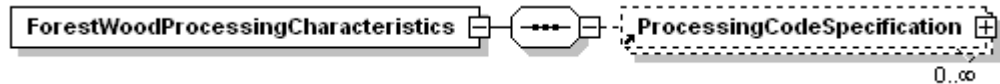

that contains information about processing of the Forest Wood product.

(sequence)

The sequence of items below is mandatory. A single instance is required.

ProcessingCodeSpecification

ProcessingCodeSpecification is optional. Multiple instances might exist.

A grouping element specifying code and description for processing details.

ForestWoodType [attribute]

Defines the type of product for Forest Wood.

This item is restricted to the following list.



Bark

Outer covering of the stem and branches of trees (tree bark). Bark from industrially processed logs or trees.

BioEnergyChips

Wood-based chips for bioenergy.

BioEnergySmallTree

Small-sized trees which have not been processed, usually used for energy purposes.

BoardWood

Boards and side cuts used for industrial processes or bioenergy.

Firewood

Firewood produced for heating.

ForestEnergy

Forest-based products for energy. It can be a mix of Bark, BioEnergyChips, BioEnergySmallTree, Firewood, LoggingResidue and Stump.

IndustrialChips

Chips coming as by-product from industrial manufacturing processes, usually used for pulp or paper making.

IndustrialReject

Wood rejects from manufacturing processes. It is used as raw material in other industrial processes or for bioenergy.

IndustrialResidues

Wood residuals from manufacturing processes used normally for bioenergy. It can be a mix of Bark, BoardWood, IndustrialChips, IndustrialReject and Sawdust.

LoggingResidue

Woody biomass residues which are created during timber harvesting. They include tree tops and branches. More information can be found in standard CEN/TS 14588:2003.

OtherWoodEnergy

Other wood based energy products.

Pellets

Pellets produced for heating.

RecycledWood

Recycled or waste wood, usually used for energy purposes.

Roundwood

Felled trees crosscut at the top, with all branches removed, that may or may not have been further crosscut.

Examples of Roundwood products are saw logs, pulpwood logs, tree length logs, stems, poles and other similar products that have been harvested in the forest but not processed industrially.

Sawdust

Sawdust from industrial manufacturing processes.

Stump

Portion of the tree that remains above and below ground after felling of the tree.

Tree

Tree that has not been delimbed and not cut into logs.

TreeClumpFromStump

Small group (or cluster) of trees emerging from a stump.

TreeCrown

Upper portion of a tree from the lowest branches and twigs.

Unspecified

When a Forest Wood Type is required to be communicated but it is unknown or need not be specified.

Formation

A group item used to communicate sheet formation target or test value according to a particular TestMethod.

TestMethod [attribute]

TestMethod is optional. A single instance might exist.

The method used to determine the results of the test under consideration.

TestAgency [attribute]

TestAgency is optional. A single instance might exist.

The agency that has set the parameters for the testing

Refer to TestAgency definition for any enumerations.

SampleType [attribute]

SampleType is optional. A single instance might exist.

Communicates how sampling was done to measure the product characteristics.

Refer to SampleType definition for any enumerations.

ResultSource [attribute]

ResultSource is optional. A single instance might exist.

Used to define the data source of the specified test

Refer to ResultSource definition for any enumerations.

(sequence)

The sequence of items below is mandatory. A single instance is required.

DetailValue

DetailValue is mandatory. A single instance is required.

A numeric value expressed in the unit of measure (UOM).

DetailRangeMin

DetailRangeMin is optional. A single instance might exist.

The minimum value (lower boundary) allowed for the DetailValue that is the parent of this element.

DetailRangeMax

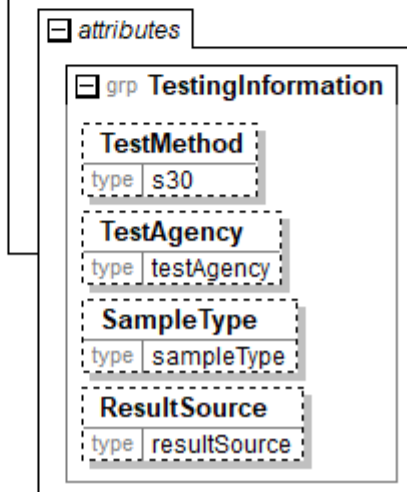
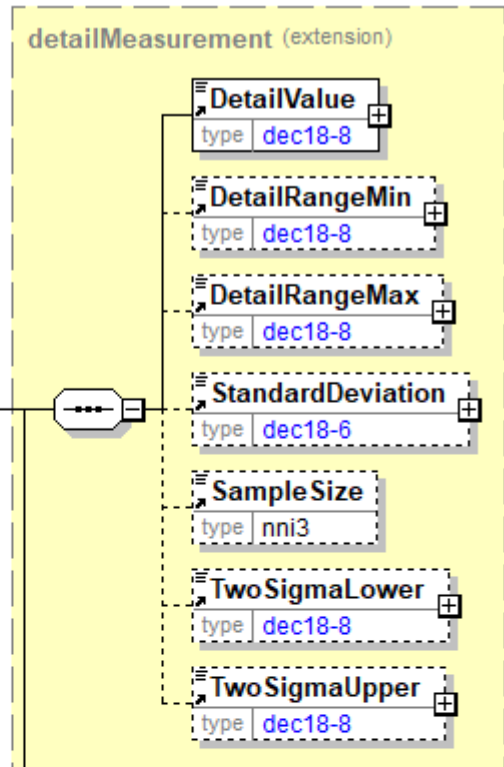

DetailRangeMax is optional. A single instance might exist.

The maximum value (upper boundary) allowed for the DetailValue that is the parent of this element.

StandardDeviation

StandardDeviation is optional. A single instance might exist.

A statistic used as a measure of dispersion in a distribution.

SampleSize

SampleSize is optional. A single instance might exist.

The number of samples used to determine the product characteristic in question.

TwoSigmaLower

TwoSigmaLower is optional. A single instance might exist.

Two sigma (a measure of dispersion associated with standard deviation) on the lower side of the standard deviation.

TwoSigmaUpper

TwoSigmaUpper is optional. A single instance might exist.

Two sigma (a measure of dispersion associated with standard deviation) on the upper side of the standard deviation.

ForwarderParty

The trading partner involved in the forwarding of the shipment.

LogisticsRole [attribute]

LogisticsRole is optional. A single instance might exist.

Communicates the nature of the logistics role, if any, the party plays in the transaction.

Refer to LogisticsRole definition for any enumerations.

(sequence)

The sequence of items below is mandatory. A single instance is required.

PartyIdentifier

PartyIdentifier is optional. Multiple instances might exist.

A unique identifier of a specific party. This element contains an attribute PartyIdentifierType that indicates the type of the identifier.

NameAddress

NameAddress is mandatory. A single instance is required.

A group item containing name and address of an organisation or business entity.

URL

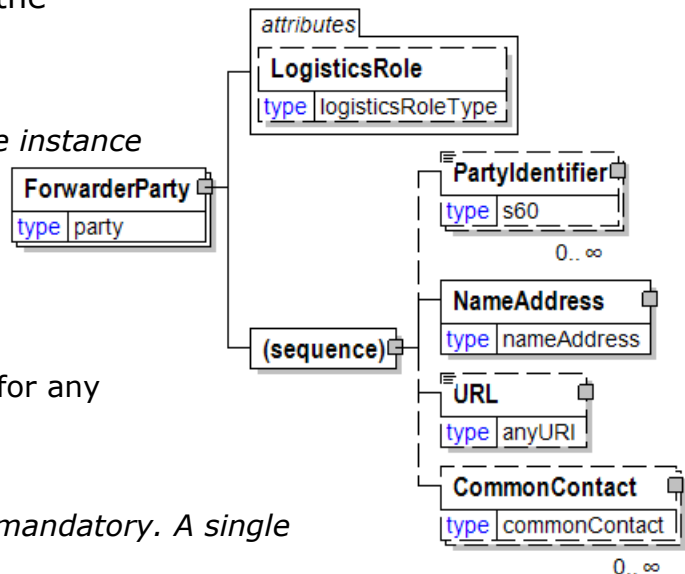

papiNet V2R31

URL is optional. A single instance might exist.

Universal Resource Locator. While typically a web address you could use this field to hold an email address.

CommonContact

CommonContact is optional. Multiple instances might exist.

Identifies a specific individual associated with the party.

FountainSolutionConductivity

Electrical measure of fountain solution measured in micro – siemens.

(sequence)

The sequence of items below is mandatory. A single instance is required.

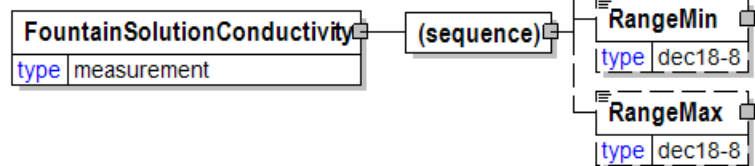

Value

Value is mandatory. A single instance is required.

A numeric value expressed in the unit of measure (UOM).

RangeMin

RangeMin is optional. A single instance might exist.

The minimum value (lower boundary) allowed for the Measurement that is the parent of this element.

RangeMax

RangeMax is optional. A single instance might exist.

The maximum value (upper boundary) allowed for the Measurement that is the parent of this element. Some elements use the RangeMax element with an extended list of unit of measures. (Note: the red colour in the picture is an artifact of how the graphic was captured and should be disregarded.)

FountainSolutionpH

Measurement of the acidic properties of the fountain solution.

(sequence)

The sequence of items below is mandatory. A single instance is required.

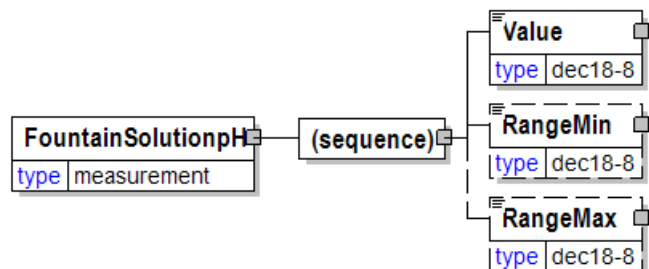

Value

Value is mandatory. A single instance is required.

A numeric value expressed in the unit of measure (UOM).

RangeMin

RangeMin is optional. A single instance might exist.

papiNet V2R31

The minimum value (lower boundary) allowed for the Measurement that is the parent of this element.

RangeMax

RangeMax is optional. A single instance might exist.

The maximum value (upper boundary) allowed for the Measurement that is the parent of this element. Some elements use the RangeMax element with an extended list of unit of measures. (Note: the red colour in the picture is an artifact of how the graphic was captured and should be disregarded.)

Freeness

Freeness

TestMethod [attribute]

TestMethod is optional. A single instance might exist.

The method used to determine the results of the test under consideration.

TestAgency [attribute]

TestAgency is optional. A single instance might exist.

The agency that has set the parameters for the testing
Refer to TestAgency definition for any enumerations.

SampleType [attribute]

SampleType is optional. A single instance might exist.

Communicates how sampling was done to measure the product characteristics.

Refer to SampleType definition for any enumerations.

ResultSource [attribute]

ResultSource is optional. A single instance might exist.

Used to define the data source of the specified test

Refer to ResultSource definition for any enumerations.

(sequence)

The sequence of items below is mandatory. A single instance is required.

DetailValue

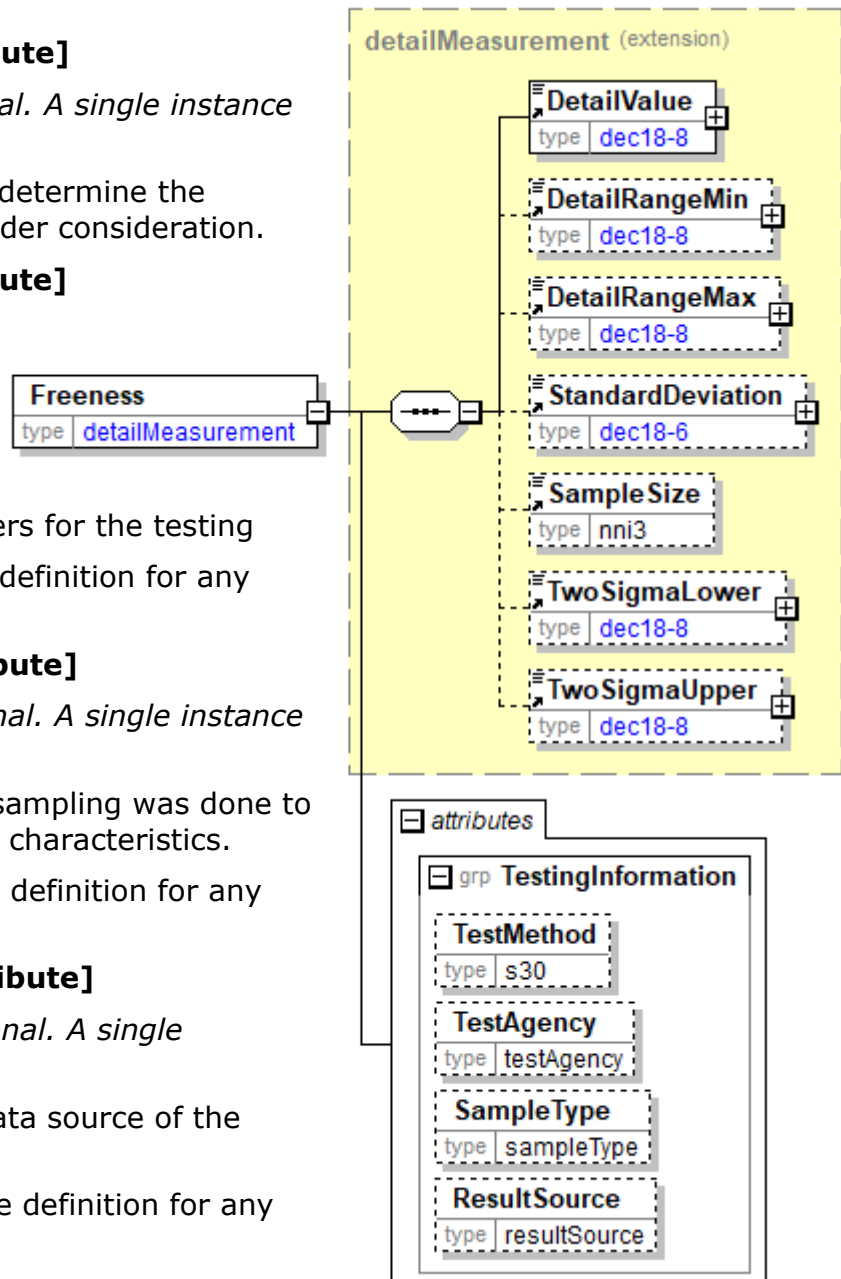

papiNet V2R31

DetailValue is mandatory. A single instance is required.

A numeric value expressed in the unit of measure (UOM).

DetailRangeMin

DetailRangeMin is optional. A single instance might exist.

The minimum value (lower boundary) allowed for the DetailValue that is the parent of this element.

DetailRangeMax

DetailRangeMax is optional. A single instance might exist.

The maximum value (upper boundary) allowed for the DetailValue that is the parent of this element.

StandardDeviation

StandardDeviation is optional. A single instance might exist.

A statistic used as a measure of dispersion in a distribution.

SampleSize

SampleSize is optional. A single instance might exist.

The number of samples used to determine the product characteristic in question.

TwoSigmaLower

TwoSigmaLower is optional. A single instance might exist.

Two sigma (a measure of dispersion associated with standard deviation) on the lower side of the standard deviation.

TwoSigmaUpper

TwoSigmaUpper is optional. A single instance might exist.

Two sigma (a measure of dispersion associated with standard deviation) on the upper side of the standard deviation.

FreightPayableAt

The location at which freight charges are calculated.

FreightPayableAt	
type	s40

Friction

A group item used to communicate static and kinetic friction target or test value according to a particular TestMethod.

TestMethod [attribute]

TestMethod is optional. A single instance might exist.

The method used to determine the results of the test under consideration.

TestAgency [attribute]

TestAgency is optional. A single instance might exist.

The agency that has set the parameters for the testing

Refer to TestAgency definition for any enumerations.

SampleType [attribute]

SampleType is optional. A single instance might exist.

Communicates how sampling was done to measure the product characteristics.

Refer to SampleType definition for any enumerations.

ResultSource [attribute]

ResultSource is optional. A single instance might exist.

Used to define the data source of the specified test

Refer to ResultSource definition for any enumerations.

(sequence)

The sequence of items below is mandatory. A single instance is required.

DetailValue

DetailValue is mandatory. A single instance is required.

A numeric value expressed in the unit of measure (UOM).

DetailRangeMin

DetailRangeMin is optional. A single instance might exist.

The minimum value (lower boundary) allowed for the DetailValue that is the parent of this element.

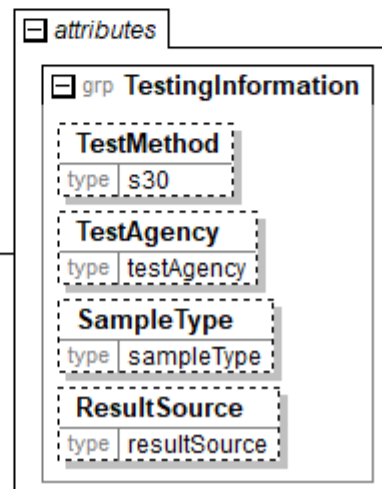
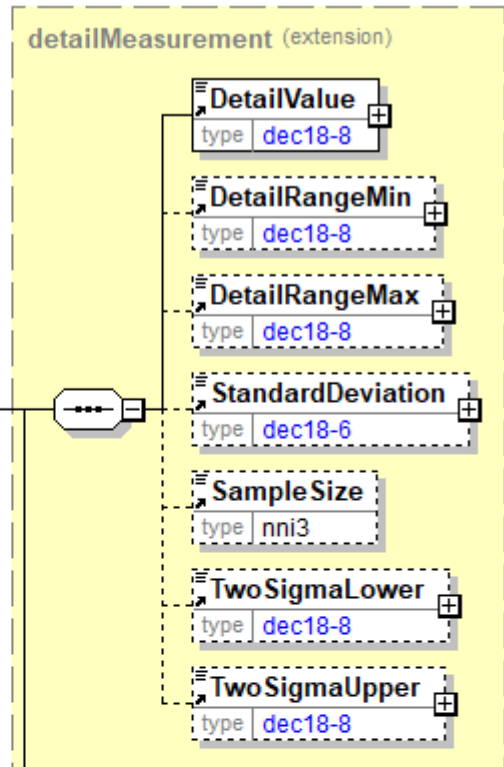

DetailRangeMax

DetailRangeMax is optional. A single instance might exist.

The maximum value (upper boundary) allowed for the DetailValue that is the parent of this element.

StandardDeviation

StandardDeviation is optional. A single instance might exist.

A statistic used as a measure of dispersion in a distribution.

SampleSize

SampleSize is optional. A single instance might exist.

The number of samples used to determine the product characteristic in question.

TwoSigmaLower

TwoSigmaLower is optional. A single instance might exist.

Two sigma (a measure of dispersion associated with standard deviation) on the lower side of the standard deviation.

TwoSigmaUpper

TwoSigmaUpper is optional. A single instance might exist.

Two sigma (a measure of dispersion associated with standard deviation) on the upper side of the standard deviation.

From

The beginning point of a timeperiod.

From
type time

FromProduct

Defines from which product the item is downgraded.

(sequence)

The sequence of items below is mandatory. A single instance is required.

(sequence)

The sequence of items below is mandatory. One instance is required, multiple instances might exist.

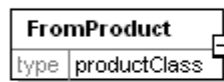

ProductIdentifier

ProductIdentifier is mandatory. A single instance is required.

Used to communicate the code of the article, in a variety of formats designated by the type.

ProductDescription

ProductDescription is optional. Multiple instances might exist.

An element used to communicate a human readable description of the product in the language specified by the Language attribute.

Classification

Classification is optional. Multiple instances might exist.

A group item that details the product classification according to a particular organization's scheme. An item across multiple classifications would still be recognized as the same item. Examples of some product classifications are: Containerboard, Pulp-Dissolving, or Newsprint.

(choice)

[choice] is optional. A single instance might exist.

BookManufacturing

BookManufacturing is mandatory. A single instance is required.

BookManufacturing is a group element that contains the elements that describe the book manufacturing process.

ForestWood

ForestWood is mandatory. A single instance is required.

A grouping element with information about characteristics for Forest Wood products.

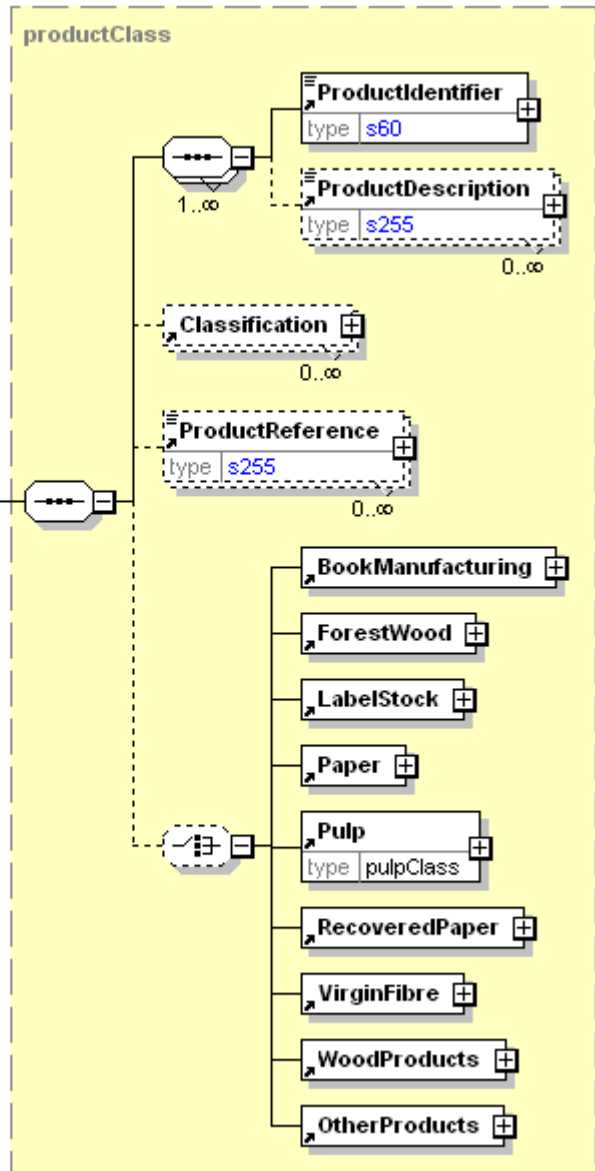

papiNet V2R31

LabelStock

LabelStock is mandatory. A single instance is required.

LabelStock contains the attributes and characteristics that define the label stock product.

Paper

Paper is mandatory. A single instance is required.

A group item defining the characteristics of the paper product.

Pulp

Pulp is mandatory. A single instance is required.

A group item defining the characteristics of pulp that are not dependent on a particular conversion process.

RecoveredPaper

RecoveredPaper is mandatory. A single instance is required.

A group item defining the characteristics of recycled fibre that are not dependent on a particular conversion process.

VirginFibre

VirginFibre is mandatory. A single instance is required.

Virgin Fibre

WoodProducts

WoodProducts is mandatory. A single instance is required.

A grouping element for all wood products.

OtherProducts

OtherProducts is mandatory. A single instance is required.

A group item defining the characteristics of other products.

FrontCouplingType [attribute]

Specifies the front coupling device that attaches the transport unit to a vehicle or another transport unit. For example attaches a trailer to a truck or another trailer.

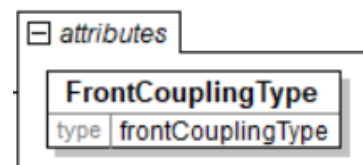

This item is restricted to the following list.

FifthWheelKingPin

A heavy metal cylindrical pin that is located underneath the front end of a trailer. The kingpin is the mechanism on a trailer that locks it to a coupling of type FifthWheelPlate.

HingedDrawBar

A coupling device that connects to a coupling of type TowBar. A hinged drawbar is free to pivot around an axle that is perpendicular to the vertical plane.

None

No coupling device present.

RigidDrawBar

A coupling device that connects to a coupling of type TowBar. A rigid drawbar is an integral part of the chassis.

GeneralLedgerAccount

The general ledger account to be referenced for the item.

Agency [attribute]

Agency is optional. A single instance might exist.

Describes the agency maintaining the list of codes. To be included in this list the agency must be a recognized standards body or industry organisation.

- For the element that owns this attribute.
- For another attribute in the list of attributes associated with the parent element.

Refer to Agency definition for any enumerations.

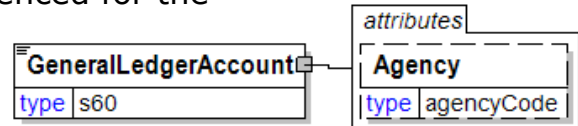

Gimmick

Gimmick

(sequence)

The sequence of items below is mandatory. A single instance is required.

AdditionalText

AdditionalText is optional. Multiple instances might exist.

A text field that is used to communicate information not previously defined or for special instructions. To be used only for circumstances not covered by specific elements.

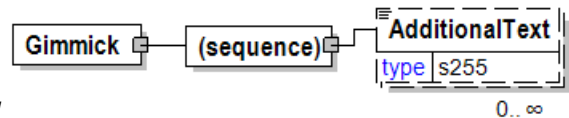

GlobalPartyID

A globally unique identifier for a party.

GlobalPartyIDType [attribute]

GlobalPartyIDType is mandatory. A single instance is required.

Specifies a globally unique type of identifier value for a party.

Refer to GlobalPartyIDType definition for any enumerations.

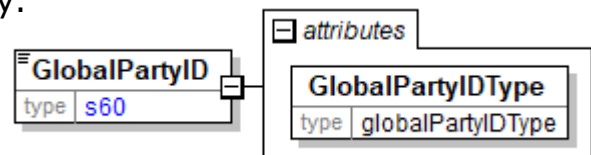

GlobalPartyIDType [attribute]

Specifies a globally unique type of identifier value for a party.

This item is restricted to the following list.



DunsNumber

A 9-digit identifier maintained by Dun & Bradstreet to uniquely identify a commercial enterprise.

Duns4Number

Similar to the DunsNumber that defines a parent company/organization. The additional 4 digits enable the definition/identification of a sub-entity, such as a mill/plant of this parent company/organisation.

GlobalLocationNumber

The globally unique EAN-UCC System identification number for legal entities, functional entities and physical locations. The Global Location Number uses the EAN/UCC-13 Data Structure. Details about the structure and usage are available at the <http://www.gs1.org> website.

ISO6523Number

This partyidentifier type is defined by ISO 6523, Structure for the Identification of Organizations, which defines the standard for a code to be used for party identification in electronic data interchange. The code is globally unique, because of the used structure. The structure of the identifier is, using xxxx99999999(NNNNN) as the example:

xxxx The International Code Designator (ICD-code) is a fixed-length code of four digits that identifies the authority issuing the ISO 6523 organization code; e.g. 0037 is the ICD-code (International Code Designator) for National Board of Taxes in Finland.

99999999 The organization code consists of up to 14 characters. The Code Designator (defined by ICD-code) defines the use of the organization code. The used code can be an existing code or, the code designator assigns the code to companies based on request. The Code Designator makes sure that the codes in their list are unique.

(NNNNN) Optional variable length information, to further identify the organization. The use of this is part defined by the code designator.

papiNetGlobalPartyIdentifier

A readily available and free identifier supported by IANA (the Internet Assigned Numbers Authority). Private Enterprise Numbers that conforms to proper URI naming conventions are available, free-of-charge from the Internet Assigned Numbers Authority (IANA). The application form is available at the <https://pen.iana.org/pen/PenApplication.page>. Obtaining an IANA Private Enterprise Number (PEN) will permit globally unique trading partner identification.

The format of papiNetGlobalPartyIdentifier is

1.3.6.1.4.1.PrivateEnterpriseNumber[.EnterpriseLocationNumber]

Only characters 0-9 and "." are allowed in the identifier. The PrivateEnterpriseNumber is a positive non-zero integer.

papiNet V2R31

The EnterpriseLocationNumber is optional with values managed by the organisation identified by the Private Enterprise Number. It is a positive non-zero integer, without leading zero(s).

The EnterpriseLocationNumber may be an enumerated list of integers separated by the full-stop character ".". It depicts an organisational sub-tree of integers, where the levels are separated by the full-stop character (.) as a separator.

For example identifier value 1.3.6.1.4.1.14302.10.5 is valid but identifier values 1.3.6.1.4.1.14302.0.5, 1.3.6.1.4.1.14302.ABC, 1.3.6.1.4.1.14302.15-20 and 1.3.6.1.4.1.14302.03 are NOT valid.

The EnterpriseLocationNumber is an optional unique location number within the Enterprise assigned by the Enterprise itself, for example

1.3.6.1.4.1.14302 The Enterprise

1.3.6.1.4.1.14302.4 Location number 4 of the Enterprise, e.g. a paper mill.

1.3.6.1.4.1.14302.12 Location number 12 of the Enterprise, e.g. a pulp mill.

Please refer to sections 3.1.4 and 3.2 in Internet Engineering Task Force RFC 1155 "Structure and Identification of Management Information for TCP/IP based Internets" for further details at <https://tools.ietf.org/html/rfc1155>.

StandardAddressNumber

A 7-digit code to uniquely identify an organisation and its location. The number consists of 6 digits with an 11-modulus check digit as the seventh digit. ISAN is the same with the ISO Country code as a prefix. This identifier is solely used by the book industry.

Gloss

A group item used to communicate specular gloss target or test value according to a particular TestMethod.

TestMethod [attribute]

TestMethod is optional. A single instance might exist.

The method used to determine the results of the test under consideration.

TestAgency [attribute]

TestAgency is optional. A single instance might exist.

The agency that has set the parameters for the testing

Refer to TestAgency definition for any enumerations.

SampleType [attribute]

SampleType is optional. A single instance might exist.

Communicates how sampling was done to measure the product characteristics.

Refer to SampleType definition for any enumerations.

ResultSource [attribute]

ResultSource is optional. A single instance might exist.

Used to define the data source of the specified test

Refer to ResultSource definition for any enumerations.

(sequence)

The sequence of items below is mandatory. A single instance is required.

DetailValue

DetailValue is mandatory. A single instance is required.

A numeric value expressed in the unit of measure (UOM).

DetailRangeMin

DetailRangeMin is optional. A single instance might exist.

The minimum value (lower boundary) allowed for the DetailValue that is the parent of this element.

DetailRangeMax

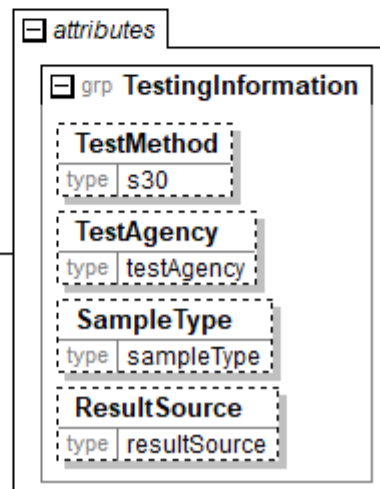
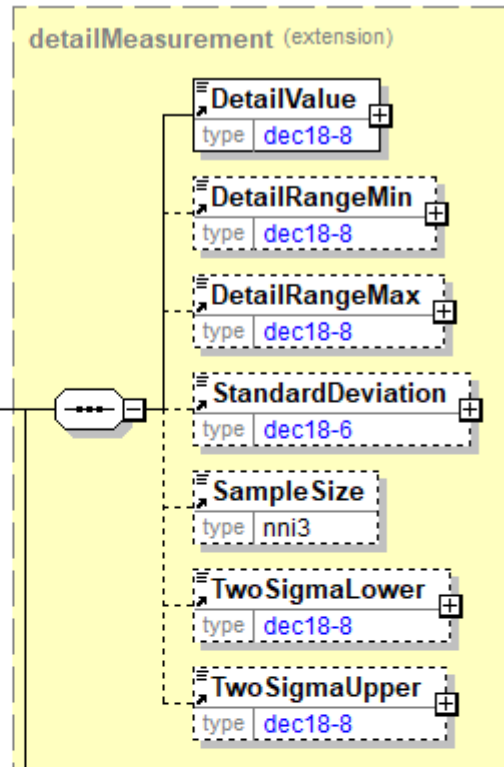

papiNet V2R31

DetailRangeMax is optional. A single instance might exist.

The maximum value (upper boundary) allowed for the DetailValue that is the parent of this element.

StandardDeviation

StandardDeviation is optional. A single instance might exist.

A statistic used as a measure of dispersion in a distribution.

SampleSize

SampleSize is optional. A single instance might exist.

The number of samples used to determine the product characteristic in question.

TwoSigmaLower

TwoSigmaLower is optional. A single instance might exist.

Two sigma (a measure of dispersion associated with standard deviation) on the lower side of the standard deviation.

TwoSigmaUpper

TwoSigmaUpper is optional. A single instance might exist.

Two sigma (a measure of dispersion associated with standard deviation) on the upper side of the standard deviation.

GlueExposure

Exposure class as defined by NIST standards and indicated in the grade stamp.

This item is restricted to the following list.

Exterior

Interior

Exposure1

Exposure2

GlueExposure	
type	plywoodOSBExposureClassType

GlueExposure

A grouping element that is used to specify the standard concerning glueing and other details about gluing.

Agency [attribute]

Agency is mandatory.

A single instance is required.

Describes the agency maintaining the list of codes. To be included in this list the agency must be a recognized standards body or industry organisation.

- For the element that owns this attribute.

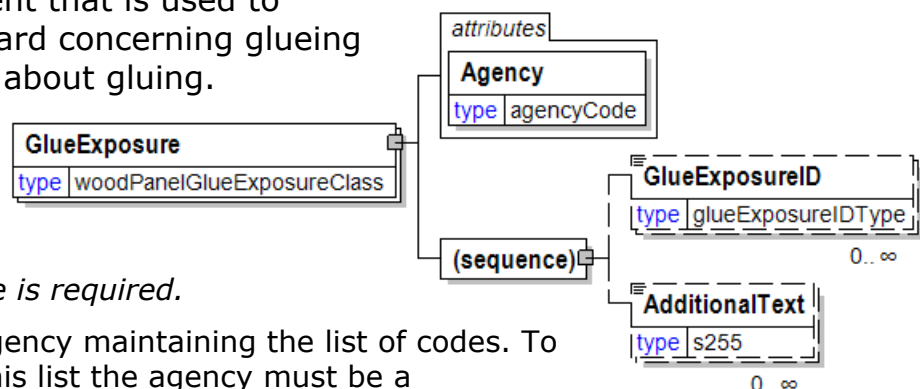

- For another attribute in the list of attributes associated with the parent element.

Refer to Agency definition for any enumerations.

(sequence)

The sequence of items below is mandatory. A single instance is required.

GlueExposureID

GlueExposureID is optional. Multiple instances might exist.

Exposure class as defined by NIST standards and indicated in grade stamp.

Refer to GlueExposureID definition for any enumerations.

AdditionalText

AdditionalText is optional. Multiple instances might exist.

A text field that is used to communicate information not previously defined or for special instructions. To be used only for circumstances not covered by specific elements.

GlueExposureID

Exposure class as defined by NIST standards and indicated in grade stamp.

This item is restricted to the following list.

Exterior

Interior

Exposure1

Exposure2

Other

GlueExposureID
type glueExposureIDType

GoodsLoadingPrinciple [attribute]

Defines principles for how goods are picked from warehouse and loaded

This item is restricted to the following list.

FirstInFirstOut

Goods to be picked and loaded on a first in and first out basis. The oldest goods stored into warehouse to be picked first.

LastInFirstOut

Goods to be picked and loaded on a last in and first out basis. The latest goods stored into warehouse to be picked first

Random

Goods to be picked and loaded in any order

attribute
GoodsLoadingPrinciple
type inventoryRotationType
default FirstInFirstOut

GoodsLoadingSequence

A group item that contains information regarding the order goods should be loaded onto a transport unit.

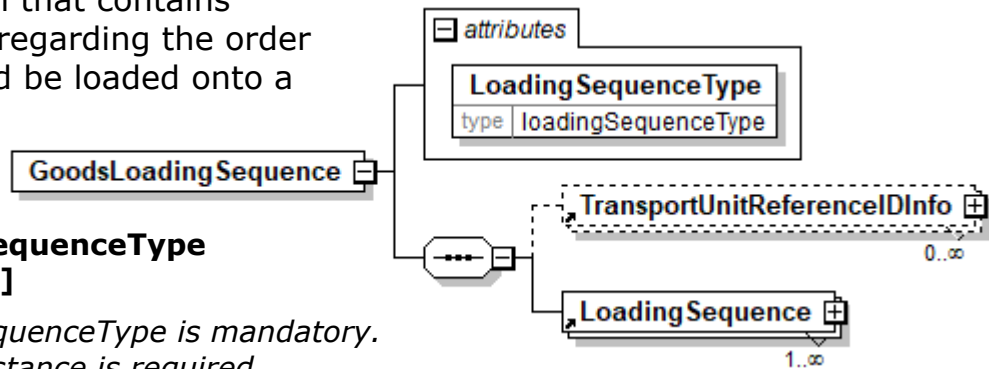

LoadingSequenceType [attribute]

LoadingSequenceType is mandatory. A single instance is required.

Specifies the type of item that is controlling the loading order of goods.

Refer to LoadingSequenceType definition for any enumerations.

(sequence)

The sequence of items below is mandatory. A single instance is required.

TransportUnitReferenceIDInfo

TransportUnitReferenceIDInfo is optional. Multiple instances might exist.

A group item that defines the relationship between a referenced transport unit and another transport unit.

LoadingSequence

LoadingSequence is mandatory. One instance is required, multiple instances might exist.

A group item that specifies a loading sequence of goods identified by the item specified in the attribute LoadingSequenceType. The loading of goods should be carried out in the order of increasing values of the SequenceNumber.

GoodsReceipt

The GoodsReceipt element is the root element for the GoodsReceipt e-Document.

The ShipTo party, or authorised agent, sends a GoodsReceipt e-Document to the Supplier and/or to the Buyer acknowledging that a specific delivery or a number of deliveries in a given time period have been received and their status.

GoodsReceipt

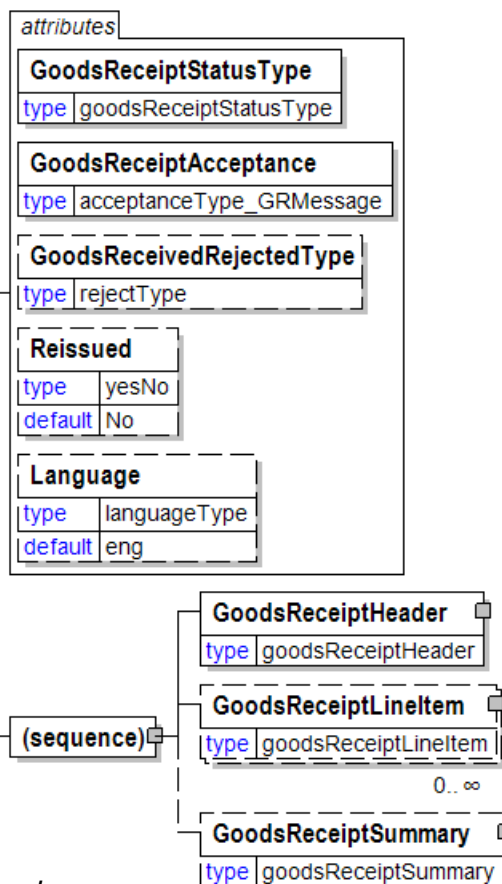

GoodsReceiptStatusType [attribute]

GoodsReceiptStatusType is mandatory. A single instance is required.

Defines the status of the entire GoodsReceipt e-Document at root level

Refer to GoodsReceiptStatusType definition for any enumerations.

GoodsReceiptAcceptance [attribute]

GoodsReceiptAcceptance is mandatory. A single instance is required.

Defines the state of the goods received as compared to the DeliveryMessage specifications. The enumeration list is the list of choices that apply to the GoodsReceipt e-Document root.

Refer to GoodsReceiptAcceptance definition for any enumerations.

GoodsReceivedRejectedType [attribute]

GoodsReceivedRejectedType is optional. A single instance might exist.

Defines the reason the goods were rejected

Refer to GoodsReceivedRejectedType definition for any enumerations.

Reissued [attribute]

Reissued is optional. A single instance might exist.

Either "Yes" or "No".

Refer to Reissued definition for any enumerations.

Language [attribute]

Language is optional. A single instance might exist.

The valid Alpha 2- and Alpha 3-character list of language codes in the ISO 639-1 and 639-2 international standards.

Information on the content of this attribute is available at:
https://www.loc.gov/standards/iso639-2/php/code_list.php

(sequence)

The sequence of items below is mandatory. A single instance is required.

GoodsReceiptHeader

GoodsReceiptHeader is mandatory. A single instance is required.

The GoodsReceiptHeader is required and contains information common to the GoodsReceipt e-Document.

GoodsReceiptLineItem

GoodsReceiptLineItem is optional. Multiple instances might exist.

The Optional GoodsReceiptLineItem specifies how a shipment was received for an individual delivery line for one PurchaseOrder and PurchaseOrder line item.

GoodsReceiptSummary

GoodsReceiptSummary is optional. A single instance might exist.

Summary information that applies to the entire GoodsReceipt e-Document.

GoodsReceiptAcceptance [attribute]

Defines the state of the goods received as compared to the DeliveryMessage specifications. The enumeration list is the list of choices that apply to the GoodsReceipt header and line item.



This item is restricted to the following list.

GoodsReceivedAsIs

The delivered goods were received without inspection, or checking of the goods for damage, or accuracy against the DeliveryMessage.

GoodsReceivedAsSpecified

Received goods agree completely with all DeliveryMessage specifications for all lines including item identifiers and item weights. There is no transit damage.

GoodsReceivedCancelled

Received goods notification is being cancelled. This value is only used when the GoodsReceiptStatusType is "Cancelled".

GoodsReceivedRejected

Received goods agree completely with all DeliveryMessage specifications for all lines including item identifiers and item weights; but there has been transit damage resulting in rejection of all goods.

GoodsReceivedWithDamage

Received goods agree completely with all DeliveryMessage specifications for all lines including item identifiers and item weights; but there has been transit damage of some items. All transit damages must be specified.

GoodsReceivedWithVariance

Received goods do not agree completely with the DeliveryMessage specifications. For those items at variance, actual received item identifiers and item weights must be specified.

Additionally, used with the VarianceType of "NotReceived" to indicate items that was on the DeliveryMessage but not in the Delivery as received.

GoodsReceivedWithVarianceAndDamage

Received goods do not agree completely with all DeliveryMessage specifications for all lines including item identifiers and item weights and there has been transit damage of some items. For those items at variance or with transit damage, actual received item identifiers, item weights, and transit damages must be specified.

GoodsReceiptAcceptance [attribute]

Defines the state of the goods received as compared to the DeliveryMessage specifications. The enumeration list is the list of choices that apply to the GoodsReceipt e-Document root.

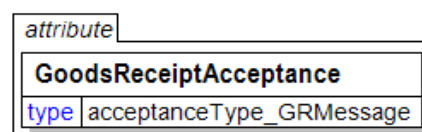

This item is restricted to the following list.

GoodsReceivedAsIs

The delivered goods were received without inspection, or checking of the goods for damage, or accuracy against the DeliveryMessage.

GoodsReceivedAsSpecified

Received goods agree completely with all DeliveryMessage specifications for all lines including item identifiers and item weights. There is no transit damage.

GoodsReceivedCancelled

Received goods notification is being cancelled. This value is only used when the GoodsReceiptStatusType is "Cancelled."

GoodsReceivedRejected

Received goods agree completely with all DeliveryMessage specifications for all lines including item identifiers and item weights; but there has been transit damage resulting in rejection of all goods.

GoodsReceivedWithDamage

Received goods agree completely with all DeliveryMessage specifications for all lines including item identifiers and item weights; but there has been transit damage of some items. All transit damages must be specified.

GoodsReceivedWithoutDeliveryMessage

Goods were received but there was no prior DeliveryMessage. This acceptance status applies to the entire GoodsReceipt e-Document and is available only at the e-Document level.

GoodsReceivedWithVariance

Received goods do not agree completely with the DeliveryMessage specifications. For those items at variance, actual received item identifiers and item weights must be specified.

Additionally, used with the VarianceType of "NotReceived" to indicate items that was on the DeliveryMessage but not in the Delivery as received.

GoodsReceivedWithVarianceAndDamage

Received goods do not agree completely with all DeliveryMessage specifications for all lines including item identifiers and item weights and there has been transit damage of some items. For those items at variance or with transit damage, actual received item identifiers, item weights, and transit damages must be specified.

GoodsReceiptArrivalDate

The Date and optionally Time on which the received goods arrived.

(sequence)

The sequence of items below is mandatory. A single instance is required.

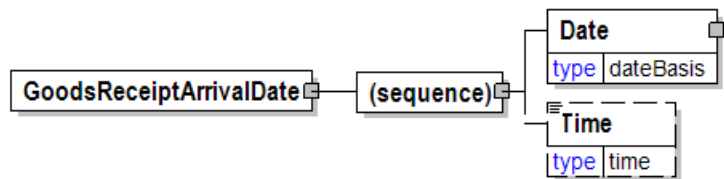

Date

Date is mandatory. A single instance is required.

A group element that contains the specification of Year, Month, and Day.

Time

Time is optional. A single instance might exist.

Times are treated in a standard XML fashion with a special case used to indicate a generalized "local" time. The standard XML approach to time is hh:mm:ss, hh:mm:ssZ, or hh:mm:ss±hh:mm.

hh:mm:ss±hh:mm is used to represent a time with a time zone. The time zone is communicated as the number of hours offset from the Universal Time Coordinate (UTC), a.k.a. Greenwich Mean Time.

hh:mm:ssZ indicates the time at Zulu (another name for UTC).

hh:mm:ss or hh:mm indicates within papiNet the applicable local time where the associated event is taking place. Caution should be used when processing times of this nature as the papiNet approach may be in discord with other users of XML.

GoodsReceiptHeader

The GoodsReceiptHeader is required and contains information common to the GoodsReceipt e-Document.

GoodsReceiptHeaderAcceptance [attribute]

GoodsReceiptHeaderAcceptance is optional. A single instance might exist.

Defines the state of the goods received as compared to the DeliveryMessage specifications. The enumeration list is the list of choices that apply to the GoodsReceipt header and line item.

Refer to GoodsReceiptHeaderAcceptance definition for any enumerations.

(sequence)

The sequence of items below is mandatory. A single instance is required.

GoodsReceiptNumber

GoodsReceiptNumber is mandatory. A single instance is required.

The unique receipt identifier as agreed by the trading partners.

GoodsReceiptIssueDate

GoodsReceiptIssueDate is optional. A single instance might exist.

The date that the GoodsReceipt e-Document was created.

TransactionHistoryNumber

TransactionHistoryNumber is optional. A single instance might exist.

A sequential number that keeps track of the version of a document.

However when the document is a confirmation document, in which case the TransactionHistoryNumber refers to the trigger transaction for the confirmation.

GoodsReceiptArrivalDate

GoodsReceiptArrivalDate is optional. A single instance might exist.

The Date and optionally Time on which the received goods arrived.

TimePeriod

TimePeriod is optional. A single instance might exist.

The TimePeriod element is used to communicate a duration period of time as indicated in PeriodType.

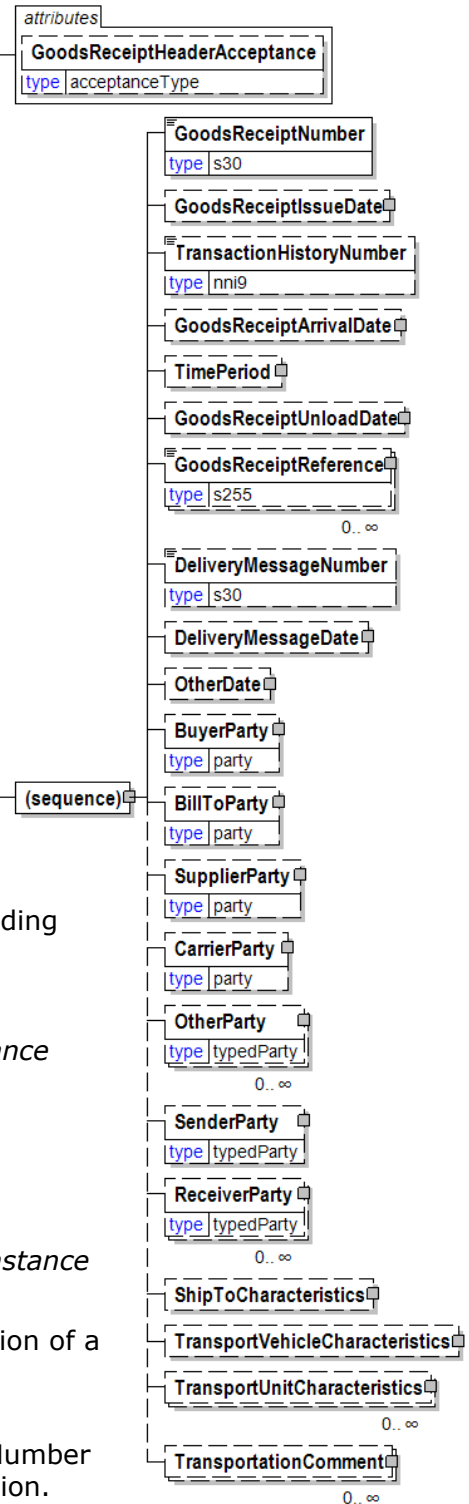
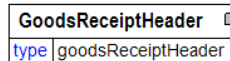

GoodsReceiptUnloadDate

GoodsReceiptUnloadDate is optional. A single instance might exist.

The Date and optionally Time on which the received goods were unloaded.

GoodsReceiptReference

GoodsReceiptReference is optional. Multiple instances might exist.

A group item detailing relevant references (such as contract number) pertaining to the GoodsReceipt, as indicated by the GoodsReceiptReferenceType.

DeliveryMessageNumber

DeliveryMessageNumber is optional. A single instance might exist.

A unique delivery identifier assigned to each DeliveryMessage as agreed between the trading partners.

DeliveryMessageDate

DeliveryMessageDate is optional. A single instance might exist.

The Date and Time when the DeliveryMessage was issued.

OtherDate

OtherDate is optional. A single instance might exist.

A date that may not be specifically detailed within a document (example: print date at the PurchaseOrderLineItem).

BuyerParty

BuyerParty is optional. A single instance might exist.

The legal entity to which the product is sold. Also commonly referred to as the sold-to party or customer. If no OtherParty is defined as the Payer, the Buyer is the Payer.

BillToParty

BillToParty is optional. A single instance might exist.

The address where the Invoice is to be sent.

SupplierParty

SupplierParty is optional. A single instance might exist.

The organisation or business entity responsible for providing the product. SupplierParty is also the seller of the product, if Seller is not specified as OtherParty = Seller.

CarrierParty

CarrierParty is optional. A single instance might exist.

The party performing the transport of the product from the pickup location to the ship-to location; could be a hauler.

OtherParty

OtherParty is optional. Multiple instances might exist.

An organisation or business entity other than those specifically detailed within an e-Document.

SenderParty

SenderParty is optional. A single instance might exist.

The business entity issuing the e-Document, the source of the document.

The entity responsible for the content. If the sender party has out sourced the message service to a third party the SenderParty is the issuer of the e-Document and not the party performing the transmission service of the electronic message.

ReceiverParty

ReceiverParty is optional. Multiple instances might exist.

The business entity for whom the e-Document is intended, the destination of the document.

The entity interested in the content. If the receiver party has outsourced the message service to a third party the ReceiverParty is the intended party for the e-Document and not the party performing the receiving service of the electronic message.

ShipToCharacteristics

ShipToCharacteristics is optional. A single instance might exist.

A group item that provides information important for the Ship-To Party.

TransportVehicleCharacteristics

TransportVehicleCharacteristics is optional. A single instance might exist.

A group item containing information about a transport vehicle, e.g. a truck. A transport vehicle has its own power and can be used to pull, push, carry, or tow a transport unit loaded with goods.

TransportUnitCharacteristics

TransportUnitCharacteristics is optional. Multiple instances might exist.

A group item containing information about a transport unit, e.g. a trailer. Transport units contain goods and move using power from another source, the transport vehicle.

TransportationComment

TransportationComment is optional. Multiple instances might exist.

Textual Commentary on Transportation for an entire GoodsReceipt.

GoodsReceiptHeaderAcceptance [attribute]

Defines the state of the goods received as compared to the DeliveryMessage specifications. The enumeration list is the list of choices that apply to the GoodsReceipt header and line item.

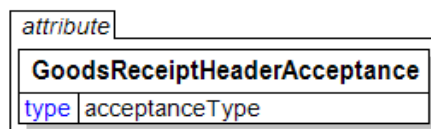

This item is restricted to the following list.

GoodsReceivedAsIs

The delivered goods were received without inspection, or checking of the goods for damage, or accuracy against the DeliveryMessage.

GoodsReceivedAsSpecified

Received goods agree completely with all DeliveryMessage specifications for all lines including item identifiers and item weights. There is no transit damage.

GoodsReceivedCancelled

papiNet V2R31

Received goods notification is being cancelled. This value is only used when the GoodsReceiptStatusType is "Cancelled".

GoodsReceivedRejected

Received goods agree completely with all DeliveryMessage specifications for all lines including item identifiers and item weights; but there has been transit damage resulting in rejection of all goods.

GoodsReceivedWithDamage

Received goods agree completely with all DeliveryMessage specifications for all lines including item identifiers and item weights; but there has been transit damage of some items. All transit damages must be specified.

GoodsReceivedWithVariance

Received goods do not agree completely with the DeliveryMessage specifications. For those items at variance, actual received item identifiers and item weights must be specified.

Additionally, used with the VarianceType of "NotReceived" to indicate items that was on the DeliveryMessage but not in the Delivery as received.

GoodsReceivedWithVarianceAndDamage

Received goods do not agree completely with all DeliveryMessage specifications for all lines including item identifiers and item weights and there has been transit damage of some items. For those items at variance or with transit damage, actual received item identifiers, item weights, and transit damages must be specified.

GoodsReceiptIssueDate

The date that the GoodsReceipt e-Document was created.

(sequence)

The sequence of items below is mandatory. A single instance is required.

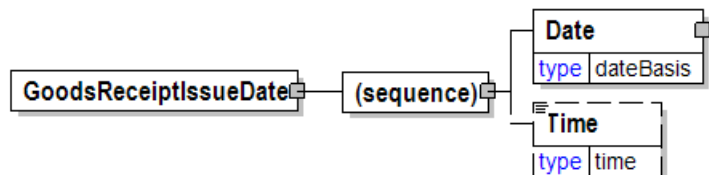

Date

Date is mandatory. A single instance is required.

A group element that contains the specification of Year, Month, and Day.

Time

Time is optional. A single instance might exist.

Times are treated in a standard XML fashion with a special case used to indicate a generalized "local" time. The standard XML approach to time is hh:mm:ss, hh:mm:ssZ, or hh:mm:ss±hh:mm.

hh:mm:ss±hh:mm is used to represent a time with a time zone. The time zone is communicated as the number of hours offset from the Universal Time Coordinate (UTC), a.k.a. Greenwich Mean Time.

hh:mm:ssZ indicates the time at Zulu (another name for UTC).

hh:mm:ss or hh:mm indicates within papiNet the applicable local time where the associated event is taking place. Caution should be used when processing times of this nature as the papiNet approach may be in discord with other

users of XML.

GoodsReceiptLineItem

The Optional GoodsReceiptLineItem specifies how a shipment was received for an individual delivery line for one PurchaseOrder and PurchaseOrder line item.

GoodsReceiptAcceptance [attribute]

GoodsReceiptAcceptance is mandatory. A single instance is required.

Defines the state of the

goods received as compared to the DeliveryMessage specifications. The enumeration list is the list of choices that apply to the GoodsReceipt header and line item.

Refer to GoodsReceiptAcceptance definition for any enumerations.

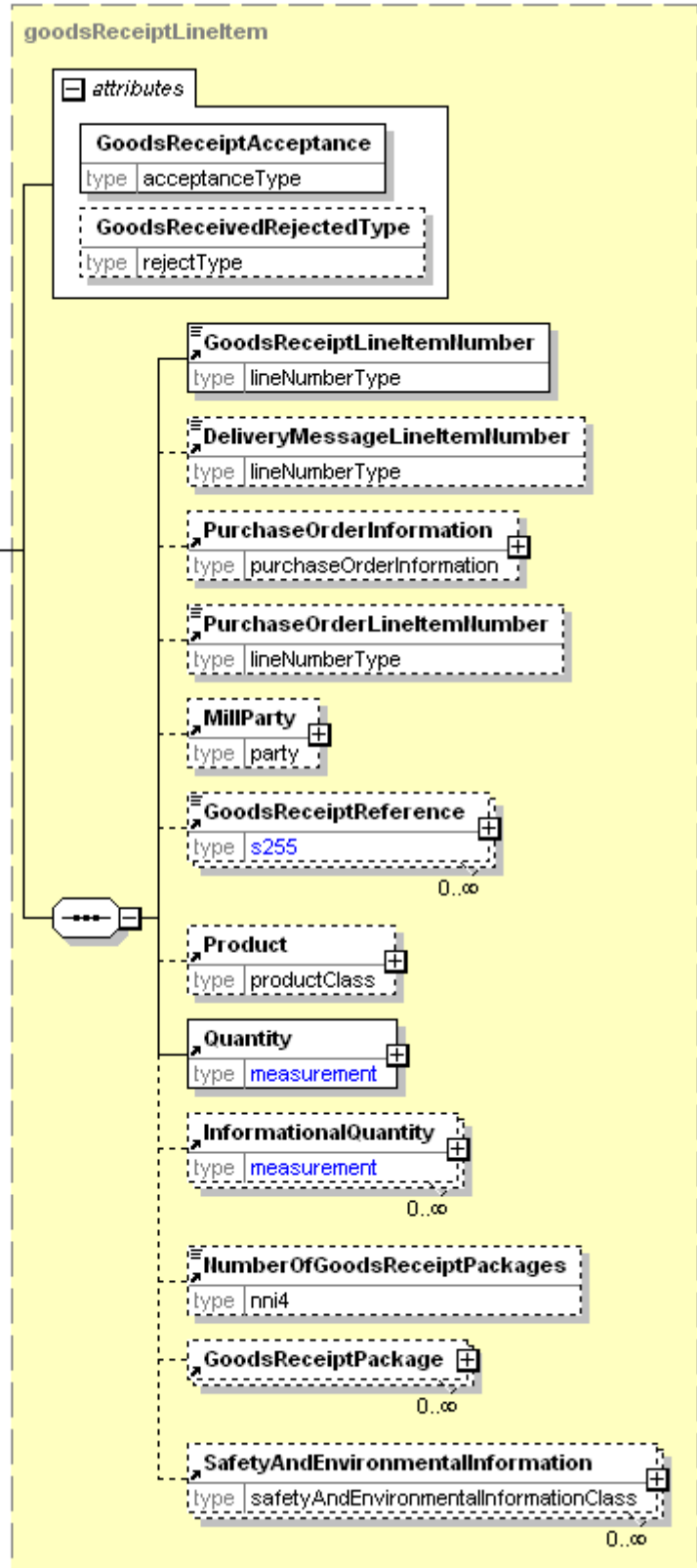

GoodsReceivedRejectedType [attribute]

GoodsReceivedRejectedType is optional. A single instance might exist.

Defines the reason the goods were rejected

Refer to GoodsReceivedRejectedType definition for any enumerations.

(sequence)

The sequence of items below is mandatory. A single instance is required.

GoodsReceiptLineItemNumber

GoodsReceiptLineItemNumber is mandatory. A single instance is required.

A sequential number that uniquely identifies the GoodsReceipt line item.

DeliveryMessageLineItemNumber

DeliveryMessageLineItemNumber is optional. A single instance might exist.

The sequential number that uniquely identifies the delivery line item.

PurchaseOrderInformation

PurchaseOrderInformation is optional. A single instance might exist.

A group item containing information unique to this PurchaseOrder, which is provided by the buyer. PurchaseOrderInformation can be optional in the supply chain. Invoices are created without having a PurchaseOrder in Vendor Managed Inventory. Freight invoices also will not have a PurchaseOrder number.

PurchaseOrderLineItemNumber

PurchaseOrderLineItemNumber is optional. A single instance might exist.

The sequential number that uniquely identifies the PurchaseOrder line item.

MillParty

MillParty is optional. A single instance might exist.

The organisation or business entity that actually produces the product.

GoodsReceiptReference

GoodsReceiptReference is optional. Multiple instances might exist.

A group item detailing relevant references (such as contract number) pertaining to the GoodsReceipt, as indicated by the GoodsReceiptReferenceType.

Product

Product is optional. A single instance might exist.

Product is a group item defining the article and its characteristics. Product is used to specify product characteristics organized by ProductIdentifier, ProductDescription, and Classification. Book Manufacturing, Label Stock, Paper, Pulp, Recovered Paper, Wood Products, and Virgin Fibre market segments have defined their product characteristics and conversion features for implementation in papiNet.

Quantity

Quantity is mandatory. A single instance is required.

The Quantity element contains attributes that provide information about the type of quantity that is being communicated, the context in which the particular quantity is to be viewed, and (if the quantity represents an adjustment) an adjustment type.

The Quantity element contains three child elements that enable you to communicate a range of values for the quantity and a target or actual value. It is at this level (Value, RangeMin, and RangeMax) that the unit of measure is specified.

papiNet V2R31

This permits the range to be specified in a different unit of measure than the target.

InformationalQuantity

InformationalQuantity is optional. Multiple instances might exist.

A quantity given in a valid UOM used for information purposes only (not for calculation). For example, an ordered quantity was 100 reels as opposed to the invoice quantity of 20,000 pounds.

NumberOfGoodsReceiptPackages

NumberOfGoodsReceiptPackages is optional. A single instance might exist.

A count of the number of packages detailed in the GoodsReceiptLineItem.

GoodsReceiptPackage

GoodsReceiptPackage is optional. Multiple instances might exist.

This element represents the manner in which the GoodsReceipt is packaged.

SafetyAndEnvironmentalInformation

SafetyAndEnvironmentalInformation is optional. Multiple instances might exist.

Name of certification type, if any, on the goods (For example, FSC, PEFC). SafetyAndEnvironmental needs a value or measurement to communicate the percentage of the product is certified (for example, 75% is certified by the indicated agency).

GoodsReceiptLineItemNumber

A sequential number that uniquely identifies the GoodsReceipt line item.

GoodsReceiptLineItemNumber
type lineNumberType

GoodsReceiptNumber

The unique receipt identifier as agreed by the trading partners.

GoodsReceiptNumber
type s30

GoodsReceiptPackage

This element represents the manner in which the GoodsReceipt is packaged.

GoodsReceiptAcceptance [attribute]

GoodsReceiptPackage

GoodsReceiptAcceptance is mandatory. A single instance is required.

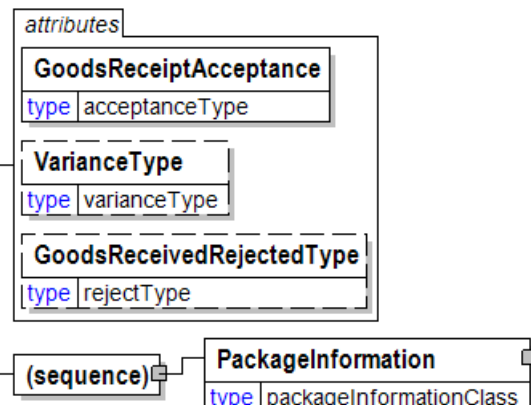

papiNet V2R31

Defines the state of the goods received as compared to the DeliveryMessage specifications. The enumeration list is the list of choices that apply to the GoodsReceipt e-Document root.

Refer to GoodsReceiptAcceptance definition for any enumerations.

VarianceType [attribute]

VarianceType is optional. A single instance might exist.

Defines the type of difference that the GoodsReceiptPackage has from the information on the DeliveryMessage

Refer to VarianceType definition for any enumerations.

GoodsReceivedRejectedType [attribute]

GoodsReceivedRejectedType is optional. A single instance might exist.

Defines the reason the goods were rejected

Refer to GoodsReceivedRejectedType definition for any enumerations.

(sequence)

The sequence of items below is mandatory. A single instance is required.

PackageInformation

PackageInformation is mandatory. A single instance is required.

The purpose of the PackageInformation structure is to clearly identify physical handling items that constitute the delivery.

PackageInformation is the highest level of product packaging it describes the shipping or warehousing unit.

If you are communicating a package, usually for logistics or transport purposes, you should include the PackageType, Identifier, ItemCount, and Quantity. (Note: you still have the ability to describe the item with one of the "named" items.)

If you are communicating one of the named Items there is no need to include PackageType, Identifier, ItemCount, and Quantity.

Since either of these two approaches can be used the entire contents of this element are optional even though the parent may be required. It is expected that you will fill in the appropriate details.

GoodsReceiptReference

A group item detailing relevant references (such as contract number) pertaining to the GoodsReceipt, as indicated by the



`GoodsReceiptReferenceType`.

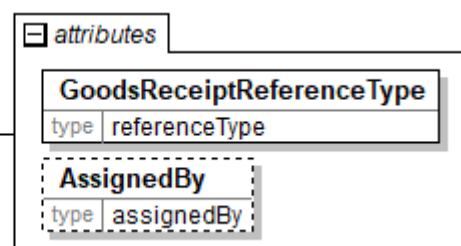

GoodsReceiptReferenceType [attribute]

GoodsReceiptReferenceType is mandatory. A single instance is required.

Provides a contextual explanation of the specific reference identifier. Many items are currently prefixed by "Buyer", "Forwarder", "Manufacturer", "Mill",

"Seller", "Supplier", "Warehouse", or "Vendor". Check for an existing non-prefixed version and use the non-prefixed version instead. In the (yet to be announced release date) version 3.0 the prefixed versions will be removed. Instead the attribute @AssignedBy will communicate the information previously communicated in the prefix.

Refer to GoodsReceiptReferenceType definition for any enumerations.

AssignedBy [attribute]

AssignedBy is optional. A single instance might exist.

Identifies the type of party or the agency that has assigned the associated item, e.g. a reference of type OrderNumber.

Refer to AssignedBy for any enumerations.

GoodsReceiptReferenceType [attribute]

Provides a contextual explanation of the specific reference identifier. Many items are currently prefixed by "Buyer", "Forwarder", "Manufacturer", "Mill", "Seller", "Supplier", "Warehouse", or "Vendor". Check for an existing non-prefixed version and use the non-prefixed version instead. In the (yet to be announced release date) version 3.0 the prefixed versions will be removed. Instead the attribute @AssignedBy will communicate the information previously communicated in the prefix.



Refer to the [referenceType](#) entry for the list of enumerations and their definitions.

GoodsReceiptStatusType [attribute]

Defines the status of the entire GoodsReceipt e-Document at root level

This item is restricted to the following list.



Cancelled

The supplied information has been cancelled. Items that have been cancelled are not included in totals on the summary levels of the e-Document.

Original

The supplied information is the first version of that information.

Replaced

The supplied information is replacing earlier supplied information. The receiver should revalidate the information in their system based upon the entire information received.

GoodsReceiptSummary

Summary information that applies to the entire GoodsReceipt e-Document.

(sequence)

The sequence of items below is mandatory. A single instance is

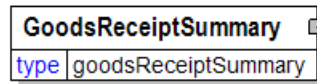

required.

TotalNumberOfLineItems

TotalNumberOfLineItems is optional. A single instance might exist.

The total number of individual line items in the document, regardless of the status or type.

(sequence)

The sequence of items below is mandatory. One instance is required, multiple instances might exist.

TotalQuantity

TotalQuantity is mandatory. A single instance is required.

The total quantity of similar items in the e-Document. TotalQuantity is primarily used in the summary section of documents where it is repeatable to permit totaling for different units of measure.

TotalInformationalQuantity

TotalInformationalQuantity is optional. Multiple instances might exist.

A quantity that is used to communicate related information about the parent element. This element represents a total that is derived from individual line items.

TermsAndDisclaimers

TermsAndDisclaimers is optional. Multiple instances might exist.

An element that contains legal information with an indication of what the Language is.

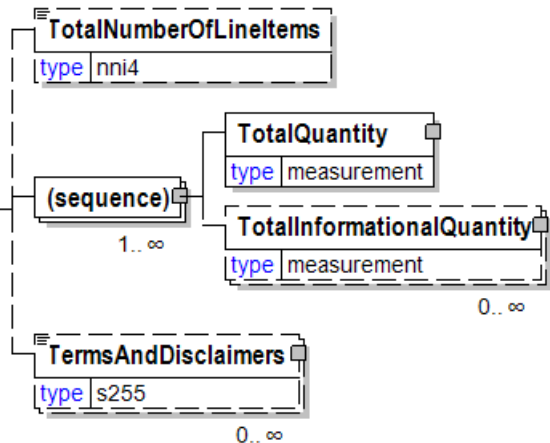

GoodsReceiptUnloadDate

The Date and optionally Time on which the received goods were unloaded.

(choice)

[choice] is mandatory. A single instance is required.

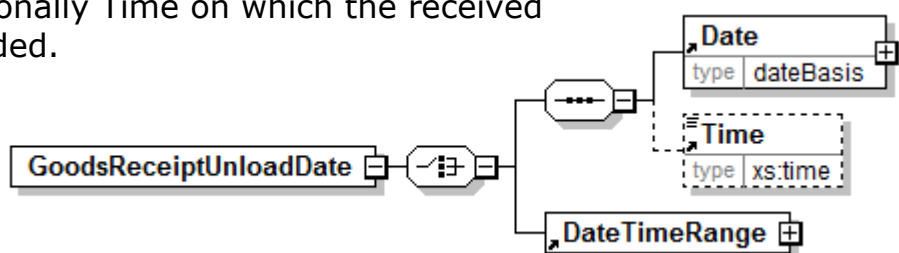

(sequence)

The sequence of items below is mandatory. A single instance is required.

papiNet V2R31

Date

Date is mandatory. A single instance is required.

A group element that contains the specification of Year, Month, and Day.

Time

Time is optional. A single instance might exist.

Times are treated in a standard XML fashion with a special case used to indicate a generalized "local" time. The standard XML approach to time is hh:mm:ss, hh:mm:ssZ, or hh:mm:ss±hh:mm.

hh:mm:ss±hh:mm is used to represent a time with a time zone. The time zone is communicated as the number of hours offset from the Universal Time Coordinate (UTC), a.k.a. Greenwich Mean Time.

hh:mm:ssZ indicates the time at Zulu (another name for UTC).

hh:mm:ss or hh:mm indicates within papiNet the applicable local time where the associated event is taking place. Caution should be used when processing times of this nature as the papiNet approach may be in discord with other users of XML.

DateTimeRange

DateTimeRange is mandatory. A single instance is required.

Specifies a date and/or time range.

GoodsReceivedRejectedType [attribute]

Defines the reason the goods were rejected

This item is restricted to the following list.

attribute
GoodsReceivedRejectedType
type rejectType

ExcessiveTransitDamage

The item(s) is/are damaged beyond acceptable use during transit.

ProductQuality

The delivery did not match the quality of the product ordered or requested.

TooEarly

The delivery has occurred prior to the agreed delivery date/time. For example, there is insufficient storage at the delivered time.

TooLate

The delivery has occurred after the agreed delivery date/time. For example, delivered after press date.

UnableToUnload

The delivered items cannot be unloaded. For example, damaged vehicle doors, load has shifted during transportation, or ShipTo requires reels to be palletised but they are delivered on the vehicle floor.

WrongBarCode

The barcode used to identify the product is incorrect.

WrongBasisWeight

The basis weight of the product is not what was ordered.

WrongDeliveryLocation

The product was delivered to the wrong location.

WrongDiameter

The diameter delivered is unusable. For example, a physical limitation on a reel stand is exceeded.

WrongLabel

The delivered item has incorrect or missing information, or incorrect label stock that would prevent its use. For example, insufficient peel-off barcode labels.

WrongProduct

The delivered item was not the product ordered or requested.

WrongReelWidth

The width of the reel is incorrect.

WrongVehicleType

The items have been delivered in a vehicle that cannot be unloaded at the ShipTo facility. For example, the ShipTo requires side unloading vehicles, but the delivery vehicle can only be unloaded from the rear.

WrongWrap

The delivered item is wrapped in material that will prevent its use. For example, a hole is not present in the end cap for vacuum lifting.

GPSCoordinates

The location of the party as specified using a Global Positioning System.

This element will be deprecated in a future version V3R00 and should not be used in new implementations. Use instead the MapCoordinates.

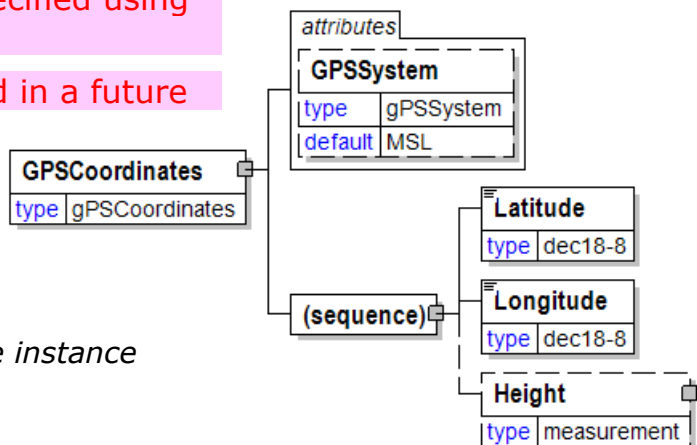

GPSSystem [attribute]

GPSSystem is optional. A single instance might exist.

The type of GPS system.

Refer to GPSSystem definition for any enumerations.

(sequence)

The sequence of items below is mandatory. A single instance is required.

Latitude

Latitude is mandatory. A single instance is required.

A measurement of the position of the party or contact in degrees north or south of

papiNet V2R31

the equator

Longitude

Longitude is mandatory. A single instance is required.

A measurement of the position of the party or contact in degrees east or west of the prime meridian

Height

Height is optional. A single instance might exist.

The height of the object.

GPSSystem [attribute]

The type of GPS system.

This item is restricted to the following list.

ECEF

Earth Centered Earth Fixed

HAE

Height about Ellipse

MSL

Mean Sea Level (default)

attribute	
GPSSystem	
type	gPSSystem
default	MSL

Grade

Grade

Grade	
type	s60

GradeAgency [attribute]

LumberAgency identifies which agency is responsible for assigning the lumber attributes.

This item is restricted to the following list.

BS

BS-EN

British standard based on a European standard.

CEN

European Committee for Standardisation (<http://www.cenorm.be>)

DIN

EN338

EN1912

EN1611-1

attribute	
GradeAgency	
type	LumberAgencyType

EDISAW

Generic

GOST

Russian federal agency on technical regulating and metrology
(<http://www.gost.ru>)

ISO

JAS

Japanese Agricultural Standard

NELMA

NLGA

NS

NSLB

RIS

RT

SIS

SPIB

WCLIB

WRCLA

WWPA

Supplier

GradeAgency

North American structural panel grading agencies. Defines the governing organisation of the grading scheme employed.

GradeAgency
type plywoodOSBGradeAgencyType

Note: There is a GradeAgency attribute, as well.

This item is restricted to the following list.

APA

PITTSBURG

TECO

MillCertified

None

GradeCode

A specific product code for which the owner or source is specified.

GradeCode
type s30

GradeName

A specific product name for which the owner or source is specified (for example, ImprovedNewsprint-45-1479)

GradeName	
type	s30

GradeStamp

Grade stamp information

GradeStamped [attribute]

GradeStamp	
type	constructionGradeStampClass

GradeStamped is optional. A single instance might exist.

Either "Yes" or "No".

Refer to GradeStamped definition for any enumerations.

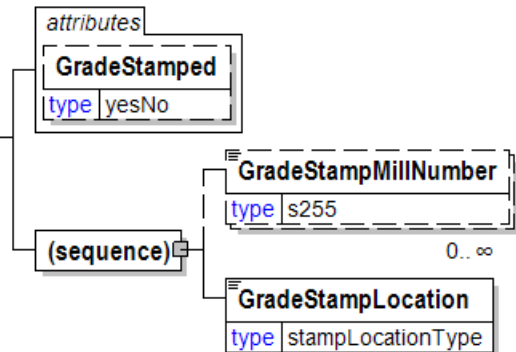

(sequence)

The sequence of items below is mandatory. A single instance is required.

GradeStampMillNumber

GradeStampMillNumber is optional. Multiple instances might exist.

Identifies the mill where the special grading was carried out.

GradeStampLocation

GradeStampLocation is mandatory. A single instance is required.

Defines the location on the piece (of the stamp).

Refer to GradeStampLocation definition for any enumerations.

GradeStamped [attribute]

Either "Yes" or "No".

This item is restricted to the following list.

Yes

No

attribute	
GradeStamped	
type	yesNo

GradeStampLocation

Defines the location on the piece (of the stamp).

This item is restricted to the following list.

Face

Back

GradeStampLocation	
type	stampLocationType

Good Side

Bad Side

Edge

End

GradeStampMillNumber

Identifies the mill where the special grading was carried out.

GradeStampMillNumber
type s255

GradeType [attribute]

Grade Type

This item is restricted to the following list.

- #1**
- #1 and #2**
- #1 and #2 Clear**
- #1 (SRB)**
- #1 Box**
- #1 Commons**
- #1 Cuts**
- #1 Cuttings**
- #1 Dense**
- #1 Dense Stadium Grade**
- #1 Dense Structural**
- #1 Door Cuttings**
- #1 Fencing (Select)**
- #1 Furniture**
- #1 Lath**
- #1 Mining**
- #1 Non Dense**
- #1 Pencil Stock**
- #1 Prime**
- #1 Sash Cuttings**
- #1 Shop**
- #1 Stadium Grade**
- #1 Structural**

attribute
GradeType
type lumberGradeType

papiNet V2R31

#1 and Btr
#2
#2 (SRB)
#2 Box
#2 Common
#2 Cuts
#2 Cuttings
#2 Dense
#2 Door Cuttings
#2 Fencing (Quality)
#2 Foundation
#2 Furniture
#2 Lath
#2 Mining
#2 Non Dense
#2 Pencil Stock
#2 Prime
#2 Sash Cuttings
#2 Shop
#2 Structural
#2 and Btr
#2 and Btr Common
#2 and Btr Fencing(Rustic)
#3
#3 (SRB)
#3 Clear
#3 Common
#3 Cuttings
#3 Fencing
#3 Fencing (Rustic)
#3 Lath
#3 Pencil Stock
#3 Shop
#3 Shop or Sash
#3 and Btr
#3 and Btr Common
#4

#4 Common

#5 Common

1.5E LAM

1.6E LAM

1.7E LAM

1.8E LAM

1.9E LAM

1200f

1350f

1400f

1450f

1500f

1600f

1650f

1800f

1950f

2.0E LAM

2.1E LAM

2.2E LAM

2.3E LAM

2.4E LAM

2.5E LAM

2.6E LAM

2000f

2100f

2200f Scaffold Plank

2250f

2400f

2400f Scaffold Plank

2550f

26002-83

GOST (agency) export Quality

2700f

2850f

3000f

302-20

302-22

302-24

3150f

3300f

8486

GOST (agency) domestic quality

900f

A

A and Btr

Appearance Knotty

Architect Clear

Architect Knotty

B

B and B

B Grade

B Laminating

B and Btr

B and Btr - 1 and 2 Clear

B.F.Laminating

Barge Framing

Barge Planking and Decking

Battens

C

C Laminating

C Select

C Ship Decking

C and Btr

C and Btr Dimension

C and Btr Select

C and Btr-VG Stepping

California Fencing

Choice

Choice and Btr

Clear

Clear All Heart

Clear Door

Clear Door Rip

Clear Finger Joint

Clear Gutter
Clear Heart
Clear VG Heart
Colonial
Commercial Decking
Commercial Dex
Commercial Patio
Construction
Construction (SRB)
Construction Common
Construction Heart
Crossarms
Custom Clear
Custom knotty
Cut Door Stock
D
D Dimension
D Laminating
D Select
D and Btr
D and Btr Select
Deck Common
Deck Heart
Dense Commercial Decking
Dense Industrial Scaffold plank 65
Dense Industrial Scaffold Plank 72
Dense Premium
Dense Select Decking
Dense Select Structural
Dense Standard Decking
Dunnage
D0VD Stepping
E
Economy
Economy Fencing
Economy Stud
Factory Fitches

Factory Select
FG or MG Ladder Rails
Fingerjoint Shop Common
Finish
Foundation
Gutter
Heart B
Heart Clear
Industrial
Industrial 26
Industrial 45
Industrial 55
Knotty
Knotty Finger Joint
L1 Dense Laminating
L1 Laminating
L1-c Laminating
L2 Laminating
L2-d Dense Laminating
L3 Laminating
Ladder and Pole Stock
Ladder Rail Stock
M-10
M-11
M-12
M-13
M-14
M-15
M-16
M-17
M-18
M-19
M-20
M-21
M-22
M-23
M-24

M-25

M-26

M-27

M-28

M-29

M-30

M-31

M-5

M-6

M-7

M-8

M-9

Margin Plank

Mast Spar and Boat Two and One-Fourth Inch and Thicker

Mast Spar and Boat One to Two Inch

Merchantable

Merchantable Heart

MillGrade

Moulding Stock (A)

Moulding Stock (B)

Moulding and Btr

Mouldings

NeLMA # 1A Furniture

NeLMA # 2A Furniture

None

NSLB #1

NSLB #2

Par99

Patio 1

Patio 2

Pipe Stave Stock

Plank Wall

Premium

Premium and Btr

Prime

Quality

Quality Fencing

Quality Knotty
RadiusEdgeDecking 1
RadiusEdgeDecking 2
Rustic
Rustic Fencing
Rustic Knotty
Sash
Sash Cuttings
Sawn Railroad Ties
Scaffold #1
Scaffold #2
Select
Select and Quality Knotty
Select Decking
Select Dex
Select Fencing
Select Heart
Select Knotty
Select Merchantable
Select Patio
Select Shop
Select Structural
Select Structural (SRB)
Select Structural Non Dense
Selected
Selected #2 Common
Selected #3 Common
Selected Decking
Selected Gutter
Ship Decking
Ship Plank
Shop Fitches
Short
Short Select
SPS 1 Certified Fingerjointed
SPS 3 Certified Fingerjointed
Stadium Plank Seats

Stadium Plank Walk boards
Stadium Planks
Stained Selects
Standard
Standard (SRB)
Standard Mouldings
Standard and Btr
Sterling
Stud
Stud (SRB)
Superior
Supreme
Tank Stock Inch and Thicker
Tank Stock Under Four Inch
Utility
Utility (#2 Mining)
Utility (SRB)
Utility and Btr
VG Ladder Rails

GradingRule [attribute]

Grading rule, the rules under which the product has been graded.

This item is restricted to the following list.

European 1611-1
GSSS
Nordic
SS EN 230120
Supplier
Other

attribute
GradingRule
type gradingRule

GrainDirection

Defines the primary orientation/alignment (Long or Short) of the cellulose fibres in a sheet or web of paper, which results from the flow of fibres in a water suspension during the papermaking process.

This item is restricted to the following list.

GrainDirection
type grainDirection

Any

Grain Direction does not matter.

Long

Orientation is aligned with the long fibres or with the grain.

Short

Orientation is aligned with the short fibres or against the grain.

Green

The "Green" portion of the method of representing colour termed RGB

(sequence)

The sequence of items below is mandatory. A single instance is required.

DetailValue

DetailValue is mandatory. A single instance is required.

A numeric value expressed in the unit of measure (UOM).

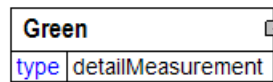

DetailRangeMin

DetailRangeMin is optional. A single instance might exist.

The minimum value (lower boundary) allowed for the DetailValue that is the parent of this element.

DetailRangeMax

DetailRangeMax is optional. A single instance might exist.

The maximum value (upper boundary) allowed for the DetailValue that is the parent of this element.

StandardDeviation

StandardDeviation is optional. A single instance might exist.

A statistic used as a measure of dispersion in a distribution.

SampleSize

SampleSize is optional. A single instance might exist.

The number of samples used to determine the product characteristic in question.

TwoSigmaLower

TwoSigmaLower is optional. A single instance might exist.

Two sigma (a measure of dispersion associated with standard deviation) on the lower side of the standard deviation.

TwoSigmaUpper

TwoSigmaUpper is optional. A single instance might exist.

Two sigma (a measure of dispersion associated with standard deviation) on the upper side of the standard deviation.

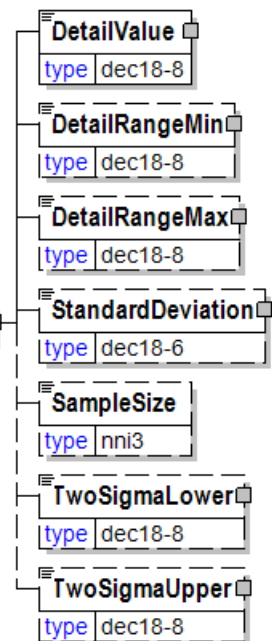

Gutter

Gutter

Bleed [attribute]

Bleed is optional. A single instance might exist.

Specifies if the printing of an illustration, design, or text to the edge of the page.

Refer to Bleed definition for any enumerations.

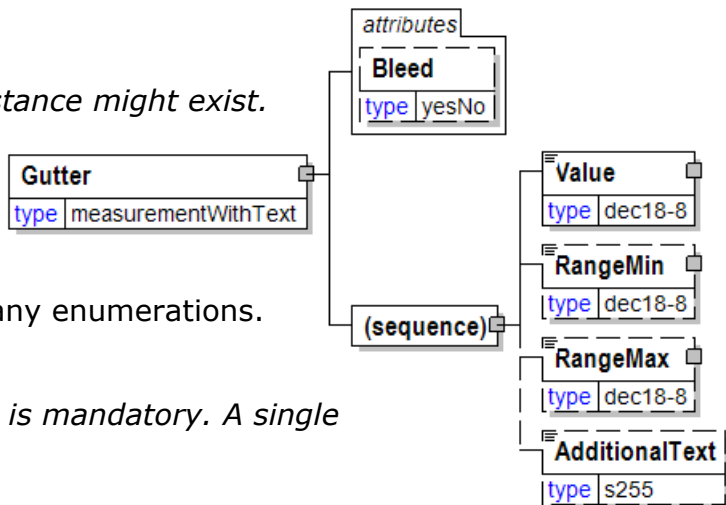

(sequence)

The sequence of items below is mandatory. A single instance is required.

Value

Value is mandatory. A single instance is required.

A numeric value expressed in the unit of measure (UOM).

RangeMin

RangeMin is optional. A single instance might exist.

The minimum value (lower boundary) allowed for the Measurement that is the parent of this element.

RangeMax

RangeMax is optional. A single instance might exist.

The maximum value (upper boundary) allowed for the Measurement that is the parent of this element. Some elements use the RangeMax element with an extended list of unit of measures. (Note: the red colour in the picture is an artifact of how the graphic was captured and should be disregarded.)

AdditionalText

AdditionalText is optional. A single instance might exist.

A text field that is used to communicate information not previously defined or for special instructions. To be used only for circumstances not covered by specific elements.

Gypsum

A placeholder for further definition of gypsum items.

(sequence)

The sequence of items below is mandatory. A single instance is required.

[Any Type]

Any type of content is permitted at this point.

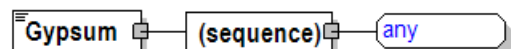

Halftones

Halftones are images made up of a series of dots in a specific pattern that simulates the look of a continuous tone image.

IsHalftones [attribute]

IsHalftones is mandatory. A single instance is required.

Indicates if the images are halftones or not.

(sequence)

The sequence of items below is mandatory. A single instance is required.

Value

Value is optional. Multiple instances might exist

A numeric value expressed in the unit of measure (UOM).

AdditionalText

AdditionalText is optional. Multiple instances might exist.

A text field that is used to communicate information not previously defined or for special instructions. To be used only for circumstances not covered by specific elements.

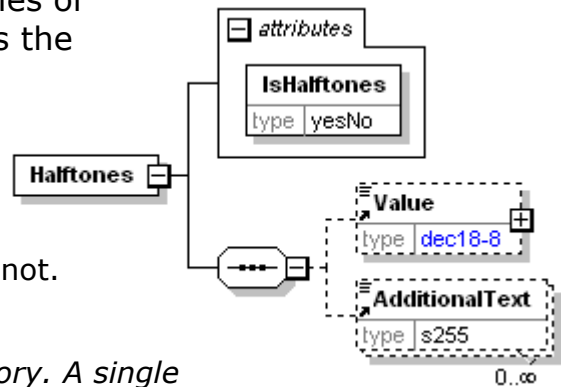

HardwoodLumber

Product structure for solid wood products made of hardwood.

(sequence)

The sequence of items below is mandatory. A single instance is required.

HardwoodLumberCharacteristics

HardwoodLumberCharacteristics is mandatory. A single instance is required.

A group item that organises the hardwood lumber –product information.

Packaging

Packaging is optional. A single instance might exist.

Type of a package that includes individual products.

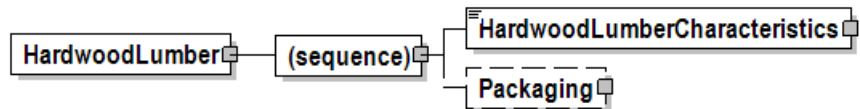

HardwoodLumberCharacteristics

A group item that organises the hardwood lumber –product information.

(sequence)

The sequence of items below is mandatory. A single instance is required.

[Any Type]

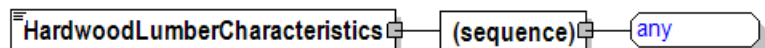

Any type of content is permitted at this point.

Head

Head.

Bleed [attribute]

Bleed is optional. A single instance might exist.

Specifies if the printing of an illustration, design, or text to the edge of the page.

Refer to Bleed definition for any enumerations.

(sequence)

The sequence of items below is mandatory. A single instance is required.

Value

Value is mandatory. A single instance is required.

A numeric value expressed in the unit of measure (UOM).

RangeMin

RangeMin is optional. A single instance might exist.

The minimum value (lower boundary) allowed for the Measurement that is the parent of this element.

RangeMax

RangeMax is optional. A single instance might exist.

The maximum value (upper boundary) allowed for the Measurement that is the parent of this element. Some elements use the RangeMax element with an extended list of unit of measures. (Note: the red colour in the picture is an artifact of how the graphic was captured and should be disregarded.)

AdditionalText

AdditionalText is optional. A single instance might exist.

A text field that is used to communicate information not previously defined or for special instructions. To be used only for circumstances not covered by specific elements.

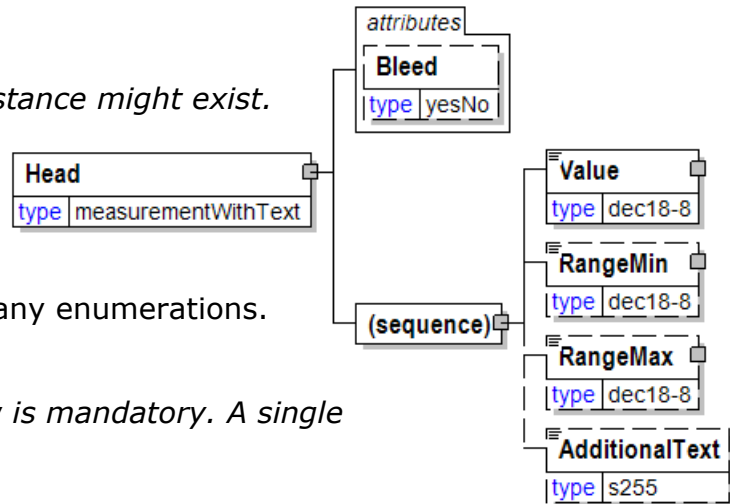

Headband

Headband.

BandLocationType [attribute]

BandLocationType is optional. A single instance might exist.

Band location type

Refer to BandLocationType definition for any enumerations.

(sequence)

The sequence of items below is mandatory. A single instance is required.

ColourCode

ColourCode is optional. A single instance might exist.

A code indicating the colour.

ColourDescription

ColourDescription is optional. A single instance might exist.

A free form description of the colour.

BandMaterial

BandMaterial is optional. A single instance might exist.

Band material

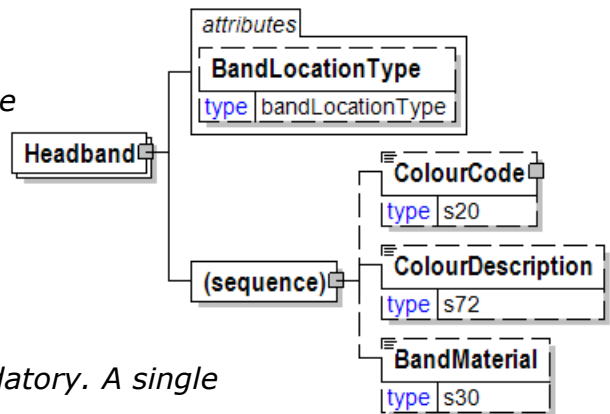

HeatTreatment

Defines the heat treatment method.

HeatTreatmentType [attribute]

HeatTreatmentType is optional. A single instance might exist.

Defines the standard to which to product has been heat treated.

Refer to HeatTreatmentType definition for any enumerations.

(sequence)

The sequence of items below is mandatory. A single instance is required.

AdditionalText

AdditionalText is optional. Multiple instances might exist.

A text field that is used to communicate information not previously defined or for special instructions. To be used only for circumstances not covered by specific elements.

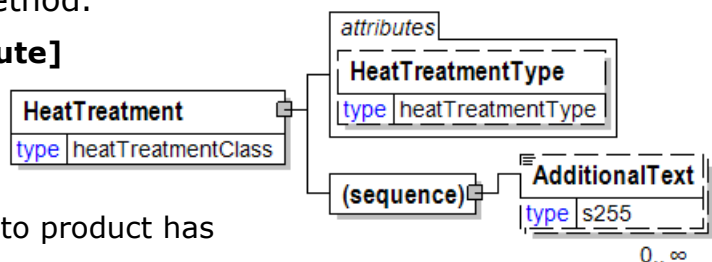

HeatTreatmentType [attribute]

Defines the standard to which to product has been heat treated.

This item is restricted to the following list.

- HT**
- HTC/NHTNC**
- KD56/30**

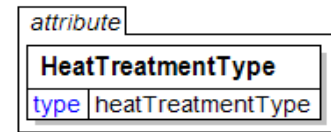

Height

The height of the object. (Used in wood/timber items.)

ActualNominal [attribute]

ActualNominal is optional. A single instance might exist.

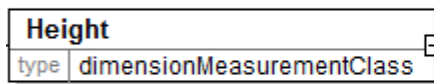

Indicates the measurement approach used to communicate the dimensions of the individual pieces.

Refer to ActualNominal definition for any enumerations.

(choice)

[choice] is mandatory. A single instance is required.

Value

Value is mandatory. A single instance is required.

A numeric value expressed in the unit of measure (UOM).

(sequence)

The sequence of items below is mandatory. A single instance is required.

RangeMin

RangeMin is optional. A single instance might exist.

The minimum value (lower boundary) allowed for the Measurement that is the parent of this element.

RangeMax

RangeMax is optional. A single instance might exist.

The maximum value (upper boundary) allowed for the Measurement that is the parent of this element. Some elements use the RangeMax element with an extended list of unit of measures. (Note: the red colour in the picture is an artifact of how the graphic was captured and should be disregarded.)

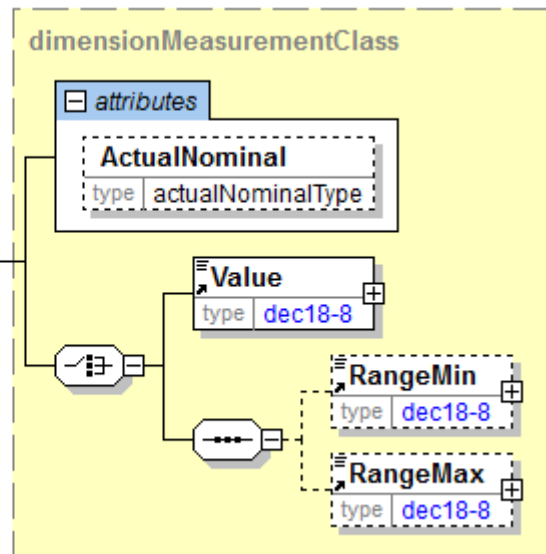

Height

The height of the object.

(sequence)

The sequence of items below is mandatory. A single instance is required.

Value

Value is mandatory. A single instance is required.

A numeric value expressed in the unit of measure (UOM).

RangeMin

RangeMin is optional. A single instance might exist.

The minimum value (lower boundary) allowed for the Measurement that is the parent of this element.

RangeMax

RangeMax is optional. A single instance might exist.

The maximum value (upper boundary) allowed for the Measurement that is the parent of this element. Some elements use the RangeMax element with an extended list of unit of measures. (Note: the red colour in the picture is an artifact of how the graphic was captured and should be disregarded.)

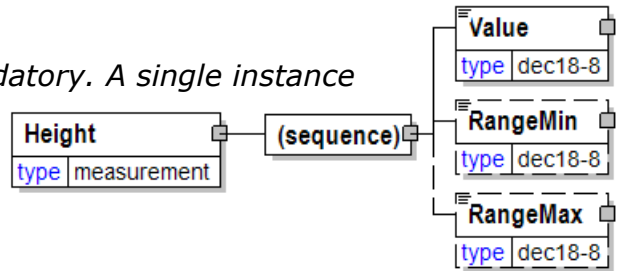

HighlightedPlanningBucket

Provides an indication and information that the planning bucket should be reviewed.

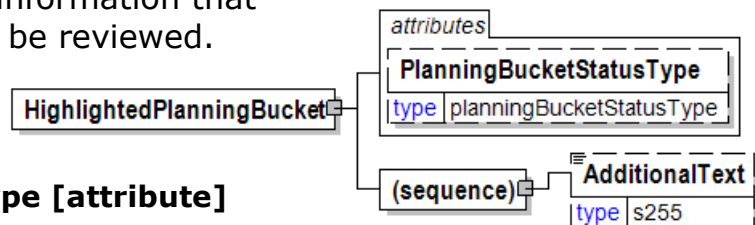

PlanningBucketStatusType [attribute]

PlanningBucketStatusType is optional. A single instance might exist.

Used to identify the Planning bucket's status. Typically used to highlight a change in status to the receiver of the e-Document.

Refer to PlanningBucketStatusType definition for any enumerations.

(sequence)

The sequence of items below is mandatory. A single instance is required.

AdditionalText

AdditionalText is optional. A single instance might exist.

A text field that is used to communicate information not previously defined or for special instructions. To be used only for circumstances not covered by specific elements.

HolePunchInformation

Hole Punch Information.

HolePunchThroughCover [attribute]

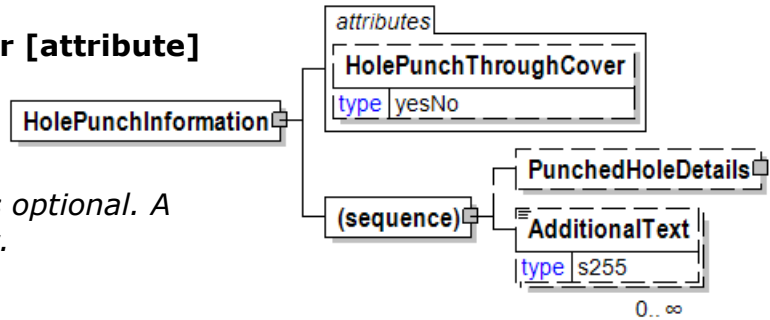

HolePunchThroughCover is optional. A single instance might exist.

Either "Yes" or "No".

Refer to HolePunchThroughCover definition for any enumerations.

(sequence)

The sequence of items below is mandatory. A single instance is required.

PunchedHoleDetails

PunchedHoleDetails is optional. A single instance might exist.

A grouping element that will contain the configuration information for punched holes.

AdditionalText

AdditionalText is optional. Multiple instances might exist.

A text field that is used to communicate information not previously defined or for special instructions. To be used only for circumstances not covered by specific elements.

HolePunchTemplateReference

Hole punch template reference

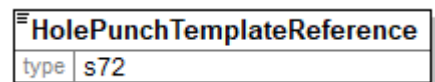

HolePunchThroughCover [attribute]

Either "Yes" or "No".

This item is restricted to the following list.

Yes

No

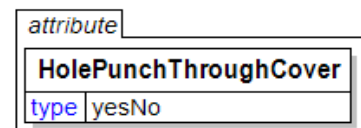

HolePunchType

Hole punch type.

This item is restricted to the following list.

DIN2

DIN4

Finnish

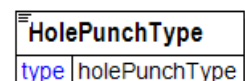

Swedish

Any

HoleReinforcement

Hole reinforcement

This item is restricted to the following list.

Yes

No

HoleReinforcement	
type	yesNo

HoleSpacing

The HoleSpacing element is used to communicate the distance between holes.

(choice)

[choice] is mandatory. A single instance is required.

HoleSpacing	
type	holeSpacing

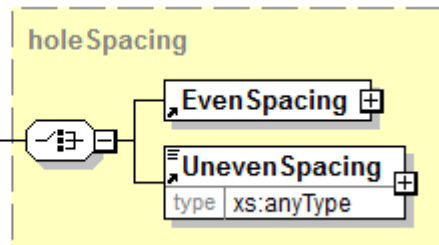

EvenSpacing

EvenSpacing is mandatory. A single instance is required.

The EvenSpacing element is used to communicate the hole-spacing that is equivalent between the holes. The initial spacing between the paper edge and the first hole is handled using the DistanceFromEdge element.

UnevenSpacing

UnevenSpacing is mandatory. A single instance is required.

Uneven Spacing

Hours

A qualifier of DeliveryTransitTime.

Hours	
type	nni6

HSB

A definition of colour using the HSB protocol.

All the components of the definition are required. The structure of Hue, Saturation, and Brilliance follows DetailMeasurement.

TestMethod [attribute]

TestMethod is optional. A single instance might exist.

The method used to determine the results of the test under consideration.

TestAgency [attribute]

TestAgency is optional. A single instance might exist.

The agency that has set the parameters for the testing

Refer to TestAgency definition for any enumerations.

SampleType [attribute]

SampleType is optional. A single instance might exist.

Communicates how sampling was done to measure the product characteristics.

Refer to SampleType definition for any enumerations.

ResultSource [attribute]

ResultSource is optional. A single instance might exist.

Used to define the data source of the specified test

Refer to ResultSource definition for any enumerations.

(sequence)

The sequence of items below is mandatory. A single instance is required.

Hue

Hue is mandatory. A single instance is required.

Measure of colour Hue in the HSB method of communicating colour.

Saturation

Saturation is mandatory. A single instance is required.

Measure of colour Saturation in the HSB method of communicating colour.

Brilliance

Brilliance is mandatory. A single instance is required.

Measure of brilliance in the HSB colour approach.

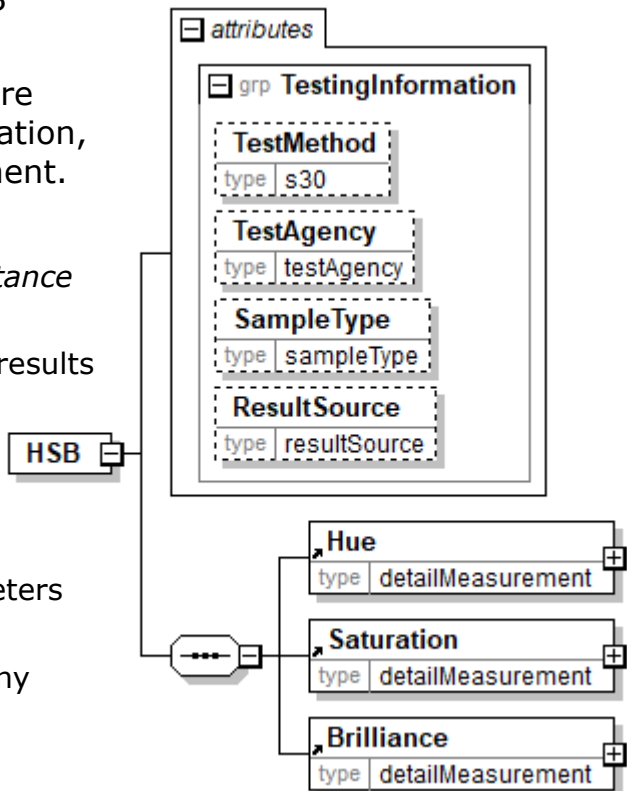

Hue

Measure of colour Hue in the HSB method of communicating colour.

(sequence)

The sequence of items below is mandatory. A single instance is required.

DetailValue

DetailValue is mandatory. A single instance is required.

A numeric value expressed in the unit of measure (UOM).

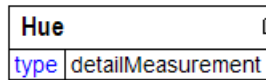

DetailRangeMin

DetailRangeMin is optional. A single instance might exist.

The minimum value (lower boundary) allowed for the DetailValue that is the parent of this element.

DetailRangeMax

DetailRangeMax is optional. A single instance might exist.

The maximum value (upper boundary) allowed for the DetailValue that is the parent of this element.

StandardDeviation

StandardDeviation is optional. A single instance might exist.

A statistic used as a measure of dispersion in a distribution.

SampleSize

SampleSize is optional. A single instance might exist.

The number of samples used to determine the product characteristic in question.

TwoSigmaLower

TwoSigmaLower is optional. A single instance might exist.

Two sigma (a measure of dispersion associated with standard deviation) on the lower side of the standard deviation.

TwoSigmaUpper

TwoSigmaUpper is optional. A single instance might exist.

Two sigma (a measure of dispersion associated with standard deviation) on the upper side of the standard deviation.

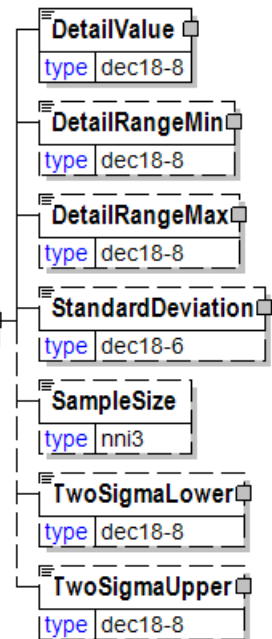

Humidity

Humidity

(sequence)

The sequence of items below is mandatory. A single instance is required.

Value

Value is mandatory. A single instance is required.

A numeric value expressed in the unit of measure (UOM).

RangeMin

RangeMin is optional. A single instance might exist.

The minimum value (lower boundary) allowed for the Measurement that is the parent of this element.

RangeMax

RangeMax is optional. A single instance might exist.

The maximum value (upper boundary) allowed for the Measurement that is the parent of this element. Some elements use the RangeMax element with an extended list of unit of measures. (Note: the red colour in the picture is an artifact of how the graphic was captured and should be disregarded.)

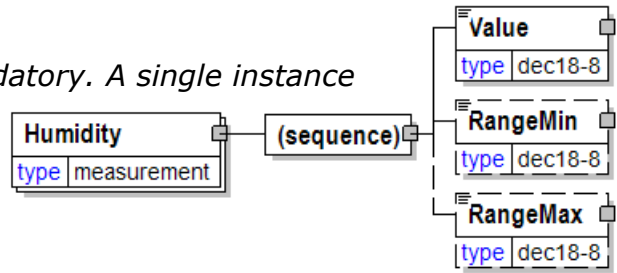

Identifier

An Identifier is required for packages and items (pallets, reel packages, boxes, ream items, reel items, etc). The Identifier element contains the actual item identifier code. Identifier is repeatable so more than one identifier can be communicated. For example, the printed identifier on a label may be different from the barcode printed on the label.

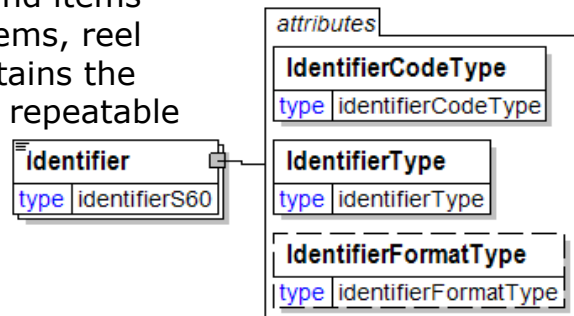

IdentifierCodeType [attribute]

IdentifierCodeType is mandatory. A single instance is required.

Defines the type of product identifier used (for example, reel number, ream number, bar code). This code type specifies how to decode the identifier value.

Refer to IdentifierCodeType definition for any enumerations.

IdentifierType [attribute]

IdentifierType is mandatory. A single instance is required.

This attribute specifies whether the Identifier is the primary way to identify the product or a secondary way. Only one of the given identifiers can be primary. In addition, this attribute also specifies the physical support used to code the identifier (for example, a Radio Frequency (RF) Tag).

Refer to IdentifierType definition for any enumerations.

IdentifierFormatType [attribute]

IdentifierFormatType is optional. A single instance might exist.

IdentifierFormatType defines the technical format used to make an IdentifierCodeType readable by technical devices or humans. The IdentifierCodeType specifies how to decode the identifier value.

Refer to IdentifierFormatType definition for any enumerations.

IdentifierCodeType [attribute]

Defines the type of product identifier used (for example, reel number, ream number, bar code). This code type specifies how to decode the identifier value.



This item is restricted to the following list.

Carrier

Carrier's own identifier coding scheme.

EAN8

To be deprecated in a future version V3R00. GS1 has renamed it to GTIN-8. Use GTIN8 instead.

EAN8Plus2

The content of barcode EAN-8 with a 2 digit add-on.

EAN8Plus5

The content of barcode EAN-8 with a 5 digit add-on.

EAN13

To be deprecated in a future version V3R00. GS1 has renamed it to GTIN-13. Use GTIN13 instead.

EAN13Plus2

The content of barcode EAN-8 with a 2 digit add-on.

EAN13Plus5

The content of barcode EAN-8 with an 5 digit add-on.

EAN13Plus8

To be deprecated in a future version V3R00.

EAN128

To be deprecated in a future version V3R00. GS1 has renamed it to GS1-128. Use GS1_128 instead. See also IdentifierFormatType GS1_128 for more information.

EPC

The EPC is a universal identifier defined by GS1 EPCglobal. It provides a unique identity for any physical object. The EPC is designed to be unique across all physical objects in the world. It is expressly intended for use by business applications that need to track all categories of physical objects.

papiNet V2R31

The identifier within computer systems and business e-documents is the EPC Pure Identity URI. RFID Tags are very often used as data carrier for the EPC. Examples of syntax for some common EPC identifiers

- Serialized Global Trade Item Number (SGTIN):
urn:epc:id:sgtin:CompanyPrefix.ItemReference.SerialNumber
- Serial Shipping Container Code (SSCC):
urn:epc:id:sscc:CompanyPrefix.SerialReference
- Global Returnable Asset Identifier (GRAI):
urn:epc:id:grai:CompanyPrefix.AssetType.SerialNumber

For more information see <http://www.gs1.org/epcglobal>

EPSMA

To be deprecated in a future version V3R00. It is not a specific identifier type. European Pressure Sensitive Manufacturers Association (EPSMA) has specified barcodes with various contents using GS1-128 symbology.

EUGROPA

To be deprecated in a future version V3R00. It is not a specific identifier type. European Paper Merchants Association has specified contents and layout of package labels. They use GS1-128 symbology and barcodes defined by GS1. <http://www.eugropa.com/>

GlobalReturnableAssetNumber

The Global Returnable Asset Identifier (GRAI) defined by GS1 for identification of reusable package or transport equipment that are considered an asset. It is used to enable tracking as well as recording of all relevant data associated with the individual asset or asset reference. The GRAI is assigned for the life time of the asset. <http://www.gs1.org/>

GlobalTradeItemNumber

To be deprecated in a future version V3R00. Use GTIN14 instead.

GS1_128

The content of barcode GS1-128 encoded in GS1-128 symbology defined by GS1. Previously referred to as EAN-128. See also IdentifierFormatType GS1_128 for more information. <http://www.gs1.org/>

GTIN8

An 8 digit identifier GTIN-8 defined by GS1 for trade items, Earlier referred to as European Article Number EAN-8. GTIN-8s will be encoded in an EAN-8 bar code. See also GTIN14 for more information. <http://www.gs1.org/>

GTIN12

A 12 digit identifier GTIN-12 defined by GS1 for trade items, Earlier referred to as Universal Product Code. GTIN-12s can be encoded in UPC-A, UPC-E, ITF-14, or GS1-128 bar codes. GTIN-12 is primarily used in North America. See also GTIN14 for more information. <http://www.gs1us.org/>

GTIN13

A 13 digit identifier GTIN-13 defined by GS1 for trade items, Earlier referred to as European Article Number EAN-13. GTIN-13s can be encoded in EAN-13, ITF-14 or GS1-128 bar codes. See also GTIN14 for more information.

papiNet V2R31

<http://www.gs1.org/>

GTIN14

A 14 digit Global Trade Item Number (GTIN) defined by GS1. It is one of the main building blocks of the GS1 System and is used to uniquely identify trade items, which are products and services that are priced, ordered or invoiced at any point in the supply chain.

GTINs can be 8, 12, 13, or 14 digits in length. GS1 recommends that every GTIN be represented in software applications as 14 digits by right justifying and zero filling left, as appropriate. The following table demonstrates the structure of GTINs in a GTIN-compliant database

Type of GTIN	GTIN Digit													
	1	2	3	4	5	6	7	8	9	10	11	12	13	14
GTIN-8	0	0	0	0	0	0	N	N	N	N	N	N	N	C
GTIN-12	0	0	N	N	N	N	N	N	N	N	N	N	N	C
GTIN-13	0	N	N	N	N	N	N	N	N	N	N	N	N	C
GTIN-14	N	N	N	N	N	N	N	N	N	N	N	N	N	C

<http://www.gs1.org/>

IFRA

The content of IFRA Bar Code using 16 digits and the Interleaved 2/5 symbols.

ISBN10

10 digit ISBN code without dashes

ISBN10Dash

10 digit ISBN code with dashes

ISBN13

13 digit ISBN code without dashes.

ISBN13Dash

13 digit ISBN code with dashes.

Measurer

Measurer's own identifier coding scheme.

NARI

North American Roll Identifier coded on 13 digits, and using the Code 39 symbols.

NPTA

National Paper Trade Association code.

RFTagSerialNumber

The fixed built-in identifier of a RFID unit.

SerialisedShippingContainerCode

The Serial Shipping Container Code (SSCC) defined by GS1 is used to identify

papiNet V2R31

individual logistic unit. A logistic unit can be any combination of units put together in a case or on a pallet or truck where the specific unit load needs to be managed through the supply chain. It is an 18 digit number.

<http://www.gs1.org/>

Supplier

Supplier's own identifier coding scheme.

TAPPI13

TAPPI 13-character identifier coding scheme.

TAPPI9

TAPPI 9-character identifier coding scheme.

UCCEAN128SSCC

To be deprecated in a future version V3R00. Use enumeration `SerialisedShippingContainerCode` instead.

UCCEANMulti

To be deprecated in a future version V3R00. Use enumeration `GS1_128` instead.

UIC14

The CEPI Unit identifier coded on 14 digits. When the CEPI Unit Identifier is used in bar code format, then the symbology must be Code 128C to European Standard EN 799. This is the official European identifier by CEPI. More info at www.cepi.org.

UIC16

To be deprecated in a future version V3R00. Use instead UIC14. UIC16 was the CEPI Unit identifier coded on 16 digits. UIC16 is no longer supported by CEPI.

UPC

To be deprecated in a future version V3R00. GS1 US has defined the UPC code to be a Global Trade Item Number GTIN-12. Use GTIN12 instead. See also `IdentifierFormatType UPC_A` for more information. <http://www.gs1us.org/>

UPC_A

To be deprecated in a future version V3R00. GS1 US has defined the UPC-A code to be a Global Trade Item Number GTIN-12. Use GTIN12 instead. See also `IdentifierFormatType UPC_A` for more information. <http://www.gs1us.org/>

UPC_A_Plus2

The content of barcode UPC-A with a 2 digit add-on.

UPC_A_Plus5

The content of barcode UPC-A with a 5 digit add-on.

UPC_E

To be deprecated in a future version V3R00. GS1 US has defined it to be a Global Trade Item Number GTIN-12 containing leading zeros. Use GTIN12 instead. See also `IdentifierFormatType UPC_E` for more information. <http://www.gs1us.org/>

UPC_E_Plus2

The content of barcode UPC-E with a 2 digit add-on.

UPC_E_Plus5

The content of barcode UPC-E with a 5 digit add-on.

UPC_ShippingContainer

To be deprecated in a future version V3R00. It is the same as a GTIN-14. Use enumeration GTIN14 instead.

IdentifierFormatType [attribute]

IdentifierFormatType defines the technical format used to make an IdentifierCodeType readable by technical devices or humans. The IdentifierCodeType specifies how to decode the identifier value

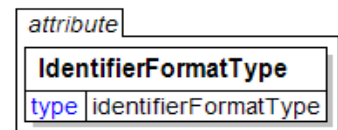

This item is restricted to the following list.

Codabar

CodablockA

CodablockF

Code11

Code16K

Code2/5Beared

Code2/5Industrial

Code2/5Interleaved

Code2/5InterleavedMod10

Code2/5MatrixEurope

Code2/5MatrixJapan

Code2/5Standard

Code39

Code39F.ASCII

Code39Mod43

Code93

Code128Auto-Switching

Code128A

Code128B

Code128C

Code128C(F1Mod10)

Composite

To be deprecated in a future version V3R00.

Datamatrix

Datamatrix is a two-dimensional matrix barcode consisting of black and white "cells" or modules arranged in either a square or rectangular pattern. The information to be encoded can be text or numeric data. It can encode up to 3,116 characters from the entire ASCII character set (with extensions). Data Matrix bar code symbology is specified by ISO/IEC 16022:2006 standard.

EAN8

An 8 digit barcode EAN-8 defined by GS1. Earlier referred to as the European Article Number 8 digit barcode. The EAN-8 is used on small packages where the EAN-13 barcode would be too large. It encodes the Global Trade Item Number (GTIN-8) and is also used by retailers to identify own-brand products sold only in their stores. <http://www.gs1.org/>

EAN8Plus2

An EAN-8 barcode with an additional 2 digit barcode to the right of the main barcode. This second barcode, which is usually not as tall as the primary barcode, is used to encode additional information for newspapers, books, and other periodicals.

EAN8Plus5

An EAN-8 barcode with an additional 5 digit barcode to the right of the main barcode. This second barcode, which is usually not as tall as the primary barcode, is used to encode additional information for newspapers, books, and other periodicals.

EAN13

A 13 digit barcode EAN-8 defined by GS1. Earlier referred to as the European Article Number 13 digit barcode. The EAN-13 is used for marking products often sold at retail point of sale and general distribution. It encodes the Global Trade Item Numbers (GTIN-13). It is used on retail product marking worldwide and by retailers to identify own-brand products sold only in their stores. <http://www.gs1.org/>

EAN13Plus2

An EAN-13 barcode with an additional 2 digit barcode to the right of the main barcode. This second barcode, which is usually not as tall as the primary barcode, is used to encode additional information for newspapers, books, and other periodicals.

EAN13Plus5

An EAN-13 barcode with an additional 5 digit barcode to the right of the main barcode. This second barcode, which is usually not as tall as the primary barcode, is used to encode additional information for newspapers, books, and other periodicals.

EAN13Plus8

To be deprecated in a future version V3R00.

EAN128

To be deprecated in a future version V3R00. GS1 has renamed this barcode to GS1-128. Use enumeration GS1_128 instead.

EPC_GRAI96

papiNet V2R31

A 96-bit encoding of Global Returnable Asset Identifier (GRAI) defined by EPCglobal for use in RFID Tags. It allows for numeric-only serial numbers, without leading zeros, whose value is less than 2^{38} (that is, from 0 through 274,877,906,943, inclusive).

<http://www.gs1.org/gsmp/kc/epcglobal/tds/>

EPC_GRAI170

A 170-bit encoding of Global Returnable Asset Identifier (GRAI) defined by EPCglobal for use in RFID Tags. It allows for the full range of serial numbers up to 16 alphanumeric characters.

<http://www.gs1.org/gsmp/kc/epcglobal/tds/>

EPC_SGTIN96

A 96-bit encoding of Serialized Global Trade Item Number (SGTIN) defined by EPCglobal for use in RFID Tags. It allows for numeric-only serial numbers, without leading zeros, whose value is less than 238 (that is, from 0 through 274,877,906,943, inclusive).

<http://www.gs1.org/gsmp/kc/epcglobal/tds/>

EPC_SGTIN198

A 198-bit encoding of Serialized Global Trade Item Number (SGTIN) defined by EPCglobal for use in RFID Tags. It allows for the full range of serial numbers up to 20 alphanumeric characters.

<http://www.gs1.org/gsmp/kc/epcglobal/tds/>

EPC_SSCC96

A 96-bit encoding of Serial Shipping Container Code (SSCC) defined by EPCglobal for use in RFID Tags. It allows for the full range of SSCCs as specified in GS1 General Specifications.

<http://www.gs1.org/gsmp/kc/epcglobal/tds/>

GS1_128

A 48 alphanumeric capacity barcode GS1-128 defined by GS1. Previously referred to as UCC/EAN-128 or EAN-128 barcode. The GS1-128 uses a series of GS1 Application Identifiers to include additional data such as Best Before Date, Batch/Lot Number, Quantity, Weight and many other attributes.

<http://www.gs1.org/>

HumanReadable

A human readable format is used.

IBM_BC412

IBM_BC412, also known as Binary Code 412, is an alphanumeric symbol with a set of 35 characters, each encoded by a set of 4 bars in 12 module positions. A proprietary IBM symbology since 1988. It is widely used in semiconductor manufacturing. Particularly useful where speed, accuracy, and ease of printing are required.

ITF14

ITF14 is the GS1 implementation of an Interleaved 2 of 5 bar code, also known as Shipping Container Symbol. ITF-14 is used to encode a Global Trade Item Number GTIN-12, GTIN-13 or GTIN-14. ITF-14 symbols are generally used on packaging levels of a product, The ITF-14 will always encode 14 digits. <http://www.gs1.org/>

papiNet V2R31

Logmars

LOGMARS (Logistics Applications of Automated Marking and Reading Symbols) is a special application of Code 39 used by the U.S. Department of Defense and is governed by Military Standard MIL-STD-1189B. The Standard defines acceptable ranges for a number of variables, include density, ratio, bar height, and size of the human-readable interpretation line. The Modulus 43 check digit, optional with Code 39, is defined and recommended in the specification. While not required by the general specification, it may be required in specific Department of Defense applications. Be sure to check the requirements for your project or contract.

MicroPDF14

To be deprecated in a future version V3R00.

PDF417

PDF417 is a stacked linear barcode symbol format. PDF stands for Portable Data File. The 417 signifies that each pattern in the code consists of 4 bars and spaces, and that each pattern is 17 units long. It is used in a variety of applications, primarily transport, identification cards, and inventory management. PDF417 is also selected by the airline industry's Bar Coded Boarding Pass standard (BCBP) as the 2D bar code symbolism for paper boarding passes.

Plessey

Plessey is a 1D linear barcode symbology based on pulse width modulation, developed in 1971 by The Plessey Company plc, a British-based company. It is one of the first barcode symbology and is still used in some rare libraries.

Postnet

POSTNET (Postal Numeric Encoding Technique) is a barcode symbology used by the United States Postal Service to assist in directing mail. The ZIP Code or ZIP+4 code is encoded in half- and full-height bars. Most often, the delivery point is added, usually being the last two digits of the address or PO box number. POSTNET is being replaced by the Intelligent Mail barcode (also known as OneCode Solution), which combines all previous Postal Service barcodes and marking into a single barcode.

QR_Code

QR codes (Quick Response codes) are two-dimensional symbols. The codes have small squares with black and white patterns. A QR code can contain up to 4296 alphanumeric characters. The QR code is defined by ISO/IEC 18004:2006 standard.

RSS

Reduced Space Symbology. GS1 has changed the name to GS1 DataBar due to the potential for confusion with Really Simple Syndication. GS1 DataBar is a family of symbols most commonly seen in the GS1 DataBar Coupon. This family of barcodes include:

- Symbols intended for retail point of sale scanning:
 - o GS1 DataBar Omnidirectional
 - o GS1 DataBar Stacked Omnidirectional
 - o GS1 DataBar Expanded

papiNet V2R31

- o GS1 DataBar Expanded Stacked
- Symbols that are not intended for retail Point-of-Sale scanning:
 - o GS1 DataBar Truncated
 - o GS1 DataBar Limited
 - o GS1 DataBar Stacked

<http://www.gs1.org/>

TLC39

UPC_A

A 12 digit barcode UPC-A defined by GS1 US. The UPC-A uniquely identifies a product for retail checkout. It encodes the Global Trade Item Number (GTIN-12) and is also used by retailers to identify own-brand products sold only in their stores. UPC-A is primarily used in North America. <http://www.gs1us.org/>

UPC_A_Plus2

An UPC-A barcode with an additional 2 digit barcode to the right of the main barcode. This second barcode, which is usually not as tall as the primary barcode, is used to encode additional information for newspapers, books, and other periodicals.

UPC_A_Plus5

An UPC-A barcode with an additional 5 digit barcode to the right of the main barcode. This second barcode, which is usually not as tall as the primary barcode, is used to encode additional information for newspapers, books, and other periodicals.

UPC_E

An 8 digit barcode UPC-E defined by GS1 US. The UPC-E is a compressed barcode which is intended for use on small items where the full 12-digit UPC-A may not fit. Compression works by squeezing extra zeros out of the barcode and then automatically re-inserting them at the scanner. Only GTIN-12 containing zeros are candidates for the UPC-E symbol. When reading UPC-E, results are returned as uncompressed GTIN-12. UPC-E is primarily used in North America. <http://www.gs1us.org/>

UPC_E_Plus2

An UPC-E barcode with an additional 2 digit barcode to the right of the main barcode. This second barcode, which is usually not as tall as the primary barcode, is used to encode additional information for newspapers, books, and other periodicals.

UPC_E_Plus5

An UPC-E barcode with an additional 5 digit barcode to the right of the main barcode. This second barcode, which is usually not as tall as the primary barcode, is used to encode additional information for newspapers, books, and other periodicals.

UCCEAN128SSCC

To be deprecated in a future version V3R00. The Serial Shipping Container Code (SSCC) is encoded in barcode GS1-128. Use enumeration GS1_128

instead.

UCCEAN128Multi

To be deprecated in a future version V3R00. Multiple information items can be encoded in barcode GS1-128. Use enumeration GS1_128 instead.

UPC_ShippingContainer

To be deprecated in a future version V3R00. Use enumeration ITF-14 instead.

Other

IdentifierType [attribute]

This attribute specifies whether the Identifier is the primary way to identify the product or a secondary way. Only one of the given identifiers can be primary. In addition, this attribute also specifies the physical support used to code the identifier (for example, a Radio Frequency (RF) Tag).

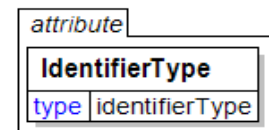

This item is restricted to the following list.

Barcode

The physical support used to code the identifier is a bar code.

CorrelationID

Correlation ID

Primary

This article Identifier is the primary identifier used.

RFTag

The physical support used to code the identifier is a Radio Frequency Tag.

Secondary

This article Identifier is the secondary identifier used.

Impressions

The work produced by one revolution of the printing cylinder or unit.

(sequence)

The sequence of items below is mandatory. A single instance is required.

Value

Value is mandatory. A single instance is required.

A numeric value expressed in the unit of measure (UOM).

RangeMin

RangeMin is optional. A single instance might exist.

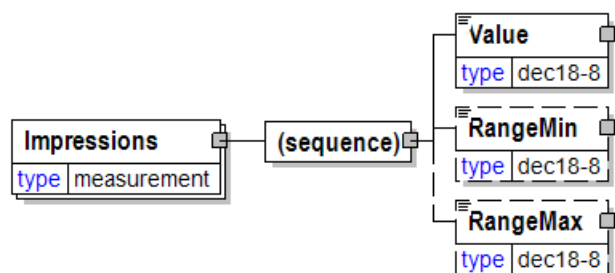

The minimum value (lower boundary) allowed for the Measurement that is the parent of this element.

RangeMax

RangeMax is optional. A single instance might exist.

The maximum value (upper boundary) allowed for the Measurement that is the parent of this element. Some elements use the RangeMax element with an extended list of unit of measures. (Note: the red colour in the picture is an artifact of how the graphic was captured and should be disregarded.)

Incoterms [attribute]

The Incoterms consist of a number official international trade terms defined by International Chamber of Commerce (ICC) plus an additional term called Other. Actual trade terms used are depending on the version of the Incoterms. The Incoterms define the responsibilities of buyers and sellers for delivery under a sales contract. They provide definitions for delivery points, loading and unloading obligations, and customs clearance. (<https://iccwbo.org>)

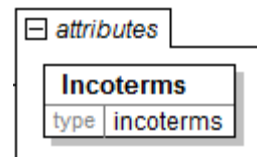

This item is restricted to the following list.

CFR

COST AND FREIGHT (... named port of destination)

CIF

COST, INSURANCE AND FREIGHT (... named port of destination).

CIP

CARRIAGE AND INSURANCE PAID TO (... named place of destination).

CPT

CARRIAGE PAID TO (... named place of destination).

DAF

DELIVERED AT FRONTIER (... named place).

DAP

DELIVERED AT PLACE (... named place of destination).

DAT

DELIVERED AT TERMINAL (... named place of destination).

DDP

DELIVERED DUTY PAID (... named place of destination).

DDU

DELIVERED DUTY UNPAID (... named place of destination).

DEQ

DELIVERED EX QUAY (... named port of destination).

DES

papiNet V2R31

DELIVERED EX SHIP (... named port of destination).

DPU

DELIVERED AT PLACE UNLOADED (... named place of destination).

EXW

EX WORKS (... named place).

FAS

FREE ALONGSIDE SHIP (... named port of shipment).

FCA

FREE CARRIER (... named place).

FOB

FREE ON BOARD (... named port of shipment).

Other

Used when the situation is not covered by the 13 official Incoterms (for example, CIN used in Switzerland for CIP).

IncotermsLocation

Named place linked to terms of delivery showing the place where goods are to be delivered.

Incoterms [attribute]

Incoterms is mandatory. A single instance is required.

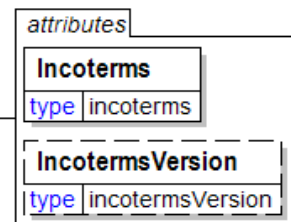
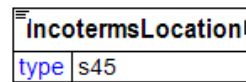

The Incoterms consist of a number official international trade terms defined by International Chamber of Commerce (ICC) plus an additional term called Other. Actual trade terms used are depending on the version of the Incoterms. The Incoterms define the responsibilities of buyers and sellers for delivery under a sales contract. They provide definitions for delivery points, loading and unloading obligations, and customs clearance. (<https://iccwbo.org>).

Refer to Incoterms definition for any enumerations.

IncotermsVersion [attribute]

IncotermsVersion is optional. A single instance might exist.

The version of the Incoterms codes used.

Refer to IncotermsVersion definition for any enumerations.

IncotermsVersion [attribute]

The version of the Incoterms codes used.

This item is restricted to the following list.

1980

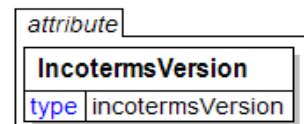

The incoterms definitions provided in 1980.

1990

The incoterms definitions provided in 1990.

2000

The incoterms definitions provided in 2000.

2010

The incoterms definitions provided in 2010.

2020

The incoterms definitions provided in 2020.

20xx

20xx should not be used in new implementations. It will be deprecated in a future version V3R00.

IncrementalOrderQuantity

An incremental quantity and units of measure that is added to MinimumOrderQuantity to arrive at an order quantity.

(sequence)

The sequence of items below is mandatory. A single instance is required.

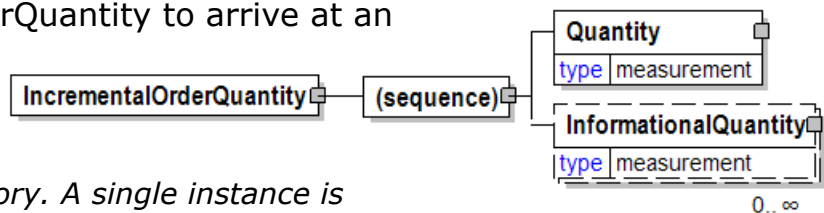

Quantity

Quantity is mandatory. A single instance is required.

The Quantity element contains attributes that provide information about the type of quantity that is being communicated, the context in which the particular quantity is to be viewed, and (if the quantity represents an adjustment) an adjustment type.

The Quantity element contains three child elements that enable you to communicate a range of values for the quantity and a target or actual value. It is at this level (Value, RangeMin, and RangeMax) that the unit of measure is specified. This permits the range to be specified in a different unit of measure than the target.

InformationalQuantity

InformationalQuantity is optional. Multiple instances might exist.

A quantity given in a valid UOM used for information purposes only (not for calculation). For example, an ordered quantity was 100 reels as opposed to the invoice quantity of 20,000 pounds.

IncrementalValue

Many times paper is produce in BasisWeights of discreet values. This element permits the expression of those increments.

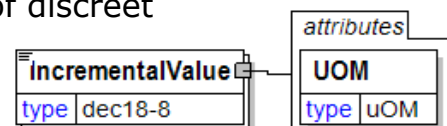

UOM [attribute]

UOM is mandatory. A single instance is required.

Defines the unit of measure for the value.

Refer to UOM definition for any enumerations.

The sequence of items below is mandatory. A single instance is required.

RequestNumber

RequestNumber is mandatory. A single instance is required.

A unique tracking number specifically identifying the InfoRequest e-Document to the originator. The tracking number is returned with the "information", the answer, to help match the answer to the request.

InfoRequestIssueDate

InfoRequestIssueDate is optional. A single instance might exist.

The date and time when InfoRequest e-Document was issued.

RequestingParty

RequestingParty is mandatory. A single instance is required.

The party requesting the information.

RespondToParty

RespondToParty is mandatory. One instance is required, multiple instances might exist.

The party the document should be responded to.

SenderParty

SenderParty is optional. A single instance might exist.

The business entity issuing the e-Document, the source of the document.

The entity responsible for the content. If the sender party has out sourced the message service to a third party the SenderParty is the issuer of the e-Document and not the party performing the transmission service of the electronic message.

ReceiverParty

ReceiverParty is optional. Multiple instances might exist.

The business entity for whom the e-Document is intended, the destination of the document.

The entity interested in the content. If the receiver party has outsourced the message service to a third party the ReceiverParty is the intended party for the e-Document and not the party performing the receiving service of the electronic message.

OtherParty

OtherParty is optional. Multiple instances might exist.

An organisation or business entity other than those specifically detailed within an e-Document.

(choice)

[choice] is mandatory. A single instance is required.

InventoryStatusRequestDetail

InventoryStatusRequestDetail is mandatory. A single instance is required.

A grouping element that provides the parameters to be used when responding with an InventoryStatus e-Document.

OrderStatusRequestDetail

OrderStatusRequestDetail is mandatory. A single instance is required.

A grouping element that provides the parameters to be used when responding with an OrderStatus e-Document.

AvailabilityStatusRequestDetail

AvailabilityStatusRequestDetail is mandatory. A single instance is required.

A grouping element that provides the parameters to be used when responding with an Availability e-Document.

PlanningRequestDetail

PlanningRequestDetail is mandatory. A single instance is required.

A grouping element that provides the parameters to be used when responding with a Planning e-Document.

ProductQualityRequestDetail

ProductQualityRequestDetail is mandatory. A single instance is required.

A grouping element that provides the parameters to be used when responding with a ProductQuality e-Document.

ShippingInstructionsRequestDetail

ShippingInstructionsRequestDetail is mandatory. A single instance is required.

A grouping element that provides the parameters to be used when responding with a ShippingInstructions e-Document.

ShipmentStatusRequestDetail

ShipmentStatusRequestDetail is mandatory. A single instance is required.

A grouping element that provides the parameters to be used when responding with a ShipmentStatus e-Document.

StatementRequestDetail

StatementRequestDetail is mandatory. A single instance is required.

A grouping element that provides the parameters to be used when responding with a Statement e-Document.

CalendarRequestDetail

CalendarRequestDetail is mandatory. A single instance is required.

A grouping element that provides the parameters to be used when responding with a Calendar e-Document.

ProductAttributesRequestDetail

ProductAttributesRequestDetail is mandatory. A single instance is required.

A grouping element that provides the parameters to be used when responding with a ProductAttributes e-Document.

MeasuringTicketRequestDetail

MeasuringTicketRequestDetail is mandatory. A single instance is required.

A grouping element that provides the parameters to be used when responding with a MeasuringTicket e-Document.

PreflightRequestDetail

PreflightRequestDetail is mandatory. A single instance is required.

A grouping element that provides the parameters to be used when responding with a Preflight e-Document.

InfoRequestIssueDate

The date and time when InfoRequest e-Document was issued.

(sequence)

The sequence of items

below is mandatory. A single instance is required.

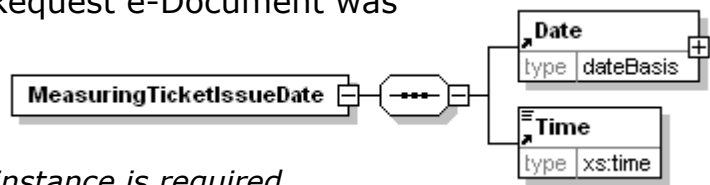

Date

Date is mandatory. A single instance is required.

A group element that contains the specification of Year, Month, and Day.

Time

Time is mandatory. A single instance is required.

Times are treated in a standard XML fashion with a special case used to indicate a generalized "local" time. The standard XML approach to time is hh:mm:ss, hh:mm:ssZ, or hh:mm:ss±hh:mm.

- hh:mm:ss±hh:mm is used to represent a time with a time zone. The time zone is communicated as the number of hours offset from the Universal Time Coordinate (UTC), a.k.a. Greenwich Mean Time.
- hh:mm:ssZ indicates the time at Zulu (another name for UTC).
- hh:mm:ss or hh:mm indicates within papiNet the applicable local time where the associated event is taking place. Caution should be used when processing times of this nature as the papiNet approach may be in discord with other users of XML.

InfoRequestType [attribute]

An attribute designed to indicate which response e-Document is expected in response to the InfoRequest e-Document.



This item is restricted to the following list.

Availability

The sender is requesting Availability information.

Calendar

The sender is requesting Calendar information.

InventoryStatus

The sender is requesting InventoryStatus information.

MeasuringTicket

The sender is requesting MeasuringTicket information.

OrderStatus

The sender is requesting OrderStatus information.

Planning

The sender is requesting Planning information.

Preflight

The sender is requesting Preflight information.

ProductAttributes

The sender is requesting ProductAttributes information.

ProductQuality

The sender is requesting ProductQuality information.

ShipmentStatus

The sender is requesting ShipmentStatus information.

ShippingInstructions

The sender is requesting ShippingInstructions information.

Statement

The sender is requesting a Statement.

InformationalAmount

A monetary amount used for information purposes only (not for calculation). For example, the invoice price adjustment subtotal is expressed in sterling pounds, and the buyer wants this information expressed in U.S. dollars.

CreditDebitNote and Invoice - The TaxAmount is displayed in the currency that is applicable throughout the e-Document. When a TaxAmount needs to be displayed in a different national currency, this field is used.

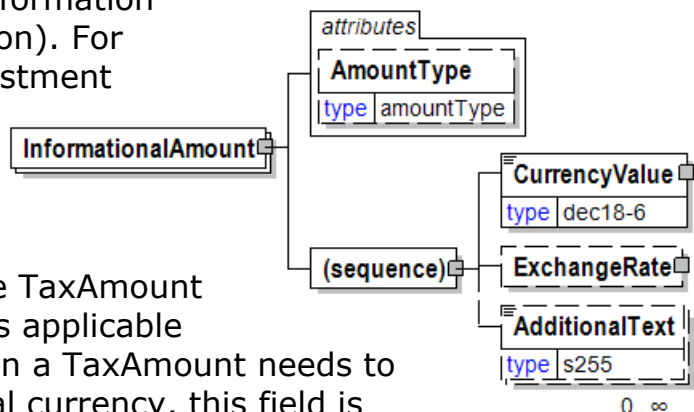

AmountType [attribute]

AmountType is optional. A single instance might exist.

Defines the type of amount.

Refer to AmountType definition for any enumerations.

(sequence)

The sequence of items below is mandatory. A single instance is required.

CurrencyValue

CurrencyValue is mandatory. A single instance is required.

The amount in the referenced currency as defined by the CurrencyType attribute.

ExchangeRate

ExchangeRate is optional. A single instance might exist.

The exchange rate as of the date included in the element.

AdditionalText

AdditionalText is optional. Multiple instances might exist.

A text field that is used to communicate information not previously defined or for special instructions. To be used only for circumstances not covered by specific elements.

InformationalPricePerUnit

A group item containing a currency value and a measurement value used convey a secondary PricePerUnit. For example, where PricePerUnit is dollars per ton. InformationalPricePerUnit could be dollars per kilogram.

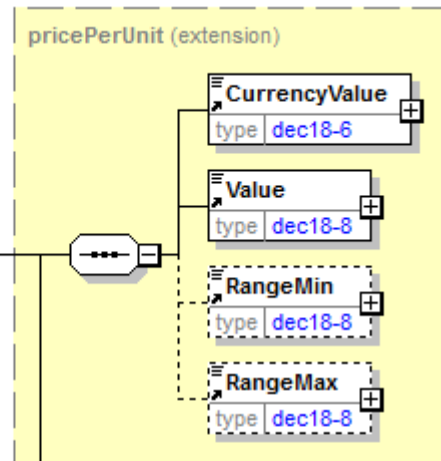
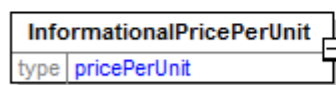

InformationalPricePerUnitType [attribute]

Defines what type of Price is being supplied.

Refer to InformationalPricePerUnit for any enumerations

(sequence)

The sequence of items below is mandatory. A single instance is required.

CurrencyValue

CurrencyValue is mandatory. A single instance is required.

The amount in the referenced currency as defined by the CurrencyType attribute.

Value

Value is mandatory. A single instance is required.

A numeric value expressed in the unit of measure (UOM).

RangeMin

RangeMin is optional. A single instance might exist.

The minimum value (lower boundary) allowed for the Measurement that is the parent of this element.

RangeMax

RangeMax is optional. A single instance might exist.

The maximum value (upper boundary) allowed for the Measurement that is the parent of this element. Some elements use the RangeMax element with an extended list of unit of measures. (Note: the red colour in the picture is an artifact of how the graphic was captured and should be disregarded.)

(sequence)

The sequence of items below is mandatory. A single instance is required.

Country

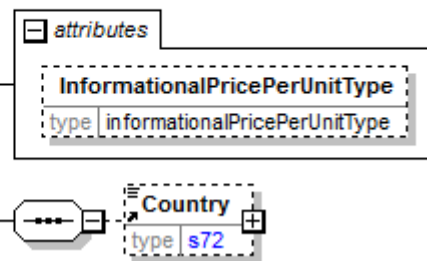

Country is optional. A single instance might exist.

The name of the country associated with the address elements. To ensure reliable matching of addresses, it is suggested to use the attribute ISOCountryCode as well.

InformationalPricePerUnitType [attribute]

Defines what type of Price is being supplied.

This item is restricted to the following list.

AlternatePrice

Alternate price calculated by the Buyer.

CoverPrice

Price that appears on the cover of a book.

ProductPrice

Price for the product specified in the Product element in the e-Document.

ProductionPrice

Price calculated by the Buyer's Production department.

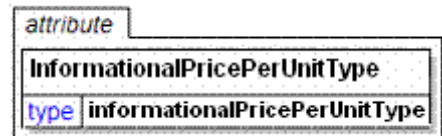

InformationalQuantity

A quantity given in a valid UOM used for information purposes only (not for calculation). For example, an ordered quantity was 100 reels as opposed to the invoice quantity of 20,000 pounds.

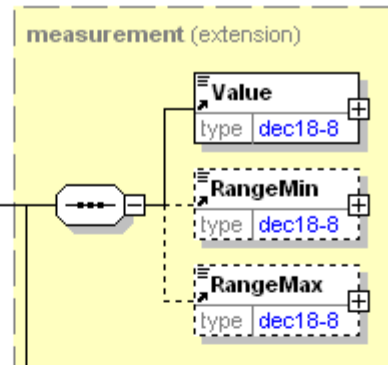

QuantityType [attribute]

QuantityType is mandatory. A single instance is required.

QuantityType communicates information about the type of quantity being communicated and how the receiver might use the information.

Refer to QuantityType definition for any enumerations.

QuantityTypeContext [attribute]

QuantityTypeContext is optional. A single instance might exist.

Provides the location in the value chain where the quantity is being reported.

Refer to QuantityTypeContext definition for any enumerations.

AdjustmentType [attribute]

AdjustmentType is optional. A single instance might exist.

Describes the type of adjustment associated with a quantity.

Refer to AdjustmentType definition for any enumerations.

MeasuringMethodType [attribute]

MeasuringMethodType is optional. A single instance might exist.

Specifies how a measurement value is created.

Refer to MeasuringMethodType definition for any enumerations.

MeasuringAgency [attribute]

MeasuringAgency is optional. A single instance might exist.

The agency defining measuring methods.

Refer to MeasuringAgency definition for any enumerations.

MeasuringMethod [attribute]

MeasuringMethod is optional. A single instance might exist.

The method used to determine how the item under consideration is measured. Measuring methods are defined by the measuring agency.

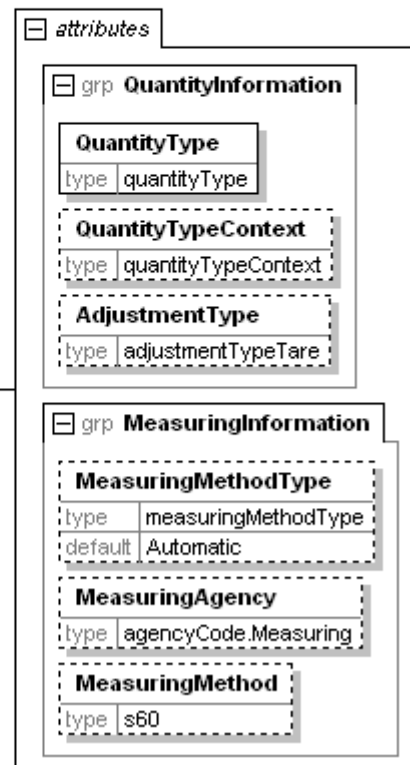

(sequence)

The sequence of items below is mandatory. A single instance is required.

Value

Value is mandatory. A single instance is required.

A numeric value expressed in the unit of measure (UOM).

RangeMin

RangeMin is optional. A single instance might exist.

The minimum value (lower boundary) allowed for the Measurement that is the parent of this element.

RangeMax

RangeMax is optional. A single instance might exist.

The maximum value (upper boundary) allowed for the Measurement that is the parent of this element. Some elements use the RangeMax element with an extended list of unit of measures. (Note: the red colour in the picture is an artifact of how the graphic was captured and should be disregarded.)

Ink

A grouping element that describes the ink used in the process.

(sequence)

The sequence of items below is mandatory. A single instance is required.

InkManufacturer

InkManufacturer is optional. A single instance might exist.

Company that produced the ink used in the job.

ColourCode

ColourCode is optional. A single instance might exist.

A code indicating the colour.

InkTack

InkTack is optional. A single instance might exist.

The stickiness of the ink.

InkViscosity

InkViscosity is optional. A single instance might exist.

The measured thickness of the ink.

FountainSolutionpH

FountainSolutionpH is optional. A single instance might exist.

Measurement of the acidic properties of the fountain solution.

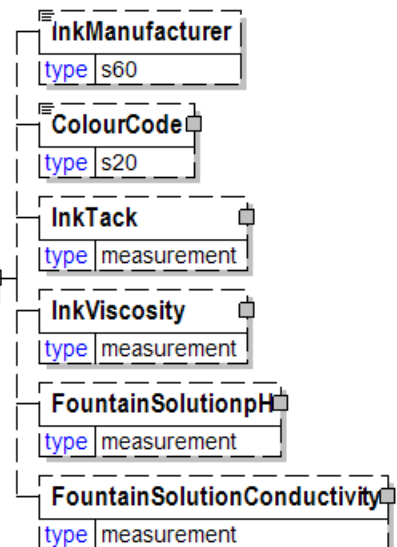
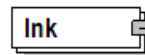

FountainSolutionConductivity

FountainSolutionConductivity is optional. A single instance might exist.

Electrical measure of fountain solution measured in micro – siemens.

InkCharacteristics

The ink characteristics.

(sequence)

The sequence of items below is mandatory. A single instance is required.

InkCoverage

InkCoverage is optional. Multiple instances might exist.

InkCoverage in InkCharacteristics will be deprecated in a future version V3R00. Use the instance of InkCoverage found in ColourSpecs.

NumberOfColours

NumberOfColours is mandatory. A single instance is required.

The number of colours

ColourSpecs

ColourSpecs is mandatory.

Colour specs

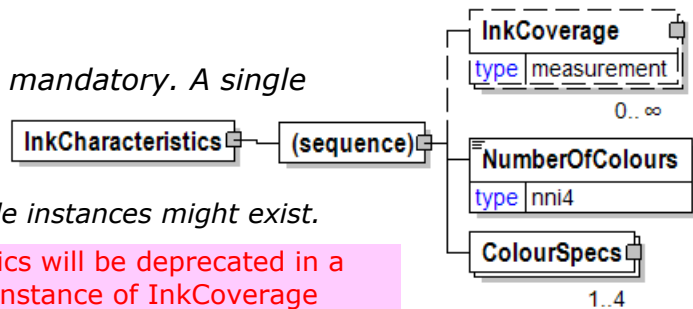

InkCoverage

Ink coverage

InkCoverageType [attribute]

InkCoverageType is optional. A single instance might exist.

Ink coverage type

Refer to InkCoverageType definition for any enumerations.

(sequence)

The sequence of items below is mandatory. A single instance is required.

Value

Value is mandatory. A single instance is required.

A numeric value expressed in the unit of measure (UOM).

RangeMin

RangeMin is optional. A single instance might exist.

The minimum value (lower boundary) allowed for the Measurement that is the parent of this element.

RangeMax

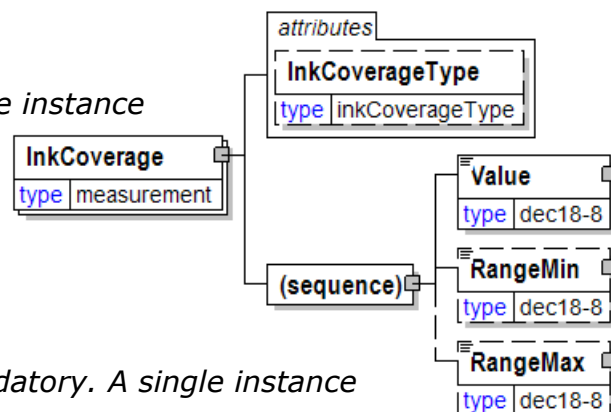

papiNet V2R31

RangeMax is optional. A single instance might exist.

The maximum value (upper boundary) allowed for the Measurement that is the parent of this element. Some elements use the RangeMax element with an extended list of unit of measures. (Note: the red colour in the picture is an artifact of how the graphic was captured and should be disregarded.)

InkCoverageType [attribute]

Ink coverage type

This item is restricted to the following list.

AcrossFlap

FullBackground

Illustrations



InkDelivery

The delivery mechanism used in the printing process.

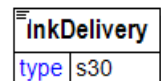

InkManufacturer

Company that produced the ink used in the job.

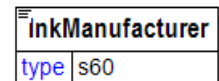

InkTack

The stickiness of the ink.

(sequence)

The sequence of items below is mandatory. A single instance is required.

Value

Value is mandatory. A single instance is required.

A numeric value expressed in the unit of measure (UOM).

RangeMin

RangeMin is optional. A single instance might exist.

The minimum value (lower boundary) allowed for the Measurement that is the parent of this element.

RangeMax

RangeMax is optional. A single instance might exist.

The maximum value (upper boundary) allowed for the Measurement that is the parent of this element. Some elements use the RangeMax element with an

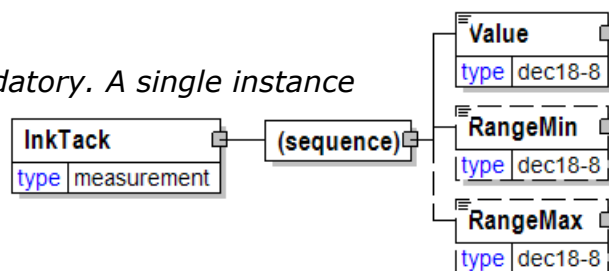

papiNet V2R31

extended list of unit of measures. (Note: the red colour in the picture is an artifact of how the graphic was captured and should be disregarded.)

InkTypeDescription

Ink type description

InkTypeDescription	
type	s30

InkViscosity

The measured thickness of the ink.

(sequence)

The sequence of items below is mandatory. A single instance is required.

Value

Value is mandatory. A single instance is required.

A numeric value expressed in the unit of measure (UOM).

RangeMin

RangeMin is optional. A single instance might exist.

The minimum value (lower boundary) allowed for the Measurement that is the parent of this element.

RangeMax

RangeMax is optional. A single instance might exist.

The maximum value (upper boundary) allowed for the Measurement that is the parent of this element. Some elements use the RangeMax element with an extended list of unit of measures. (Note: the red colour in the picture is an artifact of how the graphic was captured and should be disregarded.)

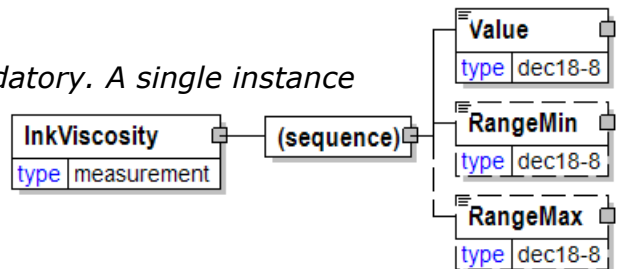

InlayCardQuantity [attribute]

Inlay card quantity

This item is restricted to the following list.

0

There are zero inlay cards.

1

There is one inlay card.

2

There are two inlay cards.

attribute	
InlayCardQuantity	
type	inlayCardQuantity

InsertReference

Insert reference

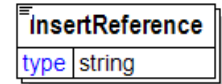

InstructionByType [attribute]

Provides the type for how goods are identified on group level when instructed for loading or delivery.

This item is restricted to the following list.

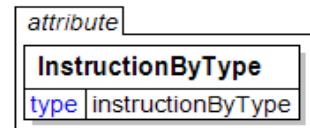

ByMillOrder

Goods are identified on group level by mill order and mill order line item.

ByProduct

Goods are identified on group level by a product specification with all required product details.

ByPurchaseOrder

Goods are identified on group level by PurchaseOrder and PurchaseOrder line item.

Insurance

Group element containing information about insurance

(sequence)

The sequence of items below is mandatory. A single instance is required.

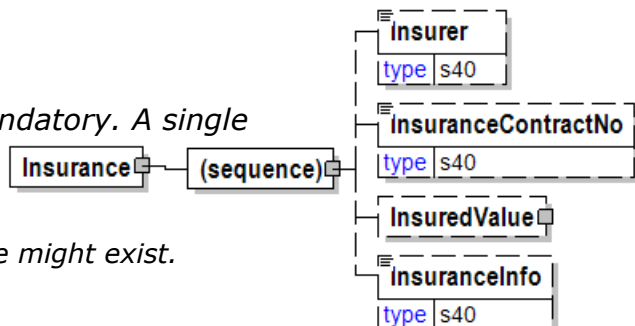

Insurer

Insurer is optional. A single instance might exist.

Name of the insurer

InsuranceContractNo

InsuranceContractNo is optional. A single instance might exist.

Insurance contract number

InsuredValue

InsuredValue is optional. A single instance might exist.

The amount the goods are insured for.

InsuranceInfo

InsuranceInfo is optional. A single instance might exist.

Any addition information about the insurance

InsuranceContractNo

Insurance contract number

InsuranceContractNo	
type	s40

InsuranceInfo

Any addition information about the insurance

InsuranceInfo	
type	s40

InsuredValue

The amount the goods are insured for.

(sequence)

The sequence of items below is mandatory. A single instance is required.

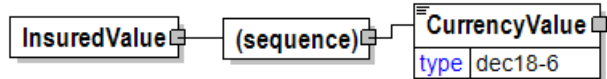

CurrencyValue

CurrencyValue is mandatory. A single instance is required.

The amount in the referenced currency as defined by the CurrencyType attribute.

Insurer

Name of the insurer

insurer	
type	s40

InventoryChange

The InventoryChange element is the root element for the InventoryChange e-Document.

The purpose of the InventoryChange e-Document is to inform involved parties about changes in the inventory at a specific location. The e-Document provides information allowing the receiving party to update their systems for cost tracking, performance, and financial reporting.

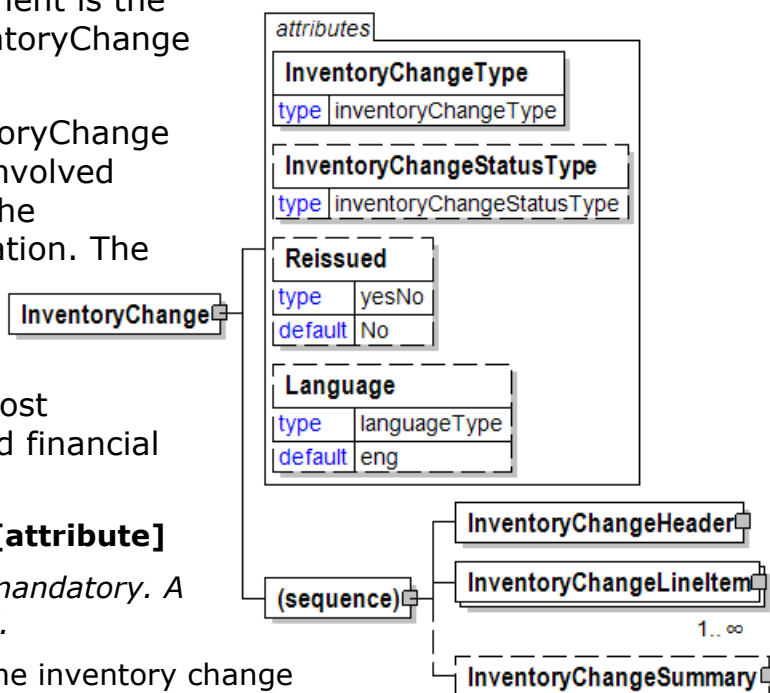

InventoryChangeType [attribute]

InventoryChangeType is mandatory. A single instance is required.

Identifies the reason for the inventory change

Refer to InventoryChangeType definition for any enumerations.

InventoryChangeStatusType [attribute]

InventoryChangeStatusType is optional. A single instance might exist.

Defines the status of the entire InventoryChange e-Document at root level

Refer to InventoryChangeStatusType definition for any enumerations.

Reissued [attribute]

Reissued is optional. A single instance might exist.

Either "Yes" or "No".

Refer to Reissued definition for any enumerations.

Language [attribute]

Language is optional. A single instance might exist.

The valid Alpha 2- and Alpha 3-character list of language codes in the ISO 639-1 and 639-2 international standards.

Information on the content of this attribute is available at:
https://www.loc.gov/standards/iso639-2/php/code_list.php

(sequence)

The sequence of items below is mandatory. A single instance is required.

InventoryChangeHeader

InventoryChangeHeader is mandatory. A single instance is required.

Common information that applies to the entire InventoryChange e-Document.

InventoryChangeLineItem

InventoryChangeLineItem is mandatory. One instance is required, multiple

instances might exist.

The detail information for a given InventoryChange item.

InventoryChangeSummary

InventoryChangeSummary is optional. A single instance might exist.

Summary information that applies to the entire InventoryChange e-Document.

InventoryChangeHeader

Common information that applies to the entire InventoryChange e-Document.

(sequence)

The sequence of items below is mandatory. A single instance is required.

InventoryChangeIssuedDate

InventoryChangeIssuedDate is mandatory. A single instance is required.

The Date and Time when the InventoryChange was issued.

TransactionHistoryNumber

TransactionHistoryNumber is optional. A single instance might exist.

A sequential number that keeps track of the version of a document.

However when the document is a confirmation document, in which case the TransactionHistoryNumber refers to the trigger transaction for the confirmation.

InventoryChangeNumber

InventoryChangeNumber is mandatory. A single instance is required.

An identifier allowing the InventoryChange to be uniquely identified.

InventoryChangeReason

InventoryChangeReason is optional. A single instance might exist.

The reason for the inventory change.

LocationParty

LocationParty is mandatory.

The organization or business entity where the business event took place or will take place.

OtherParty

OtherParty is optional. Multiple instances might exist.

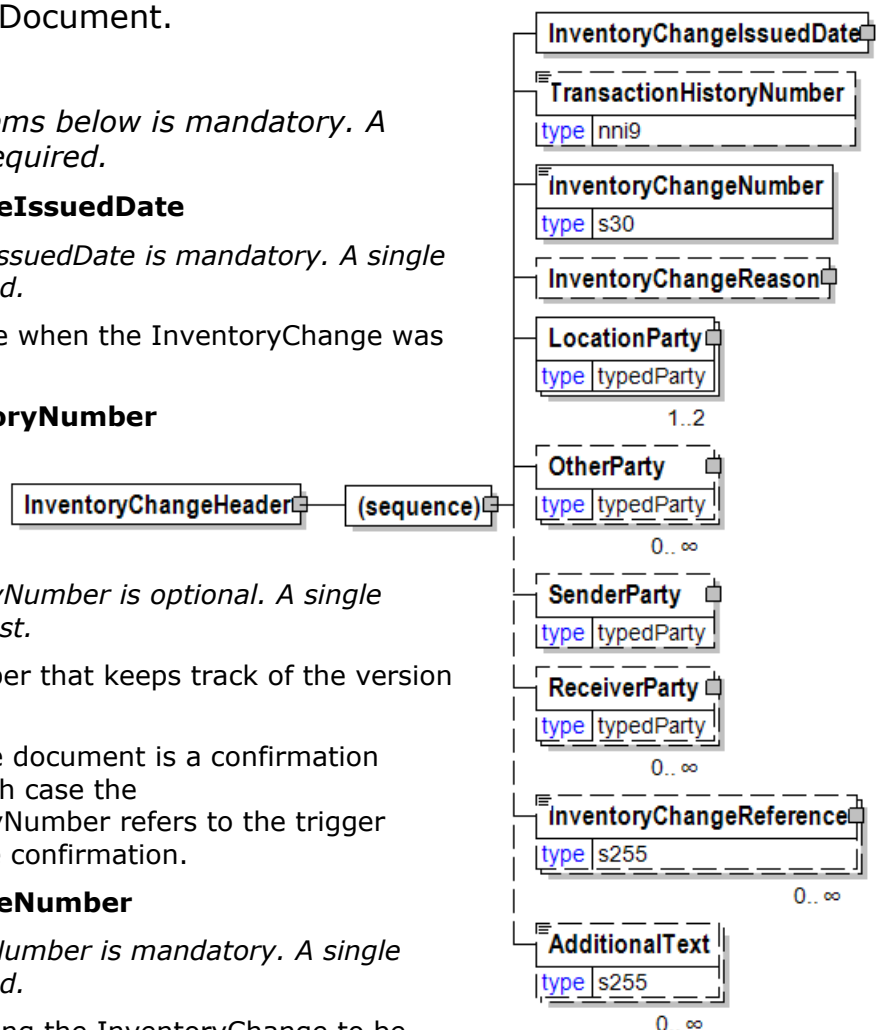

An organisation or business entity other than those specifically detailed within an e-Document.

SenderParty

SenderParty is optional. A single instance might exist.

The business entity issuing the e-Document, the source of the document.

The entity responsible for the content. If the sender party has out sourced the message service to a third party the SenderParty is the issuer of the e-Document and not the party performing the transmission service of the electronic message.

ReceiverParty

ReceiverParty is optional. Multiple instances might exist.

The business entity for whom the e-Document is intended, the destination of the document.

The entity interested in the content. If the receiver party has outsourced the message service to a third party the ReceiverParty is the intended party for the e-Document and not the party performing the receiving service of the electronic message.

InventoryChangeReference

InventoryChangeReference is optional. Multiple instances might exist.

An element detailing relevant references (such as contract number) pertaining to the InventoryChange, identified by InventoryChangeReferenceType.

AdditionalText

AdditionalText is optional. Multiple instances might exist.

A text field that is used to communicate information not previously defined or for special instructions. To be used only for circumstances not covered by specific elements.

InventoryChangeIssuedDate

The Date and Time when the InventoryChange was issued.

(sequence)

The sequence of items below is mandatory. A single instance is required.

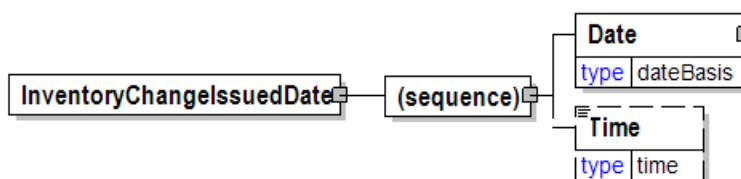

Date

Date is mandatory. A single instance is required.

A group element that contains the specification of Year, Month, and Day.

Time

Time is optional. A single instance might exist.

Times are treated in a standard XML fashion with a special case used to indicate a generalized "local" time. The standard XML approach to time is hh:mm:ss, hh:mm:ssZ, or hh:mm:ss±hh:mm.

hh:mm:ss±hh:mm is used to represent a time with a time zone. The time zone is communicated as the number of hours offset from the Universal Time

papiNet V2R31

Coordinate (UTC), a.k.a. Greenwich Mean Time.

hh:mm:ssZ indicates the time at Zulu (another name for UTC).

hh:mm:ss or hh:mm indicates within papiNet the applicable local time where the associated event is taking place. Caution should be used when processing times of this nature as the papiNet approach may be in discord with other users of XML.

InventoryChangeLineItem

The detail information for a given InventoryChange item.

(sequence)

The sequence of items below is mandatory. A single instance is required.

InventoryChangeLineItemNumber

InventoryChangeLineItemNumber is mandatory. A single instance is required.

An identifier for the InventoryChangeLineItem.

(sequence)

The sequence of items below is optional. A single instance might exist.

PurchaseOrderInformation

PurchaseOrderInformation is mandatory. A single instance is required.

A group item containing information unique to this

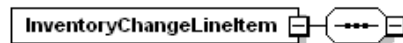

PurchaseOrder, which is provided by the buyer. PurchaseOrderInformation can be optional in the supply chain. Invoices are created without having a PurchaseOrder in Vendor Managed Inventory. Freight invoices also will not have a PurchaseOrder number.

PurchaseOrderLineItemNumber

PurchaseOrderLineItemNumber is optional. A single instance might exist.

The sequential number that uniquely identifies the PurchaseOrder line item.

Product

Product is optional. A single instance might exist.

Product is a group item defining the article and its characteristics. Product is used to specify product characteristics organized by ProductIdentifier, ProductDescription, and Classification. Book Manufacturing, Label Stock, Paper, Pulp, Recovered Paper, Wood Products, and Virgin Fibre market segments have defined their product characteristics and conversion features for implementation in papiNet.

MillParty

MillParty is optional. A single instance might exist.

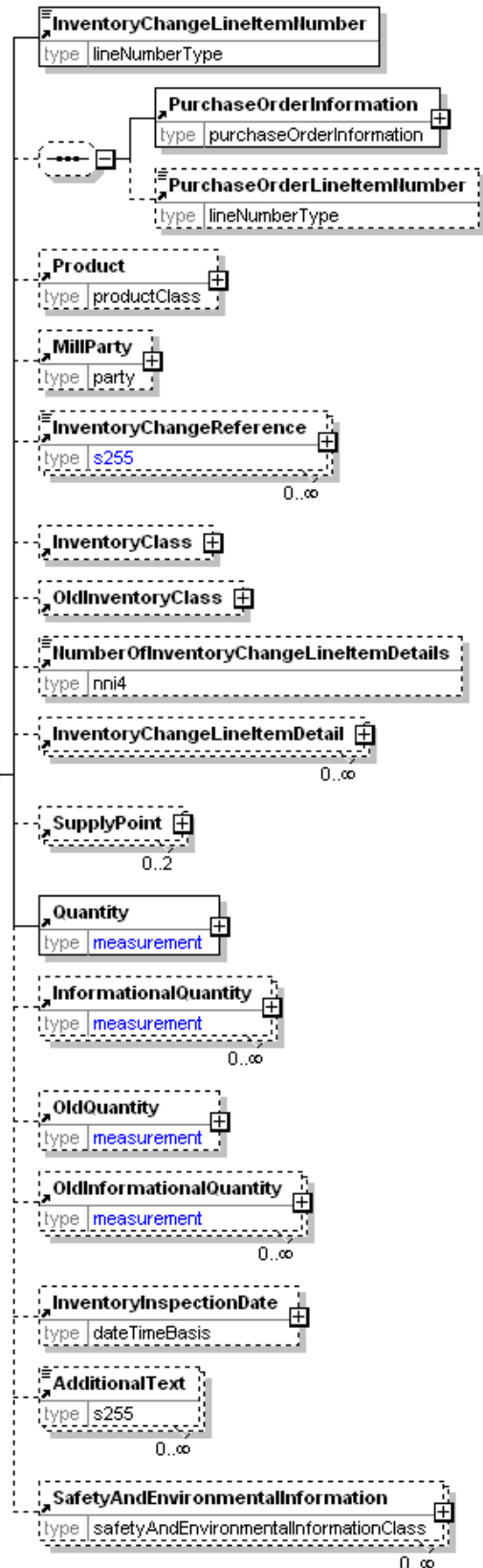

The organisation or business entity that actually produces the product.

InventoryChangeReference

InventoryChangeReference is optional. Multiple instances might exist.

An element detailing relevant references (such as contract number) pertaining to the InventoryChange, identified by InventoryChangeReferenceType.

InventoryClass

InventoryClass is optional. A single instance might exist.

A group item containing information about status of inventory and goods items.

OldInventoryClass

OldInventoryClass is optional. A single instance might exist.

A group item containing information about what the InventoryClass was prior to the event described taking place.

NumberOfInventory ChangeLineItemDetails

*NumberOfInventory
ChangeLineItemDetails is optional. A single instance might exist.*

The number of InventoryChangeLineItemDetail elements included in the InventoryChangeLineItem.

InventoryChangeLineItemDetail

InventoryChangeLineItemDetail is optional. Multiple instances might exist.

Unit level details associated with the InventoryChange.

SupplyPoint

SupplyPoint is optional. Two instances might exist.

Grouping element that contains items describing a supply point. A SupplyPoint belongs to a LocationParty, e.g. in a DeliveryOrigin or DeliveryDestination, and describes where goods are stored and can be loaded or unloaded. A SupplyPoint can for example be a loading or unloading gate at a warehouse or a road side landing at a logging area in the forest.

Quantity

Quantity is mandatory. A single instance is required.

The Quantity element contains attributes that provide information about the type of quantity that is being communicated, the context in which the particular quantity is to be viewed, and (if the quantity represents an adjustment) an adjustment type.

The Quantity element contains three child elements that enable you to communicate a range of values for the quantity and a target or actual value. It is at this level (Value, RangeMin, and RangeMax) that the unit of measure is specified. This permits the range to be specified in a different unit of measure than the target.

InformationalQuantity

InformationalQuantity is optional. Multiple instances might exist.

A quantity given in a valid UOM used for information purposes only (not for calculation). For example, an ordered quantity was 100 reels as opposed to the invoice quantity of 20,000 pounds.

OldQuantity

OldQuantity is optional. A single instance might exist.

What the Quantity was prior to the event described taking place

OldInformationalQuantity

OldInformationalQuantity is optional. Multiple instances might exist.

What the InformationalQuantity was prior to the event described taking place.

InventoryInspectionDate

InventoryInspectionDate is optional. A single instance might exist.

The physical inspection Date and Time of inventory.

AdditionalText

AdditionalText is optional. Multiple instances might exist.

A text field that is used to communicate information not previously defined or for special instructions. To be used only for circumstances not covered by specific elements.

SafetyAndEnvironmentalInformation

SafetyAndEnvironmentalInformation is optional. Multiple instances might exist.

Name of certification type, if any, on the goods (For example, FSC, PEFC). SafetyAndEnvironmental needs a value or measurement to communicate the percentage of the product is certified (for example, 75% is certified by the indicated agency).

InventoryChangeLineItemDetail

Unit level details associated with the InventoryChange.

ChangeDetailType [attribute]

ChangeDetailType is optional. A single instance might exist.



Specifies how a package is changed.

Refer to ChangeDetailType definition for any enumerations.

(sequence)

The sequence of items below is mandatory. A single instance is required.

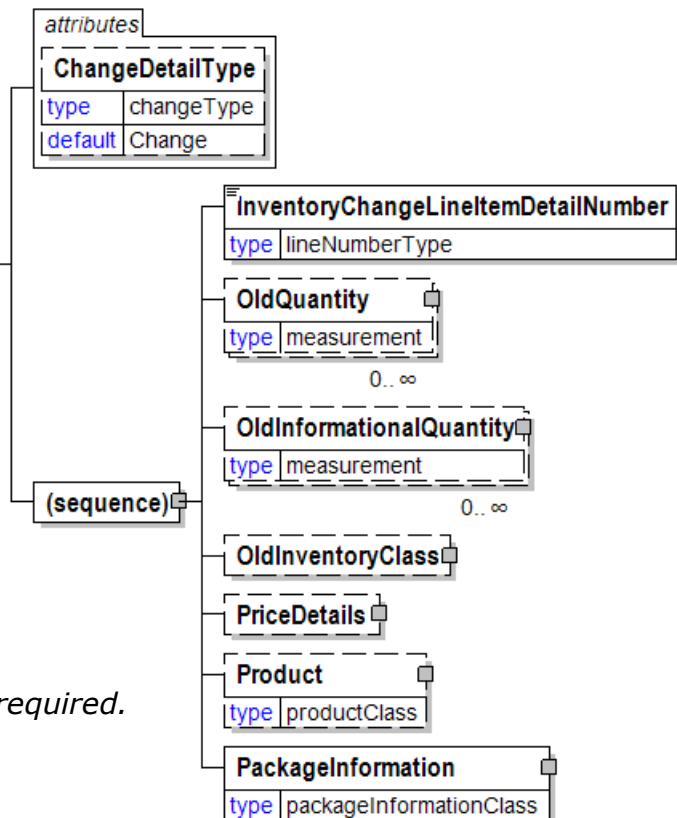

InventoryChangeLineItemDetailNumber

InventoryChangeLineItemDetailNumber is mandatory. A single instance is required.

papiNet V2R31

An identifier allowing the line item to be uniquely identified.

OldQuantity

OldQuantity is optional. Multiple instances might exist.

What the Quantity was prior to the event described taking place

OldInformationalQuantity

OldInformationalQuantity is optional. Multiple instances might exist.

What the InformationalQuantity was prior to the event described taking place.

OldInventoryClass

OldInventoryClass is optional. A single instance might exist.

A group item containing information about what the InventoryClass was prior to the event described taking place.

PriceDetails

PriceDetails is optional. A single instance might exist.

An element that groups together price information.

Product

Product is optional. A single instance might exist.

Product is a group item defining the article and its characteristics. Product is used to specify product characteristics organized by ProductIdentifier, ProductDescription, and Classification. Book Manufacturing, Label Stock, Paper, Pulp, Recovered Paper, Wood Products, and Virgin Fibre market segments have defined their product characteristics and conversion features for implementation in papiNet.

PackageInformation

PackageInformation is mandatory. A single instance is required.

The purpose of the PackageInformation structure is to clearly identify physical handling items that constitute the delivery.

PackageInformation is the highest level of product packaging it describes the shipping or warehousing unit.

If you are communicating a package, usually for logistics or transport purposes, you should include the PackageType, Identifier, ItemCount, and Quantity. (Note: you still have the ability to describe the item with one of the "named" items.)

If you are communicating one of the named Items there is no need to include PackageType, Identifier, ItemCount, and Quantity.

Since either of these two approaches can be used the entire contents of this element are optional even though the parent may be required. It is expected that you will fill in the appropriate details.

InventoryChangeLineItemDetailNumber

An identifier allowing the line item to be uniquely identified.

InventoryChangeLineItemDetailNumber
type lineNumberType

InventoryChangeLineNumber

An identifier for the InventoryChangeLineItem.

InventoryChangeLineItemNumber
type lineNumberType

InventoryChangeNumber

An identifier allowing the InventoryChange to be uniquely identified.

InventoryChangeNumber
type s30

InventoryChangeReason

The reason for the inventory change.

(sequence)

The sequence of items below is mandatory.

A single instance is required.

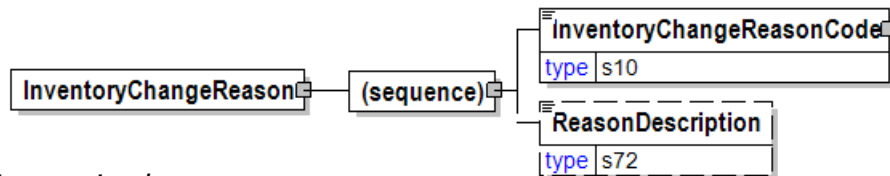

InventoryChangeReasonCode

InventoryChangeReasonCode is mandatory. A single instance is required.

A code representing the reason for the inventory change, identified by Agency.

ReasonDescription

ReasonDescription is optional. A single instance might exist.

Text associated with a particular ReasonIdentifier

InventoryChangeReasonCode

A code representing the reason for the inventory change, identified by Agency.

Agency [attribute]

Agency is mandatory. A single instance is required.

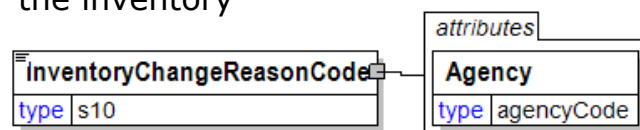

Describes the agency maintaining the list of codes. To be included in this list the agency must be a recognized standards body or industry organisation.

- For the element that owns this attribute.
- For another attribute in the list of attributes associated with the parent element.

Refer to Agency definition for any enumerations.

InventoryChangeReference

An element detailing relevant references (such as contract number) pertaining to the

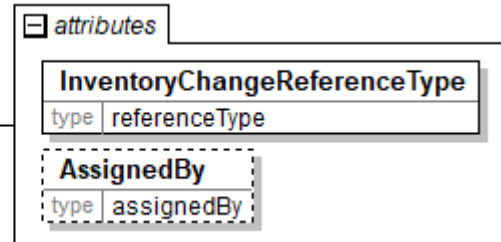
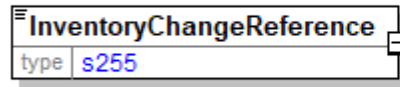

InventoryChange, identified by InventoryChangeReferenceType.

InventoryChangeReferenceType [attribute]

InventoryChangeReferenceType is mandatory. A single instance is required.

Provides a contextual explanation of the specific reference identifier. Many items are currently prefixed by "Buyer", "Forwarder", "Manufacturer", "Mill", "Seller", "Supplier", "Warehouse", or "Vendor". Check for an existing non-prefixed version and use the non-prefixed version instead. In the (yet to be announced release date) version 3.0 the prefixed versions will be removed. Instead the attribute @AssignedBy will communicate the information previously communicated in the prefix.

Refer to InventoryChangeReferenceType definition for any enumerations.

AssignedBy [attribute]

AssignedBy is optional. A single instance might exist.

Identifies the type of party or the agency that has assigned the associated item, e.g. a reference of type OrderNumber.

Refer to AssignedBy for any enumerations.

InventoryChangeReferenceType [attribute]

Provides a contextual explanation of the specific reference identifier. Many items are currently prefixed by "Buyer", "Forwarder", "Manufacturer", "Mill", "Seller", "Supplier", "Warehouse", or "Vendor". Check for an

existing non-prefixed version and use the non-prefixed version instead. In the (yet to be announced release date) version 3.0 the prefixed versions will be removed. Instead the attribute @AssignedBy will communicate the information previously communicated in the prefix.

Refer to the [referenceType](#) entry for the list of enumerations and their definitions.

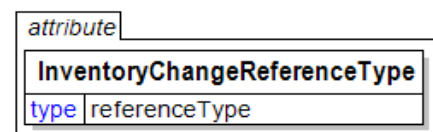

InventoryChangeStatusType [attribute]

Defines the status of the entire InventoryChange e-Document at root level

This item is restricted to the following list.



Cancelled

The supplied information has been cancelled. Items that have been cancelled are not included in totals on the summary levels of the e-Document.

Original

The supplied information is the first version of that information.

Replaced

The supplied information is replacing earlier supplied information. The receiver should revalidate the information in their system based upon the entire information received.

InventoryChangeSummary

Summary information that applies to the entire InventoryChange e-Document.

(sequence)

The sequence of items below is mandatory. A single instance is required.

TotalNumberOfLineItems

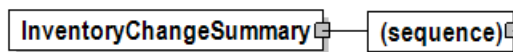

TotalNumberOfLineItems is optional. A single instance might exist.

The total number of individual line items in the document, regardless of the status or type.

(sequence)

The sequence of items below is mandatory. One instance is required, multiple instances might exist.

TotalQuantity

TotalQuantity is mandatory. A single instance is required.

The total quantity of similar items in the e-Document. TotalQuantity is primarily used in the summary section of documents where it is repeatable to permit totaling for different units of measure.

TotalInformationalQuantity

TotalInformationalQuantity is optional. Multiple instances might exist.

A quantity that is used to communicate related information about the parent element. This element represents a total that is derived from individual line items.

(sequence)

The sequence of items below is optional. Multiple instances might exist.

TotalOldQuantity

TotalOldQuantity is mandatory. A single instance is required.

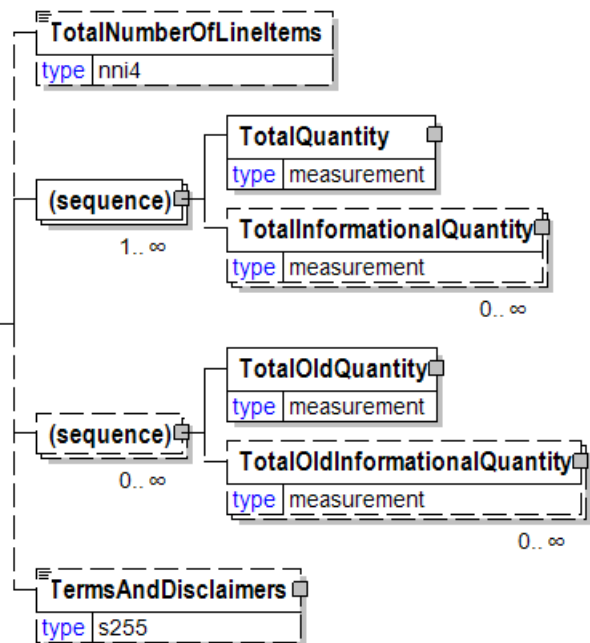

A summary of the OldQuantity in the document. TotalOldQuantity uses the QuantityInformation attribute group and the Measurement group (element grouping).

TotalOldInformationalQuantity

TotalOldInformationalQuantity is optional. Multiple instances might exist.

A summary of the OldInformationQuantity in the document.

TotalOldInformationalQuantity uses the QuantityInformation attribute group and the Measurement group (element grouping).

TermsAndDisclaimers

TermsAndDisclaimers is optional. A single instance might exist.

An element that contains legal information with an indication of what the Language is.

InventoryChangeType [attribute]

Identifies the reason for the inventory change

This item is restricted to the following list.



Buy

The material has been purchased

Classification

The inventory change is due to a change in classification

Conversion

InventoryTransfer

The material has been transferred

LocationTransfer

The material has been moved

OwnershipTransfer

The party owning the material is being changed.

QualityReject

The change is due to rejection.

Rewrapping

The material has been rewrapped

Sell

The material has been sold

SiteDamage

Damage has taken place at the storage site.

StockCount

TransitDamage

Damage has taken place in transit.

Waste

The quantity is being changed due to spoilage or waste of material.

InventoryClass

A group item containing information about status of inventory and goods items.

InventoryStatusType [attribute]

InventoryStatusType is optional. A single instance might exist.

Provides the status type for inventory/goods belonging to a product and/or an order.

Refer to InventoryStatusType definition for any enumerations.

InventoryOwnedBy [attribute]

InventoryOwnedBy is optional. A single instance might exist.

Specifies who is the owner of the inventory/goods.

Refer to InventoryOwnedBy definition for any enumerations.

(sequence)

The sequence of items below is mandatory. A single instance is required.

(sequence)

The sequence of items below is optional. Multiple instances might exist.

InventoryClassCode

InventoryClassCode is mandatory. A single instance is required.

A code specifying the inventory and goods status. Classification of statuses can be done on multiple levels indicated by InventoryClassLevel.

InventoryClassDescription

InventoryClassDescription is optional. Multiple instances might exist.

A description of the inventory class.

AdditionalText

AdditionalText is optional. Multiple instances might exist.

A text field that is used to communicate information not previously defined or for special instructions. To be used only for circumstances not covered by specific elements.

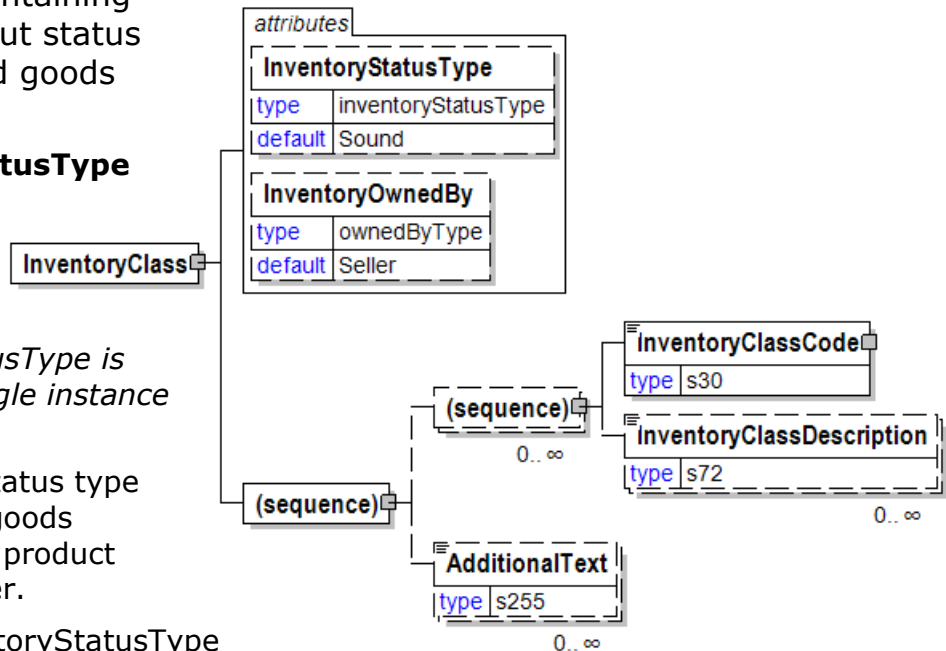

InventoryClassCode

A code specifying the inventory and goods status. Classification of statuses can be done on multiple levels indicated by InventoryClassLevel.

Agency [attribute]

Agency is mandatory. A single instance is required.

Describes the agency maintaining the list of codes. To be included in this list the agency must be a recognized standards body or industry organisation.

- For the element that owns this attribute.
- For another attribute in the list of attributes associated with the parent element.

Refer to Agency definition for any enumerations.

InventoryClassLevel [attribute]

InventoryClassLevel is optional. A single instance might exist.

The non-zero sequential number that uniquely identifies the level of stacked Inventory Class Codes. The lowest level is assigned number 1.

E.g. On level 1 "Damaged" can be given as an inventory class code while details on damages can be specified with inventory class codes on level 2.

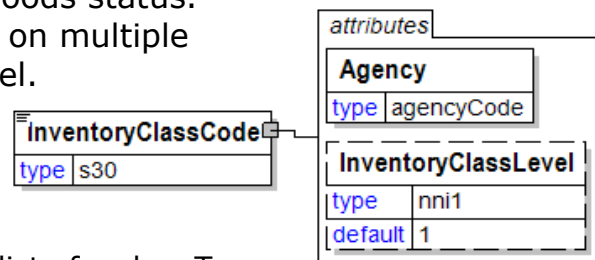

InventoryClassDescription

A description of the inventory class.

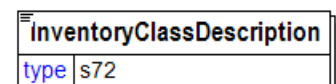

InventoryClassLevel [attribute]

The non-zero sequential number that uniquely identifies the level of stacked Inventory Class Codes. The lowest level is assigned number 1.

E.g. On level 1 "Damaged" can be given as an inventory class code while details on damages can be specified with inventory class codes on level 2.

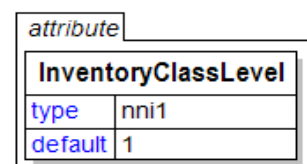

InventoryDispositionInstructions

The

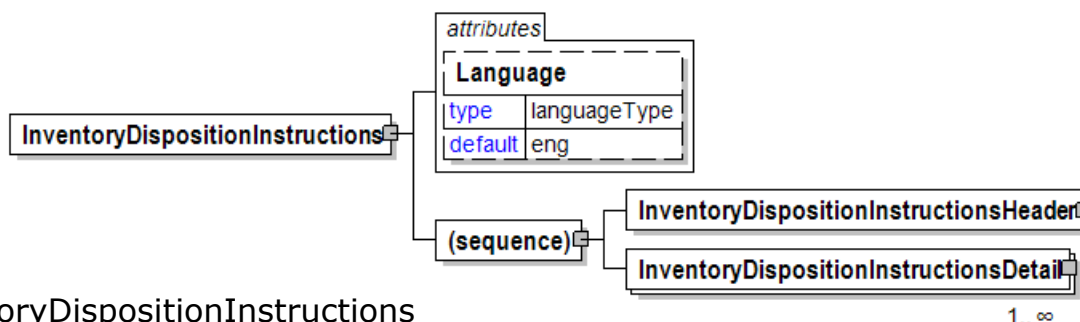

InventoryDispositionInstructions element is the root element for the InventoryDispositionInstructions e-Document.

The InventoryDispositionInstructions e-Document permits the owner of inventory stored at a third party location to request the inventory be destroyed, shipped to another location, held in inventory, or physically changed. The receiving party makes the requested changes to the inventory and sends an InventoryChange and ShippingInstructions, if required, to the requestor so their systems can be updated.

Language [attribute]

Language is optional. A single instance might exist.

The valid Alpha 2- and Alpha 3-character list of language codes in the ISO 639-1 and 639-2 international standards.

Information on the content of this attribute is available at:
https://www.loc.gov/standards/iso639-2/php/code_list.php

(sequence)

The sequence of items below is mandatory. A single instance is required.

InventoryDispositionInstructionsHeader

InventoryDispositionInstructionsHeader is mandatory. A single instance is required.

Provides information that is common for the instructions on how to dispose of problematic inventory.

InventoryDispositionInstructionsDetail

InventoryDispositionInstructionsDetail is mandatory. One instance is required, multiple instances might exist.

InventoryDispositionInstructionsDetail provides information about the product to be disposed of and the method of disposal.

InventoryDispositionInstructionsDetail

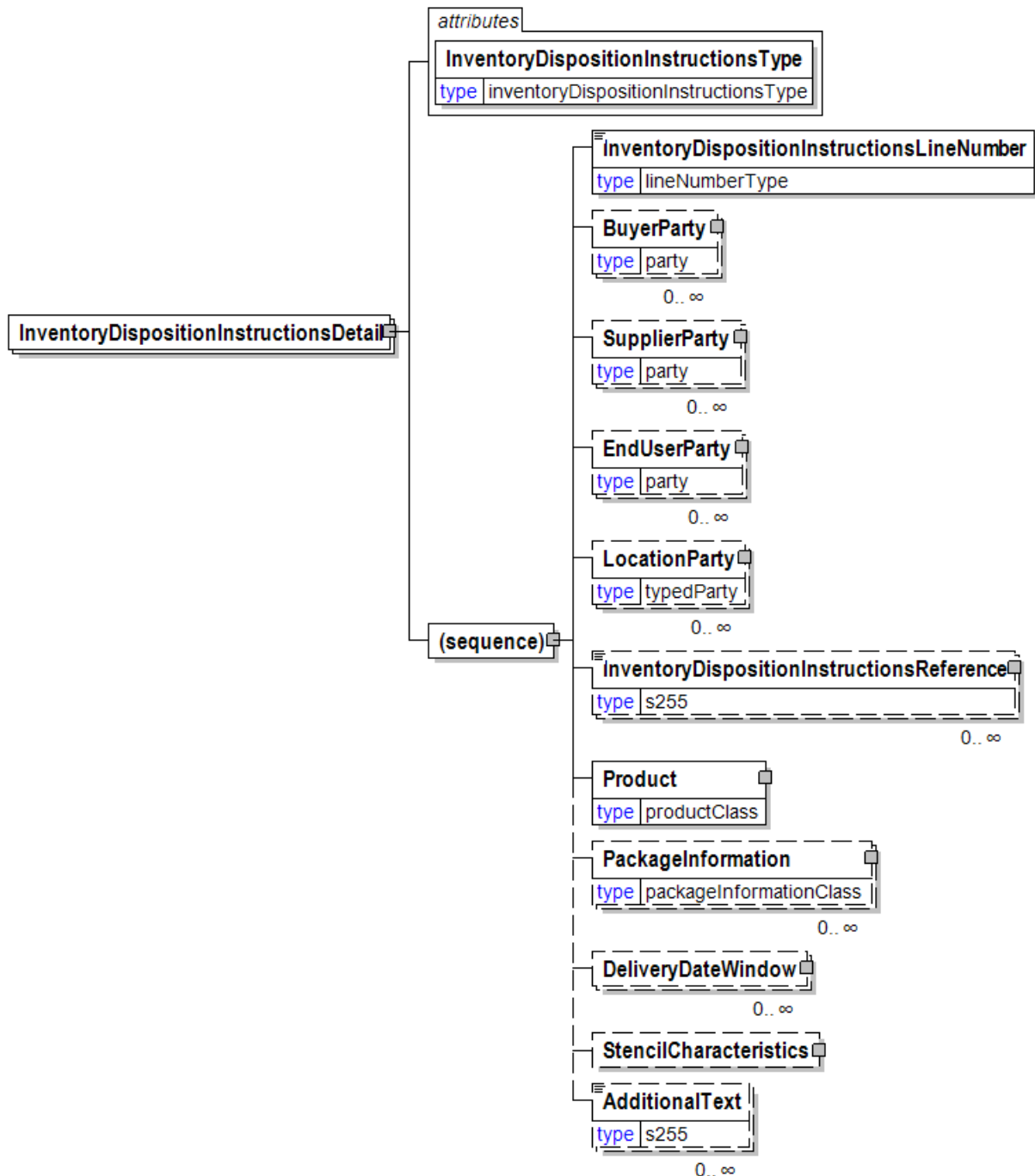

InventoryDispositionInstructionsDetail provides information about the product to be disposed of and the method of disposal.

InventoryDispositionInstructionsType [attribute]

InventoryDispositionInstructionsType is mandatory. A single instance is required.

Indicates the type of inventory disposition that is required. As this attribute is at the line level multiple dispositions can be communicated in a single e-Document.

Refer to InventoryDispositionInstructionsType definition for any enumerations.

(sequence)

The sequence of items below is mandatory. A single instance is required.

InventoryDispositionInstructionsLineNumber

InventoryDispositionInstructionsLineNumber is mandatory. A single instance is required.

The sequential number that uniquely identifies the InventoryDispositionInstructions line item.

BuyerParty

BuyerParty is optional. Multiple instances might exist.

The legal entity to which the product is sold. Also commonly referred to as the sold-to party or customer. If no OtherParty is defined as the Payer, the Buyer is the Payer.

SupplierParty

SupplierParty is optional. Multiple instances might exist.

The organisation or business entity responsible for providing the product. SupplierParty is also the seller of the product, if Seller is not specified as OtherParty = Seller.

EndUserParty

EndUserParty is optional. Multiple instances might exist.

The party using, consuming, or converting the product. For example, a printer using paper reels for a print job for a publisher. The final ShipTo destination for a product is normally to the end user's facilities.

LocationParty

LocationParty is optional. Multiple instances might exist.

The organization or business entity where the business event took place or will take place.

InventoryDispositionInstructionsReference

InventoryDispositionInstructionsReference is optional. Multiple instances might exist.

Contains references that pertain to the InventoryDispositionInstructions e-Document.

Product

Product is mandatory. A single instance is required.

Product is a group item defining the article and its characteristics. Product is used to specify product characteristics organized by ProductIdentifier, ProductDescription, and Classification. Book Manufacturing, Label Stock, Paper, Pulp, Recovered Paper, Wood Products, and Virgin Fibre market segments have defined their product characteristics and conversion features for implementation in papiNet.

PackageInformation

PackageInformation is optional. Multiple instances might exist.

The purpose of the PackageInformation structure is to clearly identify physical handling items that constitute the delivery.

PackageInformation is the highest level of product packaging it describes the shipping or warehousing unit.

papiNet V2R31

If you are communicating a package, usually for logistics or transport purposes, you should include the PackageType, Identifier, ItemCount, and Quantity. (Note: you still have the ability to describe the item with one of the "named" items.)

If you are communicating one of the named Items there is no need to include PackageType, Identifier, ItemCount, and Quantity.

Since either of these two approaches can be used the entire contents of this element are optional even though the parent may be required. It is expected that you will fill in the appropriate details.

DeliveryDateWindow

DeliveryDateWindow is optional. Multiple instances might exist.

A group item defining the date/time interval for delivery to take place. An element which may contain the estimated date for which delivery is expected. This date is not absolute.

StencilCharacteristics

StencilCharacteristics is optional. A single instance might exist.

A group element specifying attributes of a stencil to be applied to an item, and optional text.

AdditionalText

AdditionalText is optional. Multiple instances might exist.

A text field that is used to communicate information not previously defined or for special instructions. To be used only for circumstances not covered by specific elements.

InventoryDispositionInstructionsHeader

Provides information that is common for the instructions on how to dispose of problematic inventory.

(sequence)

The sequence of items below is

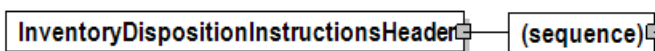

mandatory. A single instance is required.

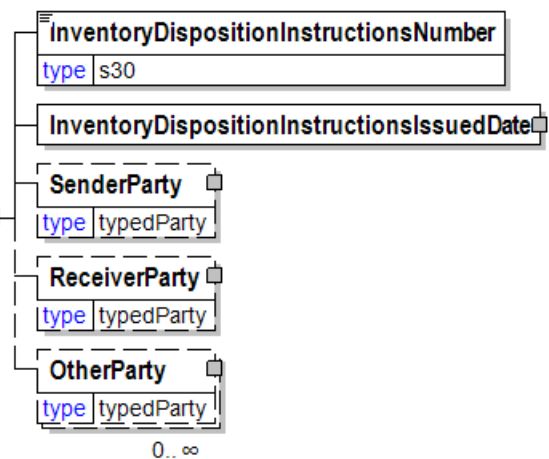

InventoryDispositionInstructionsNumber

InventoryDispositionInstructionsNumber is mandatory. A single instance is required.

The identifying number for the Inventory Disposition e-Document.

InventoryDispositionInstructionsIssuedDate

InventoryDispositionInstructionsIssuedDate is mandatory. A single instance is required.

papiNet V2R31

The date that the disposition instructions were issued.

SenderParty

SenderParty is optional. A single instance might exist.

The business entity issuing the e-Document, the source of the document.

The entity responsible for the content. If the sender party has out sourced the message service to a third party the SenderParty is the issuer of the e-Document and not the party performing the transmission service of the electronic message.

ReceiverParty

ReceiverParty is optional. A single instance might exist.

The business entity for whom the e-Document is intended, the destination of the document.

The entity interested in the content. If the receiver party has outsourced the message service to a third party the ReceiverParty is the intended party for the e-Document and not the party performing the receiving service of the electronic message.

OtherParty

OtherParty is optional. Multiple instances might exist.

An organisation or business entity other than those specifically detailed within an e-Document.

InventoryDispositionInstructionsIssuedDate

The date that the disposition instructions were issued.

(sequence)

The sequence of items below is mandatory. A single instance is required.

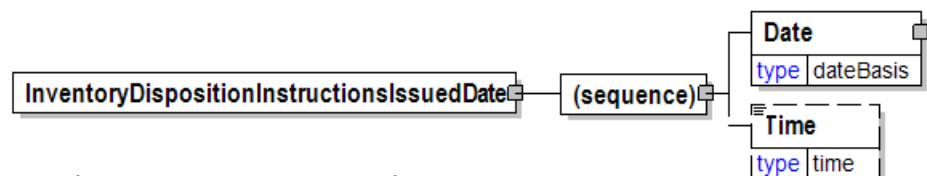

Date

Date is mandatory. A single instance is required.

A group element that contains the specification of Year, Month, and Day.

Time

Time is optional. A single instance might exist.

Times are treated in a standard XML fashion with a special case used to indicate a generalized "local" time. The standard XML approach to time is hh:mm:ss, hh:mm:ssZ, or hh:mm:ss±hh:mm.

hh:mm:ss±hh:mm is used to represent a time with a time zone. The time zone is communicated as the number of hours offset from the Universal Time Coordinate (UTC), a.k.a. Greenwich Mean Time.

hh:mm:ssZ indicates the time at Zulu (another name for UTC).

hh:mm:ss or hh:mm indicates within papiNet the applicable local time where the associated event is taking place. Caution should be used when processing times of this nature as the papiNet approach may be in discord with other users of XML.

InventoryDispositionInstructionsLineNumber

The sequential number that uniquely identifies the InventoryDispositionInstructions line item.

InventoryDispositionInstructionsLineNumber	
type	lineNumberType

InventoryDispositionInstructionsNumber

The identifying number for the InventoryDispositionInstructions e-Document.

InventoryDispositionInstructionsNumber	
type	s30

InventoryDispositionInstructionsReference

Contains references that pertain to the

InventoryDispositionInstructionsReference	
type	s255

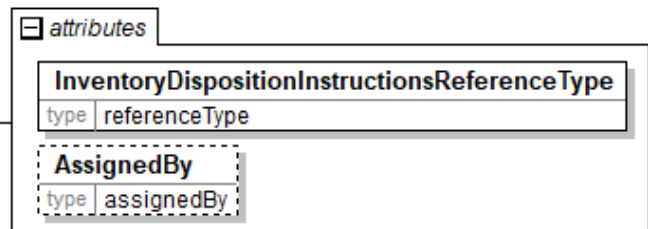

InventoryDispositionInstructions e-Document.

InventoryDispositionInstructionsReferenceType [attribute]

InventoryDispositionInstructionsReferenceType is mandatory. A single instance is required.

Provides a contextual explanation of the specific reference identifier. Many items are currently prefixed by "Buyer", "Forwarder", "Manufacturer", "Mill", "Seller", "Supplier", "Warehouse", or "Vendor". Check for an existing non-prefixed version and use the non-prefixed version instead. In the (yet to be announced release date) version 3.0 the prefixed versions will be removed. Instead the attribute @AssignedBy will communicate the information previously communicated in the prefix.

Refer to InventoryDispositionInstructionsReferenceType definition for any enumerations.

AssignedBy [attribute]

AssignedBy is optional. A single instance might exist.

Identifies the type of party or the agency that has assigned the associated item, e.g. a reference of type OrderNumber.

Refer to AssignedBy for any enumerations.

InventoryDispositionInstructionsReferenceType [attribute]

Provides a contextual explanation of the specific reference identifier. Many items are currently prefixed by "Buyer", "Forwarder", "Manufacturer", "Mill", "Seller", "Supplier", "Warehouse", or "Vendor". Check for an existing non-prefixed version and use the non-prefixed version instead. In the (yet to be announced release date) version 3.0 the prefixed versions will be removed. Instead the attribute @AssignedBy will communicate the information previously communicated in the prefix.

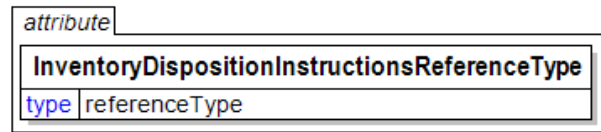

Refer to the [referenceType](#) entry for the list of enumerations and their definitions.

InventoryDispositionInstructionsType [attribute]

Indicates the type of inventory disposition that is required. As this attribute is at the line level multiple dispositions can be communicated in a single e-Document.



This item is restricted to the following list.

Scrap

Raw Material or Work in Process to be scrapped.

Destroy

Finished Goods or Work in Process containing copyrighted information that must be physically destroyed.

Hold

Excess raw materials, Work in Process, or Finished Goods that should be held for future production or until other Disposition Instructions are received at the current location.

Transfer

Raw materials or Work in Process that will be shipped to another location.

InventoryInspectionDate

The physical inspection Date and Time of inventory.

(sequence)

The sequence of items below is mandatory. A single instance is required.

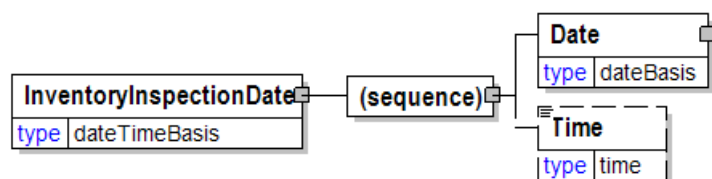

Date

Date is mandatory. A single instance is required.

papiNet V2R31

A group element that contains the specification of Year, Month, and Day.

Time

Time is optional. A single instance might exist.

Times are treated in a standard XML fashion with a special case used to indicate a generalized "local" time. The standard XML approach to time is hh:mm:ss, hh:mm:ssZ, or hh:mm:ss±hh:mm.

hh:mm:ss±hh:mm is used to represent a time with a time zone. The time zone is communicated as the number of hours offset from the Universal Time Coordinate (UTC), a.k.a. Greenwich Mean Time.

hh:mm:ssZ indicates the time at Zulu (another name for UTC).

hh:mm:ss or hh:mm indicates within papiNet the applicable local time where the associated event is taking place. Caution should be used when processing times of this nature as the papiNet approach may be in discord with other users of XML.

InventoryOwnedBy [attribute]

Specifies who is the owner of the inventory/goods.

This item is restricted to the following list.

Buyer

The owner of the inventory/goods is the buyer. The inventory/goods have already been invoiced.

Seller

The owner of the inventory/goods is the seller

InventoryOwnedBy	
type	ownedByType
default	Seller

InventoryStatus

The InventoryStatus element is the root element for the InventoryStatus e-Document.

The InventoryStatus e-Document informs involved parties about physical inventory levels at specific stock locations (warehouse, terminal, printer etc.) at a certain time (snapshot).

Reissued [attribute]

Reissued is optional. A single instance might exist.

Either "Yes" or "No".

Refer to Reissued definition for any enumerations.

Language [attribute]

Language is optional. A single instance might exist.

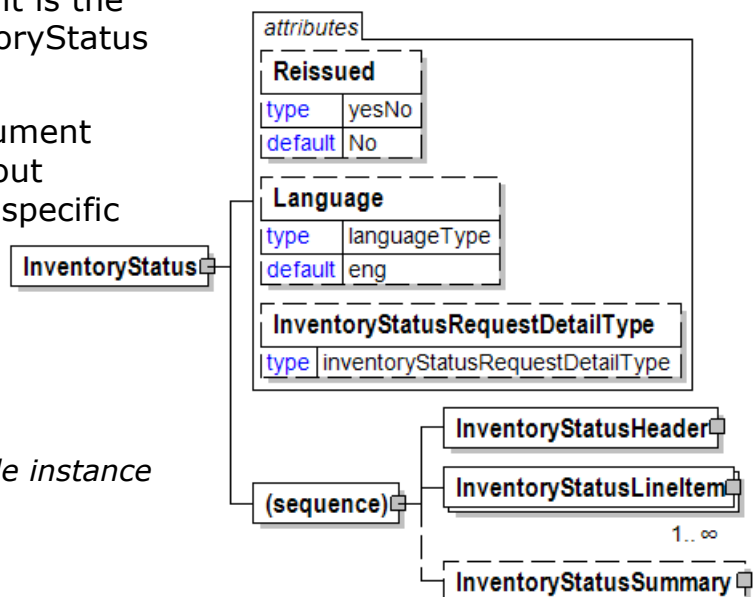

The valid Alpha 2- and Alpha 3-character list of language codes in the ISO 639-1 and 639-2 international standards.

Information on the content of this attribute is available at:
https://www.loc.gov/standards/iso639-2/php/code_list.php

InventoryStatusRequestDetailType [attribute]

InventoryStatusRequestDetailType is optional. A single instance might exist.

Communicates the method in which the InventoryStatus should be summarized.

Refer to InventoryStatusRequestDetailType definition for any enumerations.

(sequence)

The sequence of items below is mandatory. A single instance is required.

InventoryStatusHeader

InventoryStatusHeader is mandatory. A single instance is required.

Information that applies to all items on the InventoryStatus e-Document.

InventoryStatusLineItem

InventoryStatusLineItem is mandatory. One instance is required, multiple instances might exist.

Individual information about the item(s) on an InventoryStatus e-Document.

InventoryStatusSummary

InventoryStatusSummary is optional. A single instance might exist.

Summary information that applies to the entire InventoryStatus e-Document.

InventoryStatusHeader

Information that applies to all items on the InventoryStatus e-Document.

(sequence)

The sequence of items below is mandatory. A single instance is required.

InventoryStatusIssuedDate

InventoryStatusIssuedDate is mandatory. A single instance is required.

The effective date of the InventoryStatus e-Document.

RequestNumber

RequestNumber is optional. A single instance might exist.

A unique tracking number specifically identifying the InfoRequest e-Document to the originator. The tracking number is returned with the "information", the answer, to help match the answer to the request.

TransactionHistoryNumber

TransactionHistoryNumber is optional. A single instance might exist.

TransactionHistoryNumber in InventoryStatusHeader will be deprecated in a future version V3R00 and should not be used in new implementations.

InventoryStatusNumber

InventoryStatusNumber is mandatory. A single instance is required.

An identifier that allows for unique identification of the InventoryStatus.

LocationParty

LocationParty is optional. A single instance might exist.

The organization or business entity where the business event took place or will take place.

OtherParty

OtherParty is optional. Multiple instances might exist.

An organisation or business entity other than those specifically detailed within an e-Document.

SenderParty

SenderParty is optional. A single instance might exist.

The business entity issuing the e-Document, the source of the document.

The entity responsible for the content. If the sender party has out sourced the message service to a third party the SenderParty is the issuer of the e-Document and not the party performing the transmission service of the electronic message.

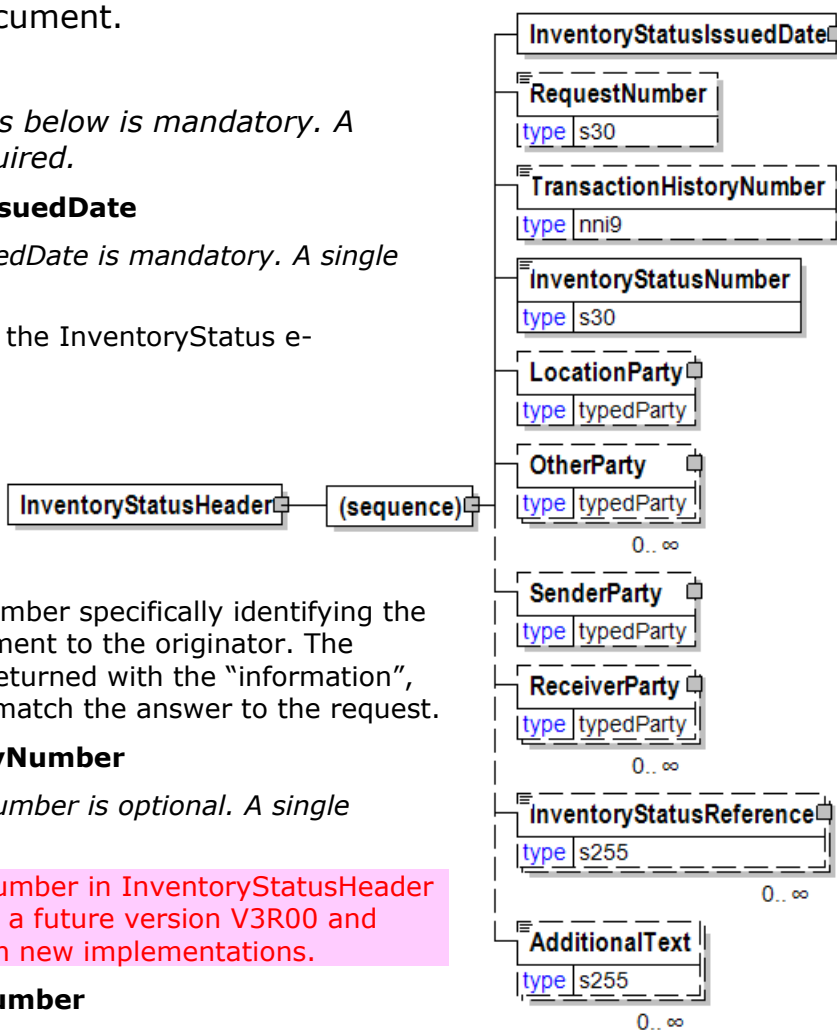

ReceiverParty

ReceiverParty is optional. Multiple instances might exist.

The business entity for whom the e-Document is intended, the destination of the document.

The entity interested in the content. If the receiver party has outsourced the message service to a third party the ReceiverParty is the intended party for the e-Document and not the party performing the receiving service of the electronic message.

InventoryStatusReference

InventoryStatusReference is optional. Multiple instances might exist.

A group item detailing relevant references pertaining to the InventoryChange, identified by InventoryStatusReferenceType.

AdditionalText

AdditionalText is optional. Multiple instances might exist.

A text field that is used to communicate information not previously defined or for special instructions. To be used only for circumstances not covered by specific elements.

InventoryStatusIssuedDate

The effective date of the InventoryStatus e-Document.

(sequence)

The sequence of items below is mandatory. A single instance is required.

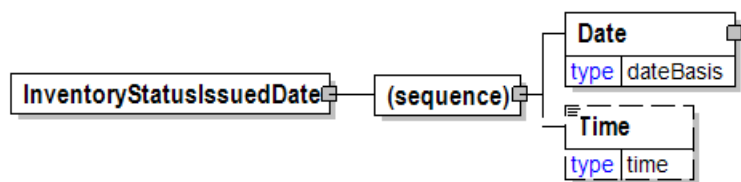

Date

Date is mandatory. A single instance is required.

A group element that contains the specification of Year, Month, and Day.

Time

Time is optional. A single instance might exist.

Times are treated in a standard XML fashion with a special case used to indicate a generalized "local" time. The standard XML approach to time is hh:mm:ss, hh:mm:ssZ, or hh:mm:ss±hh:mm.

hh:mm:ss±hh:mm is used to represent a time with a time zone. The time zone is communicated as the number of hours offset from the Universal Time Coordinate (UTC), a.k.a. Greenwich Mean Time.

hh:mm:ssZ indicates the time at Zulu (another name for UTC).

hh:mm:ss or hh:mm indicates within papiNet the applicable local time where the associated event is taking place. Caution should be used when processing times of this nature as the papiNet approach may be in discord with other users of XML.

InventoryStatusLineItem

Individual information about the item(s) on an InventoryStatus e-Document.

ShipmentComplete [attribute]

ShipmentComplete is optional. A single instance might exist.

Indicates that all shipments for the particular delivery item are complete

Refer to ShipmentComplete definition for any enumerations.

(sequence)

The sequence of items below is mandatory. A single instance is required.

InventoryStatusLineItemNumber

InventoryStatusLineItemNumber is mandatory. A single instance is required.

An identifier that allows for unique identification of the InventoryStatusLineItem.

PurchaseOrderInformation

PurchaseOrderInformation is optional. A single instance might exist.

A group item containing information unique to this PurchaseOrder, which is provided by the buyer. PurchaseOrderInformation can be optional in the supply chain. Invoices are created without having a PurchaseOrder in Vendor Managed Inventory. Freight invoices also will not have a PurchaseOrder number.

PurchaseOrderLineItemNumber

PurchaseOrderLineItemNumber is optional. A single instance might exist.

The sequential number that uniquely identifies the PurchaseOrder line item.

Product

Product is mandatory. A single instance is required.

Product is a group item defining the article and its characteristics. Product is used to specify product characteristics organized by ProductIdentifier, ProductDescription, and Classification. Book Manufacturing, Label Stock, Paper, Pulp, Recovered Paper, Wood Products, and Virgin Fibre market segments have defined their product characteristics and conversion features for implementation in papiNet.

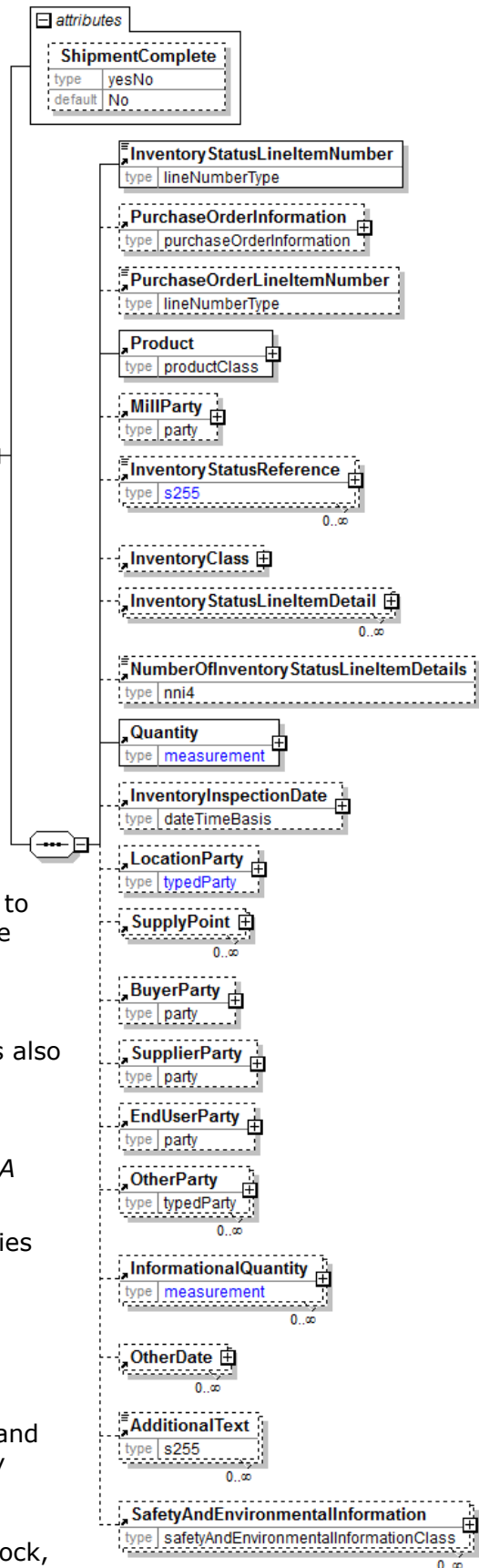

MillParty

MillParty is optional. A single instance might exist.

The organisation or business entity that actually produces the product.

InventoryStatusReference

InventoryStatusReference is optional. Multiple instances might exist.

A group item detailing relevant references pertaining to the InventoryChange, identified by InventoryStatusReferenceType.

InventoryClass

InventoryClass is optional. A single instance might exist.

A group item containing information about status of inventory and goods items.

InventoryStatusLineItemDetail

InventoryStatusLineItemDetail is optional. Multiple instances might exist.

A group element that contains InventoryStatus details.

NumberOfInventoryStatusLineItemDetails

NumberOfInventoryStatusLineItemDetails is optional. A single instance might exist.

The number of InventoryStatusLineItemDetail elements included in the InventoryStatusLineItem.

Quantity

Quantity is mandatory. A single instance is required.

The Quantity element contains attributes that provide information about the type of quantity that is being communicated, the context in which the particular quantity is to be viewed, and (if the quantity represents an adjustment) an adjustment type.

The Quantity element contains three child elements that enable you to communicate a range of values for the quantity and a target or actual value. It is at this level (Value, RangeMin, and RangeMax) that the unit of measure is specified. This permits the range to be specified in a different unit of measure than the target.

InventoryInspectionDate

InventoryInspectionDate is optional. A single instance might exist.

The physical inspection Date and Time of inventory.

LocationParty

LocationParty is optional. A single instance might exist.

The organization or business entity where the business event took place or will take place.

SupplyPoint

SupplyPoint is optional. Multiple instances might exist.

Grouping element that contains items describing a supply point. A SupplyPoint belongs to a LocationParty, e.g. in a DeliveryOrigin or DeliveryDestination, and describes where goods are stored and can be loaded or unloaded. A SupplyPoint can for example be a loading or unloading gate at a warehouse or a road side landing at a logging area in the forest.

BuyerParty

BuyerParty is optional. A single instance might exist.

The legal entity to which the product is sold. Also commonly referred to as the sold-to party or customer. If no OtherParty is defined as the Payer, the Buyer is the Payer.

SupplierParty

SupplierParty is optional. A single instance might exist.

The organisation or business entity responsible for providing the product. SupplierParty is also the seller of the product, if Seller is not specified as OtherParty = Seller.

EndUserParty

EndUserParty is optional. A single instance might exist.

The party using, consuming, or converting the product. For example, a printer using paper reels for a print job for a publisher. The final ShipTo destination for a product is normally to the end user's facilities.

OtherParty

OtherParty is optional. Multiple instances might exist.

An organisation or business entity other than those specifically detailed within an e-Document.

InformationalQuantity

InformationalQuantity is optional. Multiple instances might exist.

A quantity given in a valid UOM used for information purposes only (not for calculation). For example, an ordered quantity was 100 reels as opposed to the invoice quantity of 20,000 pounds.

OtherDate

OtherDate is optional. Multiple instances might exist.

A date that may not be specifically detailed within a document (example: print date at the PurchaseOrderLineItem).

AdditionalText

AdditionalText is optional. Multiple instances might exist.

A text field that is used to communicate information not previously defined or for special instructions. To be used only for circumstances not covered by specific elements.

SafetyAndEnvironmentalInformation

SafetyAndEnvironmentalInformation is optional. Multiple instances might exist.

Name of certification type, if any, on the goods (For example, FSC, PEFC). SafetyAndEnvironmental needs a value or measurement to communicate the percentage of the product is certified (for example, 75% is certified by the indicated agency).

InventoryStatusLineItemDetail

A group element that contains InventoryStatus details.

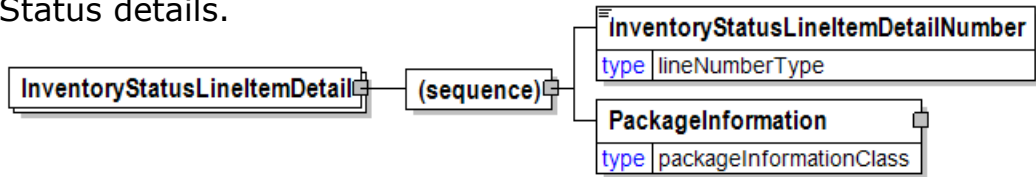

(sequence)

The sequence of items below is mandatory. A single instance is required.

InventoryStatusLineItemDetailNumber

InventoryStatusLineItemDetailNumber is mandatory. A single instance is required.

An identifier that allows for unique identification of the **InventoryStatusLineItemDetail**.

PackageInformation

PackageInformation is mandatory. A single instance is required.

The purpose of the **PackageInformation** structure is to clearly identify physical handling items that constitute the delivery.

PackageInformation is the highest level of product packaging it describes the shipping or warehousing unit.

If you are communicating a package, usually for logistics or transport purposes, you should include the **PackageType**, **Identifier**, **ItemCount**, and **Quantity**. (Note: you still have the ability to describe the item with one of the "named" items.)

If you are communicating one of the named Items there is no need to include **PackageType**, **Identifier**, **ItemCount**, and **Quantity**.

Since either of these two approaches can be used the entire contents of this element are optional even though the parent may be required. It is expected that you will fill in the appropriate details.

InventoryStatusLineItemDetailNumber

An identifier that allows for unique identification of the **InventoryStatusLineItemDetail**.

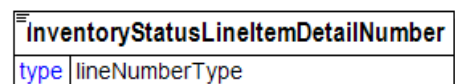

InventoryStatusLineItemNumber

An identifier that allows for unique identification of the **InventoryStatusLineItem**.

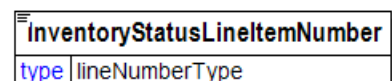

InventoryStatusNumber

An identifier that allows for unique identification of the **InventoryStatus**.

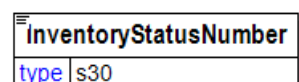

InventoryStatusReference

A group item detailing relevant references pertaining to the

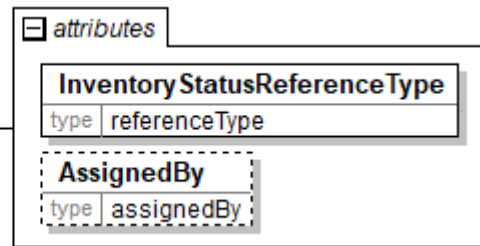
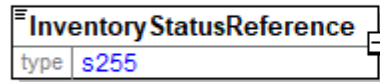

InventoryChange, identified by InventoryStatusReferenceType.

InventoryStatusReferenceType [attribute]

InventoryStatusReferenceType is mandatory. A single instance is required.

Provides a contextual explanation of the specific reference identifier. Many items are currently prefixed by "Buyer", "Forwarder", "Manufacturer", "Mill", "Seller", "Supplier", "Warehouse", or "Vendor". Check for an existing non-prefixed version and use the non-prefixed version instead. In the (yet to be announced release date) version 3.0 the prefixed versions will be removed. Instead the attribute @AssignedBy will communicate the information previously communicated in the prefix.

Refer to InventoryStatusReferenceType definition for any enumerations.

AssignedBy [attribute]

AssignedBy is optional. A single instance might exist.

Identifies the type of party or the agency that has assigned the associated item, e.g. a reference of type OrderNumber.

Refer to AssignedBy for any enumerations.

InventoryStatusReferenceType [attribute]

Provides a contextual explanation of the specific reference identifier. Many items are currently prefixed by "Buyer", "Forwarder", "Manufacturer", "Mill", "Seller", "Supplier", "Warehouse", or "Vendor". Check for an

existing non-prefixed version and use the non-prefixed version instead. In the (yet to be announced release date) version 3.0 the prefixed versions will be removed. Instead the attribute @AssignedBy will communicate the information previously communicated in the prefix.

Refer to the [referenceType](#) entry for the list of enumerations and their definitions.

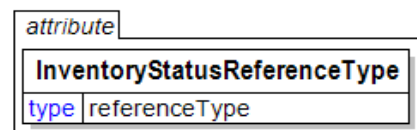

InventoryStatusReportingDetailType [attribute]

Communicates the level of detail in which inventory is to be reported.

This item is restricted to the following list.

AggregatedInventory

Inventory is to be reported in summary.

DetailedInventory

Inventory is reported in detail (using the InventoryStatusLineItemDetail element).

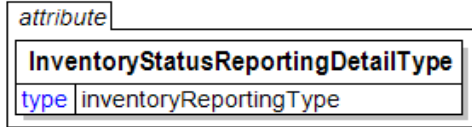

InventoryStatusRequestDetail

A grouping element that provides the parameters to be used when responding with an InventoryStatus e-Document.

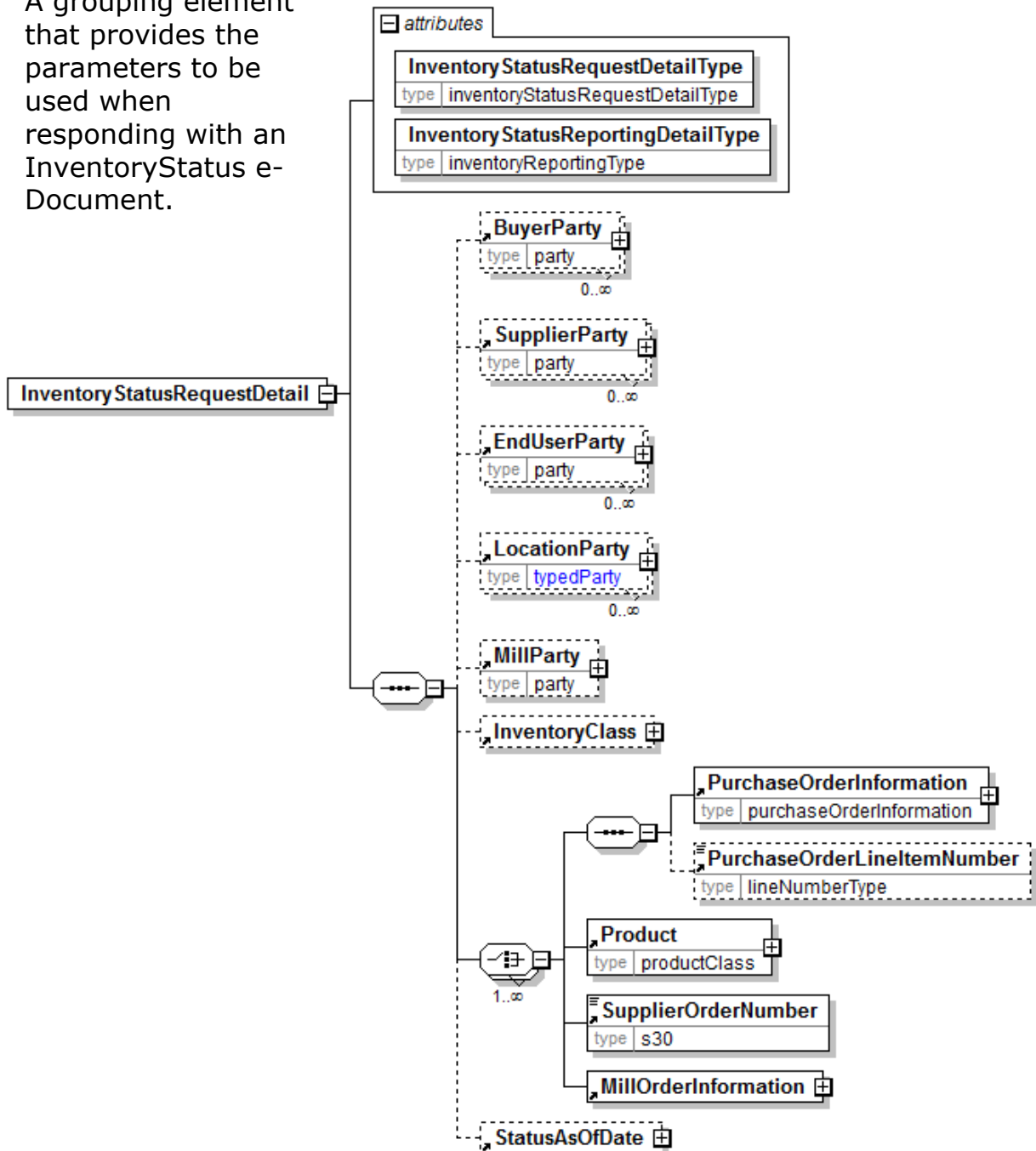

InventoryStatusRequestDetailType [attribute]

InventoryStatusRequestDetailType is mandatory. A single instance is required.

Communicates the method in which the InventoryStatus should be summarized.

Refer to InventoryStatusRequestDetailType definition for any enumerations.

InventoryStatusReportingDetailType [attribute]

InventoryStatusReportingDetailType is mandatory. A single instance is required.

Communicates the level of detail in which inventory is to be reported.

Refer to InventoryStatusReportingDetailType definition for any enumerations.

(sequence)

The sequence of items below is mandatory. A single instance is required.

BuyerParty

BuyerParty is optional. Multiple instances might exist.

The legal entity to which the product is sold. Also commonly referred to as the sold-to party or customer. If no OtherParty is defined as the Payer, the Buyer is the Payer.

SupplierParty

SupplierParty is optional. Multiple instances might exist.

The organisation or business entity responsible for providing the product. SupplierParty is also the seller of the product, if Seller is not specified as OtherParty = Seller.

EndUserParty

EndUserParty is optional. Multiple instances might exist.

The party using, consuming, or converting the product. For example, a printer using paper reels for a print job for a publisher. The final ShipTo destination for a product is normally to the end user's facilities.

LocationParty

LocationParty is optional. Multiple instances might exist.

The organization or business entity where the business event took place or will take place.

MillParty

MillParty is optional. A single instance might exist.

The organisation or business entity that actually produces the product.

InventoryClass

InventoryClass is optional. A single instance might exist.

A group item containing information about status of inventory and goods items.

(choice)

[choice] is mandatory. One instance is required, multiple instances might exist.

(sequence)

The sequence of items below is mandatory. A single instance is required.

PurchaseOrderInformation

PurchaseOrderInformation is mandatory. A single instance is required.

A group item containing information unique to this PurchaseOrder, which is provided by the buyer. PurchaseOrderInformation can be optional in the supply chain. Invoices are created without having a PurchaseOrder in Vendor Managed Inventory. Freight invoices also will not have a PurchaseOrder number.

PurchaseOrderLineNumber

PurchaseOrderLineNumber is optional. A single instance might exist.

The sequential number that uniquely identifies the PurchaseOrder line item.

Product

Product is mandatory. A single instance is required.

papiNet V2R31

Product is a group item defining the article and its characteristics. Product is used to specify product characteristics organized by ProductIdentifier, ProductDescription, and Classification. Book Manufacturing, Label Stock, Paper, Pulp, Recovered Paper, Wood Products, and Virgin Fibre market segments have defined their product characteristics and conversion features for implementation in papiNet.

SupplierOrderNumber

SupplierOrderNumber is mandatory. A single instance is required.

The number of the supplier order.

MillOrderInformation

MillOrderInformation is mandatory. A single instance is required.

A group item containing information unique to a mill order.

StatusAsOfDate

StatusAsOfDate is optional. A single instance might exist.

The specific Date and Time for which status is requested. This implies that all open transactions have closed for the date before the status is reported.

InventoryStatusRequestDetailType [attribute]

Communicates the method in which the InventoryStatus should be summarized.

This item is restricted to the following list.

attribute

InventoryStatusRequestDetailType

type inventoryStatusRequestDetailType

ByMillOrder

By the mill order number and mill order line item number the material was manufactured. MillParty has also to be specified in ByMillOrderInformation to defined the mill order origin.

ByProduct

By product

ByPurchaseOrder

By the PurchaseOrder the material was ordered

BySupplierOrderNumber

By the order the material was manufactured

InventoryStatusSummary

Summary information that applies to the entire InventoryStatus e-Document.

(sequence)

The sequence of items below is mandatory. A single instance is

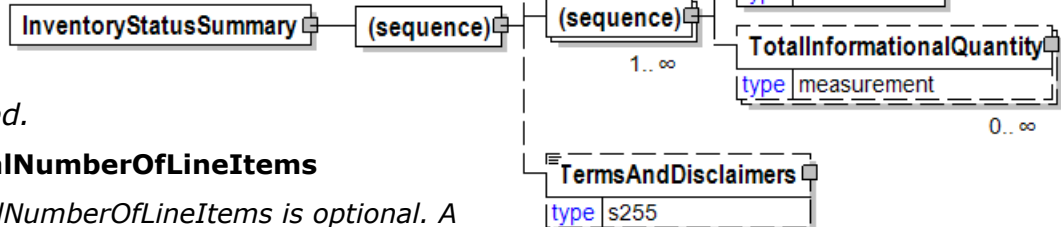

required.

TotalNumberOfLineItems

TotalNumberOfLineItems is optional. A single instance might exist.

The total number of individual line items in the document, regardless of the status or type.

(sequence)

The sequence of items below is mandatory. One instance is required, multiple instances might exist.

TotalQuantity

TotalQuantity is mandatory. A single instance is required.

The total quantity of similar items in the e-Document. TotalQuantity is primarily used in the summary section of documents where it is repeatable to permit totaling for different units of measure.

TotalInformationalQuantity

TotalInformationalQuantity is optional. Multiple instances might exist.

A quantity that is used to communicate related information about the parent element. This element represents a total that is derived from individual line items.

TermsAndDisclaimers

TermsAndDisclaimers is optional. A single instance might exist.

An element that contains legal information with an indication of what the Language is.

InventoryStatusType [attribute]

Provides the status type for inventory/goods belonging to a product and/or an order.

This item is restricted to the following list.

Sound

Sound inventory are prime inventory/goods without any damages or defects

Unsound

Unsound inventory/goods are inventory/goods with defects or inventory/goods put on hold for inspection.

attribute	
InventoryStatusType	
type	inventoryStatusType
default	Sound

Invoice

The Invoice element is the root element for the Invoice e-Document.

An Invoice e-Document can handle both debits and credits. Typically a seller sends an Invoice to a buyer after delivering the products or services specified in a PurchaseOrder or as part of an automatic replenishment agreement. Alternatively, an Invoice can be prepared by the buyer as part of a self-billing process. The Invoice is a list of the goods shipped and their quantities, or services rendered, indicating the price, terms of sale, supplemental charges, allowances, and communicates the payment required for the indicated items.

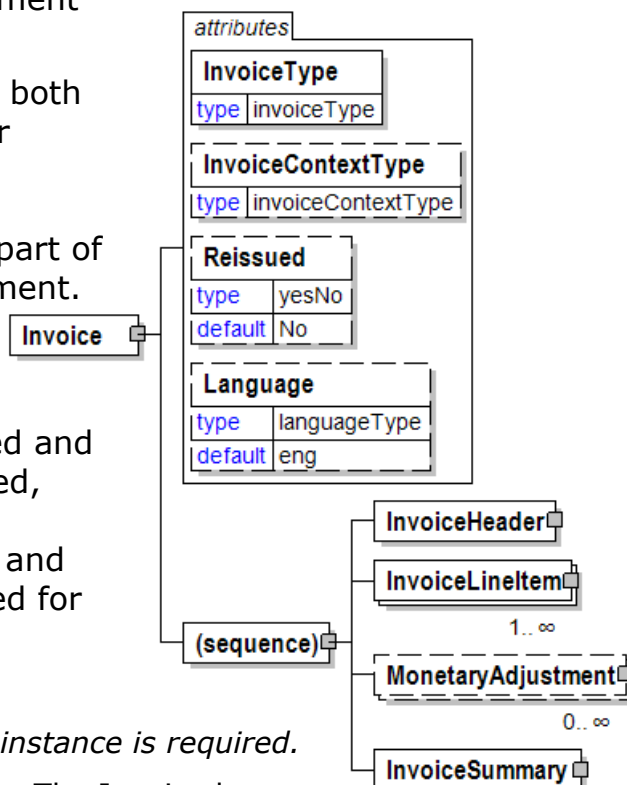

InvoiceType [attribute]

InvoiceType is mandatory. A single instance is required.

Defines the various types of invoices. The Invoice has been checked and found compliant with the EU Council Directive 2001/115/EC in force from 1 January 2004 in existing EU Member States and from 1 May 2004 in the Accession Countries. Directive 2001/115/EC harmonises, simplifies and modernises invoicing obligations on traders when they sell products or services that are subject to Value Added Tax (VAT). It also creates an EU legal framework for electronic transmission and storage of invoices. Refer to http://www.eic.ie/legislation/vat_invoicing.htm for additional information.

Types of invoices not covered in this standard include:

Delcredere – An invoice sent to the party paying for a number of buyers

Factored – An invoice assigned to a third party for collection

Refer to InvoiceType definition for any enumerations.

InvoiceContextType [attribute]

InvoiceContextType is optional. A single instance might exist.

Indicates the nature of what is included in the invoice.

Refer to InvoiceContextType definition for any enumerations.

Reissued [attribute]

Reissued is optional. A single instance might exist.

Either "Yes" or "No".

Refer to Reissued definition for any enumerations.

Language [attribute]

papiNet V2R31

Language is optional. A single instance might exist.

The valid Alpha 2- and Alpha 3-character list of language codes in the ISO 639-1 and 639-2 international standards.

Information on the content of this attribute is available at:
https://www.loc.gov/standards/iso639-2/php/code_list.php

(sequence)

The sequence of items below is mandatory. A single instance is required.

InvoiceHeader

InvoiceHeader is mandatory. A single instance is required.

Information that applies to all items on the Invoice.

InvoiceLineItem

InvoiceLineItem is mandatory. One instance is required, multiple instances might exist.

Information for each item on an Invoice.

MonetaryAdjustment

MonetaryAdjustment is optional. Multiple instances might exist.

The element containing the information necessary for the understanding, calculation, and treatment of an adjustment to a currency amount. MonetaryAdjustment contains an attribute that indicates they type of adjustment being communicated.

InvoiceSummary

InvoiceSummary is mandatory. A single instance is required.

Summary information for all items on an invoice.

InvoiceContextType [attribute]

Indicates the nature of what is included in the invoice.

This item is restricted to the following list.

LogisticsService

The invoice is exclusively for logistics services.

Product

The invoice includes product with optional logistics charges.



InvoiceDate

A date that is qualifying the invoicing period. This date often drives payment terms. Note that this date is not necessarily the same as the issue date of the invoice.

(sequence)

The sequence of items below is mandatory. A single instance

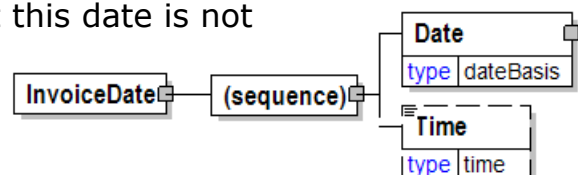

is required.

Date

Date is mandatory. A single instance is required.

A group element that contains the specification of Year, Month, and Day.

Time

Time is optional. A single instance might exist.

Times are treated in a standard XML fashion with a special case used to indicate a generalized "local" time. The standard XML approach to time is hh:mm:ss, hh:mm:ssZ, or hh:mm:ss±hh:mm.

hh:mm:ss±hh:mm is used to represent a time with a time zone. The time zone is communicated as the number of hours offset from the Universal Time Coordinate (UTC), a.k.a. Greenwich Mean Time.

hh:mm:ssZ indicates the time at Zulu (another name for UTC).

hh:mm:ss or hh:mm indicates within papiNet the applicable local time where the associated event is taking place. Caution should be used when processing times of this nature as the papiNet approach may be in discord with other users of XML.

InvoiceDeliveryInformation

A group item that contains delivery information for invoice purposes. The delivery information that is contained will be similar to that on the DeliveryMessage.

(sequence)

The sequence of items below is mandatory. A single instance is required.

DeliveryMessageNumber

DeliveryMessageNumber is mandatory. A single instance is required.

A unique delivery identifier assigned to each DeliveryMessage as agreed

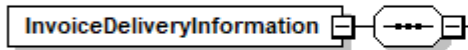

between the trading partners.

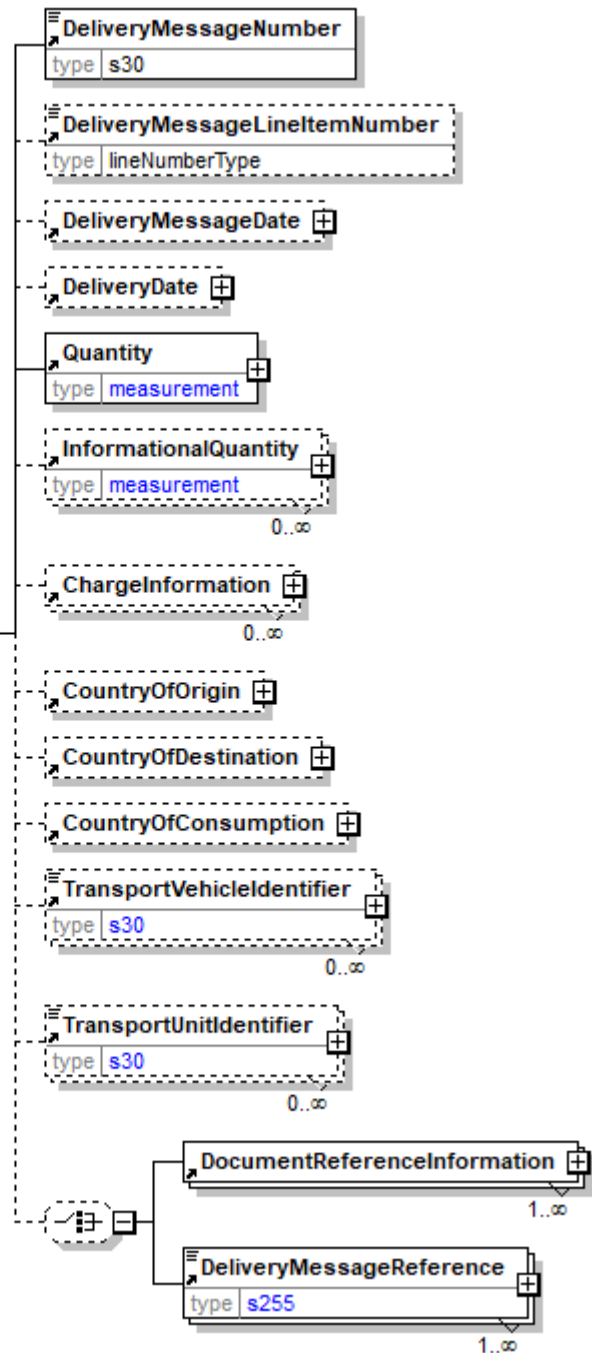

DeliveryMessageLineItemNumber

DeliveryMessageLineItemNumber is optional. A single instance might exist.

The sequential number that uniquely identifies the delivery line item.

DeliveryMessageDate

DeliveryMessageDate is optional. A single instance might exist.

The Date and Time when the DeliveryMessage was issued.

DeliveryDate

DeliveryDate is optional. A single instance might exist.

The Date and optionally the Time that the partners agree is the date upon which deliveries will be recognised. Possible choices for this date are either the date

despatched or the date received.

Quantity

Quantity is mandatory. A single instance is required.

The Quantity element contains attributes that provide information about the type of quantity that is being communicated, the context in which the particular quantity is to be viewed, and (if the quantity represents an adjustment) an adjustment type.

The Quantity element contains three child elements that enable you to communicate a range of values for the quantity and a target or actual value. It is at this level (Value, RangeMin, and RangeMax) that the unit of measure is specified. This permits the range to be specified in a different unit of measure than the target.

InformationalQuantity

InformationalQuantity is optional. Multiple instances might exist.

A quantity given in a valid UOM used for information purposes only (not for calculation). For example, an ordered quantity was 100 reels as opposed to the invoice quantity of 20,000 pounds.

ChargeInformation

ChargeInformation is optional. Multiple instances might exist.

A group element that contains elements that describe a charge. ChargeInformation is used when charge details need to be specified by using a code assigned by an agency. It is typically used for freight costs and other costs related to the supply chain.

CountryOfOrigin

CountryOfOrigin is optional. A single instance might exist.

The country of origin for the material.

CountryOfDestination

CountryOfDestination is optional. A single instance might exist.

The country where the goods will be, or were, shipped to.

CountryOfConsumption

CountryOfConsumption is optional. A single instance might exist.

The country of consumption for the material.

TransportVehicleIdentifier

TransportVehicleIdentifier is optional. Multiple instances might exist.

The identifier of the transport vehicle, for example a license plate number, a voyage number, a vessel name etc. The type of identifier is indicated by the TransportVehicleIdentifierType.

TransportUnitIdentifier

TransportUnitIdentifier is optional. Multiple instances might exist.

The identifier of the transport unit, for example a license plate number, a container ID etc. The identifier of the transport unit is the same as the identifier of the vehicle when the transport unit is directly mounted on the vehicle and does not have a separate identifier. The type of identifier is indicated by the TransportUnitIdentifierType.

(choice)

[choice] is optional. A single instance might exist.

DocumentReferenceInformation

DocumentReferenceInformation is mandatory. One instance is required, multiple instances might exist.

A group item containing reference information applicable to a document.

DeliveryMessageReference

DeliveryMessageReference is mandatory. One instance is required, multiple instances might exist.

An element that identifies the relevant references pertaining to the DeliveryMessage, identified by DeliveryMessageReferenceType.

DeliveryMessageReference in InvoiceDeliveryInformation will be deprecated in a future version V3R00 and should not be used in new implementations. Use instead DocumentReferenceInformation.

InvoiceHeader

Information that applies to all items on the Invoice.

(sequence)

The sequence of items below is mandatory. A single instance is required.

InvoiceNumber

InvoiceNumber is mandatory. A single instance is required.

The identification number of the invoice, generated by the seller.

InvoiceDate

InvoiceDate is mandatory. A single instance is required.

A date that is qualifying the invoicing period. This date often drives payment terms. Note that this date is not necessarily the same as the issue date of the invoice.

OtherDate

OtherDate is optional. Multiple instances might exist.

A date that may not be specifically detailed within a document (example: print date at the PurchaseOrderLineItem).

InvoiceReference

InvoiceReference is optional. Multiple instances might exist.

A group item detailing relevant references pertaining to the invoice e-Document. InvoiceReferenceType describes the content.

InvoiceReference in InvoiceHeader and InvoiceLineItem will be deprecated in a future version V3R00 and should not be used in new implementations. Use instead DocumentReferenceInformation.

DocumentReferenceInformation

DocumentReferenceInformation is optional. Multiple instances might exist.

A group item containing reference information applicable to a document.

BillToParty

BillToParty is mandatory. A single instance is required.

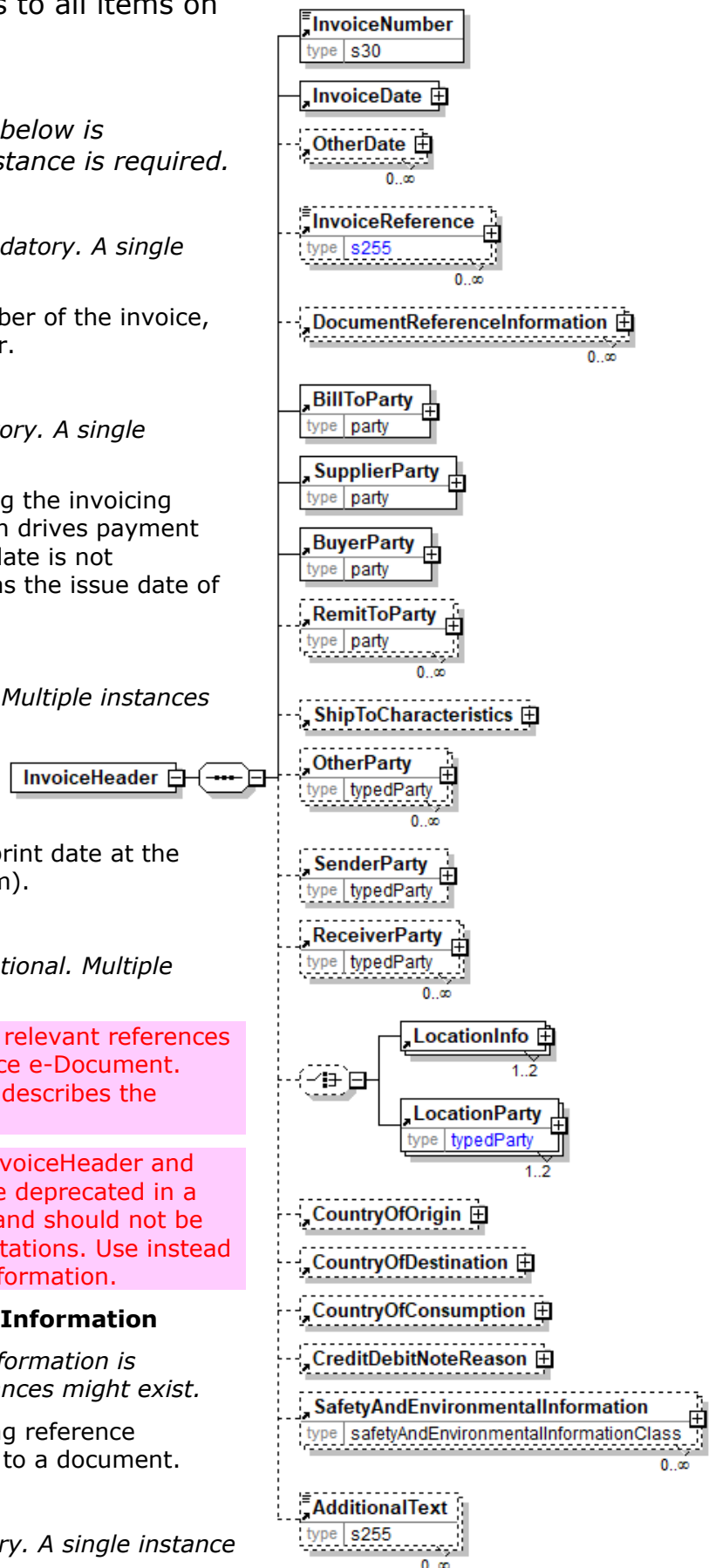

The address where the invoice is to be sent.

SupplierParty

SupplierParty is mandatory. A single instance is required.

The organisation or business entity responsible for providing the product. SupplierParty is also the seller of the product, if Seller is not specified as OtherParty = Seller.

BuyerParty

BuyerParty is mandatory. A single instance is required.

The legal entity to which the product is sold. Also commonly referred to as the sold-to party or customer. If no OtherParty is defined as the Payer, the Buyer is the Payer.

RemitToParty

RemitToParty is optional. Multiple instances might exist.

A group item containing details of the party to whom payment will be made. The RemitToParty contains all information related to remittance.

ShipToCharacteristics

ShipToCharacteristics is optional. A single instance might exist.

A group item that provides information important for the Ship-To Party.

OtherParty

OtherParty is optional. Multiple instances might exist.

An organisation or business entity other than those specifically detailed within an e-Document.

SenderParty

SenderParty is optional. A single instance might exist.

The business entity issuing the e-Document, the source of the document.

The entity responsible for the content. If the sender party has out sourced the message service to a third party the SenderParty is the issuer of the e-Document and not the party performing the transmission service of the electronic message.

ReceiverParty

ReceiverParty is optional. Multiple instances might exist.

The business entity for whom the e-Document is intended, the destination of the document.

The entity interested in the content. If the receiver party has outsourced the message service to a third party the ReceiverParty is the intended party for the e-Document and not the party performing the receiving service of the electronic message.

(choice)

[choice] is optional. A single instance might exist.

LocationInfo

LocationInfo is required. One instance is required, two instances might exist.

A grouping element that contains information about a geographical location.

LocationParty

papiNet V2R31

LocationParty is required. One instance is required, two instances might exist.

The organization or business entity where the business event took place or will take place.

LocationParty in InvoiceHeader and InvoiceLineItem will be deprecated in a future version V3R00 and should not be used in new implementations. Use instead LocationInfo.

CountryOfOrigin

CountryOfOrigin is optional. A single instance might exist.

The country of origin for the material.

CountryOfDestination

CountryOfDestination is optional. A single instance might exist.

The country where the goods will be, or were, shipped to.

CountryOfConsumption

CountryOfConsumption is optional. A single instance might exist.

The country of consumption for the material.

CreditDebitNoteReason

CreditDebitNoteReason is optional. A single instance might exist.

A group item containing the reason for the entire CreditDebitNote.

SafetyAndEnvironmentalInformation

SafetyAndEnvironmentalInformation is optional. Multiple instances might exist.

Name of certification type, if any, on the goods (For example, FSC, PEFC). SafetyAndEnvironmental needs a value or measurement to communicate the percentage of the product is certified (for example, 75% is certified by the indicated agency).

AdditionalText

AdditionalText is optional. Multiple instances might exist.

A text field that is used to communicate information not previously defined or for special instructions. To be used only for circumstances not covered by specific elements.

InvoiceLineAmount

The total invoice amount per line including adjustments, charges and tax (when tax is specified on the invoice line item).

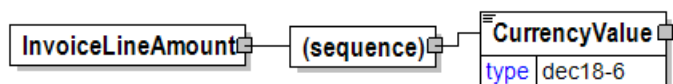

InvoiceLineAmount is equal to the InvoiceLineBaseAmount plus the sum of the signed values of the MonetaryAdjustmentAmount for all instances of MonetaryAdjustment and plus the sum of the signed values of the ChargeAmount for all instances of ChargeInformation.

(sequence)

The sequence of items below is mandatory. A single instance is required.

CurrencyValue

papiNet V2R31

CurrencyValue is mandatory. A single instance is required.

The amount in the referenced currency as defined by the CurrencyType attribute.

InvoiceLineBaseAmount

A field that contains the result of the calculation Quantity at the InvoiceLineItem level times the

PricePerUnit. As such it

does not include any taxes. It appears at the invoice line

item level. InvoiceLineBaseAmount encapsulates CurrencyValue.

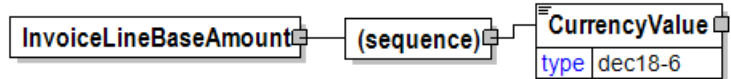

(sequence)

The sequence of items below is mandatory. A single instance is required.

CurrencyValue

CurrencyValue is mandatory. A single instance is required.

The amount in the referenced currency as defined by the CurrencyType attribute.

InvoiceLineBaseAmountInformation

A group item containing the price per unit and the invoice price amount subtotal.

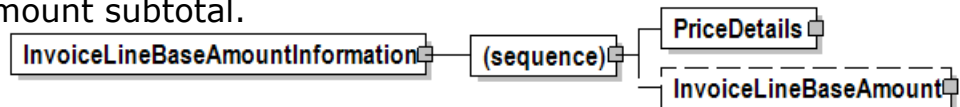

(sequence)

The sequence of items below is mandatory. A single instance is required.

PriceDetails

PriceDetails is mandatory. A single instance is required.

An element that groups together price information.

InvoiceLineBaseAmount

InvoiceLineBaseAmount is optional. A single instance might exist.

A field that contains the result of the calculation Quantity at the InvoiceLineItem level times the PricePerUnit. As such it does not include any taxes. It appears at the invoice line item level. InvoiceLineBaseAmount encapsulates CurrencyValue.

InvoiceLineItem

Information for each item on an Invoice.

IsFinalInvoice [attribute]

IsFinalInvoice is optional. A single instance might exist.

Communicates to the receiver that this is the last invoice so that the customer can “close out” the associated PO as completely invoiced.

Refer to IsFinalInvoice definition for any enumerations.

(sequence)

The sequence of items below is mandatory. A single instance is required.

InvoiceLineNumber

InvoiceLineNumber is mandatory. A single instance is required.

The sequential number that uniquely identifies the invoice line item. It may enable the invoice to be printed, viewed, or discussed in a common order.

PurchaseOrderInformation

PurchaseOrderInformation is optional. A single instance might exist.

A group item containing information unique to this PurchaseOrder, which is provided by the buyer. PurchaseOrderInformation can be optional in the supply chain. Invoices are created without having a PurchaseOrder in Vendor Managed Inventory. Freight invoices also will not have a PurchaseOrder number.

PurchaseOrderLineItemNumber

PurchaseOrderLineItemNumber is optional. A single instance might exist.

The sequential number that uniquely identifies the PurchaseOrder line item.

ChargeOrAllowance

ChargeOrAllowance is optional. A single instance might exist.

The description of the charge or allowance; such as freight, special handling, and stop-off handling.

Product

Product is optional. A single instance might exist.

Product is a group item defining the article and its characteristics. Product is used to specify product characteristics organized by ProductIdentifier, ProductDescription, and Classification. Book Manufacturing, Label Stock, Paper, Pulp, Recovered Paper, Wood Products, and

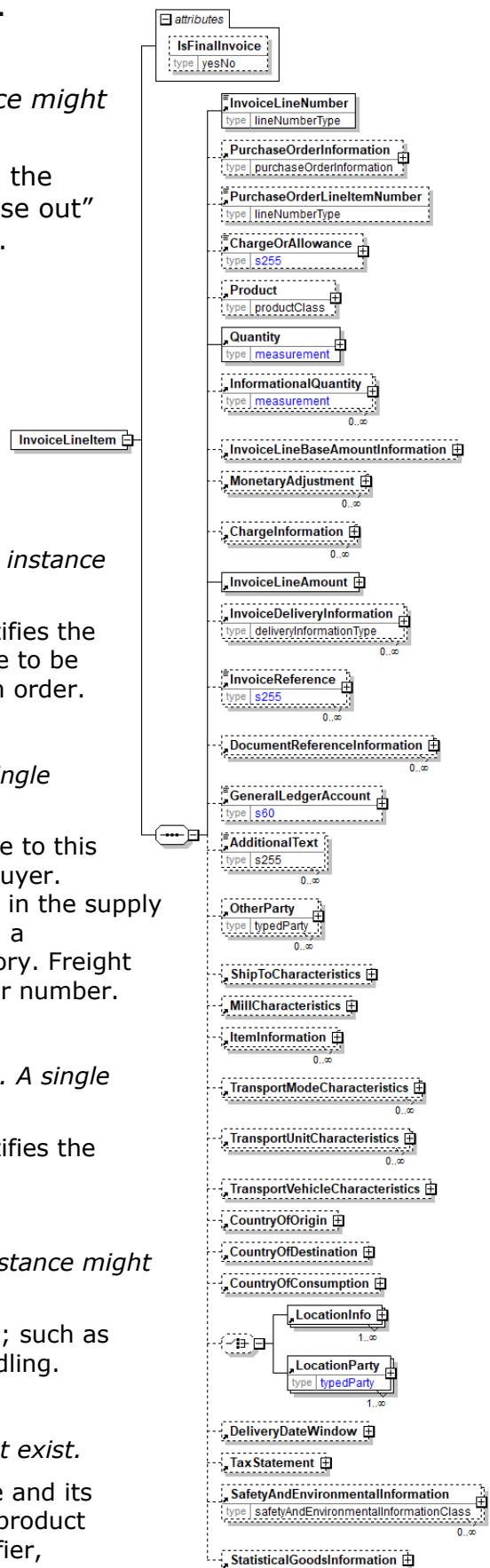

Virgin Fibre market segments have defined their product characteristics and conversion features for implementation in papiNet.

Quantity

Quantity is mandatory. A single instance is required.

The Quantity element contains attributes that provide information about the type of quantity that is being communicated, the context in which the particular quantity is to be viewed, and (if the quantity represents an adjustment) an adjustment type.

The Quantity element contains three child elements that enable you to communicate a range of values for the quantity and a target or actual value. It is at this level (Value, RangeMin, and RangeMax) that the unit of measure is specified. This permits the range to be specified in a different unit of measure than the target.

InformationalQuantity

InformationalQuantity is optional. Multiple instances might exist.

A quantity given in a valid UOM used for information purposes only (not for calculation). For example, an ordered quantity was 100 reels as opposed to the invoice quantity of 20,000 pounds.

InvoiceLineBaseAmountInformation

InvoiceLineBaseAmountInformation is optional. A single instance might exist.

A group item containing the price per unit and the invoice price amount subtotal.

MonetaryAdjustment

MonetaryAdjustment is optional. Multiple instances might exist.

The element containing the information necessary for the understanding, calculation, and treatment of an adjustment to a currency amount. MonetaryAdjustment contains an attribute that indicates they type of adjustment being communicated.

ChargeInformation

ChargeInformation is optional. Multiple instances might exist.

A group element that contains elements that describe a charge. ChargeInformation is used when charge details need to be specified by using a code assigned by an agency. It is typically used for freight costs and other costs related to the supply chain.

InvoiceLineAmount

InvoiceLineAmount is mandatory. A single instance is required.

The total invoice amount per line including adjustments, charges and tax (when tax is specified on the invoice line item).

InvoiceLineAmount is equal to the InvoiceLineBaseAmount plus the sum of the signed values of the MonetaryAdjustmentAmount for all instances of MonetaryAdjustment and plus the sum of the signed values of the ChargeAmount for all instances of ChargeInformation.

InvoiceDeliveryInformation

InvoiceDeliveryInformation is optional. Multiple instances might exist.

A group item that contains delivery information for invoice purposes. The delivery information that is contained will be similar to that on the DeliveryMessage.

InvoiceReference

InvoiceReference is optional. Multiple instances might exist.

A group item detailing relevant references pertaining to the invoice e-Document. InvoiceReferenceType describes the content.

InvoiceReference in InvoiceHeader and InvoiceLineItem will be deprecated in a future version V3R00 and should not be used in new implementations. Use instead DocumentReferenceInformation.

DocumentReferenceInformation

DocumentReferenceInformation is optional. Multiple instances might exist.

A group item containing reference information applicable to a document.

GeneralLedgerAccount

GeneralLedgerAccount is optional. A single instance might exist.

The general ledger account to be referenced for the item.

AdditionalText

AdditionalText is optional. Multiple instances might exist.

A text field that is used to communicate information not previously defined or for special instructions. To be used only for circumstances not covered by specific elements.

OtherParty

OtherParty is optional. Multiple instances might exist.

An organisation or business entity other than those specifically detailed within an e-Document.

ShipToCharacteristics

ShipToCharacteristics is optional. A single instance might exist.

A group item that provides information important for the Ship-To Party.

MillCharacteristics

MillCharacteristics is optional. A single instance might exist.

A group item defining the mill party and machine identifier where a product is or was produced.

ItemInformation

ItemInformation is optional. Multiple instances might exist.

The purpose of the ItemInformation structure is to clearly identify physical items. The attribute ItemType defines the type of physical item. Physical items can be handling units like packages as well as items contained in packages.

TransportModeCharacteristics

TransportModeCharacteristics is optional and repeatable. Multiple instances might exist.

A group item defining the primary mode of transport.

TransportUnitCharacteristics

TransportUnitCharacteristics is optional. Multiple instances might exist.

A group item containing information about a transport unit, e.g. a trailer. Transport units contain goods and move using power from another source, the transport vehicle.

TransportVehicleCharacteristics

TransportVehicleCharacteristics is optional. A single instance might exist.

papiNet V2R31

A group item containing information about a transport vehicle, e.g. a truck. A transport vehicle has its own power and can be used to pull, push, carry, or tow a transport unit loaded with goods.

CountryOfOrigin

CountryOfOrigin is optional. A single instance might exist.

The country of origin for the material.

CountryOfDestination

CountryOfDestination is optional. A single instance might exist.

The country where the goods will be, or were, shipped to.

CountryOfConsumption

CountryOfConsumption is optional. A single instance might exist.

The country of consumption for the material.

(choice)

[choice] is optional. A single instance might exist.

LocationInfo

LocationInfo is required. Multiple instances might exist.

A grouping element that contains information about a geographical location.

LocationParty

LocationParty is required. Multiple instances might exist.

The organization or business entity where the business event took place or will take place.

LocationParty in InvoiceHeader and InvoiceLineItem will be deprecated in a future version V3R00 and should not be used in new implementations. Use instead LocationInfo.

DeliveryDateWindow

DeliveryDateWindow is optional. A single instance might exist.

A group item defining the date/time interval for delivery to take place. An element which may contain the estimated date for which delivery is expected. This date is not absolute.

TaxStatement

TaxStatement is optional. A single instance might exist.

A group element for declaration of exception from normal charges of tax and the reason for tax exemption.

SafetyAndEnvironmentalInformation

SafetyAndEnvironmentalInformation is optional. Multiple instances might exist.

Name of certification type, if any, on the goods (For example, FSC, PEFC). SafetyAndEnvironmental needs a value or measurement to communicate the percentage of the product is certified (for example, 75% is certified by the indicated agency).

StatisticalGoodsInformation

StatisticalGoodsInformation is optional. A single instance might exist.

A group item containing statistical information about handled or traded goods.

papiNet V2R31

InvoiceLineNumber

The sequential number that uniquely identifies the invoice line item. It may enable the invoice to be printed, viewed, or discussed in a common order.

InvoiceLineNumber
type lineNumberType

InvoiceNumber

The identification number of the papiNet e-Document Invoice. This number uniquely identifies documents for all InvoiceType such as Invoice, DebitNote, CreditNote, Approximate, SelfBillingStatement etc

InvoiceNumber
type s30

InvoiceNumberMax

The upper range of invoices being communicated or requested.

InvoiceNumberMax
type s30

InvoiceNumberMin

The lower limit of a range of invoices being communicated or requested.

InvoiceNumberMin
type s30

InvoiceNumberRange

A range of invoices to be considered or reported on.

(sequence)

The sequence of items below is mandatory. A single instance is required.

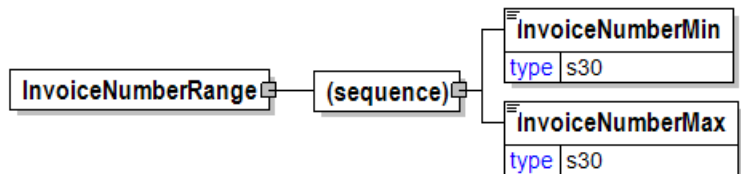

InvoiceNumberMin

InvoiceNumberMin is mandatory. A single instance is required.

The lower limit of a range of invoices being communicated or requested.

InvoiceNumberMax

InvoiceNumberMax is mandatory. A single instance is required.

The upper range of invoices being communicated or requested.

InvoicePrimaryStatus

The primary status of the invoice.

InvoiceStatusCode [attribute]

InvoiceStatusCode is mandatory.

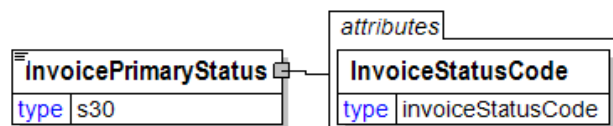

A single instance is required.

A code communicating the payment status of an invoice.

Refer to InvoiceStatusCode definition for any enumerations.

InvoiceProductGroup

Product grouping for invoiced items.

(sequence)

The sequence of items below is mandatory. A single instance is required.

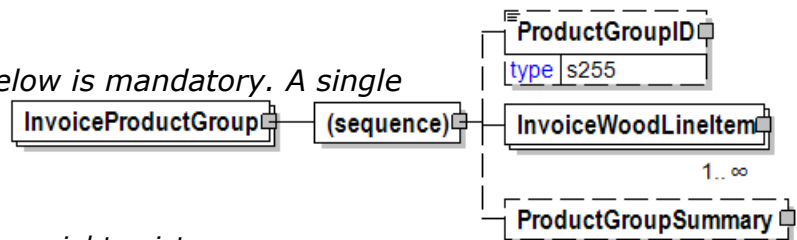

ProductGroupID

ProductGroupID is optional. A single instance might exist.

Possibility to group packages or Shipments. Example: Creating temporary group ID's for logistic reasons or lot number.

InvoiceWoodLineItem

InvoiceWoodLineItem is mandatory. One instance is required, multiple instances might exist.

Specific information for a given item on an Invoice.

Note Business Rule IVW017: At least one instance of either the Product or ChargeOrAllowance elements is required.

ProductGroupSummary

ProductGroupSummary is optional. A single instance might exist.

Group of elements to provide summary information on product level.

InvoiceReference

A group item detailing relevant references pertaining to the invoice e-Document.

InvoiceReferenceType describes the content.

InvoiceReferenceType [attribute]

InvoiceReferenceType is mandatory. A single instance is required.

Provides a contextual explanation of the specific reference identifier. Many items are currently prefixed by "Buyer", "Forwarder", "Manufacturer", "Mill", "Seller", "Supplier", "Warehouse", or "Vendor". Check for an existing non-prefixed version and use the non-prefixed version instead. In the (yet to be announced release date) version 3.0 the prefixed versions will be removed. Instead the attribute @AssignedBy will communicate the information previously communicated in the prefix.

Refer to InvoiceReferenceType definition for any enumerations.

AssignedBy [attribute]

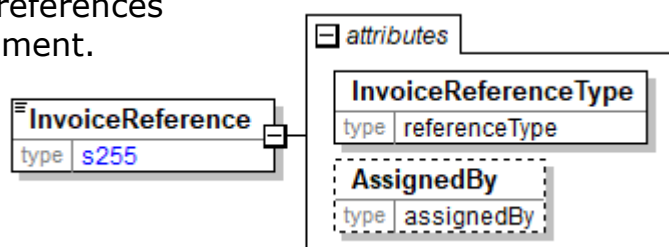

AssignedBy is optional. A single instance might exist.

Identifies the type of party or the agency that has assigned the associated item, e.g. a reference of type OrderNumber.

Refer to AssignedBy for any enumerations.

InvoiceReferenceType [attribute]

Provides a contextual explanation of the specific reference identifier. Many items are currently prefixed by "Buyer", "Forwarder", "Manufacturer", "Mill", "Seller", "Supplier", "Warehouse", or "Vendor". Check for an existing non-prefixed version and use the non-prefixed version instead. In the (yet to be announced release date) version 3.0 the prefixed versions will be removed. Instead the attribute @AssignedBy will communicate the information previously communicated in the prefix.

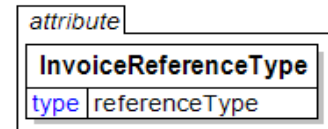

Refer to the [referenceType](#) entry for the list of enumerations and their definitions.

InvoiceSecondaryStatus

The secondary status of the invoice.

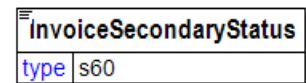

InvoiceShipment

Shipment grouping for invoiced items.

(sequence)

The sequence of items below is mandatory. A single instance is required.

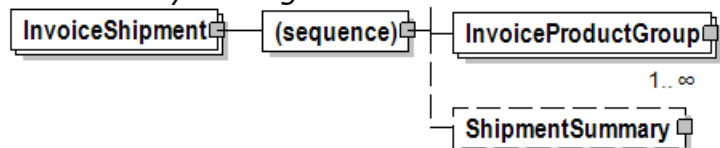

ShipmentID

ShipmentID is optional. A single instance might exist.

The ShipmentID may be a Bill of Lading Marking, which is customer's reference mark on each package used for logistic purposes. Should not be mixed up with Bill of Lading number. Another example of ShipmentID is grouping by a ContainerID.

InvoiceProductGroup

InvoiceProductGroup is mandatory. One instance is required, multiple instances might exist.

Product grouping for invoiced items.

ShipmentSummary

ShipmentSummary is optional. A single instance might exist.

Summary information for an entire shipment

InvoiceStatusCode [attribute]

A code communicating the payment status of an invoice.

This item is restricted to the following list.

attribute
InvoiceStatusCode
type invoiceStatusCode

Unpaid

No payments were booked against this invoice.

PartiallyPaid

Payments have been booked against this invoice, but the invoice is not completely paid and cleared.

Cleared

The invoice is paid to such an extent that no other money is expected or required.

InvoiceSummary

Summary information for all items on an invoice.

(sequence)

The sequence of items below is mandatory. A single instance is required.

TotalNumberOfLineItems

TotalNumberOfLineItems is optional. A single instance might exist.

The total number of individual line items in the document, regardless of the status or type.

(sequence)

The sequence of items below is optional. Multiple instances might exist.

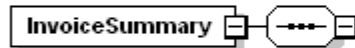

TotalQuantity

TotalQuantity is mandatory. A single instance is required.

The total quantity of similar items in the e-Document. TotalQuantity is primarily used in the summary section of documents where it is repeatable to permit totaling for different units of measure.

TotalInformationalQuantity

TotalInformationalQuantity is optional. Multiple instances might exist.

A quantity that is used to communicate related information about the parent element. This element represents a total that is derived from individual line items.

LineItemSubTotal

LineItemSubTotal is optional. A single instance might exist.

The total amount of all base amounts on e-Document line items. The base amount contains the result of the calculation quantity times the base unit price. As such it does not include any taxes. For example, in an Invoice claiming payment for products LineItemSubTotal is equal to the sum of all InvoiceLineBaseAmount.

TotalAdjustments

TotalAdjustments is optional. A single instance might exist.

The CurrencyValue of TotalAdjustments contains the total of all adjustments and charges excluding tax. For example, in the Invoice TotalAdjustments is equal to the sum of the signed values of the MonetaryAdjustmentAmount for all instances of MonetaryAdjustment with PriceAdjustment and FlatAmountAdjustment and plus the sum of the signed values of the ChargeNetAmount for all instances of ChargeInformation.

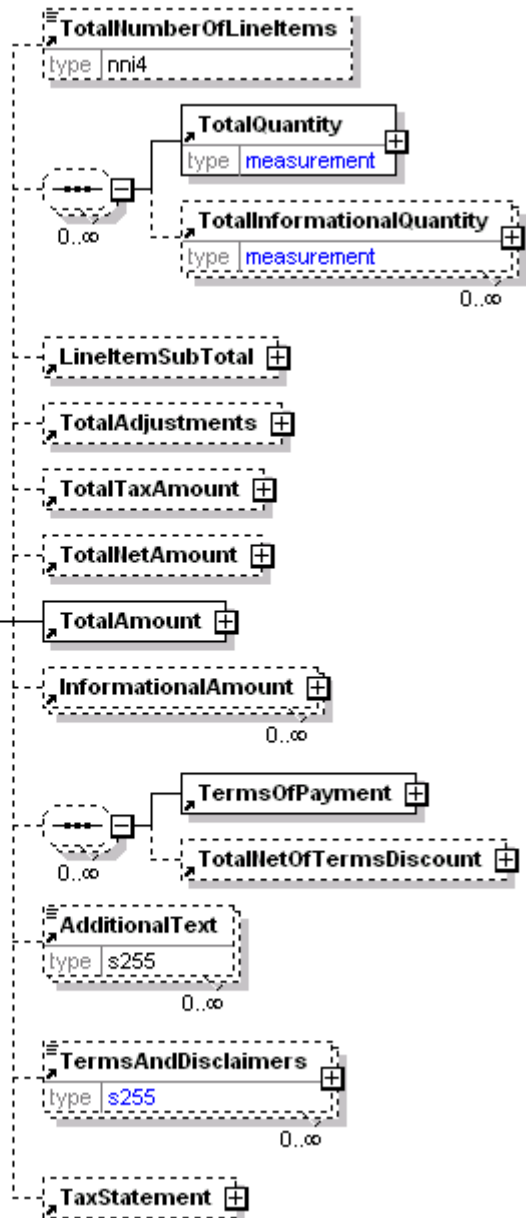

TotalTaxAmount

TotalTaxAmount is optional. A single instance might exist.

The CurrencyValue of TotalTaxAmount contains the sum of all instances of TaxAdjustment in the document. TotalTaxAmount contains the sum of all instances of the MonetaryAdjustmentAmount for tax adjustments.

TotalNetAmount

TotalNetAmount is optional. A single instance might exist.

A field containing total amount excluding tax. For example, in the Invoice TotalNetAmount is equal to the sum of LineItemSubTotal plus TotalAdjustments. TotalNetAmount encapsulates CurrencyValue.

TotalAmount

TotalAmount is mandatory. A single instance is required.

The total amount including tax (when tax is specified in the e-Document).

In e-Documents claiming payment this is the amount due for payment based on the terms of payment. Decimal rounding might be applied to this amount.

InformationalAmount

InformationalAmount is optional. Multiple instances might exist.

A monetary amount used for information purposes only (not for calculation). For example, the invoice price adjustment subtotal is expressed in sterling pounds, and the buyer wants this information expressed in U.S. dollars.

CreditDebitNote and Invoice - The TaxAmount is displayed in the currency that is applicable throughout the e-Document. When a TaxAmount needs to be displayed in a different national currency, this field is used.

(sequence)

The sequence of items below is optional. Multiple instances might exist.

TermsOfPayment

TermsOfPayment is mandatory. A single instance is required.

A group item that contains agreed-to terms defining when, how, and under what conditions the payment is to be made.

When TermsOfPayment is optional; if omitted, TermsOfPayment is controlled through previous negotiation.

TotalNetOfTermsDiscount

TotalNetOfTermsDiscount is optional. A single instance might exist.

The components of the amount to be paid if prompt payment discount terms are met, including the amount that is subject to the payment terms discount, the discount amount, and the amount due after prompt payment discount.

AdditionalText

AdditionalText is optional. Multiple instances might exist.

A text field that is used to communicate information not previously defined or for special instructions. To be used only for circumstances not covered by specific elements.

TermsAndDisclaimers

TermsAndDisclaimers is optional. Multiple instances might exist.

An element that contains legal information with an indication of what the Language

is.

TaxStatement

TaxStatement is optional. A single instance might exist.

A group element for declaration of exception from normal charges of tax and the reason for tax exemption.

InvoiceType [attribute]

Defines the various types of invoices. The Invoice has been checked and found compliant with the EU Council Directive 2001/115/EC in force from 1 January 2004 in existing EU Member States and from 1 May 2004 in the Accession Countries. Directive 2001/115/EC harmonises, simplifies and modernises invoicing obligations on traders when they sell products or services that are subject to Value Added Tax (VAT). It also creates an EU legal framework for electronic transmission and storage of invoices. Refer to http://www.eic.ie/legislation/vat_invoicing.htm for additional information.

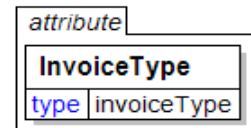

Types of invoices not covered in this standard include:

Delcredere – An invoice sent to the party paying for a number of buyers

Factored – An invoice assigned to a third party for collection

This item is restricted to the following list.

Approximate

An invoice that is created to record ownership transfer without the material physically being moved. Typically what occurs is that the buyer has agreed to take ownership of the item at a certain point in time but has not arranged for transportation. Approximate invoices are invoices that are claiming payment.

CreditNote

Credits that are provided for amount reductions and complaints. A CreditNote will normally have a reference to an earlier issued Invoice.

DebitNote

A DebitNote claims payment for additional charges. A DebitNote normally has a reference to an earlier issued Invoice.

Duplicate

To be removed in a future version. When an invoice is reissued as a duplicate the invoice type should be the same as on the original invoice. Use attribute Reissued = Yes to indicate a duplicate.

Invoice

A regular invoice (referred to as an invoice) claims payment for products, services, and charges supplied under conditions agreed to between seller and buyer. The invoice communicates, among other things, payment terms, payment method, and the payment amount required for one or more deliveries.

PrePayment

A prepayment invoice is used as a notification of amounts to be paid in advance. It is not a legal invoice claiming payment for provided products or services.

ProForma

A proforma debit note.

A proforma debit note is not a legal invoice claiming payment. A proforma debit note is an e-Document serving as a preliminary invoice, containing on the whole the same information as the final invoice, but not actually claiming payment. Proforma debit notes are typically used in a cross-border shipment for customs purposes. Can travel with the product or be sent to a broker.

ProFormaCreditNote

A proforma credit note.

A proforma credit note is not a legal invoice for credits. A proforma credit note is an e-Document serving as a preliminary credit note, containing on the whole the same information as a final credit note. A proforma credit note will normally have a reference to an earlier issued proforma debit note.

SelfBillingStatement

A SelfBillingStatement is an invoice that is prepared by the buyer of the product (or the consumer of the service) for the provider of the product or service. The preparer will pay the invoice.

Typically, logistics cost-charges are the services that are communicated. They are incurred during a certain period of time between the party who provides the logistics services (typically the party with a LogisticsRole of "LogisticsProvider") and the requestor of such services (typically the party with a LogisticsRole of "Consignor").

Raw materials, maintenance, repair, and operating supplies are examples of products that can be entered on a self billing statement for products. This type of invoice is also referred to as an invoice for "evaluated receipts" because it developed from the receiving department's evaluation of their receipts and from that creating the invoice.

The SelfBillingStatement process exists when there is a great deal of trust between the trading partners that permits this cost savings business process.

InvoiceWood

The InvoiceWood element is the root element for the InvoiceWood e-Document.

An InvoiceWood e-Document can handle both debits and credits. Typically a seller sends an InvoiceWood to a buyer after delivering the products or services specified in a PurchaseOrder or as part of an automatic replenishment agreement.

Alternatively, an InvoiceWood can be prepared by the buyer as part of a self-billing process. The InvoiceWood is a list of the goods shipped and their quantities, or services rendered, indicating the price, terms of sale, supplemental charges, allowances, and communicates the payment required for the indicated items.

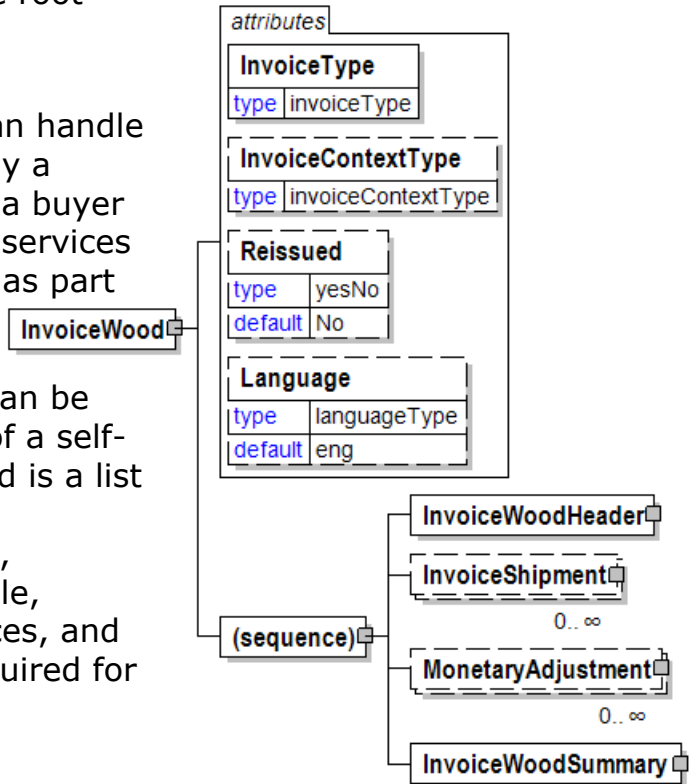

InvoiceType [attribute]

InvoiceType is mandatory. A single instance is required.

Defines the various types of invoices. The Invoice has been checked and found compliant with the EU Council Directive 2001/115/EC in force from 1 January 2004 in existing EU Member States and from 1 May 2004 in the Accession Countries. Directive 2001/115/EC harmonises, simplifies and modernises invoicing obligations on traders when they sell products or services that are subject to Value Added Tax (VAT). It also creates an EU legal framework for electronic transmission and storage of invoices. Refer to http://www.eic.ie/legislation/vat_invoicing.htm for additional information.

Types of invoices not covered in this standard include:

- Delcredere – An invoice sent to the party paying for a number of buyers
- Factored – An invoice assigned to a third party for collection

Refer to InvoiceType definition for any enumerations.

InvoiceContextType [attribute]

InvoiceContextType is optional. A single instance might exist.

Indicates the nature of what is included in the invoice.

Refer to InvoiceContextType definition for any enumerations.

Reissued [attribute]

Reissued is optional. A single instance might exist.

Either "Yes" or "No".

Refer to Reissued definition for any enumerations.

Language [attribute]

Language is optional. A single instance might exist.

The valid Alpha 2- and Alpha 3-character list of language codes in the ISO 639-1 and 639-2 international standards.

Information on the content of this attribute is available at:
https://www.loc.gov/standards/iso639-2/php/code_list.php

(sequence)

The sequence of items below is mandatory. A single instance is required.

InvoiceWoodHeader

InvoiceWoodHeader is mandatory. A single instance is required.

This element contains the information that is consistent for the entire InvoiceWood document.

InvoiceShipment

InvoiceShipment is optional. Multiple instances might exist.

Shipment grouping for invoiced items.

MonetaryAdjustment

MonetaryAdjustment is optional. Multiple instances might exist.

The element containing the information necessary for the understanding, calculation, and treatment of an adjustment to a currency amount. MonetaryAdjustment contains an attribute that indicates the type of adjustment being communicated.

InvoiceWoodSummary

InvoiceWoodSummary is mandatory. A single instance is required.

Summary information that applies to all items on a Wood Market Segment Invoice.

InvoiceWoodHeader

This element contains the information that is consistent for the entire InvoiceWood document.

(sequence)

The sequence of items below is mandatory. A single instance is required.

InvoiceNumber

InvoiceNumber is mandatory. A single instance is required.

The identification number of the papiNet e-Document Invoice. This number uniquely identifies documents for all InvoiceType such as Invoice, DebitNote, CreditNote, Approximate, SelfBillingStatement etc

InvoiceDate

InvoiceDate is mandatory. A single instance is required.

A date that is qualifying the invoicing period. This date often drives payment terms. Note that this date is not necessarily the same as the issue date of the invoice.

OtherDate

OtherDate is optional. Multiple instances might exist.

A date that may not be specifically detailed within a document (example: print date at the PurchaseOrderLineItem).

InvoiceReference

InvoiceReference is optional. Multiple instances might exist.

A group item detailing relevant references pertaining to the invoice e-Document. InvoiceReferenceType describes the content.

BillToParty

BillToParty is mandatory. A single instance is required.

The address where the invoice is to be sent.

SupplierParty

SupplierParty is mandatory. A single instance is required.

The organisation or business entity responsible for providing the product. SupplierParty is also the seller of the product, if Seller is not specified as OtherParty = Seller.

BuyerParty

BuyerParty is mandatory. A single instance is required.

The legal entity to which the product is sold. Also commonly referred to as the sold-to party or customer. If no OtherParty is defined as the Payer, the Buyer is the Payer.

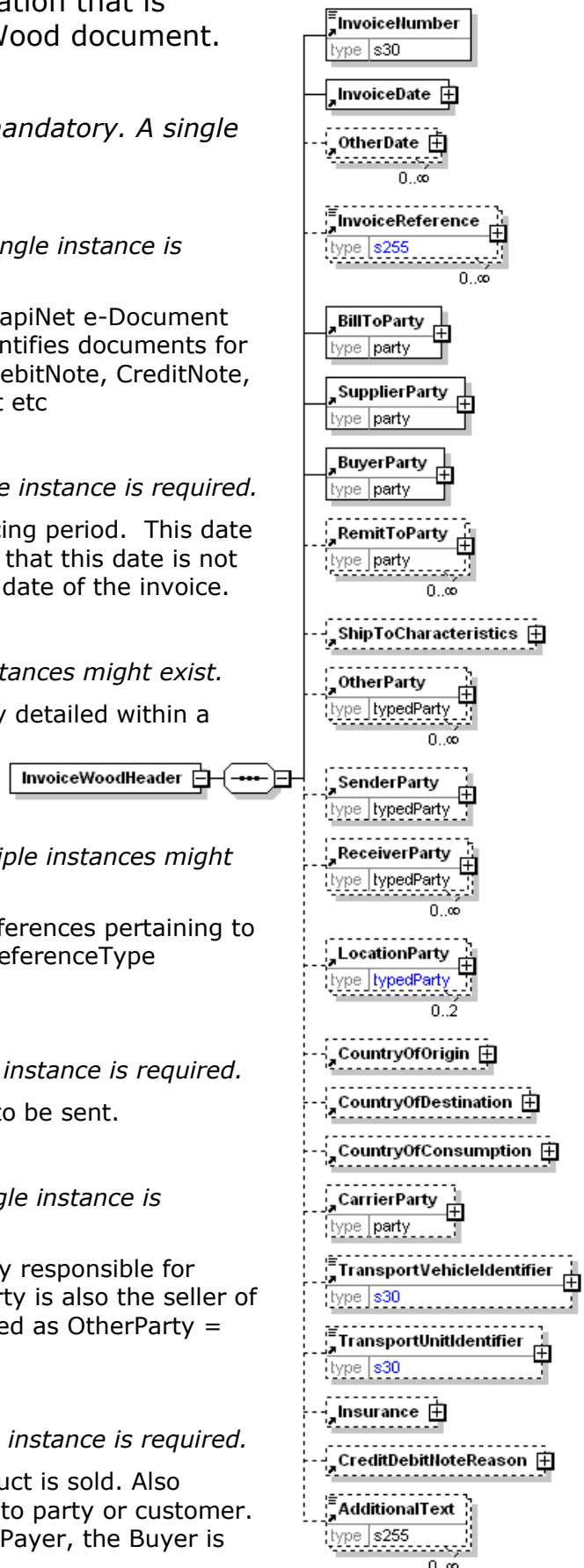

RemitToParty

RemitToParty is optional. Multiple instances might exist.

A group item containing details of the party to whom payment will be made. The RemitToParty contains all information related to remittance.

ShipToCharacteristics

ShipToCharacteristics is optional. A single instance might exist.

A group item that provides information important for the Ship-To Party.

OtherParty

OtherParty is optional. Multiple instances might exist.

An organisation or business entity other than those specifically detailed within an e-Document.

SenderParty

SenderParty is optional. A single instance might exist.

The business entity issuing the e-Document, the source of the document.

The entity responsible for the content. If the sender party has out sourced the message service to a third party the SenderParty is the issuer of the e-Document and not the party performing the transmission service of the electronic message.

ReceiverParty

ReceiverParty is optional. Multiple instances might exist.

The business entity for whom the e-Document is intended, the destination of the document.

The entity interested in the content. If the receiver party has outsourced the message service to a third party the ReceiverParty is the intended party for the e-Document and not the party performing the receiving service of the electronic message.

LocationParty

LocationParty is optional.

The organization or business entity where the business event took place or will take place.

CountryOfOrigin

CountryOfOrigin is optional. A single instance might exist.

The country of origin for the material.

CountryOfDestination

CountryOfDestination is optional. A single instance might exist.

The country where the goods will be, or were, shipped to.

CountryOfConsumption

CountryOfConsumption is optional. A single instance might exist.

The country of consumption for the material.

CarrierParty

CarrierParty is optional. A single instance might exist.

The party performing the transport of the product from the pickup location to the ship-to location; could be a hauler.

TransportVehicleIdentifier

TransportVehicleIdentifier is optional. A single instance might exist.

The identifier of the transport vehicle, for example a license plate number, a voyage number, a vessel name etc. The type of identifier is indicated by the TransportVehicleIdentifierType.

TransportUnitIdentifier

TransportUnitIdentifier is optional. A single instance might exist.

The identifier of the transport unit, for example a license plate number, a container ID etc. The identifier of the transport unit is the same as the identifier of the vehicle when the transport unit is directly mounted on the vehicle and does not have a separate identifier. The type of identifier is indicated by the TransportUnitIdentifierType.

Insurance

Insurance is optional. A single instance might exist.

Group element containing information about insurance

CreditDebitNoteReason

CreditDebitNoteReason is optional. A single instance might exist.

A group item containing the reason for the entire CreditDebitNote.

AdditionalText

AdditionalText is optional. Multiple instances might exist.

A text field that is used to communicate information not previously defined or for special instructions. To be used only for circumstances not covered by specific elements.

InvoiceWoodLineItem

Specific information for a given item on an Invoice.

Note Business Rule IVW017: At least one instance of either the Product or ChargeOrAllowance elements is required.

(sequence)

The sequence of items below is mandatory. A single instance is required.

InvoiceLineNumber

InvoiceLineNumber is mandatory. A single instance is required.

The sequential number that uniquely identifies the invoice line item. It may enable the invoice to be printed, viewed, or discussed in a common order.

PurchaseOrderInformation

PurchaseOrderInformation is optional. A single instance might exist.

A group item containing information unique to this PurchaseOrder, which is provided by the buyer. PurchaseOrderInformation can be optional in the supply chain. Invoices are created without having a PurchaseOrder in Vendor Managed Inventory. Freight invoices also will not have a PurchaseOrder number.

PurchaseOrderLineItemNumber

PurchaseOrderLineItemNumber is optional. A single instance might exist.

The sequential number that uniquely identifies the PurchaseOrder line item.

DocumentReferenceInformation

DocumentReferenceInformation is optional. Multiple instances might exist.

A group item containing reference information applicable to a document.

EndsDiscountInformation

EndsDiscountInformation is optional. A single instance might exist.

Rule for calculating the ends discount, expressed by a code.

ChargeOrAllowance

ChargeOrAllowance is optional. A single instance might exist.

The description of the charge or allowance; such as freight, special handling, and stop-off handling.

Product

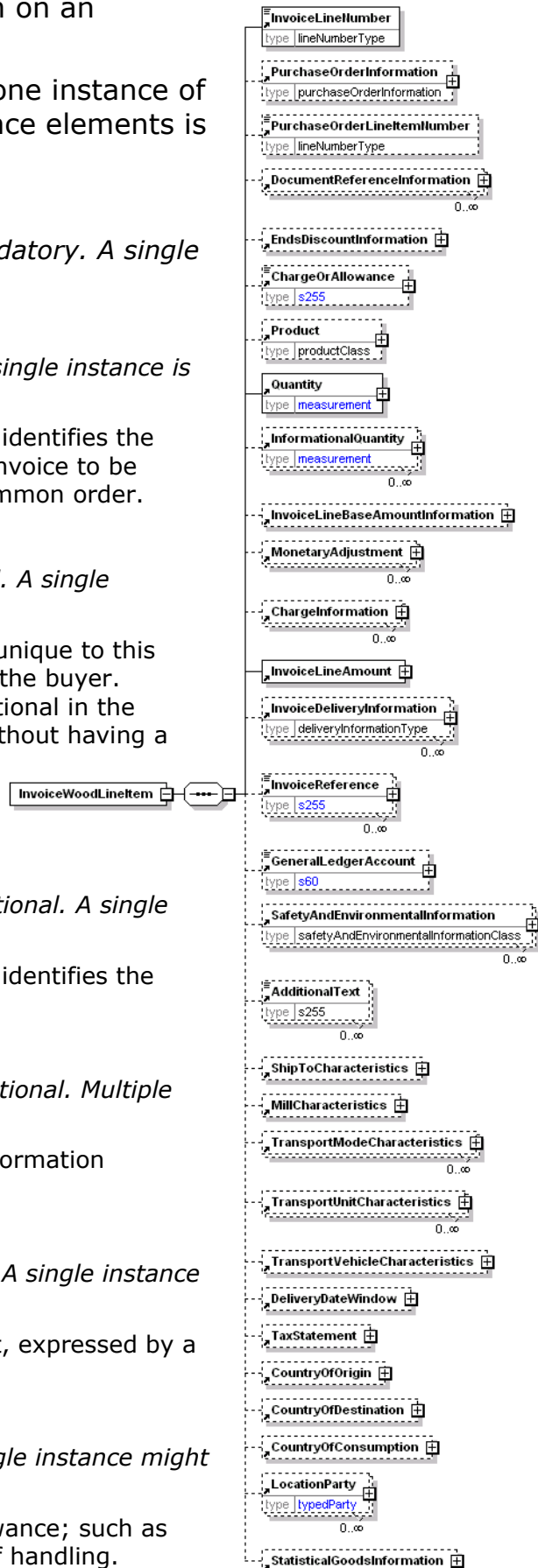

Product is optional. A single instance might exist.

Product is a group item defining the article and its characteristics. Product is used to specify product characteristics organized by ProductIdentifier, ProductDescription, and Classification. Book Manufacturing, Label Stock, Paper, Pulp, Recovered Paper, Wood Products, and Virgin Fibre market segments have defined their product characteristics and conversion features for implementation in papiNet.

Quantity

Quantity is mandatory. A single instance is required.

The Quantity element contains attributes that provide information about the type of quantity that is being communicated, the context in which the particular quantity is to be viewed, and (if the quantity represents an adjustment) an adjustment type.

The Quantity element contains three child elements that enable you to communicate a range of values for the quantity and a target or actual value. It is at this level (Value, RangeMin, and RangeMax) that the unit of measure is specified. This permits the range to be specified in a different unit of measure than the target.

InformationalQuantity

InformationalQuantity is optional. Multiple instances might exist.

A quantity given in a valid UOM used for information purposes only (not for calculation). For example, an ordered quantity was 100 reels as opposed to the invoice quantity of 20,000 pounds.

InvoiceLineBaseAmountInformation

InvoiceLineBaseAmountInformation is optional. A single instance might exist.

A group item containing the price per unit and the invoice price amount subtotal.

MonetaryAdjustment

MonetaryAdjustment is optional. Multiple instances might exist.

The element containing the information necessary for the understanding, calculation, and treatment of an adjustment to a currency amount. MonetaryAdjustment contains an attribute that indicates they type of adjustment being communicated.

ChargeInformation

ChargeInformation is optional. Multiple instances might exist.

A group element that contains elements that describe a charge. ChargeInformation is used when charge details need to be specified by using a code assigned by an agency. It is typically used for freight costs and other costs related to the supply chain.

InvoiceLineAmount

InvoiceLineAmount is mandatory. A single instance is required.

The total invoice amount per line including adjustments, charges and tax (when tax is specified on the invoice line item).

InvoiceLineAmount is equal to the InvoiceLineBaseAmount plus the sum of the signed values of the MonetaryAdjustmentAmount for all instances of MonetaryAdjustment and plus the sum of the signed values of the ChargeAmount for all instances of ChargeInformation.

InvoiceDeliveryInformation

InvoiceDeliveryInformation is optional. Multiple instances might exist.

A group item that contains delivery information for invoice purposes. The delivery information that is contained will be similar to that on the DeliveryMessage.

InvoiceReference

InvoiceReference is optional. Multiple instances might exist.

A group item detailing relevant references pertaining to the invoice e-Document. InvoiceReferenceType describes the content.

GeneralLedgerAccount

GeneralLedgerAccount is optional. A single instance might exist.

The general ledger account to be referenced for the item.

SafetyAndEnvironmentalInformation

SafetyAndEnvironmentalInformation is optional. Multiple instances might exist.

Name of certification type, if any, on the goods (For example, FSC, PEFC). SafetyAndEnvironmental needs a value or measurement to communicate the percentage of the product is certified (for example, 75% is certified by the indicated agency).

AdditionalText

AdditionalText is optional. Multiple instances might exist.

A text field that is used to communicate information not previously defined or for special instructions. To be used only for circumstances not covered by specific elements.

ShipToCharacteristics

ShipToCharacteristics is optional. A single instance might exist.

A group item that provides information important for the Ship-To Party.

MillCharacteristics

MillCharacteristics is optional. A single instance might exist.

A group item defining the mill party and machine identifier where a product is or was produced.

TransportModeCharacteristics

TransportModeCharacteristics is optional and repeatable .Multiple instances might exist.

A group item defining the primary mode of transport.

TransportUnitCharacteristics

TransportUnitCharacteristics is optional. Multiple instances might exist.

A group item containing information about a transport unit, e.g. a trailer. Transport units contain goods and move using power from another source, the transport vehicle.

TransportVehicleCharacteristics

TransportVehicleCharacteristics is optional. A single instance might exist.

A group item containing information about a transport vehicle, e.g. a truck. A transport vehicle has its own power and can be used to pull, push, carry, or tow a transport unit loaded with goods.

DeliveryDateWindow

DeliveryDateWindow is optional. A single instance might exist.

A group item defining the date/time interval for delivery to take place. An element which may contain the estimated date for which delivery is expected. This date is not absolute.

TaxStatement

TaxStatement is optional. A single instance might exist.

A group element for declaration of exception from normal charges of tax and the reason for tax exemption.

CountryOfOrigin

CountryOfOrigin is optional. A single instance might exist.

The country of origin for the material.

CountryOfDestination

CountryOfDestination is optional. A single instance might exist.

The country where the goods will be, or were, shipped to.

CountryOfConsumption

CountryOfConsumption is optional. A single instance might exist.

The country of consumption for the material.

LocationParty

LocationParty is optional. Multiple instances might exist.

The organization or business entity where the business event took place or will take place.

StatisticalGoodsInformation

StatisticalGoodsInformation is optional. A single instance might exist.

A group item containing statistical information about handled or traded goods.

InvoiceWoodSummary

Summary information that applies to all items on a Wood Market Segment Invoice.

(sequence)

The sequence of items below is mandatory. A single instance is required.

TotalNumberOfLineItems

TotalNumberOfLineItems is mandatory. A single instance is required.

The total number of individual line items in the document, regardless of the status or type.

(sequence)

The sequence of items below is mandatory. One instance is required, multiple instances might exist.

TotalQuantity

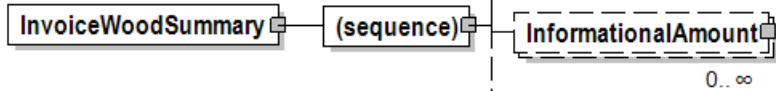

TotalQuantity is mandatory. A single instance is required.

The total quantity of similar items in the e-Document. TotalQuantity is primarily used in the summary section of documents where it is repeatable to permit totaling for different units of measure.

TotalInformationalQuantity

TotalInformationalQuantity is optional. Multiple instances might exist.

A quantity that is used to communicate related information about the parent element. This element represents a total that is derived from individual line items.

LineItemSubTotal

LineItemSubTotal is optional. A single instance might exist.

The total amount of all base amounts on e-Document line items. The base amount contains the result of the calculation quantity times the base unit price. As such it does not include any taxes. For example, in an Invoice claiming payment for products LineItemSubTotal is equal to the sum of all InvoiceLineBaseAmount.

TotalAdjustments

TotalAdjustments is optional. A single instance might exist.

The CurrencyValue of TotalAdjustments contains the total of all adjustments and charges excluding tax. For example, in the Invoice TotalAdjustments is equal to the

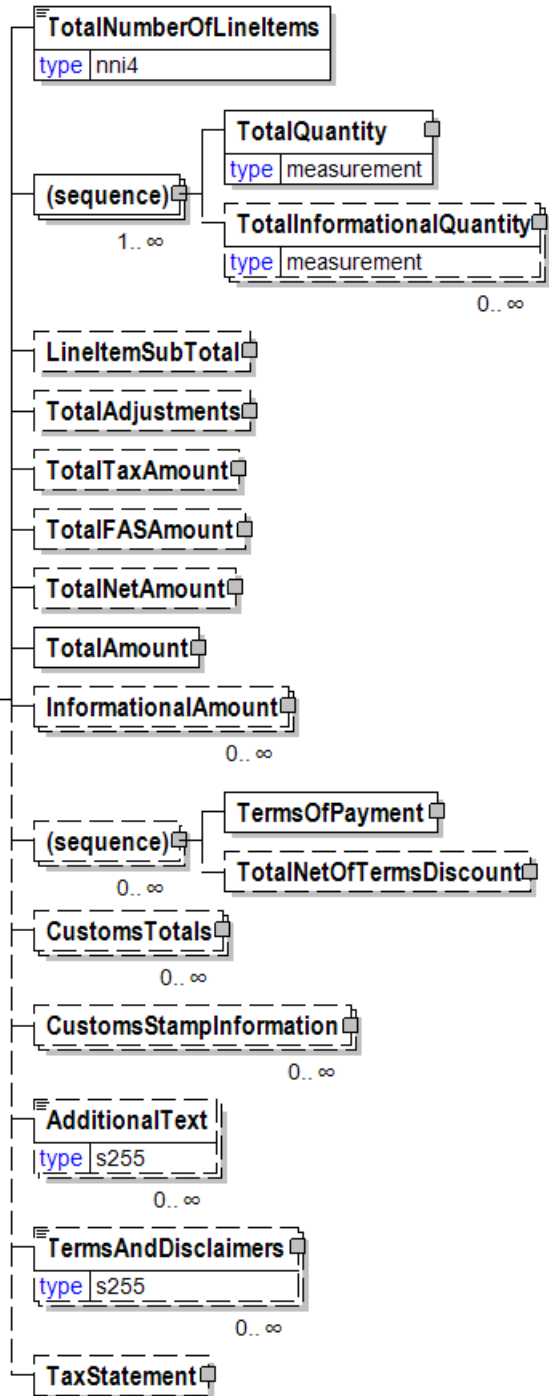

sum of the signed values of the MonetaryAdjustmentAmount for all instances of MonetaryAdjustment with PriceAdjustment and FlatAmountAdjustment and plus the sum of the signed values of the ChargeNetAmount for all instances of ChargeInformation.

TotalTaxAmount

TotalTaxAmount is optional. A single instance might exist.

The CurrencyValue of TotalTaxAmount contains the sum of all instances of TaxAdjustment in the document. TotalTaxAmount contains the sum of all instances of the MonetaryAdjustmentAmount for tax adjustments.

TotalFASAmount

TotalFASAmount is optional. A single instance might exist.

TotalFASAmount is the total Free Alongside Ship value.

TotalNetAmount

TotalNetAmount is optional. A single instance might exist.

A field containing total amount excluding tax. For example, in the Invoice TotalNetAmount is equal to the sum of LineItemSubTotal plus TotalAdjustments. TotalNetAmount encapsulates CurrencyValue.

TotalAmount

TotalAmount is mandatory. A single instance is required.

The total amount including tax (when tax is specified in the e-Document).

In e-Documents claiming payment this is the amount due for payment based on the terms of payment. Decimal rounding might be applied to this amount.

InformationalAmount

InformationalAmount is optional. Multiple instances might exist.

A monetary amount used for information purposes only (not for calculation). For example, the invoice price adjustment subtotal is expressed in sterling pounds, and the buyer wants this information expressed in U.S. dollars.

CreditDebitNote and Invoice - The TaxAmount is displayed in the currency that is applicable throughout the e-Document. When a TaxAmount needs to be displayed in a different national currency, this field is used.

(sequence)

The sequence of items below is optional. Multiple instances might exist.

TermsOfPayment

TermsOfPayment is mandatory. A single instance is required.

A group item that contains agreed-to terms defining when, how, and under what conditions the payment is to be made.

When TermsOfPayment is optional; if omitted, TermsOfPayment is controlled through previous negotiation.

TotalNetOfTermsDiscount

TotalNetOfTermsDiscount is optional. A single instance might exist.

The components of the amount to be paid if prompt payment discount terms are met, including the amount that is subject to the payment terms discount, the discount amount, and the amount due after prompt payment discount.

CustomsTotals

CustomsTotals is optional. Multiple instances might exist.

A grouping element for customs total information.

CustomsStampInformation

CustomsStampInformation is optional. Multiple instances might exist.

A grouping element that organises the information for customs.

AdditionalText

AdditionalText is optional. Multiple instances might exist.

A text field that is used to communicate information not previously defined or for special instructions. To be used only for circumstances not covered by specific elements.

TermsAndDisclaimers

TermsAndDisclaimers is optional. Multiple instances might exist.

An element that contains legal information with an indication of what the Language is.

TaxStatement

TaxStatement is optional. A single instance might exist.

A group element for declaration of exception from normal charges of tax and the reason for tax exemption.

IsAverageValue [attribute]

Indicates if the value is an average value or not.

This item is restricted to the following list.

Yes

No

IsAverageValue	
type	yesNo
default	No

IsBindingHandSeparation [attribute]

Indicates if there is hand separation required or not for books with odd page counts.

This item is restricted to the following list.

Yes

No

attributes	
IsBindingHandSeparation	
type	yesNo

IsBoxed [attribute]

This item is restricted to the following list.

Yes

Indicates that the operation should be performed and the specifications are included in the e-Document.

No

attribute	
IsBoxed	
type	isBoxed

Indicates that the operation will not be performed.

StandardOperatingProcedure

Indicates the operation should be performed according to the Standard Operating Procedure manual provided by the customer that contains all procedures required for conducting business.

IsBusinessChainSequenceApplicable [attribute]

Defines if the information supplied applies to the BusinessChainSequence or not.

This item is restricted to the following list.

Yes

No

attributes	
IsBusinessChainSequenceApplicable	
type	yesNo
default	No

IsCarrierLoadingOperator [attribute]

Specifies if the carrier is the loading operator or not.

This item is restricted to the following list.

Yes

No

attributes	
IsCarrierLoadingOperator	
type	yesNo

IsCarrierUnloadingOperator [attribute]

Specifies if the carrier is the unloading operator or not.

This item is restricted to the following list.

Yes

No

attributes	
IsCarrierUnloadingOperator	
type	yesNo

IsCountryAllowed [attribute]

Indicates if sale or distribution of the product is allowed or not allowed in the country.

This item is restricted to the following list.

Yes

No

attributes	
IsCountryAllowed	
type	yesNo
default	No

IsDeadEndRoad [attribute]

A road with only one way in or out.

This item is restricted to the following list.

Yes

No

attributes	
IsDeadEndRoad	
type	yesNo

IsEaselBound [attribute]

Specifies if the binding is at the top of the pages or not rather than on the side which changes the pagination of the pages.

This item is restricted to the following list.

Yes

No

attributes	
IsEaselBound	
type	yesNo
default	No

IsFinalInvoice [attribute]

Communicates to the receiver that this is the last invoice so that the customer can "close out" the associated PO as completely invoiced.

This item is restricted to the following list.

Yes

No

attribute	
IsFinalInvoice	
type	yesNo

IsFolioPresent [attribute]

Attribute that is used to indicate if the folio number is or is not present on the page.

This item is restricted to the following list.

Yes

No

attributes	
IsFolioPresent	
type	yesNo
default	Yes

IsForestWoodReject [attribute]

Specifies if the product is a reject or not.

This item is restricted to the following list.

Yes

No

attributes	
IsForestWoodReject	
type	yesNo

IsHalftones [attribute]

Indicates if the images are halftones or not.

This item is restricted to the following list.

Yes

No

attributes	
IsHalftones	
type	yesNo

IsLineCuts [attribute]

Indicates if images are Line Cuts or not.

This item is restricted to the following list.

Yes

No

attributes	
IsLineCuts	
type	yesNo

IsLoaded [attribute]

Specifies if the item is loaded or not.

This item is restricted to the following list.

Yes

No

attributes	
IsLoaded	
type	yesNo
default	No

IsMeasuringInfoCancelled [attribute]

Specifies if the measuring information is cancelled or not. When the measuring information is cancelled, then all versions of the measuring information are cancelled.

This item is restricted to the following list.

Yes

No

attributes	
IsMeasuringInfoCancelled	
type	yesNo
default	No

IsObjectMeasuringCompleted [attribute]

Specifies if measuring is completed or not for the object, when measuring of the object is carried out by having several measuring events.

This item is restricted to the following list.

Yes

No

attributes	
IsObjectMeasuringCompleted	
type	yesNo

ISOCountryCode [attribute]

The valid Alpha 2-character list of officially assigned country codes in the ISO 3166-1 international standard.

Information on the content of this attribute is available at:

<https://www.iso.org/obp/ui/#search>

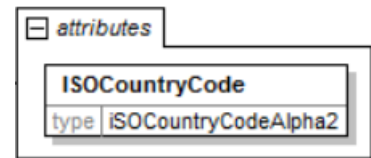

ISOCountryCodeAlpha3 [attribute]

The valid Alpha 3-character list of officially assigned country codes in the ISO 3166-1 international standard.

Information on the content of this attribute is available at:

<https://www.iso.org/obp/ui/#search>



ISOCountryCodeNumeric [attribute]

The valid Numeric 3-digit list of officially assigned country codes in the ISO 3166-1 international standard.

Information on the content of this attribute is available at:

<https://www.iso.org/obp/ui/#search>

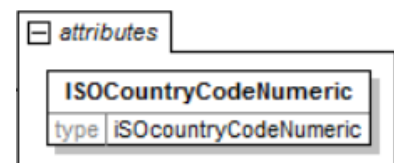

IsOpenDeliveryAgreement [attribute]

Indicates that a transportation of the product is managed as a long-term agreement between the business parties.

This item is restricted to the following list.

Yes

No

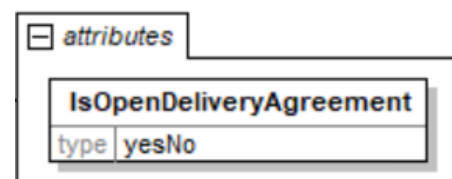

IsOptionalDeliveryOrigin [attribute]

Specifies if the DeliveryOrigin is optional or not. The default value is "No".

This item is restricted to the following list.

Yes

No (default)

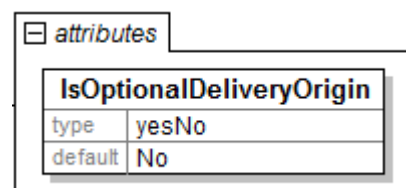

IsOptionalDestination [attribute]

Specifies if the Destination is optional or not. The default value is "No".

This item is restricted to the following list.

Yes

No (default)

A screenshot of a table representing the 'IsOptionalDestination' attribute. The table is titled 'attributes' and contains a sub-table for 'IsOptionalDestination'. The sub-table has two rows: 'type' with the value 'yesNo' and 'default' with the value 'No'.

attributes	
IsOptionalDestination	
type	yesNo
default	No

IsPageBlank [attribute]

Indicates if the entire page of the book is intentionally left blank or not.

This item is restricted to the following list.

Yes

No

A screenshot of a table representing the 'IsPageBlank' attribute. The table is titled 'attributes' and contains a sub-table for 'IsPageBlank'. The sub-table has two rows: 'type' with the value 'yesNo' and 'default' with the value 'No'.

attributes	
IsPageBlank	
type	yesNo
default	No

IsPalletized [attribute]

The buyer's directions for how the item is to be palletized.

This item is restricted to the following list.

Yes

Indicates that the operation should be performed and the specifications are included in the e-Document.

No

Indicates that the operation will not be performed.

StandardOperatingProcedure

Indicates the operation should be performed according to the Standard Operating Procedure manual provided by the customer that contains all procedures required for conducting business.

A screenshot of a table representing the 'IsPalletized' attribute. The table is titled 'attribute' and contains a sub-table for 'IsPalletized'. The sub-table has two rows: 'type' with the value 'isPalletized'.

attribute	
IsPalletized	
type	isPalletized

IsPartialConfirmation [attribute]

Specifies if the confirmation is a partial confirmation or not, e.g. confirmation of one segment only. Default value is No.

This item is restricted to the following list.

Yes

No

A screenshot of a table representing the 'IsPartialConfirmation' attribute. The table is titled 'attributes' and contains a sub-table for 'IsPartialConfirmation'. The sub-table has two rows: 'type' with the value 'yesNo' and 'default' with the value 'No'.

attributes	
IsPartialConfirmation	
type	yesNo
default	No

IsPartialConfirmationsAllowed [attribute]

Specifies if partial confirmations are allowed or not, e.g. confirmations of one segment only. Default value is No.

This item is restricted to the following list.

Yes

No

attributes	
IsPartialConfirmationsAllowed	
type	yesNo
default	No

IsPartialIndicator [attribute]

Specifies if the container (e.g. pallet, box) is partially full or not.

This item is restricted to the following list.

Yes

No

IsPartialIndicator	
type	yesNo
default	No

IsPartialPalletsAllowed [attribute]

Indicates if partial pallets are allowed or not.

This item is restricted to the following list.

Yes

No

attribute	
IsPartialPalletsAllowed	
type	yesNo

IsRFTagRequired [attribute]

Indicates that RFTag application is required in the manufacturing and carton packaging processes.

This item is restricted to the following list.

Yes

No

attributes	
IsRFTagRequired	
type	yesNo
default	No

IsRouteAsInstructed [attribute]

Indicates if the route is the same as the earlier instructed route, e.g. in a DeliveryInstruction e-Document. A route is indicated as not the same if any route information is different compared to the earlier instructed route. It is recommended to inform the reason for the change/new of the route.

This item is restricted to the following list.

Yes

attributes	
IsRouteAsInstructed	
type	yesNo

No

IsSlotManaged [attribute]

Specifies if the activity is managed by given slot times for execution of the activity. For example given slot times for unloading of a transport unit.

This item is restricted to the following list.

Yes

No



IssueDate

The date and time when the item was issued.

(sequence)

The sequence of items below is mandatory. A single instance is required.

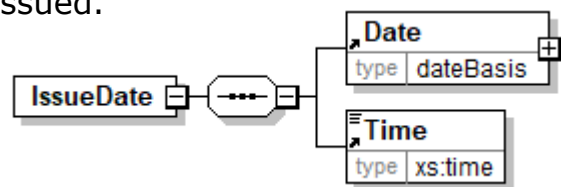

Date

Date is mandatory. A single instance is required.

A group element that contains the specification of Year, Month, and Day.

Time

Time is mandatory. A single instance is required.

Times are treated in a standard XML fashion with a special case used to indicate a generalized "local" time. The standard XML approach to time is hh:mm:ss, hh:mm:ssZ, or hh:mm:ss±hh:mm.

- hh:mm:ss±hh:mm is used to represent a time with a time zone. The time zone is communicated as the number of hours offset from the Universal Time Coordinate (UTC), a.k.a. Greenwich Mean Time.
- hh:mm:ssZ indicates the time at Zulu (another name for UTC).
- hh:mm:ss or hh:mm indicates within papiNet the applicable local time where the associated event is taking place. Caution should be used when processing times of this nature as the papiNet approach may be in discord with other users of XML.

IssueOrEventID

Used to communicate the identifier for a job.

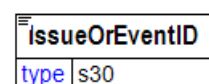

IsThirdPartyAdvice [attribute]

An advice to a third party of a ShippingInstructions.

This item is restricted to the following list.

Yes

No

attribute	
IsThirdPartyAdvice	
type	yesNo

IsThirdPartyShipment [attribute]

Shipment request to a party other than the party that ordered the product from the supplier

This item is restricted to the following list.

Yes

No

attribute	
IsThirdPartyShipment	
type	yesNo

IsTimeSlotAvailable [attribute]

Defines if the time slot is available or not.

This item is restricted to the following list.

Yes

No

attributes	
IsTimeSlotAvailable	
type	yesNo

IsTotal [attribute]

Specifies if the value is the total value or not.

This item is restricted to the following list.

Yes

No

attributes	
IsTotal	
type	yesNo
default	No

IsTradeRegionAvailable [attribute]

Is the geographic area available or not.

This item is restricted to the following list.

Yes

No

attribute	
IsTradeRegionAvailable	
type	yesNo

IsVehicleTourComplete [attribute]

Indicates whether all legs for the particular vehicle tour referenced by VehicleTourNumber are carried out or not.

This item is restricted to the following list.

Yes

No

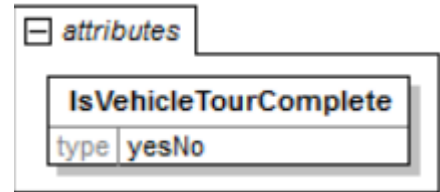

IsVersionCancelled [attribute]

Specifies if the version of an item is cancelled or not.

This item is restricted to the following list.

Yes

No

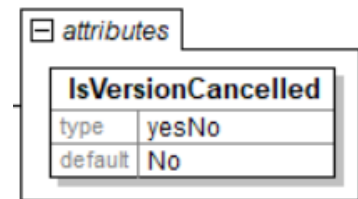

IsWithLoad [attribute]

Indicates if a vehicle is carrying a load or if it is possible to carry a load or not.

This item is restricted to the following list.

Yes

No

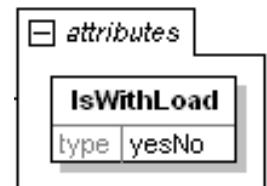

ItemCount

A count of the number of items (examples: a count of the number of boxes on a pallet or of reams in a box).

(sequence)

The sequence of items below is mandatory. A single instance is required.

Value

Value is mandatory. A single instance is required.

A numeric value expressed in the unit of measure (UOM).

RangeMin

RangeMin is optional. A single instance might exist.

The minimum value (lower boundary) allowed for the Measurement that is the parent of this element.

RangeMax

RangeMax is optional. A single instance might exist.

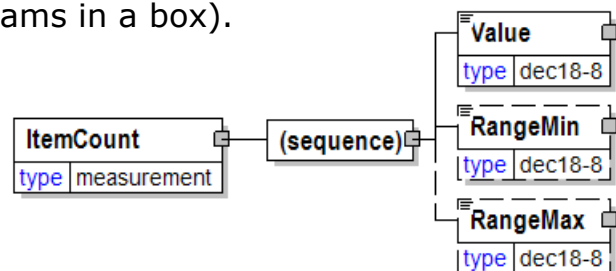

The maximum value (upper boundary) allowed for the Measurement that is the parent of this element. Some elements use the RangeMax element with an extended list of unit of measures. (Note: the red colour in the picture is an artifact of how the graphic was captured and should be disregarded.)

ItemDetails

A group element that identifies a specific item and measured attribute values for that item.

ItemType [attribute]

ItemType is mandatory. A single instance is required.

Indicates the form of the item being reported as being used. Many of the ItemType(s) indicated here have a corresponding named element equivalent, which is referenced here for definition purposes.

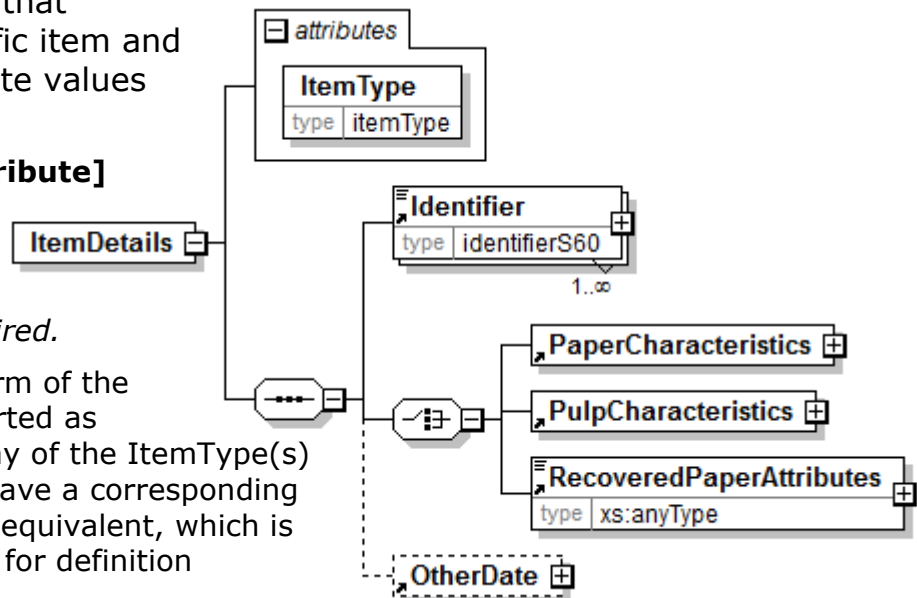

Refer to ItemType definition for any enumerations.

(sequence)

The sequence of items below is mandatory. A single instance is required.

Identifier

Identifier is mandatory. One instance is required, multiple instances might exist.

An Identifier is required for packages and items (pallets, reel packages, boxes, ream items, reel items, etc). The Identifier element contains the actual item identifier code. Identifier is repeatable so more than one identifier can be communicated. For example, the printed identifier on a label may be different from the barcode printed on the label.

(choice)

[choice] is mandatory. A single instance is required.

PaperCharacteristics

PaperCharacteristics is mandatory. A single instance is required.

The identifying characteristics of paper most important to the ordering of the item. These are the characteristics that, when associated with a given grade, allow the manufacturer to produce but not convert or package, the paper.

PulpCharacteristics

PulpCharacteristics is mandatory. A single instance is required.

The physical and chemical characteristics of the pulp product regardless of the form that it is taking.

RecoveredPaperAttributes

RecoveredPaperAttributes is mandatory. A single instance is required.

The attributes of Recovered Paper.

OtherDate

OtherDate is optional. A single instance might exist.

A date that may not be specifically detailed within a document (example: print date at the PurchaseOrderLineItem).

ItemInfo

A grouping element that contains information about an item. The attribute `ItemType` defines the type of physical item.

Item Info describes property values of an item as well as tracking information between items processed in the supply chain.

ItemType [attribute]

ItemType is optional. A single instance might exist.

Indicates the form of the item being reported as being used. Many of the `ItemType(s)` indicated here have a corresponding named element equivalent, which is referenced here for definition purposes.

Refer to `ItemType` definition for any enumerations.

(sequence)

The sequence of items below is mandatory. A single instance is required.

Identifier

Identifier is mandatory. Multiple instances might exist.

An Identifier is required for packages and items (pallets, reel packages, boxes, ream items, reel items, etc). The Identifier element contains the actual item identifier code. Identifier is repeatable so more than one identifier can be communicated. For example, the printed identifier on a label may be different from the barcode printed on the label.

TrackingReferenceID

TrackingReferenceID is optional. Multiple instances might exist.

A grouping element that defines tracking references between items processed in the supply chain.

ItemReference

ItemReference is optional. Multiple instances might exist.

An element detailing relevant references pertaining to the Item as indicated by

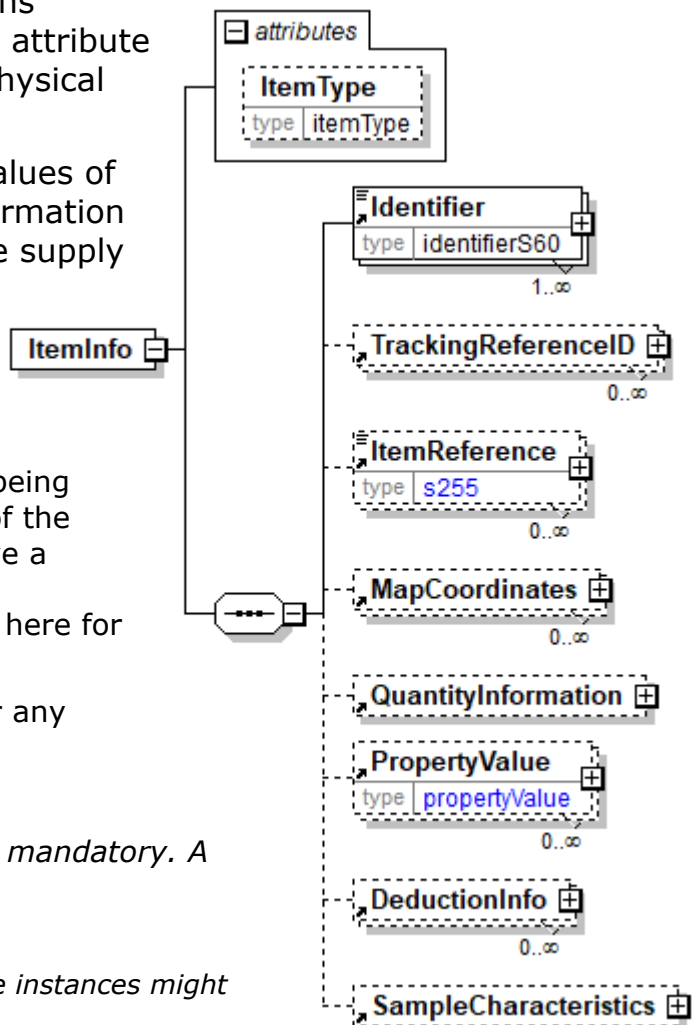

ItemReferenceType and AssignedBy.

MapCoordinates

MapCoordinates is optional. Multiple instances might exist.

A group item defining and containing position coordinates of a location

QuantityInformation

QuantityInformation is optional A single instance might exist.

A group item containing information about quantity and informational quantity of similar items.

PropertyValue

PropertyValue is optional. Multiple instances might exist.

Specifies a value for a property of an item. The property is defined by the attribute PropertyType. The attribute MeasuringMethod and MeasuringAgency can be used to clarify details for a how a property is measured or calculated, e.g. Diameter for a saw log can be measured "Under Bark" or "Over Bark". The attribute MeasuringMethodType defines how the value is created, e.g. measured automatically, calculated etc. The attribute IsAverageValue indicates if the value is an average value or not.

PropertySubValue can specify a value for a property related to the property specified by the attribute PropertyType of PropertyValue. PropertyValueOfWhichMax and PropertyValueOfWhichMin can specify maximum and minimum values for properties that are part of the property specified by the attribute PropertyType of PropertyValue.

DeductionInfo

DeductionInfo is optional. Multiple instances might exist.

A grouping element that contains information about deductions of quantities.

SampleCharacteristics

SampleCharacteristics is optional A single instance might exist.

A grouping element that contains information related to a sample.

ItemInformation

The purpose of the ItemInformation structure is to clearly identify physical items. The attribute ItemType defines the type of physical item. Physical items can be handling units like packages as well as items contained in packages.

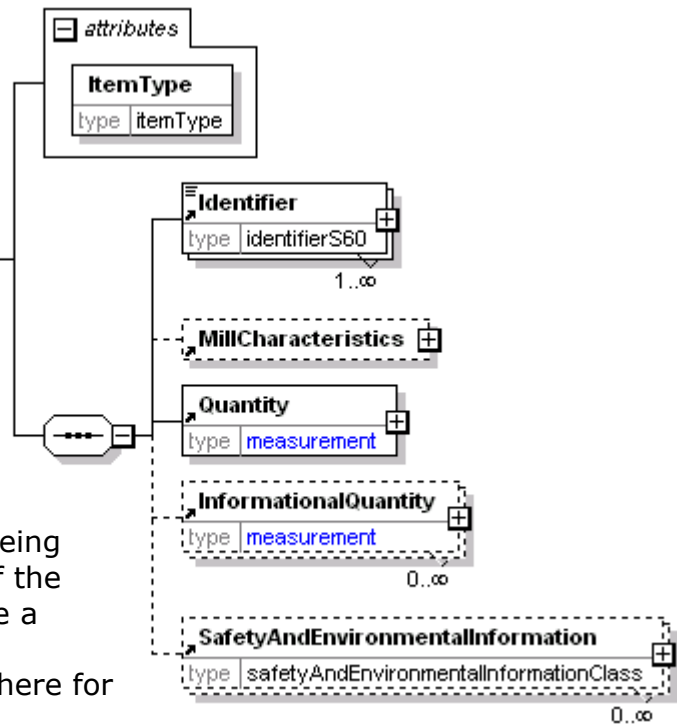

ItemType [attribute]

ItemType is mandatory. A single instance is required.

Indicates the form of the item being reported as being used. Many of the ItemType(s) indicated here have a corresponding named element equivalent, which is referenced here for definition purposes.

Refer to ItemType definition for any enumerations.

(sequence)

The sequence of items below is mandatory. A single instance is required.

Identifier

Identifier is mandatory. One instance is required, multiple instances might exist.

An Identifier is required for packages and items (pallets, reel packages, boxes, ream items, reel items, etc). The Identifier element contains the actual item identifier code. Identifier is repeatable so more than one identifier can be communicated. For example, the printed identifier on a label may be different from the barcode printed on the label.

MillCharacteristics

MillCharacteristics is optional. A single instance might exist.

A group item defining the mill party and machine identifier where a product is or was produced.

Quantity

Quantity is mandatory. A single instance is required.

The Quantity element contains attributes that provide information about the type of quantity that is being communicated, the context in which the particular quantity is to be viewed, and (if the quantity represents an adjustment) an adjustment type.

The Quantity element contains three child elements that enable you to communicate a range of values for the quantity and a target or actual value. It is at this level (Value, RangeMin, and RangeMax) that the unit of measure is specified. This permits the range to be specified in a different unit of measure than the target.

InformationalQuantity

InformationalQuantity is optional. Multiple instances might exist.

papiNet V2R31

A quantity given in a valid UOM used for information purposes only (not for calculation). For example, an ordered quantity was 100 reels as opposed to the invoice quantity of 20,000 pounds.

SafetyAndEnvironmentalInformation

SafetyAndEnvironmentalInformation is optional. Multiple instances might exist.

Name of certification type, if any, on the goods (For example, FSC, PEFC). SafetyAndEnvironmental needs a value or measurement to communicate the percentage of the product is certified (for example, 75% is certified by the indicated agency).

ItemisedUsageLineItem

A group item containing information that relates to an itemized amount of usage.

(sequence)

The sequence of items below is mandatory. A single instance is required.

Product

Product is optional. A single instance might exist.

Product is a group item defining the article and its characteristics. Product is used to specify product characteristics organized by ProductIdentifier, ProductDescription, and Classification. Book Manufacturing, Label Stock, Paper, Pulp, Recovered Paper, Wood Products, and Virgin Fibre market segments have defined their product characteristics and conversion features for implementation in papiNet.

PurchaseOrderInformation

PurchaseOrderInformation is optional. A single instance might exist.

A group item containing information unique to this PurchaseOrder, which is provided by the buyer. PurchaseOrderInformation can be optional in the supply chain. Invoices are created without having a PurchaseOrder in Vendor Managed Inventory. Freight invoices also will not have a PurchaseOrder number.

PurchaseOrderLineItemNumber

PurchaseOrderLineItemNumber is optional. A single instance might exist.

The sequential number that uniquely identifies the PurchaseOrder line item.

Quantity

Quantity is optional. A single instance might exist.

The Quantity element contains attributes that provide information about the type of quantity that is being communicated, the context in which the particular quantity is to be viewed, and (if the quantity represents an adjustment) an adjustment type.

The Quantity element contains three child elements that enable you to communicate a range of values for the quantity and a target or actual value. It is at this level (Value, RangeMin, and RangeMax) that the unit of measure is specified.

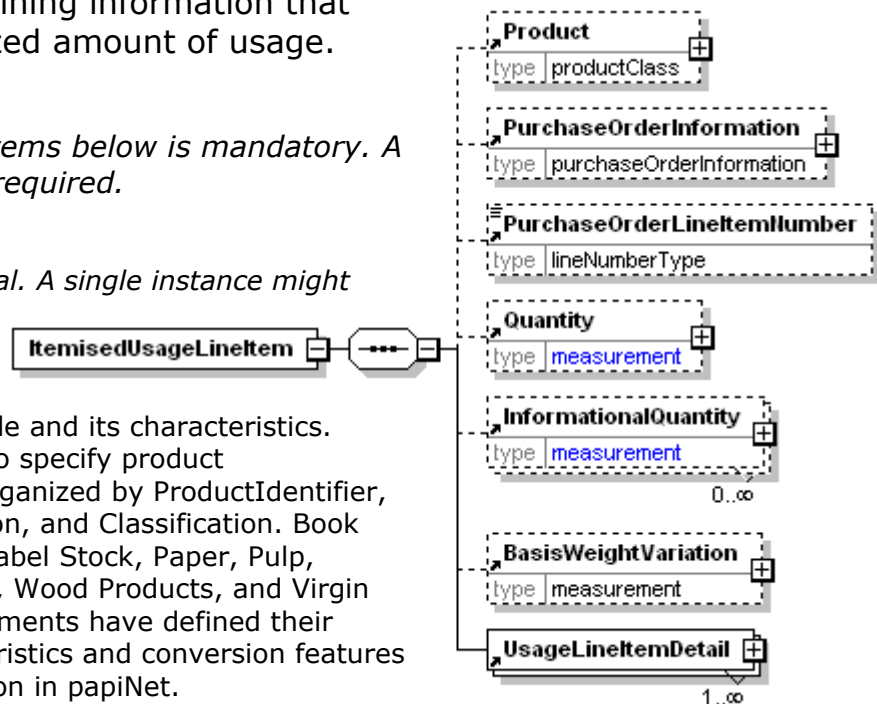

This permits the range to be specified in a different unit of measure than the target.

InformationalQuantity

InformationalQuantity is optional. Multiple instances might exist.

A quantity given in a valid UOM used for information purposes only (not for calculation). For example, an ordered quantity was 100 reels as opposed to the invoice quantity of 20,000 pounds.

BasisWeightVariation

BasisWeightVariation is optional. A single instance might exist.

BasisWeightVariation is the measured difference between the mill target basis weight and the mill actual basis weight.

UsageLineItemDetail

UsageLineItemDetail is mandatory. One instance is required, multiple instances might exist.

For each ItemisedUsageLineItem there must be one or more UsageLineItemDetail. This element lists the specific product that has been consumed.

ItemMeasuringInfo

A grouping element that contains information about measured items.

UnCompletedMeasurement [attribute]

UnCompletedMeasurement is optional. A single instance might exist.

Indicates if the measuring of an item is uncompleted, i.e. if some measurement values are missing.

Refer to UnCompletedMeasurement definition for any enumerations.

(sequence)

The sequence of items below is mandatory. A single instance is required.

ItemInfo

ItemInfo is mandatory. A single instance is required.

A grouping element that contains information about an item. The attribute ItemType defines the type of physical item. Item Info describes property values of an item as well as tracking information between items processed in the supply chain.

DownGradingInfo

DownGradingInfo is optional. A single instance might exist.

A grouping element that contains information about downgrading of products.

PriceAndAmountInfo

PriceAndAmountInfo is optional. A single instance might exist.

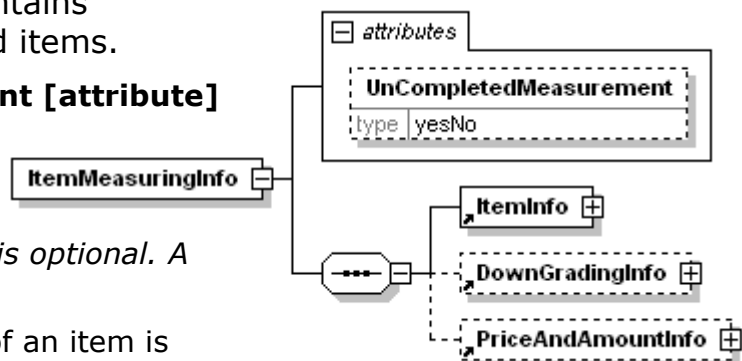

A grouping element that contains information about price and amounts.

ItemReference

An element detailing relevant references pertaining to the Item as indicated by ItemReferenceType and AssignedBy.

ItemReferenceType [attribute]

ItemReferenceType is mandatory. A single instance is required.

Provides a contextual explanation of the specific reference identifier. Many items are currently prefixed by "Buyer", "Forwarder", "Manufacturer", "Mill", "Seller", "Supplier", "Warehouse", or "Vendor". Check for an existing non-prefixed version and use the non-prefixed version instead. In the (yet to be announced release date) version 3.0 the prefixed versions will be removed. Instead the attribute @AssignedBy will communicate the information previously communicated in the prefix.

Refer to ItemReferenceType definition for any enumerations.

AssignedBy [attribute]

AssignedBy is optional. A single instance might exist.

Identifies the type of party or the agency that has assigned the associated item, e.g. a reference of type OrderNumber.

Refer to AssignedBy for any enumerations.

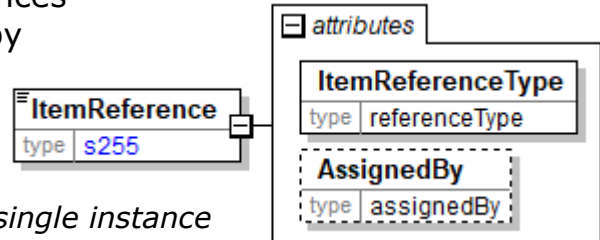

ItemReferenceType [attribute]

Provides a contextual explanation of the specific reference identifier. Many items are currently prefixed by "Buyer", "Forwarder", "Manufacturer", "Mill", "Seller", "Supplier", "Warehouse" or "Vendor". Check for an existing non-prefixed version and use the non-prefixed version instead. In the (yet to be announced release date) version 3.0 the prefixed versions will be removed. Instead the attribute AssignedBy will communicate the information previously communicated in the prefix.

Refer to the [referenceType](#) entry for the list of enumerations and their definitions.

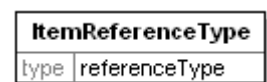

ItemsPerPallet

The number of items on the pallet (either reels or sheet or sheet-package).

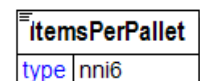

ItemsPerTier

Number of items on each full tier, e.g. number of boxes, gaylords, loose books etc. on a tier on a pallet.

ItemsPerTier	
type	nni3

ItemType [attribute]

Indicates the form of the item being reported as being used. Many of the ItemType(s) indicated here have a corresponding named element equivalent, which is referenced here for definition purposes.

attribute	
ItemType	
type	itemType

This item is restricted to the following list.

BaleItem

Box

BoxItem

CalibrationCheckItem

An item used for calibration checks of measuring equipments.

Load

A Load contains all goods on a transport carried by one or many transport units.

Log

A cut portion of a stem.

LogBundle

A bundle of logs (a virtual type of item).

LogMultiProduct

A log composed of several virtual log segments with different products.

LogPile

A pile of logs (a virtual type of package).

LogSegment

An uncut virtual portion of a multi product log.

LooseVolumeItem

A unit containing loose volume products (during transports) (a type of virtual package).

Pallet

PulpUnit

ReamItem

ReelItem

ReelPackage

Stem

A tree without branches.

Tambour

TankCompartment

A compartment in a divided tank.

TransportUnit

A transport unit contains goods and moves using power from another source, the transport vehicle, e.g. a RailCar, a Trailer, a DrawbarCombinations etc.

ItemVersionNumber

The assigned version number of an information item.
For example, version 2.1 of an item.

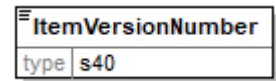

JewelBox

Jewel box.

JewelBoxType [attribute]

JewelBoxType is optional. A single instance might exist.

The type of jewel box (container for CD or DVD).

Refer to JewelBoxType definition for any enumerations.

TrayColourType [attribute]

TrayColourType is optional. A single instance might exist.

The type of tray colour.

Refer to TrayColourType definition for any enumerations.

InlayCardQuantity [attribute]

InlayCardQuantity is optional. A single instance might exist.

Inlay card quantity

Refer to InlayCardQuantity definition for any enumerations.

WrapType [attribute]

WrapType is optional. A single instance might exist.

Communicates the type of material used to wrap the product.

Refer to WrapType definition for any enumerations.

TearStripType [attribute]

TearStripType is optional. A single instance might exist.

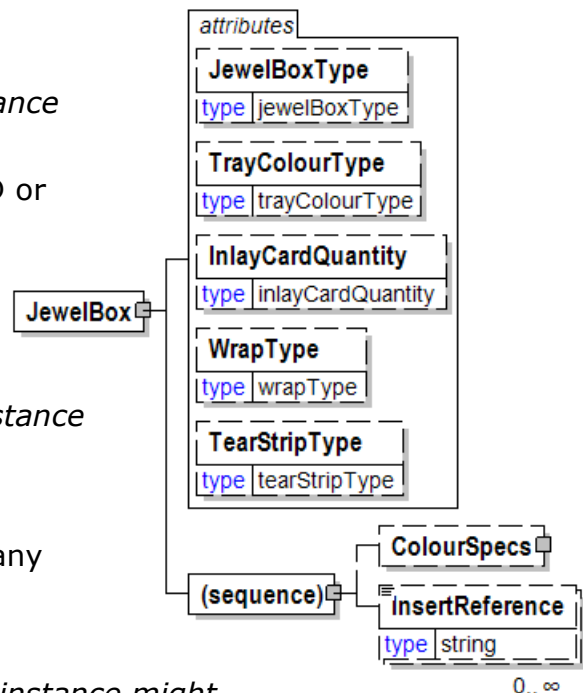

papiNet V2R31

Tear Strip Type

Refer to TearStripType definition for any enumerations.

(sequence)

The sequence of items below is mandatory. A single instance is required.

ColourSpecs

ColourSpecs is optional. A single instance might exist.

Colour specs

InsertReference

InsertReference is optional. Multiple instances might exist.

Insert reference

JewelBoxType [attribute]

The type of jewel box (container for CD or DVD).

This item is restricted to the following list.

Double

JewelBox holds 2 CDs.

DoubleSlimLine

DoubleSlimLineLiveHinge

MidFrameDouble2LiveHinge

MidFrameDouble2SingleTray

Quad3-4CDs

Quad5CDs

Quad6CDs

Single

JewelBox holds a single CD.

StandardSingleTray

Triple

JewelBox holds a single CD.

Other

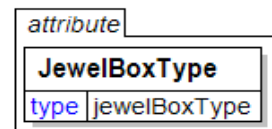

JobCode

The particular identification code of printing an entire request known as a job.

Agency [attribute]

Agency is optional. A single instance might exist.

Describes the agency maintaining the list of codes. To be included in this list

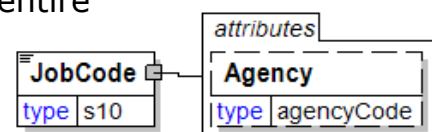

papiNet V2R31

the agency must be a recognized standards body or industry organisation.

- For the element that owns this attribute.
- For another attribute in the list of attributes associated with the parent element.

Refer to Agency definition for any enumerations.

JobDateTimeRange

The specification of the date range for the job.

(sequence)

The sequence of items below is mandatory. A single instance is required.

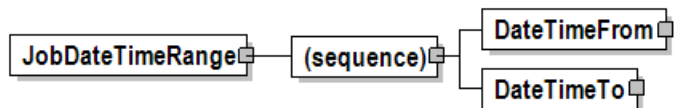

DateTimeFrom

DateTimeFrom is mandatory. A single instance is required.

The start or beginning Date and Time of a date range.

DateTimeTo

DateTimeTo is mandatory. A single instance is required.

The ending Date and Time of a date/time range.

JobDescription

A textual description of the job.

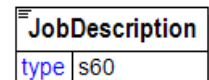

JobID

An element used to communicate the unique identifier of the Job

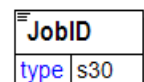

JobInformation

JobInformation is optional. This construct captures information specific to the entire job set up.

(sequence)

The sequence of items below is mandatory. A single instance is required.

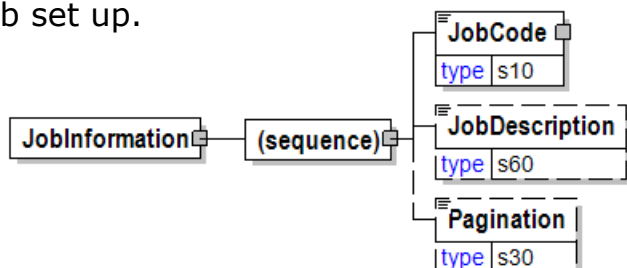

JobCode

JobCode is mandatory. A single instance is required.

The particular identification code of printing an entire request known as a job.

JobDescription

JobDescription is optional. A single instance might exist.

A textual description of the job.

Pagination

Pagination is optional. A single instance might exist.

Number of pages that make up a book.

Joining

Defines the method used to join pieces of wood.

JoiningType [attribute]

JoiningType is optional. A single instance might exist.

Defines the type of mechanical joint employed in manufacture of the product.

Refer to JoiningType definition for any enumerations.

(sequence)

The sequence of items below is mandatory. A single instance is required.

AdditionalText

AdditionalText is optional. A single instance might exist.

A text field that is used to communicate information not previously defined or for special instructions. To be used only for circumstances not covered by specific elements.

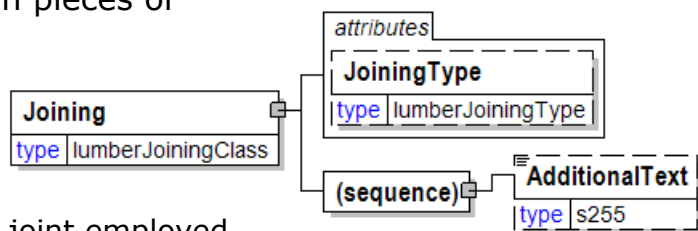

JoiningType [attribute]

Defines the type of mechanical joint employed in manufacture of the product.

This item is restricted to the following list.

FingerJointed

FingerJointed-VertUseOnly

Glued-Up

Other

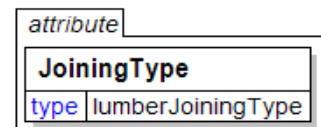

L

The "L" component of the method of communicating colour termed L^*a^*b .

(sequence)

The sequence of items below is mandatory. A single instance is required.

DetailValue

DetailValue is mandatory. A single instance is required.

A numeric value expressed in the unit of measure (UOM).

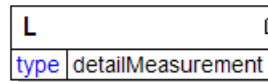

DetailRangeMin

DetailRangeMin is optional. A single instance might exist.

The minimum value (lower boundary) allowed for the DetailValue that is the parent of this element.

DetailRangeMax

DetailRangeMax is optional. A single instance might exist.

The maximum value (upper boundary) allowed for the DetailValue that is the parent of this element.

StandardDeviation

StandardDeviation is optional. A single instance might exist.

A statistic used as a measure of dispersion in a distribution.

SampleSize

SampleSize is optional. A single instance might exist.

The number of samples used to determine the product characteristic in question.

TwoSigmaLower

TwoSigmaLower is optional. A single instance might exist.

Two sigma (a measure of dispersion associated with standard deviation) on the lower side of the standard deviation.

TwoSigmaUpper

TwoSigmaUpper is optional. A single instance might exist.

Two sigma (a measure of dispersion associated with standard deviation) on the upper side of the standard deviation.

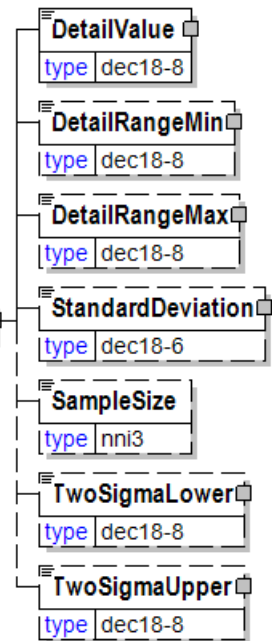

Lab

A definition of colour using the L*a*b protocol.

L*a*b colour consists of a luminance or lightness component (L) and two chromatic components: a component (from green to red) and the b component (from blue to yellow). All the components of the definition are required. The structure of Luminance, "a", and "b" follows DetailMeasurement.

TestMethod [attribute]

TestMethod is optional. A single instance might exist.

The method used to determine the results of the test under consideration.

TestAgency [attribute]

TestAgency is optional. A single instance might exist.

The agency that has set the parameters for the testing

Refer to TestAgency definition for any enumerations.

SampleType [attribute]

SampleType is optional. A single instance might exist.

Communicates how sampling was done to measure the product characteristics.

Refer to SampleType definition for any enumerations.

ResultSource [attribute]

ResultSource is optional. A single instance might exist.

Used to define the data source of the specified test

Refer to ResultSource definition for any enumerations.

(sequence)

The sequence of items below is mandatory. A single instance is required.

L

L is optional. A single instance might exist.

The "L" component of the method of communicating colour termed L*a*b.

a

a is mandatory. A single instance is required.

The "a" portion of the method of colour represented by L*a*b.

b

b is mandatory. A single instance is required.

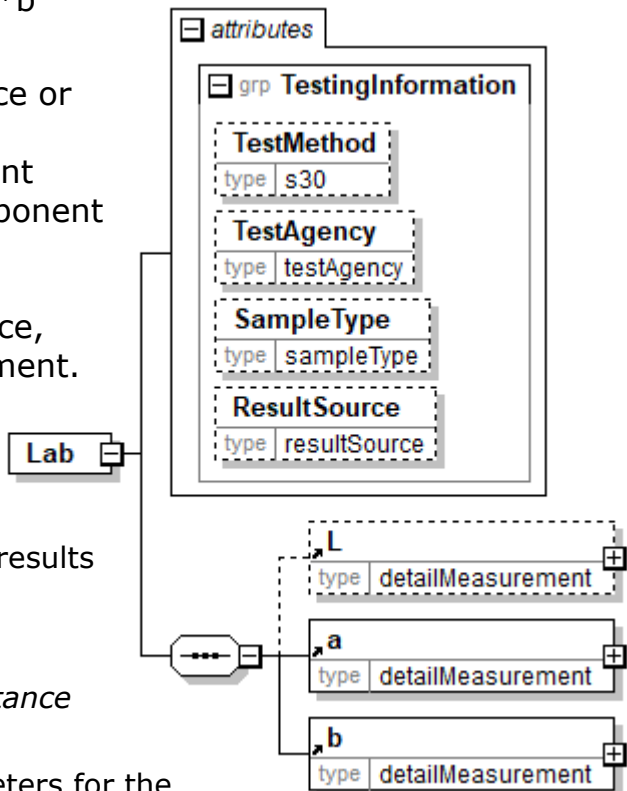

papiNet V2R31

The "b" component of the method of communicating colour termed L*a*b.

LabelBrandName

The trade name or brand name used or, to be used for the label stock.

LabelBrandName
type s30

LabelCharacteristics

A group item that organises the labeling information.

(sequence)

The sequence of items below is mandatory. A single instance is required.

CustomerMarks

CustomerMarks is optional. Multiple instances might exist.

The text that the buyer wants the seller to print on the package label or elsewhere.

LabelStyle

LabelStyle is optional. A single instance might exist.

A text field describing the type of special label layout requested by the buyer.

LabelBrandName

LabelBrandName is optional. A single instance might exist.

The trade name or brand name used or, to be used for the label stock.

LabelPosition

LabelPosition is optional. A single instance might exist.

Information about where the label is to be placed on the package.

NumberOfLabels

NumberOfLabels is optional. A single instance might exist.

The number of labels to be placed on the package.

Length

Length is optional. A single instance might exist.

The length of the object.

Width

Width is optional. A single instance might exist.

The width of the object.

ColourCode

ColourCode is optional. A single instance might exist.

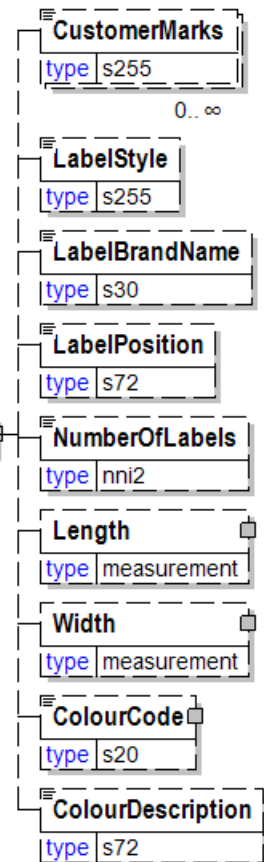

A code indicating the colour.

ColourDescription

ColourDescription is optional. A single instance might exist.

A free form description of the colour.

LabelOrientation [attribute]

Specifies label orientation for loaded goods seen in the transport direction of the goods carrier. It makes the label visible during unloading from a predetermined side.

attribute
LabelOrientation
type labelOrientationType

This item is restricted to the following list.

BackEndSide

Goods labels are oriented towards the back-end side

FrontEndSide

Goods labels are oriented towards the front-end side

LeftAndRightSide

Goods labels are oriented towards the left side for goods to be unloaded from the left side and towards the right side for goods to be unloaded from the right side.

LeftSide

Goods labels are oriented towards the left side

RightSide

Goods labels are oriented towards the right side

LabelPosition

Information about where the label is to be placed on the package.

LabelPosition
type s72

LabelStock

LabelStock contains the attributes and characteristics that define the label stock product.

(sequence)

The sequence of items below is mandatory. A single instance is required.

LabelStockCharacteristics

LabelStockCharacteristics is optional. A single instance might exist.

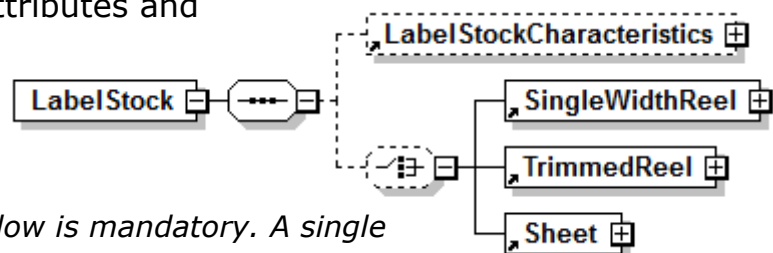

Label stock characteristics.

(choice)

[choice] is optional. A single instance might exist.

SingleWidthReel

SingleWidthReel is mandatory. A single instance is required.

Single width reel information.

TrimmedReel

TrimmedReel is mandatory. A single instance is required.

Trimmed reel

Sheet

Sheet is mandatory. A single instance is required.

A group item that contains the conversion and packaging characteristics for sheets.

LabelStockCharacteristics

Label stock characteristics.

(sequence)

The sequence of items below is mandatory. A single instance is required.

LabelStockLayer

LabelStockLayer is optional. Multiple instances might exist.

Label stock layer

ExtraFeature

ExtraFeature is optional. Multiple instances might exist.

A special or extra feature that the label has or needs.

AdditionalText

AdditionalText is optional. Multiple instances might exist.

A text field that is used to communicate information not previously defined or for special instructions. To be used only for circumstances not covered by specific elements.

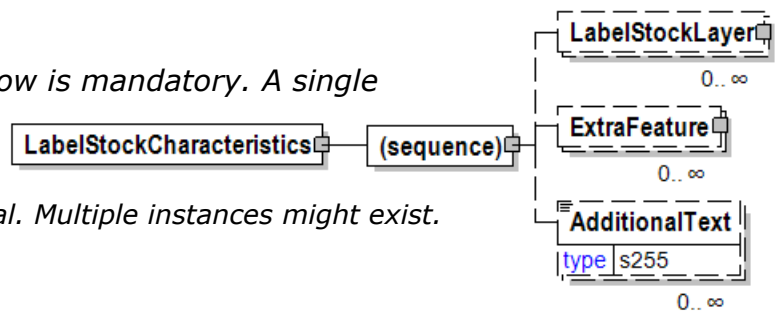

LabelStockLayer

Label stock layer

(sequence)

The sequence of items below is mandatory. A single instance is required.

LabelStockLayerType

LabelStockLayerType is mandatory. A single instance is required.

The label stock layer type

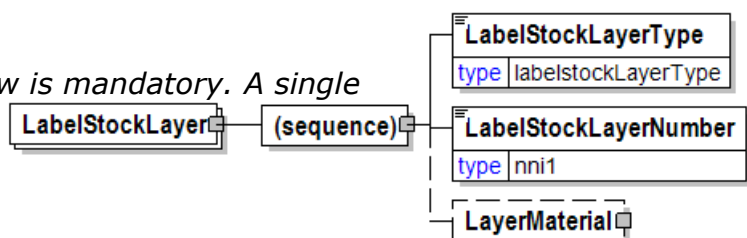

papiNet V2R31

Refer to LabelStockLayerType definition for any enumerations.

LabelStockLayerNumber

LabelStockLayerNumber is mandatory. A single instance is required.

The label stock layer number

LayerMaterial

LayerMaterial is optional. A single instance might exist.

Used to identify the materials used in the layers of the label.

LabelStockLayerNumber

The label stock layer number

LabelStockLayerNumber	
type	nni1

LabelStockLayerType

The label stock layer type

This item is restricted to the following list.

Adhesive

Backing

Face

Silicon

LabelStockLayerType	
type	labelstockLayerType

LabelStyle

A text field describing the type of special label layout requested by the buyer.

LabelStyle	
type	s255

Language [attribute]

The valid Alpha 2- and Alpha 3-character list of language codes in the ISO 639-1 and 639-2 international standards.

Information on the content of this attribute is available at:

https://www.loc.gov/standards/iso639-2/php/code_list.php

attribute	
Language	
type	languageType
default	eng

LargeEndDiameter

Used to report the log butt end diameter as a measurement.

(sequence)

The sequence of items below is mandatory. A single instance is required.

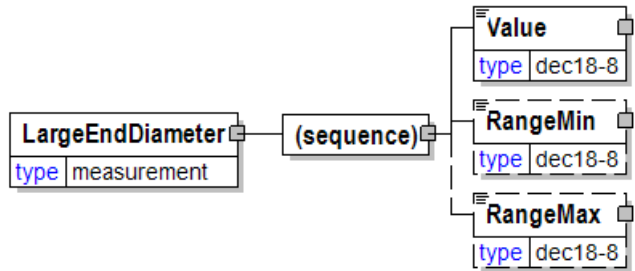

Value

Value is mandatory. A single instance is required.

A numeric value expressed in the unit of measure (UOM).

RangeMin

RangeMin is optional. A single instance might exist.

The minimum value (lower boundary) allowed for the Measurement that is the parent of this element.

RangeMax

RangeMax is optional. A single instance might exist.

The maximum value (upper boundary) allowed for the Measurement that is the parent of this element. Some elements use the RangeMax element with an extended list of unit of measures. (Note: the red colour in the picture is an artifact of how the graphic was captured and should be disregarded.)

LastDateOfChange

The last date for which changes to the line item may occur before it is "locked" in the production process.

LastDateOfChange encapsulates Date.

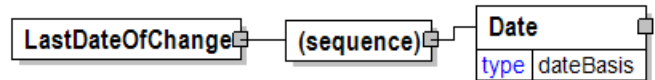

(sequence)

The sequence of items below is mandatory. A single instance is required.

Date

Date is mandatory. A single instance is required.

A group element that contains the specification of Year, Month, and Day.

Latitude

A measurement of the position of the party or contact in degrees north or south of the equator

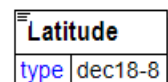

LayerMaterial

Used to identify the materials used in the layers of the label.

(sequence)

The sequence of items below is mandatory. A single instance is required.

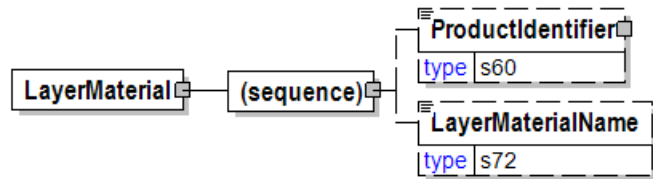

ProductIdentifier

ProductIdentifier is optional. A single instance might exist.

Used to communicate the code of the article, in a variety of formats designated by the type.

LayerMaterialName

LayerMaterialName is optional. A single instance might exist.

The layer material name

LayerMaterialName

The layer material name

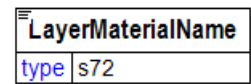

LayersPerUnit

The number of layers on the shipping, handling, or delivery unit. (This element uses pattern matching to ensure the appropriate format for latitude.)

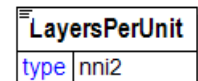

LegStageType [attribute]

LegStageType is used to identify whether this is the primary transportation process or a transportation process that comes before or after the main transportation process.

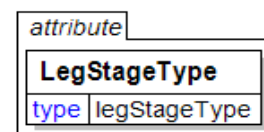

This item is restricted to the following list.

PreCarriage

The initial transport of goods from the seller's premises to the main port of shipment. Usually by truck, rail or on inland waterways.

MainCarriage

The primary transport of goods, generally for the longest part of the journey and generally from one country to another. Usually by sea vessel or by airplane, but can be truck or rail as well.

OnCarriage

Transport from the port of arrival in the country of destination to the buyer's premises. Usually by truck, rail or on inland waterways.

Length

The approach to length used in the timber/lumber related constructs.

ActualNominal [attribute]

ActualNominal is optional. A single instance might exist.

Indicates the measurement approach used to communicate the dimensions of the

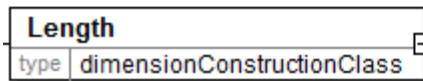

individual pieces.

Refer to ActualNominal definition for any enumerations.

WithGrain [attribute]

WithGrain is optional. A single instance might exist.

Either "Yes" or "No".

Refer to WithGrain definition for any enumerations.

(choice)

[choice] is optional. A single instance might exist.

Value

Value is mandatory. A single instance is required.

A numeric value expressed in the unit of measure (UOM).

(sequence)

The sequence of items below is mandatory. A single instance is required.

RangeMin

RangeMin is optional. A single instance might exist.

The minimum value (lower boundary) allowed for the Measurement that is the parent of this element.

RangeMax

RangeMax is optional. A single instance might exist.

The maximum value (upper boundary) allowed for the Measurement that is the parent of this element. Some elements use the RangeMax element with an extended list of unit of measures. (Note: the red colour in the picture is an artifact of how the graphic was captured and should be disregarded.)

AdditionalText

AdditionalText is mandatory. One instance is required, multiple instances might exist.

A text field that is used to communicate information not previously defined or for

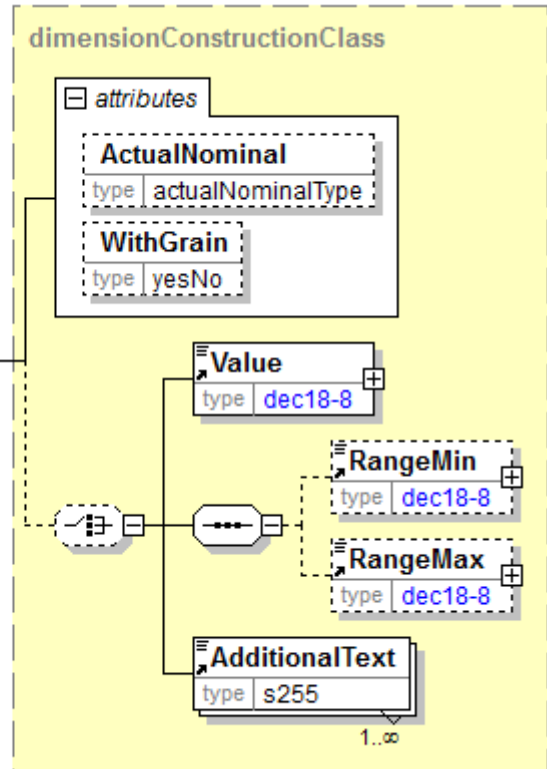

special instructions. To be used only for circumstances not covered by specific elements.

Length

The length of the object. (Used in wood/timber items.)

ActualNominal [attribute]

ActualNominal is optional. A single instance might exist.

Indicates the measurement approach used to communicate the dimensions of the individual pieces.

Refer to ActualNominal definition for any enumerations.

(choice)

[choice] is mandatory. A single instance is required.

Value

Value is mandatory. A single instance is required.

A numeric value expressed in the unit of measure (UOM).

(sequence)

The sequence of items below is mandatory. A single instance is required.

RangeMin

RangeMin is optional. A single instance might exist.

The minimum value (lower boundary) allowed for the Measurement that is the parent of this element.

RangeMax

RangeMax is optional. A single instance might exist.

The maximum value (upper boundary) allowed for the Measurement that is the parent of this element. Some elements use the RangeMax element with an extended list of unit of measures. (Note: the red colour in the picture is an artifact of how the graphic was captured and should be disregarded.)

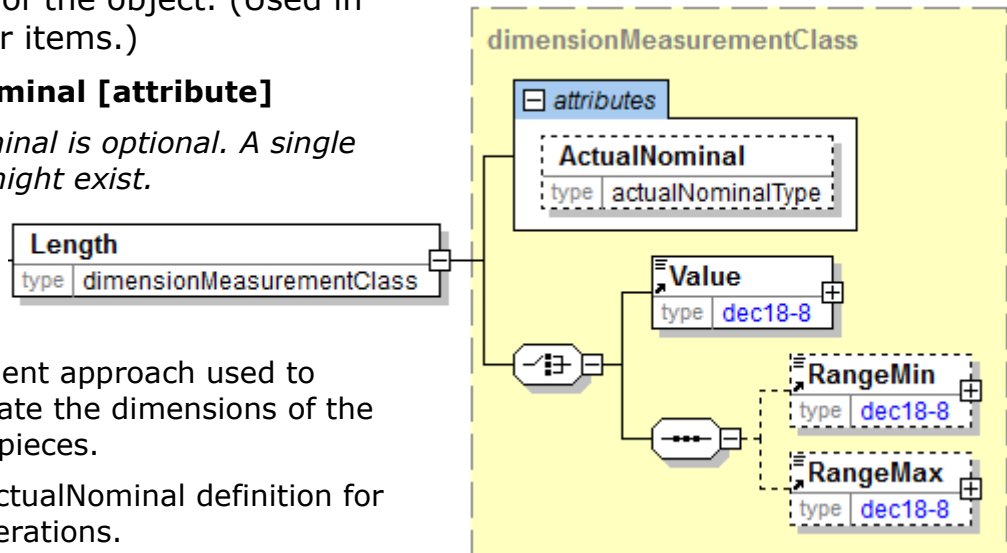

Length

The length of the object.

(sequence)

The sequence of items below is mandatory. A single instance is required.

Value

Value is mandatory. A single instance is required.

A numeric value expressed in the unit of measure (UOM).

RangeMin

RangeMin is optional. A single instance might exist.

The minimum value (lower boundary) allowed for the Measurement that is the parent of this element.

RangeMax

RangeMax is optional. A single instance might exist.

The maximum value (upper boundary) allowed for the Measurement that is the parent of this element. Some elements use the RangeMax element with an extended list of unit of measures. (Note: the red colour in the picture is an artifact of how the graphic was captured and should be disregarded.)

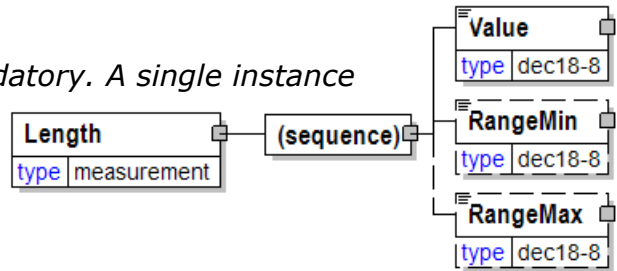

LengthCategory

Value of the length category.

UOM [attribute]

UOM is optional. A single instance might exist.

Defines the unit of measure for the value.

Refer to UOM definition for any enumerations.

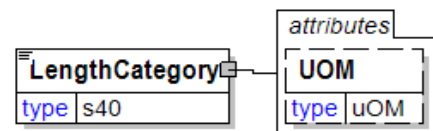

LengthCutDescription

Length Cut Description

LengthCutType [attribute]

LengthCutType is optional. A single instance might exist.

Indicates whether the timber length is in dimensional modules, free length or exact cut length.

Refer to LengthCutType definition for any enumerations.

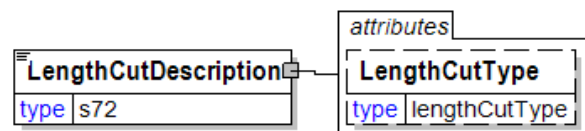

LengthCutType [attribute]

Indicates whether the timber length is in dimensional modules, free length or exact cut length.

This item is restricted to the following list.



ExactLength

The product is cut within agreed tolerance.

FreeCut

The product is free cut.

SpecialLength

The product is cut in a specific length as usually cut.

Untrimmed

The product is untrimmed.

1DecimeterCut

The product is cut in one decimeter interval.

3DecimeterCut

The product is cut in three decimeter interval.

LengthFromCore

In relationship to a paper event (usually a mill join) where is the event in terms of the length of the paper.

(sequence)

The sequence of items below is mandatory. A single instance is required.

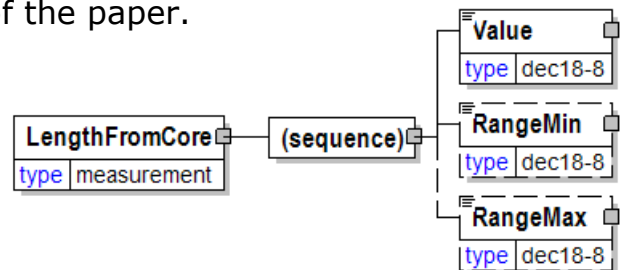

Value

Value is mandatory. A single instance is required.

A numeric value expressed in the unit of measure (UOM).

RangeMin

RangeMin is optional. A single instance might exist.

The minimum value (lower boundary) allowed for the Measurement that is the parent of this element.

RangeMax

RangeMax is optional. A single instance might exist.

The maximum value (upper boundary) allowed for the Measurement that is the parent of this element. Some elements use the RangeMax element with an extended list of unit of measures. (Note: the red colour in the picture is an artifact of how the graphic was captured and should be disregarded.)

LengthSpecification

Length specification of the wood product.

(sequence)

The sequence of items below is mandatory. A single instance is required.

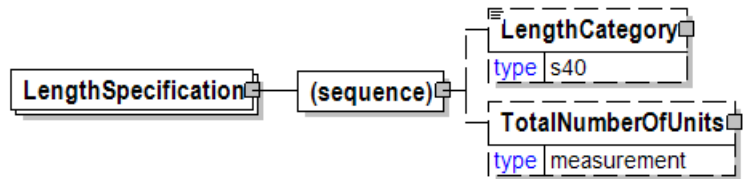

LengthCategory

LengthCategory is optional. A single instance might exist.

Value of the length category.

TotalNumberOfUnits

TotalNumberOfUnits is optional. A single instance might exist.

The total number of units.

LengthType [attribute]

Defines the type of source for how length is given. The attribute Agency can define the source.

This item is restricted to the following list.

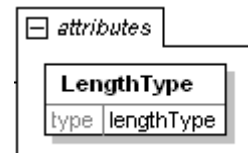

AdditionalAdjusted

An additional adjustment of given length, e.g. an additional adjustment of the length for a route when the vehicle is driven an extra distance for loading or unloading.

Estimated

The length is estimated, e.g. the length of a route is manually calculated from maps.

Measured

The length is measured, e.g. the length of a route is measured by driving a vehicle.

NationalForestRoadDatabase

The length of a road or a route is based on information from a national forest road database.

NationalRoadDatabase

The length of a road or a route is based on information from a national road database.

LengthTypeVersion [attribute]

Specifies the version of the source for a length type.

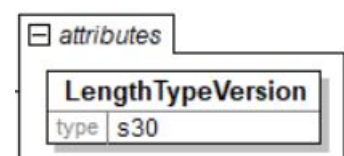

LicenceNumber

Licence number.

Note: the spelling of this element conforms to papiNet's use of UK English.

LicenceNumber	
type	s30

LightScattering

A group item used to communicate light scattering coefficients according to a particular TestMethod.

TestMethod [attribute]

TestMethod is optional. A single instance might exist.

The method used to determine the results of the test under consideration.

TestAgency [attribute]

TestAgency is optional. A single instance might exist.

The agency that has set the parameters for the testing

Refer to TestAgency definition for any enumerations.

SampleType [attribute]

SampleType is optional. A single instance might exist.

Communicates how sampling was done to measure the product characteristics.

Refer to SampleType definition for any enumerations.

ResultSource [attribute]

ResultSource is optional. A single instance might exist.

Used to define the data source of the specified test

Refer to ResultSource definition for any enumerations.

(sequence)

The sequence of items below is mandatory. A single instance is required.

DetailValue

LightScattering	
type	detailMeasurement

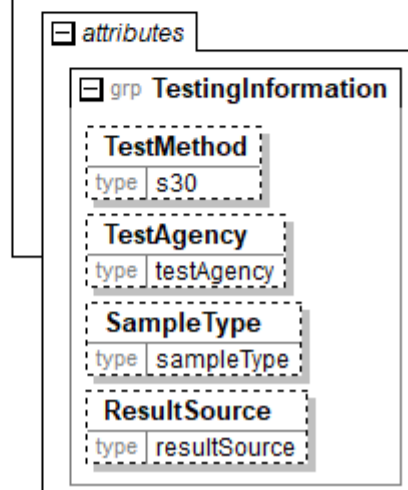
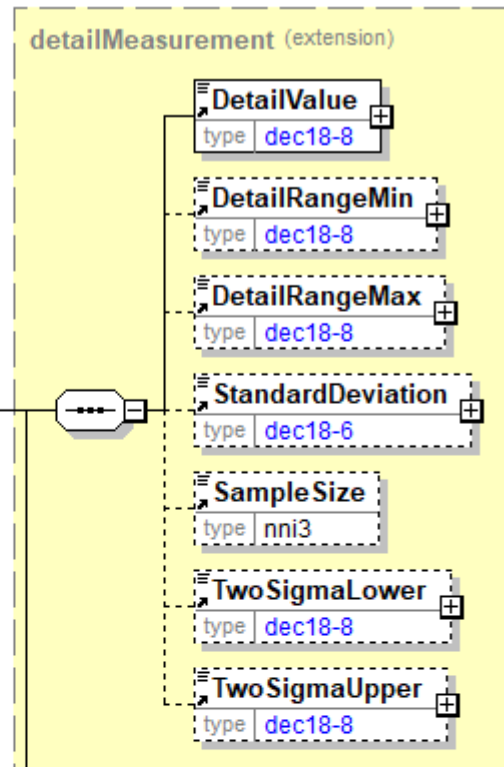

papiNet V2R31

DetailValue is mandatory. A single instance is required.

A numeric value expressed in the unit of measure (UOM).

DetailRangeMin

DetailRangeMin is optional. A single instance might exist.

The minimum value (lower boundary) allowed for the DetailValue that is the parent of this element.

DetailRangeMax

DetailRangeMax is optional. A single instance might exist.

The maximum value (upper boundary) allowed for the DetailValue that is the parent of this element.

StandardDeviation

StandardDeviation is optional. A single instance might exist.

A statistic used as a measure of dispersion in a distribution.

SampleSize

SampleSize is optional. A single instance might exist.

The number of samples used to determine the product characteristic in question.

TwoSigmaLower

TwoSigmaLower is optional. A single instance might exist.

Two sigma (a measure of dispersion associated with standard deviation) on the lower side of the standard deviation.

TwoSigmaUpper

TwoSigmaUpper is optional. A single instance might exist.

Two sigma (a measure of dispersion associated with standard deviation) on the upper side of the standard deviation.

LineCuts

A print obtained from a line drawing.

IsLineCuts [attribute]

IsLineCuts is mandatory. A single instance is required.

Indicates if images are Line Cuts or no.

Refer to IsLineCuts definition for any enumerations.

(sequence)

The sequence of items below is mandatory. A single instance is required.

Value

Value is optional. A single instance might exist.

A numeric value expressed in the unit of measure (UOM).

AdditionalText

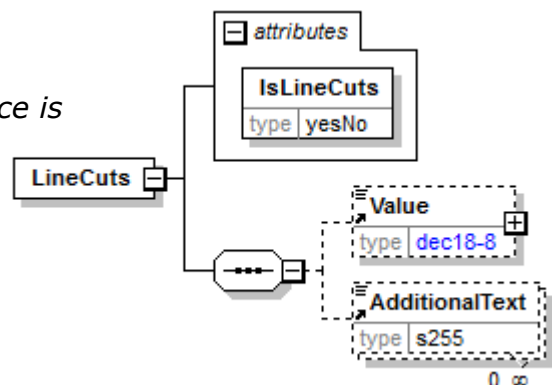

papiNet V2R31

AdditionalText is optional. Multiple instances might exist.

A text field that is used to communicate information not previously defined or for special instructions. To be used only for circumstances not covered by specific elements.

LineBaseAmount

For the particular e-Document being communicated the LineBaseAmount represents the quantity times the base unit price.

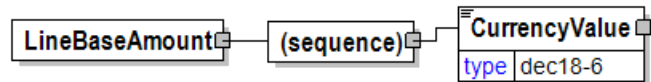

(sequence)

The sequence of items below is mandatory. A single instance is required.

CurrencyValue

CurrencyValue is mandatory. A single instance is required.

The amount in the referenced currency as defined by the CurrencyType attribute.

LineItemNumber

A sequential number that uniquely identifies the line item of an e-Document.

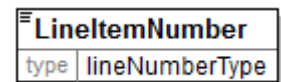

LineItemSubTotal

The total amount of all base amounts on e-Document line items. The base amount contains the result of the calculation quantity times the base unit price. As such it does not include any taxes. For example, in an Invoice claiming payment for products LineItemSubTotal is equal to the sum of all InvoiceLineBaseAmount.

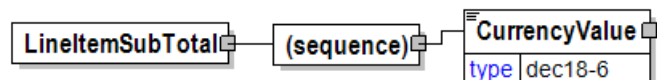

(sequence)

The sequence of items below is mandatory. A single instance is required.

CurrencyValue

CurrencyValue is mandatory. A single instance is required.

The amount in the referenced currency as defined by the CurrencyType attribute.

LoadAvailable

The LoadAvailable element is the root element for the LoadAvailable e-Document.

The Supplier party or authorized agent sends a LoadAvailable e-Document to the BuyerParty(consuming mill) indicating that load(s) for specific product is(are) ready on a specific date for acceptance and pickup.

The LoadAvailable e-Document from the supplier may include a Shipper Load Number. This number may be used as the consuming mill's release number The Shipper Load Number is used for authorization for pick-up of load at supplier point.

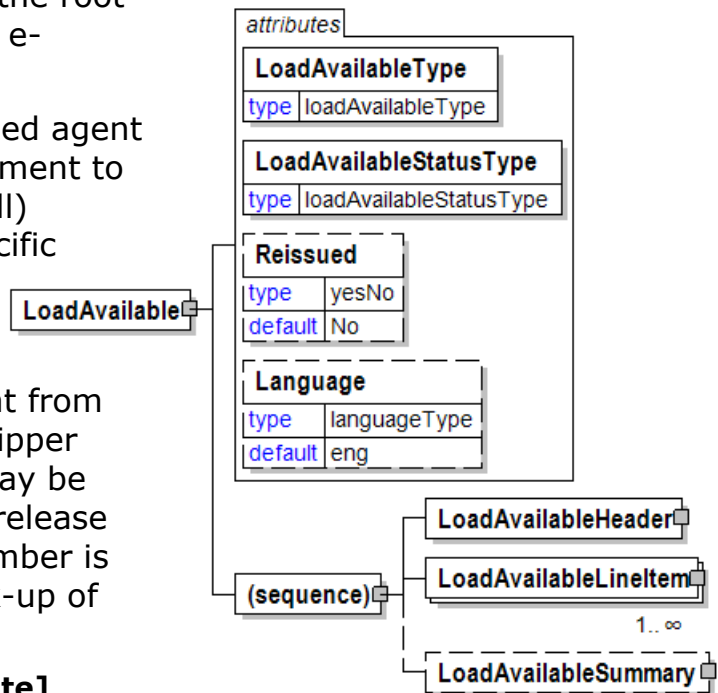

LoadAvailableType [attribute]

LoadAvailableType is mandatory. A single instance is required.

LoadAvailableType defines the type LoadAvailable e-Document. Refer to LoadAvailableType definition for any enumerations.

LoadAvailableStatusType [attribute]

LoadAvailableStatusType is mandatory. A single instance is required.

LoadAvailableStatusType defines the status of the entire LoadAvailable e-Document.

Refer to LoadAvailableStatusType definition for any enumerations.

Reissued [attribute]

Reissued is optional. A single instance might exist.

Either "Yes" or "No".

Refer to Reissued definition for any enumerations.

Language [attribute]

Language is optional. A single instance might exist.

The valid Alpha 2- and Alpha 3-character list of language codes in the ISO 639-1 and 639-2 international standards.

Information on the content of this attribute is available at: https://www.loc.gov/standards/iso639-2/php/code_list.php

(sequence)

The sequence of items below is mandatory. A single instance is required.

LoadAvailableHeader

LoadAvailableHeader is mandatory. A single instance is required.

papiNet V2R31

The LoadAvailableHeader, a group item containing generic information common to the LoadAvailable e-Document.

LoadAvailableLineItem

LoadAvailableLineItem is mandatory. One instance is required, multiple instances might exist.

LoadAvailableLineItem is a group item containing information that relates to a line in the LoadAvailable e-Document.

LoadAvailableSummary

LoadAvailableSummary is optional. A single instance might exist.

LoadAvailable Summary

LoadAvailableConfirmationIssuedDate

The date of response to the LoadAvailable e-Document from originating party.

(sequence)

The sequence of items below is mandatory. A single instance is required.

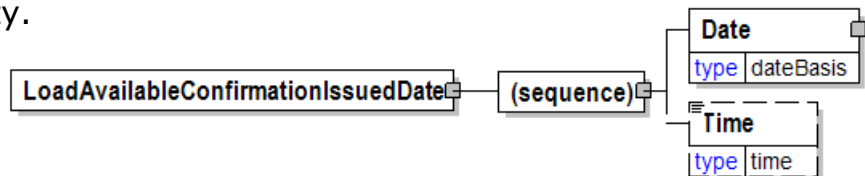

Date

Date is mandatory. A single instance is required.

A group element that contains the specification of Year, Month, and Day.

Time

Time is optional. A single instance might exist.

Times are treated in a standard XML fashion with a special case used to indicate a generalized "local" time. The standard XML approach to time is hh:mm:ss, hh:mm:ssZ, or hh:mm:ss±hh:mm.

hh:mm:ss±hh:mm is used to represent a time with a time zone. The time zone is communicated as the number of hours offset from the Universal Time Coordinate (UTC), a.k.a. Greenwich Mean Time.

hh:mm:ssZ indicates the time at Zulu (another name for UTC).

hh:mm:ss or hh:mm indicates within papiNet the applicable local time where the associated event is taking place. Caution should be used when processing times of this nature as the papiNet approach may be in discord with other users of XML.

LoadAvailableHeader

The LoadAvailableHeader, a group item containing generic information common to the LoadAvailable e-Document.

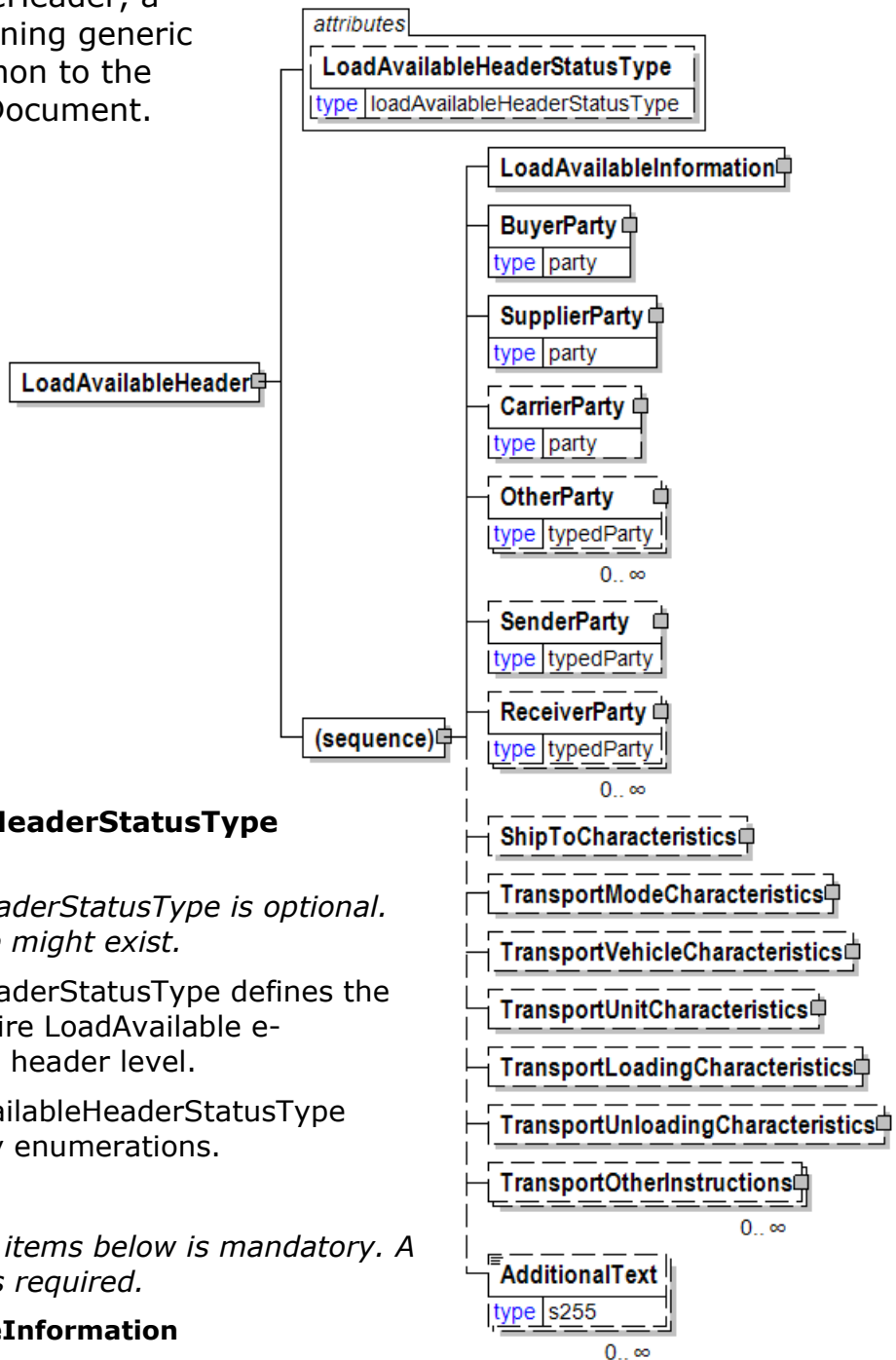

LoadAvailableHeaderStatusType [attribute]

LoadAvailableHeaderStatusType is optional. A single instance might exist.

LoadAvailableHeaderStatusType defines the status of the entire LoadAvailable e-Document at the header level.

Refer to LoadAvailableHeaderStatusType definition for any enumerations.

(sequence)

The sequence of items below is mandatory. A single instance is required.

LoadAvailableInformation

LoadAvailableInformation is mandatory. A single instance is required.

LoadAvailableInformation is a group item containing information about the whole LoadAvailable e-Document.

BuyerParty

BuyerParty is mandatory. A single instance is required.

The legal entity to which the product is sold. Also commonly referred to as the sold-to party or customer. If no OtherParty is defined as the Payer, the Buyer is the Payer.

SupplierParty

SupplierParty is mandatory. A single instance is required.

The organisation or business entity responsible for providing the product. SupplierParty is also the seller of the product, if Seller is not specified as OtherParty = Seller.

CarrierParty

CarrierParty is optional. A single instance might exist.

The party performing the transport of the product from the pickup location to the ship-to location; could be a hauler.

OtherParty

OtherParty is optional. Multiple instances might exist.

An organisation or business entity other than those specifically detailed within an e-Document.

SenderParty

SenderParty is optional. A single instance might exist.

The business entity issuing the e-Document, the source of the document.

The entity responsible for the content. If the sender party has out sourced the message service to a third party the SenderParty is the issuer of the e-Document and not the party performing the transmission service of the electronic message.

ReceiverParty

ReceiverParty is optional. Multiple instances might exist.

The business entity for whom the e-Document is intended, the destination of the document.

The entity interested in the content. If the receiver party has outsourced the message service to a third party the ReceiverParty is the intended party for the e-Document and not the party performing the receiving service of the electronic message.

ShipToCharacteristics

ShipToCharacteristics is optional. A single instance might exist.

A group item that provides information important for the Ship-To Party.

TransportModeCharacteristics

TransportModeCharacteristics is optional. A single instance might exist.

A group item defining the primary mode of transport.

TransportVehicleCharacteristics

TransportVehicleCharacteristics is optional. A single instance might exist.

A group item containing information about a transport vehicle, e.g. a truck. A transport vehicle has its own power and can be used to pull, push, carry, or tow a transport unit loaded with goods.

TransportUnitCharacteristics

TransportUnitCharacteristics is optional. A single instance might exist.

A group item containing information about a transport unit, e.g. a trailer. Transport units contain goods and move using power from another source, the transport vehicle.

TransportLoadingCharacteristics

papiNet V2R31

TransportLoadingCharacteristics is optional. A single instance might exist.

A group item defining how the transported items are to be loaded.

TransportUnloadingCharacteristics

TransportUnloadingCharacteristics is optional. A single instance might exist.

A group item defining how the transported items are to be unloaded.

TransportOtherInstructions

TransportOtherInstructions is optional. Multiple instances might exist.

A group item defining any other instructions for the transport not covered in the description of transport mode, vehicle, unit, and loading characteristics or defining an alternative description for the categories mentioned above.

AdditionalText

AdditionalText is optional. Multiple instances might exist.

A text field that is used to communicate information not previously defined or for special instructions. To be used only for circumstances not covered by specific elements.

LoadAvailableHeaderStatusType [attribute]

LoadAvailableHeaderStatusType defines the status of the entire LoadAvailable e-Document at the header level.

This item is restricted to the following list.

Accepted

The supplied information is accepted.

Amended

The supplied information is changed

NoAction

The supplied information has not been amended and thereby requires no action.

Original

The supplied information is the first version of that information.

Rejected

The supplied information is rejected.



LoadAvailableInformation

LoadAvailableInformation is a group item containing information about the whole LoadAvailable e-Document.

(sequence)

The sequence of items below is mandatory. A single instance is required.

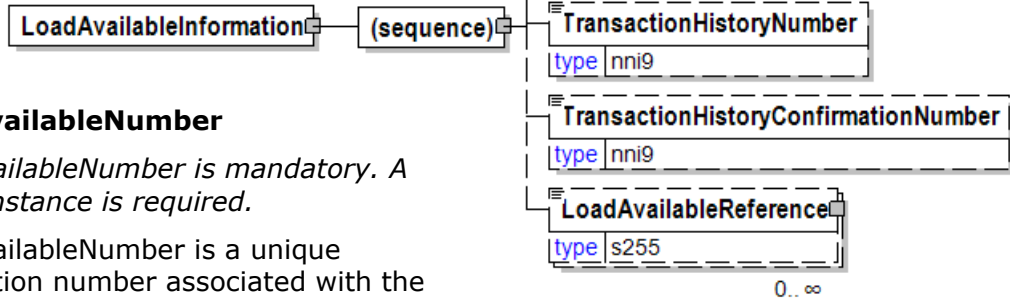

LoadAvailableNumber

LoadAvailableNumber is mandatory. A single instance is required.

LoadAvailableNumber is a unique transaction number associated with the whole LoadAvailable. This number is provided by the originator of the LoadAvailable e-Document and follows the document through its life.

LoadAvailableIssuedDate

LoadAvailableIssuedDate is mandatory. A single instance is required.

The date that the LoadAvailable was issued to the company to which the load was offered.

LoadAvailableConfirmationIssuedDate

LoadAvailableConfirmationIssuedDate is optional. A single instance might exist.

The date of response to the LoadAvailable e-Document from originating party.

TransactionHistoryNumber

TransactionHistoryNumber is optional. A single instance might exist.

A sequential number that keeps track of the version of a document.

However when the document is a confirmation document, in which case the TransactionHistoryNumber refers to the trigger transaction for the confirmation.

TransactionHistoryConfirmationNumber

TransactionHistoryConfirmationNumber is optional. A single instance might exist.

A sequential number that keeps track the version of a confirmation document.

When the document is a confirmation document, then the TransactionHistoryNumber refers to the trigger transaction for the confirmation.

LoadAvailableReference

LoadAvailableReference is optional. Multiple instances might exist.

LoadAvailableReferenceType provides a contextual explanation of the specific reference identifier.

LoadAvailableIssuedDate

The date that the LoadAvailable was issued to the company to which the load was offered.

(sequence)

The sequence of items below is mandatory. A single instance is required.

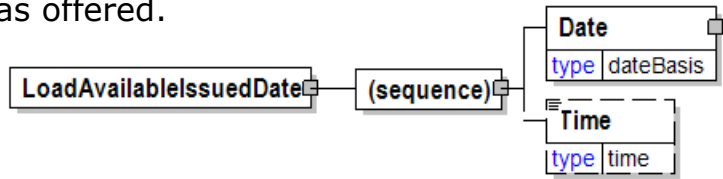

Date

Date is mandatory. A single instance is required.

A group element that contains the specification of Year, Month, and Day.

Time

Time is optional. A single instance might exist.

Times are treated in a standard XML fashion with a special case used to indicate a generalized "local" time. The standard XML approach to time is hh:mm:ss, hh:mm:ssZ, or hh:mm:ss±hh:mm.

hh:mm:ss±hh:mm is used to represent a time with a time zone. The time zone is communicated as the number of hours offset from the Universal Time Coordinate (UTC), a.k.a. Greenwich Mean Time.

hh:mm:ssZ indicates the time at Zulu (another name for UTC).

hh:mm:ss or hh:mm indicates within papiNet the applicable local time where the associated event is taking place. Caution should be used when processing times of this nature as the papiNet approach may be in discord with other users of XML.

LoadAvailableLineItem

LoadAvailableLineItem is a group item containing information that relates to a line in the LoadAvailable e-Document.

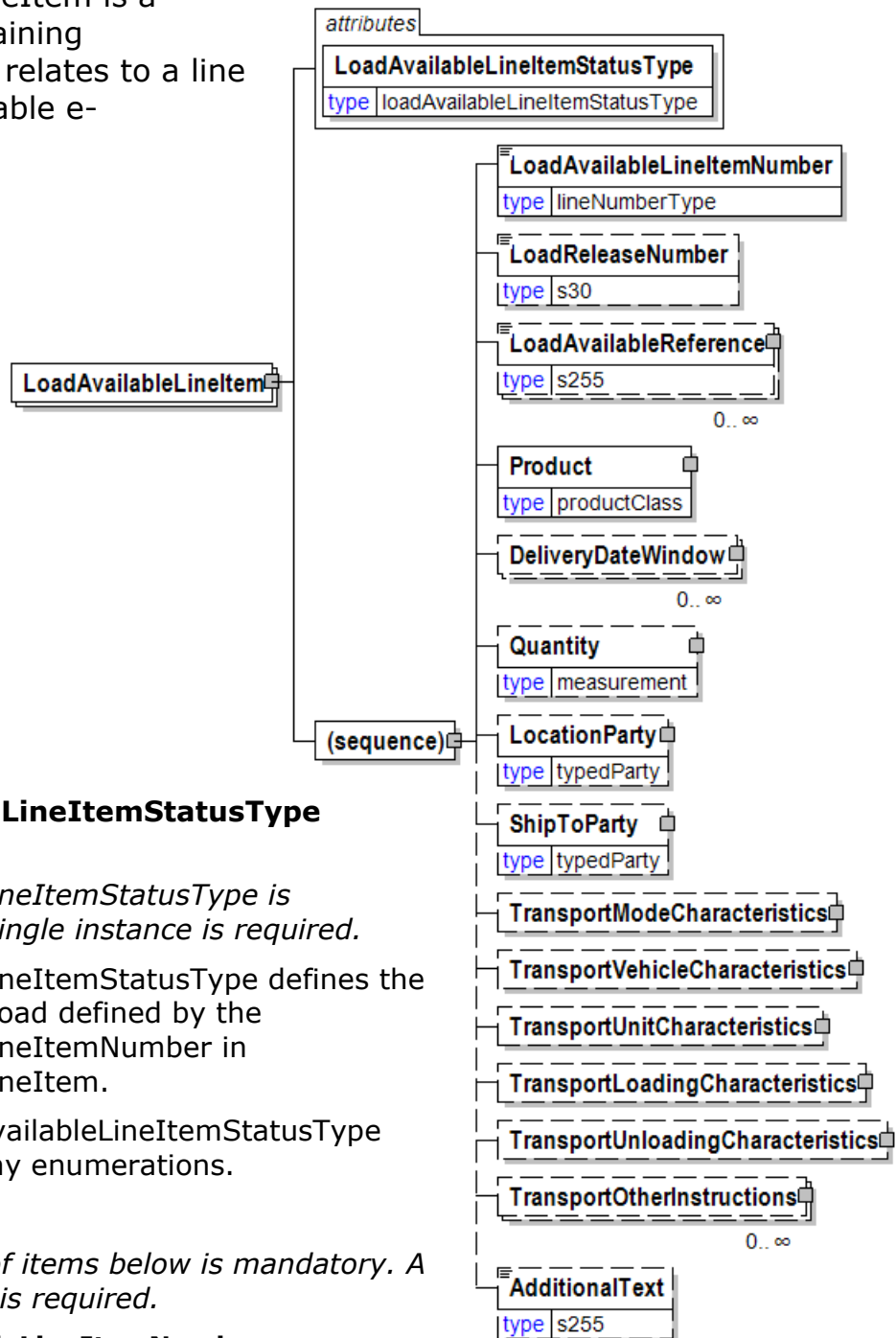

LoadAvailableLineItemStatusType [attribute]

LoadAvailableLineItemStatusType is mandatory. A single instance is required.

LoadAvailableLineItemStatusType defines the status of each load defined by the LoadAvailableLineItemNumber in LoadAvailableLineItem.

Refer to LoadAvailableLineItemStatusType definition for any enumerations.

(sequence)

The sequence of items below is mandatory. A single instance is required.

LoadAvailableLineItemNumber

LoadAvailableLineItemNumber is mandatory. A single instance is required.

LoadAvailableLineItemNumber is a unique number within a given LoadAvailable associating the number of loads available with a numeric sequence.

LoadReleaseNumber

LoadReleaseNumber is optional. A single instance might exist.

LoadReleaseNumber is a unique number identifying the load. The number comes from the company to whom the load was offered.

LoadAvailableReference

LoadAvailableReference is optional. Multiple instances might exist.

LoadAvailableReferenceType provides a contextual explanation of the specific reference identifier.

Product

Product is mandatory. A single instance is required.

Product is a group item defining the article and its characteristics. Product is used to specify product characteristics organized by ProductIdentifier, ProductDescription, and Classification. Book Manufacturing, Label Stock, Paper, Pulp, Recovered Paper, Wood Products, and Virgin Fibre market segments have defined their product characteristics and conversion features for implementation in papiNet.

DeliveryDateWindow

DeliveryDateWindow is optional. Multiple instances might exist.

A group item defining the date/time interval for delivery to take place. An element which may contain the estimated date for which delivery is expected. This date is not absolute.

Quantity

Quantity is optional. A single instance might exist.

The Quantity element contains attributes that provide information about the type of quantity that is being communicated, the context in which the particular quantity is to be viewed, and (if the quantity represents an adjustment) an adjustment type.

The Quantity element contains three child elements that enable you to communicate a range of values for the quantity and a target or actual value. It is at this level (Value, RangeMin, and RangeMax) that the unit of measure is specified. This permits the range to be specified in a different unit of measure than the target.

LocationParty

LocationParty is optional. A single instance might exist.

The organization or business entity where the business event took place or will take place.

ShipToParty

ShipToParty is optional. A single instance might exist.

The name and/or address to which the goods should be delivered with the party type indicated by the PartyType attribute.

TransportModeCharacteristics

TransportModeCharacteristics is optional. A single instance might exist.

A group item defining the primary mode of transport.

TransportVehicleCharacteristics

TransportVehicleCharacteristics is optional. A single instance might exist.

A group item containing information about a transport vehicle, e.g. a truck. A transport vehicle has its own power and can be used to pull, push, carry, or tow a transport unit loaded with goods.

TransportUnitCharacteristics

TransportUnitCharacteristics is optional. A single instance might exist.

A group item containing information about a transport unit, e.g. a trailer. Transport units contain goods and move using power from another source, the transport vehicle.

TransportLoadingCharacteristics

TransportLoadingCharacteristics is optional. A single instance might exist.

A group item defining how the transported items are to be loaded.

TransportUnloadingCharacteristics

TransportUnloadingCharacteristics is optional. A single instance might exist.

A group item defining how the transported items are to be unloaded.

TransportOtherInstructions

TransportOtherInstructions is optional. Multiple instances might exist.

A group item defining any other instructions for the transport not covered in the description of transport mode, vehicle, unit, and loading characteristics or defining an alternative description for the categories mentioned above.

AdditionalText

AdditionalText is optional. A single instance might exist.

A text field that is used to communicate information not previously defined or for special instructions. To be used only for circumstances not covered by specific elements.

LoadAvailableLineItemNumber

LoadAvailableLineItemNumber is a unique number within a given LoadAvailable associating the number of loads available with a numeric sequence.

LoadAvailableLineItemNumber
type lineNumberType

LoadAvailableLineItemStatusType [attribute]

LoadAvailableLineItemStatusType defines the status of each load defined by the LoadAvailableLineItemNumber in LoadAvailableLineItem.

attribute
LoadAvailableLineItemStatusType
type loadAvailableLineItemStatusType

This item is restricted to the following list.

Accepted

The supplied information is accepted.

Amended

The supplied information is changed

Cancelled

The supplied information has been cancelled. Items that have been cancelled are not included in totals on the summary levels of the e-Document.

NoAction

The supplied information has not been amended and thereby requires no action.

Original

The supplied information is the first version of that information.

Pending

The supplied information is not complete and will be updated later.

Rejected

The supplied information is rejected.

LoadAvailableNumber

LoadAvailableNumber is a unique transaction number associated with the whole LoadAvailable. This number is provided by the originator of the LoadAvailable e-Document and follows the document through its life.

LoadAvailableNumber
type s30

LoadAvailableReference

LoadAvailableReferenceType provides a contextual explanation of the specific reference identifier.

LoadAvailableReference
type s255

attributes
LoadAvailableReferenceType
type referenceType
AssignedBy
type assignedBy

LoadAvailableReferenceType [attribute]

LoadAvailableReferenceType is mandatory. A single instance is required.

Provides a contextual explanation of the specific reference identifier. Many items are currently prefixed by "Buyer", "Forwarder", "Manufacturer", "Mill", "Seller", "Supplier", "Warehouse", or "Vendor". Check for an existing non-prefixed version and use the non-prefixed version instead. In the (yet to be announced release date) version 3.0 the prefixed versions will be removed. Instead the attribute @AssignedBy will communicate the information previously communicated in the prefix.

Refer to LoadAvailableReferenceType definition for any enumerations.

AssignedBy [attribute]

AssignedBy is optional. A single instance might exist.

Identifies the type of party or the agency that has assigned the associated item, e.g. a reference of type OrderNumber.

Refer to AssignedBy for any enumerations.

LoadAvailableReferenceType [attribute]

Provides a contextual explanation of the specific reference identifier. Many items are currently prefixed by "Buyer", "Forwarder", "Manufacturer", "Mill", "Seller", "Supplier", "Warehouse", or "Vendor". Check for an

attribute
LoadAvailableReferenceType
type referenceType

existing non-prefixed version and use the non-prefixed version instead. In the (yet to be announced release date) version 3.0 the prefixed versions will be removed. Instead the attribute @AssignedBy will communicate the information previously communicated in the prefix.

Refer to the [referenceType](#) entry for the list of enumerations and their definitions.

LoadAvailableStatusType [attribute]

LoadAvailableStatusType defines the status of the entire LoadAvailable e-Document.

This item is restricted to the following list.



Accepted

The supplied information is accepted.

Amended

The supplied information is changed.

Cancelled

The supplied information has been cancelled. Items that have been cancelled are not included in totals on the summary levels of the e-Document.

Original

The supplied information is the first version of that information.

Rejected

The supplied information is rejected.

LoadAvailableSummary

LoadAvailable Summary

(sequence)

The sequence of items below is mandatory. A single instance is required.

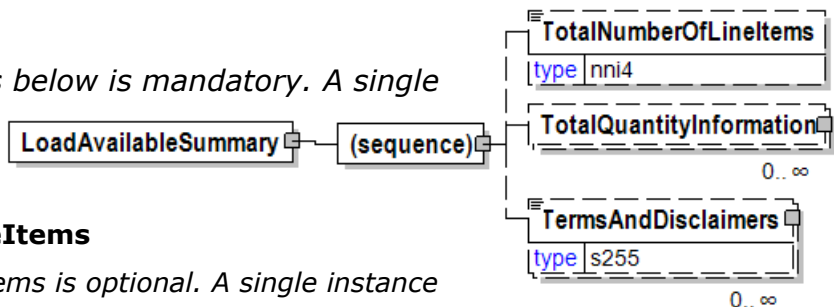

TotalNumberOfLineItems

TotalNumberOfLineItems is optional. A single instance might exist.

The total number of individual line items in the document, regardless of the status or type.

TotalQuantityInformation

TotalQuantityInformation is optional. Multiple instances might exist.

A group item containing information about the total quantity and total informational quantity of similar items in the document. TotalQuantityInformation is primarily used in the summary section of e-Documents where it is repeatable to permit totalling for different units of measure.

TermsAndDisclaimers

TermsAndDisclaimers is optional. Multiple instances might exist.

An element that contains legal information with an indication of what the Language is.

LoadAvailableType [attribute]

LoadAvailableType defines the type LoadAvailable e-Document.

This item is restricted to the following list.



LoadAvailable

LoadAvailable indicates the e-Document is from the company with the load.

LoadAvailableConfirmation

LoadAvailableConfirmation indicates the e-Document is from the company to whom the load was offered.

LoadingFrom

Specifies a transport unit from which the goods are loaded.

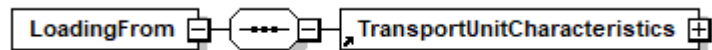

(sequence)

The sequence of items below is mandatory. A single instance is required.

TransportUnitCharacteristics

TransportUnitCharacteristics is mandatory. A single instance is required.

A group item containing information about a transport unit, e.g. a trailer. Transport units contain goods and move using power from another source, the transport vehicle.

LoadingSequence

A group item that specifies a loading sequence of goods identified by the item specified in the attribute

LoadingSequenceType. The loading of goods should be carried out in the order of increasing values of the SequenceNumber.

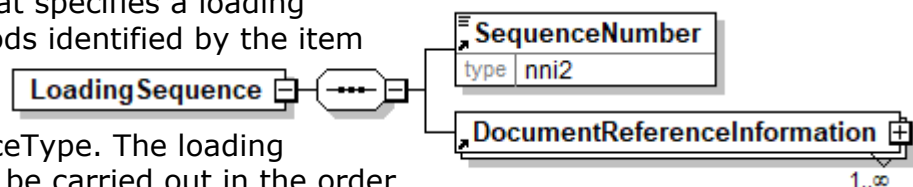

(sequence)

The sequence of items below is mandatory. A single instance is required.

SequenceNumber

SequenceNumber is mandatory. A single instance is required.

A sequential number that uniquely identifies a sequence.

DocumentReferenceInformation

DocumentReferenceInformation is mandatory. One instance is required, multiple instances might exist.

A group item containing reference information applicable to a document.

LoadingSequenceType [attribute]

Specifies the type of item that is controlling the loading order of goods.

This item is restricted to the following list.

ByOrderNumber

The loading sequences of goods are identified by order numbers and optional order line items.

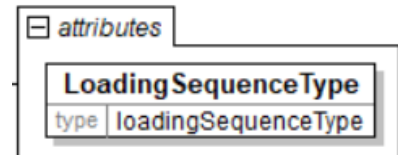

LoadingTolerance [attribute]

Specifies tolerance type for load quantity. Tolerance values are given by RangeMin and RangeMax in Quantity.

This item is restricted to the following list.

FillUpFromOtherOrder

Fill up a full load from an other order

Full

Always a full load

FullWithinTolerance

Always a full load if still within given tolerance

WithinTolerance

The load should be within given tolerance

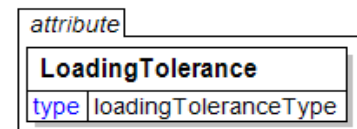

LoadNumber

An element used to communicate the unique identifier of the LoadNumber.

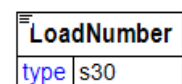

LoadOpeningSide [attribute]

Specifies opening sides on a transport unit for loading and unloading seen in the transport direction of the goods carrier

This item is restricted to the following list.

BackEndSide

Opening for loading and unloading is towards the back-end side

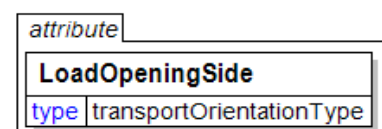

FrontEndSide

Opening for loading and unloading is towards the front-end side

LeftAndRightSide

Openings for loading and unloading are both towards the left side and the right side.

LeftSide

Opening for loading and unloading is towards the left side

RightSide

Opening for loading and unloading is towards the right side

LoadReleaseNumber

LoadReleaseNumber is a unique number identifying the load. The number comes from the company to whom the load was offered.

LoadReleaseNumber	
type	s30

LoadTender

The LoadTender element is the root element for the LoadTender e-Document.

The LoadTender e-Document supports the transport booking process. Transport booking includes the following steps:

- LoadTender – more than one carrier has been informed about the upcoming transport.
- Booking – identifies a transport booking that is part of a detail transport plan, the load has been booked with a single carrier.

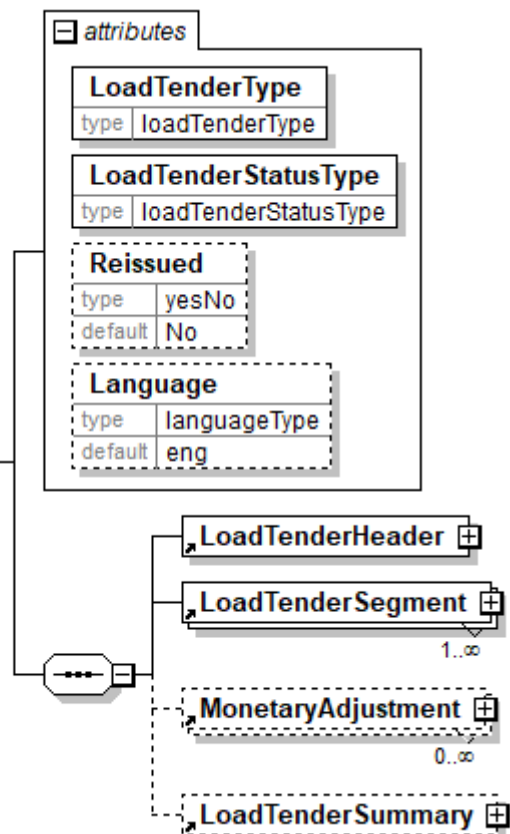

LoadTenderType [attribute]

LoadTenderType is mandatory. A single instance is required.

Code indicating the function of the LoadTender e-Document.

Refer to LoadTenderType definition for any enumerations.

LoadTenderStatusType [attribute]

LoadTenderStatusType is mandatory. A single instance is required.

Identifies the status of the entire LoadTender e-Document (in other words, at the root level).

Refer to LoadTenderStatusType definition for any enumerations.

Reissued [attribute]

Reissued is optional. A single instance might exist.

Either "Yes" or "No".

Refer to Reissued definition for any enumerations.

Language [attribute]

Language is optional. A single instance might exist.

The valid Alpha 2- and Alpha 3-character list of language codes in the ISO 639-1 and 639-2 international standards.

Information on the content of this attribute is available at:
https://www.loc.gov/standards/iso639-2/php/code_list.php

(sequence)

The sequence of items below is mandatory. A single instance is required.

LoadTenderHeader

LoadTenderHeader is mandatory. A single instance is required.

The LoadTenderHeader contains information common to the entire LoadTender.

LoadTenderSegment

LoadTenderSegment is mandatory. One instance is required, multiple instances might exist.

The details for a particular load segment.

MonetaryAdjustment

MonetaryAdjustment is optional. Multiple instances might exist.

The element containing the information necessary for the understanding, calculation, and treatment of an adjustment to a currency amount. MonetaryAdjustment contains an attribute that indicates they type of adjustment being communicated.

LoadTenderSummary

LoadTenderSummary is optional. A single instance might exist.

Summary information that applies to the entire LoadTender e-Document.

LoadTenderAmount

The base amount for the LoadTenderLineItem.

Determined from Quantity times the PricePerUnit. As such it does not include any taxes.

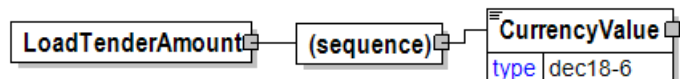

(sequence)

The sequence of items below is mandatory. A single instance is required.

CurrencyValue

CurrencyValue is mandatory. A single instance is required.

The amount in the referenced currency as defined by the CurrencyType attribute.

LoadTenderHeader

The LoadTenderHeader contains information common to the entire LoadTender.

LoadTenderHeaderStatusType [attribute]

LoadTenderHeaderStatusType is mandatory. A single instance is required.

Identifies the status of the header of the LoadTender e-Document.

Refer to LoadTenderHeaderStatusType definition for any enumerations.

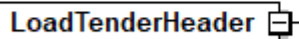

IsPartialConfirmationsAllowed [attribute]

IsPartialConfirmationsAllowed is optional. A single instance is might exist.

Specifies if partial confirmations are allowed or not, e.g. confirmations of one segment only. Default value is No.

Refer to IsPartialConfirmationsAllowed definition for any enumerations.

(sequence)

The sequence of items below is mandatory. A single instance is required.

LoadTenderNumber

LoadTenderNumber is mandatory. A single instance is required.

The identifier for the LoadTender e-Document.

LoadTenderIssueDate

LoadTenderIssueDate is mandatory. A single instance is required.

The date when the e-Document was issued.

TransactionHistoryNumber

TransactionHistoryNumber is optional. A single instance might exist.

A sequential number that keeps track of the version of a document.

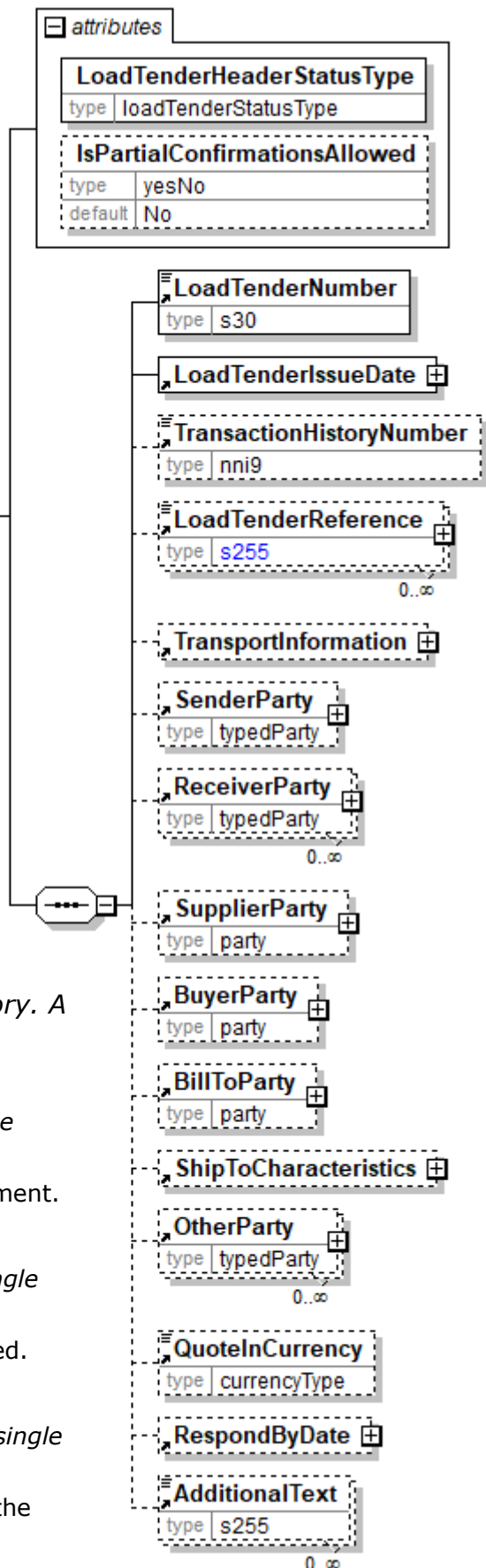

However when the document is a confirmation document, in which case the TransactionHistoryNumber refers to the trigger transaction for the confirmation.

LoadTenderReference

LoadTenderReference is optional. Multiple instances might exist.

An item detailing relevant references pertaining to the LoadTender. The type of reference is identified by the LoadTenderReferenceType attribute.

TransportInformation

TransportInformation is optional. A single instance might exist.

A grouping element for transport information.

SenderParty

SenderParty is optional. A single instance might exist.

The business entity issuing the e-Document, the source of the document.

The entity responsible for the content. If the sender party has out sourced the message service to a third party the SenderParty is the issuer of the e-Document and not the party performing the transmission service of the electronic message.

ReceiverParty

ReceiverParty is optional. Multiple instances might exist.

The business entity for whom the e-Document is intended, the destination of the document.

The entity interested in the content. If the receiver party has outsourced the message service to a third party the ReceiverParty is the intended party for the e-Document and not the party performing the receiving service of the electronic message.

SupplierParty

SupplierParty is optional. A single instance might exist.

The organisation or business entity responsible for providing the product. SupplierParty is also the seller of the product, if Seller is not specified as OtherParty = Seller.

BuyerParty

BuyerParty is optional. A single instance might exist.

The legal entity to which the product is sold. Also commonly referred to as the sold-to party or customer. If no OtherParty is defined as the Payer, the Buyer is the Payer.

BillToParty

BillToParty is optional. A single instance might exist.

The address where the invoice is to be sent.

ShipToCharacteristics

ShipToCharacteristics is optional. A single instance might exist.

A group item that provides information important for the Ship-To Party.

OtherParty

OtherParty is optional. Multiple instances might exist.

An organisation or business entity other than those specifically detailed within an e-Document.

QuoteInCurrency

QuoteInCurrency is optional. A single instance might exist.

Indicates that the quote is to be provided in the currency specified.

A three-character ISO 4217 currency code in capital letters. The ISO standard classification for currencies. Refer to the ISO standard for information about the choices for the enumerations.

<https://www.iso.org/iso-4217-currency-codes.html>

RespondByDate

RespondByDate is optional. A single instance might exist.

The date that a response to the query if required.

AdditionalText

AdditionalText is optional. Multiple instances might exist.

A text field that is used to communicate information not previously defined or for special instructions. To be used only for circumstances not covered by specific elements.

LoadTenderHeaderStatusType [attribute]

Identifies the status of the header of the LoadTender e-Document.

This item is restricted to the following list.

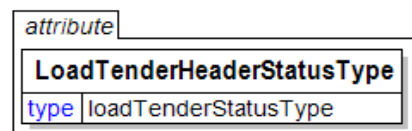

Amended

The supplied information is changed.

Cancelled

The supplied information has been cancelled. Items that have been cancelled are not included in totals on the summary levels of the e-Document.

Original

The supplied information is the first version of that information.

LoadTenderIssueDate

The date when the e-Document was issued.

(sequence)

The sequence of items below is mandatory. A single instance is required.

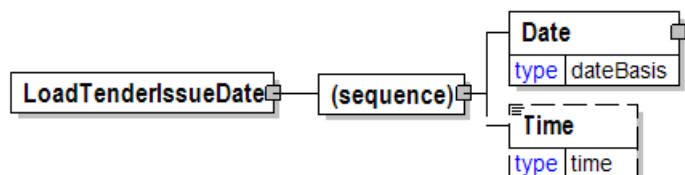

Date

Date is mandatory. A single instance is required.

A group element that contains the specification of Year, Month, and Day.

Time

Time is optional. A single instance might exist.

Times are treated in a standard XML fashion with a special case used to indicate a

papiNet V2R31

generalized "local" time. The standard XML approach to time is hh:mm:ss, hh:mm:ssZ, or hh:mm:ss±hh:mm.

hh:mm:ss±hh:mm is used to represent a time with a time zone. The time zone is communicated as the number of hours offset from the Universal Time Coordinate (UTC), a.k.a. Greenwich Mean Time.

hh:mm:ssZ indicates the time at Zulu (another name for UTC).

hh:mm:ss or hh:mm indicates within papiNet the applicable local time where the associated event is taking place. Caution should be used when processing times of this nature as the papiNet approach may be in discord with other users of XML.

LoadTenderLineItem

Group element identifying a line item to be included within this LoadTender Segment.

(sequence)

The sequence of items below is mandatory. A single instance is required.

LoadTenderLineItemNumber

LoadTenderLineItemNumber is mandatory. A single instance is required.

The sequential number that uniquely identifies the LoadTender line item.

SupplierParty

SupplierParty is optional. A single instance might exist.

The organisation or business entity responsible for providing the product. SupplierParty is also the seller of the product, if Seller is not specified as



OtherParty = Seller.

Product

Product is optional. A single instance might exist.

Product is a group item defining the article and its characteristics. Product is used to specify product characteristics organized by ProductIdentifier, ProductDescription, and Classification. Book Manufacturing, Label Stock, Paper, Pulp, Recovered Paper, Wood Products, and Virgin Fibre market segments have defined their product characteristics and conversion features for implementation in papiNet.

QuantityInformation

QuantityInformation is mandatory. A single instance is required.

A group item containing information about quantity and informational quantity of similar items.

SupplyPoint

SupplyPoint is optional. Multiple instances might exist.

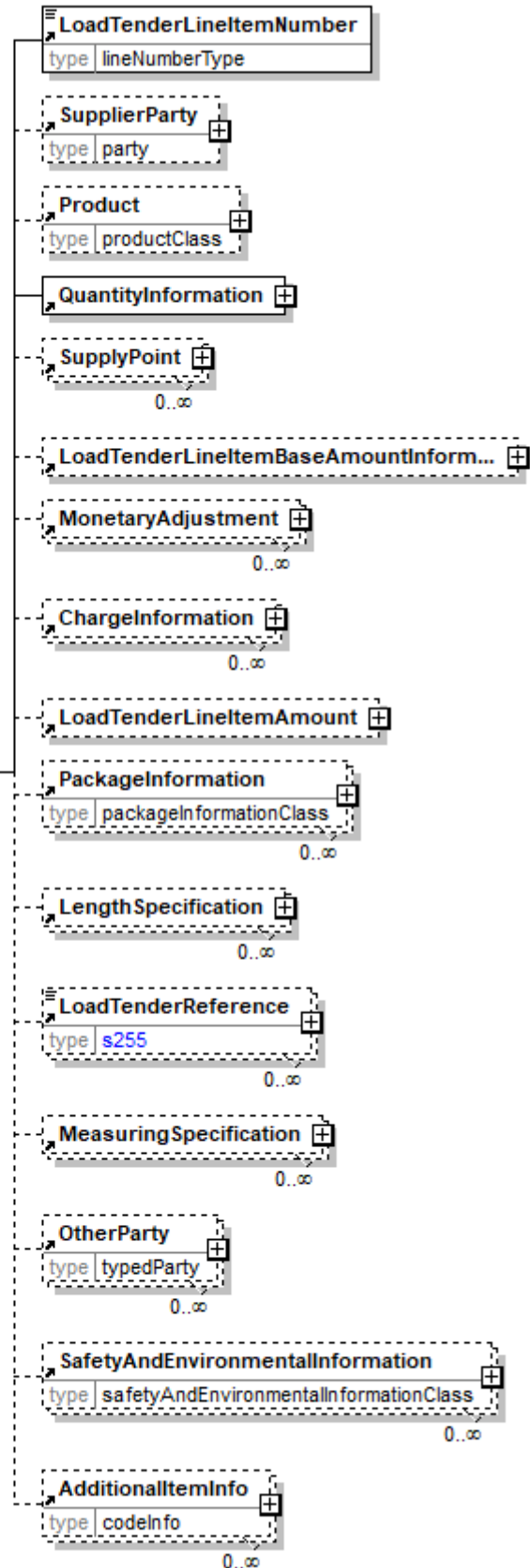

Grouping element that contains items describing a supply point. A SupplyPoint belongs to a LocationParty, e.g. in a DeliveryOrigin or DeliveryDestination, and describes where goods are stored and can be loaded or unloaded. A SupplyPoint can for example be a loading or unloading gate at a warehouse or a road side landing at a logging area in the forest.

LoadTenderLineItemBaseAmountInformation

LoadTenderLineItemBaseAmountInformation is optional. A single instance might exist.

Group element used to detail the LoadTender Line Item's PriceDetails and TotalAmount. Normally used to identify the PricePerUnit of the line item.

MonetaryAdjustment

MonetaryAdjustment is optional. Multiple instances might exist.

The element containing the information necessary for the understanding, calculation, and treatment of an adjustment to a currency amount. MonetaryAdjustment contains an attribute that indicates they type of adjustment being communicated.

ChargeInformation

ChargeInformation is optional. Multiple instances might exist.

A group element that contains elements that describe a charge. ChargeInformation is used when charge details need to be specified by using a code assigned by an agency. It is typically used for freight costs and other costs related to the supply chain.

LoadTenderLineItemAmount

LoadTenderLineItemAmount is optional. A single instance might exist.

Total amount of the LoadTenderLineItem including charges, adjustments and tax (when tax is specified on the load tender line item).

LoadTenderLineItemAmount is equal to the LoadTenderAmount plus the sum of the signed values of the ChargeAmount for all instances of ChargeInformation plus the sum of the signed values of the MonetaryAdjustmentAmount for all instances of MonetaryAdjustment.

PackageInformation

PackageInformation is optional. Multiple instances might exist.

The purpose of the PackageInformation structure is to clearly identify physical handling items that constitute the delivery.

PackageInformation is the highest level of product packaging it describes the shipping or warehousing unit.

If you are communicating a package, usually for logistics or transport purposes, you should include the PackageType, Identifier, ItemCount, and Quantity. (Note: you still have the ability to describe the item with one of the "named" items.)

If you are communicating one of the named Items there is no need to include PackageType, Identifier, ItemCount, and Quantity.

Since either of these two approaches can be used the entire contents of this element are optional even though the parent may be required. It is expected that you will fill in the appropriate details.

LengthSpecification

LengthSpecification is optional. Multiple instances might exist.

papiNet V2R31

Length specification of the wood product.

LoadTenderReference

LoadTenderReference is optional. Multiple instances might exist.

An item detailing relevant references pertaining to the LoadTender. The type of reference is identified by the LoadTenderReferenceType attribute.

MeasuringSpecification

MeasuringSpecification is optional. Multiple instances might exist.

A grouping element that contains a specification for measurement procedures for a measuring party at a measuring location.

OtherParty

OtherParty is optional. Multiple instances might exist.

An organisation or business entity other than those specifically detailed within an e-Document.

SafetyAndEnvironmentalInformation

SafetyAndEnvironmentalInformation is optional. Multiple instances might exist.

Name of certification type, if any, on the goods (For example, FSC, PEFC). SafetyAndEnvironmental needs a value or measurement to communicate the percentage of the product is certified (for example, 75% is certified by the indicated agency).

AdditionalItemInfo

AdditionalItemInfo is optional. Multiple instances might exist.

A grouping element that contains information about additional items specified by an agency. Restricted use of this element is recommended.

LoadTenderLineItemAmount

Total amount of the LoadTenderLineItem including charges, adjustments and tax (when tax is specified on the load tender line item).

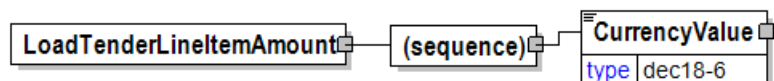

LoadTenderLineItemAmount is equal to the LoadTenderAmount plus the sum of the signed values of the ChargeAmount for all instances of ChargeInformation plus the sum of the signed values of the MonetaryAdjustmentAmount for all instances of MonetaryAdjustment.

(sequence)

The sequence of items below is mandatory. A single instance is required.

CurrencyValue

CurrencyValue is mandatory. A single instance is required.

The amount in the referenced currency as defined by the CurrencyType attribute.

LoadTenderLineItemBaseAmountInformation

Group element used to detail the LoadTender Line Item's PriceDetails and TotalAmount. Normally used to identify the PricePerUnit of the line item.

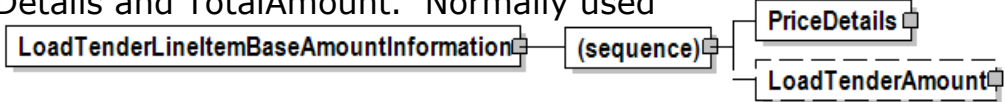

(sequence)

The sequence of items below is mandatory. A single instance is required.

PriceDetails

PriceDetails is mandatory. A single instance is required.

An element that groups together price information.

LoadTenderAmount

LoadTenderAmount is optional. A single instance might exist.

The base amount for the LoadTenderLineItem. Determined from Quantity times the PricePerUnit. As such it does not include any taxes.

LoadTenderLineItemNumber

The sequential number that uniquely identifies the LoadTender line item.

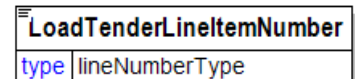

LoadTenderNumber

The identifier for the LoadTender e-Document.

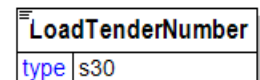

LoadTenderReference

An item detailing relevant references pertaining to the LoadTender. The type of reference is identified by the

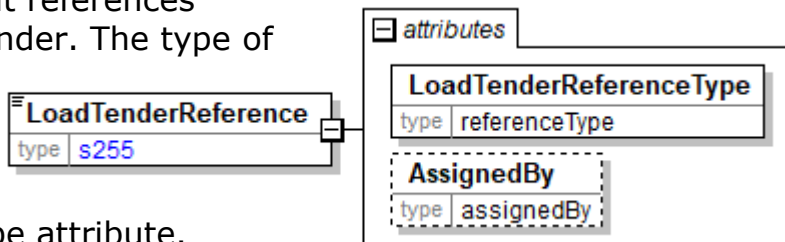

LoadTenderReferenceType attribute.

LoadTenderReferenceType [attribute]

LoadTenderReferenceType is mandatory. A single instance is required.

Provides a contextual explanation of the specific reference identifier. Many items are currently prefixed by "Buyer", "Forwarder", "Manufacturer", "Mill", "Seller", "Supplier", "Warehouse", or "Vendor". Check for an existing non-prefixed version and use the non-prefixed version instead. In the (yet to be announced release date) version 3.0 the prefixed versions will be removed. Instead the attribute @AssignedBy will communicate the information

previously communicated in the prefix.

Refer to LoadTenderReferenceType definition for any enumerations.

AssignedBy [attribute]

AssignedBy is optional. A single instance might exist.

Identifies the type of party or the agency that has assigned the associated item, e.g. a reference of type OrderNumber.

Refer to AssignedBy for any enumerations.

LoadTenderReferenceType [attribute]

Provides a contextual explanation of the specific reference identifier. Many items are currently prefixed by "Buyer", "Forwarder", "Manufacturer", "Mill", "Seller", "Supplier", "Warehouse", or "Vendor". Check for an existing non-prefixed version and use the non-prefixed version instead. In the (yet to be announced release date) version 3.0 the prefixed versions will be removed. Instead the attribute @AssignedBy will communicate the information previously communicated in the prefix.

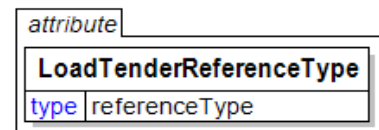

Refer to the [referenceType](#) entry for the list of enumerations and their definitions.

LoadTenderResponse

The LoadTenderResponse element is the root element for the LoadTenderResponse e-Document.

The LoadTenderResponse e-Document supports the transport booking process and is used as a response e-Document to LoadTender e-Document. Transport booking includes the following steps:

- LoadTenderResponse – more than one carrier has been informed about the upcoming transport.
- BookingConfirmation – identifies a transport booking that is part of a detail transport plan, the load has been booked with a single carrier.

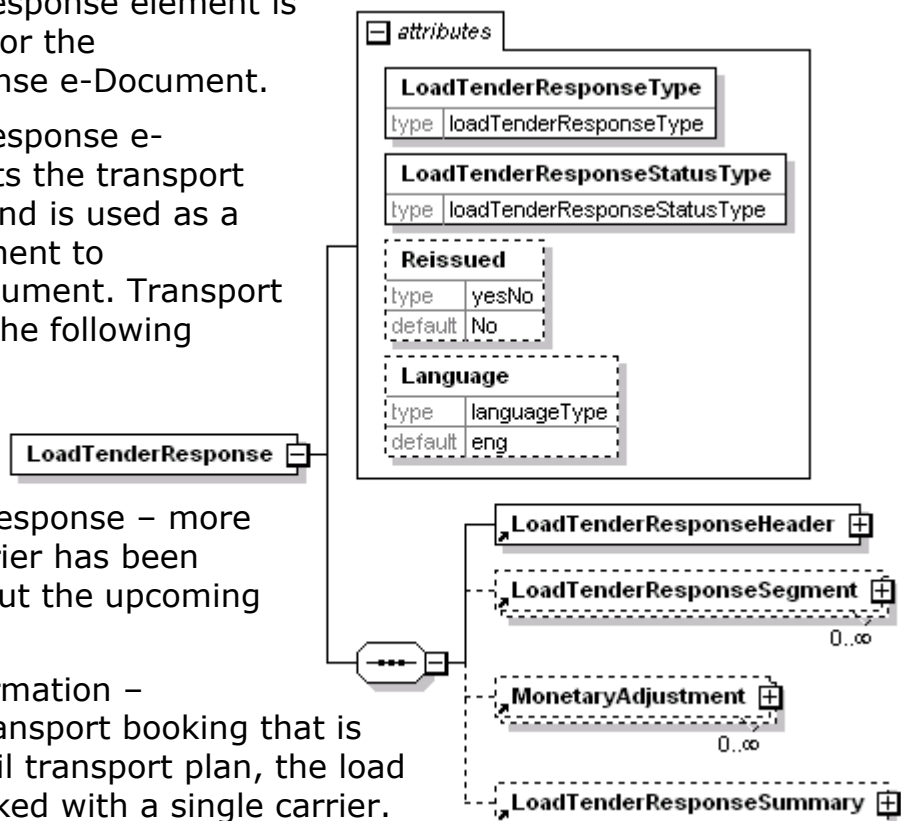

The LoadTenderResponse provides a means of communicating these events.

LoadTenderResponseType [attribute]

LoadTenderResponseType is mandatory. A single instance is required.

Code indicating the function of the e-Document.

Refer to LoadTenderResponseType definition for any enumerations.

LoadTenderResponseStatusType [attribute]

LoadTenderResponseStatusType is mandatory. A single instance is required.

Identifies the status of the entire LoadTenderResponse e-Document (in other words, at the root level).

Refer to LoadTenderResponseStatusType definition for any enumerations.

Reissued [attribute]

Reissued is optional. A single instance might exist.

Either "Yes" or "No".

Refer to Reissued definition for any enumerations.

Language [attribute]

Language is optional. A single instance might exist.

The valid Alpha 2- and Alpha 3-character list of language codes in the ISO 639-1 and 639-2 international standards.

Information on the content of this attribute is available at:

https://www.loc.gov/standards/iso639-2/php/code_list.php

(sequence)

The sequence of items below is mandatory. A single instance is required.

LoadTenderResponseHeader

LoadTenderResponseHeader is mandatory. A single instance is required.

The LoadTenderResponseHeader contains information common to the entire LoadTenderResponse.

LoadTenderResponseSegment

LoadTenderResponseSegment is optional. Multiple instances might exist.

The details for a particular load segment.

MonetaryAdjustment

MonetaryAdjustment is optional. Multiple instances might exist.

The element containing the information necessary for the understanding, calculation, and treatment of an adjustment to a currency amount. MonetaryAdjustment contains an attribute that indicates they type of adjustment being communicated.

LoadTenderResponseSummary

LoadTenderResponseSummary is optional. A single instance might exist.

Summary information that applies to the entire LoadTenderResponse e-Document.

LoadTenderResponseHeader

The LoadTenderResponseHeader contains information common to the entire LoadTenderResponse.

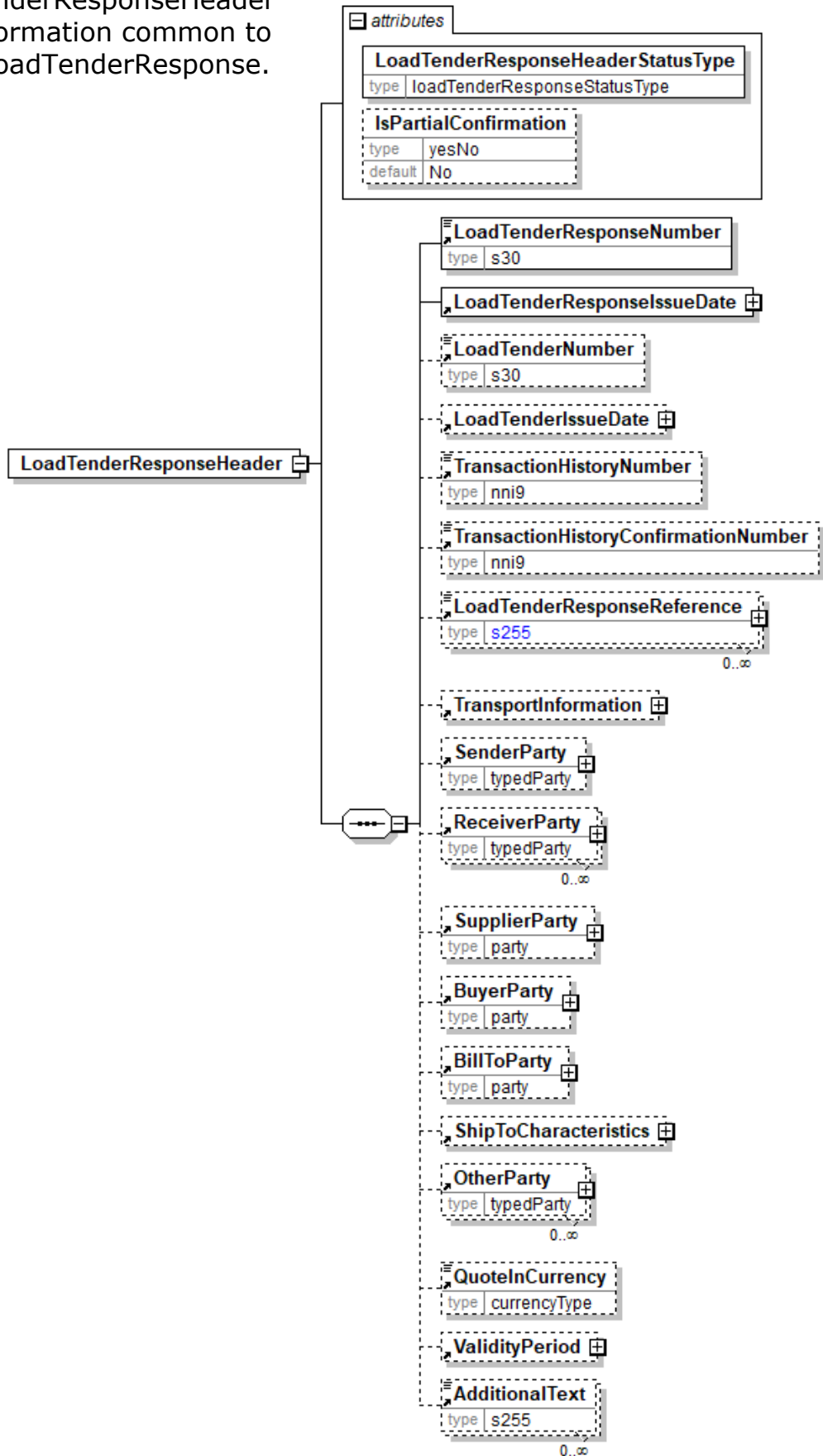

LoadTenderResponseHeaderStatusType [attribute]

LoadTenderResponseHeaderStatusType is mandatory. A single instance is required.

Identifies the status of the header of the LoadTenderResponse e-Document.
Refer to LoadTenderResponseHeaderStatusType definition for any enumerations.

IsPartialConfirmation [attribute]

IsPartialConfirmation is optional. A single instance is might exist.

Specifies if the confirmation is a partial confirmation or not, e.g. confirmation of one segment only. Default value is No.

Refer to IsPartialConfirmation definition for any enumerations.

(sequence)

The sequence of items below is mandatory. A single instance is required.

LoadTenderResponseNumber

LoadTenderResponseNumber is mandatory. A single instance is required.

The identifier for the LoadTenderResponse e-Document.

LoadTenderResponseIssueDate

LoadTenderResponseIssueDate is mandatory. A single instance is required.

The date when the e-Document was issued.

LoadTenderNumber

LoadTenderNumber is optional. A single instance might exist.

The identifier for the LoadTender e-Document.

LoadTenderIssueDate

LoadTenderIssueDate is optional. A single instance might exist.

The date when the e-Document was issued.

TransactionHistoryNumber

TransactionHistoryNumber is optional. A single instance might exist.

A sequential number that keeps track of the version of a document.

However when the document is a confirmation document, in which case the TransactionHistoryNumber refers to the trigger transaction for the confirmation.

TransactionHistoryConfirmationNumber

TransactionHistoryConfirmationNumber is optional. A single instance might exist.

A sequential number that keeps track the version of a confirmation document.

When the document is a confirmation document, then the TransactionHistoryNumber refers to the trigger transaction for the confirmation.

LoadTenderResponseReference

LoadTenderResponseReference is optional. Multiple instances might exist.

An item detailing relevant references pertaining to the LoadTenderResponse. The type of reference is identified by the LoadTenderReferenceType attribute.

TransportInformation

TransportInformation is optional. A single instance might exist.

A grouping element for transport information.

SenderParty

SenderParty is optional. A single instance might exist.

The business entity issuing the e-Document, the source of the document.

The entity responsible for the content. If the sender party has out sourced the message service to a third party the SenderParty is the issuer of the e-Document and not the party performing the transmission service of the electronic message.

ReceiverParty

ReceiverParty is optional. Multiple instances might exist.

The business entity for whom the e-Document is intended, the destination of the document.

The entity interested in the content. If the receiver party has outsourced the message service to a third party the ReceiverParty is the intended party for the e-Document and not the party performing the receiving service of the electronic message.

SupplierParty

SupplierParty is optional. A single instance might exist.

The organisation or business entity responsible for providing the product. SupplierParty is also the seller of the product, if Seller is not specified as OtherParty = Seller.

BuyerParty

BuyerParty is optional. A single instance might exist.

The legal entity to which the product is sold. Also commonly referred to as the sold-to party or customer. If no OtherParty is defined as the Payer, the Buyer is the Payer.

BillToParty

BillToParty is optional. A single instance might exist.

The address where the invoice is to be sent.

ShipToCharacteristics

ShipToCharacteristics is optional. A single instance might exist.

A group item that provides information important for the Ship-To Party.

OtherParty

OtherParty is optional. Multiple instances might exist.

An organisation or business entity other than those specifically detailed within an e-Document.

QuoteInCurrency

QuoteInCurrency is optional. A single instance might exist.

Indicates that the quote is to be provided in the currency specified.

A three-character ISO 4217 currency code in capital letters. The ISO standard classification for currencies. Refer to the ISO standard for information about the choices for the enumerations.

<https://www.iso.org/iso-4217-currency-codes.html>

ValidityPeriod

ValidityPeriod is optional. A single instance might exist.

The validity period for a specific item, e.g. the validity period for an e-Document.

AdditionalText

AdditionalText is optional. Multiple instances might exist.

A text field that is used to communicate information not previously defined or for special instructions. To be used only for circumstances not covered by specific elements.

LoadTenderResponseHeaderStatusType [attribute]

Identifies the status of the header of the LoadTenderResponse e-Document.

This item is restricted to the following list.



Accepted

The supplied information is accepted.

Amended

The supplied information is changed

Cancelled

The supplied information has been cancelled. Items that have been cancelled are not included in totals on the summary levels of the e-Document.

Pending

The supplied information is not complete and will be updated later.

Rejected

The supplied information is rejected.

LoadTenderResponseIssueDate

The date when the e-Document was issued.

(sequence)

The sequence of items below is mandatory. A single instance is required.

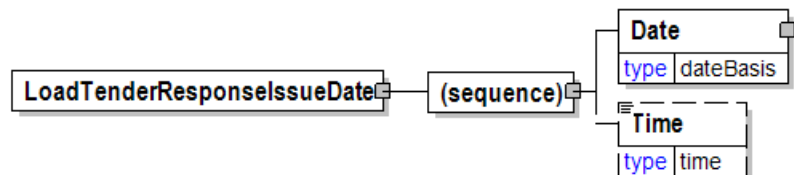

Date

Date is mandatory. A single instance is required.

A group element that contains the specification of Year, Month, and Day.

Time

Time is optional. A single instance might exist.

Times are treated in a standard XML fashion with a special case used to indicate a generalized "local" time. The standard XML approach to time is hh:mm:ss, hh:mm:ssZ, or hh:mm:ss±hh:mm.

papiNet V2R31

hh:mm:ss±hh:mm is used to represent a time with a time zone. The time zone is communicated as the number of hours offset from the Universal Time Coordinate (UTC), a.k.a. Greenwich Mean Time.

hh:mm:ssZ indicates the time at Zulu (another name for UTC).

hh:mm:ss or hh:mm indicates within papiNet the applicable local time where the associated event is taking place. Caution should be used when processing times of this nature as the papiNet approach may be in discord with other users of XML.

LoadTenderResponseLineItem

The details for a particular load line item.

(sequence)

The sequence of items below is mandatory. A single instance is required.



LoadTenderResponseLineItemNumber

LoadTenderResponseLineItemNumber is mandatory. A single instance is required.

The sequential number that uniquely identifies the LoadTenderResponse line item.

SupplierParty

SupplierParty is optional. A single instance might exist.

The organisation or business entity responsible for providing the product. SupplierParty is also the seller of the product, if Seller is not specified as OtherParty = Seller.

Product

Product is optional. A single instance might exist.

Product is a group item defining the article and its characteristics. Product is used to specify product characteristics organized by ProductIdentifier, ProductDescription, and Classification. Book Manufacturing, Label Stock, Paper, Pulp, Recovered Paper, Wood Products, and Virgin Fibre market segments have defined their product characteristics and conversion features for implementation in papiNet.

QuantityInformation

QuantityInformation is mandatory. A single instance is required.

A group item containing information about quantity and informational quantity of similar items.

SupplyPoint

SupplyPoint is optional. Multiple instances might exist.

Grouping element that contains items describing a supply point. A SupplyPoint belongs to a LocationParty, e.g. in a DeliveryOrigin or DeliveryDestination, and describes where goods are stored and can be loaded or unloaded. A SupplyPoint can for example be a loading or unloading gate at a warehouse or a road side landing at a logging area in the forest.

LoadTenderLineItemBaseAmountInformation

LoadTenderLineItemBaseAmountInformation is optional. A single instance might exist.

Group element used to detail the LoadTender Line Item's PriceDetails and TotalAmount. Normally used to identify the PricePerUnit of the line item.

MonetaryAdjustment

MonetaryAdjustment is optional. Multiple instances might exist.

The element containing the information necessary for the understanding, calculation, and treatment of an adjustment to a currency amount. MonetaryAdjustment contains an attribute that indicates the type of adjustment being communicated.

ChargeInformation

ChargeInformation is optional. Multiple instances might exist.

A group element that contains elements that describe a charge. ChargeInformation is used when charge details need to be specified by using a code assigned by an agency. It is typically used for freight costs and other costs related to the supply chain.

LoadTenderLineItemAmount

LoadTenderLineItemAmount is optional. A single instance might exist.

Total amount of the LoadTenderLineItem including charges, adjustments and tax (when tax is specified on the load tender line item).

LoadTenderLineItemAmount is equal to the LoadTenderAmount plus the sum of the

signed values of the ChargeAmount for all instances of ChargeInformation plus the sum of the signed values of the MonetaryAdjustmentAmount for all instances of MonetaryAdjustment.

PackageInformation

PackageInformation is optional. Multiple instances might exist.

The purpose of the PackageInformation structure is to clearly identify physical handling items that constitute the delivery.

PackageInformation is the highest level of product packaging it describes the shipping or warehousing unit.

If you are communicating a package, usually for logistics or transport purposes, you should include the PackageType, Identifier, ItemCount, and Quantity. (Note: you still have the ability to describe the item with one of the "named" items.)

If you are communicating one of the named Items there is no need to include PackageType, Identifier, ItemCount, and Quantity.

Since either of these two approaches can be used the entire contents of this element are optional even though the parent may be required. It is expected that you will fill in the appropriate details.

LengthSpecification

LengthSpecification is optional. Multiple instances might exist.

Length specification of the wood product.

LoadTenderResponseReference

LoadTenderResponseReference is optional. Multiple instances might exist.

An item detailing relevant references pertaining to the LoadTenderResponse. The type of reference is identified by the LoadTenderReferenceType attribute.

MeasuringSpecification

MeasuringSpecification is optional. Multiple instances might exist.

A grouping element that contains a specification for measurement procedures for a measuring party at a measuring location.

OtherParty

OtherParty is optional. Multiple instances might exist.

An organisation or business entity other than those specifically detailed within an e-Document.

SafetyAndEnvironmentalInformation

SafetyAndEnvironmentalInformation is optional. Multiple instances might exist.

Name of certification type, if any, on the goods (For example, FSC, PEFC). SafetyAndEnvironmental needs a value or measurement to communicate the percentage of the product is certified (for example, 75% is certified by the indicated agency).

AdditionalItemInfo

AdditionalItemInfo is optional. Multiple instances might exist.

A grouping element that contains information about additional items specified by an agency. Restricted use of this element is recommended.

LoadTenderResponseLineNumber

The sequential number that uniquely identifies the LoadTenderResponse line item.

LoadTenderResponseLineNumber	
type	lineNumberType

LoadTenderResponseNumber

The identifier for the LoadTenderResponse e-Document.

LoadTenderResponseNumber	
type	s30

LoadTenderResponseReference

An item detailing relevant references pertaining to the

LoadTenderResponseReference	
type	s255

attributes	
LoadTenderResponseReferenceType	
type	referenceType
AssignedBy	
type	assignedBy

LoadTenderResponse. The type of reference is identified by the LoadTenderReferenceType attribute.

LoadTenderResponseReferenceType [attribute]

LoadTenderResponseReferenceType is mandatory. A single instance is required.

Provides a contextual explanation of the specific reference identifier. Many items are currently prefixed by "Buyer", "Forwarder", "Manufacturer", "Mill", "Seller", "Supplier", "Warehouse", or "Vendor". Check for an existing non-prefixed version and use the non-prefixed version instead. In the (yet to be announced release date) version 3.0 the prefixed versions will be removed. Instead the attribute @AssignedBy will communicate the information previously communicated in the prefix.

Refer to LoadTenderResponseReferenceType definition for any enumerations.

AssignedBy [attribute]

AssignedBy is optional. A single instance might exist.

Identifies the type of party or the agency that has assigned the associated item, e.g. a reference of type OrderNumber.

Refer to AssignedBy for any enumerations.

LoadTenderResponseReferenceType [attribute]

Provides a contextual explanation of the specific reference identifier. Many items are currently prefixed by "Buyer", "Forwarder", "Manufacturer", "Mill",

attribute	
LoadTenderResponseReferenceType	
type	referenceType

papiNet V2R31

"Seller", "Supplier", "Warehouse", or "Vendor". Check for an existing non-prefixed version and use the non-prefixed version instead. In the (yet to be announced release date) version 3.0 the prefixed versions will be removed. Instead the attribute @AssignedBy will communicate the information previously communicated in the prefix.

Refer to the [referenceType](#) entry for the list of enumerations and their definitions.

LoadTenderResponseSegment

The details for a particular load segment.

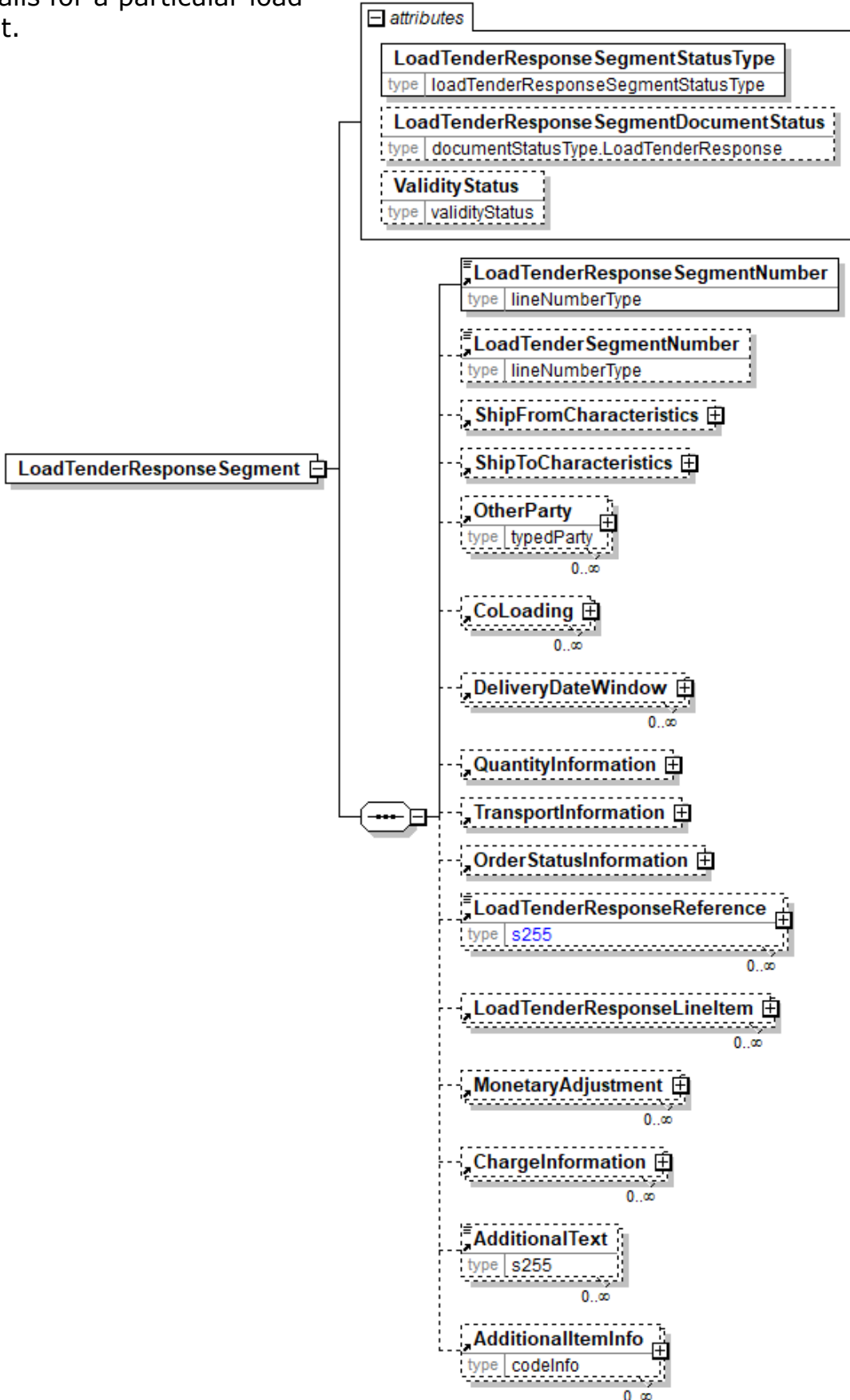

LoadTenderResponseSegmentStatusType [attribute]

LoadTenderResponseSegmentStatusType is mandatory. A single instance is required.

Identifies the status of the load tender segment.

Refer to LoadTenderResponseSegmentStatusType definition for any enumerations.

LoadTenderResponseSegmentDocumentStatus [attribute]

LoadTenderResponseSegmentDocumentStatus is optional. A single instance might exist.

Defines the actual document status for the LoadTenderResponseSegment.

Refer to LoadTenderResponseSegmentDocumentStatus definition for any enumerations.

ValidityStatus [attribute]

ValidityStatus is optional. A single instance might exist.

The validity status for a specific item.

Refer to ValidityStatus definition for any enumerations.

(sequence)

The sequence of items below is mandatory. A single instance is required.

LoadTenderResponseSegmentNumber

LoadTenderResponseSegmentNumber is mandatory. A single instance is required.

The identifier for the LoadTenderResponse segment.

LoadTenderSegmentNumber

LoadTenderSegmentNumber is optional. A single instance might exist.

The identifier for the LoadTender segment.

ShipFromCharacteristics

ShipFromCharacteristics is optional. A single instance might exist.

A group item that provides information pertaining to the Ship-From Party.

ShipToCharacteristics

ShipToCharacteristics is optional. A single instance might exist.

A group item that provides information important for the Ship-To Party.

OtherParty

OtherParty is optional. Multiple instances might exist.

An organisation or business entity other than those specifically detailed within an e-Document.

CoLoading

CoLoading is optional. Multiple instances might exist.

A group item specifying information about items to be loaded or loaded on the same transport unit.

Used to identify:

- Delivery together to the drop point

- Transport Orders stuffed together in a container

Transport Orders not splittable

DeliveryDateWindow

DeliveryDateWindow is optional. Multiple instances might exist.

A group item defining the date/time interval for delivery to take place. An element which may contain the estimated date for which delivery is expected. This date is not absolute.

QuantityInformation

QuantityInformation is optional. A single instance might exist.

A group item containing information about quantity and informational quantity of similar items.

TransportInformation

TransportInformation is optional. A single instance might exist.

A grouping element for transport information.

OrderStatusInformation

OrderStatusInformation is optional. A single instance might exist.

A group element that stores two levels of order status codes.

LoadTenderResponseReference

LoadTenderResponseReference is optional. Multiple instances might exist.

An item detailing relevant references pertaining to the LoadTenderResponse. The type of reference is identified by the LoadTenderReferenceType attribute.

LoadTenderResponseLineItem

LoadTenderResponseLineItem is optional. Multiple instances might exist.

The details for a particular load line item.

MonetaryAdjustment

MonetaryAdjustment is optional. Multiple instances might exist.

The element containing the information necessary for the understanding, calculation, and treatment of an adjustment to a currency amount. MonetaryAdjustment contains an attribute that indicates the type of adjustment being communicated.

ChargeInformation

ChargeInformation is optional. Multiple instances might exist.

A group element that contains elements that describe a charge. ChargeInformation is used when charge details need to be specified by using a code assigned by an agency. It is typically used for freight costs and other costs related to the supply chain.

AdditionalText

AdditionalText is optional. Multiple instances might exist.

A text field that is used to communicate information not previously defined or for special instructions. To be used only for circumstances not covered by specific elements.

AdditionalItemInfo

AdditionalItemInfo is optional. Multiple instances might exist.

A grouping element that contains information about additional items specified by an

agency. Restricted use of this element is recommended.

LoadTenderResponseSegmentDocumentStatus [attribute]

Defines the actual document status for the LoadTenderResponseSegment.

This item is restricted to the following list.

attribute
LoadTenderResponseSegmentDocumentStatus
type documentStatusType.LoadTenderResponse

Cancelled

The supplied information of the document item is cancelled. Items that have been cancelled are not included in totals on the summary level of e-Documents.

Confirmed

The supplied information of the document item is agreed. If a requested change or cancellation of an existing document item can not be accepted, then the earlier agreed information of the document item will be re-confirmed.

Pending

The supplied information of the document item is being investigated.

Rejected

The supplied information of the document item can not be accepted. The document item is new or not earlier confirmed.

LoadTenderResponseSegmentNumber

The identifier for the LoadTenderResponse segment.

LoadTenderResponseSegmentNumber
type lineNumberType

LoadTenderResponseSegmentStatusType [attribute]

Identifies the status of the LoadTender segment.

This item is restricted to the following list.

attributes
LoadTenderResponseSegmentStatusType
type loadTenderResponseSegmentStatusType

Accepted

The supplied information is accepted.

Amended

The supplied information is changed.

Cancelled

The supplied information has been cancelled. Items that have been cancelled are not included in totals on the summary levels of the e-Documents.

NoAction

The supplied information has not been amended and thereby requires no action.

Pending

The supplied information is not complete and will be updated later.

Rejected

The supplied information is rejected.

LoadTenderResponseStatusType [attribute]

Identifies the status of the entire LoadTender response e-Document (in other words, at the root level).

This item is restricted to the following list.



Accepted

The supplied information is accepted.

Amended

The supplied information is changed

Cancelled

The supplied information has been cancelled. Items that have been cancelled are not included in totals on the summary levels of the e-Document.

Pending

The supplied information is not complete and will be updated later.

Rejected

The supplied information is rejected.

LoadTenderResponseSummary

Summary information that applies to the entire LoadTenderResponse e-Document.

(sequence)

The sequence of items below is mandatory. A single instance is required.

TotalQuantityInformation

TotalQuantityInformation is optional. Multiple instances might exist.

A group item containing information about the total quantity and total informational quantity of similar items in the document. TotalQuantityInformation is primarily used in the summary section of e-Documents where it is repeatable to permit totalling for different units of measure.

LineItemSubTotal

LineItemSubTotal is optional. A single instance might exist.

The total amount of all base amounts on e-Document line items. The base amount contains the result of the calculation quantity times the base unit price. As such it does not include any taxes. For example, in an Invoice claiming payment for products LineItemSubTotal is equal to the sum of all InvoiceLineBaseAmount.

TotalAdjustments

TotalAdjustments is optional. A single instance might exist.

The CurrencyValue of TotalAdjustments contains the total of all adjustments and charges excluding tax. For example, in the Invoice TotalAdjustments is equal to the sum of the signed values of the MonetaryAdjustmentAmount for all instances of MonetaryAdjustment with PriceAdjustment and FlatAmountAdjustment and plus the sum of the signed values of the ChargeNetAmount for all instances of ChargeInformation.

TotalTaxAmount

TotalTaxAmount is optional. A single instance might exist.

The CurrencyValue of TotalTaxAmount contains the sum of all instances of TaxAdjustment in the document. TotalTaxAmount contains the sum of all instances of the MonetaryAdjustmentAmount for tax adjustments.

TotalNetAmount

TotalNetAmount is optional. A single instance might exist.

A field containing total amount excluding tax. For example, in the Invoice TotalNetAmount is equal to the sum of LineItemSubTotal plus TotalAdjustments. TotalNetAmount encapsulates CurrencyValue.

TotalAmount

TotalAmount is optional. A single instance might exist.

The total amount including tax (when tax is specified in the e-Document).

In e-Documents claiming payment this is the amount due for payment based on

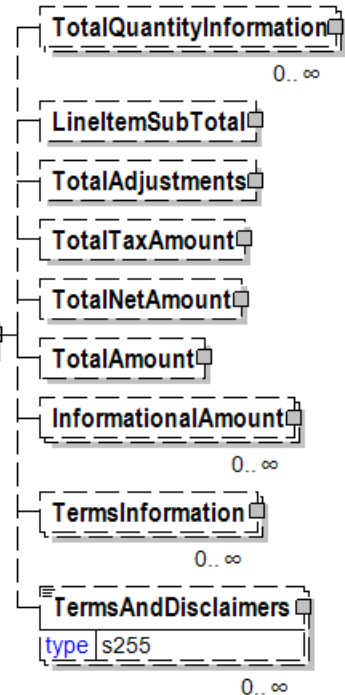

the terms of payment. Decimal rounding might be applied to this amount.

InformationalAmount

InformationalAmount is optional. Multiple instances might exist.

A monetary amount used for information purposes only (not for calculation). For example, the invoice price adjustment subtotal is expressed in sterling pounds, and the buyer wants this information expressed in U.S. dollars.

CreditDebitNote and Invoice - The TaxAmount is displayed in the currency that is applicable throughout the e-Document. When a TaxAmount needs to be displayed in a different national currency, this field is used.

TermsInformation

TermsInformation is optional. Multiple instances might exist.

An element that contains the term related information.

TermsAndDisclaimers

TermsAndDisclaimers is optional. Multiple instances might exist.

An element that contains legal information with an indication of what the Language is.

LoadTenderResponseType [attribute]

Code indicating the function of the e-Document.

This item is restricted to the following list.

<i>attribute</i>
LoadTenderResponseType
<i>type</i> loadTenderResponseType

PreBookingConfirmation

A communication of the requirement for a transport vehicle or unit reservation that has risen from a rough transport plan.

BookingConfirmation

A communication affirming the placement of the booking with a particular party.

LoadTenderResponse

Indicates the ability of the respondent to fulfill the load tender request.

LoadTenderSegment

The details for a particular load tender segment.

LoadTenderSegmentStatusType [attribute]

LoadTenderSegmentStatusType is mandatory. A single instance is required.

Identifies the status of the LoadTender segment.

Refer to LoadTenderSegmentStatusType definition for any enumerations.

LoadTenderSegment

LoadTenderSegmentDocumentStatus [attribute]

LoadTenderSegmentDocumentStatus is optional. A single instance might exist.

Defines the actual document status for the LoadTenderSegment.

Refer to LoadTenderSegmentDocumentStatus definition for any enumerations.

ValidityStatus [attribute]

ValidityStatus is optional. A single instance might exist.

The validity status for a specific item.

Refer to ValidityStatus definition for any enumerations.

(sequence)

The sequence of items below is mandatory. A single instance is required.

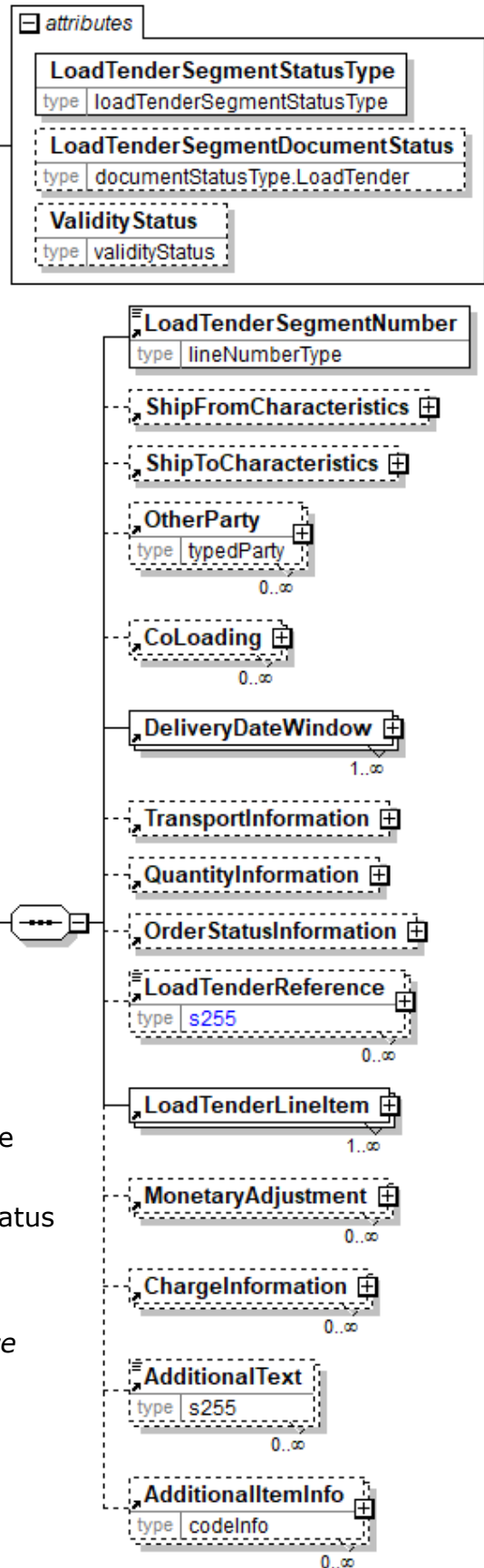

LoadTenderSegmentNumber

LoadTenderSegmentNumber is mandatory. A single instance is required.

The identifier for the LoadTender segment.

ShipFromCharacteristics

ShipFromCharacteristics is optional. A single instance might exist.

A group item that provides information pertaining to the Ship-From Party.

ShipToCharacteristics

ShipToCharacteristics is optional. A single instance might exist.

A group item that provides information important for the Ship-To Party.

OtherParty

OtherParty is optional. Multiple instances might exist.

An organisation or business entity other than those specifically detailed within an e-Document.

CoLoading

CoLoading is optional. Multiple instances might exist.

A group item specifying information about items to be loaded or loaded on the same transport unit.

Used to identify:

- Delivery together to the drop point

- Transport Orders stuffed together in a container

- Transport Orders not splittable

DeliveryDateWindow

DeliveryDateWindow is mandatory. One instance is required, multiple instances might exist.

A group item defining the date/time interval for delivery to take place. An element which may contain the estimated date for which delivery is expected. This date is not absolute.

TransportInformation

TransportInformation is optional. A single instance might exist.

A grouping element for transport information.

QuantityInformation

QuantityInformation is optional. A single instance might exist.

A group item containing information about quantity and informational quantity of similar items.

OrderStatusInformation

OrderStatusInformation is optional. A single instance might exist.

A group element that stores two levels of order status codes.

LoadTenderReference

LoadTenderReference is optional. Multiple instances might exist.

An item detailing relevant references pertaining to the LoadTender. The type of reference is identified by the LoadTenderReferenceType attribute.

LoadTenderLineItem

LoadTenderLineItem is mandatory. One instance is required, multiple instances might exist.

Group element identifying a line item to be included within this LoadTender Segment.

MonetaryAdjustment

MonetaryAdjustment is optional. Multiple instances might exist.

The element containing the information necessary for the understanding, calculation, and treatment of an adjustment to a currency amount. MonetaryAdjustment contains an attribute that indicates the type of adjustment being communicated.

ChargeInformation

ChargeInformation is optional. Multiple instances might exist.

A group element that contains elements that describe a charge. ChargeInformation is used when charge details need to be specified by using a code assigned by an agency. It is typically used for freight costs and other costs related to the supply chain.

AdditionalText

AdditionalText is optional. Multiple instances might exist.

A text field that is used to communicate information not previously defined or for special instructions. To be used only for circumstances not covered by specific elements.

AdditionalItemInfo

AdditionalItemInfo is optional. Multiple instances might exist.

A grouping element that contains information about additional items specified by an agency. Restricted use of this element is recommended.

LoadTenderSegmentDocumentStatus [attribute]

Defines the actual document status for the LoadTenderSegment.

This item is restricted to the following list.

Cancelled

The supplied information of the document item is cancelled. Items that have been cancelled are not included in totals on the summary level of e-Documents.

Requested

The supplied information of the document item is ordered.

attribute
LoadTenderSegmentDocumentStatus
type documentStatusType.LoadTender

LoadTenderSegmentNumber

The identifier for the LoadTender segment.

LoadTenderSegmentNumber
type lineNumberType

LoadTenderSegmentStatusType [attribute]

Identifies the status of the LoadTender segment.

This item is restricted to the following list.

Amended

The supplied information is changed.

Cancelled

The supplied information has been cancelled. Items that have been cancelled are not included in totals on the summary levels of the e-Document.

NoAction

The supplied information has not been amended and thereby requires no action.

Original

The supplied information is the first version of that information.

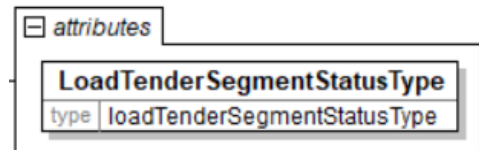

LoadTenderStatusType [attribute]

Identifies the status of the entire LoadTender e-Document (in other words, at the root level).

This item is restricted to the following list.

Amended

The supplied information is changed

Cancelled

The supplied information has been cancelled. Items that have been cancelled are not included in totals on the summary levels of the e-Document.

Original

The supplied information is the first version of that information.

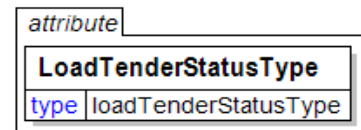

LoadTenderSummary

Summary information that applies to the entire LoadTender e-Document.

(sequence)

The sequence of items below is mandatory. A single instance is required.

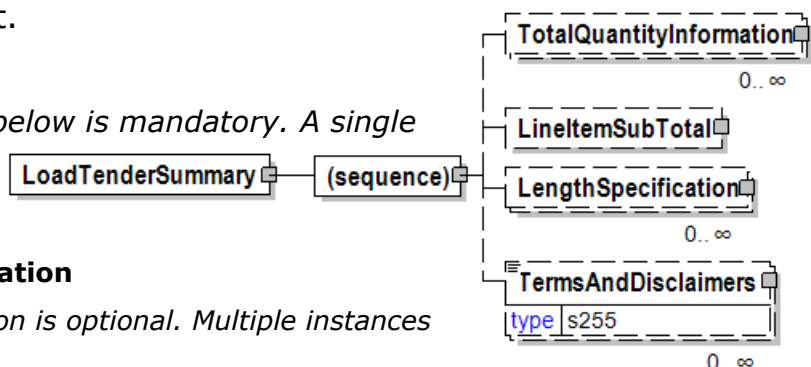

TotalQuantityInformation

TotalQuantityInformation is optional. Multiple instances might exist.

A group item containing information about the total quantity and total informational quantity of similar items in the document.

TotalQuantityInformation is primarily used in the summary section of e-Documents where it is repeatable to permit totalling for different units of measure.

LineItemSubTotal

LineItemSubTotal is optional. A single instance might exist.

The total amount of all base amounts on e-Document line items. The base amount contains the result of the calculation quantity times the base unit price. As such it does not include any taxes. For example, in an Invoice claiming payment for products LineItemSubTotal is equal to the sum of all InvoiceLineBaseAmount.

LengthSpecification

LengthSpecification is optional. Multiple instances might exist.

Length specification of the wood product.

TermsAndDisclaimers

TermsAndDisclaimers is optional. Multiple instances might exist.

An element that contains legal information with an indication of what the Language is.

LoadTenderType [attribute]

Code indicating the function of the LoadTender e-Document.

This item is restricted to the following list.

<i>attribute</i>
LoadTenderType
<i>type</i> loadTenderType

PreBooking

A requirement for a transport vehicle or unit reservation that has risen from a rough transport plan.

Booking

An indication that time for a service is required. For example a booking that is part of a detail transport plan.

LoadTender

More than one carrier has been informed about the upcoming transport requirement (the load).

LocationCharacteristics

A grouping element that contains information related to a geographical location.

(sequence)

The sequence of items below is mandatory. A single instance is required.

LocationProperty

LocationProperty is optional. Multiple instances might exist.

A

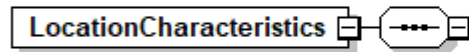

grouping element that contains a specification of a property for a location.

MapPoint

MapPoint is optional. Multiple instances might exist.

A grouping element for items describing a point on a map. A mappoint is normally named waypoint in a GPS.

AreaInfo

AreaInfo is optional. Multiple instances might exist.

A grouping element that contains information about an area, e.g. an area belonging to a location.

OtherDate

OtherDate is optional. Multiple instances might exist.

A date that may not be specifically detailed within a document (example: print date at the PurchaseOrderLineItem).

OtherParty

OtherParty is optional. Multiple instances might exist.

An organisation or business entity other than those specifically detailed within an e-Document.

DocumentReferenceInformation

DocumentReferenceInformation is optional. Multiple instances might exist.

A group item containing reference information applicable to a document.

eAttachment

eAttachment is optional. A single instance might exist.

eAttachment enables the sender to provide information about attachments to the document.

- Note: An element "e-Attachment" also exists. papiNet will no longer use hyphens in our element and attribute names as this causes issues with BizTalk.

AdditionalText

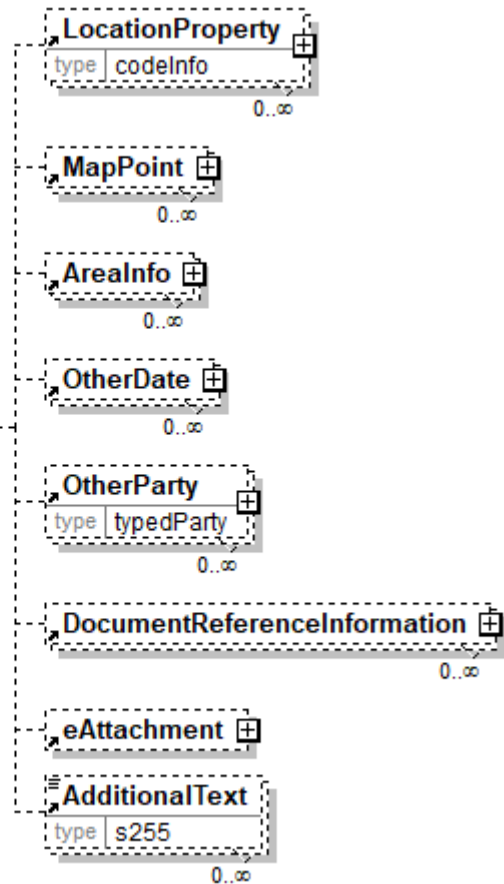

AdditionalText is optional. Multiple instances might exist.

A text field that is used to communicate information not previously defined or for special instructions. To be used only for circumstances not covered by specific elements.

LocationCode

A code used to identify a specific physical location within a site identified by a party, e.g. a loading station in a warehouse or an unloading station at a printer site.

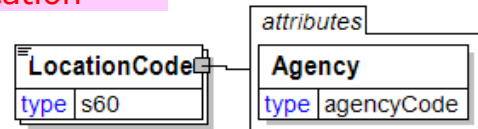

LocationCode will be deprecated in a future version V3R00. Use SupplyPoint instead of LocationCode.

Agency [attribute]

Agency is mandatory. A single instance is required.

Describes the agency maintaining the list of codes. To be included in this list the agency must be a recognized standards body or industry organisation.

- For the element that owns this attribute.
- For another attribute in the list of attributes associated with the parent element.

Refer to Agency definition for any enumerations.

LocationIdentifier

Options for identifying a physical location.

(choice)

[choice] is mandatory. A single instance is required.

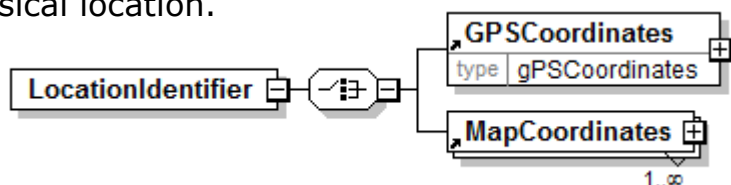

GPSCoordinates

GPSCoordinates is mandatory. A single instance is required.

The location of the party as specified using a Global Positioning System.

This element will be deprecated in a future version V3R00 and should not be used in new implementations. Use instead the MapCoordinates

MapCoordinates

MapCoordinates is mandatory. One instance is required, multiple instances might exist.

A group item defining and containing position coordinates of a location.

LocationInfo

A grouping element that contains information about a geographical location.

(sequence)

The sequence of items below is mandatory. A single instance is required.

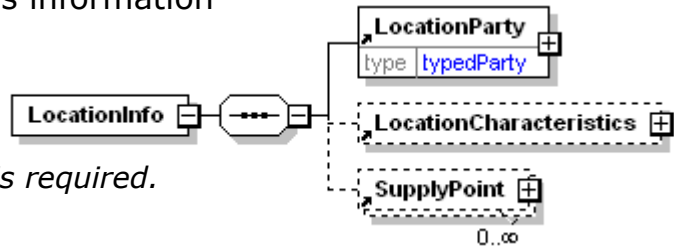

LocationParty

LocationParty is mandatory. A single instance is required.

The organization or business entity where the business event took place or will take place.

LocationCharacteristics

LocationCharacteristics is optional. A single instance might exist.

A grouping element that contains information related to a geographical location.

SupplyPoint

SupplyPoint is optional. Multiple instances might exist.

Grouping element that contains items describing a supply point. A SupplyPoint belongs to a LocationParty, e.g. in a DeliveryOrigin or DeliveryDestination, and describes where goods are stored and can be loaded or unloaded. A SupplyPoint can for example be a loading or unloading gate at a warehouse or a road side landing at a logging area in the forest.

LocationInformation

A grouping element describing the location of the shipment.

(sequence)

The sequence of items below is mandatory. A single instance is required.

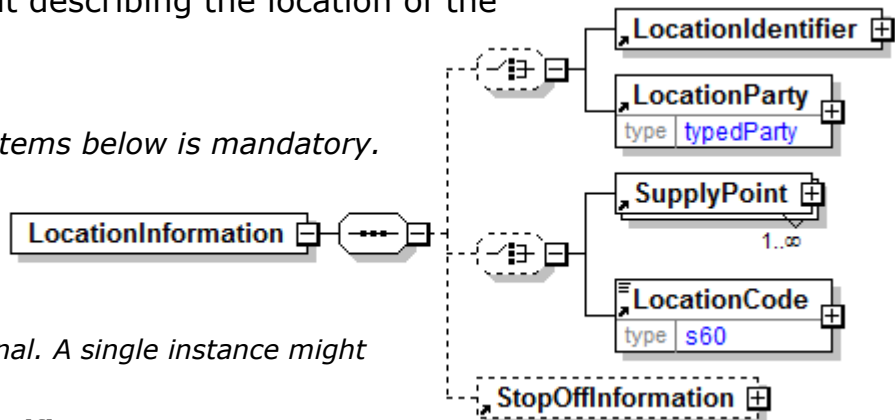

(choice)

[choice] is optional. A single instance might exist.

LocationIdentifier

LocationIdentifier is mandatory. A single instance is required.

Options for identifying a physical location.

LocationParty

LocationParty is mandatory. A single instance is required.

The organization or business entity where the business event took place or will take place.

(choice)

[choice] is optional. A single instance might exist.

SupplyPoint

papiNet V2R31

SupplyPoint is mandatory. One instance is required, multiple instances might exist.

Grouping element that contains items describing a supply point. A SupplyPoint belongs to a LocationParty, e.g. in a DeliveryOrigin or DeliveryDestination, and describes where goods are stored and can be loaded or unloaded. A SupplyPoint can for example be a loading or unloading gate at a warehouse or a road side landing at a logging area in the forest.

LocationCode

LocationCode is mandatory. A single instance is required.

A code used to identify a specific physical location within a site identified by a party, e.g. a loading station in a warehouse or an unloading station at a printer site.

LocationCode will be deprecated in a future version V3R00. Use SupplyPoint instead of LocationCode.

StopOffInformation

StopOffInformation is optional. A single instance might exist.

Where is the shipment and how far to the next stop.

LocationParty

The organization or business entity where the business event took place or will take place.

LocationType [attribute]

LocationType is optional. A single instance might exist.

Defines type of location when context needs to be specified, e.g. when goods are moved from one location to a new location.

Refer to LocationType definition for any enumerations.

PartyType [attribute]

PartyType is mandatory. A single instance is required.

Identifies the business role associated with the particular party

Refer to PartyType definition for any enumerations.

LogisticsRole [attribute]

LogisticsRole is optional. A single instance might exist.

Communicates the nature of the logistics role, if any, the party plays in the transaction.

Refer to LogisticsRole definition for any enumerations.

(sequence)

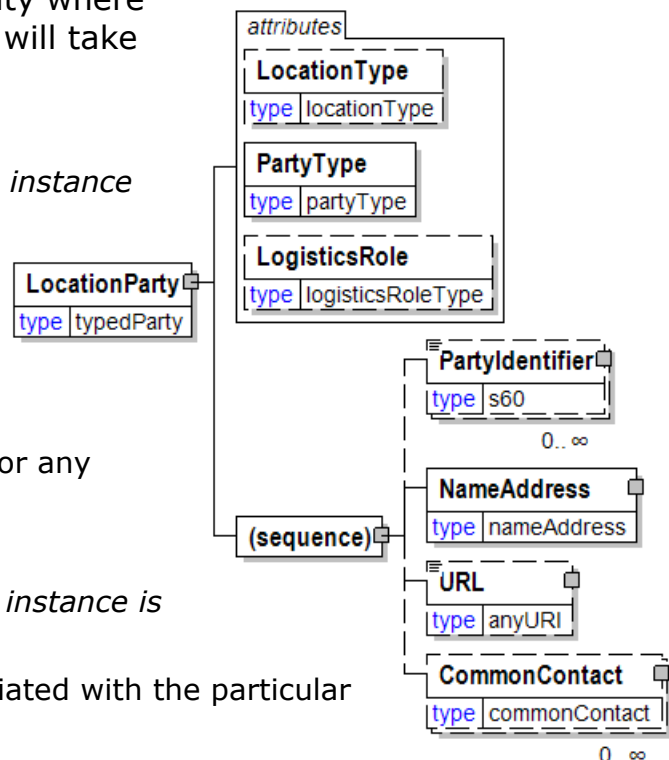

papiNet V2R31

The sequence of items below is mandatory. A single instance is required.

PartyIdentifier

PartyIdentifier is optional. Multiple instances might exist.

A unique identifier of a specific party. This element contains an attribute PartyIdentifierType that indicates the type of the identifier.

NameAddress

NameAddress is mandatory. A single instance is required.

A group item containing name and address of an organisation or business entity.

URL

URL is optional. A single instance might exist.

Universal Resource Locator. While typically a web address you could use this field to hold an email address.

CommonContact

CommonContact is optional. Multiple instances might exist.

Identifies a specific individual associated with the party.

LocationPartyType

Identifies a business role associated with a location where business events take place

LocationPartyType
type locationPartyType

This item is restricted to the following list.

BorderCrossing

A geographic location separating two countries authorised to validate customs documentation.

CustomerFacility

The type of the origin or destination location of a transport leg in a route is a buyer facility, usually a print site, or a warehouse owned by the buyer.

CustomerStock

A "virtual" location that indicates that the material is owned by the customer.

Laboratory

Laboratory is where analysis is done.

LoggingArea

A geographic location in the forest where logging takes place.

Mill

A production facility.

PlaceFinalDestination

The final destination of the goods.

PlaceOfAccept

The location where acceptance of the goods is to take place.

PlaceOfDespatch

The location where despatch took place.

PlaceOfDischarge

The location where the goods were unloaded.

PlaceOfLoading

The location where loading is to or took place.

PlaceOfMeasuring

The location where the products are measured.

PlaceOfPassingThrough

A location to be passed by a vehicle, e.g. a main intersection on a Route.

PlaceOfReloading

A location where the goods were or will be transferred from one transport to another. It may but does not need to involve a change of transport mode.

Port

The type of the origin or destination location of a transport leg in a route. It is a maritime location.

PrinterFacility

The location of the printer who will be using the product.

ShipFromLocation

The location the goods were shipped from.

ShipTo

The address the material should be shipped to.

Terminal

The type of the origin or destination location of a transport leg in a route. It can be a sea, road or rail terminal.

Warehouse

A storage location. It can be the origin or destination location of a transport leg in a route.

LocationProperty

A grouping element that contains a specification of a property for a location.

Agency [attribute]

Agency is mandatory. A single instance is required.

Describes the agency maintaining the list of codes. To be included in this list the agency must be a recognized standards body or industry organisation.

- For the element that owns this attribute.
- For another attribute in the list of attributes associated with the parent element.

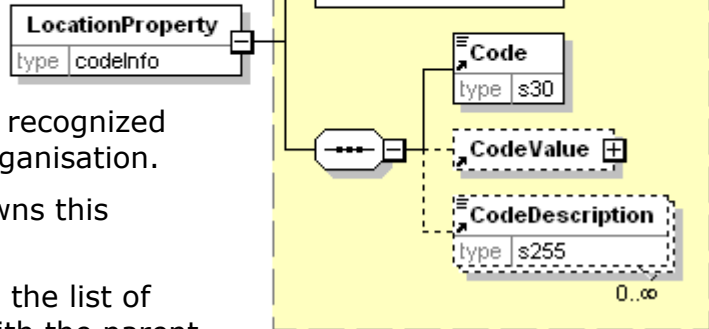

Refer to Agency definition for any enumerations.

(sequence)

The sequence of items below is mandatory. A single instance is required.

Code

Code is mandatory. A single instance is required.

Specifies a code that is defined by an agency. The agency is given for the whole construct containing the code.

CodeValue

CodeValue is optional. A single instance might exist.

A grouping element specifying a value belonging to a code that is defined by an agency.

CodeDescription

CodeDescription is optional. Multiple instances might exist.

A textual description for the meaning of a code that is defined by an agency. When the Code is associated with a CodeValue of type TextValue, then the CodeDescription is a textual description of both the Code and the TextValue.

LocationQualifier [attribute]

An attribute of the shipment method of payment describing the location to which the delivery terms refer. This location determines where and when the goods ownership is transferred from the seller to the buyer.

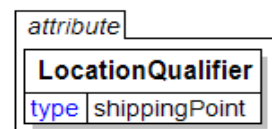

This item is restricted to the following list.

Destination

Ownership is transferred at the final destination.

DistributionCentre

Ownership is transferred at the distribution centre, which is an intermediate warehouse.

Dock

Ownership is transferred at the dock.

Factory

Ownership is transferred where the product is made.

Mill

Ownership is transferred at the manufacturing unit (paper mill).

OnVesselFOBPoint

Ownership is transferred on the vessel.

Origin

Ownership is transferred at the originating shipment location.

OriginAfterLoadingOnEquipment

Ownership is transferred at the time equipment is loaded at the mill/warehouse/terminal.

OriginShippingPoint

Ownership is transferred at the origin shipping point, in other words, at the port of loading.

Plant

Ownership does not transfer until received at the buyer's facility.

Port

Ownership is transferred at the port.

Reload

Ownership is transferred when the product is reloaded for final shipment.

Terminal

Ownership is transferred at the terminal

Warehouse

Ownership changes upon departure of the goods from the warehouse.

LocationType [attribute]

Defines type of location when context needs to be specified, e.g. when goods are moved from one location to a new location.

This item is restricted to the following list.

Destination

Defines location as a Destination

Origin

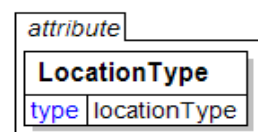

Defines location as an Origin

ViaLocation

The location is a location on the route before arrival to the destination.

LocationType [attribute]

Location of Break on the Press. A group item detailing relevant locations on the press to the Performance e-Document.

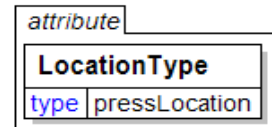

This item is restricted to the following list.

AirTurn

After Colour Unit – just prior to Dryer

Chills

After Dryer – on chill rolls

Dryer

Within Dryer equipment

Folder

Within Folders ; prior to cut off delivery

Infeed

Prior to Printing Units, after Reel Stand /Splicing Area

PrintingUnit

Within any colour unit

ReelStand

Non Splice phase – prior to Infeed

RibbonDeck

After slitting ; prior to folder

Slitter

As Web is slit to ribbons

Splicer

During the pasting cycle

Log

Log information

(sequence)

The sequence of items below is mandatory. A single instance is required.

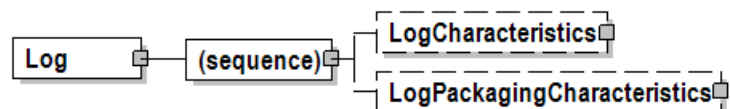

LogCharacteristics

LogCharacteristics is optional. A single instance might exist.

Log characteristics

LogPackagingCharacteristics

LogPackagingCharacteristics is optional. A single instance might exist.

Log packaging characteristics

LogCharacteristics

Log characteristics

LogLengthType [attribute]

LogLengthType is optional. A single instance might exist.

Log length type

Refer to LogLengthType definition for any enumerations.

Debarked [attribute]

Debarked is optional. A single instance might exist.

Either "Yes" or "No".

Refer to Debarked definition for any enumerations.

LogConversionRule [attribute]

LogConversionRule is optional. A single instance might exist.

Used to report the standard conversion rule used when converting log size to board-feet or other volume measurement

Refer to LogConversionRule definition for any enumerations.

(sequence)

The sequence of items below is mandatory. A single instance is required.

Length

Length is optional. A single instance might exist.

The length of the object.

SmallEndDiameter

SmallEndDiameter is optional. A single instance might exist.

Reports the log crown end diameter as a measurement.

LargeEndDiameter

LargeEndDiameter is optional. A single instance might exist.

Used to report the log butt end diameter as a measurement.

DiameterBreastHeight

DiameterBreastHeight is optional. A single instance might exist.

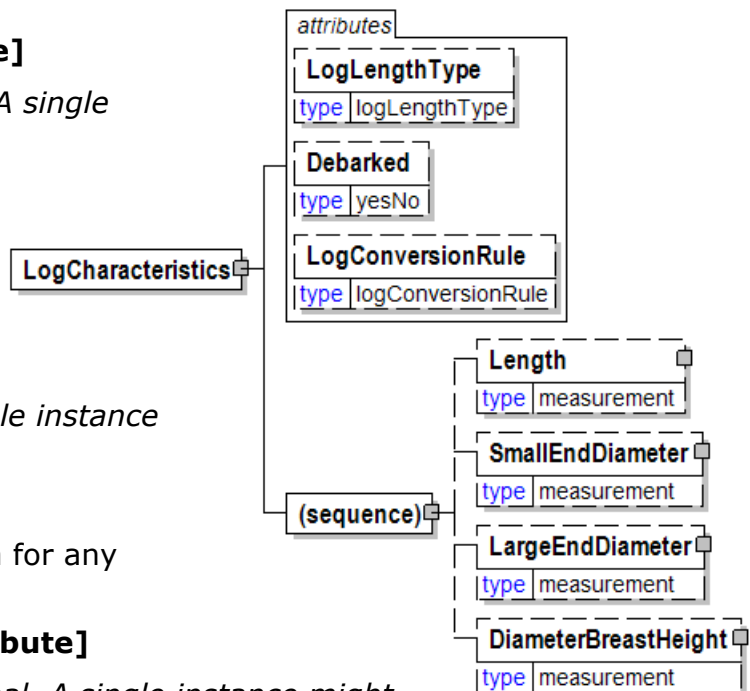

papiNet V2R31

Used to report the log diameter 4.5 feet from the butt end as a measurement. Used with the LogConversionRule attribute to determine log's volume conversion to board-feet or other measure.

LogConversionRule [attribute]

Used to report the standard conversion rule used when converting log size to board-feet or other volume measurement



This item is restricted to the following list.

Doyle

The Doyle Log Rule, developed around 1825, is based on a mathematical formula and is widely used throughout the southern United States. This rule allows for a saw kerf of 5/16 inch and a slabbing allowance of 4 inches, which is about twice the normal amount. Because of this, the Doyle Rule is somewhat inconsistent; it underestimates small logs and overestimates large logs. As a seller of timber, you must be aware that for smaller logs the Doyle Rule will underestimate the actual volume of wood that you have in your trees.

International

This rule was developed in 1906 and is based on a reasonably accurate mathematical formula. The rule allows for a 1/4-inch saw kerf and a fixed taper allowance of 1/2 inch per 4 feet of log length. Deductions are also allowed for shrinkage of boards and a slab thickness that varies with the log diameter. Overall, the International 1/4-Inch Log Rule is the most consistent and is often used as a basis of comparison for log rules.

Scribner

The Scribner Log Rule, developed around 1846, is a good example of a diagram rule. It was created by drawing the cross-sections of 1-inch boards within circles representing the end view of logs. A space of 1/4 inch was left between the boards to account for saw kerf. The Scribner Rule does not have an allowance for log taper and typically underestimates logs, particularly if the log length is long.

ScribnerDecimalC

The Scribner Decimal C is a different form of the Scribner Rule; it rounds the volumes to the nearest 10 board feet. For example, 392 board feet on the Scribner is equivalent to 390 board feet on the Scribner Decimal C scale.

LogisticsRole [attribute]

Communicates the nature of the logistics role, if any, the party plays in the transaction.

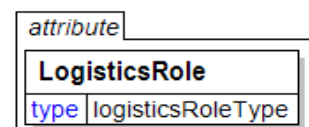

This item is restricted to the following list.

Consignee

The party to whom the goods are turned over to.

Consignor

The party who is responsible for the goods prior to the shipping process.

LogisticsProvider

The party who is responsible for logistics services. This definition of LogisticsProvider allows you to define a party as a buyer of logistics services as well as a supplier of logistics services.

LogLengthType [attribute]

Log length type

This item is restricted to the following list.

CutToLength

RandomLength

Short

TreeLength

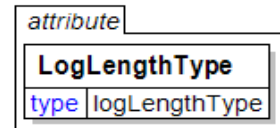

LogPackagingCharacteristics

Log packaging characteristics

DoubleBunked [attribute]

DoubleBunked is optional. A single instance might exist.

Either "Yes" or "No".

Refer to DoubleBunked definition for any enumerations.

(sequence)

The sequence of items below is mandatory. A single instance is required.

Identifier

Identifier is mandatory. One instance is required, multiple instances might exist.

An Identifier is required for packages and items (pallets, reel packages, boxes, ream items, reel items, etc). The Identifier element contains the actual item identifier code. Identifier is repeatable so more than one identifier can be communicated. For example, the printed identifier on a label may be different from the barcode printed on the label.

ItemCount

ItemCount is optional. A single instance might exist.

A count of the number of items (examples: a count of the number of boxes on a pallet or of reams in a box).

Quantity

Quantity is mandatory. A single instance is required.

The Quantity element contains attributes that provide information about the type of

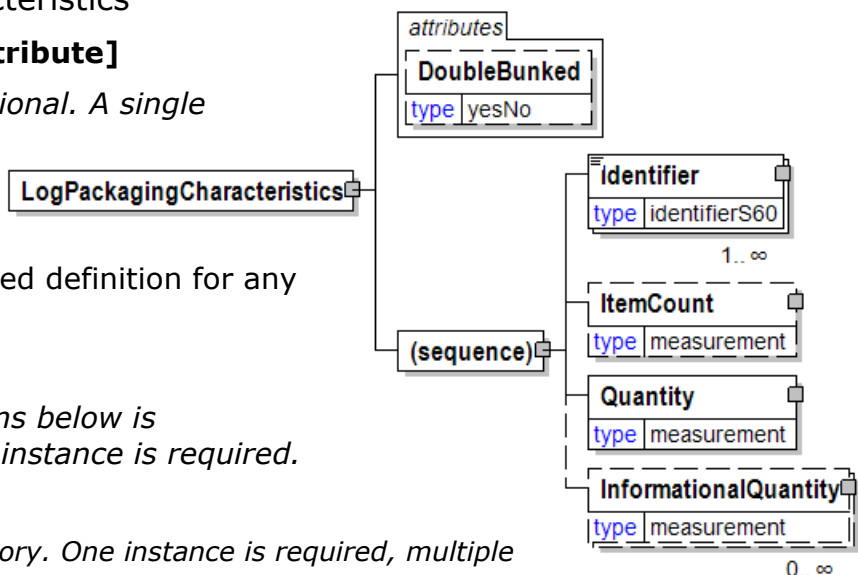

papiNet V2R31

quantity that is being communicated, the context in which the particular quantity is to be viewed, and (if the quantity represents an adjustment) an adjustment type.

The Quantity element contains three child elements that enable you to communicate a range of values for the quantity and a target or actual value. It is at this level (Value, RangeMin, and RangeMax) that the unit of measure is specified. This permits the range to be specified in a different unit of measure than the target.

InformationalQuantity

InformationalQuantity is optional. Multiple instances might exist.

A quantity given in a valid UOM used for information purposes only (not for calculation). For example, an ordered quantity was 100 reels as opposed to the invoice quantity of 20,000 pounds.

Longitude

A measurement of the position of the party or contact in degrees east or west of the prime meridian

Longitude
type dec18-8

LumberGrade

Defines quality characteristics achieved by selecting pieces based on a grading rule.

GradeType [attribute]

GradeType is optional. A single instance might exist.

Grade Type

Refer to GradeType definition for any enumerations.

GradingRule [attribute]

GradingRule is optional. A single instance might exist.

Grading rule, the rules under which the product has been graded.

Refer to GradingRule definition for any enumerations.

GradeAgency [attribute]

GradeAgency is optional. A single instance might exist.

LumberAgency identifies which agency is responsible for assigning the lumber attributes.

Refer to GradeAgency definition for any enumerations.

ModulusElasticity [attribute]

ModulusElasticity is optional. A single instance might exist.

Modulus elasticity

LumberGrade
type lumberGradeClass

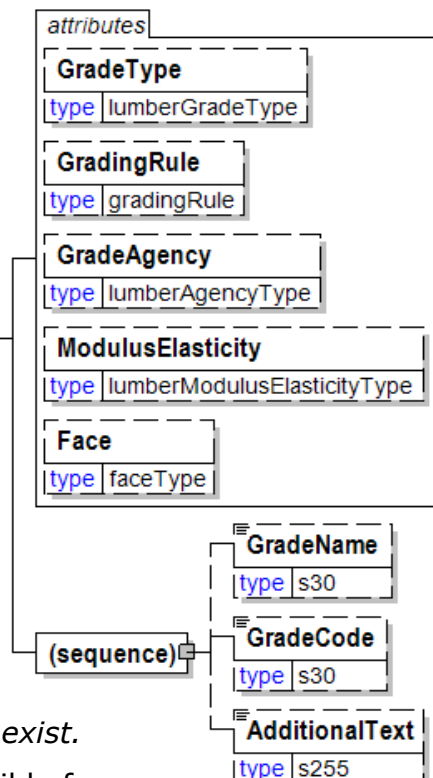

papiNet V2R31

Refer to ModulusElasticity definition for any enumerations.

Face [attribute]

Face is optional. A single instance might exist.

Used to describe which side (or face) of the product that the grade is applicable to.

Refer to Face definition for any enumerations.

(sequence)

The sequence of items below is mandatory. A single instance is required.

GradeName

GradeName is optional. A single instance might exist.

A specific product name for which the owner or source is specified in the "@AssignedBy" attribute (for example, ImprovedNewsprint-45-1479)

GradeCode

GradeCode is optional. A single instance might exist.

A specific product code for which the owner or source is specified in the "@AssignedBy" attribute

AdditionalText

AdditionalText is optional. A single instance might exist.

A text field that is used to communicate information not previously defined or for special instructions. To be used only for circumstances not covered by specific elements.

LumberSpecies

Specifies the raw material species.

SpeciesType [attribute]

SpeciesType is optional. A single instance might exist.

Defines the species or mix of species comprising the product.

Refer to SpeciesType definition for any enumerations.

SpeciesOrigin [attribute]

SpeciesOrigin is optional. A single instance might exist.

The country of origin of the species employed in manufacture of the product.

Refer to SpeciesOrigin definition for any enumerations.

SpeciesAgency [attribute]

SpeciesAgency is optional. A single instance might exist.

Defines the governing organisation of the scheme employed in determining

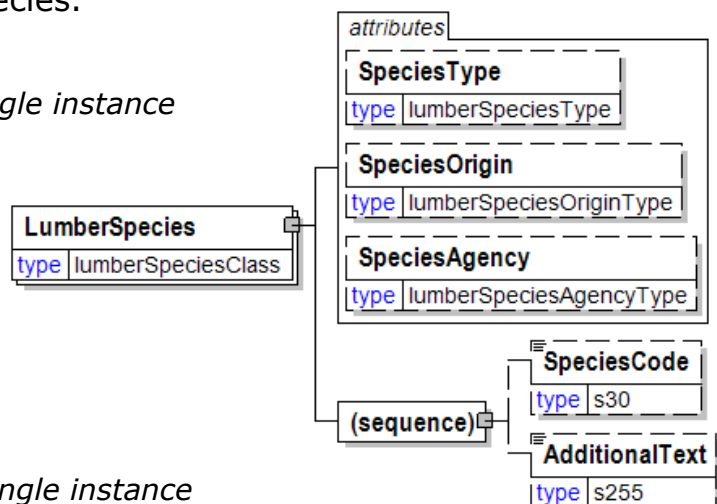

the species of the product.

Refer to SpeciesAgency definition for any enumerations.

(sequence)

The sequence of items below is mandatory. A single instance is required.

SpeciesCode

SpeciesCode is optional. A single instance might exist.

Species Code

AdditionalText

AdditionalText is optional. A single instance might exist.

A text field that is used to communicate information not previously defined or for special instructions. To be used only for circumstances not covered by specific elements.

Luminance

Luminance

TestMethod [attribute]

TestMethod is optional. A single instance might exist.

The method used to determine the results of the test under consideration.

TestAgency [attribute]

TestAgency is optional. A single instance might exist.

The agency that has set the parameters for the testing

Refer to TestAgency definition for any enumerations.

SampleType [attribute]

SampleType is optional. A single instance might exist.

Communicates how sampling was done to measure the product characteristics.

Refer to SampleType definition for any enumerations.

ResultSource [attribute]

ResultSource is optional. A single instance might exist.

Used to define the data source of the specified test

Refer to ResultSource definition for any enumerations.

(sequence)

The sequence of items below is mandatory. A single instance is required.

DetailValue

DetailValue is mandatory. A single instance is required.

A numeric value expressed in the unit of measure (UOM).

DetailRangeMin

DetailRangeMin is optional. A single instance might exist.

The minimum value (lower boundary) allowed for the DetailValue that is the parent of this element.

DetailRangeMax

DetailRangeMax is optional. A single instance might exist.

The maximum value (upper boundary) allowed for the DetailValue that is the

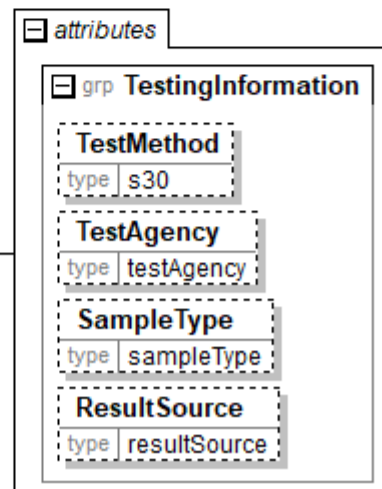
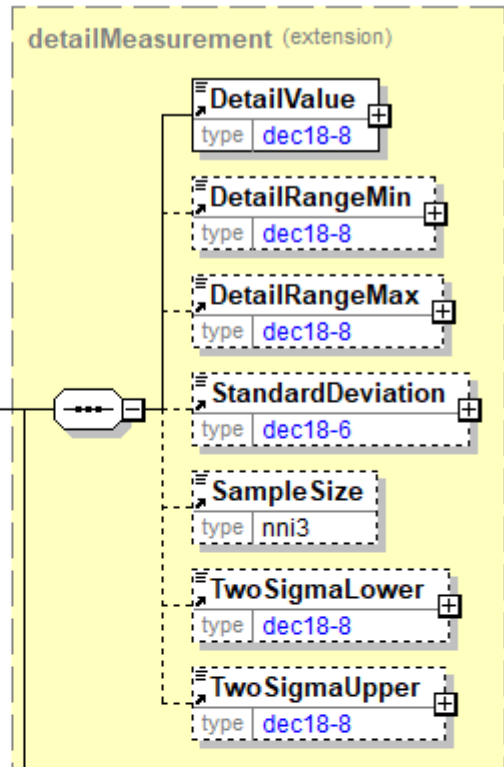

parent of this element.

StandardDeviation

StandardDeviation is optional. A single instance might exist.

A statistic used as a measure of dispersion in a distribution.

SampleSize

SampleSize is optional. A single instance might exist.

The number of samples used to determine the product characteristic in question.

TwoSigmaLower

TwoSigmaLower is optional. A single instance might exist.

Two sigma (a measure of dispersion associated with standard deviation) on the lower side of the standard deviation.

TwoSigmaUpper

TwoSigmaUpper is optional. A single instance might exist.

Two sigma (a measure of dispersion associated with standard deviation) on the upper side of the standard deviation.

Machine

Machine is used to capture information specific to the particular machine used in the conversion or consumption process.

(sequence)

The sequence of items below is mandatory. A single instance is required.

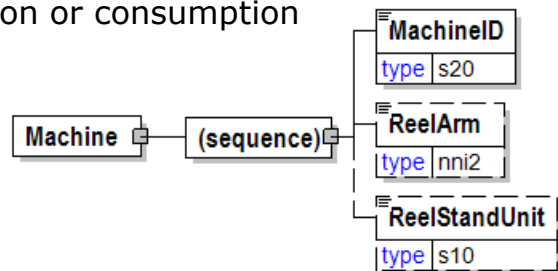

MachineID

MachineID is mandatory. A single instance is required.

An identifier assigned to the particular machine being referenced. For example, a machine could be a paper machine, an off-line coater, a sheeter, or a printing press. The particular machine being referenced will be determined by the business event being supported.

ReelArm

ReelArm is optional. A single instance might exist.

The reel arm number.

ReelStandUnit

ReelStandUnit is optional. A single instance might exist.

The reelstand unit number.

MachineConditions

A grouping element for all the environmental measurement at the time of the run.

(sequence)

The sequence of items below is mandatory. A single instance is required.

Humidity

Humidity is optional. Multiple instances might exist.

Humidity

AmbientTemperature

AmbientTemperature is optional. Multiple instances might exist.

The temperature of the surrounding environment.

MachineSpeed

MachineSpeed is optional. Multiple instances might exist.

The rate at which the machine is, was, or should be running.

Tension

Tension is optional. Multiple instances might exist.

Tension of the web on the printing press.

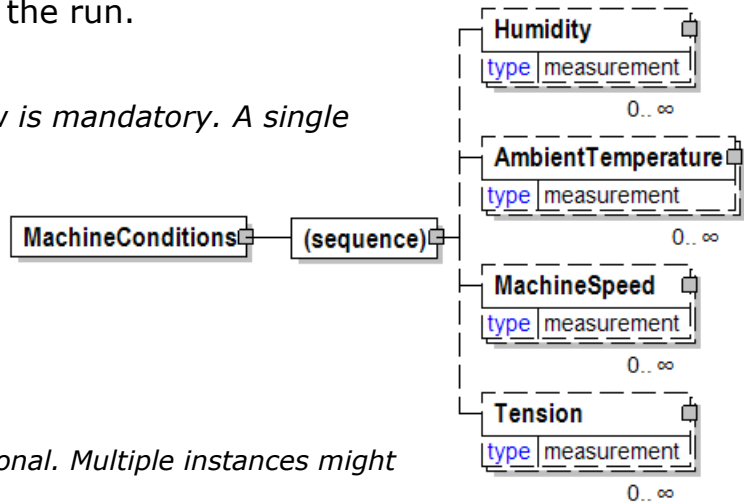

MachineDownTime

The length of loss production time that a machine experienced due to malfunction regardless of cause.

(sequence)

The sequence of items below is mandatory. A single instance is required.

Value

Value is mandatory. A single instance is required.

A numeric value expressed in the unit of measure (UOM).

RangeMin

RangeMin is optional. A single instance might exist.

The minimum value (lower boundary) allowed for the Measurement that is the parent of this element.

RangeMax

RangeMax is optional. A single instance might exist.

The maximum value (upper boundary) allowed for the Measurement that is the parent of this element. Some elements use the RangeMax element with an extended list of unit of measures. (Note: the red colour in the picture is an artifact of how the graphic was captured and should be disregarded.)

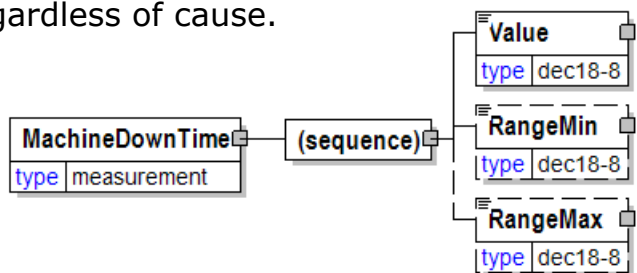

MachineID

An identifier assigned to the particular machine being referenced. For example, a machine could be a paper machine, an off-line coater, a sheeter, or a printing press. The particular machine being referenced will be determined by the business event being supported.

MachineID	
type	s20

MachineLocation

A unique and defined area in the operating machine. On a printing press it would include areas such as: "Splicer", "Infeed", "Print Unit", "folder", "Silcone coater". Also see PressBreakLocation.

MachineLocation	
type	s20

MachineSpeed

The rate at which the machine is, was, or should be running.

SpeedType [attribute]

SpeedType is optional. A single instance might exist.

Speed Type

Refer to SpeedType definition for any enumerations.

(sequence)

The sequence of items below is mandatory. A single instance is required.

Value

Value is mandatory. A single instance is required.

A numeric value expressed in the unit of measure (UOM).

RangeMin

RangeMin is optional. A single instance might exist.

The minimum value (lower boundary) allowed for the Measurement that is the parent of this element.

RangeMax

RangeMax is optional. A single instance might exist.

The maximum value (upper boundary) allowed for the Measurement that is the parent of this element. Some elements use the RangeMax element with an extended list of unit of measures. (Note: the red colour in the picture is an artifact of how the graphic was captured and should be disregarded.)

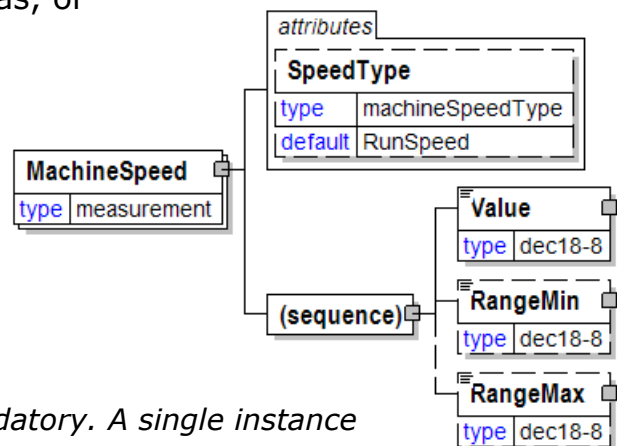

MachineStoppage [attribute]

An indicator on whether the production had to be periodically stopped.

This item is restricted to the following list.

Yes

No

attribute	
MachineStoppage	
type	yesNo
default	No

Magenta

The Magenta component of a colour.

Magenta is a locally defined element used in the CMYK element.

(sequence)

The sequence of items below is mandatory. A single instance is required.

DetailValue

DetailValue is mandatory. A single instance is required.

A numeric value expressed in the unit of measure (UOM).

DetailRangeMin

DetailRangeMin is optional. A single instance might exist.

The minimum value (lower boundary) allowed for the DetailValue that is the parent of this element.

DetailRangeMax

DetailRangeMax is optional. A single instance might exist.

The maximum value (upper boundary) allowed for the DetailValue that is the parent of this element.

StandardDeviation

StandardDeviation is optional. A single instance might exist.

A statistic used as a measure of dispersion in a distribution.

SampleSize

SampleSize is optional. A single instance might exist.

The number of samples used to determine the product characteristic in question.

TwoSigmaLower

TwoSigmaLower is optional. A single instance might exist.

Two sigma (a measure of dispersion associated with standard deviation) on the lower side of the standard deviation.

TwoSigmaUpper

TwoSigmaUpper is optional. A single instance might exist.

Two sigma (a measure of dispersion associated with standard deviation) on the

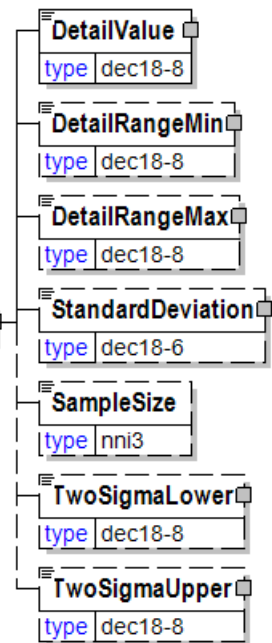
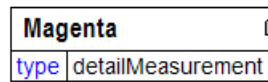

upper side of the standard deviation.

MailAttachment

MailAttachment enables the complainer to indicate that they are providing by mail (express courier, snail mail etc.) proof of the Complaint.

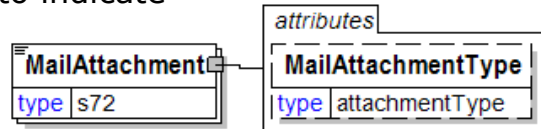

MailAttachmentType [attribute]

MailAttachmentType is optional. A single instance might exist.

The type of mail attachment.

Refer to MailAttachmentType definition for any enumerations.

MailAttachmentType [attribute]

The type of mail attachment.

This item is restricted to the following list.

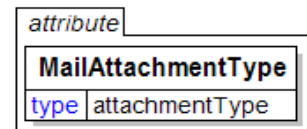

BillOfLading

The mail attachment is a bill of lading.

CMR

Collection maintenance repair, a standard book repair method

Photo

The mail attachment is a photo.

Sample

The mail attachment is a sample.

Waybill

The forwarding agreement or carrying agreement that is used as a receipt for cargo and as a contract of carriage.

MakeTo

Indicates upon which constraint production should be based on (length or diameter). Specifies the basis of the finished diameter of a reel, either a Diameter specification or a Length of paper specification

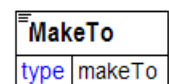

This item is restricted to the following list.

Length

Diameter

ManufacturingProcess

Defines the different machining and processes made for the product.

ManufacturingProcessType [attribute]

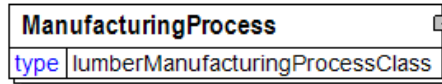

ManufacturingProcessType is optional. A single instance might exist.

Describes the exact nature of any further mechanical processing applied to the product.

Refer to ManufacturingProcessType definition for any enumerations.

ManufacturingProcessAgency [attribute]

ManufacturingProcessAgency is optional. A single instance might exist.

Manufacturing process agency

Refer to ManufacturingProcessAgency definition for any enumerations.

(sequence)

The sequence of items below is mandatory. A single instance is required.

Value

Value is optional. A single instance might exist.

A numeric value expressed in the unit of measure (UOM).

AdditionalText

AdditionalText is optional. A single instance might exist.

A text field that is used to communicate information not previously defined or for special instructions. To be used only for circumstances not covered by specific elements.

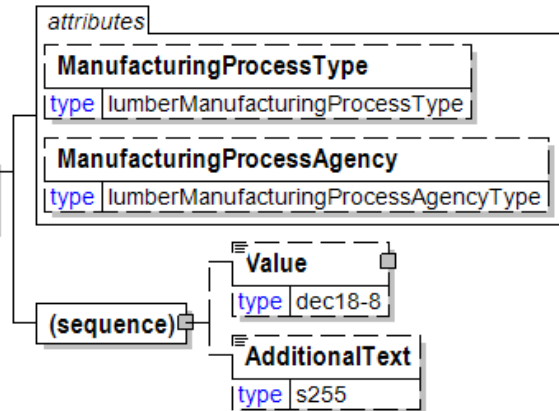

ManufacturingProcessAgency [attribute]

Manufacturing process agency

This item is restricted to the following list.

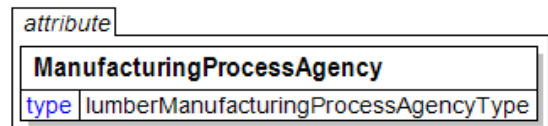

ISO

International Organization for Standardization

prEN TC(1113-1)

Supplier

Product supplier is the agency for the coding structure.

ManufacturingProcessType [attribute]

Describes the exact nature of any further mechanical processing applied to the product.

attribute
ManufacturingProcessType
type lumberManufacturingProcessType

This item is restricted to the following list.

Chamfered

The edge is beveled.

Combed

Compressed

Cut

DrySplitted

EndMatched

Finesawn

FJ-Lam

FJ-Lam components are knotless, finger-jointed and laminated blanks up to 6 meters

FJ-Blank

FurtherProcess

FingerJointed

GlueLamBeam

GreenSplitted

H and M

H or M

HeatTreated

Impregnated

ImpregnatedA

ImpregnatedWolmanitAB

KD56/30

Phyto sanitary treatment. Kiln Dried up to a temperature in the core of the piece of at least 56 C for at least 30 minutes.

Lacquered

Lamwood

A piece of wood built up of plies or laminations that have been joined either with glue or with mechanical fastenings: the term is most frequently applied where the plies are too thick to be classified as veneer and when the grain of all plies is parallel.

MachineStrengthGraded

NorthFloor

Notched

papiNet V2R31

OilTreated

Opti-Blank

Painted

Planed

Pro-Lam

Resawn

Rough

Uneven texture, not smooth as passed through a saw.

Rougher Headed

RoughSawn

S1E

Surfaced one edge

S1S

Surfaced one side

S1S EdgeRgh

Surfaced one side, edge rough

S1S1E

Surfaced one side, one edge

S1S2E

Surfaced one side, two edges

S2E

Surfaced two edges

S2S

Surfaced two sides

S2S EdgeRgh

Surfaced two sides, edge rough

S2S1E

Surfaced two sides, one edge

S4S

Surfaced four sides

S4SEE

Surfaced four sides, eased edges

Sawn

SawTexture

Smooth

Split

StrengthGraded

Treated

Vstol

Other

ManufacturingSpecifications

Manufacturing specifications.

PressType [attribute]

PressType is optional. A single instance might exist.

The type of press used.

Refer to PressType definition for any enumerations.

PressImpositionType [attribute]

PressImpositionType is optional. A single instance might exist.

The type of press imposition

Refer to PressImpositionType definition for any enumerations.

(sequence)

The sequence of items below is mandatory. A single instance is required.

Margins

Margins is optional. A single instance might exist.

Margins.

InkCharacteristics

InkCharacteristics is optional. A single instance might exist.

The ink characteristics.

FinishSpecs

FinishSpecs is optional. A single instance might exist.

Finish specifications

FinishPrep

FinishPrep is optional. A single instance might exist.

Finish prep

PrintedMediaSpecs

PrintedMediaSpecs is optional. A single instance might exist.

Printed media specifications

Perforation

Perforation is optional. Multiple instances might exist.

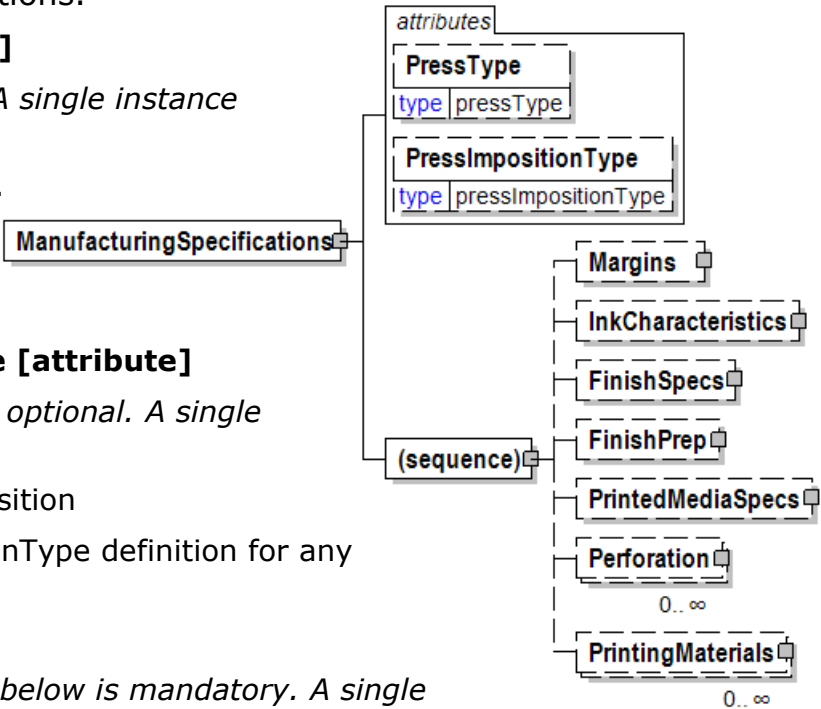

Perforation information

PrintingMaterials

PrintingMaterials is optional. Multiple instances might exist.

Printing materials information.

MapAreaBorderType [attribute]

Specifies if the coordinates belong to an outer border or an inner border for the map point displayed as an area point. An area specified by an inner border is excluded from the area specified by the outer border.



This item is restricted to the following list.

Inner

The inner border for a map point displayed as an area point.

Outer

The outer border for a map point displayed as an area point.

MapCoordinates

A group item defining and containing position coordinates of a location.

MapReferenceSystem [attribute]

MapReferenceSystem is mandatory. A single instance is required.

MapReferenceSystem defines the map projection and the origin of the coordinate system used for production of the map. Also referred to as Map Datum.

Refer to MapReferenceSystem definition for any enumerations.

MapCoordinateType [attribute]

MapCoordinateType is mandatory. A single instance is required.

MapCoordinateType defines the coordinate system.

Refer to MapCoordinateType definition for any enumerations.

MapAreaBorderType [attribute]

MapAreaBorderType is optional. A single instance might exist.

Specifies if the coordinates belong to an outer border or an inner border for the map point displayed as an area point. An area specified by an inner border is excluded from the area specified by the outer border.

Refer to MapAreaBorderType definition for any enumerations.

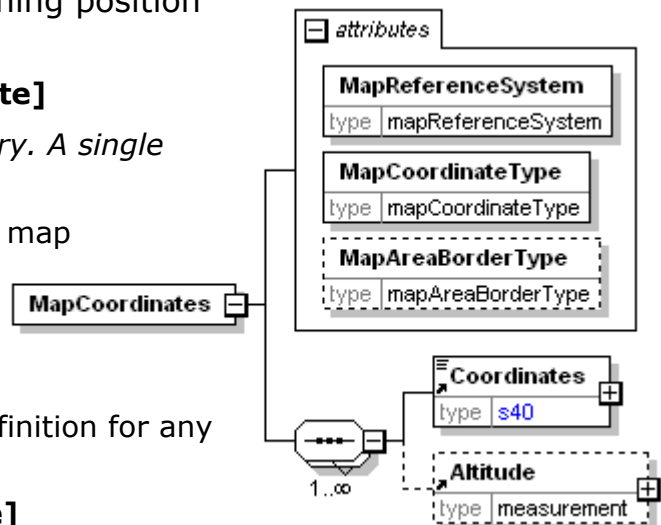

(sequence)

The sequence of items below is mandatory. Multiple instances might exist.

Coordinates

Coordinates is mandatory. A single instance is required.

Contains the position coordinates of a location.

Altitude

Altitude is optional. A single instance might exist.

The height of a location above a ground reference point as specified by the map reference system.

MapCoordinateType [attribute]

MapCoordinateType defines the coordinate system.

This item is restricted to the following list.



ETRS-TM35FIN

ETRS-TM35FIN is a coordinate system used in Finland with rectangular grid coordinates northing = X and easting = Y in CoordinateFormatType = XY.

KKJ1

KKJ zone 1 is a coordinate system used in western part of Finland with rectangular grid coordinates northing = X and easting = Y in CoordinateFormatType = XY.

KKJ2

KKJ zone 2 is a coordinate system used in western part of Finland with rectangular grid coordinates northing = X and easting = Y in CoordinateFormatType = XY.

KKJ3

KKJ zone 3 is a coordinate system used in middle part of Finland with rectangular grid coordinates northing = X and easting = Y in CoordinateFormatType = XY.

KKJ4

KKJ zone 4 is a coordinate system used in eastern part of Finland with rectangular grid coordinates northing = X and easting = Y in CoordinateFormatType = XY.

Lambert93

Lambert 93 is the official map projection of Metropolitan France since December 26, 2000. It is a coordinate system with rectangular grid coordinates easting = X and northing = Y in CoordinateFormatType = XY.

More info at:

https://geodesie.ign.fr/?p=72&page=site_lambert93

<https://geodesie.ign.fr/contenu/fichiers/documentation/rgf93/Lambert-93.pdf>

Lambert1

Lambert Zone 1 is a coordinate system used for the northern part of France with rectangular grid coordinates easting = X and northing = Y in CoordinateFormatType = XY.

More info at:

http://education.ign.fr/sites/all/files/geodesie_projections.pdf

<https://geodesie.ign.fr/contenu/fichiers/documentation/pedagogiques/TransformationsCoordonneesGeodesiques.pdf>

Lambert2

Lambert Zone 2 is a coordinate system used for the centre part of France with rectangular grid coordinates easting = X and northing = Y in CoordinateFormatType = XY.

More info at:

http://education.ign.fr/sites/all/files/geodesie_projections.pdf

<https://geodesie.ign.fr/contenu/fichiers/documentation/pedagogiques/TransformationsCoordonneesGeodesiques.pdf>

Lambert3

Lambert Zone 3 is a coordinate system used for the southern part of France with rectangular grid coordinates easting = X and northing = Y in CoordinateFormatType = XY.

More info at:

http://education.ign.fr/sites/all/files/geodesie_projections.pdf

<https://geodesie.ign.fr/contenu/fichiers/documentation/pedagogiques/TransformationsCoordonneesGeodesiques.pdf>

Lambert4

Lambert Zone 4 is a coordinate system used for Corsica with rectangular grid coordinates easting = X and northing = Y in CoordinateFormatType = XY.

More info at:

http://education.ign.fr/sites/all/files/geodesie_projections.pdf

<https://geodesie.ign.fr/contenu/fichiers/documentation/pedagogiques/TransformationsCoordonneesGeodesiques.pdf>

Lambert2Etendu

Lambert 2 Etendu is a coordinate system used for all of France. It is an extension of Lambert Zone 2 for metropolitan France with rectangular grid coordinates easting = X and northing = Y in CoordinateFormatType = XY.

More info at:

http://education.ign.fr/sites/all/files/geodesie_projections.pdf

<https://geodesie.ign.fr/contenu/fichiers/documentation/pedagogiques/TransformationsCoordonneesGeodesiques.pdf>

LatLong

Coordinates specified as Latitude and Longitude.

RT90_2.5GonV

RT90 2.5 gon V 0:-15 is a coordinate system used in Sweden with rectangular grid coordinates northing = X and easting = Y in CoordinateFormatType = XY.

papiNet V2R31

More info at <http://www.lantmateriet.se>

SWEREF99TM

SWEREF 99 TM is a coordinate system used in Sweden with rectangular grid coordinates northing = X and easting = Y in CoordinateFormatType = XY.

More info at <http://www.lantmateriet.se>

UTM

The Universal Transverse Mercator (UTM) coordinate system is a grid based method of specifying locations on the surface of the Earth. The system employs a series of sixty zones, each of which is based on a specifically defined secant Transverse Mercator projection.

Grid zone = Zone, easting = X and northing = Y in CoordinateFormatType = ZoneXY.

MapPoint

A grouping element for items describing an object on a map. A map point having a single coordinate is normally named waypoint in a GPS.

MapPointType [attribute]

MapPointType is optional. A single instance might exist.

Type of object specified by a map point.

Refer to MapPointType definition for any enumerations.

MapPointDisplayType [attribute]

MapPointDisplayType is optional. A single instance might exist.

Defines how map points are processed and displayed on maps by map applications.

Refer to MapPointDisplayType definition for any enumerations.

(sequence)

The sequence of items below is mandatory. A single instance is required.

MapPointName

MapPointName is mandatory. A single instance is required.

A unique name for a point on a map. It is also normally the name of the corresponding waypoint in a GPS.

MapPointID

MapPointID is optional. Multiple instances might exist.

Identification of the map point. An identifier used to identify a MapPoint defined by an agency.

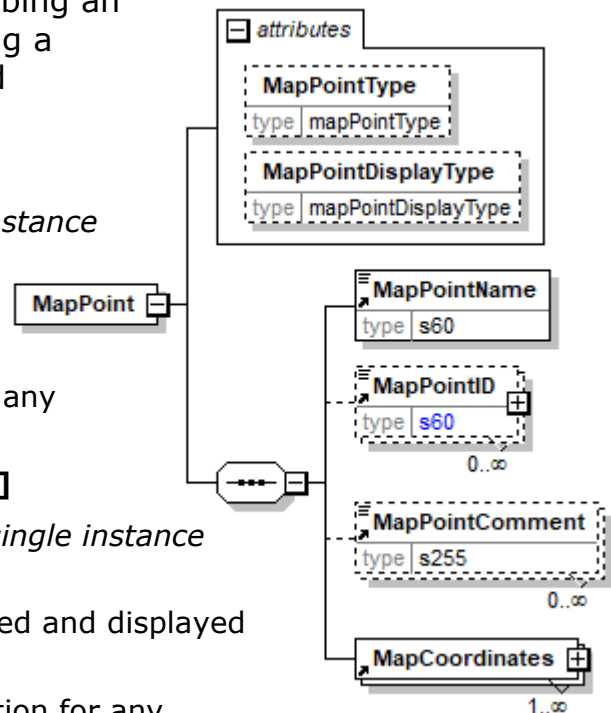

MapPointComment

MapPointComment is optional. Multiple instances might exist.

A descriptive text for a point on a map. It is also normally shown in a GPS as a comment for the corresponding waypoint.

MapCoordinates

MapCoordinates is mandatory. One instance is required, multiple instances might exist.

A group item defining and containing position coordinates of a location.

MapPointComment

A descriptive text for a point on a map. It is also normally shown in a GPS as a comment for the corresponding waypoint.

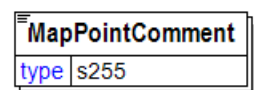

MapPointDisplayType [attribute]

Defines how map points are processed and displayed on maps by map applications.



This item is restricted to the following list.

AreaPoint

A map point that is displayed as a border line of a polygon area on maps. A number of coordinates are given for this type of map point. The last coordinate has to be the same as the first coordinate. Map applications draw a line between these coordinates when displaying it on maps.

Attribute MapAreaBorderType for element MapCoordinates specifies if the coordinates belong to an outer border or an inner border. An area specified by an inner border is excluded from the area specified by the outer border.

LinePoint

A map point that is displayed as a line on maps. A number of coordinates are given for this type of map point. Map applications draw a line between these coordinates when displaying it on maps. A LinePoint can be represented as a Track object in a GPS or in the gpx-standard.

UserWaypoint

A map point that is displayed as a normal waypoint visible for the user.

MapPointID

Identification of the map point. An identifier used to identify a MapPoint defined by an agency.

Agency [attribute]

Agency is mandatory. A single instance is required.

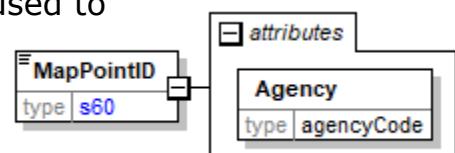

papiNet V2R31

Describes the agency maintaining the list of codes. To be included in this list the agency must be a recognized standards body or industry organisation.

- For the element that owns this attribute.
- For another attribute in the list of attributes associated with the parent element.

Refer to Agency definition for any enumerations.

MapPointName

A unique name for a point on a map. It is also normally the name of the corresponding waypoint in a GPS.

MapPointName
type s60

MapPointType [attribute]

Type of object specified by a map point.

This item is restricted to the following list.

attribute
MapPointType
type mapPointType

ApproachingWay

A map point showing the way how to approach the destination, e.g. a supply point. The advised way starts from the first given map point continuing to the next ones. Extra information about the way can be given in MapPointComment.

Barrier

An object serving to obstruct passage or to maintain separation, e.g. a gate.

BearingCapacityRestriction

A map point showing where bearing capacity restriction exists on the road.

Bridge

A bridge, e.g. for crossing over a river. A bridge might be restricted by width and bearing capacity.

CraneTemporaryStorage

A place where a crane used for loading and unloading can temporarily be put.

DrivingProhibited

A map point specifying that driving is prohibited on this leg of the road.

Ferry

A ferry crossing with restrictions along a road. Typically restricted by width and bearing capacity.

Footpath

A map point showing a footpath.

ForestRoad

Usually a light constructed road used mainly for forestry operations and wood transportations.

HazardPlace

A map point which needs to be noticed in order to drive or work safely, e.g. a point on a road or at a roadside landing.

LoggingArea

A map point showing a logging area.

MainIntersection

Connection point between a main road and minor roads.

Passage

A section or crossing with restrictions along a road. Typically restricted by width.

PassingPossibility

Place where vehicles can turn around.

PointOfNatureValues

A map point of special nature values which have to be taken into account in the operations.

PointOfRemark

A map point with special information which has to be taken into account in the operations.

PowerLine

A power line which can cause a danger to drivers and has to be taken into account in the operations.

RescuePlace

A map point showing a rescue place, e.g. defined for a work place.

RoadNetworkConnection

A connection point to the road network for a location.

RoadWorks

Repairs to a road forming a hazard or obstruction to traffic.

RouteEnd

End point of a route.

RouteLegEnd

End point of a route leg.

RouteLegStart

Start point of a route leg.

RouteStart

Start point of a route.

Slope

A section of a road with a gradient forming obstruction to traffic.

SupplyPoint

A map point showing a supply point, e.g. a roadside landing.

TelephoneCable

A telephone or a data communication cable which has to be taken into account in the operations.

TemporaryRoad

Usually a light constructed and temporary road used for wood transportations and loggings, e.g. a winter road.

TrafficRestriction

A map point with special restriction to the traffic. Detailed information of the restriction can be given in MapPointComment.

TrafficWarning

A map point with special warning or notice concerning the traffic on the road. Detailed information of the warning can be given in MapPointComment.

TurningPossibility

A place where vehicles can turn around.

UnderPass

A section of a road that passes under another road, railway line, etc. Typically restricted by height and width.

WeighBridge

Place for weighing of vehicles.

WorkCabinPlace

A map point showing the place for a work cabin, e.g. a temporary place in the forest for a cabin used by forest workers.

MapReferenceSystem [attribute]

MapReferenceSystem defines the map projection and the origin of the coordinate system used for production of the map. Also referred to as Map Datum.

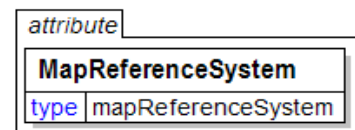

This item is restricted to the following list.

ETRS89

The European Terrestrial Reference System 1989 is a three-dimensional geodetic frame of reference - a mapping coordinate system used as the standard high accuracy system for GPS in Europe. ETRS89 is the EU-recommended frame of reference for geodata for Europe.

More info at <http://lareg.ensg.ign.fr/EUREF>

EUREF-FIN

A map reference system used in Finland

KKJ

A map reference system used in Finland. This older system will be replaced by

ETRS89 (EUREF-FIN) on new maps.

NTF

NTF is a Map reference System used in France. Although the official MapReference System in France is RGF93, NTF is still the most used reference system in year 2007.

Code EPSG used by Open Geospatial Consortium: 4807 More info at:

<http://www.ign.fr/telechargement/education/fiches/geodesie/syst%C3%A8mes.pdf>

http://www.ign.fr/telechargement/education/fiches/geodesie/systemes_EN.pdf

http://www.ign.fr/telechargement/education/fiches/geodesie/coordonnees_EN.pdf

RGF93

RGF93 is the official geodetic frame of reference for France (<http://www.ign.fr/telechargement/P.I/Objectifs/Statuts/texte-26.12.2000.pdf>). It is a subset of ETRS89.

Code EPSG used by Open Geospatial Consortium for RGF93: 4965 (3D), 4171 (2D).

We can consider that the latitude and the longitude defined with the MapReferenceSystem RGF93 are equivalent to the latitude and the longitude defined with WGS84 (1 to 2 centimetres of gap).

RT90

A map reference system used in Sweden.

More info at <http://www.lantmateriet.se>

SWEREF99

A map reference system used in Sweden. The older reference system RT90 will be replaced by SWEREF99 on new maps.

More info at <http://www.lantmateriet.se>

WGS84

The World Geodetic System defines a global reference system for the earth. WGS84 is the revision from year 1984. It is the reference system used by the Global Positioning System (GPS). WGS 84 is the most common reference system used for web based maps, e.g. Googlemaps and Google Earth.

Margins

Margins.

(sequence)

The sequence of items below is mandatory. A single instance is required.

Head

Head is optional. A single instance might exist.

Head.

Thumb

Thumb is optional. A single instance might exist.

Thumb.

Gutter

Gutter is optional. A single instance might exist.

Gutter

Foot

Foot is optional. A single instance might exist.

Foot

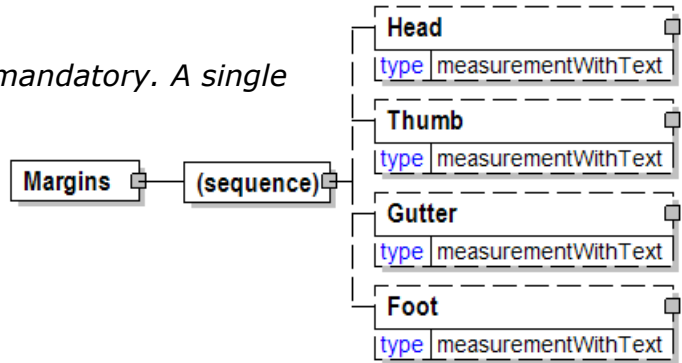

MasterDataBusinessParty

Master data for an organisation or a business entity. Many business roles can be specified for the business party.

N.B. Enumerations of attribute Agency for the PartyIdentifier that also exist as

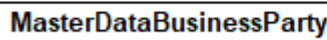

enumerations of PartyType for business parties are not allowed to be used, e.g. Buyer, Seller, Supplier etc.

N.B. Enumeration Other of attribute Agency for the PartyIdentifier is not allowed to be used.

N.B. The following enumerations of attribute PartyIdentifierType for the PartyIdentifier are not allowed to be used: AssignedByBuyer, AssignedByReceiver, AssignedBySeller, AssignedBySender and Other.

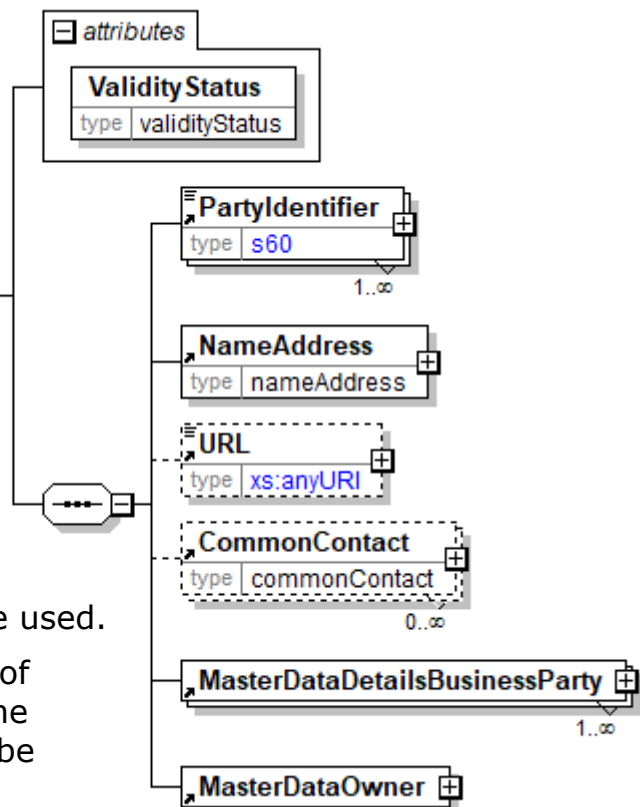

ValidityStatus [attribute]

ValidityStatus is mandatory. A single instance is required.

The validity status for a specific item.

Refer to ValidityStatus definition for any enumerations.

(sequence)

The sequence of items below is mandatory. A single instance is required.

PartyIdentifier

PartyIdentifier is mandatory. One instance is required, multiple instances might exist.

A unique identifier of a specific party. This element contains an attribute PartyIdentifierType that indicates the type of the identifier.

NameAddress

NameAddress is mandatory. A single instance is required.

A group item containing name and address of an organisation or business entity.

URL

URL is optional. A single instance might exist.

Universal Resource Locator. While typically a web address you could use this field to hold an email address.

CommonContact

CommonContact is optional. Multiple instances might exist.

Identifies a specific individual associated with the party.

MasterDataDetailsBusinessParty

MasterDataDetailsBusinessParty is mandatory. One instance is required, multiple instances might exist.

A grouping element that contains detail information for master data for an organisation or a business entity.

MasterDataOwner

MasterDataOwner is mandatory. A single instance is required.

The party that is the owner of master data.

MasterDataDetailsBusinessParty

A grouping element that contains detail information for master data for an organisation or a business entity.

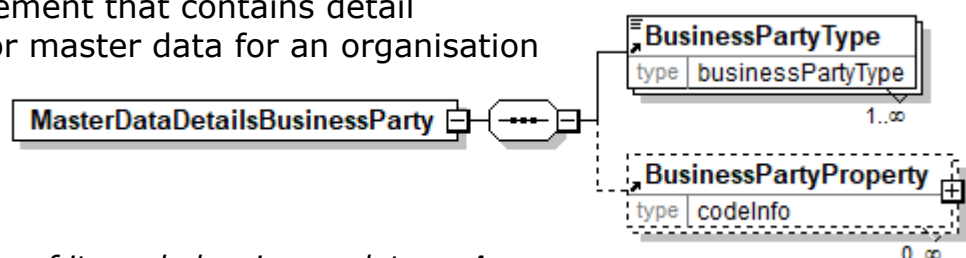

(sequence)

The sequence of items below is mandatory. A single instance is required.

BusinessPartyType

BusinessPartyType is mandatory. One instance is required, multiple instances might exist.

Identifies a business role associated with a business party.

Refer to BusinessPartyType definition for any enumerations.

BusinessPartyProperty

BusinessPartyProperty is optional. Multiple instances might exist.

A grouping element that contains a specification of a property for a business party.

MasterDataDetailsLocation

A grouping element that contains detail information for master data for a location where business events take place.

(sequence)

The sequence of items below is mandatory. A single instance is required.

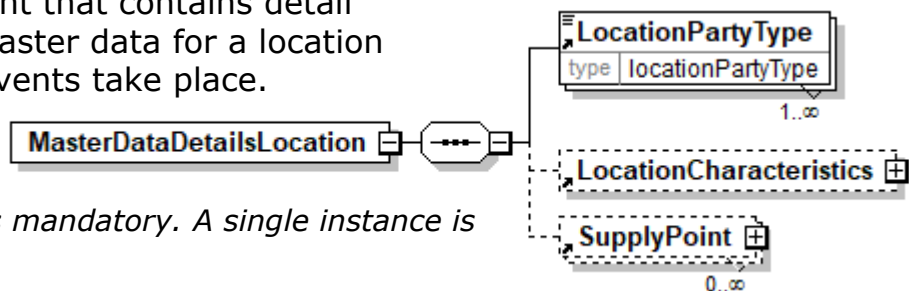

LocationPartyType

LocationPartyType is mandatory. One instance is required, multiple instances might exist.

Identifies a business role associated with a location where business events take place.

Refer to LocationPartyType definition for any enumerations.

LocationCharacteristics

LocationCharacteristics is optional. A single instance might exist.

A grouping element that contains information related to a geographical location.

SupplyPoint

SupplyPoint is optional. Multiple instances might exist.

Grouping element that contains items describing a supply point. A SupplyPoint belongs to a LocationParty, e.g. in a DeliveryOrigin or DeliveryDestination, and describes where goods are stored and can be loaded or unloaded. A SupplyPoint can for example be a loading or unloading gate at a warehouse or a road side landing at a logging area in the forest.

MasterDataDetailsProduct

A grouping element that contains detail information for master data for a product.

(sequence)

The sequence of items below is mandatory.

A single instance is required.

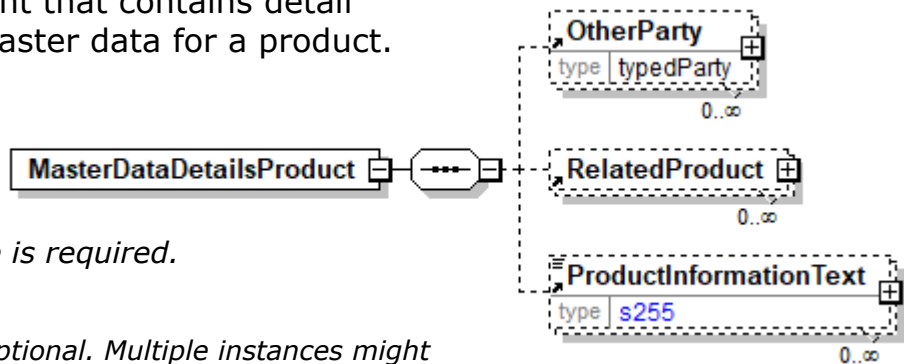

OtherParty

OtherParty is optional. Multiple instances might exist.

An organisation or business entity other than those specifically detailed within an e-Document.

RelatedProduct

RelatedProduct is optional. Multiple instances might exist.

Specifies a related product to a product in a product hierarchy.

ProductInformationText

ProductInformationText is optional. Multiple instances might exist.

An element used to communicate human readable information about the Product in the language specified by the Language attribute.

MasterDataLocation

Master data for a location where business events take place. Many business roles can be specified for the location.

N.B. Enumerations of attribute Agency for the PartyIdentifier that also exist as enumerations of PartyType for business parties are not allowed to be used, e.g. Buyer, Seller, Supplier etc.

N.B. Enumeration Other of attribute Agency for the PartyIdentifier is not allowed to be used.

N.B. The following enumerations of attribute PartyIdentifierType for the PartyIdentifier are not allowed to be used: AssignedByBuyer, AssignedByReceiver, AssignedBySeller, AssignedBySender and Other.

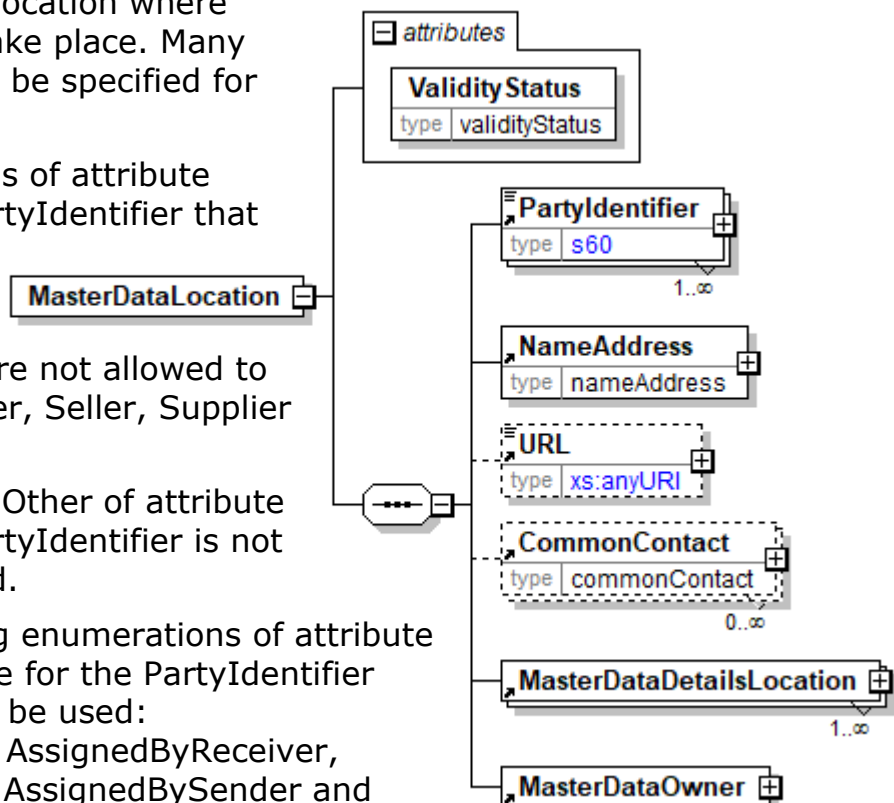

ValidityStatus [attribute]

ValidityStatus is mandatory. A single instance is required.

The validity status for a specific item.

Refer to ValidityStatus definition for any enumerations.

(sequence)

The sequence of items below is mandatory. A single instance is required.

PartyIdentifier

PartyIdentifier is mandatory. One instance is required, multiple instances might exist.

A unique identifier of a specific party. This element contains an attribute PartyIdentifierType that indicates the type of the identifier.

NameAddress

NameAddress is mandatory. A single instance is required.

A group item containing name and address of an organisation or business entity.

URL

URL is optional. A single instance might exist.

Universal Resource Locator. While typically a web address you could use this field to hold an email address.

CommonContact

CommonContact is optional. Multiple instances might exist.

Identifies a specific individual associated with the party.

MasterDataDetailsLocation

MasterDataDetailsLocation is mandatory. One instance is required, multiple instances might exist.

A grouping element that contains detail information for master data for a location where business events take place.

MasterDataOwner

MasterDataOwner is mandatory. A single instance is required.

The party that is the owner of master data.

MasterDataOwner

The party that is the owner of master data.

(sequence)

The sequence of items below is mandatory. A single instance is required.

GlobalPartyID

GlobalPartyID is mandatory. A single instance is required.

A globally unique identifier for a party.

NameAddress

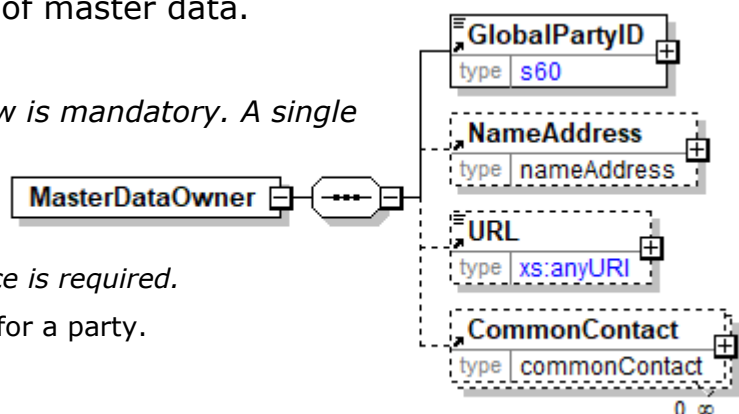

NameAddress is optional. A single instance might exist.

A group item containing name and address of an organisation or business entity.

URL

URL is optional. A single instance might exist.

Universal Resource Locator. While typically a web address you could use this field to hold an email address.

CommonContact

CommonContact is optional. Multiple instances might exist.

Identifies a specific individual associated with the party.

MasterDataProduct

Master data for a product. Master data for a product hierarchy can be built when related products to the product are supplied.

N.B. Enumerations of attribute Agency that are the same as enumerations of PartyType for business parties are not allowed to be used, e.g. Buyer, Seller, Supplier etc.

N.B. Enumeration Other of attribute Agency is not allowed to be used.

N.B. The following enumerations of attribute PartyIdentifierType are not allowed to be used: AssignedByBuyer, AssignedByReceiver, AssignedBySeller, AssignedBySender and Other.

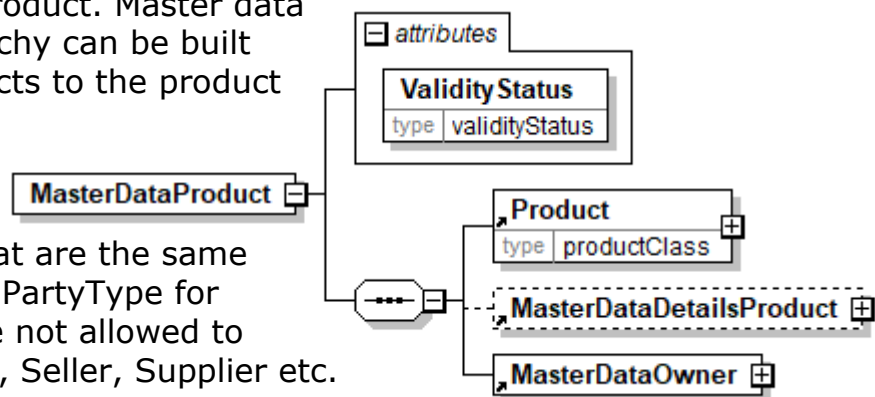

ValidityStatus [attribute]

ValidityStatus is mandatory. A single instance is required.

The validity status for a specific item.

Refer to ValidityStatus definition for any enumerations.

(sequence)

The sequence of items below is mandatory. A single instance is required.

Product

Product is mandatory. A single instance is required.

Product is a group item defining the article and its characteristics. Product is used to specify product characteristics organized by ProductIdentifier, ProductDescription, and Classification. Book Manufacturing, Label Stock, Paper, Pulp, Recovered Paper, Wood Products, and Virgin Fibre market segments have defined their product characteristics and conversion features for implementation in papiNet.

MasterDataDetailsProduct

MasterDataDetailsProduct is optional. A single instance might exist.

papiNet V2R31

A grouping element that contains detail information for master data for a product.

MasterDataOwner

MasterDataOwner is mandatory. A single instance is required.

The party that is the owner of master data.

MasterReelWidth

The master reel width.

(sequence)

The sequence of items below is mandatory. A single instance is required.

Value

Value is mandatory. A single instance is required.

A numeric value expressed in the unit of measure (UOM).

RangeMin

RangeMin is optional. A single instance might exist.

The minimum value (lower boundary) allowed for the Measurement that is the parent of this element.

RangeMax

RangeMax is optional. A single instance might exist.

The maximum value (upper boundary) allowed for the Measurement that is the parent of this element. Some elements use the RangeMax element with an extended list of unit of measures. (Note: the red colour in the picture is an artifact of how the graphic was captured and should be disregarded.)

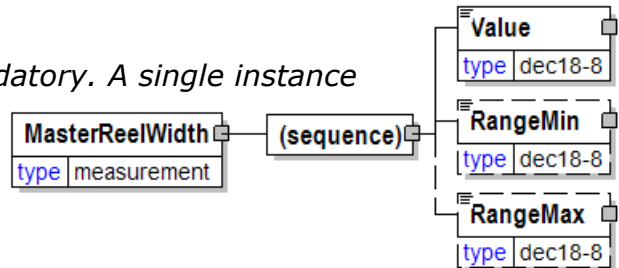

MasterSource [attribute]

The source of the master

This item is restricted to the following list.

1610/1630

1/4Inch2TrackR2RTape

CDR

The source is Compact Disc Recordable.

DAT

The source is Digital Audio Tape.

DATWithLog

Diskette

DVD

The source is Digital Video Disk.

Electronic

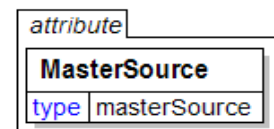

papiNet V2R31

Exabyte

A company (and, by extension, a tape format) for computer data backup and transfer onto data quality 8-mm VCR tape. Exabyte units can store 5 Gbytes of data per tape.

Jazz

The Jazz drive is a removable storage solution developed by Iomega Corp. The Jaz drive has a 12-ms average seek time and the removable cartridges hold up to 2 GB of data.

MagneticOptical

Syquest

A removable hard disk drive that is connected to the computer via a SCSI interface.

Zip

A high-capacity floppy disk drive.

Other

MasterStorageOption

Master storage option

MasterStorageOption	
type	s72

MaterialCharacteristics

Material characteristics.

FinishType [attribute]

FinishType is optional. A single instance might exist.

Defines the finish of a sheet of paper, which means the condition of its surface (refer to Embossing for more information).

Finishes may be produced on or off machine. Finishes that are created off-machine are called embossed. (Embossing is a child element of ReelConversionCharacteristics and

SheetConversionCharacteristics.)

Note:

Embossed" as a finish type is just a generalized choice for one of the more specific choices listed.

Unsupercalendered" as a finish type would be indicated by not communicating a finish type.

Refer to FinishType definition for any enumerations.

(sequence)

The sequence of items below is mandatory. A single instance is required.

(sequence)

The sequence of items below is mandatory. One instance is required, multiple instances might exist.

ProductIdentifier

ProductIdentifier is mandatory. A single instance is required.

Used to communicate the code of the article, in a variety of formats designated by the type.

ProductDescription

ProductDescription is optional. Multiple instances might exist.

An element used to communicate a human readable description of the product in the language specified by the Language attribute.

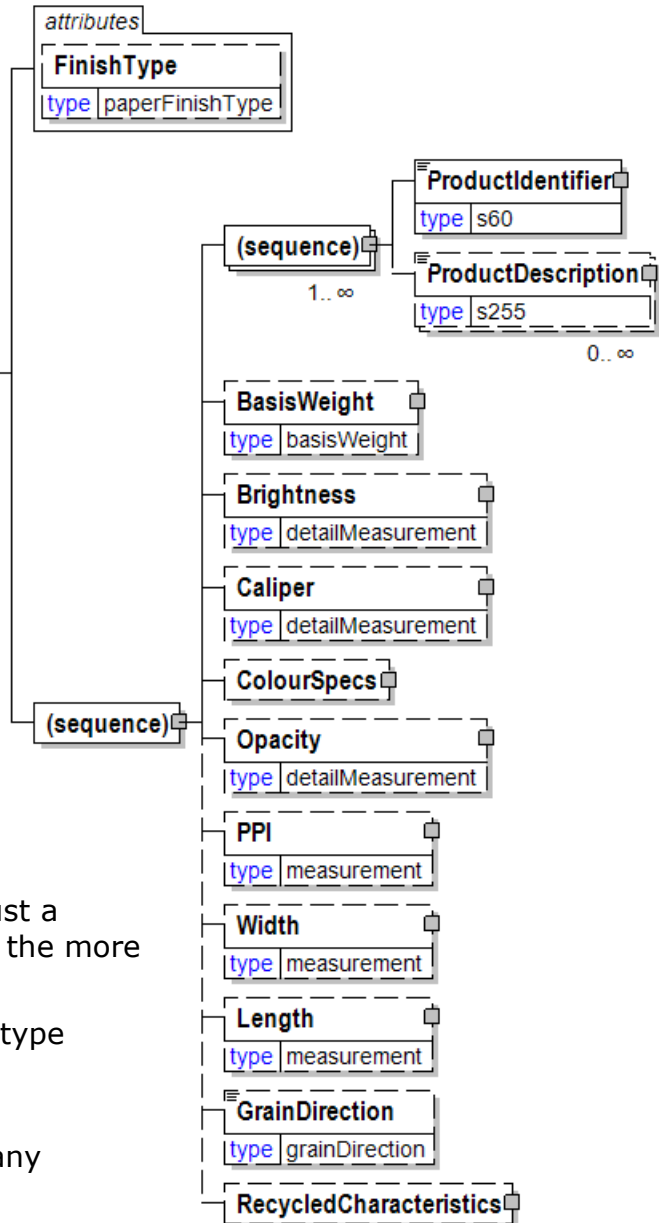

BasisWeight

BasisWeight is optional. A single instance might exist.

The weight of the paper expressed as a mass for a given surface area. In countries using the metric system, the basis weight is expressed as the weight in grams of one sheet of paper that is one square meter in area—not dependent on basic sheet size. In countries using the imperial system, the weight is expressed in pounds for a given ProductBasisSizeType.

Brightness

Brightness is optional. A single instance might exist.

A measurement of the degree of light reflectivity of the product.

Caliper

Caliper is optional. A single instance might exist.

The thickness of a sheet of paper under standard test conditions.

ColourSpecs

ColourSpecs is optional. A single instance might exist.

Colour specs

Opacity

Opacity is optional. A single instance might exist.

A group item used to communicate opacity target or test value according to a particular TestMethod.

PPI

PPI is optional. A single instance might exist.

A group item used to communicate the number of pages in an inch of thickness either as a target or actual value. Equal to the number of sheets per inch times 2.

Width

Width is optional. A single instance might exist.

The width of the object.

Length

Length is optional. A single instance might exist.

The length of the object.

GrainDirection

GrainDirection is optional. A single instance might exist.

Defines the primary orientation/alignment (Long or Short) of the cellulose fibres in a sheet or web of paper, which results from the flow of fibres in a water suspension during the papermaking process.

Refer to GrainDirection definition for any enumerations.

RecycledCharacteristics

RecycledCharacteristics is optional. A single instance might exist.

RecycledCharacteristics groups together the concepts associated with recycled material.

MaxCurrencyValue

The upper range of the allowed currency amount.

CurrencyType [attribute]

CurrencyType is optional. A single instance might exist.

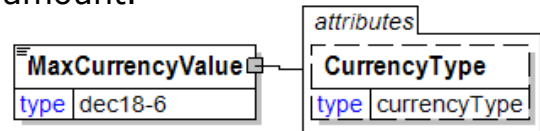

A three-character ISO 4217 currency code in capital letters. The ISO standard classification for currencies. Refer to the ISO standard for information about the choices for the attribute's enumerations.

<https://www.iso.org/iso-4217-currency-codes.html>

MaximumClampingForce

Specifies maximum clamp force allowed during handling of an item.

(sequence)

The sequence of items below is mandatory. A single instance is required.

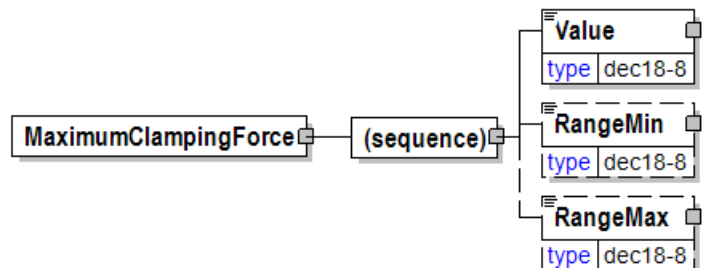

Value

Value is mandatory. A single instance is required.

A numeric value expressed in the unit of measure (UOM).

RangeMin

RangeMin is optional. A single instance might exist.

The minimum value (lower boundary) allowed for the Measurement that is the parent of this element.

RangeMax

RangeMax is optional. A single instance might exist.

The maximum value (upper boundary) allowed for the Measurement that is the parent of this element. Some elements use the RangeMax element with an extended list of unit of measures. (Note: the red colour in the picture is an artifact of how the graphic was captured and should be disregarded.)

MaximumGrossWeight

The maximum weight allowed including the pallet.

(sequence)

The sequence of items below is mandatory. A single instance is required.

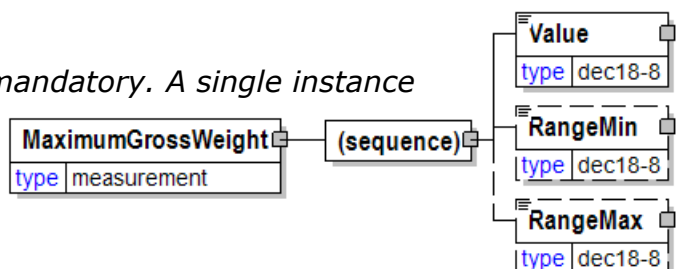

Value

Value is mandatory. A single instance is required.

A numeric value expressed in the unit of measure (UOM).

RangeMin

papiNet V2R31

RangeMin is optional. A single instance might exist.

The minimum value (lower boundary) allowed for the Measurement that is the parent of this element.

RangeMax

RangeMax is optional. A single instance might exist.

The maximum value (upper boundary) allowed for the Measurement that is the parent of this element. Some elements use the RangeMax element with an extended list of unit of measures. (Note: the red colour in the picture is an artifact of how the graphic was captured and should be disregarded.)

MaximumHeight

The maximum height allowed including the pallet.

(sequence)

The sequence of items below is mandatory. A single instance is required.

Value

Value is mandatory. A single instance is required.

A numeric value expressed in the unit of measure (UOM).

RangeMin

RangeMin is optional. A single instance might exist.

The minimum value (lower boundary) allowed for the Measurement that is the parent of this element.

RangeMax

RangeMax is optional. A single instance might exist.

The maximum value (upper boundary) allowed for the Measurement that is the parent of this element. Some elements use the RangeMax element with an extended list of unit of measures. (Note: the red colour in the picture is an artifact of how the graphic was captured and should be disregarded.)

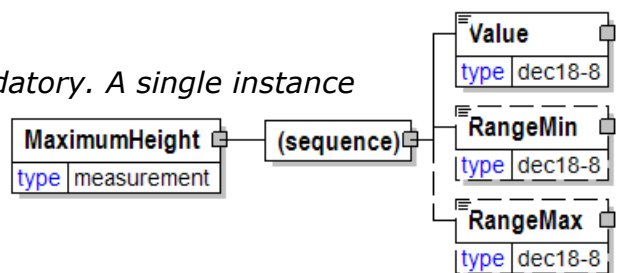

MaximumNumberOfJoins

The maximum number of joins requested (permitted). Permits customers to indicate join-free reels.

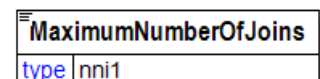

MaximumOffcut

Maximum off cut.

(sequence)

The sequence of items below is mandatory. A single instance is required.

Value

Value is mandatory. A single instance is required.

A numeric value expressed in the unit of measure (UOM).

RangeMin

RangeMin is optional. A single instance might exist.

The minimum value (lower boundary) allowed for the Measurement that is the parent of this element.

RangeMax

RangeMax is optional. A single instance might exist.

The maximum value (upper boundary) allowed for the Measurement that is the parent of this element. Some elements use the RangeMax element with an extended list of unit of measures. (Note: the red colour in the picture is an artifact of how the graphic was captured and should be disregarded.)

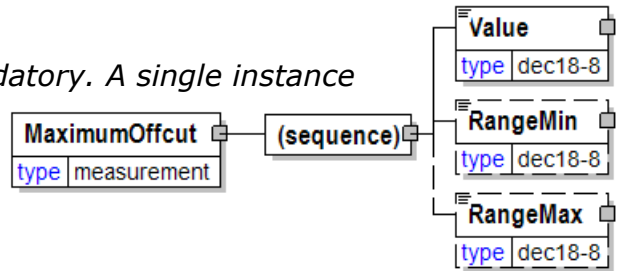

MaximumOrderQuantity

The maximum amount that can be ordered at one time.

(sequence)

The sequence of items below is mandatory. A single instance is required.

Quantity

Quantity is mandatory. A single instance is required.

The Quantity element contains attributes that provide information about the type of quantity that is being communicated, the context in which the particular quantity is to be viewed, and (if the quantity represents an adjustment) an adjustment type.

The Quantity element contains three child elements that enable you to communicate a range of values for the quantity and a target or actual value. It is at this level (Value, RangeMin, and RangeMax) that the unit of measure is specified. This permits the range to be specified in a different unit of measure than the target.

InformationalQuantity

InformationalQuantity is optional. Multiple instances might exist.

A quantity given in a valid UOM used for information purposes only (not for calculation). For example, an ordered quantity was 100 reels as opposed to the invoice quantity of 20,000 pounds.

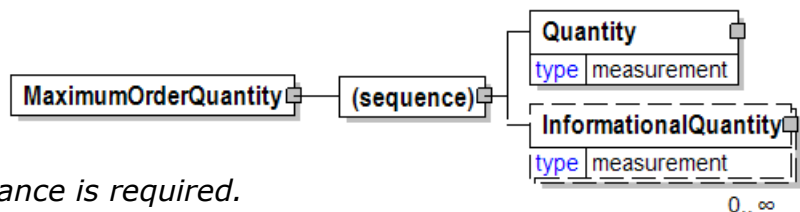

MeasurementModule

A text element specifying the module model used for measuring.

BrandName [attribute]

Brandname is optional. A single instance might exist.

Specifies the trade name for the associated item.

ModelYear [attribute]

ModelYear is optional. A single instance might exist.

Specifies the year assigned to the model of an item.

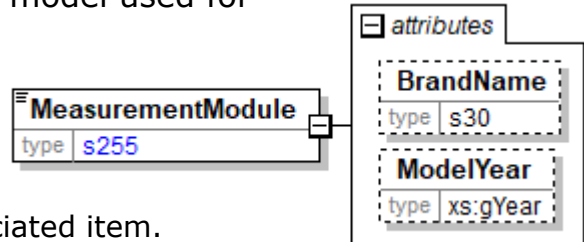

MeasurementsAre [attribute]

Used to define for a product whether the details provided are ranges and lists of properties, or whether they are discrete, single properties of the product.

This item is restricted to the following list.

Discreet

For a product, elements with measurements are observed or target values, and elements that allow a list of attributes for the product to be specified must have zero or one occurrence.

Range

For a product, elements with measurements specify a range, and elements that allow a list of attributes for the product to be specified may have zero or more occurrences.

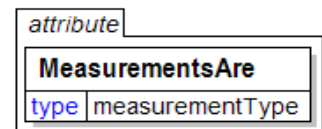

MeasurementSpecification

A grouping element that contains a specification of properties and quantities that should be measured or are measured.

(sequence)

The sequence of items below is mandatory. A single instance is required.

PropertySpecification

PropertySpecification is optional. Multiple instances might exist.

A grouping element that contains a specification of properties that should be measured or are measured.

QuantitySpecification

QuantitySpecification is optional. Multiple instances might exist.

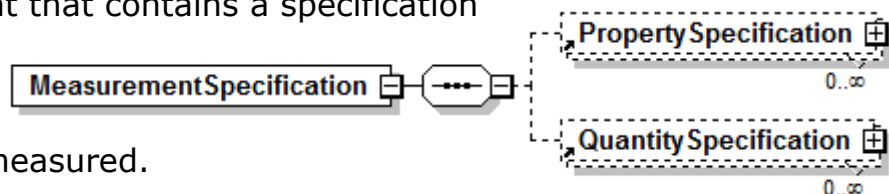

papiNet V2R31

A grouping element that contains a specification of quantities that should be measured or are measured.

MeasurementSystem

A text element describing the system used for measuring.

MeasurementSystem	
type	s255

MeasuringAgency [attribute]

The agency defining measuring methods. When reporting a property value, then the MeasuringAgency defines TextValue for the property.

attribute
MeasuringAgency
type agencyCode.Measuring

This item is restricted to the following list.

ASTM

ASTM International, known until 2001 as the American Society for Testing and Materials (ASTM), is an international standards organization that develops and publishes voluntary consensus technical standards for a wide range of materials, products, systems, and services. For example Winter Class diesel has to fulfil ASTM standards. (<http://www.astm.org>).

BS

British Standards.

To be deprecated in a future version V3R00, use instead BSI.

BSI

British Standards Institute (refer to bsi-global.com for more information).

Buyer

The buyer has defined the codes used in the particular element of the transaction. Care must be used when using this agency to assure that the recipient of the e-Document understands what is being communicated.

CEN

European Committee for Standardisation (<http://www.cen.eu>).

CIE

Vienna-based Commission Internationale de l'Eclairage.

DuPont

DuPont.

EN

European standards organisation.

To be deprecated in a future version V3R00, use instead CEN.

ForestForwarder

The party that transports forest wood products from logging areas to roadside

landings.

ForestHarvester

The party that harvests forest wood products at logging areas.

ForestHub

An agency for Forest Wood Supply & Bioproducts industries.

GE

General Electric.

ImageXpert

ImageXpert.

ISO

International Organisation for Standardization.

KpDC

Agency maintaining codes for the Latvia wood supply segment (www.KpDC.lv).

NS-EN

Norwegian Standards, European Standards.

To be deprecated in a future version V3R00, use instead SN.

PAPTAC

Pulp and Paper Technical Association of Canada.

PWO

Agency for Pulpwood Online.

RVR

Agency maintaining codes for the German wood supply segment.

RVR is the abbreviation for "Rahmenvereinbarung für den Rohholzhandel in Deutschland".

(www.rvr-deutschland.de).

SCAN-test

SD

Agency maintaining codes for the Norwegian wood supply segment (www.skogdata.no).

SDC

Agency maintaining codes for the Swedish wood supply segment (www.biometria.se).

SFS

Finnish Standards Association.

SFS-EN

To be deprecated in a future version V3R00, use instead SFS.

Refer to www.sfs.fi/en for more information.

SIS

Swedish Standards Institute.

Refer to www.sis.se/en for more information.

SN

Standards Norway

Refer to www.standard.no/en for more information.

SS-EN

To be deprecated in a future version V3R00, use instead SIS.

Supplier

The supplier has defined the codes used in the particular element of the transaction. Care must be used when using this agency to assure that the recipient of the e-Document understands what is being communicated.

TAPPI

Technical Association for the Pulp and Paper Industry.

MeasuringCode

A code defining the measuring procedure.

MeasuringCode will be deprecated in a future version V3R00 and should not be used in new implementations. Use instead the MeasuringCodeInfo construct.

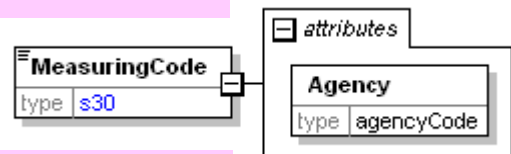

Agency [attribute]

Agency is mandatory. A single instance is required.

Describes the agency maintaining the list of codes. To be included in this list the agency must be a recognized standards body or industry organisation.

- For the element that owns this attribute.
- For another attribute in the list of attributes associated with the parent element.

Refer to Agency definition for any enumerations.

MeasuringCodeInfo

A grouping element that contains information about measuring codes defining the measuring procedure.

Agency [attribute]

Agency is mandatory. A single instance is required.

Describes the agency maintaining the list of codes. To be included in this list the agency must be a recognized standards body or industry organisation.

- For the element that owns this attribute.
- For another attribute in the list of attributes associated with the parent element.

Refer to Agency definition for any enumerations.

MeasuringCodeType [attribute]

MeasuringCodeType is mandatory. A single instance is required.

Specifies the type of the measuring code.

Refer to MeasuringCodeType definition for any enumerations

(sequence)

The sequence of items below is mandatory. A single instance is required.

Code

Code is mandatory. A single instance is required.

Specifies a code that is defined by an agency. The agency is given for the whole construct containing the code.

CodeValue

CodeValue is optional. A single instance might exist.

A grouping element specifying a value belonging to a code that is defined by an agency.

CodeDescription

CodeDescription is optional. Multiple instances might exist.

A textual description for the meaning of a code that is defined by an agency. When the Code is associated with a CodeValue of type TextValue, then the CodeDescription is a textual description of both the Code and the TextValue.

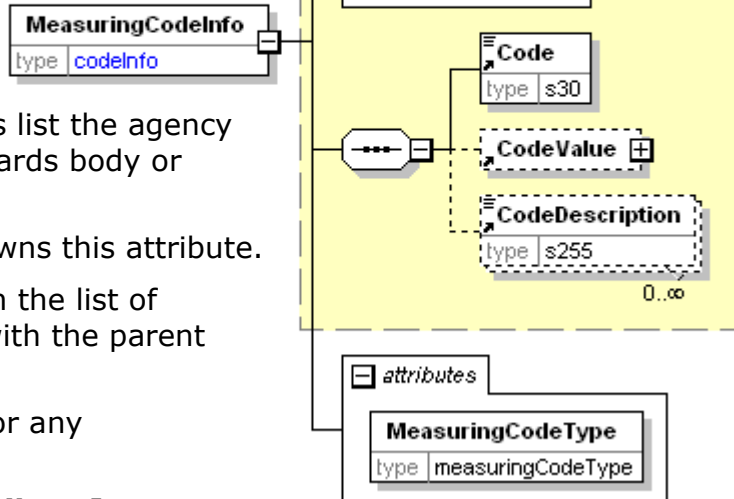

MeasuringCodeType [attribute]

Specifies the type of the measuring code.

This item is restricted to the following list.

MeasuringLocationType

The code specifies the type of location where measuring takes place.

MeasuringMethodService

The code specifies methods and services for the measuring.

MeasuringPurpose

The code specifies the measuring purpose.

MeasuringRegulation

The code specifies a measuring regulation.

MeasuringReportType

The code specifies a type of a measuring report.

MeasuringScope

The code specifies the scope of the measuring.

PopulationScope

The code specifies the scope of the statistical adjustments for a population of clearly-defined items with similar characteristics.

Other

The type of the code is not specified.

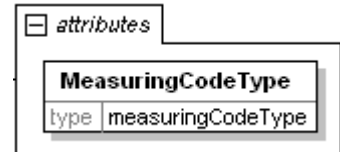

MeasuringComplete [attribute]

Indicates that measuring is completed for a particular item.

This item is restricted to the following list.

ByOrderLineItemNumber

Specifies that measuring is completed for an order line item of an order number.

ByOrderNumber

Specifies that measuring is completed for all order line items of an order number.

NotComplete

Specifies that measuring is not completed.



MeasuringDate

The date when the measuring was done.

(sequence)

The sequence of items below is mandatory. A single instance is required.

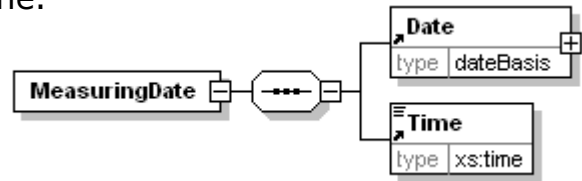

Date

Date is mandatory. A single instance is required.

A group element that contains the specification of Year, Month, and Day.

Time

Time is mandatory. A single instance is required.

Times are treated in a standard XML fashion with a special case used to indicate a generalized "local" time. The standard XML approach to time is hh:mm:ss, hh:mm:ssZ, or hh:mm:ss±hh:mm.

- hh:mm:ss±hh:mm is used to represent a time with a time zone. The time zone is communicated as the number of hours offset from the Universal Time Coordinate (UTC), a.k.a. Greenwich Mean Time.
- hh:mm:ssZ indicates the time at Zulu (another name for UTC).
- hh:mm:ss or hh:mm indicates within papiNet the applicable local time where the associated event is taking place. Caution should be used when processing times of this nature as the papiNet approach may be in discord with other users of XML.

MeasuringDescription

A text element describing the measuring procedure.

MeasuringDescription will be deprecated in a future version V3R00 and should not be used in new implementations. Use instead the MeasuringCodeInfo construct.



MeasuringEquipment

A grouping element that contains information about the equipment used for measuring.

(sequence)

The sequence of items below is mandatory. A single instance is

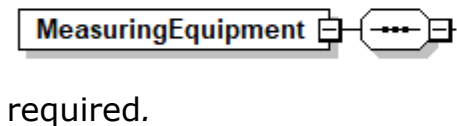

required.

(sequence)

The sequence of items below is optional. Multiple instances might exist.

(sequence)

The sequence of items below is optional. A single instance might exist.

MeasuringEquipmentCode

MeasuringCode is mandatory. One instance is required, multiple instances might exist.

A code used for identifying the measuring equipment.

CodeValue

CodeValue is optional. A single instance might exist.

A grouping element specifying a value belonging to a code that is defined by an agency.

MeasuringEquipmentDescription

MeasuringEquipmentDescription is optional. Multiple instances might exist.

A text field element describing equipment used for measuring. When a MeasuringEquipmentCode is associated with a CodeValue of type TextValue, then the MeasuringEquipmentDescription is a textual description of both the MeasuringEquipmentCode and the TextValue.

MeasurementSystem

MeasurementSystem is optional. A single instance might exist.

A text element describing the system used for measuring.

MeasurementModule

MeasurementModule is optional. A single instance might exist.

A text element specifying the module model used for measuring.

Calibration

Calibration is optional. A single instance might exist.

A grouping element that contains information about calibration of the measuring equipment.

MeasuringEquipmentCode

A code used for identifying the measuring equipment.

Agency [attribute]

Agency is mandatory. A single instance is required.

Describes the agency maintaining the list of codes. To be included in this list the agency must be a recognized standards body or industry organisation.

- For the element that owns this attribute.
- For another attribute in the list of attributes associated with the parent element.

Refer to Agency definition for any enumerations.

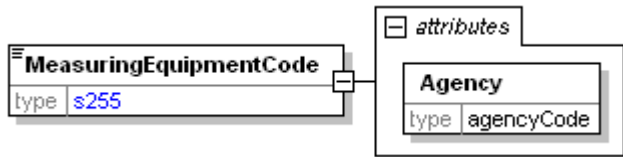

MeasuringEquipmentDescription

A text field element describing equipment used for measuring. When a MeasuringEquipmentCode is associated with a CodeValue of type TextValue, then the MeasuringEquipmentDescription is a textual description of both the MeasuringEquipmentCode and the TextValue.

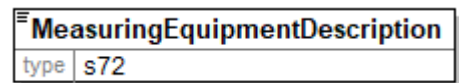

MeasuringInfoVersion

A grouping element that contains a specification of the version for the measuring information associated with a measurement.

IsVersionCancelled [attribute]

IsVersionCancelled is optional. A single instance might exist.

Specifies if the version of an item is cancelled or not.

Refer to IsVersionCancelled definition for any enumerations.

(sequence)

The sequence of items below is mandatory. A single instance is required.

VersionNumber

VersionNumber is mandatory. A single instance is required.

A unique number identifying the version of an item.

VersionDate

VersionDate is optional. A single instance might exist.

The Date and Time when the version of an item was issued.

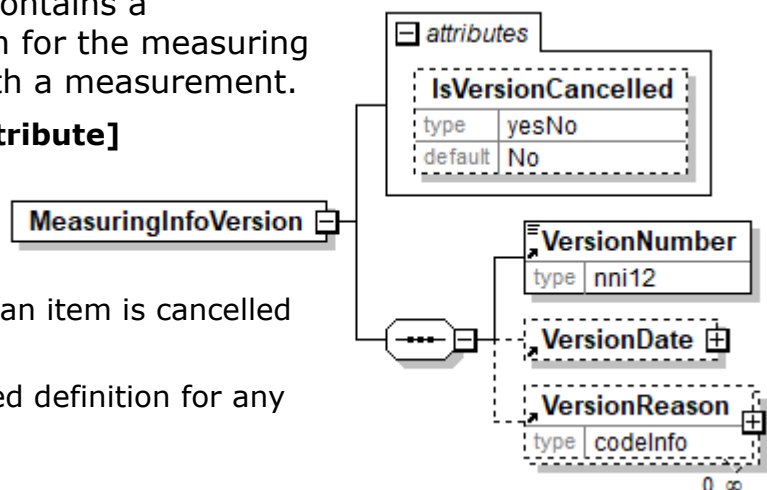

VersionReason

VersionReason is optional. Multiple instances might exist.

A grouping element that specifies the reason for a version of an item.

MeasuringInfoVersions [attribute]

Specifies the principle for how versions of measuring information are communicated for given measuring numbers. Default value is Single.

This item is restricted to the following list

Multiple

Multiple versions of measuring information might exist for a given measuring number.

Single

Only one version of measuring information exists for a given measuring number, normally the latest version.

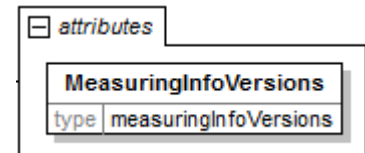

MeasuringInfoInvoicingType [attribute]

Specifies the type of measuring information that is supplied for invoicing. Depending on the invoicing process can the entire measuring information or just the difference to a previous invoiced version of measuring information be invoiced. A previous invoiced version of measuring information has to be credited when the entire measuring information is invoiced for a new version. A positive amount is debit and a negative amount is credit.

This item is restricted to the following list

Difference

Measuring information is specified as the difference to the latest already invoiced version or to the previous specified version in the MeasuringTicket e-Document.

Entire

Measuring information is specified as the entire measured information.

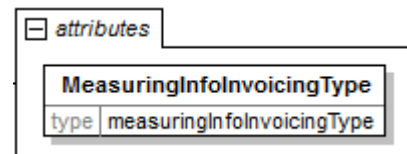

MeasuringInstruction

The MeasuringInstruction element is the root element for the MeasuringInstruction e-Document.

The MeasuringInstruction e-Document can be used to instruct a measuring party what to measure and how to measure it. Packages and loads as well as individual items can be measured.

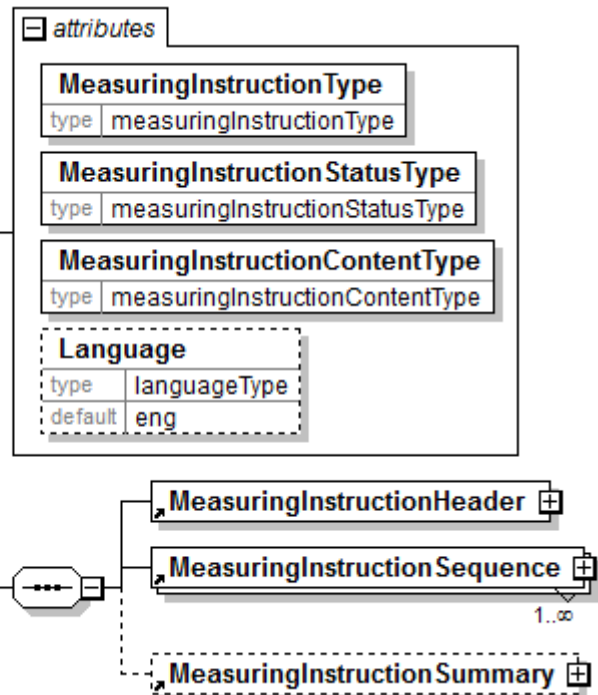
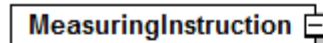

MeasuringInstructionType [attribute]

MeasuringInstructionType is mandatory. A single instance is required.

MeasuringInstructionType defines the type of MeasuringInstruction e-Document.

Refer to MeasuringInstructionType definition for any enumerations.

MeasuringInstructionStatusType [attribute]

MeasuringInstructionStatusType is mandatory. A single instance is required.

Identifies the status of the entire MeasuringInstruction e-Document.

Refer to MeasuringInstructionStatusType definition for any enumerations.

MeasuringInstructionContentType [attribute]

MeasuringInstructionContentType is mandatory. A single instance is required.

Specifies the method for finding what item or items to be measured.

Refer to MeasuringInstructionContentType definition for any enumerations.

Language [attribute]

Language is optional. A single instance might exist.

The valid Alpha 2- and Alpha 3-character list of language codes in the ISO 639-1 and 639-2 international standards.

Information on the content of this attribute is available at:
https://www.loc.gov/standards/iso639-2/php/code_list.php

(sequence)

The sequence of items below is mandatory. A single instance is required.

MeasuringInstructionHeader

MeasuringInstructionHeader is mandatory. A single instance is required.

The MeasuringInstructionHeader contains information common to the entire MeasuringInstruction e-Document.

MeasuringInstructionSequence

MeasuringInstructionSequence is mandatory. One instance is required, multiple instances might exist.

A grouping element that contains information about a source product to be measured.

MeasuringInstructionSummary

MeasuringInstructionSummary is optional. A single instance might exist.

A grouping element that contains summary information that applies to the entire MeasuringInstruction e-Document.

MeasuringInstructionContentType [attribute]

Specifies the method for finding what item or items to be measured.

This item is restricted to the following list.

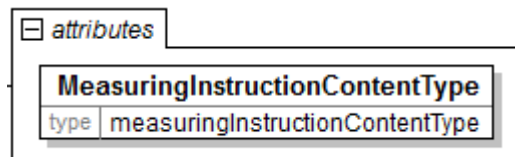

ByDeliverySource

Deliveries with a reference to a delivery source number.

ByLoad

A delivery with a reference to a specific transport.

ByOrder

Deliveries with a reference to an order number.

ByRandomSample

A random sample having a random sample number and a reference to an order number or a specific transport.

BySample

A sample having a sample number and a reference to an order number or a specific transport.

MeasuringInstructionHeader

The MeasuringInstructionHeader contains information common to the entire MeasuringInstruction e-Document.

(sequence)

The sequence of items below is mandatory. A single instance is required.

DocumentNumber

DocumentNumber mandatory. A single instance is required.

The unique identifier of a document.

DocumentIssueDate

DocumentIssueDate is mandatory. A single instance is required.

The date and time when the e-Document was issued.

TransactionHistoryNumber

TransactionHistoryNumber is optional. A single instance might exist.

A

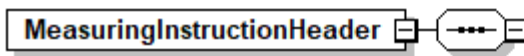

sequential number that keeps track of the version of a document.

However when the document is a confirmation document, in which case the TransactionHistoryNumber refers to the trigger transaction for the confirmation.

MeasuringInstructionTitle

MeasuringInstructionTitle is optional. Multiple instances might exist.

A text describing the context of the MeasuringInstruction.

SenderParty

SenderParty is optional. A single instance might exist.

The business entity issuing the e-Document, the source of the document.

- The entity responsible for the content. If the sender party has outsourced the message service to a third party the SenderParty is the issuer of the e-Document and not the party performing the transmission service of the electronic message.

ReceiverParty

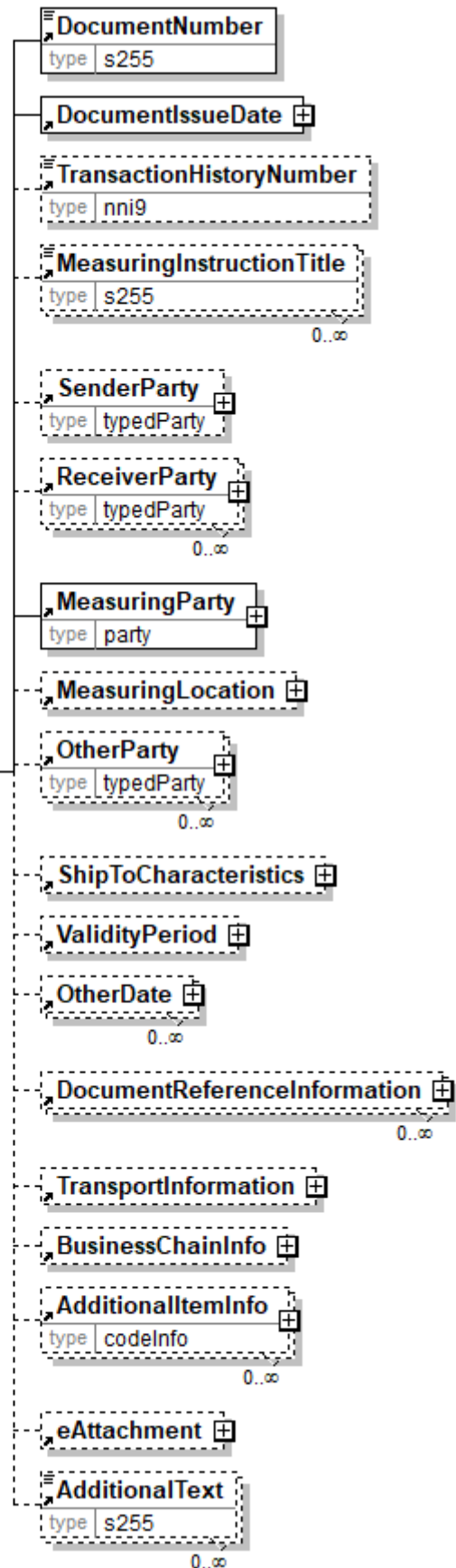

ReceiverParty is optional. Multiple instances might exist.

The business entity for whom the e-Document is intended, the destination of the document.

- The entity interested in the content. If the receiver party has outsourced the message service to a third party the ReceiverParty is the intended party for the e-Document and not the party performing the receiving service of the electronic message.

MeasuringParty

MeasuringParty is mandatory. A single instance is required.

The party that is responsible for the measurements at the measuring location.

MeasuringLocation

ReceiverParty is optional. A single instance might exist.

A grouping element that contains information about where the measuring is taken place.

OtherParty

OtherParty is optional. Multiple instances might exist.

An organisation or business entity other than those specifically detailed within an e-Document.

ShipToCharacteristics

ShipToCharacteristics is optional. A single instance might exist.

A group item that provides information important for the Ship-To Party.

ValidityPeriod

ValidityPeriod is optional. A single instance might exist.

The validity period for a specific item, e.g. the validity period for an e-Document.

OtherDate

OtherDate is optional. Multiple instances might exist.

A date that may not be specifically detailed within a document (example: print date at the PurchaseOrderLineItem).

DocumentReferenceInformation

DocumentReferenceInformation is optional. Multiple instances might exist.

A group item containing reference information applicable to a document.

TransportInformation

TransportInformation is optional. A single instance might exist.

A grouping element for transport information.

BusinessChainInfo

BusinessChainInfo is optional. A single instance might exist.

A grouping element that contains information about parties in the business chain when products or services are traded in many levels.

The business chain starts at the sourcing end where products are provided when BusinessChainContextType = Product.

The business chain starts at the purchasing of a service from the OriginalLogisticsSupplier when BusinessChainContextType = LogisticsService.

AdditionalItemInfo

AdditionalItemInfo is optional. Multiple instances might exist.

A grouping element that contains information about additional items specified by an agency. Restricted use of this element is recommended.

eAttachment

eAttachment is optional. A single instance might exist.

eAttachment enables the sender to provide information about attachments to the document.

Note: An element "e-Attachment" also exists. papiNet will no longer use hyphens in our element and attribute names as this causes issues with BizTalk.

AdditionalText

AdditionalText is optional. Multiple instances might exist.

A text field that is used to communicate information not previously defined or for special instructions. To be used only for circumstances not covered by specific elements.

MeasuringInstructionSequence

A grouping element that contains information about a source product to be measured.

(sequence)

The sequence of items below is mandatory. A single instance is required.

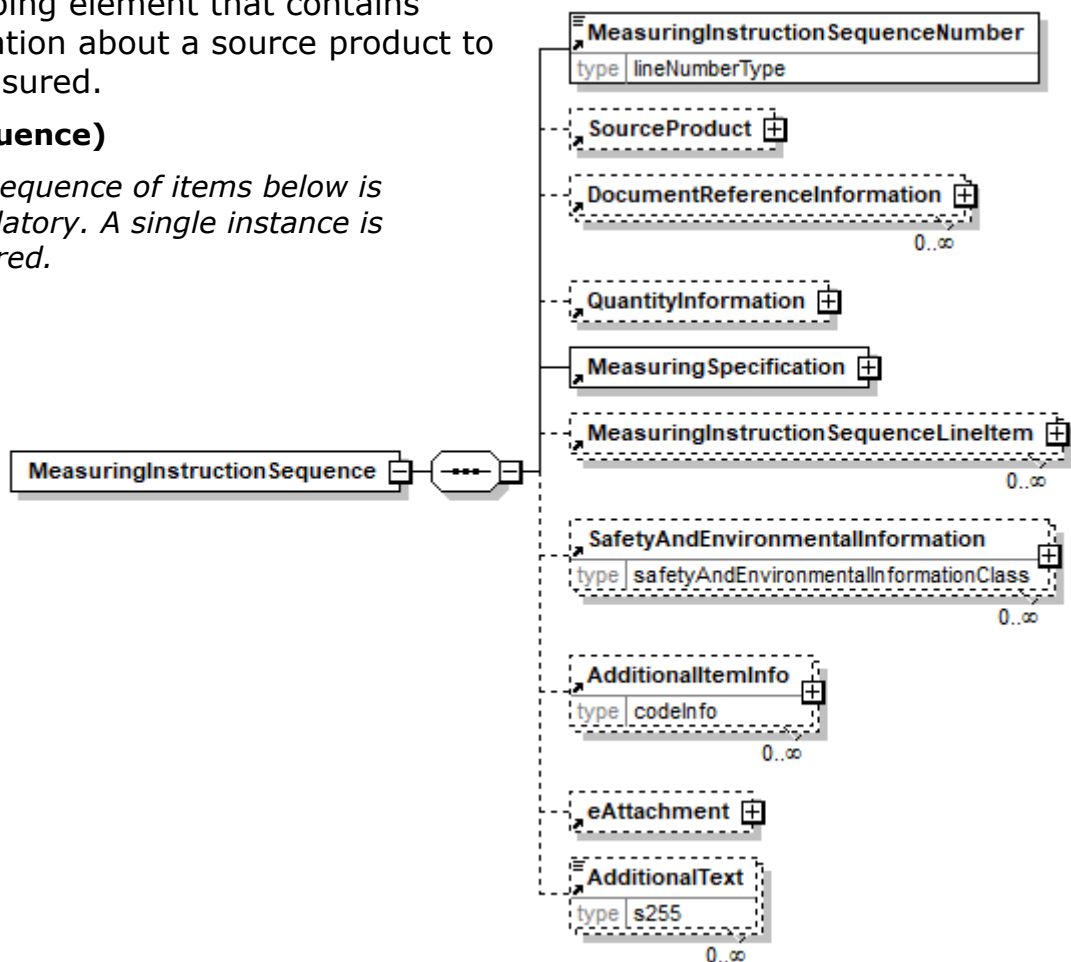

MeasuringInstructionSequenceNumber

MeasuringInstructionSequenceNumber is mandatory. A single instance is required.

papiNet V2R31

A sequential number that uniquely identifies the sequence in a MeasuringInstruction e-Document.

SourceProduct

SourceProduct is optional. A single instance might exist.

SourceProduct is a group element defining the product that is available for measuring.

The measuring of this product is done according to the measuring rules for the contracted product, which usually is the same product. But in some cases the product available for measuring is different from the contracted product. In these cases, the product available for measuring shall be measured according to the measuring rules for the MeasuringProduct specified in MeasuringSpecification.

For example, Pulpwood is produced but it is of very bad quality because of long time storage in the forest. This pulpwood will be sold as fire wood and shall when delivered be measured according to the measuring rules for firewood.

DocumentReferenceInformation

DocumentReferenceInformation is optional. Multiple instances might exist.

A group item containing reference information applicable to a document.

QuantityInformation

QuantityInformation is optional. A single instance might exist.

A group item containing information about quantity and informational quantity of similar items.

MeasuringSpecification

MeasuringSpecification is mandatory. A single instance is required.

A grouping element that contains a specification for measurement procedures for a measuring party at a measuring location.

MeasuringInstructionSequenceLineItem

MeasuringInstructionSequenceLineItem is optional. Multiple instances might exist.

A grouping element that contains information for a line item of the MeasuringInstructionSequence. The line item specifies detail information associated with a product.

SafetyAndEnvironmentalInformation

SafetyAndEnvironmentalInformation is optional. Multiple instances might exist.

Name of certification type, if any, on the goods (For example, FSC, PEFC). SafetyAndEnvironmental needs a value or measurement to communicate the percentage of the product is certified (for example, 75% is certified by the indicated agency).

AdditionalItemInfo

AdditionalItemInfo is optional. Multiple instances might exist.

A grouping element that contains information about additional items specified by an agency. Restricted use of this element is recommended.

eAttachment

eAttachment is optional. A single instance might exist.

eAttachment enables the sender to provide information about attachments to the document.

Note: An element "e-Attachment" also exists. papiNet will no longer use hyphens in

our element and attribute names as this causes issues with BizTalk.

AdditionalText

AdditionalText is optional. Multiple instances might exist.

A text field that is used to communicate information not previously defined or for special instructions. To be used only for circumstances not covered by specific elements.

MeasuringInstructionSequenceLineItem

A grouping element that contains information for a line item of the

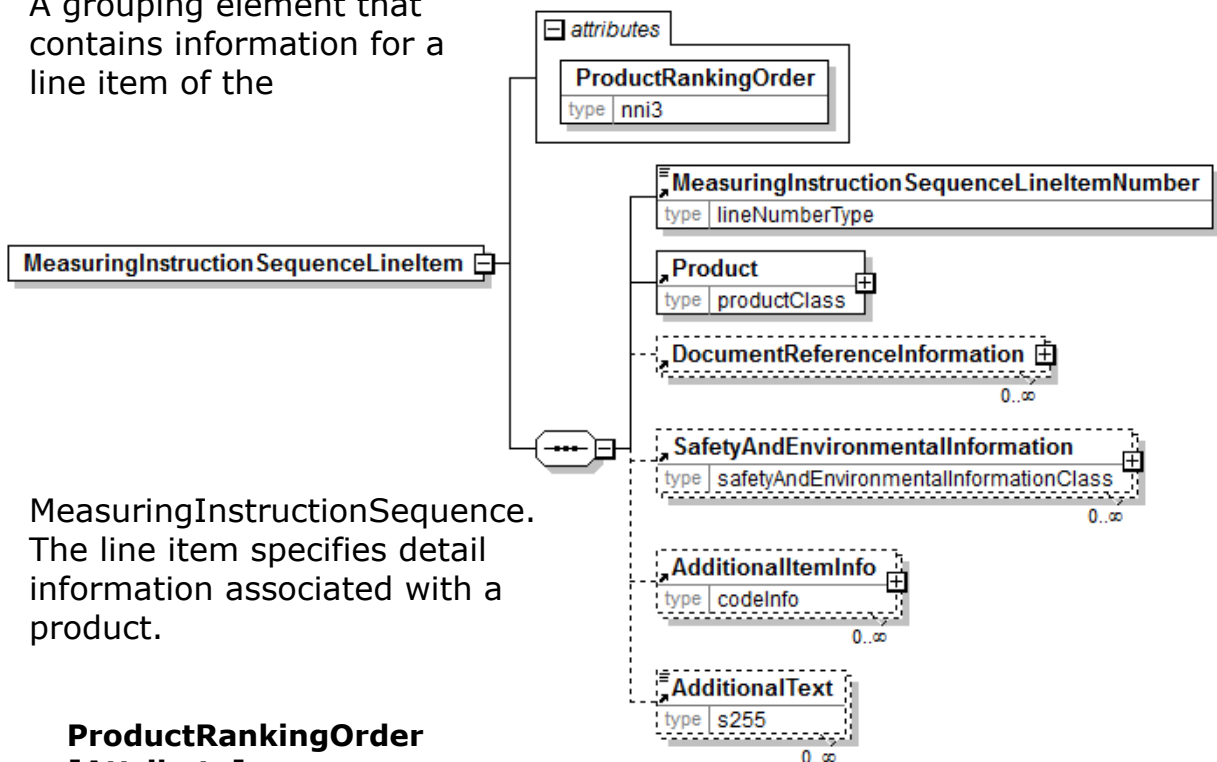

MeasuringInstructionSequence. The line item specifies detail information associated with a product.

ProductRankingOrder [Attribute]

ProductRankingOrder is mandatory. A single instance is required.

Defines the order of products to choose when available product properties are applicable to specifications of more than one product. ProductRankingOrder is a positive number. Value 1 has the highest rank.

(sequence)

The sequence of items below is mandatory. A single instance is required.

MeasuringInstructionSequenceLineItemNumber

MeasuringInstructionSequenceLineItemNumber is mandatory. A single instance is required.

A sequential number that uniquely identifies the line item of the MeasuringInstructionSequence.

Product

Product is mandatory. A single instance is required.

Product is a group item defining the article and its characteristics. Product is used to specify product characteristics organized by ProductIdentifier, ProductDescription, and Classification. Book Manufacturing, Forest Wood, Label

papiNet V2R31

Stock, Paper, Pulp, Recovered Paper, Wood Products, and Virgin Fibre market segments have defined their product characteristics and conversion features for implementation in papiNet.

DocumentReferenceInformation

DocumentReferenceInformation is optional. Multiple instances might exist.

A group item containing reference information applicable to a document.

SafetyAndEnvironmentalInformation

SafetyAndEnvironmentalInformation is optional. Multiple instances might exist.

Name of certification type, if any, on the goods (For example, FSC, PEFC). SafetyAndEnvironmental needs a value or measurement to communicate the percentage of the product is certified (for example, 75% is certified by the indicated agency).

AdditionalItemInfo

AdditionalItemInfo is optional. Multiple instances might exist.

A grouping element that contains information about additional items specified by an agency. Restricted use of this element is recommended.

AdditionalText

AdditionalText is optional. Multiple instances might exist.

A text field that is used to communicate information not previously defined or for special instructions. To be used only for circumstances not covered by specific elements.

MeasuringInstructionSequenceLineItemNumber

A sequential number that uniquely identifies the line item of the

MeasuringInstructionSequenceLineItemNumber	
type	lineNumberType

MeasuringInstructionSequence.

MeasuringInstructionSequenceNumber

A sequential number that uniquely identifies the sequence in a MeasuringInstruction e-Document.

MeasuringInstructionSequenceNumber	
type	lineNumberType

MeasuringInstructionStatusType [attribute]

Identifies the status of the entire MeasuringInstruction e-Document.

This item is restricted to the following list.

attributes	
MeasuringInstructionStatusType	
type	measuringInstructionStatusType

Cancelled

The supplied information has been cancelled. Items that have been cancelled are not included in totals on the summary levels of the e-document.

Original

The supplied information is the first version of that information.

Replaced

The supplied information is replacing earlier supplied information. The receiver should revalidate the information in their system based upon the entire information received.

MeasuringInstructionSummary

A grouping element that contains summary information that applies to the entire MeasuringInstruction e-Document.

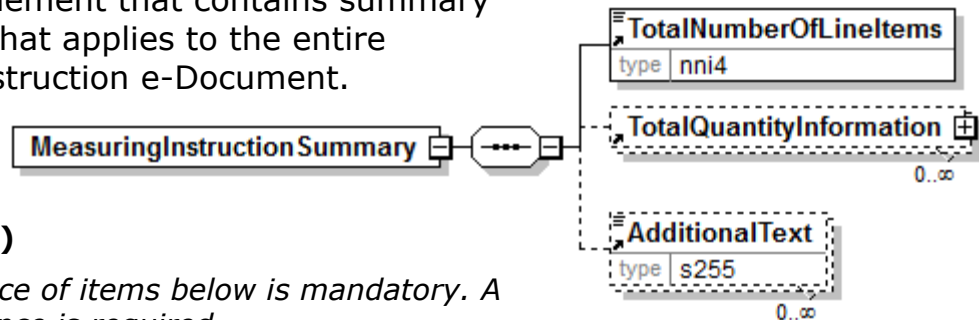

(sequence)

The sequence of items below is mandatory. A single instance is required.

TotalNumberOfLineItems

TotalNumberOfLineItems is optional. A single instance might exist.

The total number of individual line items in the document, regardless of the status or type.

TotalQuantityInformation

TotalQuantityInformation is optional. A single instance might exist.

A group item containing information about the total quantity and total informational quantity of similar items in the document.

TotalQuantityInformation is primarily used in the summary section of e-Documents where it is repeatable to permit totalling for different units of measure.

AdditionalText

AdditionalText is optional. Multiple instances might exist.

A text field that is used to communicate information not previously defined or for special instructions. To be used only for circumstances not covered by specific elements.

MeasuringInstructionTitle

A text describing the context of the MeasuringInstruction.

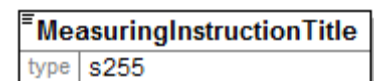

MeasuringInstructionType [attribute]

MeasuringInstructionType defines the type of MeasuringInstruction e-Document.

This item is restricted to the following list.

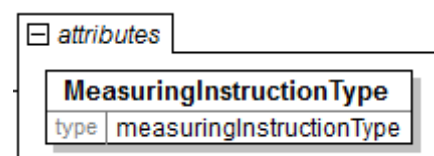

MeasuringInstruction

An instruction to measure products. Normally a measurement includes both quantity and quality.

SampleMeasuringInstruction

An instruction to measure samples to check the original measurements or to measure specific properties in for example a laboratory.

MeasuringLineID

The unique identifier for the measuring line at a measuring location.

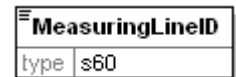

MeasuringLocation

A grouping element that contains information about where the measuring is taken place.

(sequence)

The sequence of items below is mandatory. A single instance is required.

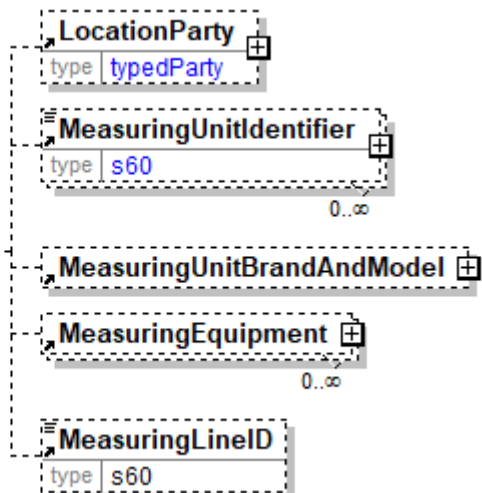
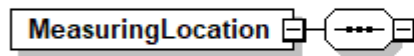

LocationParty

LocationParty is optional. A single instance might exist.

The organization or business entity where the business event took place or will take place.

MeasuringUnitIdentifier

MeasuringUnitIdentifier is optional. Multiple instances might exist.

The identifier of a measuring unit, e.g. the identifier of a Forest Harvester. The type of identifier is indicated by the attribute MeasuringUnitIdentifierType.

MeasuringUnitBrandAndModel

MeasuringUnitBrandAndModel is optional. A single instance might exist.

A grouping element containing information about brand and model for a measuring unit.

MeasuringEquipment

MeasuringEquipment is optional. Multiple instances might exist.

A grouping element that contains information about the equipment used for measuring.

MeasuringLineID

MeasuringLineID is optional. A single instance might exist.

The unique identifier for the measuring line at a measuring location.

MeasuringMethod [attribute]

The method used to determine how the item under consideration is measured. Measuring methods are defined by the measuring agency.

attribute	
MeasuringMethod	
type	s60

MeasuringMethodType [attribute]

Specifies how a measurement value is created.

This item is restricted to the following list.

MeasuringMethodType	
type	measuringMethodType
default	Automatic

Automatic

The value is created by a closed automatic measurement system.

Calculated

The value is calculated based on information from different sources.

Classified

The value is created by applying rules for classification based on a number of properties.

ConvertedUOM

The value is created by converting a value from a unit of measure into another unit of measure.

Manual

The value is created by manual measurement or calculated based on only manual measurements.

Unspecified

It is not specified how the value is created.

VisualEstimated

The value is created by visual estimation.

MeasuringNumber

A unique identifier for the measuring information communicated in a MeasuringTicketSequence.

MeasuringNumber	
type	s60

The measuring information in the MeasuringTicketSequence can have different identifiers depending on the source of the information, such as a measuring event, a calculation of quantities based on a measuring event and a calculation of compensation based on quantities and prices, as well as on the MeasuringTicketType and the MeasuringTicketContextType of the MeasuringTicket.

MeasuringParty

The party that is responsible for the measurements at the measuring location.

LogisticsRole [attribute]

LogisticsRole is optional. A single instance might exist.

Communicates the nature of the logistics role, if any, the party plays in the transaction.

Refer to LogisticsRole definition for any enumerations.

(sequence)

The sequence of items below is mandatory. A single instance is required.

PartyIdentifier

PartyIdentifier is optional. Multiple instances might exist.

A unique identifier of a specific party. This element contains an attribute PartyIdentifierType that indicates the type of the identifier.

NameAddress

NameAddress is mandatory. A single instance is required.

A group item containing name and address of an organisation or business entity.

URL

URL is optional. A single instance might exist.

Universal Resource Locator. While typically a web address you could use this field to hold an email address.

CommonContact

CommonContact is optional. Multiple instances might exist.

Identifies a specific individual associated with the party.

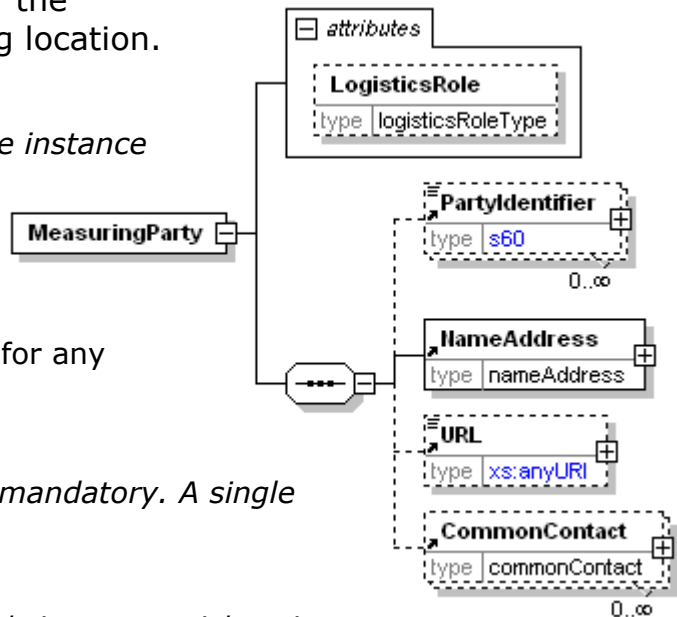

MeasuringProduct

MeasuringProduct is a group element defining the product that the measuring rules shall be based on or is based on.

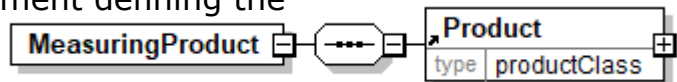

For example, Pulpwood is produced but it is of very bad quality because of long time storage in the forest. This pulpwood will be sold as fire wood and shall when delivered be measured according to the measuring rules for firewood.

(sequence)

The sequence of items below is mandatory. A single instance is required.

Product

Product is mandatory. A single instance is required.

Product is a group item defining the article and its characteristics. Product is used to specify product characteristics organized by ProductIdentifier, ProductDescription, and Classification. Book Manufacturing, Forest Wood, Label Stock, Paper, Pulp, Recovered Paper, Wood Products, and Virgin Fibre market segments have defined their product characteristics and conversion features for implementation in papiNet.

MeasuringReference

An element detailing relevant references pertaining to measuring as indicated by

MeasuringReferenceType and AssignedBy.

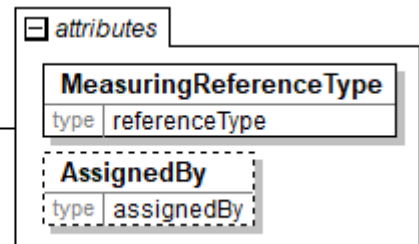
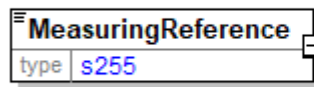

MeasuringReferenceType [attribute]

MeasuringReferenceType is mandatory. A single instance is required.

Provides a contextual explanation of the specific reference identifier. Many items are currently prefixed by "Buyer", "Forwarder", "Manufacturer", "Mill", "Seller", "Supplier", "Warehouse", or "Vendor". Check for an existing non-prefixed version and use the non-prefixed version instead. In the (yet to be announced release date) version 3.0 the prefixed versions will be removed. Instead the attribute @AssignedBy will communicate the information previously communicated in the prefix.

Refer to MeasuringReferenceType definition for any enumerations.

AssignedBy [attribute]

AssignedBy is optional. A single instance might exist.

Identifies the type of party or the agency that has assigned the associated item, e.g. a reference of type OrderNumber.

Refer to AssignedBy for any enumerations.

MeasuringReferenceType [attribute]

Provides a contextual explanation of the specific reference identifier. Many items are currently prefixed by "Buyer", "Forwarder", "Manufacturer", "Mill", "Seller", "Supplier", "Warehouse" or "Vendor". Check for an existing non-prefixed version and use the non-prefixed version instead. In the (yet to be announced release date) version 3.0 the prefixed versions will be removed. Instead the attribute AssignedBy will communicate the information previously communicated in the prefix.

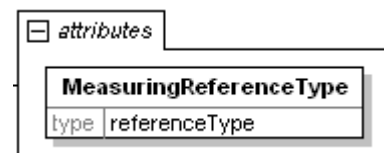

Refer to the [referenceType](#) entry for the list of enumerations and their definitions.

MeasuringSpecification

A grouping element that contains a specification for measurement procedures for a measuring party at a measuring location.

MeasuringType [attribute]

MeasuringType is mandatory. A single instance is required.

MeasuringSpecification

Specifies how detailed the measurements are done.

Refer to MeasuringType definition for any enumerations.

PrioritisedMeasuringType [attribute]

PrioritisedMeasuringType is optional. A single instance might exist.

Attribute PrioritisedMeasuringType is used for specifying a measuring type as an alternative measuring type, when alternative measuring types are allowed to be used. The enumeration value of attribute PrioritisedMeasuringType specifies which measuring type is prioritised of the alternative measuring types.

Refer to PrioritisedMeasuringType definition for any enumerations.

CompensationMeasuringType [attribute]

CompensationMeasuringType is optional. A single instance might exist.

Specifies what kind of measuring is used for financial compensation.

Refer to CompensationMeasuringType definition for any enumerations.

(sequence)

The sequence of items below is mandatory. A single instance is required.

MeasuringParty

MeasuringParty is optional. A single instance might exist.

The party that is responsible for the measurements at the measuring location.

MeasuringLocation

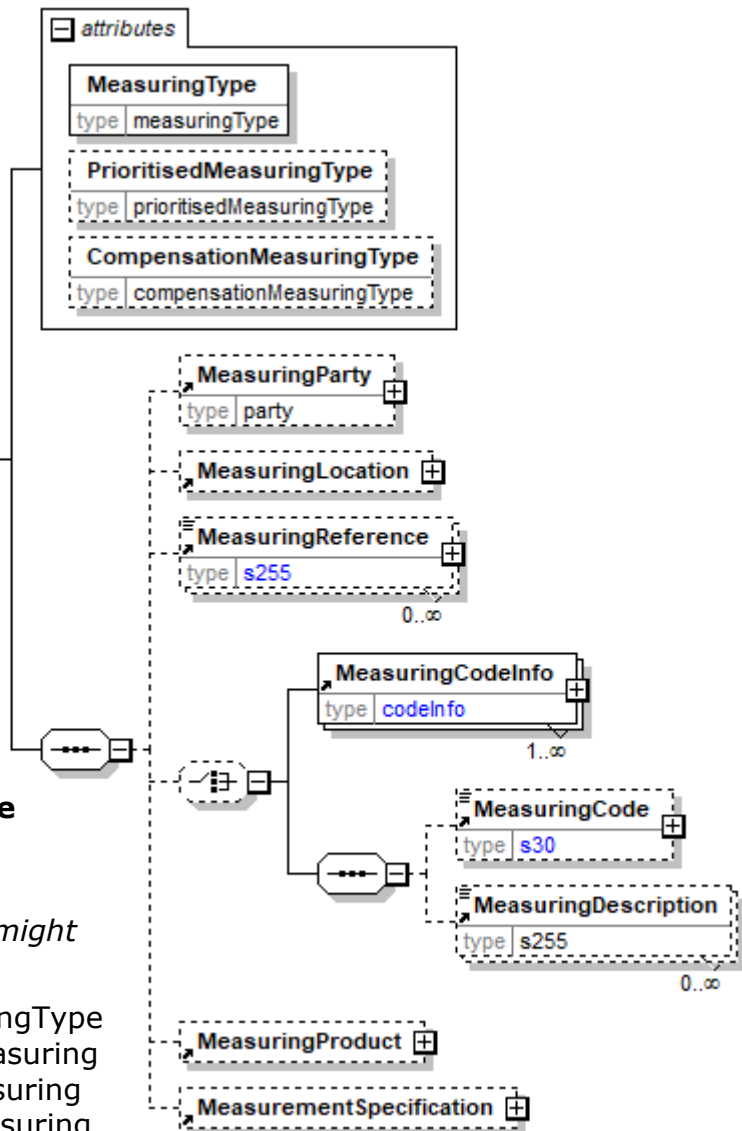

MeasuringLocation is optional. A single instance might exist.

A grouping element that contains information about where the measuring is taken place.

MeasuringReference

MeasuringReference is optional. Multiple instances might exist.

An element detailing relevant references pertaining to measuring as indicated by MeasuringReferenceType and AssignedBy.

(choice)

[choice] is optional. A single instance might exist.

MeasuringCodeInfo

MeasuringCodeInfo is mandatory. One instance is required, multiple instances might exist.

A grouping element that contains information about measuring codes defining the measuring procedure.

(sequence)

The sequence of items below is mandatory. A single instance is required.

MeasuringCode

MeasuringCode is optional. A single instance might exist.

A code defining the measuring procedure.

MeasuringCode will be deprecated in a future version V3R00 and should not be used in new implementations. Use instead the MeasuringCodeInfo construct.

MeasuringDescription

MeasuringDescription is optional. Multiple instances might exist.

A text element describing the measuring procedure.

MeasuringDescription will be deprecated in a future version V3R00 and should not be used in new implementations. Use instead the MeasuringCodeInfo construct.

MeasuringProduct

MeasuringCode is optional. A single instance might exist.

MeasuringProduct is a group element defining the product that the measuring rules shall be based on or is based on.

For example, Pulpwood is produced but it is of very bad quality because of long time storage in the forest. This pulpwood will be sold as fire wood and shall when delivered be measured according to the measuring rules for firewood.

MeasurementSpecification

MeasurementSpecification is optional. A single instance might exist.

A grouping element that contains a specification of properties and quantities that should be measured or are measured.

MeasuringTicket

The MeasuringTicket element is the root element for the MeasuringTicket e-Document.

The MeasuringTicket e-Document specifies the details from measuring of items. Packages and loads can be measured as well as individual items in packages and loads. Products, Quantities and various measured properties can be reported. These measurements can be used as a base for calculation of billable products.



MeasuringTicketType [attribute]

MeasuringTicketType is mandatory. A single instance is required.

MeasuringTicketType defines the type of MeasuringTicket.

Refer to MeasuringTicketType definition for any enumerations.

MeasuringTicketStatusType [attribute]

MeasuringTicketStatusType is mandatory. A single instance is required.

Identifies the status of the entire MeasuringTicket e-Document.

Refer to MeasuringTicketStatusType definition for any enumerations.

MeasuringTicketContextType [attribute]

MeasuringTicketContextType is optional. A single instance might exist.

Indicates the nature of what is included in the MeasuringTicket e-document.

Refer to MeasuringTicketContextType definition for any enumerations.

Reissued [attribute]

Reissued is optional. A single instance might exist.

Either "Yes" or "No".

Refer to Reissued definition for any enumerations.

Language [attribute]

Language is optional. A single instance might exist.

The valid Alpha 2- and Alpha 3-character list of language codes in the ISO 639-1 and 639-2 international standards.

Information on the content of this attribute is available at:
https://www.loc.gov/standards/iso639-2/php/code_list.php

(sequence)

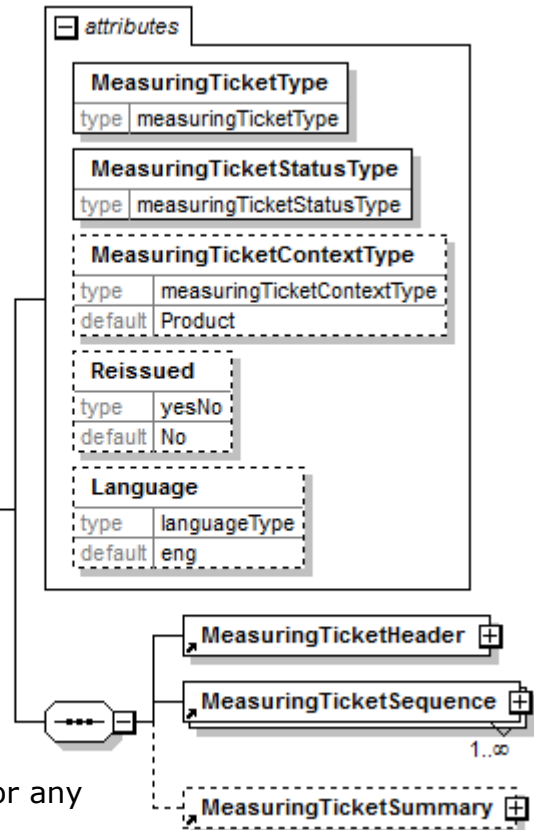

The sequence of items below is mandatory. A single instance is required.

MeasuringTicketHeader

MeasuringTicketHeader is mandatory. A single instance is required.

The MeasuringTicketHeader contains information common to the entire MeasuringTicket e-Document.

MeasuringTicketSequence

MeasuringTicketSequence is mandatory. One instance is required, multiple instances might exist.

A grouping element that contains information for a measuring event, e.g. a truck load.

MeasuringTicketSummary

MeasuringTicketSummary is optional. A single instance might exist.

A grouping element that contains summary information that applies to the entire MeasuringTicket e-Document.

MeasuringTicketContextType [attribute]

Indicates the nature of what is included in the MeasuringTicket e-document.

This item is restricted to the following list.

LogisticsService

The MeasuringTicket is exclusively for logistics business.

Product

The MeasuringTicket is exclusively for product business.

MeasuringTicketContextType	
type	measuringTicketContextType
default	Product

MeasuringTicketHeader

The MeasuringTicketHeader contains information common to the entire MeasuringTicket e-Document.

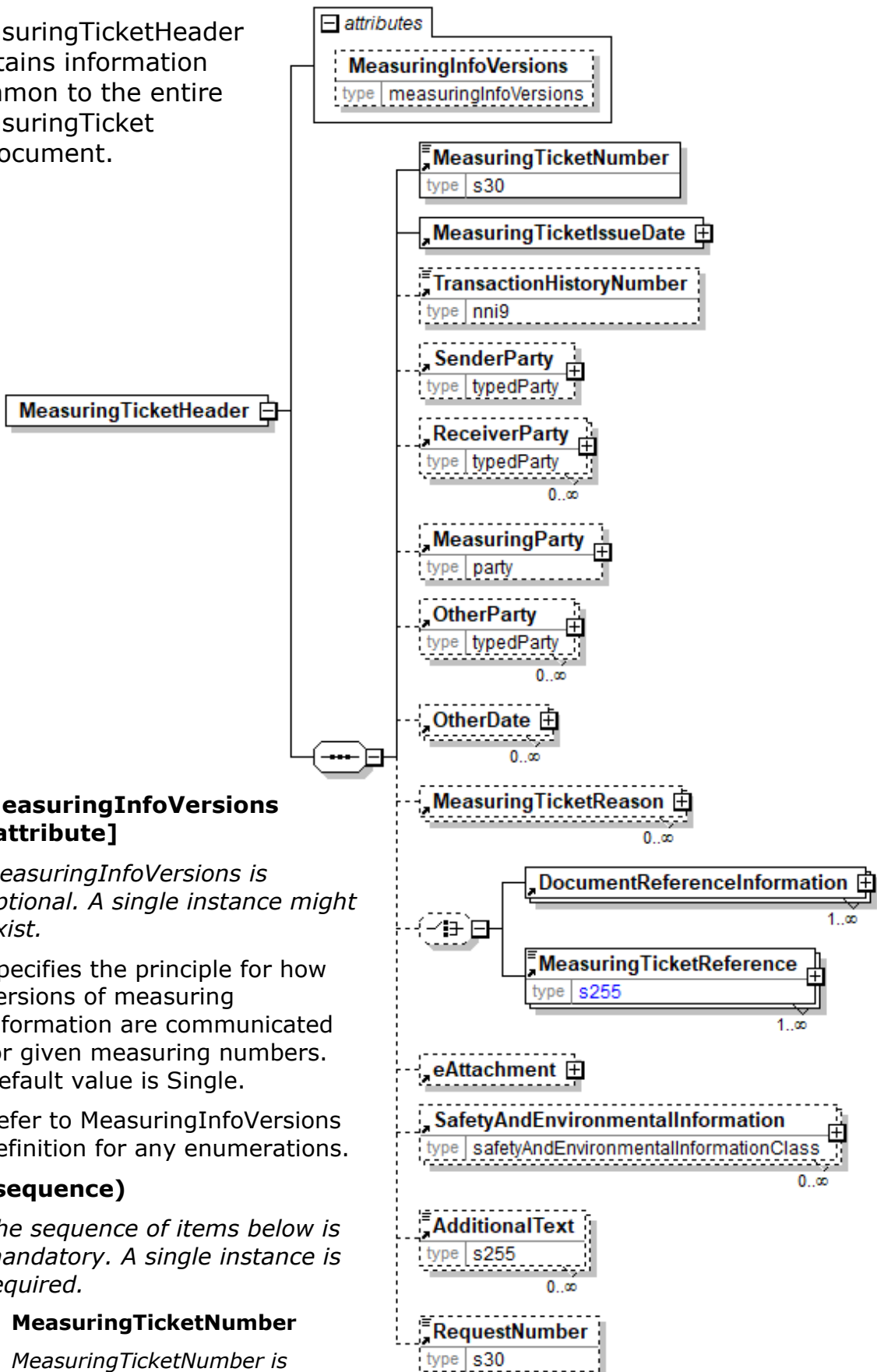

MeasuringInfoVersions [attribute]

MeasuringInfoVersions is optional. A single instance might exist.

Specifies the principle for how versions of measuring information are communicated for given measuring numbers. Default value is Single.

Refer to MeasuringInfoVersions definition for any enumerations.

(sequence)

The sequence of items below is mandatory. A single instance is required.

MeasuringTicketNumber

MeasuringTicketNumber is mandatory. A single instance is required.

The unique identifier for the MeasuringTicket e-Document.

MeasuringTicketIssueDate

MeasuringTicketIssueDate is mandatory. A single instance is required.

The date and time when the MeasuringTicket e-Document was issued.

TransactionHistoryNumber

TransactionHistoryNumber is optional. A single instance might exist.

A sequential number that keeps track of the version of a document.

However when the document is a confirmation document, in which case the TransactionHistoryNumber refers to the trigger transaction for the confirmation.

SenderParty

SenderParty is optional. A single instance might exist.

The business entity issuing the e-Document, the source of the document.

- The entity responsible for the content. If the sender party has out sourced the message service to a third party the SenderParty is the issuer of the e-Document and not the party performing the transmission service of the electronic message.

ReceiverParty

ReceiverParty is optional. Multiple instances might exist.

The business entity for whom the e-Document is intended, the destination of the document.

- The entity interested in the content. If the receiver party has outsourced the message service to a third party the ReceiverParty is the intended party for the e-Document and not the party performing the receiving service of the electronic message.

MeasuringParty

MeasuringParty is optional. A single instance might exist.

The party that is responsible for the measurements at the measuring location.

OtherParty

OtherParty is optional. Multiple instances might exist.

An organisation or business entity other than those specifically detailed within an e-Document.

OtherDate

OtherDate is optional. Multiple instances might exist.

A date that may not be specifically detailed within a document (example: print date at the PurchaseOrderLineItem).

MeasuringTicketReason

MeasuringTicketReason is optional. Multiple instances might exist.

A group item containing the reason for issuing the MeasuringTicket e-Document, e.g. why it is replaced.

(choice)

[choice] is optional. A single instance might exist.

DocumentReferenceInformation

papiNet V2R31

DocumentReferenceInformation is mandatory. One instance is required, multiple instances might exist.

A group item containing reference information applicable to a document.

MeasuringTicketReference

MeasuringTicketReference is mandatory. One instance is required, multiple instances might exist.

An element detailing relevant references pertaining to the MeasuringTicket as indicated by MeasuringTicketReferenceType and AssignedBy.

MeasuringTicketReference will be deprecated in a future version V3R00. Use the DocumentReferenceInformation element instead.

eAttachment

eAttachment is optional. A single instance might exist.

eAttachment enables the sender to provide information about attachments to the document.

- Note: An element "e-Attachment" also exists. papiNet will no longer use hyphens in our element and attribute names as this causes issues with BizTalk.

SafetyAndEnvironmentalInformation

SafetyAndEnvironmentalInformation is optional. Multiple instances might exist.

Name of certification type, if any, on the goods (For example, FSC, PEFC). SafetyAndEnvironmental needs a value or measurement to communicate the percentage of the product is certified (for example, 75% is certified by the indicated agency).

AdditionalText

AdditionalText is optional. Multiple instances might exist.

A text field that is used to communicate information not previously defined or for special instructions. To be used only for circumstances not covered by specific elements.

RequestNumber

RequestNumber is optional. A single instance might exist.

A unique tracking number specifically identifying the InfoRequest e-Document to the originator. The tracking number is returned with the "information", the answer, to help match the answer to the request.

MeasuringTicketIssueDate

The date and time when the MeasuringTicket e-Document was issued.

(sequence)

The sequence of items below is mandatory. A single instance is required.

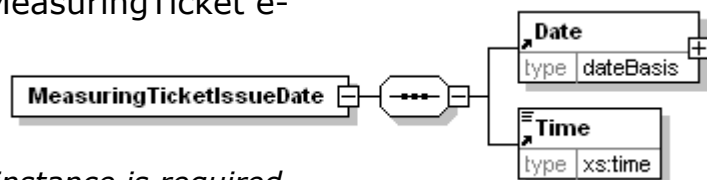

Date

Date is mandatory. A single instance is required.

A group element that contains the specification of Year, Month, and Day.

Time

papiNet V2R31

Time is mandatory. A single instance is required.

Times are treated in a standard XML fashion with a special case used to indicate a generalized "local" time. The standard XML approach to time is hh:mm:ss, hh:mm:ssZ, or hh:mm:ss±hh:mm.

- hh:mm:ss±hh:mm is used to represent a time with a time zone. The time zone is communicated as the number of hours offset from the Universal Time Coordinate (UTC), a.k.a. Greenwich Mean Time.
- hh:mm:ssZ indicates the time at Zulu (another name for UTC).
- hh:mm:ss or hh:mm indicates within papiNet the applicable local time where the associated event is taking place. Caution should be used when processing times of this nature as the papiNet approach may be in discord with other users of XML.

MeasuringTicketNumber

The unique identifier for the MeasuringTicket e-Document.

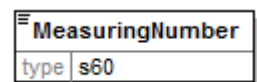

MeasuringTicketReason

A group item containing the reason for issuing the MeasuringTicket e-Document, e.g. why it is replaced.

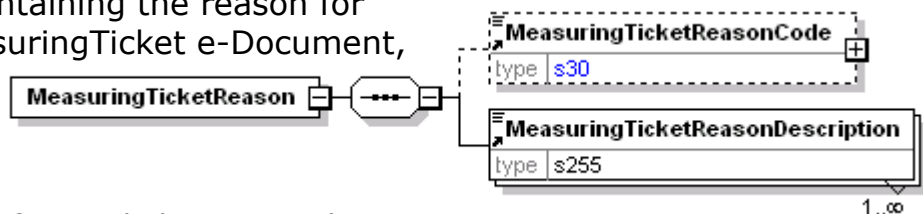

(sequence)

The sequence of items below is mandatory. A single instance is required.

MeasuringTicketReasonCode

MeasuringTicketReasonCode is optional. A single instance might exist.

A code specifying the reason for issuing the MeasuringTicket e-Document.

MeasuringTicketReasonDescription

MeasuringTicketReasonDescription is mandatory. One instance is required, multiple instances might exist.

A text describing the reason for issuing the MeasuringTicket e-Document.

MeasuringTicketReasonCode

A code specifying the reason for issuing the MeasuringTicket e-Document.

Agency [attribute]

Agency is mandatory. A single instance is required.

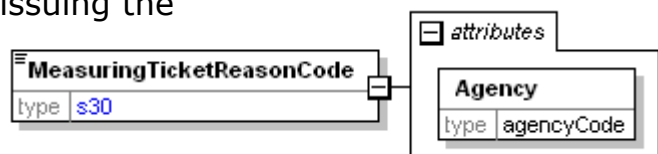

Describes the agency maintaining the list of codes. To be included in this list the agency must be a recognized standards body or industry organisation.

- For the element that owns this attribute.
- For another attribute in the list of attributes associated with the parent element.

Refer to Agency definition for any enumerations.

MeasuringTicketReasonDescription

A text describing the reason for issuing the MeasuringTicket e-Document.

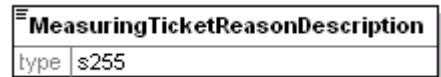

MeasuringTicketReference

An element detailing relevant references pertaining to the MeasuringTicket as indicated by

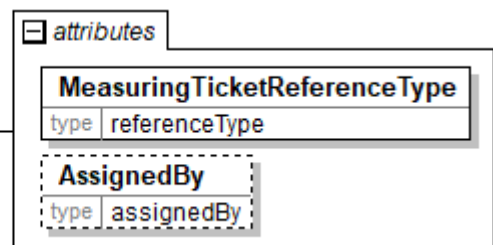
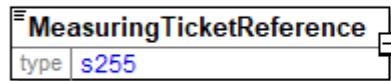

MeasuringTicketReferenceType and AssignedBy.

MeasuringTicketReference will be deprecated in a future version V3R00. Use the DocumentReferenceInformation element instead.

MeasuringTicketReferenceType [attribute]

MeasuringTicketReferenceType is mandatory. A single instance is required.

Provides a contextual explanation of the specific reference identifier. Many items are currently prefixed by "Buyer", "Forwarder", "Manufacturer", "Mill", "Seller", "Supplier", "Warehouse", or "Vendor". Check for an existing non-prefixed version and use the non-prefixed version instead. In the (yet to be announced release date) version 3.0 the prefixed versions will be removed. Instead the attribute @AssignedBy will communicate the information previously communicated in the prefix.

Refer to MeasuringTicketReferenceType definition for any enumerations.

AssignedBy [attribute]

AssignedBy is optional. A single instance might exist.

Identifies the type of party or the agency that has assigned the associated item, e.g. a reference of type OrderNumber.

Refer to AssignedBy for any enumerations.

MeasuringTicketReferenceType [attribute]

Provides a contextual explanation of the specific reference identifier. Many items are currently prefixed by "Buyer", "Forwarder",



“Manufacturer”, “Mill”, “Seller”, “Supplier”, “Warehouse” or “Vendor”. Check for an existing non-prefixed version and use the non-prefixed version instead. In the (yet to be announced release date) version 3.0 the prefixed versions will be removed. Instead the attribute AssignedBy will communicate the information previously communicated in the prefix.

Refer to the [referenceType](#) entry for the list of enumerations and their definitions.

MeasuringTicketRequestDetail

A grouping element that provides the parameters to be used when responding with a MeasuringTicket e-Document.

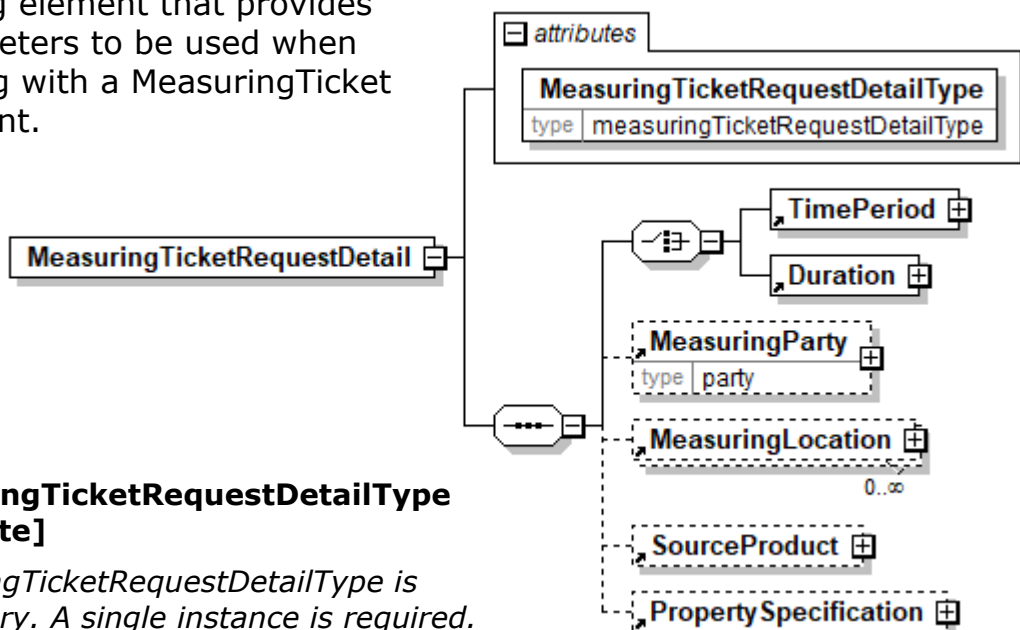

MeasuringTicketRequestDetailType [attribute]

MeasuringTicketRequestDetailType is mandatory. A single instance is required.

Communicates the method in which the MeasuringTicket should be reported. Refer to MeasuringTicketRequestDetailType definition for any enumerations.

(sequence)

The sequence of items below is mandatory. A single instance is required.

(choice)

[choice] is mandatory. A single instance is required.

TimePeriod

TimePeriod is mandatory. A single instance is required.

The TimePeriod element is used to communicate a duration period of time as indicated in PeriodType.

Duration

Duration is mandatory. A single instance is required.

A grouping element that contains information about a time interval and its target date.

MeasuringParty

MeasuringParty is optional. A single instance might exist.

The party that is responsible for the measurements at the measuring location.

MeasuringLocation

MeasuringLocation is optional. Multiple instances might exist.

A grouping element that contains information about where the measuring is taken place.

SourceProduct

SourceProduct is optional. A single instance might exist.

SourceProduct is a group element defining the product that is available for measuring.

The measuring of this product is done according to the measuring rules for the contracted product, which usually is the same product. But in some cases the product available for measuring is different from the contracted product. In these cases, the product available for measuring shall be measured according to the measuring rules for the MeasuringProduct specified in MeasuringSpecification.

For example, Pulpwood is produced but it is of very bad quality because of long time storage in the forest. This pulpwood will be sold as fire wood and shall when delivered be measured according to the measuring rules for firewood.

PropertySpecification

PropertySpecification is optional. A single instance might exist.

A grouping element that contains a specification of properties that should be measured or are measured.

MeasuringTicketRequestDetailType [attribute]

Communicates the method in which the MeasuringTicket should be reported.

This item is restricted to the following list.

CalibrationCheckLog

Request for a Calibration Check Log.

PropertyTicket

Request for a MeasuringTicket of type PropertyTicket.



MeasuringTicketSequence

A grouping element that contains information for a measuring event, e.g. a truck load.

MeasuringInfoInvoicingType [attribute]

MeasuringInfoInvoicingType is optional. A single instance might exist.

Specifies the type of measuring information that is supplied for invoicing. Depending on the invoicing process can the entire measuring information or just the difference to a previous invoiced version of measuring information be invoiced. A previous invoiced version of measuring information has to be credited when the entire measuring information is invoiced for a new version. A positive amount is debit and a negative amount is credit.

Refer to MeasuringInfoInvoicingType definition for any enumerations.

IsMeasuringInfoCancelled [attribute]

IsMeasuringInfoCancelled is optional. A single instance might exist.

Specifies if the measuring information is cancelled or not. When the measuring information is cancelled, then all versions of the measuring information are cancelled.

Refer to IsMeasuringInfoCancelled definition for any enumerations.

(sequence)

The sequence of items below is mandatory. A single instance is required.

MeasuringTicketSequenceNumber

MeasuringTicketSequenceNumber is mandatory. A single instance is required.

A sequential number that uniquely identifies the sequence in a MeasuringTicket e-Document.

MeasuringNumber

MeasuringNumber is optional. A single instance might exist.

A unique identifier for the measuring information communicated in a MeasuringTicketSequence.

The measuring information in the MeasuringTicketSequence can have different identifiers depending on the source of the information, such as a measuring event, a calculation

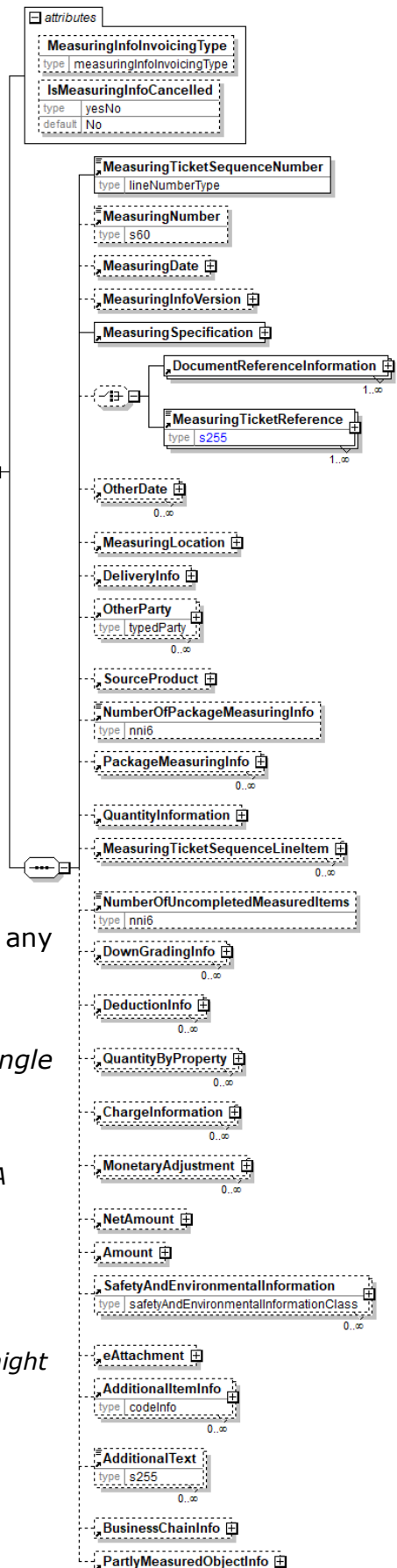

of quantities based on a measuring event and a calculation of compensation based on quantities and prices, as well as on the MeasuringTicketType and the MeasuringTicketContextType of the MeasuringTicket.

MeasuringDate

MeasuringDate is optional. A single instance might exist.

The date when the measuring was done.

MeasuringInfoVersion

MeasuringInfoVersion is optional. A single instance might exist.

A grouping element that contains a specification of the version for the measuring information associated with a measurement.

MeasuringSpecification

MeasuringSpecification is mandatory. A single instance is required.

A grouping element that contains a specification for measurement procedures for a measuring party at a measuring location.

(choice)

[choice] is optional. A single instance might exist.

DocumentReferenceInformation

DocumentReferenceInformation is mandatory. One instance is required, multiple instances might exist.

A group item containing reference information applicable to a document.

MeasuringTicketReference

MeasuringTicketReference is mandatory. One instance is required, multiple instances might exist.

An element detailing relevant references pertaining to the MeasuringTicket as indicated by MeasuringTicketReferenceType and AssignedBy.

MeasuringTicketReference will be deprecated in a future version V3R00. Use the DocumentReferenceInformation element instead.

OtherDate

OtherDate is optional. Multiple instances might exist.

A date that may not be specifically detailed within a document (example: print date at the PurchaseOrderLineItem).

MeasuringLocation

MeasuringLocation is optional. A single instance might exist.

A grouping element that contains information about where the measuring is taken place.

DeliveryInfo

DeliveryInfo is optional. A single instance might exist.

Information about the delivery.

OtherParty

OtherParty is optional. Multiple instances might exist.

An organisation or business entity other than those specifically detailed within an e-Document.

SourceProduct

SourceProduct is optional. A single instance might exist.

SourceProduct is a group element defining the product that is available for measuring.

The measuring of this product is done according to the measuring rules for the contracted product, which usually is the same product. But in some cases the product available for measuring is different from the contracted product. In these cases, the product available for measuring shall be measured according to the measuring rules for the MeasuringProduct specified in MeasuringSpecification.

For example, Pulpwood is produced but it is of very bad quality because of long time storage in the forest. This pulpwood will be sold as fire wood and shall when delivered be measured according to the measuring rules for firewood.

NumberOfPackageMeasuringInfo

NumberOfPackageMeasuringInfo is optional. A single instance might exist.

Number of reported packages by PackageMeasuringInfo.

PackageMeasuringInfo

PackageMeasuringInfo is optional. Multiple instances might exist.

A grouping element that contains information about a measured package or a measured load when the load is treated as one package.

QuantityInformation

QuantityInformation is optional. A single instance might exist.

A group item containing information about quantity and informational quantity of similar items.

MeasuringTicketSequenceLineItem

MeasuringTicketSequenceLineItem is optional. Multiple instances might exist.

A grouping element identifying a line item included within the MeasuringTicket Sequence.

NumberOfUnCompletedMeasuredItems

NumberOfUnCompletedMeasuredItems is optional. A single instance might exist.

Specifies the number of items that are uncompleted measured, i.e. some measurement values are missing for these items.

DownGradingInfo

DownGradingInfo is optional. Multiple instances might exist.

A grouping element that contains information about downgrading of products.

DeductionInfo

DeductionInfo is optional. Multiple instances might exist.

A grouping element that contains information about deductions of quantities.

QuantityByProperty

QuantityByProperty is optional. Multiple instances might exist.

A grouping element that contains specification of quantities per property value.

ChargeInformation

ChargeInformation is optional. Multiple instances might exist.

A group element that contains elements that describe a charge. ChargeInformation is used when charge details need to be specified by using a code assigned by an

agency. It is typically used for freight costs and other costs related to the supply chain.

MonetaryAdjustment

MonetaryAdjustment is optional. Multiple instances might exist.

The element containing the information necessary for the understanding, calculation, and treatment of an adjustment to a currency amount. MonetaryAdjustment contains an attribute that indicates the type of adjustment being communicated.

NetAmount

NetAmount is optional. A single instance might exist.

An element that contains the net amount excluding tax. NetAmount encapsulates CurrencyValue.

Amount

Amount is optional. A single instance might exist.

An element that contains the amount including tax. The Amount encapsulates CurrencyValue.

SafetyAndEnvironmentalInformation

SafetyAndEnvironmentalInformation is optional. Multiple instances might exist.

Name of certification type, if any, on the goods (For example, FSC, PEFC). SafetyAndEnvironmental needs a value or measurement to communicate the percentage of the product is certified (for example, 75% is certified by the indicated agency).

eAttachment

eAttachment is optional. A single instance might exist.

eAttachment enables the sender to provide information about attachments to the document.

- Note: An element "e-Attachment" also exists. papiNet will no longer use hyphens in our element and attribute names as this causes issues with BizTalk.

AdditionalItemInfo

AdditionalItemInfo is optional. Multiple instances might exist.

A grouping element that contains information about additional items specified by an agency. Restricted use of this element is recommended.

AdditionalText

AdditionalText is optional. Multiple instances might exist.

A text field that is used to communicate information not previously defined or for special instructions. To be used only for circumstances not covered by specific elements.

BusinessChainInfo

BusinessChainInfo is optional. A single instance might exist.

A grouping element that contains information about parties in the business chain when products or services are traded in many levels.

The business chain starts at the sourcing end where products are provided when BusinessChainContextType = Product.

The business chain starts at the purchasing of a service from the OriginalLogisticsSupplier when BusinessChainContextType = LogisticsService.

PartlyMeasuredObjectInfo

PartlyMeasuredObjectInfo is optional. A single instance might exist.

A grouping element containing information about an object that is partly measured during several measuring events. Measuring information reported is per measuring event, when element PartlyMeasuredObjectInfo is used.

N.B. After that measuring is completed, summary measuring information for all measuring events can be reported as a normal measuring event of the object, i.e. PartlyMeasuredObjectInfo is not used.

MeasuringTicketSequenceLineItem

A grouping element identifying a line item included within the MeasuringTicket Sequence.

MeasuringComplete [attribute]

MeasuringComplete is optional. A single instance might exist.

Indicates that measuring is completed for a particular item.

MeasuringTicketSequenceLineItem

Refer to MeasuringComplete definition for any enumerations.

(sequence)

The sequence of items below is mandatory. A single instance is required.

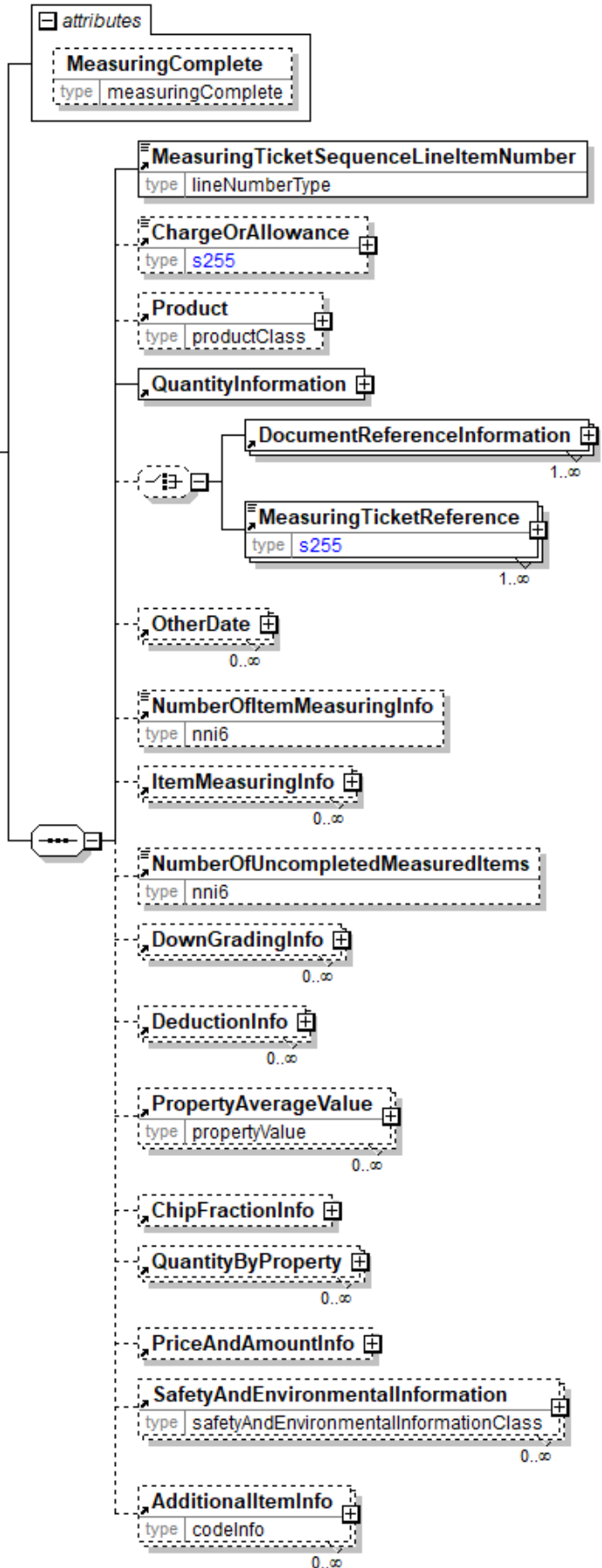

MeasuringTicketSequenceLineNumber

MeasuringTicketSequenceLineNumber is mandatory. A single instance is required.

A sequential number that uniquely identifies the line item of the MeasuringTicketSequence.

ChargeOrAllowance

ChargeOrAllowance is optional. A single instance might exist.

The description of the charge or allowance; such as freight, special handling, and stop-off handling.

Product

Product is optional. A single instance might exist.

Product is a group item defining the article and its characteristics. Product is used to specify product characteristics organized by ProductIdentifier, ProductDescription, and Classification. Book Manufacturing, Label Stock, Paper, Pulp, Recovered Paper, Wood Products, and Virgin Fibre market segments have defined their product characteristics and conversion features for implementation in papiNet.

QuantityInformation

QuantityInformation is mandatory. A single instance is required.

A group item containing information about quantity and informational quantity of similar items.

(choice)

[choice] is optional. A single instance might exist.

DocumentReferenceInformation

DocumentReferenceInformation is mandatory. One instance is required, multiple instances might exist.

A group item containing reference information applicable to a document.

MeasuringTicketReference

MeasuringTicketReference is mandatory. One instance is required, multiple instances might exist.

An element detailing relevant references pertaining to the MeasuringTicket as indicated by MeasuringTicketReferenceType and AssignedBy.

MeasuringTicketReference will be deprecated in a future version V3R00. Use the DocumentReferenceInformation element instead.

OtherDate

OtherDate is optional. Multiple instances might exist.

A date that may not be specifically detailed within a document (example: print date at the PurchaseOrderLineItem).

NumberOfItemMeasuringInfo

NumberOfItemMeasuringInfo is optional. A single instance might exist.

Number of reported items by ItemMeasuringInfo.

ItemMeasuringInfo

ItemMeasuringInfo is optional. Multiple instances might exist.

A grouping element that contains information about measured items.

NumberOfUnCompletedMeasuredItems

NumberOfUnCompletedMeasuredItems is optional. A single instance might exist.

Specifies the number of items that are uncompleted measured, i.e. some measurement values are missing for these items.

DownGradingInfo

DownGradingInfo is optional. Multiple instances might exist.

A grouping element that contains information about downgrading of products.

DeductionInfo

DeductionInfo is optional. Multiple instances might exist.

A grouping element that contains information about deductions of quantities.

PropertyAverageValue

PropertyAverageValue is optional. Multiple instances might exist.

Specifies an average value for a property for a number of items. The property is defined by the attribute PropertyType. The attribute MeasuringMethod and MeasuringAgency can be used to clarify details for a how a property is measured or calculated, e.g. Diameter for a saw log can be measured "Under Bark" or "Over Bark". The attribute MeasuringMethodType defines how the value is created, e.g. measured automatically, calculated etc.

PropertySubValue can specify a value for a property related to the property specified by the attribute PropertyType of PropertyAverageValue.

ChipFractionInfo

ChipFractionInfo is optional. A single instance might exist.

Grouping element that contains information about analysis of chip fractions.

QuantityByProperty

QuantityByProperty is optional. Multiple instances might exist.

A grouping element that contains specification of quantities per property value.

PriceAndAmountInfo

PriceAndAmountInfo is optional. A single instance might exist.

A grouping element that contains information about price and amounts.

SafetyAndEnvironmentalInformation

SafetyAndEnvironmentalInformation is optional. Multiple instances might exist.

Name of certification type, if any, on the goods (For example, FSC, PEFC). SafetyAndEnvironmental needs a value or measurement to communicate the percentage of the product is certified (for example, 75% is certified by the indicated agency).

AdditionalItemInfo

AdditionalItemInfo is optional. Multiple instances might exist.

A grouping element that contains information about additional items specified by an agency. Restricted use of this element is recommended.

MeasuringTicketSequenceLineItemNumber

A sequential number that uniquely identifies the line item of the MeasuringTicketSequence.

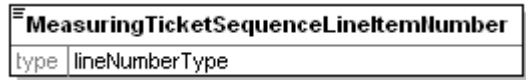

MeasuringTicketSequenceNumber

A sequential number that uniquely identifies the sequence in a MeasuringTicket e-Document.



MeasuringTicketStatusType [attribute]

Identifies the status of the entire MeasuringTicket e-Document.



This item is restricted to the following list.

Cancelled

The supplied information has been cancelled. Items that have been cancelled are not included in totals on the summary levels of the e-Document.

Original

The supplied information is the first version of that information.

Replaced

The supplied information is replacing earlier supplied information. The receiver should revalidate the information in their system based upon the entire information received.

MeasuringTicketSummary

A grouping element that contains summary information that applies to the entire MeasuringTicket e-Document.

(sequence)

The sequence of items below is mandatory. A single instance is required.

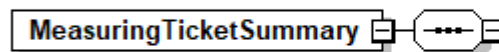

TotalNumberOfSequences

TotalNumberOfSequences is optional. A single instance might exist.

The total number of sequences in the document.

TotalQuantityInformation

TotalQuantityInformation is optional. Multiple instances might exist.

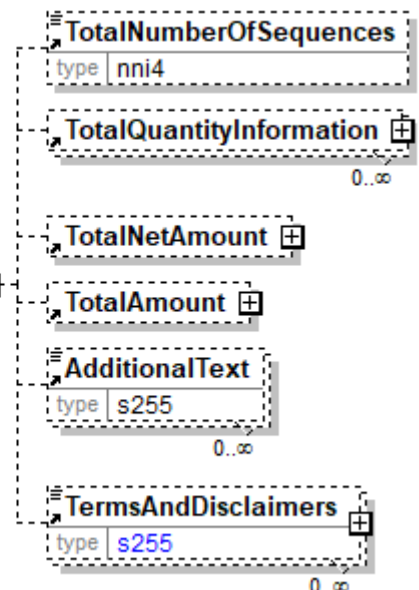

papiNet V2R31

A group item containing information about the total quantity and total informational quantity of similar items in the document.

TotalNetAmount

TotalNetAmount is optional. A single instance might exist.

A field containing total amount excluding tax. For example, in the Invoice TotalNetAmount is equal to the sum of LineItemSubTotal plus TotalAdjustments. TotalNetAmount encapsulates CurrencyValue.

TotalAmount

TotalAmount is optional. A single instance might exist.

The total amount including tax (when tax is specified in the e-Document).

In e-Documents claiming payment this is the amount due for payment based on the terms of payment. Decimal rounding might be applied to this amount.

AdditionalText

AdditionalTexts is optional. Multiple instances might exist.

A text field that is used to communicate information not previously defined or for special instructions. To be used only for circumstances not covered by specific elements.

TermsAndDisclaimers

TermsAndDisclaimers is optional. Multiple instances might exist.

An element that contains legal information with an indication of what the Language is.

MeasuringTicketType [attribute]

MeasuringTicketType defines the type of MeasuringTicket.

MeasuringTicketType
type measuringTicketType

This item is restricted to the following list.

ArrivalTicket

A MeasuringTicketType that contains information about rough measurements done upon arrival of a transport vehicle to a measuring location. For example used for updating physical location of the load and calculating compensation to the carrier.

CalibrationCheckLog

A MeasuringTicketType that contains a check log with information about calibration of measuring equipment.

InvoiceSpecification

A MeasuringTicketType that contains information about measured products including prices and amounts. This MeasuringTicketType is normally used as a detailed specification of billable or invoiced products.

MeasuringTicket

A MeasuringTicketType that contains detailed information about measured products and items. This information can be used as a base for calculation of billable products.

ProductionTicket

A MeasuringTicketType that contains information about produced products and items. A ProductionTicket can also contain measuring information for produced items.

PropertyTicket

A MeasuringTicketType that contains detailed information about calculated or measured properties of a SourceProduct not related to a specific delivery.

It typically consolidates property information over a time period, measuring location and other attributes defined in an InfoRequest or otherwise agreed between partners.

ReceptionTicket

A MeasuringTicketType that contains information about reception verification done upon arrival of a transport. For example, the load can be verified that it only contains proper products and that it doesn't contain any forbidden foreign objects. Based on the verification the load can be accepted or rejected.

SalesCatalogue

A MeasuringTicketType that contains information about measurements of products for sale. For example used for sending information about logs at roadside or standing trees for sale.

SampleMeasuringTicket

A MeasuringTicketType that contains detailed information about measured samples taken from e.g. a delivery.

MeasuringType [attribute]

Specifies how detailed the measurements are done.

This item is restricted to the following list.

MeasuringType	
type	measuringType

ByItem

Each item is measured separately, e.g. logs on a truck load.

ByItemOrByPackage

Measurements may be carried out by item or by package. If a measuring location can handle both types then by item is normally used.

ByLoad

The whole load is measured as one unit, e.g. a load carried by several transport units is measured as one unit.

ByPackage

Each package is measured separately, e.g. packages on a truck load or a roadside logpile.

ByPackageAndItem

Measurements are carried on both packages and items. A package can in some cases be virtual, e.g. a log composed of several virtual log segments can be regarded as a virtual package for the log segments.

ByPackageOrByLoad

Measurements may be carried out by package or by load. If a measuring location can handle both types then by package is normally used.

ByTransportUnit

The load on each transport unit is measured as one unit, e.g. loads on railcars.

MeasuringUnitBrandAndModel

A grouping element containing information about brand and model for a measuring unit.

(sequence)

The sequence of items

below is mandatory. A single instance is required.

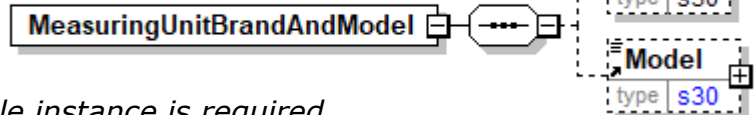

Brand

Brand is optional. A single instance might exist.

Specifies a trade name for an item. E.g. the brand name of a transport vehicle, the brand name of a material etc.

Model

Model is optional. A single instance might exist.

Specifies the model of an item. E.g. the model of a transport vehicle.

MeasuringUnitIdentifier

The identifier of a measuring unit, e.g. the identifier of a Forest Harvester. The type of identifier is indicated by the attribute MeasuringUnitIdentifierType.

MeasuringUnitIdentifierType [attribute]

MeasuringUnitIdentifierType is mandatory. A single instance is required.

Provides a contextual definition for the value used to identify the measuring unit.

Refer to MeasuringUnitIdentifierType definition for any enumerations.

Agency [attribute]

Agency is optional. A single instance might exist.

Describes the agency maintaining the list of codes. To be included in this list the agency must be a recognized standards body or industry organisation.

- For the element that owns this attribute.
- For another attribute in the list of attributes associated with the parent element.

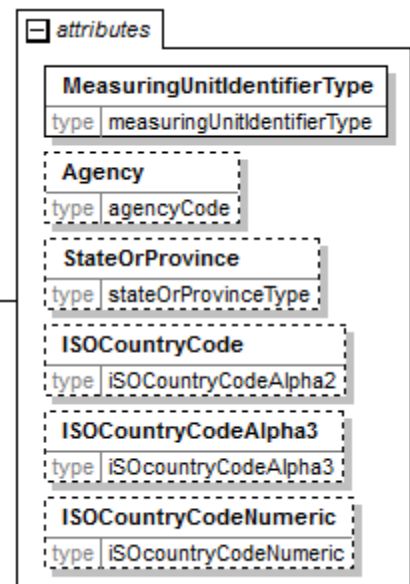
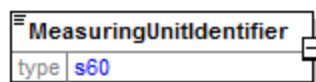

Refer to Agency definition for any enumerations.

StateOrProvince [attribute]

StateOrProvince is optional. A single instance might exist.

The political designation or boundary of a specific area of land.

ISOCountryCode [attribute]

ISOCountryCode is optional. A single instance might exist.

The valid Alpha 2-character list of officially assigned country codes in the ISO 3166-1 international standard.

Information on the content of this attribute is available at:

<https://www.iso.org/obp/ui/#search>

ISOCountryCodeAlpha3 [attribute]

ISOCountryCodeAlpha3 is optional. A single instance might exist.

The valid Alpha 3-character list of officially assigned country codes in the ISO 3166-1 international standard.

Information on the content of this attribute is available at:

<https://www.iso.org/obp/ui/#search>

ISOCountryCodeNumeric [attribute]

ISOCountryCodeNumeric is optional. A single instance might exist.

The valid Numeric 3-digit list of officially assigned country codes in the ISO 3166-1 international standard.

Information on the content of this attribute is available at:

<https://www.iso.org/obp/ui/#search>

MeasuringUnitIdentifierType [attribute]

Provides a contextual definition for the value used to identify the measuring unit.

This item is restricted to the following list.

AssignedByAgencyID

A unique identifier that has been assigned by the agency given in the attribute Agency. Attribute Agency is mandatory when AssignedByAgencyID is used.

AssignedByMachineOwnerID

A unique identifier that has been assigned by the owner of the machine.

LicencePlateNumber

A licence plate number issued by an official authority.

MachineID

A globally unique identifier for the machine. It is an identifier belonging to the machine independent of the owner of the machine, e.g. a GUID number.

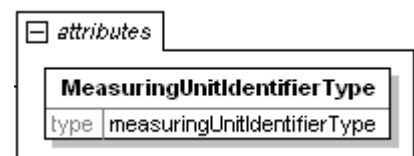

MechanicalMaterial

Mechanical material information

(sequence)

The sequence of items below is mandatory. A single instance is required.

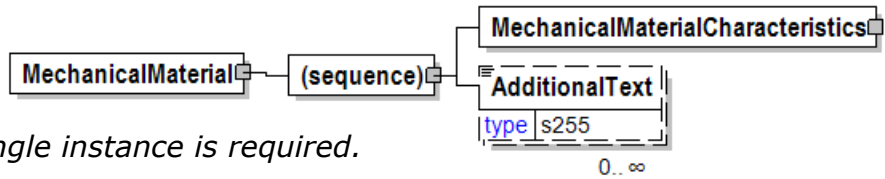

MechanicalMaterialCharacteristics

MechanicalMaterialCharacteristics is mandatory. A single instance is required.

Mecahnical material characteristics.

AdditionalText

AdditionalText is optional. Multiple instances might exist.

A text field that is used to communicate information not previously defined or for special instructions. To be used only for circumstances not covered by specific elements.

MechanicalMaterialCharacteristics

Mecahnical material characteristics.

(sequence)

The sequence of items below is mandatory. A single instance is required.

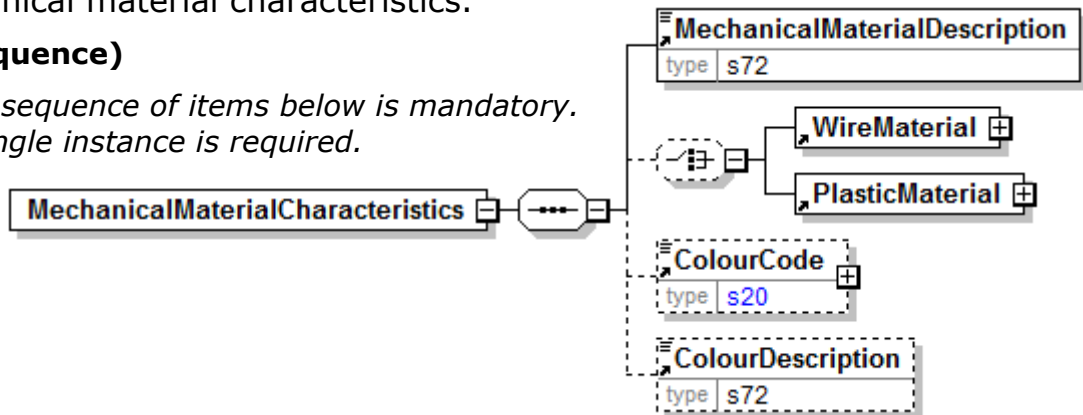

MechanicalMaterialDescription

MechanicalMaterialDescription is mandatory. A single instance is required.

Mechanical material description

(choice)

[choice] is optional. A single instance might exist.

WireMaterial

WireMaterial is mandatory. A single instance is required.

Wire Material

PlasticMaterial

PlasticMaterial is mandatory. A single instance is required.

Describes the plastic used in the process.

ColourCode

ColourCode is optional. A single instance might exist.

A code indicating the colour.

ColourDescription

ColourDescription is optional. A single instance might exist.

A free form description of the colour.

MechanicalMaterialDescription

Mechanical material description

MechanicalMaterialDescription	
type	s72

Media

Media.

MasterSource [attribute]

MasterSource is optional. A single instance might exist.

The source of the master

Refer to MasterSource definition for any enumerations.

(sequence)

The sequence of items below is mandatory. A single instance is required.

TotalRunningLength

TotalRunningLength is optional. A single instance might exist.

Summary value of amount measured in running meters, etc.

TotalNumberOfUnits

TotalNumberOfUnits is optional. A single instance might exist.

The total number of units.

MasterStorageOption

MasterStorageOption is optional. A single instance might exist.

Master storage option

(choice)

[choice] is mandatory. A single instance is required.

AudioCassette

AudioCassette is mandatory. One instance is required, multiple instances might exist.

Audio cassette

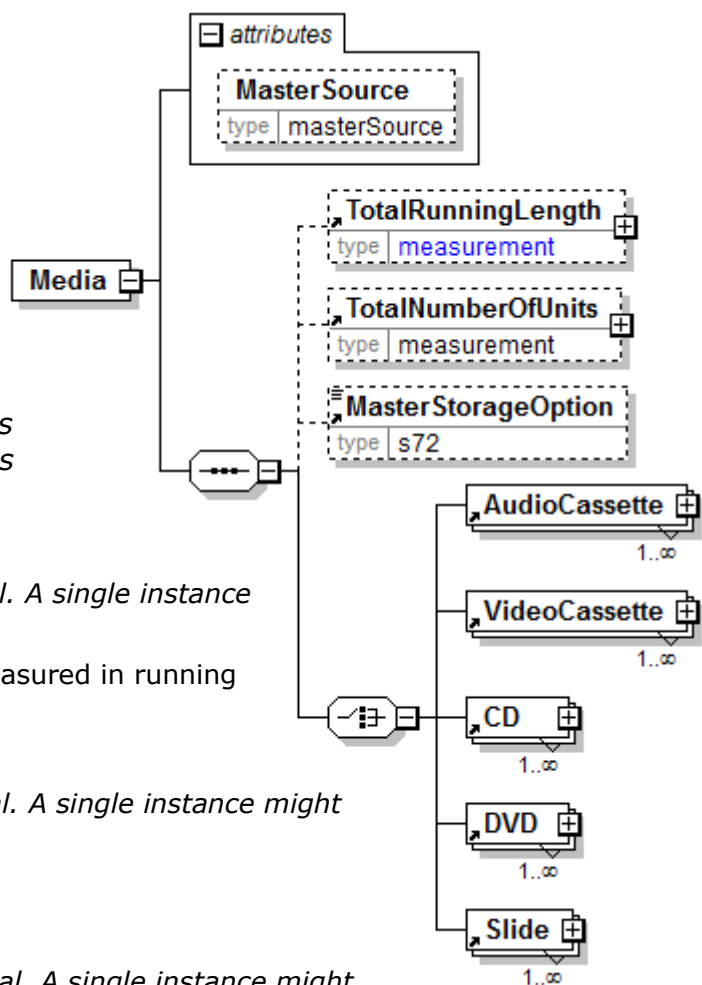

papiNet V2R31

VideoCassette

VideoCassette is mandatory. One instance is required, multiple instances might exist.

Video cassette information.

CD

CD is mandatory. One instance is required, multiple instances might exist.

CD

DVD

DVD is mandatory. One instance is required, multiple instances might exist.

DVD

Slide

Slide is mandatory. One instance is required, multiple instances might exist.

Slide

MediaLength

Media length

(sequence)

The sequence of items below is mandatory. A single instance is required.

TotalTime

TotalTime is optional. A single instance might exist.

The total time.

SideOneTime

SideOneTime is optional. A single instance might exist.

The time for side one.

SideTwoTime

SideTwoTime is optional. A single instance might exist.

The time for side two.

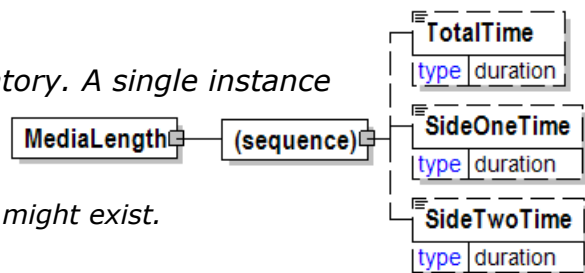

MediaType [attribute]

The type of media

This item is restricted to the following list.

CD

Compact Disk

DVD

Digital Video Disk

Electronic

Jaz

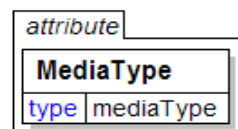

High capacity storage media

Syquest

A removable hard disk drive that is connected to the computer via a SCSI interface.

Zip

Other

MerchantParty

This named party represents the merchant involved in the business transaction. This party is only used in the communication of OrderStatus otherwise it is handled via OtherParty.

LogisticsRole [attribute]

LogisticsRole is optional. A single instance might exist.

Communicates the nature of the logistics role, if any, the party plays in the transaction.

Refer to LogisticsRole definition for any enumerations.

(sequence)

The sequence of items below is mandatory. A single instance is required.

PartyIdentifier

PartyIdentifier is optional. Multiple instances might exist.

A unique identifier of a specific party. This element contains an attribute PartyIdentifierType that indicates the type of the identifier.

NameAddress

NameAddress is mandatory. A single instance is required.

A group item containing name and address of an organisation or business entity.

URL

URL is optional. A single instance might exist.

Universal Resource Locator. While typically a web address you could use this field to hold an email address.

CommonContact

CommonContact is optional. Multiple instances might exist.

Identifies a specific individual associated with the party.

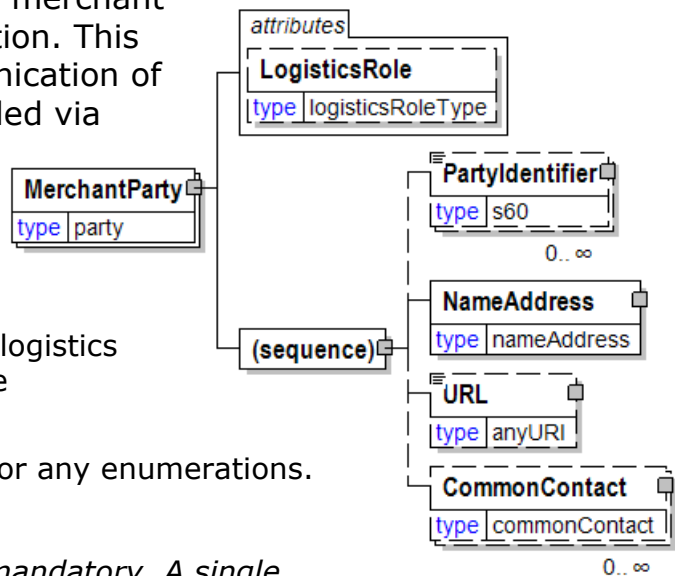

Method [attribute]

An attribute of the shipment method of payment, which defines the responsibilities of buyers and sellers for delivery under a sales contract.

It especially determines the obligations of the seller and the buyer regarding the payment of the freight costs.

This item is restricted to the following list.

CollectFreight

Customer pays and bears all freight charges.

CollectFreightAndAllowed

Customer pays freight charges and deducts the amount from the seller's Invoice.

CollectFreightCreditedBackToCustomer

Defines the difference between the invoice freight cost and the allowance by the mill. This can be a credit or a debit to the customer.

CustomerPickupBackhaul

Specifies that the carrier who is doing the delivery can pick a return load.

Pickup

Specifies that the customer will pick up the goods; in other words, the goods transport is organised by the buyer who will therefore pay for the freight.

PrepaidButChargedToCustomer

Specifies that the freight costs will be prepaid by the seller but will be charged back to the buyer.

PrepaidBySeller

Specifies that the seller will prepay the freight costs.

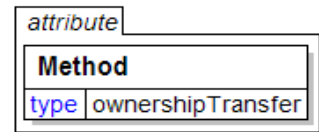

MethodOfPayment

The manner in which payment is to be transmitted to the seller.

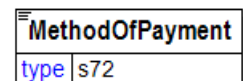

MillCharacteristics

A group item defining the mill party and machine identifier where a product is or was produced.

(sequence)

The sequence of items below is mandatory. A single instance is

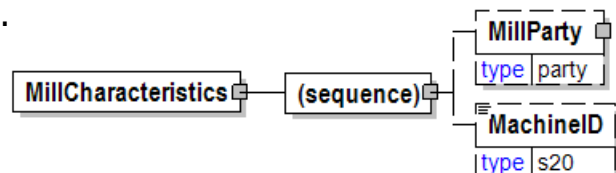

required.

MillParty

MillParty is optional. A single instance might exist.

The organisation or business entity that actually produces the product.

MachineID

MachineID is optional. A single instance might exist.

An identifier assigned to the particular machine being referenced. For example, a machine could be a paper machine, an off-line coater, a sheeter, or a printing press. The particular machine being referenced will be determined by the business event being supported.

MillJoinLocation

A group element detailing the location of each mill join in a reel. The element `DeliveryMessageReelCharacteristics/NumberOfMillJoins` gives the total number of joins in a reel.

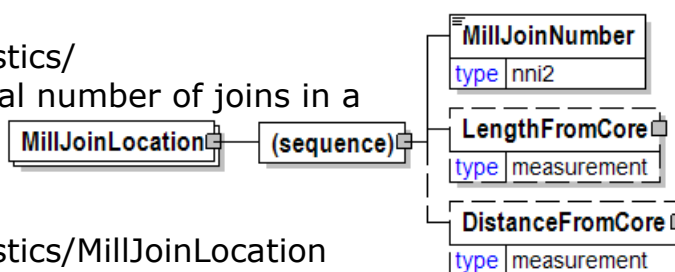

`DeliveryMessageReelCharacteristics/MillJoinLocation` would be repeated the `NumberOfMillJoin` times.

(sequence)

The sequence of items below is mandatory. A single instance is required.

MillJoinNumber

MillJoinNumber is mandatory. A single instance is required.

A sequential number that identifies each mill join in a reel. The element `DeliveryMessageReelCharacteristics/NumberOfMillJoins` gives the total number of joins in a reel.

LengthFromCore

LengthFromCore is optional. A single instance might exist.

In relationship to a paper event (usually a mill join) where is the event in terms of the length of the paper.

DistanceFromCore

DistanceFromCore is optional. A single instance might exist.

The distance from the radius of the core. This element can be used to communicate where a mill join is located. Compare to `LengthFromCore`.

MillJoinNumber

A sequential number that identifies each mill join in a reel. The element `DeliveryMessageReelCharacteristics/NumberOfMillJoins` gives the total number of joins in a reel.

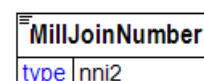

MillOrderInformation

A group item containing information unique to a mill order.

(sequence)

The sequence of items below is mandatory. A single instance is required.

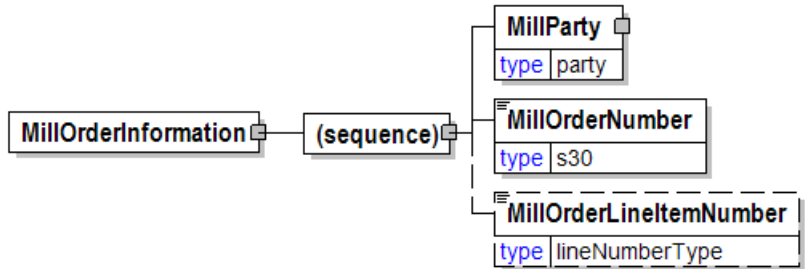

MillParty

MillParty is mandatory. A single instance is required.

The organisation or business entity that actually produces the product.

MillOrderNumber

MillOrderNumber is mandatory. A single instance is required.

The manufacturing order number the mill uses.

MillOrderLineItemNumber

MillOrderLineItemNumber is optional. A single instance might exist.

A number that uniquely identifies the line items of the Mill Order.

MillOrderLineItemNumber

A number that uniquely identifies the line items of the Mill Order.

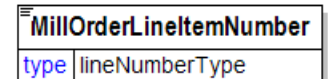

MillOrderNumber

The manufacturing order number the mill uses.

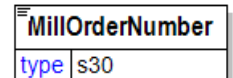

MillParty

The organisation or business entity that actually produces the product.

LogisticsRole [attribute]

LogisticsRole is optional. A single instance might exist.

Communicates the nature of the logistics role, if any, the party plays in the transaction.

Refer to LogisticsRole definition for any enumerations.

(sequence)

The sequence of items below is mandatory. A single instance is required.

PartyIdentifier

PartyIdentifier is optional. Multiple instances might exist.

A unique identifier of a specific party. This element contains an attribute PartyIdentifierType that indicates the type of the identifier.

NameAddress

NameAddress is mandatory. A single instance is required.

A group item containing name and address of an organisation or business entity.

URL

URL is optional. A single instance might exist.

Universal Resource Locator. While typically a web address you could use this field to hold an email address.

CommonContact

CommonContact is optional. Multiple instances might exist.

Identifies a specific individual associated with the party.

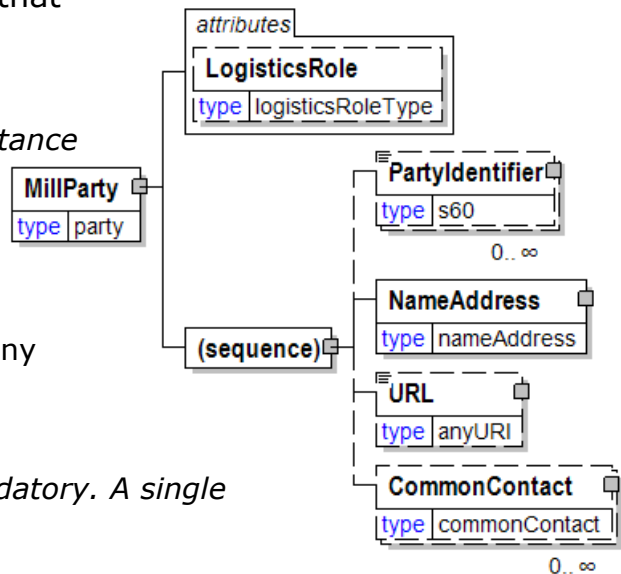

MillProductionInformation

A grouping element that contains information about production at the mill.

(sequence)

The sequence of items below is mandatory. A single instance is required.

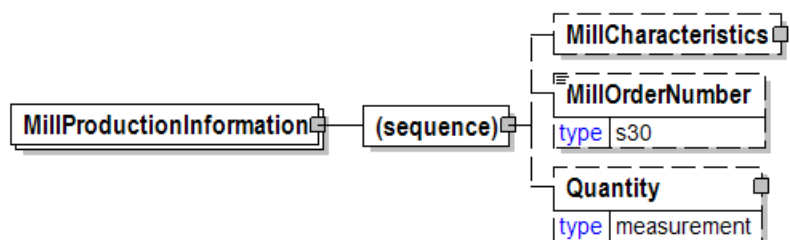

MillCharacteristics

MillCharacteristics is optional. A single instance might exist.

A group item defining the mill party and machine identifier where a product is or was produced.

MillOrderNumber

papiNet V2R31

MillOrderNumber is optional. A single instance might exist.

The manufacturing order number the mill uses.

Quantity

Quantity is optional. A single instance might exist.

The Quantity element contains attributes that provide information about the type of quantity that is being communicated, the context in which the particular quantity is to be viewed, and (if the quantity represents an adjustment) an adjustment type.

The Quantity element contains three child elements that enable you to communicate a range of values for the quantity and a target or actual value. It is at this level (Value, RangeMin, and RangeMax) that the unit of measure is specified. This permits the range to be specified in a different unit of measure than the target.

Millwork

A placeholder for the further definition of millwork items.

(sequence)

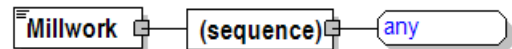

The sequence of items below is mandatory. A single instance is required.

[Any Type]

Any type of content is permitted at this point.

MinCurrencyValue

The lower range of the allowed currency amount.

CurrencyType [attribute]

CurrencyType is optional. A single instance might exist.

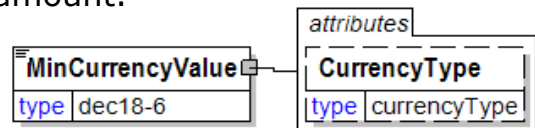

A three-character ISO 4217 currency code in capital letters. The ISO standard classification for currencies. Refer to the ISO standard for information about the choices for the attribute's enumerations.

<https://www.iso.org/iso-4217-currency-codes.html>

MinimumOrderQuantity

The minimum amount that can be ordered on a PurchaseOrder.

(sequence)

The sequence of items below is mandatory. A single instance is required.

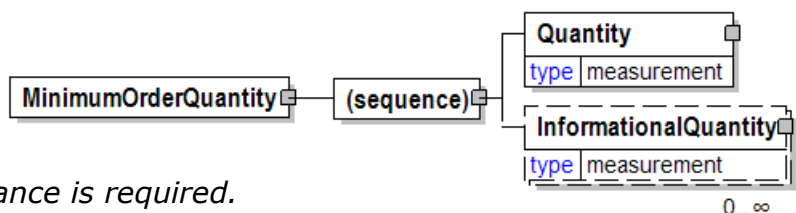

Quantity

Quantity is mandatory. A single instance is required.

The Quantity element contains attributes that provide information about the type of quantity that is being communicated, the context in which the particular quantity is

papiNet V2R31

to be viewed, and (if the quantity represents an adjustment) an adjustment type.

The Quantity element contains three child elements that enable you to communicate a range of values for the quantity and a target or actual value. It is at this level (Value, RangeMin, and RangeMax) that the unit of measure is specified. This permits the range to be specified in a different unit of measure than the target.

InformationalQuantity

InformationalQuantity is optional. Multiple instances might exist.

A quantity given in a valid UOM used for information purposes only (not for calculation). For example, an ordered quantity was 100 reels as opposed to the invoice quantity of 20,000 pounds.

Minutes

A qualifier for the DeliveryTransitTime.

Minutes	
type	nni6

MixedProductPalletIndicator [attribute]

Specifies whether a product can be mixed with other products on the same pallet.

This item is restricted to the following list.

Yes

No

attribute	
MixedProductPalletIndicator	
type	yesNo
default	No

MixProductIndicator [attribute]

Specifies whether a product can be mixed with other products on the same shipment.

This item is restricted to the following list.

Yes

No

attribute	
MixProductIndicator	
type	yesNo
default	No

MobilePhone

The mobile phone number of the individual associated with the ContactName.

MobilePhone	
type	phoneNumber

Model

Specifies the model of an item. E.g. the model of a transport vehicle.

ModelYear [attribute]

ModelYear is optional. A single instance might exist.

Specifies the year assigned to the model of an item.

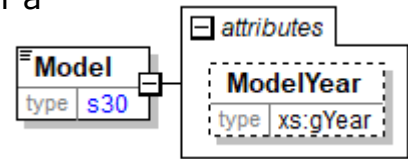

ModelYear [attribute]

Specifies the year assigned to the model of an item.

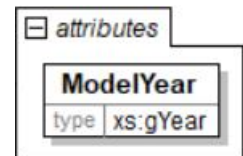

ModulusElasticity [attribute]

Modulus elasticity

This item is restricted to the following list.

1.0E

1.1E

1.2E

1.3E

1.4E

1.5E

1.6E

1.7E

1.8E

1.9E

2.0E

2.1E

2.2E

2.3E

2.4E

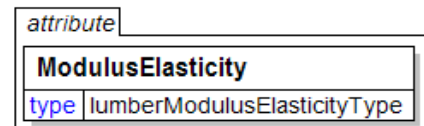

Moisture

Desired percentage, or other indicator, of water in the product at the time of shipment.

TestMethod [attribute]

TestMethod is optional. A single instance might exist.

The method used to determine the results of the test under consideration.

TestAgency [attribute]

TestAgency is optional. A single instance might exist.

The agency that has set the parameters for the testing

Refer to TestAgency definition for any enumerations.

SampleType [attribute]

SampleType is optional. A single instance might exist.

Communicates how sampling was done to measure the product characteristics.

Refer to SampleType definition for any enumerations.

ResultSource [attribute]

ResultSource is optional. A single instance might exist.

Used to define the data source of the specified test

Refer to ResultSource definition for any enumerations.

(sequence)

The sequence of items below is mandatory. A single instance is required.

DetailValue

DetailValue is mandatory. A single instance is required.

A numeric value expressed in the unit of measure (UOM).

DetailRangeMin

DetailRangeMin is optional. A single instance might exist.

The minimum value (lower boundary) allowed for the DetailValue that is the parent of this element.

DetailRangeMax

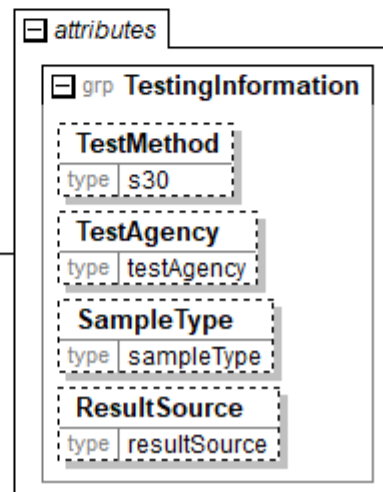
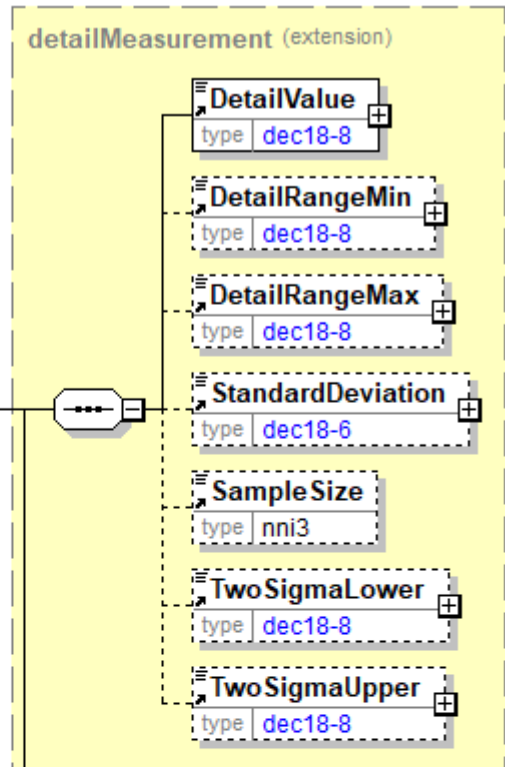
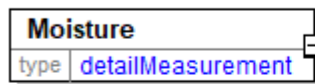

DetailRangeMax is optional. A single instance might exist.

The maximum value (upper boundary) allowed for the DetailValue that is the parent of this element.

StandardDeviation

StandardDeviation is optional. A single instance might exist.

A statistic used as a measure of dispersion in a distribution.

SampleSize

SampleSize is optional. A single instance might exist.

The number of samples used to determine the product characteristic in question.

TwoSigmaLower

TwoSigmaLower is optional. A single instance might exist.

Two sigma (a measure of dispersion associated with standard deviation) on the lower side of the standard deviation.

TwoSigmaUpper

TwoSigmaUpper is optional. A single instance might exist.

Two sigma (a measure of dispersion associated with standard deviation) on the upper side of the standard deviation.

MoistureContent

Defines the moisture content percentage of the product.

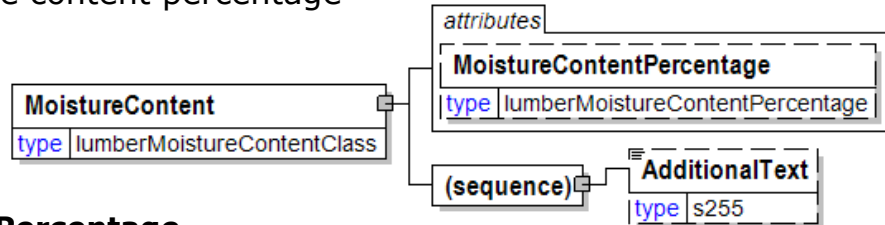

MoistureContentPercentage **[attribute]**

MoistureContentPercentage is optional. A single instance might exist.

Defines the percentage moisture content to which the product has been dried. Refer to MoistureContentPercentage definition for any enumerations.

(sequence)

The sequence of items below is mandatory. A single instance is required.

AdditionalText

AdditionalText is optional. A single instance might exist.

A text field that is used to communicate information not previously defined or for special instructions. To be used only for circumstances not covered by specific elements.

MoistureContentPercentage [attribute]

Defines the percentage moisture content to which the product has been dried.

This item is restricted to the following list.

attribute

MoistureContentPercentage

type | lumberMoistureContentPercentage

1

2

3

4

5

6

7

8

9

10

11

12

13

14

15

16

18

19

20

21

22

23

Other

MonetaryAdjustment

The element containing the information necessary for the understanding, calculation, and treatment of an adjustment to a currency amount. MonetaryAdjustment contains an attribute that indicates the type of adjustment being communicated.

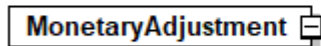

AdjustmentType [attribute]

AdjustmentType is mandatory. A single instance is required.

Describes the type of adjustment applied to a monetary oriented element. Adjustment values should always be given as negative or positive adjustments even if AdjustmentType indicates the sign. For example, a rebate of 1% on an invoice should be given as an adjustment percentage of -1%.

Refer to AdjustmentType definition for any enumerations.

(sequence)

The sequence of items below is mandatory. A single instance is required.

MonetaryAdjustmentLine

MonetaryAdjustmentLine is mandatory. A single instance is required.

A sequence number indicating the order of printing or the sequence in which a group of adjustments are to be considered.

MonetaryAdjustmentComponent

MonetaryAdjustmentComponent is optional. Multiple instances might exist.

A group item that contains information for specifying a monetary adjustment component by a code assigned by an agency.

MonetaryAdjustmentStartAmount

MonetaryAdjustmentStartAmount is optional. A single instance might exist.

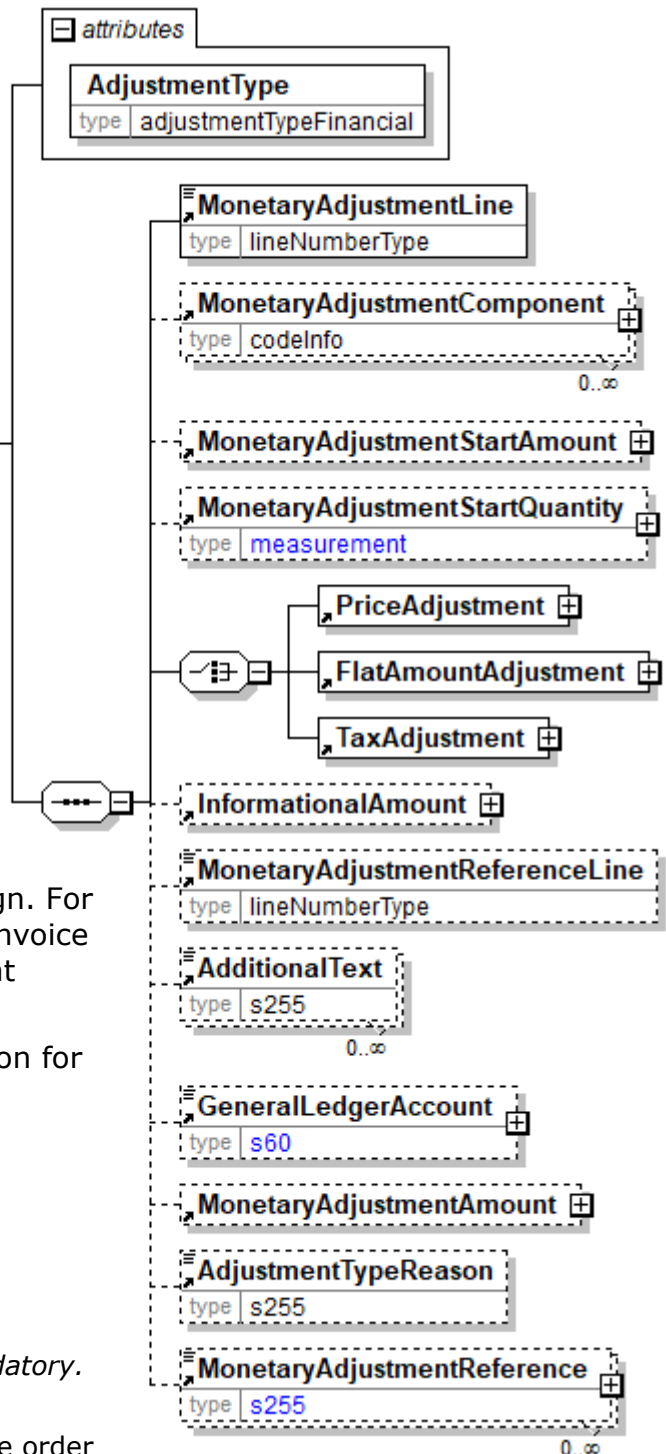

papiNet V2R31

The beginning currency amount used in the calculation of a monetary adjustment.

MonetaryAdjustmentStartQuantity

MonetaryAdjustmentStartQuantity is optional. A single instance might exist.

The beginning quantity used in the calculation of a monetary adjustment.

(choice)

[choice] is mandatory. A single instance is required.

PriceAdjustment

PriceAdjustment is mandatory. A single instance is required.

A group item defining a deviation from the PricePerUnit.

FlatAmountAdjustment

FlatAmountAdjustment is mandatory. A single instance is required.

A group item that contains flat adjustment amount information.

TaxAdjustment

TaxAdjustment is mandatory. A single instance is required.

This content element contains the necessary information to describe, calculate, and handle a tax adjustment.

InformationalAmount

InformationalAmount is optional. A single instance might exist.

A monetary amount used for information purposes only (not for calculation). For example, the invoice price adjustment subtotal is expressed in sterling pounds, and the buyer wants this information expressed in U.S. dollars.

CreditDebitNote and Invoice - The TaxAmount is displayed in the currency that is applicable throughout the e-Document. When a TaxAmount needs to be displayed in a different national currency, this field is used.

MonetaryAdjustmentReferenceLine

MonetaryAdjustmentReferenceLine is optional. A single instance might exist.

A link to a previously defined MonetaryAdjustmentLine upon which this adjustment is based.

AdditionalText

AdditionalText is optional. Multiple instances might exist.

A text field that is used to communicate information not previously defined or for special instructions. To be used only for circumstances not covered by specific elements.

GeneralLedgerAccount

GeneralLedgerAccount is optional. A single instance might exist.

The general ledger account to be referenced for the item.

MonetaryAdjustmentAmount

MonetaryAdjustmentAmount is optional. A single instance might exist.

The actual amount of the monetary adjustment.

AdjustmentTypeReason

AdjustmentTypeReason is optional. A single instance might exist.

Provides additional information about the type of adjustment. Can be viewed as a

sub-classification of the adjustment type attribute or as a textual explanation.

MonetaryAdjustmentReference

MonetaryAdjustmentReference is optional. Multiple instances might exist.

An element detailing relevant references pertaining to the MonetaryAdjustment as indicated by MonetaryAdjustmentReferenceType and AssignedBy.

MonetaryAdjustmentAmount

The actual amount of the monetary adjustment.

(sequence)

The sequence of items

below is mandatory. A single instance is required.

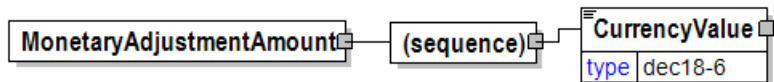

CurrencyValue

CurrencyValue is mandatory. A single instance is required.

The amount in the referenced currency as defined by the CurrencyType attribute.

MonetaryAdjustmentComponent

A group item that contains information for specifying a monetary adjustment component by a code assigned by an agency.

Agency [attribute]

Agency is

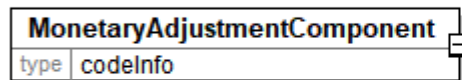

mandatory. A single instance is required.

Describes the agency maintaining the list of codes. To be included in this list the agency must be a recognized standards body or industry organisation.

- For the element that owns this attribute.
- For another attribute in the list of attributes associated with the parent element.

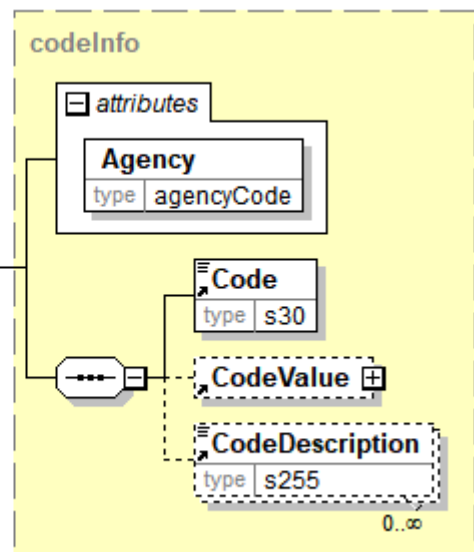

Refer to Agency definition for any enumerations.

(sequence)

The sequence of items below is mandatory. A single instance is required.

Code

Code is mandatory. A single instance is required.

Specifies a code that is defined by an agency. The agency is given for the whole construct containing the code.

CodeValue

CodeValue is optional. A single instance might exist.

A grouping element specifying a value belonging to a code that is defined by an agency.

CodeDescription

CodeDescription is optional. Multiple instances might exist.

A textual description for the meaning of a code that is defined by an agency. When the Code is associated with a CodeValue of type TextValue, then the CodeDescription is a textual description of both the Code and the TextValue.

MonetaryAdjustmentLine

A sequence number indicating the order of printing or the sequence in which a group of adjustments are to be considered.

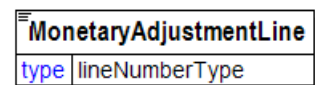

MonetaryAdjustmentReference

An element detailing relevant references pertaining to the

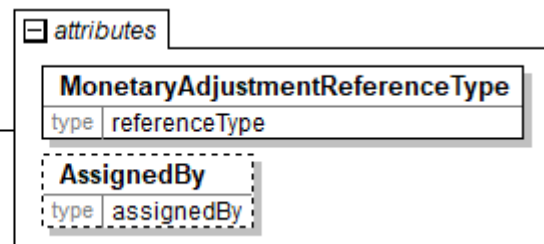
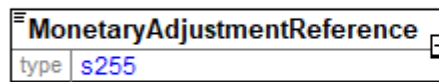

MonetaryAdjustment as indicated by MonetaryAdjustmentReferenceType and AssignedBy.

MonetaryAdjustmentReferenceType [attribute]

Provides a contextual explanation of the specific reference identifier. Many items are currently prefixed by "Buyer", "Forwarder", "Manufacturer", "Mill", "Seller", "Supplier", "Warehouse" or "Vendor". Check for an existing non-prefixed version and use the non-prefixed version instead. In the (yet to be announced release date) version 3.0 the prefixed versions will be removed. Instead the attribute AssignedBy will communicate the information previously communicated in the prefix.

Refer to MeasuringTicketReferenceType definition for any enumerations.

AssignedBy [attribute]

AssignedBy is optional. A single instance might exist.

Identifies the type of party or the agency that has assigned the associated item, e.g. a reference of type OrderNumber.

Refer to AssignedBy for any enumerations

MonetaryAdjustmentReferenceLine

A link to a previously defined MonetaryAdjustmentLine upon which this adjustment is based.

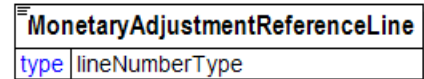

MonetaryAdjustmentReferenceType [attribute]

Provides a contextual explanation of the specific reference identifier. Many items are currently prefixed by "Buyer", "Forwarder", "Manufacturer", "Mill", "Seller", "Supplier", "Warehouse" or "Vendor". Check for an existing non-prefixed version and use the non-prefixed version instead. In the (yet to be announced release date) version 3.0 the prefixed versions will be removed. Instead the attribute AssignedBy will communicate the information previously communicated in the prefix.

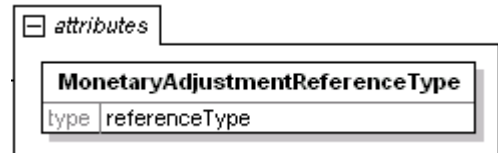

Refer to the [referenceType](#) entry for the list of enumerations and their definitions.

MonetaryAdjustmentStartAmount

The beginning currency amount used in the calculation of a monetary adjustment.

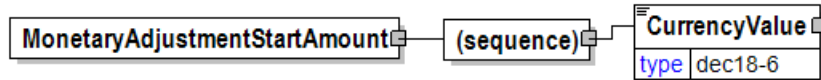

(sequence)

The sequence of items below is mandatory. A single instance is required.

CurrencyValue

CurrencyValue is mandatory. A single instance is required.

The amount in the referenced currency as defined by the CurrencyType attribute.

MonetaryAdjustmentStartQuantity

The beginning quantity used in the calculation of a monetary adjustment.

QuantityType [attribute]

QuantityType is optional. A single instance might exist.

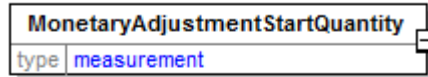

QuantityType communicates information about the type of quantity being communicated and how the receiver might use the information.

Refer to QuantityType definition for any enumerations.

QuantityTypeContext [attribute]

QuantityTypeContext is optional. A single instance might exist.

Provides the location in the value chain where the quantity is being reported.

Refer to QuantityTypeContext definition for any enumerations.

AdjustmentType [attribute]

AdjustmentType is optional. A single instance might exist.

Describes the type of adjustment associated with a quantity.

Refer to AdjustmentType definition for any enumerations.

MeasuringMethodType [attribute]

MeasuringMethodType is optional. A single instance might exist.

Specifies how a measurement value is created.

Refer to MeasuringMethodType definition for any enumerations.

MeasuringAgency [attribute]

MeasuringAgency is optional. A single instance might exist.

The agency defining measuring methods.

Refer to MeasuringAgency definition for any enumerations.

MeasuringMethod [attribute]

MeasuringMethod is optional. A single instance might exist.

The method used to determine how the item under consideration is measured. Measuring methods are defined by the measuring agency.

(sequence)

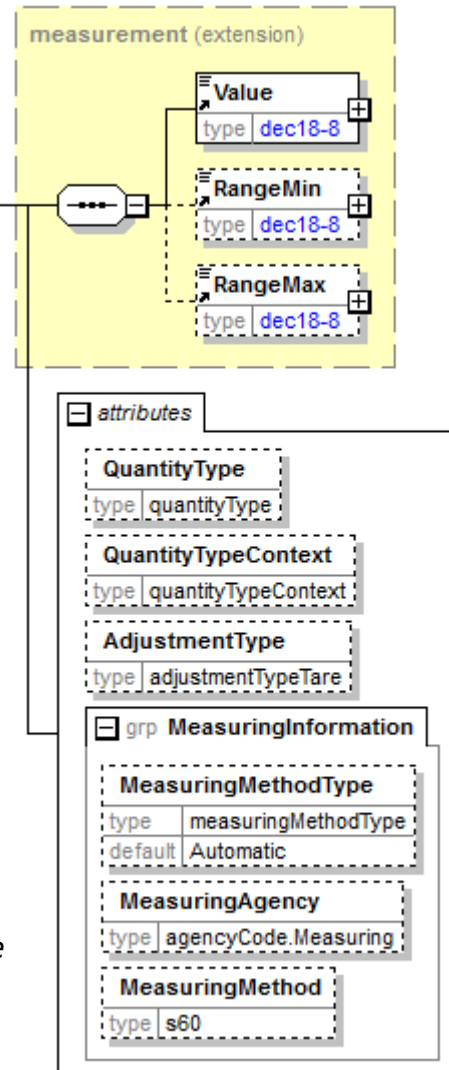

papiNet V2R31

The sequence of items below is mandatory. A single instance is required.

Value

Value is mandatory. A single instance is required.

A numeric value expressed in the unit of measure (UOM).

RangeMin

RangeMin is optional. A single instance might exist.

The minimum value (lower boundary) allowed for the Measurement that is the parent of this element.

RangeMax

RangeMax is optional. A single instance might exist.

The maximum value (upper boundary) allowed for the Measurement that is the parent of this element. Some elements use the RangeMax element with an extended list of unit of measures. (Note: the red colour in the picture is an artifact of how the graphic was captured and should be disregarded.)

Month

Identifies the month number when communicating a Calendar date. Month is an integer between 1 and 12 without leading zeros.

Month	
type	monthType

Mullen

Mullen, also called "burst strength", is the amount of pressure required to rupture paper or linerboard when applied to its surface. The unit of measure is KiloPascal (sometimes abbreviated as "kPa").

TestMethod [attribute]

TestMethod is optional. A single instance might exist.

The method used to determine the results of the test under consideration.

TestAgency [attribute]

TestAgency is optional. A single instance might exist.

The agency that has set the parameters for the testing

Refer to TestAgency definition for any enumerations.

SampleType [attribute]

SampleType is optional. A single instance might exist.

Communicates how sampling was done to measure the product characteristics.

Refer to SampleType definition for any enumerations.

ResultSource [attribute]

ResultSource is optional. A single instance might exist.

Used to define the data source of the specified test

Refer to ResultSource definition for any enumerations.

(sequence)

The sequence of items below is mandatory. A single instance is required.

DetailValue

DetailValue is mandatory. A single instance is required.

A numeric value expressed in the unit of measure (UOM).

DetailRangeMin

DetailRangeMin is optional. A single instance might exist.

The minimum value (lower boundary) allowed for the DetailValue that is the parent

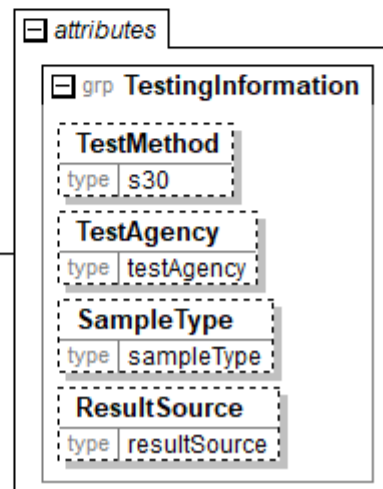
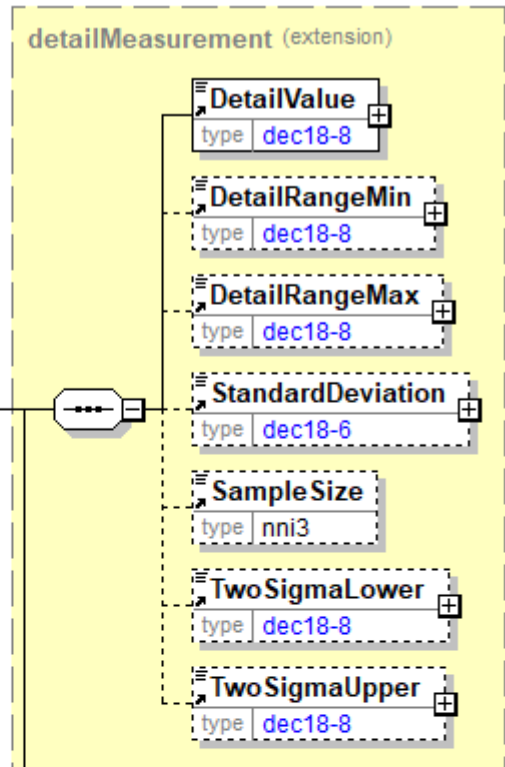

of this element.

DetailRangeMax

DetailRangeMax is optional. A single instance might exist.

The maximum value (upper boundary) allowed for the DetailValue that is the parent of this element.

StandardDeviation

StandardDeviation is optional. A single instance might exist.

A statistic used as a measure of dispersion in a distribution.

SampleSize

SampleSize is optional. A single instance might exist.

The number of samples used to determine the product characteristic in question.

TwoSigmaLower

TwoSigmaLower is optional. A single instance might exist.

Two sigma (a measure of dispersion associated with standard deviation) on the lower side of the standard deviation.

TwoSigmaUpper

TwoSigmaUpper is optional. A single instance might exist.

Two sigma (a measure of dispersion associated with standard deviation) on the upper side of the standard deviation.

MWeight

The weight of 1000 sheets.

(sequence)

The sequence of items below is mandatory. A single instance is required.

Value

Value is mandatory. A single instance is required.

A numeric value expressed in the unit of measure (UOM).

RangeMin

RangeMin is optional. A single instance might exist.

The minimum value (lower boundary) allowed for the Measurement that is the parent of this element.

RangeMax

RangeMax is optional. A single instance might exist.

The maximum value (upper boundary) allowed for the Measurement that is the parent of this element. Some elements use the RangeMax element with an extended list of unit of measures. (Note: the red colour in the picture is an artifact of how the graphic was captured and should be disregarded.)

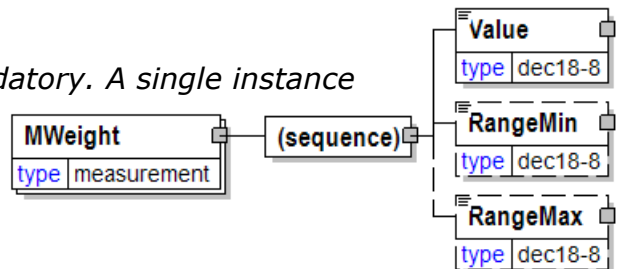

papiNet V2R31

Name1

The primary-level name of an organisation or business entity (for example, company name).

Name1	
type	s60

Name2

The second-level name of an organisation or business entity (for example, department, division, and so on).

Name2	
type	s60

Name3

The third-level name of an organisation or business entity.

Name3	
type	s60

NameAddress

A group item containing name and address of an organisation or business entity.

CommunicationRole [attribute]

CommunicationRole is optional. A single instance might exist.

Provides information about the sender, receiver, and participants to the document communication.

Refer to CommunicationRole definition for any enumerations.

AddressRoleType [attribute]

AddressRoleType is optional. A single instance might exist.

Specifies the role of an address.

Refer to AddressRoleType definition for any enumerations.

(sequence)

The sequence of items below is mandatory. A single instance is required.

Name1

Name1 is mandatory. A single instance is required.

The primary-level name of an organisation or business entity (for example, company name).

Name2

Name2 is optional. A single instance might exist.

The second-level name of an organisation or business entity (for example, department, division, and so on).

Name3

Name3 is optional. A single instance might exist.

The third-level name of an organisation or business entity.

OrganisationUnit

OrganisationUnit is optional. A

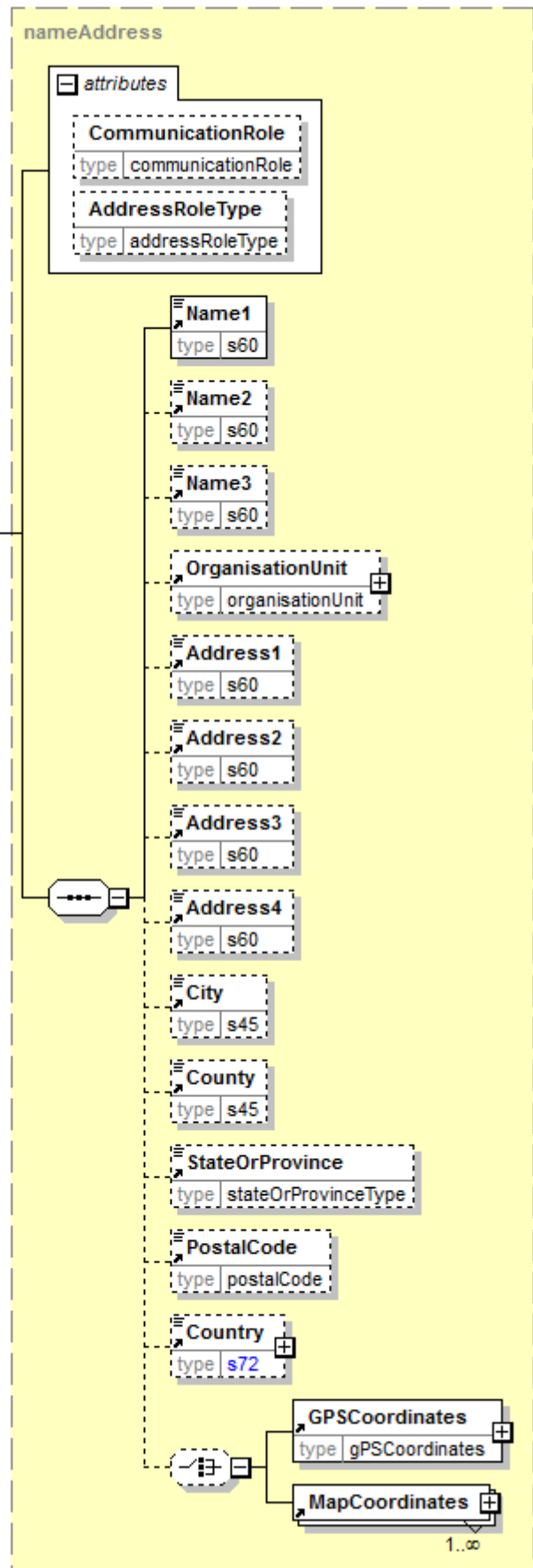

papiNet V2R31

single instance might exist.

A segment of a business or the entire business.

Address1

Address1 is optional. A single instance might exist.

The primary-level address of an organisation or business entity (for example, street name, and number).

Address2

Address2 is optional. A single instance might exist.

The second-level address of an organisation or business entity.

Address3

Address3 is optional. A single instance might exist.

The third-level address of an organisation or business entity.

Address4

Address4 is optional. A single instance might exist.

The fourth-level address of an organisation or business entity.

City

City is optional. A single instance might exist.

Name of the city associated with the address elements.

County

County is optional. A single instance might exist.

The name of the county that the address is in.

StateOrProvince

StateOrProvince is optional. A single instance might exist.

The political designation or boundary of a specific area of land.

PostalCode

PostalCode is optional. A single instance might exist.

The postal code associated with the address elements.

Country

Country is optional. A single instance might exist.

The name of the country associated with the address elements. To ensure reliable matching of addresses, it is suggested to use the attribute ISOCountryCode as well.

(choice)

[choice] is optional. A single instance might exist.

GPSCoordinates

GPSCoordinates is mandatory. A single instance is required.

The location of the party as specified using a Global Positioning System.

GPSCoordinates will be deprecated in a future version V3R00 and should not be used in new implementations. Use instead the MapCoordinates

MapCoordinates

MapCoordinates is mandatory. One instance is required, multiple instances might

exist.

A group item defining and containing position coordinates of a location.

NASTA [attribute]

Indicates if the specification must conform to the NASTA (National Association of State Textbook Administrators) requirements.

attribute	
NASTA	
type	yesNo
default	No

This item is restricted to the following list.

Yes

Book production must adhere to NASTA specifications.

No

Book production is not subject to NASTA specifications.

NaturalWoodSiding

Natural wood siding

(sequence)

The sequence of items below is mandatory. A single instance is required.

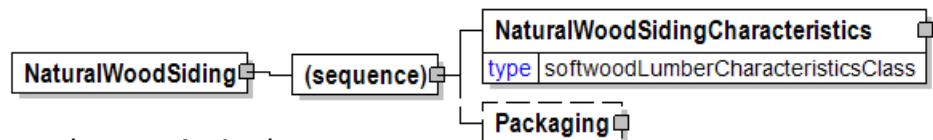

NaturalWoodSidingCharacteristics

NaturalWoodSidingCharacteristics is mandatory. A single instance is required.

Natural wood siding characteristics

Packaging

Packaging is optional. A single instance might exist.

Type of a package that includes individual products.

NaturalWoodSidingCharacteristics

Natural wood siding characteristics

(sequence)

The sequence of items below is mandatory. A single instance is required.

LumberSpecies

LumberSpecies is mandatory. One instance is required, multiple instances might exist.

Specifies the raw material species.

LumberGrade

LumberGrade is mandatory. A single instance is required.

Defines quality characteristics achieved by selecting pieces based on a grading rule.

Length

Length is optional.

The length of the object.

Width

Width is optional.

The width of the object.

Thickness

Thickness is optional.

Physical dimension of a product.

Seasoning

Seasoning is optional. A single instance might exist.

Describes drying/ moisture control method.

MoistureContent

MoistureContent is optional. A single instance might exist.

Defines the moisture content percentage of the product.

HeatTreatment

HeatTreatment is optional. A single instance might exist.

Defines the heat treatment method.

ManufacturingProcess

ManufacturingProcess is optional. Multiple instances might exist.

Defines the different machining and processes made for the product.

PatternProfile

PatternProfile is optional. A single instance might exist.

Defines the pattern used in machining the product.

Trim

Trim is optional. A single instance might exist.



Trim

Joining

Joining is optional. A single instance might exist.

Defines the method used to join pieces of wood.

PressureTreatment

PressureTreatment is optional. A single instance might exist.

Method and parameter values of pressure treatment.

FireTreatment

FireTreatment is optional. A single instance might exist.

Fire treatment

OtherTreatment

OtherTreatment is optional. A single instance might exist.

Other treatment

GradeStamp

GradeStamp is optional. A single instance might exist.

Grade stamp information

ExLog

ExLog is optional. A single instance might exist.

Describes the cutting pattern of the log.

ClassIdentifier

ClassIdentifier is optional. Multiple instances might exist.

Standard used for product identification.

Weight

Weight is optional. A single instance might exist.

The weight of the item.

LabelCharacteristics

LabelCharacteristics is optional. A single instance might exist.

A group item that organises the labeling information.

StencilCharacteristics

StencilCharacteristics is optional. A single instance might exist.

A group element specifying attributes of a stencil to be applied to an item, and optional text.

Wrap

Wrap is optional. A single instance might exist.

A group item that organises wrapping detail information.

SafetyAndEnvironmentalInformation

SafetyAndEnvironmentalInformation is optional. Multiple instances might exist.

Name of certification type, if any, on the goods (For example, FSC, PEFC). SafetyAndEnvironmental needs a value or measurement to communicate the percentage of the product is certified (for example, 75% is certified by the

indicated agency).

AdditionalText

AdditionalText is optional. Multiple instances might exist.

A text field that is used to communicate information not previously defined or for special instructions. To be used only for circumstances not covered by specific elements.

LengthCutDescription

LengthCutDescription is optional. A single instance might exist.

Length Cut Description

ShippingMark

ShippingMark is optional. A single instance might exist.

A shipping mark identifies the producer and quality on the end side of the product. Not to be mixed with company code/logo or other product marking.

NaturalWoodSiding-Other

Natural Wood Siding - Other

(sequence)

The

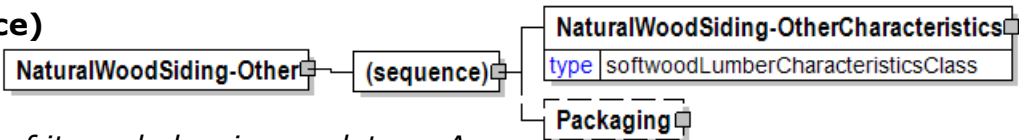

sequence of items below is mandatory. A single instance is required.

NaturalWoodSiding-OtherCharacteristics

NaturalWoodSiding-OtherCharacteristics is mandatory. A single instance is required.

Natural Wood Siding - Other Characteristics

Packaging

Packaging is optional. A single instance might exist.

Type of a package that includes individual products.

NaturalWoodSiding-OtherCharacteristics

Natural Wood Siding - Other Characteristics

(sequence)

The sequence of items below is mandatory. A single instance is required.

LumberSpecies

LumberSpecies is mandatory. One instance is required, multiple instances might exist.

Specifies the raw material species.

LumberGrade

LumberGrade is mandatory. A single instance is required.

Defines quality characteristics achieved by selecting pieces based on a grading rule.

Length

Length is optional.

The length of the object.

Width

Width is optional.

The width of the object.

Thickness

Thickness is optional.

Physical dimension of a product.

Seasoning

Seasoning is optional. A single instance might exist.

Describes drying/ moisture control method.

MoistureContent

MoistureContent is optional. A single instance might exist.

Defines the moisture content percentage of the product.

HeatTreatment

HeatTreatment is optional. A single instance might exist.

Defines the heat treatment method.

ManufacturingProcess

ManufacturingProcess is optional. Multiple instances might exist.

Defines the different machining and processes made for the product.

PatternProfile

PatternProfile is optional. A single instance might exist.

Defines the pattern used in machining the product.

Trim

Trim is optional. A single instance might exist.



Trim

Joining

Joining is optional. A single instance might exist.

Defines the method used to join pieces of wood.

PressureTreatment

PressureTreatment is optional. A single instance might exist.

Method and parameter values of pressure treatment.

FireTreatment

FireTreatment is optional. A single instance might exist.

Fire treatment

OtherTreatment

OtherTreatment is optional. A single instance might exist.

Other treatment

GradeStamp

GradeStamp is optional. A single instance might exist.

Grade stamp information

ExLog

ExLog is optional. A single instance might exist.

Describes the cutting pattern of the log.

ClassIdentifier

ClassIdentifier is optional. Multiple instances might exist.

Standard used for product identification.

Weight

Weight is optional. A single instance might exist.

The weight of the item.

LabelCharacteristics

LabelCharacteristics is optional. A single instance might exist.

A group item that organises the labeling information.

StencilCharacteristics

StencilCharacteristics is optional. A single instance might exist.

A group element specifying attributes of a stencil to be applied to an item, and optional text.

Wrap

Wrap is optional. A single instance might exist.

A group item that organises wrapping detail information.

SafetyAndEnvironmentalInformation

SafetyAndEnvironmentalInformation is optional. Multiple instances might exist.

Name of certification type, if any, on the goods (For example, FSC, PEFC). SafetyAndEnvironmental needs a value or measurement to communicate the percentage of the product is certified (for example, 75% is certified by the

indicated agency).

AdditionalText

AdditionalText is optional. Multiple instances might exist.

A text field that is used to communicate information not previously defined or for special instructions. To be used only for circumstances not covered by specific elements.

LengthCutDescription

LengthCutDescription is optional. A single instance might exist.

Length Cut Description

ShippingMark

ShippingMark is optional. A single instance might exist.

A shipping mark identifies the producer and quality on the end side of the product. Not to be mixed with company code/logo or other product marking.

NetAmount

An element that contains the net amount excluding tax. NetAmount encapsulates CurrencyValue.

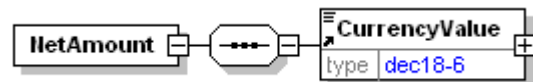

(sequence)

The sequence of items below is mandatory. A single instance is required.

CurrencyValue

CurrencyValue is mandatory. A single instance is required.

The amount in the referenced currency as defined by the CurrencyType attribute.

NetChargeAmount

A field containing the sum of all instances of the Complaint charges.

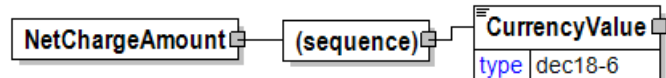

(sequence)

The sequence of items below is mandatory. A single instance is required.

CurrencyValue

CurrencyValue is mandatory. A single instance is required.

The amount in the referenced currency as defined by the CurrencyType attribute.

NoiseReduction [attribute]

The noise reduction method

This item is restricted to the following list.

DolbyB

A simplified version of type A noise reduction targeted

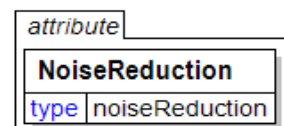

papiNet V2R31

towards consumer recording equipment.

DolbyC

An improvement of the B type consumer technology filters result in 20 dB of noise reduction but still confined 1KHz and over typically found built into mid and high end cassette recorders.

DolbyS

A multiband consumer version of the Dolby system.

None

NonPressComponent

Non-press component.

(choice)

[choice] is mandatory. A single instance is required.

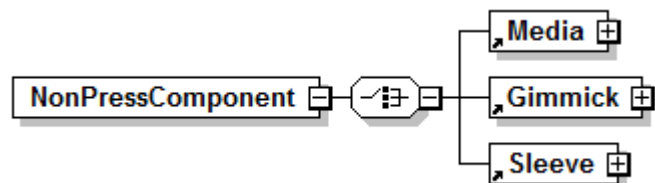

Media

Media is mandatory. A single instance is required.

Media.

Gimmick

Gimmick is mandatory. A single instance is required.

Gimmick

Sleeve

Sleeve is mandatory. A single instance is required.

Sleeve.

NonStandardPulp

The characteristics of the form that pulp in a nonstandard presentation takes.

(sequence)

The sequence of items below is mandatory. A single instance is required.

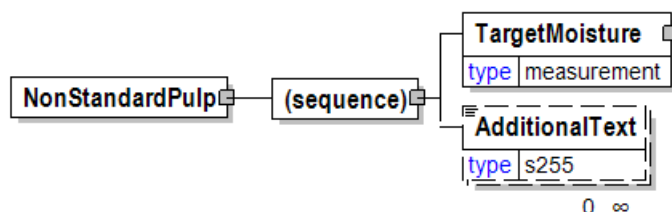

TargetMoisture

TargetMoisture is mandatory. A single instance is required.

The moisture target for the product being specified.

AdditionalText

AdditionalText is optional. Multiple instances might exist.

A text field that is used to communicate information not previously defined or for special instructions. To be used only for circumstances not covered by specific elements.

Notification

A group element that contains information about a notification.

NotificationReasonType [attribute]

NotificationReasonType is optional. A single instance might exist.

Specifies the type of reason for a notification.

Refer to NotificationReasonType definition for any enumerations.

(sequence)

The sequence of items below is mandatory. A single instance is required.

NotificationNumber

NotificationNumber is mandatory. A single instance is required.

The unique identifier of a notification.

IssueDate

IssueDate is mandatory. A single instance is required.

The date and time when the item was issued.

NotificationText

NotificationText is optional. Multiple instances might exist.

An element used to communicate human readable information about a notification.

OtherParty

OtherParty is optional. Multiple instances might exist.

An organisation or business entity other than those specifically detailed within an e-Document.

DocumentReferenceInformation

DocumentReferenceInformation is optional. Multiple instances might exist.

A group item containing reference information applicable to a document.

NotificationDetails

NotificationDetails is optional. A single instance might exist.

A grouping element that contains structured detailed information in a notification.

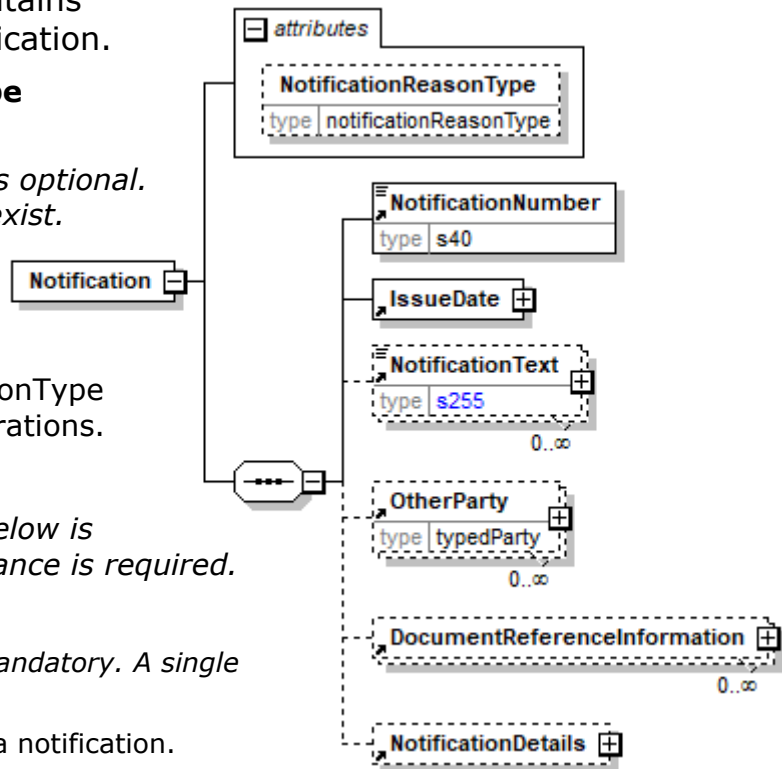

NotificationDetails

A grouping element that contains structured detailed information in a notification.

(sequence)

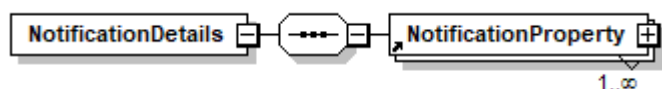

The sequence of items below is mandatory. A single instance is required.

NotificationProperty

NotificationProperty is mandatory. Multiple instances might exist.

A grouping element that contains information about a property assigned by an Agency in a notification.

NotificationNumber

The unique identifier of a notification.

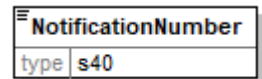

NotificationProperty

A grouping element that contains information about a property assigned by an Agency in a notification.

Agency [attribute]

Agency is mandatory. A single instance is required.

Describes the agency maintaining the list of codes. To be included in this list the agency must be a recognized standards body or industry organisation.

- For the element that owns this attribute.
- For another attribute in the list of attributes associated with the parent element.

Refer to Agency definition for any enumerations.

(sequence)

The sequence of items below is mandatory. A single instance is required.

Code

Code is mandatory. A single instance is required.

Specifies a code that is defined by an agency. The agency is given for the whole construct containing the code.

CodeValue

CodeValue is optional. A single instance might exist.

A grouping element specifying a value belonging to a code that is defined by an agency.

CodeDescription

CodeDescription is optional. Multiple instances might exist.

A textual description for the meaning of a code that is defined by an agency. When the Code is associated with a CodeValue of type TextValue, then the CodeDescription is a textual description of both the Code and the TextValue.

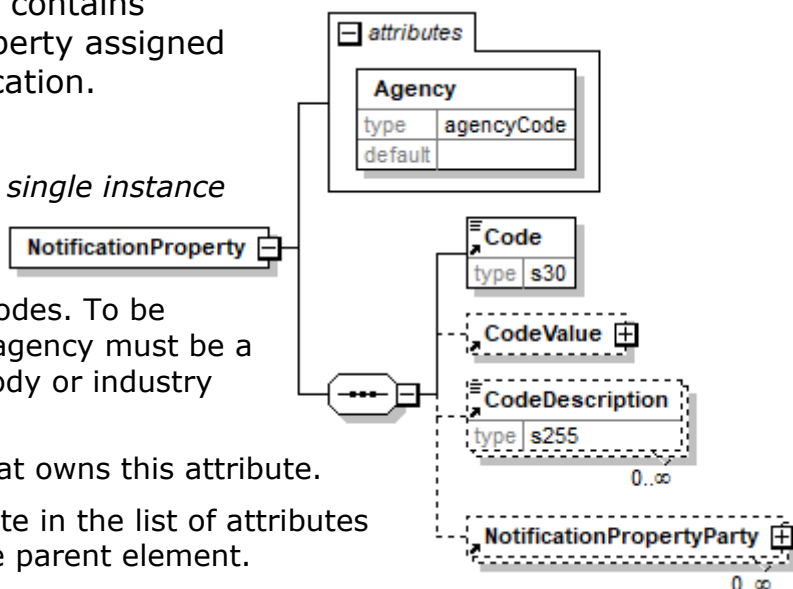

NotificationPropertyParty

NotificationPropertyParty is optional. Multiple instances might exist.

Specifies a party being part of a property in a notification.

NotificationPropertyParty

Specifies a party being part of a property in a notification.

PartyType [attribute]

PartyType is optional. A single instance might exist.

Identifies the business role associated with the particular party

Refer to PartyType definition for any enumerations.

(sequence)

The sequence of items below is mandatory. A single instance is required.

PartyIdentifier

PartyIdentifier is mandatory. One instance is required, multiple instances might exist.

A unique identifier of a specific party. This element contains an attribute PartyIdentifierType that indicates the type of the identifier.

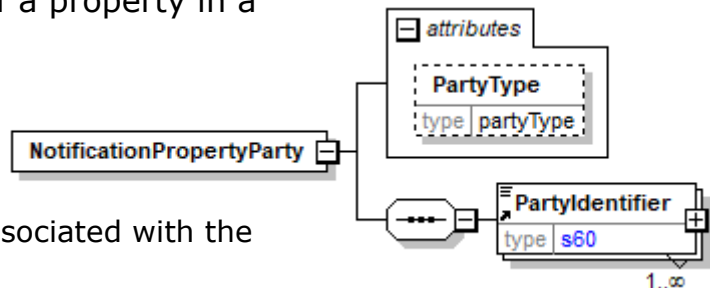

NotificationReasonType [attribute]

Specifies the type of reason for a notification.

This item is restricted to the following list.

IgnoreReferencedItem

The item referenced in

DocumentReferenceInformation shall be ignored and disregarded.

SampleDrawnInDelivery

The item specified is a sample drawn in a delivery. The identifier of the sample is supplied in DocumentReferenceInformation with reference type RandomSampleNumber or SampleNumber.



NotificationText

An element used to communicate human readable information about a notification.

Language [attribute]

Language is optional. A single instance might exist.

The valid Alpha 2- and Alpha 3-character list of language codes in the ISO 639-1 and 639-2 international standards.

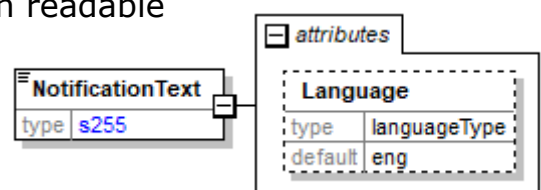

papiNet V2R31

Information on the content of this attribute is available at:
https://www.loc.gov/standards/iso639-2/php/code_list.php

NumberOfAttachments

NumberOfAttachments indicates the number of attachments enclosed in the e-Document

NumberOfAttachments	
type	nni3

NumberOfBands

The number of bands to be applied to the package.

NumberOfBands	
type	nni2

NumberOfBindComponents

Total number of components contained in the book block.

NumberOfBindComponents	
type	nni4

NumberOfColours

The number of colours

NumberOfColours	
type	nni4

NumberOfComplaintLineItemDetail

The number of ComplaintLineItemDetail elements for a given ComplaintLineItem (Example: the number of reels in a ComplaintLineItem)

NumberOfComplaintLineItemDetail	
type	nni4

NumberOfComplaintResponseLineItemDetail

The number of ComplaintResponseLineItemDetail elements for a given ComplaintResponseLineItem

NumberOfComplaintResponseLineItemDetail	
type	nni4

NumberOfDocuments

Specifies the number of documents needed.

Original [attribute]

Original is optional. A single instance might exist.

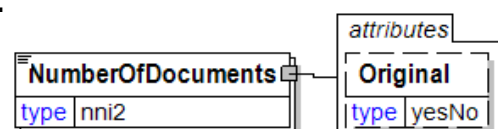

papiNet V2R31

Either "Yes" or "No".

Refer to Original definition for any enumerations.

NumberOfDocumentsRequired

The number of copies of the document required.

NumberOfDocumentsRequired	
type	nni2

NumberOfGoodsReceiptPackages

A count of the number of packages detailed in the GoodsReceiptLineItem.

NumberOfGoodsReceiptPackages	
type	nni4

NumberOfHits

The number of hits

NumberOfHits	
type	nni4

NumberOfHoles

The number of holes punched in a sheet of paper.

NumberOfHoles	
type	nni3

NumberOfInventoryChangeLineItemDetails

The number of InventoryChangeLineItemDetail elements included in the InventoryChangeLineItem.

NumberOfInventoryChangeLineItemDetails	
type	nni4

NumberOfInventoryStatusLineItemDetails

The number of InventoryStatusLineItemDetail elements included in the InventoryStatusLineItem.

NumberOfInventoryStatusLineItemDetails	
type	nni4

NumberOfItemMeasuringInfo

Number of reported items by ItemMeasuringInfo.

NumberOfItemMeasuringInfo	
type	nni6

papiNet V2R31

NumberOfLabels

The number of labels to be placed on the package.

NumberOfLabels	
type	nni2

NumberOfMillJoins

The number of joins in the reel.

NumberOfMillJoins	
type	nni1

NumberOfPackageMeasuringInfo

Number of reported packages by PackageMeasuringInfo.

NumberOfPackageMeasuringInfo	
type	nni6

NumberOfPackages

The number of packages in the delivery.

NumberOfPackages	
type	nni4

NumberOfPackingListItems

The number of PackingList items in a PackingUnit of the PackingList.

NumberOfPackingListItems	
type	nni3

NumberOfPages

The number of pages.

NumberOfPages	
type	nni6

NumberOfPlies

The number of layers of paper product joined together to make the final saleable product.

NumberOfPlies	
type	nni1

NumberOfRibbons

The number of ribbons.

NumberOfRibbons	
type	nni2

NumberOfSides

The number of sides.

NumberOfSides	
type	nni2

NumberOfSignatures

The number of signatures.

NumberOfSignatures	
type	nni4

NumberOfUncompletedMeasuredItems

Specifies the number of items that are uncompleted measured, i.e. some measurement values are missing for these items.

NumberOfUncompletedMeasuredItems	
type	nni6

NumberOfWraps

The number of turns of wrapping material to be applied to the package.

NumberOfWraps	
type	dec03-2

NumberOrderDocumentRequired

There are certain business cases whereby a party is required to reference external documents to the transaction. Additionally, in these cases, the party is required to communicate the number of these external documents. This element is used to indicate how many of these external documents will be required. Typically used to indicate how many hard copies of the referenced document are needed.

NumberOrderDocumentRequired	
type	nni2

NumberPerProduct

The number of components or items per assembly or constructed product

NumberPerProduct	
type	dec18-8

NumericValue

A grouping element for a numeric value and its statistical measures.

(sequence)

The sequence of items below is mandatory. A single instance is required.

DetailValue

DetailValue is mandatory. A single instance is required.

A numeric value expressed in the unit of measure (UOM).

DetailRangeMin

DetailRangeMin is optional. A single instance might exist.

The minimum value (lower boundary) allowed for the DetailValue that is the parent of this element.

DetailRangeMax

DetailRangeMax is optional. A single instance might exist.

The maximum value (upper boundary) allowed for the DetailValue that is the parent of this element.

StandardDeviation

StandardDeviation is optional. A single instance might exist.

A statistic used as a measure of dispersion in a distribution.

SampleSize

SampleSize is optional. A single instance might exist.

The number of samples used to determine the product characteristic in question.

TwoSigmaLower

TwoSigmaLower is optional. A single instance might exist.

Two sigma (a measure of dispersion associated with standard deviation) on the lower side of the standard deviation.

TwoSigmaUpper

TwoSigmaUpper is optional. A single instance might exist.

Two sigma (a measure of dispersion associated with standard deviation) on the upper side of the standard deviation.

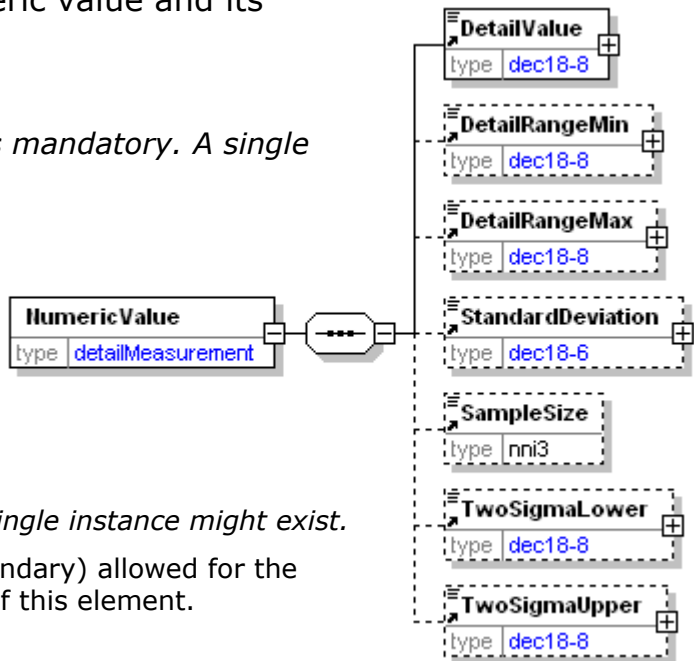

OldInformationalQuantity

What the InformationalQuantity was prior to the event described taking place.

QuantityType [attribute]

QuantityType is mandatory. A single instance is required.



QuantityType communicates information about the type of quantity being communicated and how the receiver might use the information.

Refer to QuantityType definition for any enumerations.

QuantityTypeContext [attribute]

QuantityTypeContext is optional. A single instance might exist.

Provides the location in the value chain where the quantity is being reported.

Refer to QuantityTypeContext definition for any enumerations.

AdjustmentType [attribute]

AdjustmentType is optional. A single instance might exist.

Describes the type of adjustment associated with a quantity.

Refer to AdjustmentType definition for any enumerations.

MeasuringMethodType [attribute]

MeasuringMethodType is optional. A single instance might exist.

Specifies how a measurement value is created.

Refer to MeasuringMethodType definition for any enumerations.

MeasuringAgency [attribute]

MeasuringAgency is optional. A single instance might exist.

The agency defining measuring methods.

Refer to MeasuringAgency definition for any enumerations.

MeasuringMethod [attribute]

MeasuringMethod is optional. A single instance might exist.

The method used to determine how the item under consideration is measured. Measuring methods are defined by the measuring agency.

(sequence)

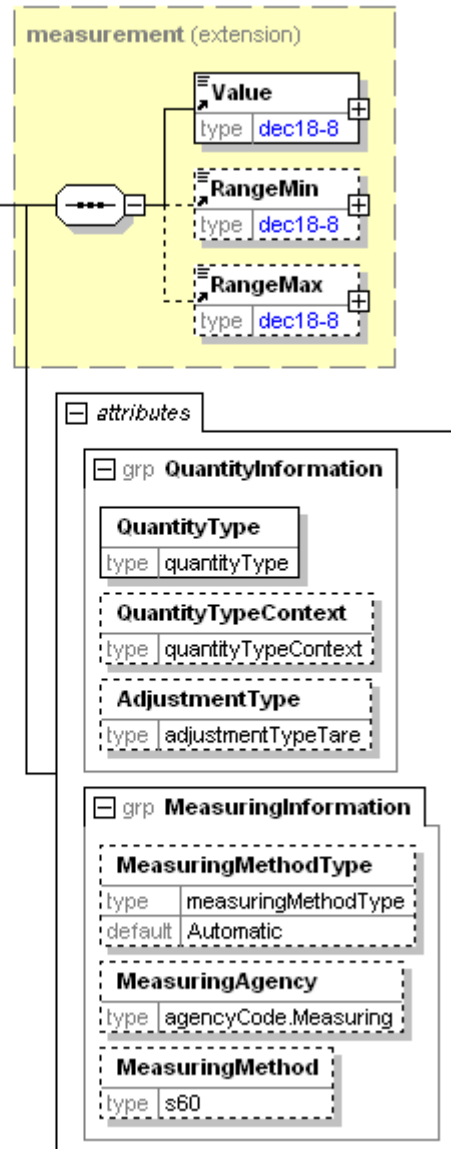

The sequence of items below is mandatory. A single instance is required.

Value

Value is mandatory. A single instance is required.

A numeric value expressed in the unit of measure (UOM).

RangeMin

RangeMin is optional. A single instance might exist.

The minimum value (lower boundary) allowed for the Measurement that is the parent of this element.

RangeMax

RangeMax is optional. A single instance might exist.

The maximum value (upper boundary) allowed for the Measurement that is the parent of this element. Some elements use the RangeMax element with an extended list of unit of measures. (Note: the red colour in the picture is an artifact of how the graphic was captured and should be disregarded.)

OldInventoryClass

A group item containing information about what the InventoryClass was prior to the event described taking place.

InventoryStatusType

OldInventoryClass

[attribute]

InventoryStatusType is optional. A single instance might exist.

Provides the status type for inventory/goods belonging to a product and/or an order.

Refer to InventoryStatusType definition for any enumerations.

InventoryOwnedBy [attribute]

InventoryOwnedBy is optional. A single instance might exist.

Specifies who is the owner of the inventory/goods.

Refer to InventoryOwnedBy definition for any enumerations.

(sequence)

The sequence of items below is mandatory. A single instance is required.

(sequence)

The sequence of items below is optional. Multiple instances might exist.

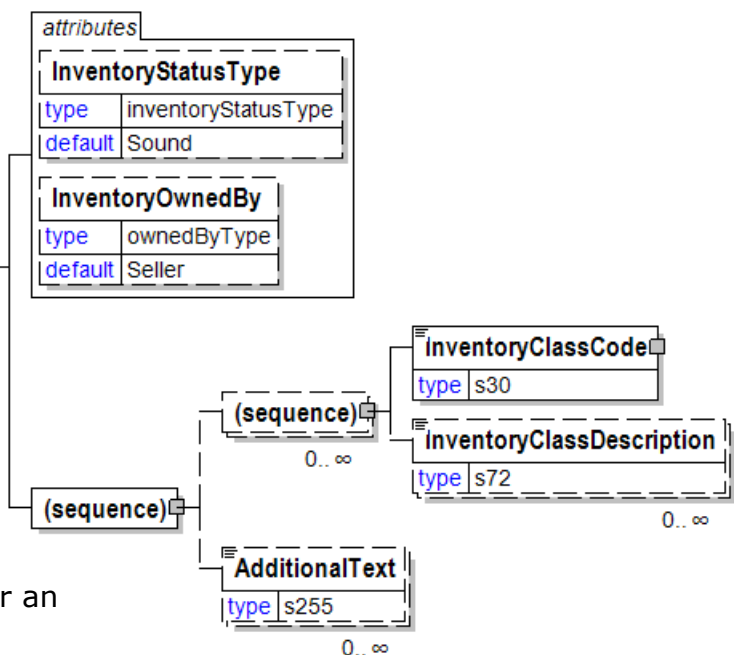

InventoryClassCode

InventoryClassCode is mandatory. A single instance is required.

A code specifying the inventory and goods status. Classification of statuses can be done on multiple levels indicated by InventoryClassLevel.

InventoryClassDescription

InventoryClassDescription is optional. Multiple instances might exist.

A description of the inventory class.

AdditionalText

AdditionalText is optional. Multiple instances might exist.

A text field that is used to communicate information not previously defined or for special instructions. To be used only for circumstances not covered by specific elements.

OldQuantity

What the Quantity was prior to the event described taking place

QuantityType [attribute]

QuantityType is mandatory. A single instance is required.

QuantityType communicates information about the type of quantity being communicated and how the receiver might use the information.

Refer to QuantityType definition for any enumerations.

QuantityTypeContext [attribute]

QuantityTypeContext is optional. A single instance might exist.

Provides the location in the value chain where the quantity is being reported.

Refer to QuantityTypeContext definition for any enumerations.

AdjustmentType [attribute]

AdjustmentType is optional. A single instance might exist.

Describes the type of adjustment associated with a quantity.

Refer to AdjustmentType definition for any enumerations.

MeasuringMethodType [attribute]

MeasuringMethodType is optional. A single instance might exist.

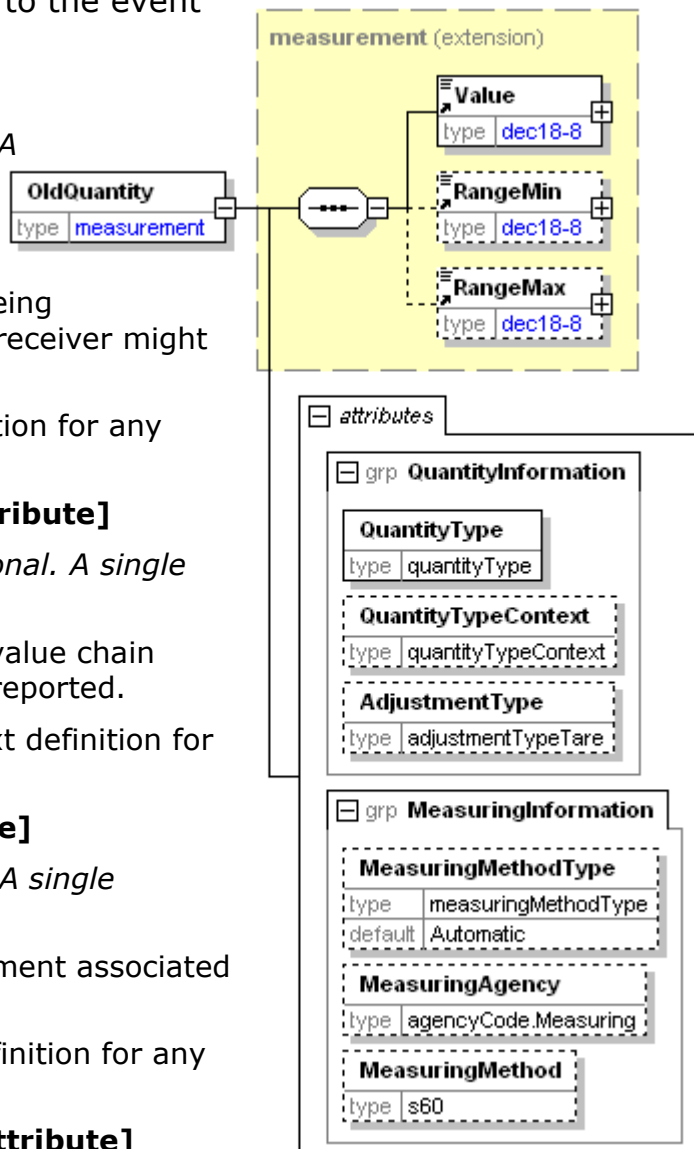

instance might exist.

Specifies how a measurement value is created.

Refer to MeasuringMethodType definition for any enumerations.

MeasuringAgency [attribute]

MeasuringAgency is optional. A single instance might exist.

The agency defining measuring methods.

Refer to MeasuringAgency definition for any enumerations.

MeasuringMethod [attribute]

MeasuringMethod is optional. A single instance might exist.

The method used to determine how the item under consideration is measured.

Measuring methods are defined by the measuring agency.

(sequence)

The sequence of items below is mandatory. A single instance is required.

Value

Value is mandatory. A single instance is required.

A numeric value expressed in the unit of measure (UOM).

RangeMin

RangeMin is optional. A single instance might exist.

The minimum value (lower boundary) allowed for the Measurement that is the parent of this element.

RangeMax

RangeMax is optional. A single instance might exist.

The maximum value (upper boundary) allowed for the Measurement that is the parent of this element. Some elements use the RangeMax element with an extended list of unit of measures. (Note: the red colour in the picture is an artifact of how the graphic was captured and should be disregarded.)

Opacity

A group item used to communicate opacity target or test value according to a particular TestMethod.

TestMethod [attribute]

TestMethod is optional. A single instance might exist.

The method used to determine the results of the test under consideration.

TestAgency [attribute]

TestAgency is optional. A single instance might exist.

The agency that has set the parameters for the testing

Refer to TestAgency definition for any enumerations.

SampleType [attribute]

SampleType is optional. A single instance might exist.

Communicates how sampling was done to measure the product characteristics.

Refer to SampleType definition for any enumerations.

ResultSource [attribute]

ResultSource is optional. A single instance might exist.

Used to define the data source of the specified test

Refer to ResultSource definition for any enumerations.

(sequence)

The sequence of items below is mandatory. A single instance is required.

DetailValue

DetailValue is mandatory. A single instance is required.

A numeric value expressed in the unit of measure (UOM).

DetailRangeMin

DetailRangeMin is optional. A single instance might exist.

The minimum value (lower boundary) allowed for the DetailValue that is the parent of this element.

DetailRangeMax

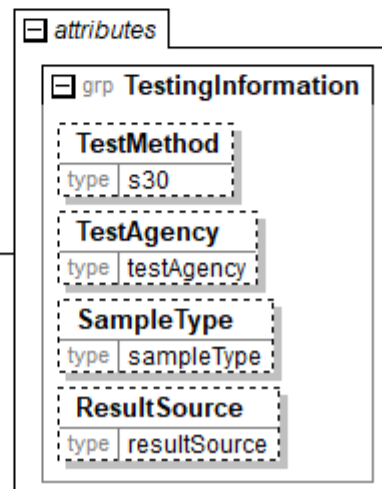
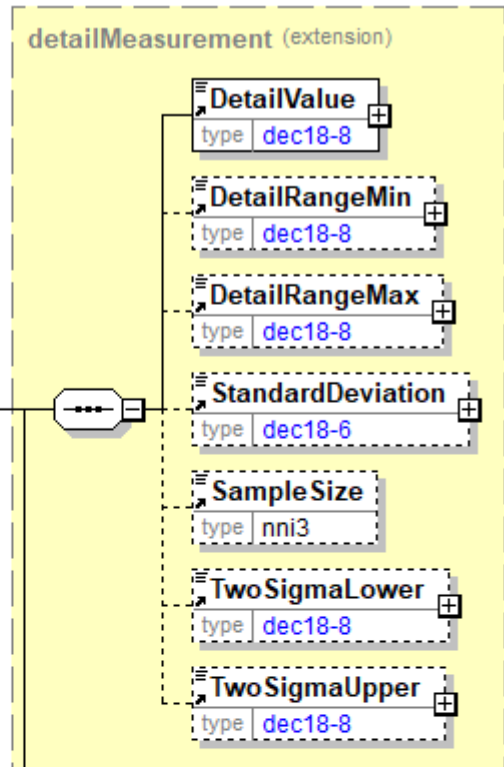

DetailRangeMax is optional. A single instance might exist.

The maximum value (upper boundary) allowed for the DetailValue that is the parent of this element.

StandardDeviation

StandardDeviation is optional. A single instance might exist.

A statistic used as a measure of dispersion in a distribution.

SampleSize

SampleSize is optional. A single instance might exist.

The number of samples used to determine the product characteristic in question.

TwoSigmaLower

TwoSigmaLower is optional. A single instance might exist.

Two sigma (a measure of dispersion associated with standard deviation) on the lower side of the standard deviation.

TwoSigmaUpper

TwoSigmaUpper is optional. A single instance might exist.

Two sigma (a measure of dispersion associated with standard deviation) on the upper side of the standard deviation.

OrderConfirmation

The OrderConfirmation element is the root element for the OrderConfirmation e-Document.

A seller sends an OrderConfirmation e-Document to a buyer after receiving a PurchaseOrder from that buyer. The e-Document contains a response to the conditions specified in the PurchaseOrder. A supplier may also send an OrderConfirmation e-Document to convey changes that the supplier has made in the order or to convey new information such as a Supplier Reference Number or Job Number.

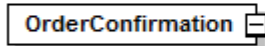

OrderConfirmationStatusType [attribute]

OrderConfirmationStatusType is mandatory. A single instance is required.

Identifies the status of the whole OrderConfirmation e-Document (i.e. at the root level)

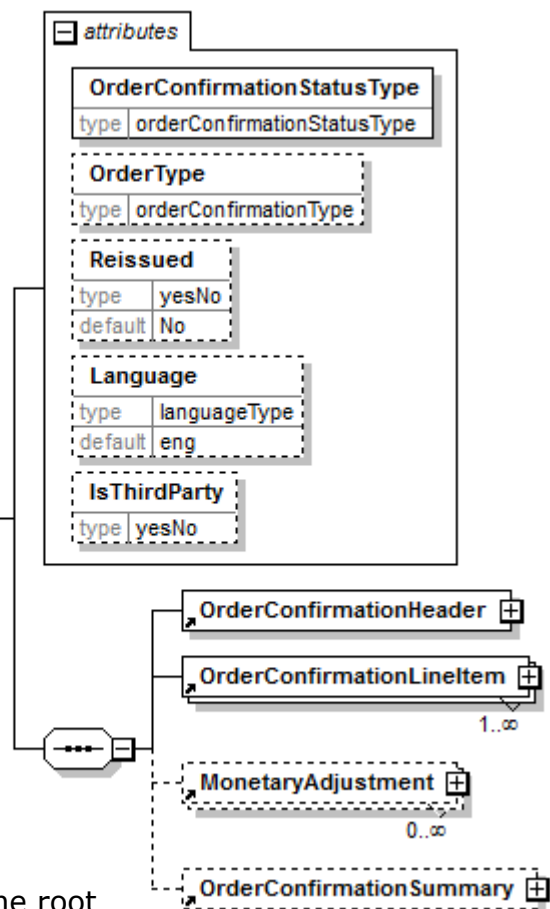

Refer to OrderConfirmationStatusType definition for any enumerations.

OrderType [attribute]

OrderType is optional. A single instance might exist.

Defines the type of OrderConfirmation being communicated.

Refer to OrderType definition for any enumerations.

Reissued [attribute]

Reissued is optional. A single instance might exist.

Either "Yes" or "No".

Refer to Reissued definition for any enumerations.

Language [attribute]

Language is optional. A single instance might exist.

The valid Alpha 2- and Alpha 3-character list of language codes in the ISO 639-1 and 639-2 international standards.

Information on the content of this attribute is available at:
https://www.loc.gov/standards/iso639-2/php/code_list.php

IsThirdParty [attribute]

IsThirdParty is optional. A single instance might exist.

Indication of an indirect business process.

Refer to IsThirdParty definition for any enumerations.

(sequence)

The sequence of items below is mandatory. A single instance is required.

OrderConfirmationHeader

OrderConfirmationHeader is mandatory. A single instance is required.

Information that is common to all items on the OrderConfirmation.

OrderConfirmationLineItem

OrderConfirmationLineItem is mandatory. One instance is required, multiple instances might exist.

The detail of the items that are communicated in the OrderConfirmation e-Document.

MonetaryAdjustment

MonetaryAdjustment is optional. Multiple instances might exist.

The element containing the information necessary for the understanding, calculation, and treatment of an adjustment to a currency amount. MonetaryAdjustment contains an attribute that indicates they type of adjustment being communicated.

OrderConfirmationSummary

OrderConfirmationSummary is optional. A single instance might exist.

Summary information that applies to the whole OrderConfirmation e-Document.

OrderConfirmationHeader

Information that is common to all items on the OrderConfirmation.

OrderConfirmationHeaderStatusType [attribute]

OrderConfirmationHeaderStatusType is mandatory. A single instance is required.

An attribute defining the status of the OrderConfirmation header

Refer to OrderConfirmationHeaderStatusType definition for any enumerations.

(sequence)

The sequence of items below is mandatory. A single instance is required.

OrderConfirmationHeader

OrderConfirmationNumber

OrderConfirmationNumber is optional. A single instance might exist.

The unique order identifier as designated by the seller.

OrderConfirmationHeaderStatusTypeText

OrderConfirmationHeaderStatusTypeText is optional. A single instance might exist.

A text field that may provide detail explaining the status of the OrderConfirmationHeader.

This field is required if the OrderConfirmationHeaderStatusType is "Rejected".

When the OrderConfirmationHeaderStatusType is "Pending", the reason can be specified in this field.

Not required if the PurchaseOrder is "Accepted".

OrderConfirmationIssuedDate

OrderConfirmationIssuedDate is mandatory. A single instance is required.

The Date and optionally the Time that the OrderConfirmation was issued.

TransactionHistoryNumber

TransactionHistoryNumber is optional. A single instance might exist.

A sequential number that keeps track of the version of a document.

However when the document is a confirmation document, in which case the TransactionHistoryNumber refers to the trigger

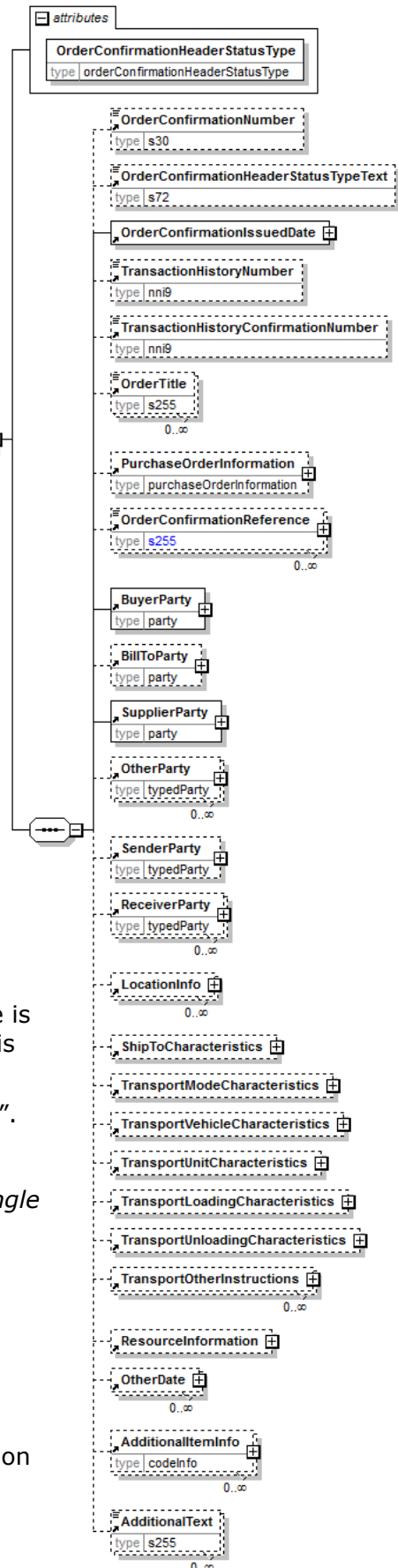

transaction for the confirmation.

TransactionHistoryConfirmationNumber

TransactionHistoryConfirmationNumber is optional. A single instance might exist.

A sequential number that keeps track the version of a confirmation document.

When the document is a confirmation document, then the TransactionHistoryNumber refers to the trigger transaction for the confirmation.

PurchaseOrderInformation

PurchaseOrderInformation is optional. A single instance might exist.

A group item containing information unique to this PurchaseOrder, which is provided by the buyer. PurchaseOrderInformation can be optional in the supply chain. Invoices are created without having a PurchaseOrder in Vendor Managed Inventory. Freight invoices also will not have a PurchaseOrder number.

OrderConfirmationReference

OrderConfirmationReference is optional. Multiple instances might exist.

A group item detailing relevant references pertaining to the OrderConfirmation. Typically, the ContractNumber is referenced. OrderConfirmationReferenceType provides the identification of what the reference represents.

BuyerParty

BuyerParty is mandatory. A single instance is required.

The legal entity to which the product is sold. Also commonly referred to as the sold-to party or customer. If no OtherParty is defined as the Payer, the Buyer is the Payer.

BillToParty

BillToParty is optional. A single instance might exist.

The address where the invoice is to be sent.

SupplierParty

SupplierParty is mandatory. A single instance is required.

The organisation or business entity responsible for providing the product. SupplierParty is also the seller of the product, if Seller is not specified as OtherParty = Seller.

OtherParty

OtherParty is optional. Multiple instances might exist.

An organisation or business entity other than those specifically detailed within an e-Document.

SenderParty

SenderParty is optional. A single instance might exist.

The business entity issuing the e-Document, the source of the document.

The entity responsible for the content. If the sender party has out sourced the message service to a third party the SenderParty is the issuer of the e-Document and not the party performing the transmission service of the electronic message.

ReceiverParty

ReceiverParty is optional. Multiple instances might exist.

The business entity for whom the e-Document is intended, the destination of the

document.

The entity interested in the content. If the receiver party has outsourced the message service to a third party the ReceiverParty is the intended party for the e-Document and not the party performing the receiving service of the electronic message.

LocationInfo

LocationInfo is optional. Multiple instances might exist.

A grouping element that contains information about a geographical location.

ShipToCharacteristics

ShipToCharacteristics is optional. A single instance might exist.

A group item that provides information important for the Ship-To Party.

TransportModeCharacteristics

TransportModeCharacteristics is optional. A single instance might exist.

A group item defining the primary mode of transport.

TransportVehicleCharacteristics

TransportVehicleCharacteristics is optional. A single instance might exist.

A group item containing information about a transport vehicle, e.g. a truck. A transport vehicle has its own power and can be used to pull, push, carry, or tow a transport unit loaded with goods.

TransportUnitCharacteristics

TransportUnitCharacteristics is optional. A single instance might exist.

A group item containing information about a transport unit, e.g. a trailer. Transport units contain goods and move using power from another source, the transport vehicle.

TransportLoadingCharacteristics

TransportLoadingCharacteristics is optional. A single instance might exist.

A group item defining how the transported items are to be loaded.

TransportUnloadingCharacteristics

TransportUnloadingCharacteristics is optional. A single instance might exist.

A group item defining how the transported items are to be unloaded.

TransportOtherInstructions

TransportOtherInstructions is optional. Multiple instances might exist.

A group item defining any other instructions for the transport not covered in the description of transport mode, vehicle, unit, and loading characteristics or defining an alternative description for the categories mentioned above.

ResourceInformation

ResourceInformation is optional. A single instance might exist.

A group item that contains information for specification of resources.

OtherDate

OtherDate is optional. Multiple instances might exist.

A date that may not be specifically detailed within a document (example: print date at the PurchaseOrderLineItem).

AdditionalItemInfo

AdditionalItemInfo is optional. Multiple instances might exist.

A grouping element that contains information about additional items specified by an agency. Restricted use of this element is recommended.

AdditionalText

AdditionalText is optional. Multiple instances might exist.

A text field that is used to communicate information not previously defined or for special instructions. To be used only for circumstances not covered by specific elements.

OrderConfirmationHeaderStatusType [attribute]

An attribute defining the status of the OrderConfirmation header

This item is restricted to the following list.

attribute
OrderConfirmationHeaderStatusType
type orderConfirmationHeaderStatusType

Accepted

The supplied information is accepted.

Amended

The supplied information is changed.

Cancelled

The supplied information has been cancelled. Items that have been cancelled are not included in totals on the summary levels of the e-Document.

NoAction

The supplied information has not been amended and thereby requires no action.

Pending

The supplied information is not complete and will be updated later.

Rejected

The supplied information is rejected.

OrderConfirmationHeaderStatusTypeText

A text field that may provide detail explaining the status of the OrderConfirmationHeader.

OrderConfirmationHeaderStatusTypeText
type s72

This field is required if the OrderConfirmationHeaderStatusType is "Rejected".

When the OrderConfirmationHeaderStatusType is "Pending", the reason can be specified in this field.

Not required if the PurchaseOrder is "Accepted".

OrderConfirmationIssuedDate

The Date and optionally the Time that the OrderConfirmation was issued.

(sequence)

The sequence of items below is mandatory. A single instance is required.

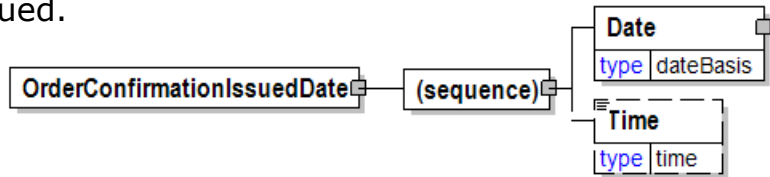

Date

Date is mandatory. A single instance is required.

A group element that contains the specification of Year, Month, and Day.

Time

Time is optional. A single instance might exist.

Times are treated in a standard XML fashion with a special case used to indicate a generalized "local" time. The standard XML approach to time is hh:mm:ss, hh:mm:ssZ, or hh:mm:ss±hh:mm.

hh:mm:ss±hh:mm is used to represent a time with a time zone. The time zone is communicated as the number of hours offset from the Universal Time Coordinate (UTC), a.k.a. Greenwich Mean Time.

hh:mm:ssZ indicates the time at Zulu (another name for UTC).

hh:mm:ss or hh:mm indicates within papiNet the applicable local time where the associated event is taking place. Caution should be used when processing times of this nature as the papiNet approach may be in discord with other users of XML.

OrderConfirmationLineItem

The detail of the items that are communicated in the OrderConfirmation e-Document.

OrderConfirmationLineItemStatusType [attribute]

OrderConfirmationLineItemStatusType is mandatory. A single instance is required.

Defines the status of the OrderConfirmation line item
Refer to OrderConfirmationLineItemStatusType definition for any enumerations.

OrderConfirmationLineItemDocumentStatus [attribute]

OrderConfirmationLineItemDocumentStatus is optional. A single instance might exist.

Defines the actual document status for the OrderConfirmationLineItem.

Refer to OrderConfirmationLineItemDocumentStatus definition for any enumerations.

Billable [attribute]

Billable is optional. A single instance might exist.

Either "Yes" or "No".

Refer to Billable definition for any enumerations.

(sequence)

The sequence of items below is mandatory. A single instance is required.

OrderConfirmationLineItemNumber

OrderConfirmationLineItemNumber is optional. A single instance might exist.

The sequential number that uniquely identifies the OrderConfirmation line item.

OrderConfirmationLineItemStatusTypeText

OrderConfirmationLineItemStatusTypeText is optional. A single instance might exist.

A text field that may provide detail explaining the status of the OrderConfirmationLineItem.

When a PurchaseOrderLineItem is rejected, the reason for the rejection must be specified in this field.

Not required if the PurchaseOrder is accepted or no changes have been made.

If the item is pending, the reason may be specified here.

PurchaseOrderLineItemNumber

PurchaseOrderLineItemNumber is optional. A single instance

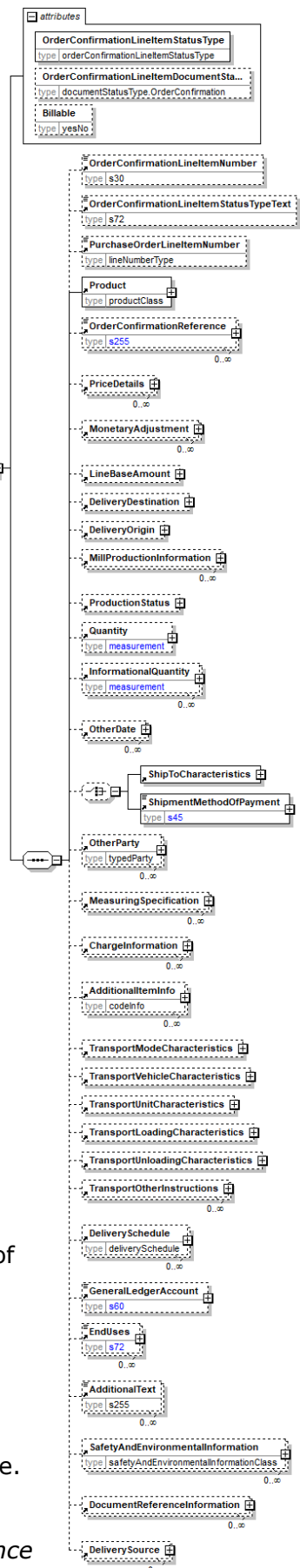

might exist.

The sequential number that uniquely identifies the PurchaseOrder line item.

Product

Product is mandatory. A single instance is required.

Product is a group item defining the article and its characteristics. Product is used to specify product characteristics organized by ProductIdentifier, ProductDescription, and Classification. Book Manufacturing, Label Stock, Paper, Pulp, Recovered Paper, Wood Products, and Virgin Fibre market segments have defined their product characteristics and conversion features for implementation in papiNet.

OrderConfirmationReference

OrderConfirmationReference is optional. Multiple instances might exist.

A group item detailing relevant references pertaining to the OrderConfirmation. Typically, the ContractNumber is referenced. OrderConfirmationReferenceType provides the identification of what the reference represents.

PriceDetails

PriceDetails is optional. Multiple instances might exist.

An element that groups together price information.

MonetaryAdjustment

MonetaryAdjustment is optional. Multiple instances might exist.

The element containing the information necessary for the understanding, calculation, and treatment of an adjustment to a currency amount. MonetaryAdjustment contains an attribute that indicates the type of adjustment being communicated.

LineBaseAmount

LineBaseAmount is optional. A single instance might exist.

For the particular e-Document being communicated the LineBaseAmount represents the quantity times the base unit price.

DeliveryDestination

DeliveryDestination is optional. A single instance might exist.

The DeliveryDestination specifies the end of one leg of the delivery. In order to comply with the US Trade Act of 2002 you would use this element with a LocationParty/@PartyType of Port.

DeliveryOrigin

DeliveryOrigin is optional. A single instance might exist.

A group item that represents the start of one leg in a route. Compare to DeliveryDestination.

The DeliveryOrigin specifies the start of one leg of the delivery.

In order to comply with the US Trade Act of 2002 you would use this element with a LocationParty/@PartyType of Port.

MillProductionInformation

MillProductionInformation is optional. Multiple instances might exist.

A grouping element that contains information about production at the mill.

ProductionStatus

ProductionStatus is optional. A single instance might exist.

A group item used to communicate the release of a delivery line number.

Quantity

Quantity is optional. A single instance might exist.

The Quantity element contains attributes that provide information about the type of quantity that is being communicated, the context in which the particular quantity is to be viewed, and (if the quantity represents an adjustment) an adjustment type.

The Quantity element contains three child elements that enable you to communicate a range of values for the quantity and a target or actual value. It is at this level (Value, RangeMin, and RangeMax) that the unit of measure is specified. This permits the range to be specified in a different unit of measure than the target.

InformationalQuantity

InformationalQuantity is optional. Multiple instances might exist.

A quantity given in a valid UOM used for information purposes only (not for calculation). For example, an ordered quantity was 100 reels as opposed to the invoice quantity of 20,000 pounds.

OtherDate

OtherDate is optional. Multiple instances might exist.

A date that may not be specifically detailed within a document (example: print date at the PurchaseOrderLineItem).

(choice)

[choice] is optional. A single instance might exist.

ShipToCharacteristics

ShipToCharacteristics is mandatory. A single instance is required.

A group item that provides information important for the Ship-To Party.

ShipmentMethodOfPayment

ShipmentMethodOfPayment is mandatory. A single instance is required.

An element communicating responsibility of freight payment and when transfer of ownership will occur.

OtherParty

OtherParty is optional. Multiple instances might exist.

An organisation or business entity other than those specifically detailed within an e-Document.

MeasuringSpecification

MeasuringSpecification is optional. Multiple instances might exist.

A grouping element that contains a specification for measurement procedures for a measuring party at a measuring location

ChargeInformation

ChargeInformation is optional. Multiple instances might exist.

A group element that contains elements that describe a charge. ChargeInformation is used when charge details need to be specified by using a code assigned by an agency. It is typically used for freight costs and other costs related to the supply chain.

AdditionalItemInfo

AdditionalItemInfo is optional. Multiple instances might exist.

A grouping element that contains information about additional items specified by an agency. Restricted use of this element is recommended.

TransportModeCharacteristics

TransportModeCharacteristics is optional. A single instance might exist.

A group item defining the primary mode of transport.

TransportVehicleCharacteristics

TransportVehicleCharacteristics is optional. A single instance might exist.

A group item containing information about a transport vehicle, e.g. a truck. A transport vehicle has its own power and can be used to pull, push, carry, or tow a transport unit loaded with goods.

TransportUnitCharacteristics

TransportUnitCharacteristics is optional. A single instance might exist.

A group item containing information about a transport unit, e.g. a trailer. Transport units contain goods and move using power from another source, the transport vehicle.

TransportLoadingCharacteristics

TransportLoadingCharacteristics is optional. A single instance might exist.

A group item defining how the transported items are to be loaded.

TransportUnloadingCharacteristics

TransportUnloadingCharacteristics is optional. A single instance might exist.

A group item defining how the transported items are to be unloaded.

TransportOtherInstructions

TransportOtherInstructions is optional. Multiple instances might exist.

A group item defining any other instructions for the transport not covered in the description of transport mode, vehicle, unit, and loading characteristics or defining an alternative description for the categories mentioned above.

DeliverySchedule

DeliverySchedule is optional. Multiple instances might exist.

A group item defining a series of DeliveryDateWindow(s) in which specified quantities must be delivered.

GeneralLedgerAccount

GeneralLedgerAccount is optional. A single instance might exist.

The general ledger account to be referenced for the item.

EndUses

EndUses is optional. Multiple instances might exist.

A text element used to express in human readable form a list of applicable end uses for a product. Examples of end uses are:

Magazine

Book

Commercial print

etc

AdditionalText

AdditionalText is optional. Multiple instances might exist.

A text field that is used to communicate information not previously defined or for special instructions. To be used only for circumstances not covered by specific elements.

SafetyAndEnvironmentalInformation

SafetyAndEnvironmentalInformation is optional. Multiple instances might exist.

Name of certification type, if any, on the goods (For example, FSC, PEFC). SafetyAndEnvironmental needs a value or measurement to communicate the percentage of the product is certified (for example, 75% is certified by the indicated agency).

DocumentReferenceInformation

DocumentReferenceInformation is optional. Multiple instances might exist.

A group item containing reference information applicable to a document.

DeliverySource

DeliverySource is optional. Multiple instances might exist.

A grouping element with information that identifies and specifies the source of a delivery, e.g. a logging area.

OrderConfirmationLineItemDocumentStatus [attribute]

Defines the actual document status for the OrderConfirmationLineItem.

This item is restricted to the following list.

<i>attribute</i>
OrderConfirmationLineItemDocumentStatus
<i>type</i> documentStatusType.OrderConfirmation

Cancelled

The supplied information of the document item is cancelled. Items that have been cancelled are not included in totals on the summary level of e-Documents.

Confirmed

The supplied information of the document item is agreed. If a requested change or cancellation of an existing document item can not be accepted, then the earlier agreed information of the document item will be re-confirmed.

Pending

The supplied information of the document item is being investigated.

Rejected

The supplied information of the document item can not be accepted. The document item is new or not earlier confirmed.

OrderConfirmationLineItemDocumentStatus [attribute]

Defines the actual document status for the OrderConfirmationLineItem.

This item is restricted to the following list.

attribute
OrderConfirmationLineItemDocumentStatus
type documentStatusType.OrderConfirmationWood

Cancelled

The supplied information of the document item is cancelled. Items that have been cancelled are not included in totals on the summary level of e-Documents.

Confirmed

The supplied information of the document item is agreed. If a requested change or cancellation of an existing document item can not be accepted, then the earlier agreed information of the document item will be re-confirmed.

Pending

The supplied information of the document item is being investigated.

Rejected

The supplied information of the document item can not be accepted. The document item is new or not earlier confirmed.

OrderConfirmationLineItemNumber

The sequential number that uniquely identifies the OrderConfirmation line item.

OrderConfirmationLineItemNumber
type s30

OrderConfirmationLineItemStatusType [attribute]

Defines the status of the OrderConfirmation line item

This item is restricted to the following list.

attribute
OrderConfirmationLineItemStatusType
type orderConfirmationLineItemStatusType

Accepted

The supplied information is accepted.

Amended

The supplied information is changed

Cancelled

The supplied information has been cancelled. Items that have been cancelled are not included in totals on the summary levels of the e-Documents.

NoAction

The supplied information has not been amended and thereby requires no action.

Pending

papiNet V2R31

The supplied information is not complete and will be updated later.

Rejected

The supplied information is rejected.

OrderConfirmationLineItemStatusTypeText

A text field that may provide detail explaining the status of the OrderConfirmationLineItem.

OrderConfirmationLineItemStatusTypeText	
type	s72

When a PurchaseOrderLineItem is rejected, the reason for the rejection must be specified in this field.

Not required if the PurchaseOrder is accepted or no changes have been made.

If the item is pending, the reason may be specified here.

OrderConfirmationNumber

The unique order identifier as designated by the seller.

OrderConfirmationNumber	
type	s30

OrderConfirmationReference

A group item detailing relevant references pertaining to the

OrderConfirmationReference	
type	s255

attributes	
OrderConfirmationReferenceType	
type	referenceType
AssignedBy	
type	assignedBy

OrderConfirmation. Typically, the ContractNumber is referenced.

OrderConfirmationReferenceType provides the identification of what the reference represents.

OrderConfirmationReferenceType [attribute]

OrderConfirmationReferenceType is mandatory. A single instance is required.

Provides a contextual explanation of the specific reference identifier. Many items are currently prefixed by "Buyer", "Forwarder", "Manufacturer", "Mill", "Seller", "Supplier", "Warehouse", or "Vendor". Check for an existing non-prefixed version and use the non-prefixed version instead. In the (yet to be announced release date) version 3.0 the prefixed versions will be removed. Instead the attribute @AssignedBy will communicate the information previously communicated in the prefix.

Refer to OrderConfirmationReferenceType definition for any enumerations.

AssignedBy [attribute]

AssignedBy is optional. A single instance might exist.

Identifies the type of party or the agency that has assigned the associated item, e.g. a reference of type OrderNumber.

Refer to AssignedBy for any enumerations.

OrderConfirmationReferenceType [attribute]

Provides a contextual explanation of the specific reference identifier. Many items are currently prefixed by "Buyer", "Forwarder", "Manufacturer", "Mill", "Seller", "Supplier", "Warehouse", or "Vendor". Check for an

existing non-prefixed version and use the non-prefixed version instead. In the (yet to be announced release date) version 3.0 the prefixed versions will be removed. Instead the attribute @AssignedBy will communicate the information previously communicated in the prefix.

Refer to the [referenceType](#) entry for the list of enumerations and their definitions.

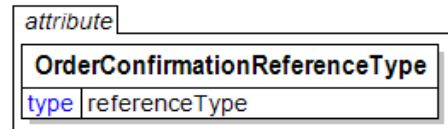

OrderConfirmationStatusType [attribute]

Identifies the status of the whole OrderConfirmation e-Document (i.e. at the root level)

This item is restricted to the following list.

Accepted

The supplied information is accepted.

Amended

The supplied information is changed.

Cancelled

The supplied information has been cancelled. Items that have been cancelled are not included in totals on the summary levels of the e-Document.

Rejected

The supplied information is rejected.

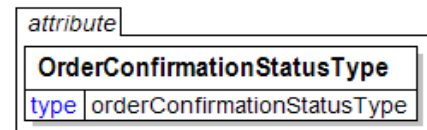

OrderConfirmationSummary

Summary information that applies to the whole OrderConfirmation e-Document.

(sequence)

The sequence of items below is mandatory. A single instance is required.

TotalNumberOfLineItems

TotalNumberOfLineItems is optional. A single instance might exist.

The total number of individual line items in the document, regardless of the status or type.

(sequence)

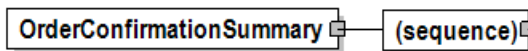

The sequence of items below is optional. Multiple instances might exist.

TotalQuantity

TotalQuantity is mandatory. A single instance is required.

The total quantity of similar items in the e-Document. TotalQuantity is primarily used in the summary section of documents where it is repeatable to permit totaling for different units of measure.

TotalInformationalQuantity

TotalInformationalQuantity is optional. Multiple instances might exist.

A quantity that is used to communicate related information about the parent element. This element represents a total that is derived from individual line items.

LineItemSubTotal

LineItemSubTotal is optional. A single instance might exist.

The total amount of all base amounts on e-Document line items. The base amount contains the result of the calculation quantity times the base unit price. As such it does not include any taxes. For example, in an Invoice LineItemSubTotal is equal to the sum of all InvoiceLineBaseAmount.

TotalAdjustments

TotalAdjustments is optional. A single instance might exist.

The CurrencyValue of TotalAdjustments contains the total of all adjustments and charges excluding tax. For example, in the Invoice TotalAdjustments is equal to the sum of the signed values of the MonetaryAdjustmentAmount for all instances of MonetaryAdjustment with PriceAdjustment and FlatAmountAdjustment and plus the sum of the signed values of the ChargeNetAmount for all instances of

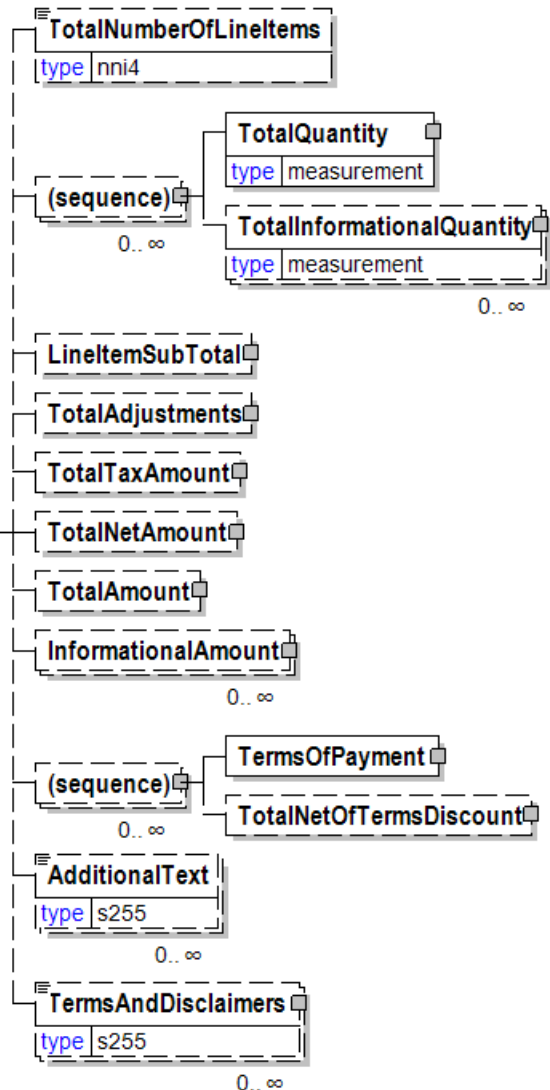

ChargeInformation.

TotalTaxAmount

TotalTaxAmount is optional. A single instance might exist.

The CurrencyValue of TotalTaxAmount contains the sum of all instances of TaxAdjustment in the document. TotalTaxAmount contains the sum of all instances of the MonetaryAdjustmentAmount for tax adjustments.

TotalNetAmount

TotalNetAmount is optional. A single instance might exist.

A field containing total amount excluding tax. For example, in the Invoice TotalNetAmount is equal to the sum of LineItemSubTotal plus TotalAdjustments. TotalNetAmount encapsulates CurrencyValue.

TotalAmount

TotalAmount is optional. A single instance might exist.

The total amount including tax (when tax is specified in the e-Document).

In e-Documents claiming payment this is the amount due for payment based on the terms of payment. Decimal rounding might be applied to this amount.

InformationalAmount

InformationalAmount is optional. Multiple instances might exist.

A monetary amount used for information purposes only (not for calculation). For example, the invoice price adjustment subtotal is expressed in sterling pounds, and the buyer wants this information expressed in U.S. dollars.

CreditDebitNote and Invoice - The TaxAmount is displayed in the currency that is applicable throughout the e-Document. When a TaxAmount needs to be displayed in a different national currency, this field is used.

(sequence)

The sequence of items below is optional. Multiple instances might exist.

TermsOfPayment

TermsOfPayment is mandatory. A single instance is required.

A group item that contains agreed-to terms defining when, how, and under what conditions the payment is to be made.

When TermsOfPayment is optional; if omitted, TermsOfPayment is controlled through previous negotiation.

TotalNetOfTermsDiscount

TotalNetOfTermsDiscount is optional. A single instance might exist.

The components of the amount to be paid if prompt payment discount terms are met, including the amount that is subject to the payment terms discount, the discount amount, and the amount due after prompt payment discount.

AdditionalText

AdditionalText is optional. Multiple instances might exist.

A text field that is used to communicate information not previously defined or for special instructions. To be used only for circumstances not covered by specific elements.

TermsAndDisclaimers

TermsAndDisclaimers is optional. Multiple instances might exist.

An element that contains legal information with an indication of what the Language is.

OrderConfirmationWood

The OrderConfirmationWood element is the root element for the OrderConfirmationWood e-Document.

A seller sends an OrderConfirmationWood e-Document to a buyer after receiving a PurchaseOrder from that buyer. The e-Document contains a response to the conditions specified in the PurchaseOrder. A supplier may also send an OrderConfirmationWood e-Document to convey changes that the supplier has made in the order or to convey new information such as a Supplier Reference Number or Job Number.

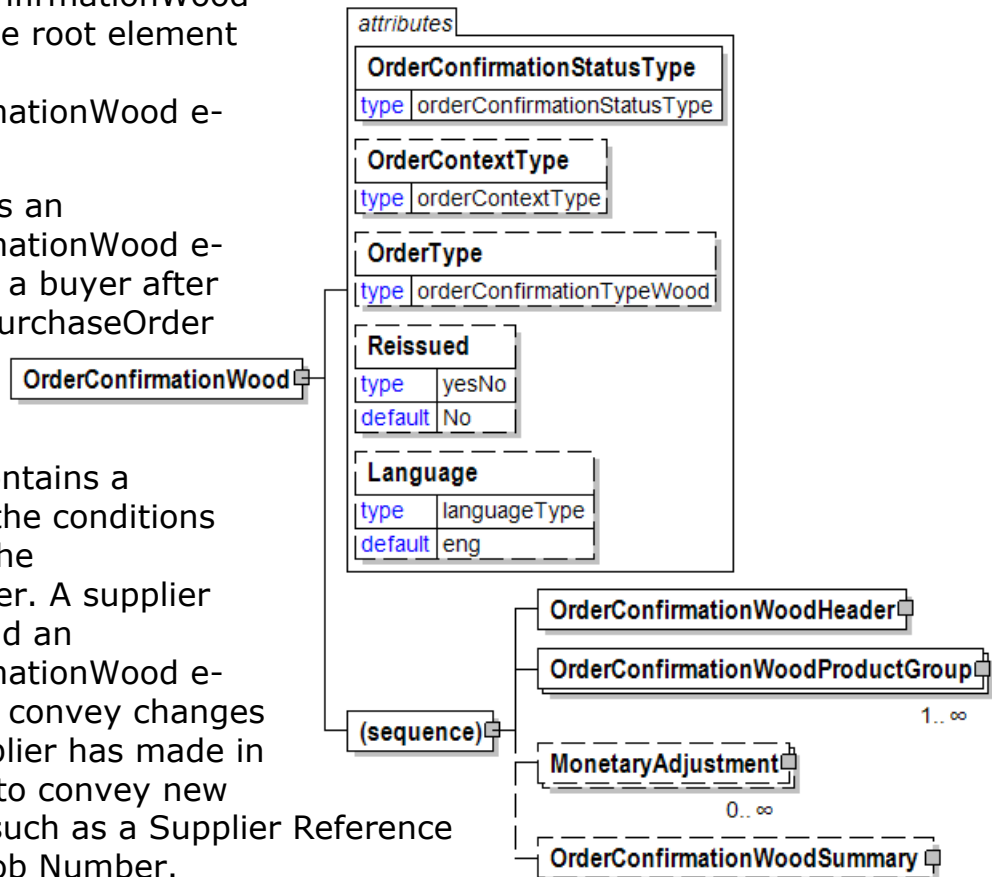

OrderConfirmationStatusType [attribute]

OrderConfirmationStatusType is mandatory. A single instance is required.

Identifies the status of the whole OrderConfirmation e-Document (i.e. at the root level)

Refer to OrderConfirmationStatusType definition for any enumerations.

OrderContextType [attribute]

OrderContextType is optional. A single instance might exist.

Qualifies the source of the PurchaseOrder.

Refer to OrderContextType definition for any enumerations.

OrderType [attribute]

OrderType is optional. A single instance might exist.

Defines the type of OrderConfirmationWood being communicated.

Refer to OrderType definition for any enumerations.

Reissued [attribute]

Reissued is optional. A single instance might exist.

Either "Yes" or "No".

Refer to Reissued definition for any enumerations.

Language [attribute]

Language is optional. A single instance might exist.

The valid Alpha 2- and Alpha 3-character list of language codes in the ISO 639-1 and 639-2 international standards.

Information on the content of this attribute is available at:
https://www.loc.gov/standards/iso639-2/php/code_list.php

(sequence)

The sequence of items below is mandatory. A single instance is required.

OrderConfirmationWoodHeader

OrderConfirmationWoodHeader is mandatory. A single instance is required.

OrderConfirmationWoodHeader contains information that is consistent across the entire document.

OrderConfirmationWoodProductGroup

OrderConfirmationWoodProductGroup is mandatory. One instance is required, multiple instances might exist.

Group element used to potentially group like products together. Construct consists of a product group id, line items, and a product grouping summary.

MonetaryAdjustment

MonetaryAdjustment is optional. Multiple instances might exist.

The element containing the information necessary for the understanding, calculation, and treatment of an adjustment to a currency amount. MonetaryAdjustment contains an attribute that indicates they type of adjustment being communicated.

OrderConfirmationWoodSummary

OrderConfirmationWoodSummary is optional. A single instance might exist.

Summary information that applies to the Wood market segment OrderConfirmationWood e-Document.

OrderConfirmationWoodHeader

OrderConfirmationWoodHeader contains information that is consistent across the entire document.

OrderConfirmationHeaderStatusType [attribute]

OrderConfirmationHeaderStatusType is mandatory. A single instance is required.

An attribute defining the status of the OrderConfirmationWood header

Refer to

OrderConfirmationWoodHeader

OrderConfirmationHeaderStatusType definition for any enumerations.

(sequence)

The sequence of items below is mandatory. A single instance is required.

OrderConfirmationNumber

OrderConfirmationNumber is optional. A single instance might exist.

The unique order identifier as designated by the seller.

OrderConfirmationHeaderStatusTypeText

OrderConfirmationHeaderStatusTypeText is optional. A single instance might exist.

A text field that may provide detail explaining the status of the OrderConfirmationHeader.

This field is required if the OrderConfirmationHeaderStatusType is "Rejected".

When the OrderConfirmationHeaderStatusType is "Pending", the reason can be specified in this field.

Not required if the PurchaseOrder is "Accepted".

OrderConfirmationIssuedDate

OrderConfirmationIssuedDate is mandatory. A single instance is required.

The Date and optionally the Time that the OrderConfirmation was issued.

TransactionHistoryNumber

TransactionHistoryNumber is optional. A single instance might exist.

A sequential number that keeps track of the version of a document.

However when the document is a confirmation document, in which case the TransactionHistoryNumber refers to the trigger transaction for the confirmation.

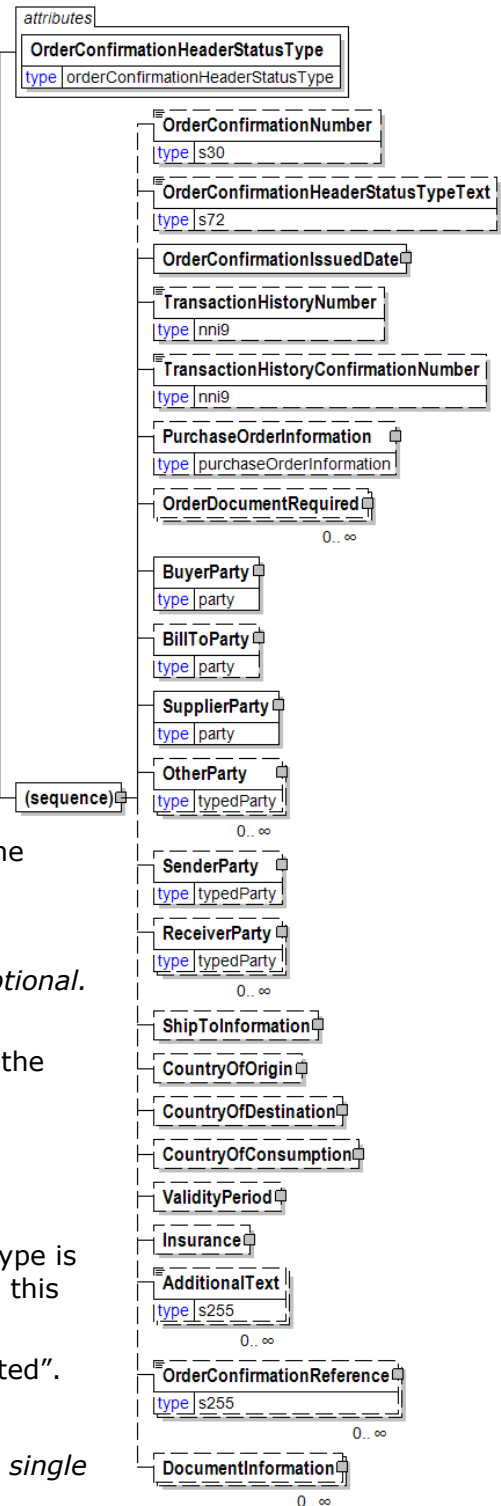

TransactionHistoryConfirmationNumber

TransactionHistoryConfirmationNumber is optional. A single instance might exist.

A sequential number that keeps track the version of a confirmation document.

When the document is a confirmation document, then the TransactionHistoryNumber refers to the trigger transaction for the confirmation.

PurchaseOrderInformation

PurchaseOrderInformation is optional. A single instance might exist.

A group item containing information unique to this PurchaseOrder, which is provided by the buyer. PurchaseOrderInformation can be optional in the supply chain. Invoices are created without having a PurchaseOrder in Vendor Managed Inventory. Freight invoices also will not have a PurchaseOrder number.

OrderDocumentRequired

OrderDocumentRequired is optional. Multiple instances might exist.

Group element used to identify any external documents that need to be referenced and how many of those documents are required. Typically, used to identify hard copy documents.

OrderDocumentRequired will be deprecated in a future version V3R00. Use the DocumentInformation element instead.

BuyerParty

BuyerParty is mandatory. A single instance is required.

The legal entity to which the product is sold. Also commonly referred to as the sold-to party or customer. If no OtherParty is defined as the Payer, the Buyer is the Payer.

BillToParty

BillToParty is optional. A single instance might exist.

The address where the invoice is to be sent.

SupplierParty

SupplierParty is mandatory. A single instance is required.

The organisation or business entity responsible for providing the product. SupplierParty is also the seller of the product, if Seller is not specified as OtherParty = Seller.

OtherParty

OtherParty is optional. Multiple instances might exist.

An organisation or business entity other than those specifically detailed within an e-Document.

SenderParty

SenderParty is optional. A single instance might exist.

The business entity issuing the e-Document, the source of the document.

The entity responsible for the content. If the sender party has out sourced the message service to a third party the SenderParty is the issuer of the e-Document and not the party performing the transmission service of the electronic message.

ReceiverParty

ReceiverParty is optional. Multiple instances might exist.

The business entity for whom the e-Document is intended, the destination of the document.

The entity interested in the content. If the receiver party has outsourced the message service to a third party the ReceiverParty is the intended party for the e-Document and not the party performing the receiving service of the electronic message.

ShipToInformation

ShipToInformation is optional. A single instance might exist.

Group element containing information about the ship to and delivery of a product.

CountryOfOrigin

CountryOfOrigin is optional. A single instance might exist.

The country of origin for the material.

CountryOfDestination

CountryOfDestination is optional. A single instance might exist.

The country where the goods will be, or were, shipped to.

CountryOfConsumption

CountryOfConsumption is optional. A single instance might exist.

The country of consumption for the material.

ValidityPeriod

ValidityPeriod is optional. A single instance might exist.

The validity period for a specific item, e.g. the validity period for an e-Document.

Insurance

Insurance is optional. A single instance might exist.

Group element containing information about insurance

AdditionalText

AdditionalText is optional. Multiple instances might exist.

A text field that is used to communicate information not previously defined or for special instructions. To be used only for circumstances not covered by specific elements.

OrderConfirmationReference

OrderConfirmationReference is optional. Multiple instances might exist.

A group item detailing relevant references pertaining to the OrderConfirmation. Typically, the ContractNumber is referenced. OrderConfirmationReferenceType provides the identification of what the reference represents.

DocumentInformation

DocumentInformation is optional. Multiple instances might exist.

A group element containing a specification of required documents in the business process. Additional free text to be printed on documents can also be specified.

OrderConfirmationWoodLineItem

The details of the line items that are communicated on the Wood market segment OrderConfirmationWood.

OrderConfirmationLineItemStatusType [attribute]

OrderConfirmationLineItemStatusType is mandatory. A single instance is required.

Defines the status of the OrderConfirmation line item

Refer to OrderConfirmationLineItemStatusType definition for any enumerations.

OrderConfirmationWoodLineItem

OrderConfirmationLineItemDocumentStatus [attribute]

OrderConfirmationLineItemDocumentStatus is optional. A single instance might exist.

Defines the actual document status for the OrderConfirmationLineItem.

Refer to OrderConfirmationLineItemDocumentStatus definition for any enumerations.

(sequence)

The sequence of items below is mandatory. A single instance is required.

OrderConfirmationLineItemNumber

OrderConfirmationLineItemNumber is optional. A single instance might exist.

The sequential number that uniquely identifies the OrderConfirmation line item.

OrderConfirmationLineItemStatusTypeText

OrderConfirmationLineItemStatusTypeText is

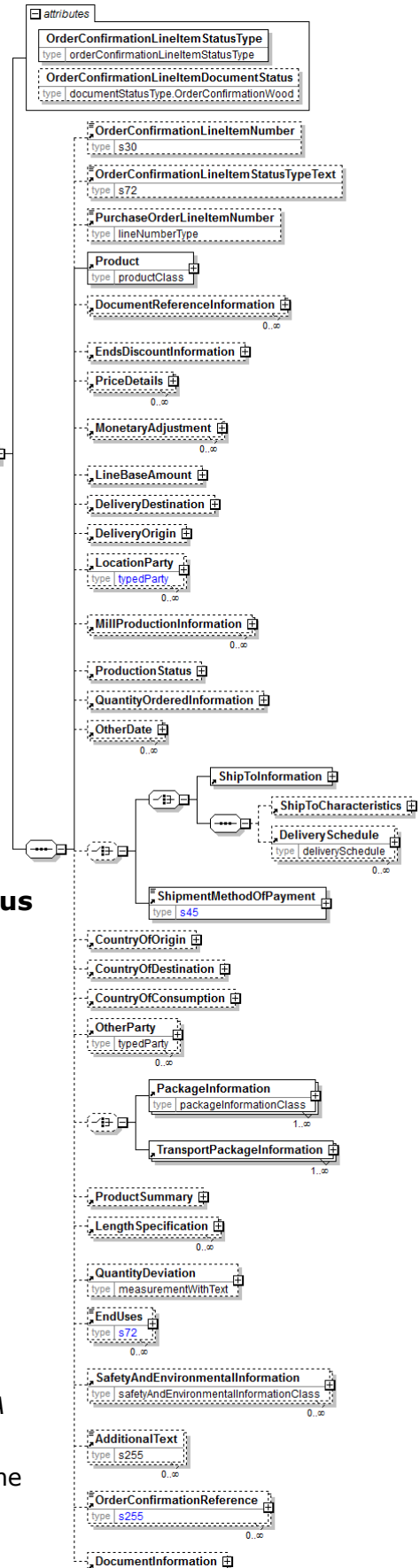

optional. A single instance might exist.

A text field that may provide detail explaining the status of the OrderConfirmationLineItem.

When a PurchaseOrderLineItem is rejected, the reason for the rejection must be specified in this field.

Not required if the PurchaseOrder is accepted or no changes have been made.

If the item is pending, the reason may be specified here.

PurchaseOrderLineItemNumber

PurchaseOrderLineItemNumber is optional. A single instance might exist.

The sequential number that uniquely identifies the PurchaseOrder line item.

Product

Product is mandatory. A single instance is required.

Product is a group item defining the article and its characteristics. Product is used to specify product characteristics organized by ProductIdentifier, ProductDescription, and Classification. Book Manufacturing, Label Stock, Paper, Pulp, Recovered Paper, Wood Products, and Virgin Fibre market segments have defined their product characteristics and conversion features for implementation in papiNet.

DocumentReferenceInformation

DocumentReferenceInformation is optional. Multiple instances might exist.

A group item containing reference information applicable to a document.

EndsDiscountInformation

EndsDiscountInformation is optional. A single instance might exist.

Rule for calculating the ends discount, expressed by a code.

PriceDetails

PriceDetails is optional. Multiple instances might exist.

An element that groups together price information.

MonetaryAdjustment

MonetaryAdjustment is optional. Multiple instances might exist.

The element containing the information necessary for the understanding, calculation, and treatment of an adjustment to a currency amount. MonetaryAdjustment contains an attribute that indicates they type of adjustment being communicated.

LineBaseAmount

LineBaseAmount is optional. A single instance might exist.

For the particular e-Document being communicated the LineBaseAmount represents the quantity times the base unit price.

DeliveryDestination

DeliveryDestination is optional. A single instance might exist.

The DeliveryDestination specifies the end of one leg of the delivery. In order to comply with the US Trade Act of 2002 you would use this element with a LocationParty/@PartyType of Port.

DeliveryOrigin

papiNet V2R31

DeliveryOrigin is optional. A single instance might exist.

A group item that represents the start of one leg in a route. Compare to DeliveryDestination.

The DeliveryOrigin specifies the start of one leg of the delivery.

In order to comply with the US Trade Act of 2002 you would use this element with a LocationParty/@PartyType of Port.

LocationParty

LocationParty is optional. Multiple instances might exist.

The organization or business entity where the business event took place or will take place.

MillProductionInformation

MillProductionInformation is optional. Multiple instances might exist.

A grouping element that contains information about production at the mill.

ProductionStatus

ProductionStatus is optional. A single instance might exist.

A group item used to communicate the release of a delivery line number.

QuantityOrderedInformation

QuantityOrderedInformation is optional. A single instance might exist.

Used to identify quantity. The construct provides via InformationalQuantity the ability to provide the Quantity in another UOM. Length is also provided to further specify the quantity.

OtherDate

OtherDate is optional. Multiple instances might exist.

A date that may not be specifically detailed within a document (example: print date at the PurchaseOrderLineItem).

(choice)

[choice] is optional. A single instance might exist.

ShipToInformation

ShipToInformation is mandatory. A single instance is required.

Group element containing information about the ship to and delivery of a product.

(sequence)

The sequence of items below is mandatory. A single instance is required.

ShipToCharacteristics

ShipToCharacteristics is optional. A single instance might exist.

A group item that provides information important for the Ship-To Party.

DeliverySchedule

DeliverySchedule is optional. Multiple instances might exist.

A group item defining a series of DeliveryDateWindow(s) in which specified quantities must be delivered.

ShipmentMethodOfPayment

ShipmentMethodOfPayment is mandatory. A single instance is required.

An element communicating responsibility of freight payment and when transfer of ownership will occur.

CountryOfOrigin

CountryOfOrigin is optional. A single instance might exist.

The country of origin for the material.

CountryOfDestination

CountryOfDestination is optional. A single instance might exist.

The country where the goods will be, or were, shipped to.

CountryOfConsumption

CountryOfConsumption is optional. A single instance might exist.

The country of consumption for the material.

OtherParty

OtherParty is optional. Multiple instances might exist.

An organisation or business entity other than those specifically detailed within an e-Document.

(choice)

[choice] is optional. A single instance might exist.

PackageInformation

PackageInformation is mandatory. One instance is required, multiple instances might exist.

The purpose of the PackageInformation structure is to clearly identify physical handling items that constitute the delivery.

PackageInformation is the highest level of product packaging it describes the shipping or warehousing unit.

If you are communicating a package, usually for logistics or transport purposes, you should include the PackageType, Identifier, ItemCount, and Quantity. (Note: you still have the ability to describe the item with one of the "named" items.)

If you are communicating one of the named Items there is no need to include PackageType, Identifier, ItemCount, and Quantity.

Since either of these two approaches can be used the entire contents of this element are optional even though the parent may be required. It is expected that you will fill in the appropriate details.

TransportPackageInformation

TransportPackageInformation is mandatory. One instance is required, multiple instances might exist.

Information of a package used in transportation, can include several normal packages.

ProductSummary

ProductSummary is optional. A single instance might exist.

Group of elements to provide summary information on product level.

LengthSpecification

LengthSpecification is optional. Multiple instances might exist.

papiNet V2R31

Length specification of the wood product.

QuantityDeviation

QuantityDeviation is optional. A single instance might exist.

To be deprecated in a future version V3R00. Use the Quantity element with a QuantityContext of "Deviation".

EndUses

EndUses is optional. Multiple instances might exist.

A text element used to express in human readable form a list of applicable end uses for a product. Examples of end uses are:

- Magazine
- Book
- Commercial print
- etc

SafetyAndEnvironmentalInformation

SafetyAndEnvironmentalInformation is optional. Multiple instances might exist.

Name of certification type, if any, on the goods (For example, FSC, PEFC). SafetyAndEnvironmental needs a value or measurement to communicate the percentage of the product is certified (for example, 75% is certified by the indicated agency).

AdditionalText

AdditionalText is optional. Multiple instances might exist.

A text field that is used to communicate information not previously defined or for special instructions. To be used only for circumstances not covered by specific elements.

OrderConfirmationReference

OrderConfirmationReference is optional. Multiple instances might exist.

A group item detailing relevant references pertaining to the OrderConfirmation. Typically, the ContractNumber is referenced. OrderConfirmationReferenceType provides the identification of what the reference represents.

DocumentInformation

DocumentInformation is optional. A single instance might exist.

A group element containing a specification of required documents in the business process. Additional free text to be printed on documents can also be specified.

OrderConfirmationWoodProductGroup

Group element used to potentially group like products together. Construct consists of a product group id, line items, and a product

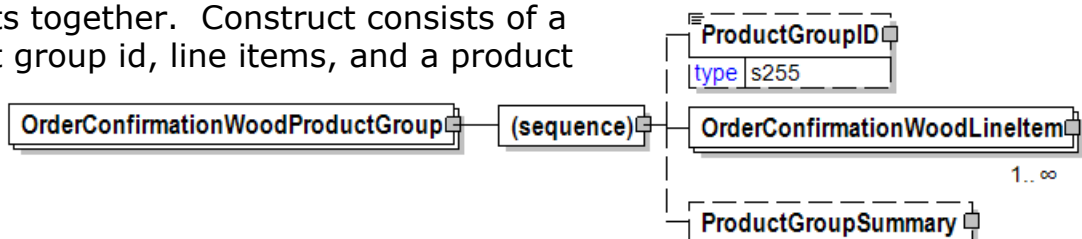

grouping summary.

(sequence)

The sequence of items below is mandatory. A single instance is required.

ProductGroupID

ProductGroupID is optional. A single instance might exist.

Possibility to group packages or Shipments. Example: Creating temporary group ID's for logistic reasons or lot number.

OrderConfirmationWoodLineItem

OrderConfirmationWoodLineItem is mandatory. One instance is required, multiple instances might exist.

The details of the line items that are communicated on the Wood market segment OrderConfirmationWood.

ProductGroupSummary

ProductGroupSummary is optional. A single instance might exist.

Group of elements to provide summary information on product level.

OrderConfirmationWoodSummary

Summary information that applies to the Wood market segment OrderConfirmationWood e-Document.

(sequence)

The sequence of items below is mandatory. A single instance is required.

TotalNumberOfLineItems

TotalNumberOfLineItems is optional. A single instance might exist.

The total number of individual line items in the document, regardless of the status or type.

(sequence)

The sequence of items below is optional. Multiple instances might exist.

TotalQuantity

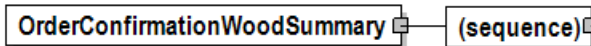

TotalQuantity is mandatory. A single instance is required.

The total quantity of similar items in the e-Document. TotalQuantity is primarily used in the summary section of documents where it is repeatable to permit totaling for different units of measure.

TotalInformationalQuantity

TotalInformationalQuantity is optional. Multiple instances might exist.

A quantity that is used to communicate related information about the parent element. This element represents a total that is derived from individual line items.

ProductSummary

ProductSummary is optional. A single instance might exist.

Group of elements to provide summary information on product level.

LengthSpecification

LengthSpecification is optional. Multiple instances might exist.

Length specification of the wood product.

QuantityDeviation

QuantityDeviation is optional. A single instance might exist.

To be deprecated in a future version V3R00. Use the Quantity element with a

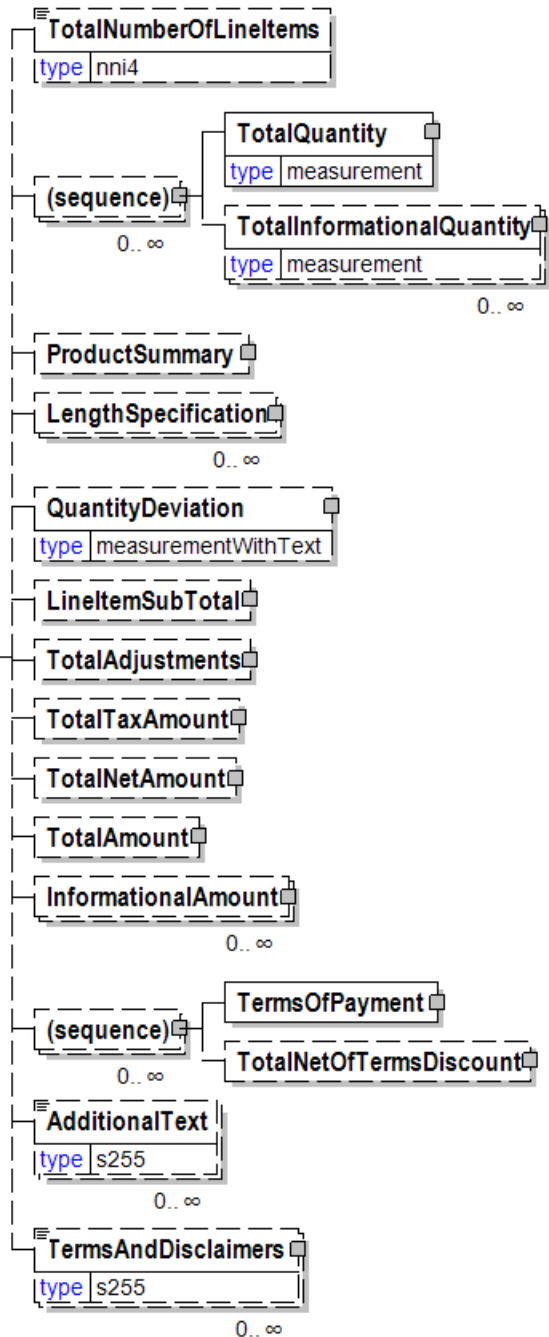

QuantityContext of "Deviation".

LineItemSubTotal

LineItemSubTotal is optional. A single instance might exist.

The total amount of all base amounts on e-Document line items. The base amount contains the result of the calculation quantity times the base unit price. As such it does not include any taxes. For example, in an Invoice claiming payment for products LineItemSubTotal is equal to the sum of all InvoiceLineBaseAmount.

TotalAdjustments

TotalAdjustments is optional. A single instance might exist.

The CurrencyValue of TotalAdjustments contains the total of all adjustments and charges excluding tax. For example, in the Invoice TotalAdjustments is equal to the sum of the signed values of the MonetaryAdjustmentAmount for all instances of MonetaryAdjustment with PriceAdjustment and FlatAmountAdjustment and plus the sum of the signed values of the ChargeNetAmount for all instances of ChargeInformation.

TotalTaxAmount

TotalTaxAmount is optional. A single instance might exist.

The CurrencyValue of TotalTaxAmount contains the sum of all instances of TaxAdjustment in the document. TotalTaxAmount contains the sum of all instances of the MonetaryAdjustmentAmount for tax adjustments.

TotalNetAmount

TotalNetAmount is optional. A single instance might exist.

A field containing total amount excluding tax. For example, in the Invoice TotalNetAmount is equal to the sum of LineItemSubTotal plus TotalAdjustments. TotalNetAmount encapsulates CurrencyValue.

TotalAmount

TotalAmount is optional. A single instance might exist.

The total amount including tax (when tax is specified in the e-Document).

In e-Documents claiming payment this is the amount due for payment based on the terms of payment. Decimal rounding might be applied to this amount.

InformationalAmount

InformationalAmount is optional. Multiple instances might exist.

A monetary amount used for information purposes only (not for calculation). For example, the invoice price adjustment subtotal is expressed in sterling pounds, and the buyer wants this information expressed in U.S. dollars.

CreditDebitNote and Invoice - The TaxAmount is displayed in the currency that is applicable throughout the e-Document. When a TaxAmount needs to be displayed in a different national currency, this field is used.

(sequence)

The sequence of items below is optional. Multiple instances might exist.

TermsOfPayment

TermsOfPayment is mandatory. A single instance is required.

A group item that contains agreed-to terms defining when, how, and under what conditions the payment is to be made.

When TermsOfPayment is optional; if omitted, TermsOfPayment is controlled

papiNet V2R31

through previous negotiation.

TotalNetOfTermsDiscount

TotalNetOfTermsDiscount is optional. A single instance might exist.

The components of the amount to be paid if prompt payment discount terms are met, including the amount that is subject to the payment terms discount, the discount amount, and the amount due after prompt payment discount.

AdditionalText

AdditionalText is optional. Multiple instances might exist.

A text field that is used to communicate information not previously defined or for special instructions. To be used only for circumstances not covered by specific elements.

TermsAndDisclaimers

TermsAndDisclaimers is optional. Multiple instances might exist.

An element that contains legal information with an indication of what the Language is.

OrderContextType [attribute]

Qualifies the source of the PurchaseOrder.

This item is restricted to the following list.

PurchaseOrder

The source is the buyer.

SalesOrder

The source is the supplier.

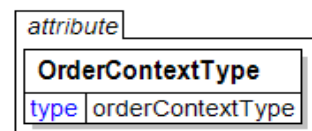

OrderDocumentRequired

Group element used to identify any external documents that need to be referenced and how many of those documents are required.

Typically, used to identify hard copy documents.

OrderDocumentRequired will be deprecated in a future version V3R00. Use the DocumentInformation element instead.

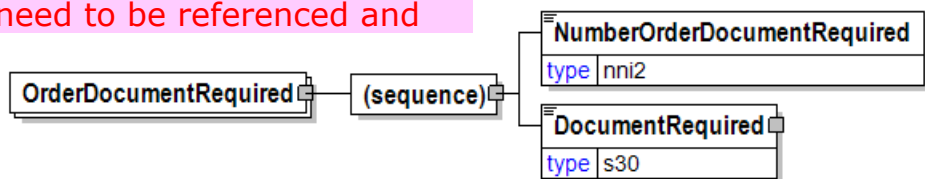

(sequence)

The sequence of items below is mandatory. A single instance is required.

NumberOrderDocumentRequired

NumberOrderDocumentRequired is mandatory. A single instance is required.

There are certain business cases whereby a party is required to reference external documents to the transaction. Additionally, in these cases, the party is required to

papiNet V2R31

communicate the number of these external documents. This element is used to indicate how many of these external documents will be required. Typically used to indicate how many hard copies of the referenced document are needed.

DocumentRequired

DocumentRequired is mandatory. A single instance is required.

An element that permits the listing of the documents required.

OrderHeaderStatusType [attribute]

Defines the status of the PurchaseOrder header

This item is restricted to the following list.

Amended

The supplied information is changed.

Cancelled

The supplied information has been cancelled. Items that have been cancelled are not included in totals on the summary levels of the e-Document.

New

The supplied information is new and supplied for the first time.

NoAction

The supplied information has not been amended and thereby requires no action.

attribute
OrderHeaderStatusType
type purchaseOrderHeaderStatusType

OrderLineItemDocumentStatus [attribute]

Defines the actual document status for the PurchaseOrderLineItem.

This item is restricted to the following list.

Cancelled

The supplied information of the document item is cancelled. Items that have been cancelled are not included in totals on the summary level of e- Documents.

Requested

The supplied information of the document item is ordered.

attribute
OrderLineItemDocumentStatus
type documentStatusType.PurchaseOrderWood

OrderLineItemStatusType [attribute]

Defines the status of the PurchaseOrder line item

This item is restricted to the following list.

Amended

attribute
OrderLineItemStatusType
type purchaseOrderLineItemStatusType

The supplied information is changed.

Cancelled

The supplied information has been cancelled. Items that have been cancelled are not included in totals on the summary levels of the e-Document.

New

The supplied information is new and supplied for the first time.

NoAction

The supplied information has not been amended and thereby requires no action.

OrderOfMatterAdditional

Group element used to identify all the information for the additional manufacturing requirements.

OrderOfMatterAdditionalType [attribute]

OrderOfMatterAdditionalType is mandatory. A single instance is required.

Specifies the additional type for order of matter.

Refer to OrderOfMatterAdditionalType definition for any enumerations.

OrderOfMatterAdditionalProcess [attribute]

OrderOfMatterAdditionalProcess is mandatory. A single instance is required.

Specifies the process requirement for the additional type for order of matter.

Refer to OrderOfMatterAdditionalProcess definition for any enumerations.

(sequence)

The sequence of items below is mandatory. A single instance is required.

PlacementInOrderOfMatter

PlacementInOrderOfMatter is optional. A single instance might exist.

Element used to identify where the component is to be placed amongst other components when assembling a book.

OrderOfMatterAdditionalValue

OrderOfMatterAdditionalValue is optional. A single instance might exist.

Value that corresponds to the OrderOfMatterAdditionalType.

SpecReference

SpecReference is optional. Multiple instances might exist.

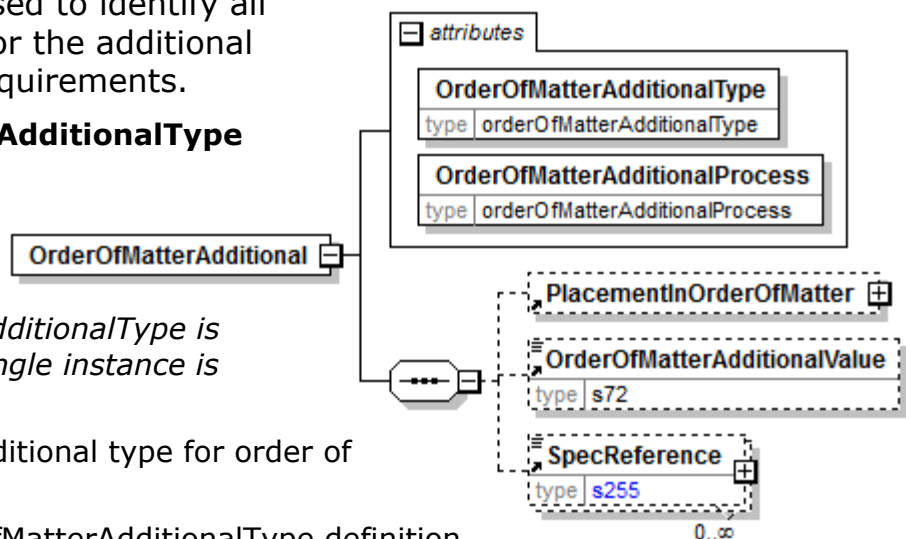

Used to identify any external or associated documents, identifiers, etc.

OrderOfMatterAdditionalProcess [attribute]

Specifies the process requirement for the additional type for order of matter.

This item is restricted to the following list.

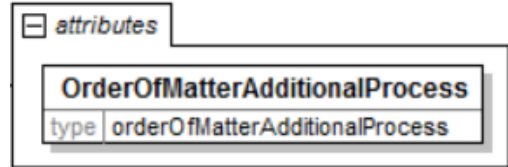

IsNotRequired

Specifies that the additional type for order of matter is not required.

IsRequired

Specifies that the additional type for order of matter is required.

StandardOperatingProcedure

Specifies that the additional type for order of matter is required and that the supplier's standard operating procedures should be followed.

OrderOfMatterAdditionalType [attribute]

Specifies the additional type for order of matter.

This item is restricted to the following list.

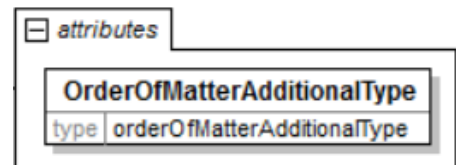

BlankPages

Specifies where blank pages that are added during the printing process to fill out a signature can be placed.

ProductionMarks

Specifies where production information should be placed.

VariableData

Specifies where variable data that changes for each book should be placed.

OrderOfMatterAdditionalValue

Value that corresponds to the OrderOfMatterAdditionalType.

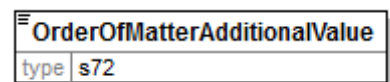

OrderPrimaryStatus

An element that contains the highest level status code pertaining to an entire order.

OrderStatusCode [attribute]

OrderStatusCode is mandatory. A single instance is required.

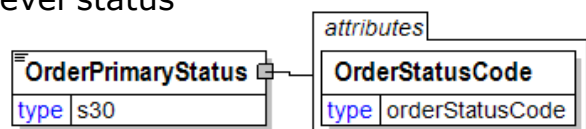

papiNet V2R31

This attribute communicates the overall status of the order.
Refer to OrderStatusCode definition for any enumerations.

OrderQuantities

An element that contains the quantities that can be used for ordering.

(sequence)

The sequence of items below is mandatory. A single instance is required.

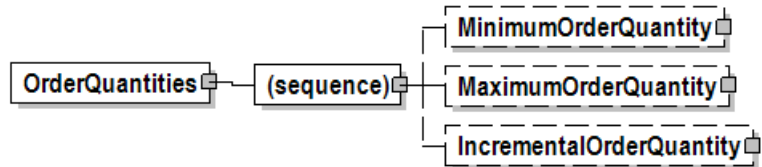

MinimumOrderQuantity

MinimumOrderQuantity is optional. A single instance might exist.

The minimum amount that can be ordered on a PurchaseOrder.

MaximumOrderQuantity

MaximumOrderQuantity is optional. A single instance might exist.

The maximum amount that can be ordered at one time.

IncrementalOrderQuantity

IncrementalOrderQuantity is optional. A single instance might exist.

An incremental quantity and units of measure that is added to MinimumOrderQuantity to arrive at an order quantity.

OrderSecondaryStatus

An element that contains a secondary status description pertaining to the entire order.

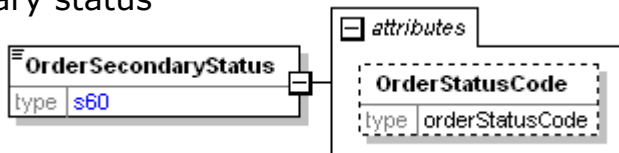

OrderStatus

The OrderStatus element is the root element for the OrderStatus e-Document.

The OrderStatus e-Document permits the sender to report the current status of an order, specific order line items, or to report status of multiple orders based upon some specified criteria. The e-Document enables the sender to indicate a primary status as well as an additional secondary status at the order level as well as for each line and component.

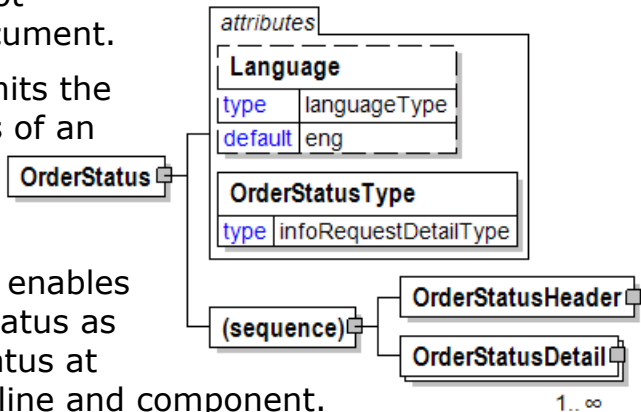

Language [attribute]

papiNet V2R31

Language is optional. A single instance might exist.

The valid Alpha 2- and Alpha 3-character list of language codes in the ISO 639-1 and 639-2 international standards.

Information on the content of this attribute is available at:
https://www.loc.gov/standards/iso639-2/php/code_list.php

OrderStatusType [attribute]

OrderStatusType is mandatory. A single instance is required.

Communicates the method in which the OrderStatus has been, or should be, summarized.

Refer to OrderStatusType definition for any enumerations.

(sequence)

The sequence of items below is mandatory. A single instance is required.

OrderStatusHeader

OrderStatusHeader is mandatory. A single instance is required.

Information that applies to the entire OrderStatus e-Document.

OrderStatusDetail

OrderStatusDetail is mandatory. One instance is required, multiple instances might exist.

The specifics of the information being communicated in the OrderStatus e-Document.

OrderStatusCode [attribute]

This attribute communicates the overall status of the order.

This item is restricted to the following list.

attribute
OrderStatusCode
type orderStatusCode

ActiveFree

The PO, order, or line item has been accepted or confirmed by the supplier. It may not have been manufactured, packed, or shipped yet. It is free for production. This status is also known as open status.

ActiveHold

The PO, order, or line item has been accepted or confirmed by the supplier. It may not have been manufactured, packed, or shipped yet. It is not free for production. Examples of this status include a reserved order or line item, the print time has not been determined, other payment terms not completed, or the last date for change has not been received.

Cancelled

The PO, order, or line item has a cancelled status in the supplier's system. It will not be manufactured nor shipped.

Complete

The PO, order, or line item has a complete status in the supplier's system. It has been packed, shipped, and invoiced successfully.

Delayed

An unexpected event has caused a delay.

FinalPlanning

The order is undergoing the final planning process.

Invoiced

The PO, order, or line item has an invoiced status in the supplier's system. It has been billed to the customer for payment purposes.

Loaded

The PO, order, or line item has a loaded status in the supplier's system. It has been loaded onto a transport vehicle shipping purposes.

NotReceived

Not received by either the buyer or seller.

OrderLineConfirmed

The order line has been confirmed.

Packed

The PO, order, or line item has a packed status in the supplier's system. It has been packaged or staged for loading and shipping purposes.

PartiallyShipped

The PO, order, or line item has a partially shipped status in the supplier's system. Part of the quantity requested has been shipped to the customer but part of the request still remains to be shipped.

Pending

The PO, order, or line item has a pending status in the supplier's system. It has not yet been confirmed, accepted, nor rejected by the supplier. This status indicates that the supplier requires more time to determine acceptance.

Planned

The PO, order, or line item has a planned or scheduled status in the supplier's system. It has not yet begun the manufacturing process.

ProductionComplete

The PO, order, or line item has completed the manufacture process by the supplier.

ProductionPlanned

Production has been planned for the order.

ProductionStarted

The PO, order, or line item has begun to be manufactured by the supplier.

Received

The material has arrived at the destination and has been processed by that location.

ReservedInProductionPlanningSystem

Material and capacity is available for production.

Scheduled

The order has been scheduled.

ShipmentComplete

The order has been fully shipped.

ShipmentPlanned

Shipment has been planned for the order

Shuttled

Material has been moved.

Staged

Material has been positioned for production.

Transferred

The manufacturing order has been moved.

TransferredToMillSystem

The order has been loaded onto the mill manufacturing system.

Unscheduled

The order has not yet been scheduled.

Unshipped

The PO, order, or line item is in the supplier's mill or warehouse but has yet to be shipped.

OrderStatusDetail

The specifics of the information being communicated in the OrderStatus e-Document.

(sequence)

The sequence of items below is mandatory. A single instance is required.

PurchaseOrderInformation

PurchaseOrderInformation is mandatory. A single instance is required.

A group item containing information unique to this PurchaseOrder, which is provided by the buyer. PurchaseOrderInformation can be optional in the supply chain. Invoices are created without having a PurchaseOrder in Vendor Managed Inventory. Freight invoices also will not have a PurchaseOrder number.

PurchaseOrderLineItemNumber

PurchaseOrderLineItemNumber is mandatory. A single instance is required.

The sequential number that uniquely identifies the PurchaseOrder line item.

(sequence)

The sequence of items below is optional. Multiple instances might exist.

SupplierOrderNumber

SupplierOrderNumber is mandatory. A single instance is required.

The number of the supplier order.

SupplierOrderLineItemNumber

SupplierOrderLineItemNumber is optional. A single instance might exist.

The number of the line item on the supplier order.

LocationParty

LocationParty is optional. A single instance might exist.

The organization or business entity where the business event took place or will take place.

Product

Product is mandatory. A single instance is required.

Product is a group item defining the article and its characteristics. Product is used to specify

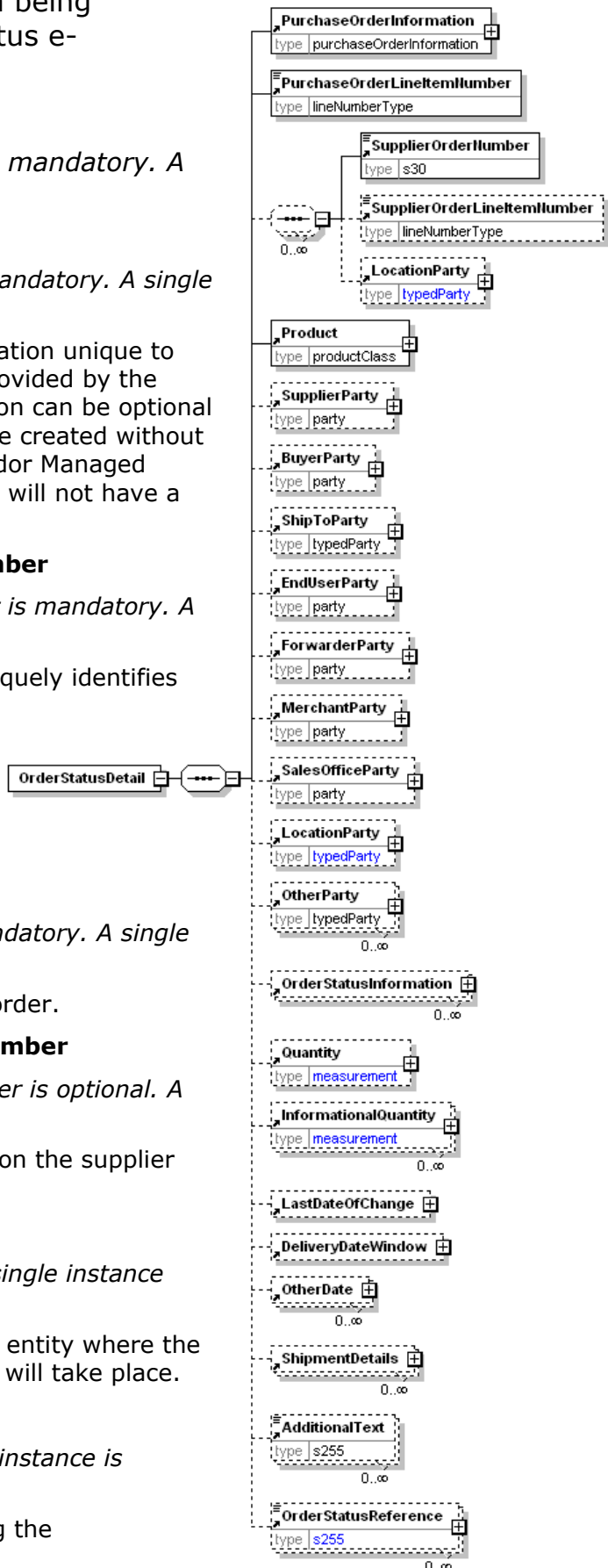

product characteristics organized by ProductIdentifier, ProductDescription, and Classification. Book Manufacturing, Label Stock, Paper, Pulp, Recovered Paper, Wood Products, and Virgin Fibre market segments have defined their product characteristics and conversion features for implementation in papiNet.

SupplierParty

SupplierParty is optional. A single instance might exist.

The organisation or business entity responsible for providing the product. SupplierParty is also the seller of the product, if Seller is not specified as OtherParty = Seller.

BuyerParty

BuyerParty is optional. A single instance might exist.

The legal entity to which the product is sold. Also commonly referred to as the sold-to party or customer. If no OtherParty is defined as the Payer, the Buyer is the Payer.

ShipToParty

ShipToParty is optional. A single instance might exist.

The name and/or address to which the goods should be delivered with the party type indicated by the PartyType attribute.

EndUserParty

EndUserParty is optional. A single instance might exist.

The party using, consuming, or converting the product. For example, a printer using paper reels for a print job for a publisher. The final ShipTo destination for a product is normally to the end user's facilities.

ForwarderParty

ForwarderParty is optional. A single instance might exist.

The trading partner involved in the forwarding of the shipment.

MerchantParty

MerchantParty is optional. A single instance might exist.

This named party represents the merchant involved in the business transaction. This party is only used in the communication of OrderStatus otherwise it is handled via OtherParty.

SalesOfficeParty

SalesOfficeParty is optional. A single instance might exist.

This named party represents the sales office involved in the business transaction. This party is only used in the communication of OrderStatus otherwise it is handled via OtherParty.

LocationParty

LocationParty is optional. A single instance might exist.

The organization or business entity where the business event took place or will take place.

OtherParty

OtherParty is optional. Multiple instances might exist.

An organisation or business entity other than those specifically detailed within an e-Document.

OrderStatusInformation

OrderStatusInformation is optional. Multiple instances might exist.

A group element that stores two levels of order status codes.

Quantity

Quantity is optional. A single instance might exist.

The Quantity element contains attributes that provide information about the type of quantity that is being communicated, the context in which the particular quantity is to be viewed, and (if the quantity represents an adjustment) an adjustment type.

The Quantity element contains three child elements that enable you to communicate a range of values for the quantity and a target or actual value. It is at this level (Value, RangeMin, and RangeMax) that the unit of measure is specified. This permits the range to be specified in a different unit of measure than the target.

InformationalQuantity

InformationalQuantity is optional. Multiple instances might exist.

A quantity given in a valid UOM used for information purposes only (not for calculation). For example, an ordered quantity was 100 reels as opposed to the invoice quantity of 20,000 pounds.

LastDateOfChange

LastDateOfChange is optional. A single instance might exist.

The last date for which changes to the line item may occur before it is "locked" in the production process. LastDateOfChange encapsulates Date.

DeliveryDateWindow

DeliveryDateWindow is optional. A single instance might exist.

A group item defining the date/time interval for delivery to take place. An element which may contain the estimated date for which delivery is expected. This date is not absolute.

OtherDate

OtherDate is optional. Multiple instances might exist.

A date that may not be specifically detailed within a document (example: print date at the PurchaseOrderLineItem).

ShipmentDetails

ShipmentDetails is optional. Multiple instances might exist.

A group element containing information that relates to the shipment details for the line item.

AdditionalText

AdditionalText is optional. Multiple instances might exist.

A text field that is used to communicate information not previously defined or for special instructions. To be used only for circumstances not covered by specific elements.

OrderStatusReference

OrderStatusReference is optional. Multiple instances might exist.

An item detailing relevant references (such as contract number) pertaining to the OrderStatus. The type of reference is identified by the attribute OrderStatusReferenceType.

OrderStatusHeader

Information that applies to the entire OrderStatus e-Document.

(sequence)

The sequence of items below is mandatory. A single instance is required.

OrderStatusNumber

OrderStatusNumber is mandatory. A single instance is required.

A number used to identify the OrderStatus report.

OrderStatusResponseDate

OrderStatusResponseDate is mandatory. A single instance is required.

The Date and Time that the OrderStatus e-Document was created.

RequestNumber

RequestNumber is optional. A single instance might exist.

A unique tracking number specifically identifying the InfoRequest e-Document to the originator. The tracking number is returned with the "information", the answer, to help match the answer to the request.

RequestingParty

RequestingParty is optional. A single instance might exist.

The party requesting the information.

RespondToParty

RespondToParty is optional. Multiple instances might exist.

The party the document should be responded to.

SenderParty

SenderParty is optional. A single instance might exist.

The business entity issuing the e-Document, the source of the document.

The entity responsible for the content. If the sender party has out sourced the message service to a third party the SenderParty is the issuer of the e-Document and not the party performing the transmission service of the electronic message.

ReceiverParty

ReceiverParty is optional. Multiple instances might exist.

The business entity for whom the e-Document is intended, the destination of the document.

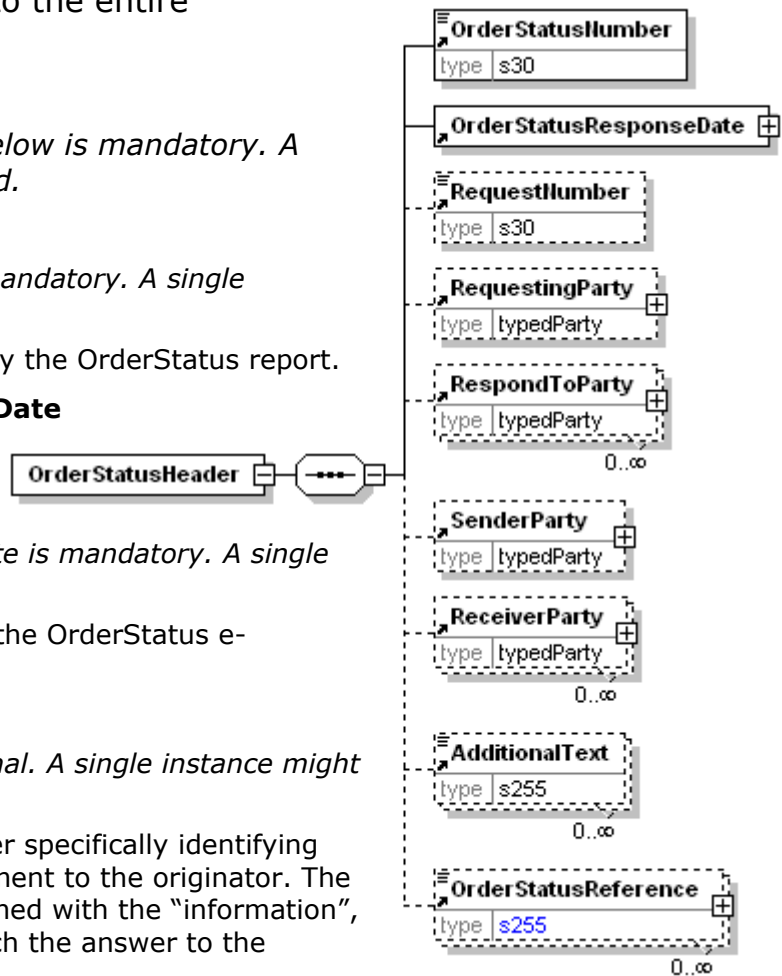

The entity interested in the content. If the receiver party has outsourced the message service to a third party the ReceiverParty is the intended party for the e-Document and not the party performing the receiving service of the electronic message.

AdditionalText

AdditionalText is optional. Multiple instances might exist.

A text field that is used to communicate information not previously defined or for special instructions. To be used only for circumstances not covered by specific elements.

OrderStatusReference

OrderStatusReference is optional. Multiple instances might exist.

An item detailing relevant references (such as contract number) pertaining to the OrderStatus. The type of reference is identified by the attribute OrderStatusReferenceType.

OrderStatusInformation

A group element that stores two levels of order status codes.

(sequence)

The sequence of items below is mandatory. A single instance is required.

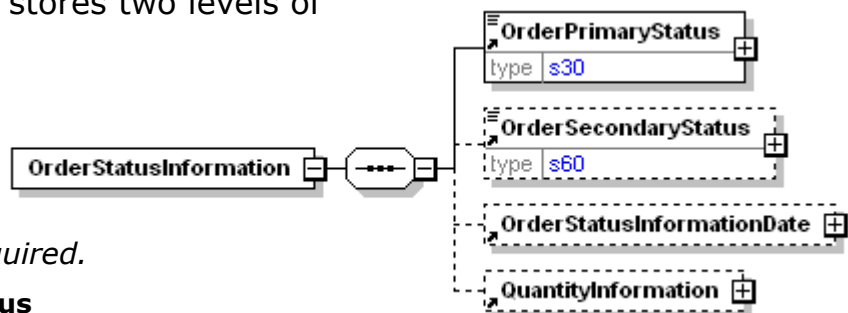

OrderPrimaryStatus

OrderPrimaryStatus is mandatory. A single instance is required.

An element that contains the highest level status code pertaining to an entire order.

OrderSecondaryStatus

OrderSecondaryStatus is optional. A single instance might exist.

An element that contains a secondary status description pertaining to the entire order.

OrderStatusInformationDate

OrderStatusInformationDate is optional. A single instance might exist.

The date and time when the specified OrderStatus was achieved.

QuantityInformation

QuantityInformation is optional. A single instance might exist.

A group item containing information about quantity and informational quantity of similar items.

OrderStatusInformationDate

The date and time when the specified OrderStatus was achieved.

(sequence)

The sequence of items below is mandatory. A single instance is required.

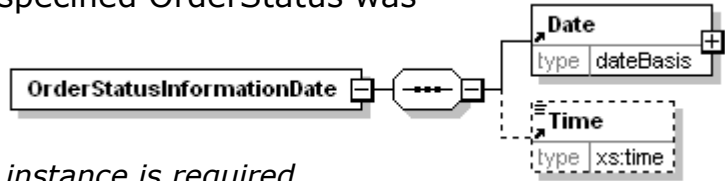

Date

Date is mandatory. A single instance is required.

A group element that contains the specification of Year, Month, and Day.

Time

Time is optional. A single instance might exist.

Times are treated in a standard XML fashion with a special case used to indicate a generalized "local" time. The standard XML approach to time is hh:mm:ss, hh:mm:ssZ, or hh:mm:ss±hh:mm.

hh:mm:ss±hh:mm is used to represent a time with a time zone. The time zone is communicated as the number of hours offset from the Universal Time Coordinate (UTC), a.k.a. Greenwich Mean Time.

hh:mm:ssZ indicates the time at Zulu (another name for UTC).

hh:mm:ss or hh:mm indicates within papiNet the applicable local time where the associated event is taking place. Caution should be used when processing times of this nature as the papiNet approach may be in discord with other users of XML.

OrderStatusNumber

A number used to identify the OrderStatus report.

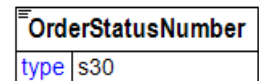

OrderStatusReference

An item detailing relevant references (such as contract number) pertaining to the OrderStatus. The type of reference is identified by the attribute

OrderStatusReferenceType.

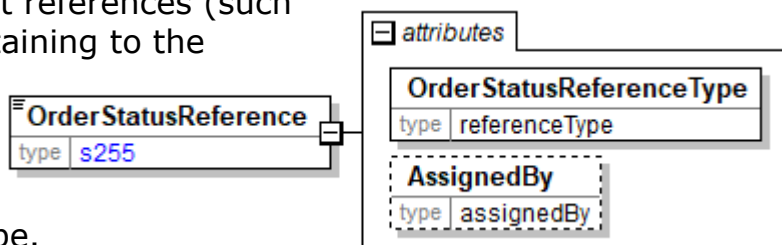

OrderStatusReferenceType [attribute]

OrderStatusReferenceType is mandatory. A single instance is required.

Provides a contextual explanation of the specific reference identifier. Many items are currently prefixed by "Buyer", "Forwarder", "Manufacturer", "Mill", "Seller", "Supplier", "Warehouse", or "Vendor". Check for an existing non-prefixed version and use the non-prefixed version instead. In the (yet to be announced release date) version 3.0 the prefixed versions will be removed.

papiNet V2R31

Instead the attribute @AssignedBy will communicate the information previously communicated in the prefix.

Refer to OrderStatusReferenceType definition for any enumerations.

AssignedBy [attribute]

AssignedBy is optional. A single instance might exist.

Identifies the type of party or the agency that has assigned the associated item, e.g. a reference of type OrderNumber.

Refer to AssignedBy for any enumerations.

OrderStatusReferenceType [attribute]

Provides a contextual explanation of the specific reference identifier. Many items are currently prefixed by "Buyer", "Forwarder", "Manufacturer", "Mill", "Seller", "Supplier", "Warehouse" or "Vendor". Check for an existing non-prefixed version and use the non-prefixed version instead. In the (yet to be announced release date) version 3.0 the prefixed versions will be removed. Instead the attribute AssignedBy will communicate the information previously communicated in the prefix.

OrderStatusReferenceType
type referenceType

Refer to the [referenceType](#) entry for the list of enumerations and their definitions.

OrderStatusRequestDetail

A grouping element that provides the parameters to be used when responding with an OrderStatus e-Document.

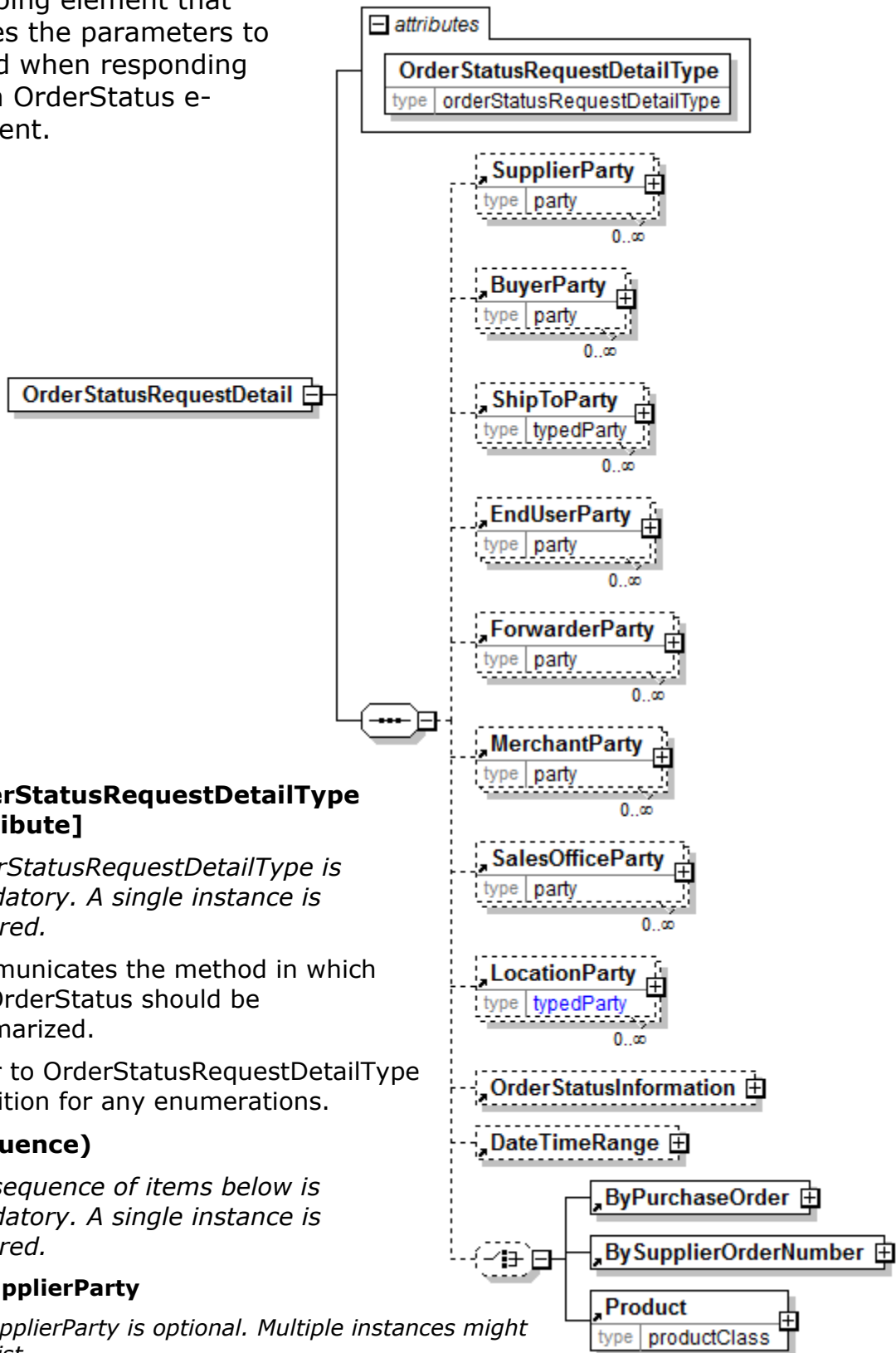

OrderStatusRequestDetailType [attribute]

OrderStatusRequestDetailType is mandatory. A single instance is required.

Communicates the method in which the OrderStatus should be summarized.

Refer to OrderStatusRequestDetailType definition for any enumerations.

(sequence)

The sequence of items below is mandatory. A single instance is required.

SupplierParty

SupplierParty is optional. Multiple instances might exist.

The organisation or business entity responsible for providing the product. SupplierParty is also the seller of the product, if Seller is not specified as OtherParty = Seller.

BuyerParty

BuyerParty is optional. Multiple instances might exist.

The legal entity to which the product is sold. Also commonly referred to as the sold-to party or customer. If no OtherParty is defined as the Payer, the Buyer is the Payer.

ShipToParty

ShipToParty is optional. Multiple instances might exist.

The name and/or address to which the goods should be delivered with the party type indicated by the PartyType attribute.

EndUserParty

EndUserParty is optional. Multiple instances might exist.

The party using, consuming, or converting the product. For example, a printer using paper reels for a print job for a publisher. The final ShipTo destination for a product is normally to the end user's facilities.

ForwarderParty

ForwarderParty is optional. Multiple instances might exist.

The trading partner involved in the forwarding of the shipment.

MerchantParty

MerchantParty is optional. Multiple instances might exist.

This named party represents the merchant involved in the business transaction. This party is only used in the communication of OrderStatus otherwise it is handled via OtherParty.

SalesOfficeParty

SalesOfficeParty is optional. Multiple instances might exist.

This named party represents the sales office involved in the business transaction. This party is only used in the communication of OrderStatus otherwise it is handled via OtherParty.

LocationParty

LocationParty is optional. Multiple instances might exist.

The organization or business entity where the business event took place or will take place.

OrderStatusInformation

OrderStatusInformation is optional. A single instance might exist.

A group element that stores two levels of O order status codes.

DateTimeRange

DateTimeRange is optional. A single instance might exist.

Specifies a date and/or time range.

(choice)

[choice] is optional. A single instance might exist.

ByPurchaseOrder

ByPurchaseOrder is mandatory. A single instance is required.

Selection criteria for communicating purchase order information.

BySupplierOrderNumber

BySupplierOrderNumber is mandatory. A single instance is required.

Selection criteria for communicating Supplier Order information

Product

Product is mandatory. A single instance is required.

Product is a group item defining the article and its characteristics. Product is used to specify product characteristics organized by ProductIdentifier, ProductDescription, and Classification. Book Manufacturing, Label Stock, Paper, Pulp, Recovered Paper, Wood Products, and Virgin Fibre market segments have defined their product characteristics and conversion features for implementation in papiNet.

OrderStatusRequestDetailType [attribute]

Communicates the method in which the OrderStatus should be summarized.

This item is restricted to the following list.

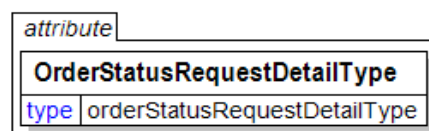

ByProduct

By product

ByPurchaseOrder

By the PurchaseOrder the material was ordered

BySupplierOrderNumber

By the order the material was manufactured

OrderStatusResponseDate

The Date and Time that the OrderStatus e-Document was created.

(sequence)

The sequence of items below is mandatory. A single instance is required.

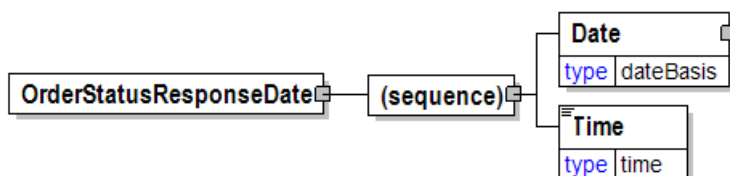

Date

Date is mandatory. A single instance is required.

A group element that contains the specification of Year, Month, and Day.

Time

Time is mandatory. A single instance is required.

Times are treated in a standard XML fashion with a special case used to indicate a generalized "local" time. The standard XML approach to time is hh:mm:ss, hh:mm:ssZ, or hh:mm:ss±hh:mm.

hh:mm:ss±hh:mm is used to represent a time with a time zone. The time zone is communicated as the number of hours offset from the Universal Time Coordinate (UTC), a.k.a. Greenwich Mean Time.

papiNet V2R31

hh:mm:ssZ indicates the time at Zulu (another name for UTC).

hh:mm:ss or hh:mm indicates within papiNet the applicable local time where the associated event is taking place. Caution should be used when processing times of this nature as the papiNet approach may be in discord with other users of XML.

OrderStatusType [attribute]

Communicates the method in which the OrderStatus has been, or should be, summarized.

This item is restricted to the following list.

ByProduct

By product

ByPurchaseOrder

By the PurchaseOrder the material was ordered

BySupplierOrderNumber

By the order the material was manufactured

attribute
OrderStatusType
type infoRequestDetailType

OrderStatusType [attribute]

Defines the status of the entire PurchaseOrder e-Document, in other words, at the root level

This item is restricted to the following list.

Amended

The supplied information is changed.

Cancelled

The supplied information has been cancelled. Items that have been cancelled are not included in totals on the summary levels of the e-Document.

Original

The supplied information is the first version of that information.

attribute
OrderStatusType
type purchaseOrderStatusType

OrderTitle

A text describing the context of the order.

Order Title
type s255

OrderType [attribute]

Defines the type of OrderConfirmation being communicated.

This item is restricted to the following list.

attribute
OrderType
type orderConfirmationType

Agreement

A legally binding exchange of promises between parties that the law will enforce.

BlanketOrder

An order that communicates the same information as a StandardOrder but also indicates that the order may be completed over a period of time or, until a certain volume is achieved or, until a certain currency amount is spent.

ConfirmingOrder

A confirming order is used to electronically confirm an order that has not been placed electronically by the customer that is, it was placed using another means such as fax, phone or email.

ConsumptionOrder

A PurchaseOrder that is based upon consumption for a particular period of time or instance.

ReleaseOrder

A release order is used to release a product to be made. This type of order refers to a previous order or agreement, such as a reservation order, a contract, or a blanket order. A release number version which is an incremented number, is used in this type.

ReservationOrder

A reservation order is used to book a paper supplier's capacity for specific quantities of specific products, but it is not yet a firm commitment to buy. Consequently, all line items of a reservation order have a ProductionStatusType of NotFree. To release one or more PurchaseOrder line items of a reservation order, a buyer can use a standard order or a release order.

StandardOrder

A standard order is a regular one-time order. It defines quantities for one or more products to be purchased and may also define a delivery location and date. A standard order may reference a previous agreement (for example, a quotation, a contract, or a reservation order) for information.

TrialOrder

A trial order is used whenever a seller has agreed to have a buyer sample a product. The seller needs to process this order differently from other orders, because a trial order may include a product sold at a discounted rate or even provided for free. A trial order typically is for small quantities.

OrderType [attribute]

Defines the type of OrderConfirmationWood being communicated.

This item is restricted to the following list.

Agreement

A legally binding exchange of promises between parties that the law will

attribute
OrderType
type orderConfirmationTypeWood

enforce.

BlanketOrder

An order that communicates the same information as a StandardOrder but also indicates that the order may be completed over a period of time or, until a certain volume is achieved or, until a certain currency amount is spent.

ReleaseOrder

A release order is used to release a product to be made. This type of order refers to a previous order or agreement, such as a reservation order, a contract, or a blanket order. A release number version which is an incremented number, is used in this type.

ReservationOrder

A reservation order is used to book a paper supplier's capacity for specific quantities of specific products, but it is not yet a firm commitment to buy. Consequently, all line items of a reservation order have a ProductionStatusType of NotFree. To release one or more PurchaseOrder line items of a reservation order, a buyer can use a standard order or a release order.

StandardOrder

A standard order is a regular one-time order. It defines quantities for one or more products to be purchased and may also define a delivery location and date. A standard order may reference a previous agreement (for example, a quotation, a contract, or a reservation order) for information.

OrderType [attribute]

Defines the type of PurchaseOrder issued.

This item is restricted to the following list.

attribute
OrderType
type purchaseOrderTypeWood

BlanketOrder

A PurchaseOrder that communicates the same information as a StandardOrder but also indicates that the order may be completed over a period of time or, until a certain volume is achieved or, until a certain currency amount is spent.

ReleaseOrder

A release order is used to release a product to be made. This type of PurchaseOrder refers to a previous order or agreement, such as a reservation order, a contract, or a blanket order. A release number version called PurchaseOrderReleaseNumber, which is an incremented number, is used in this e-Document.

ReservationOrder

A reservation order is used to book a paper supplier's capacity for specific quantities of specific products, but it is not yet a firm commitment to buy. Consequently, all PurchaseOrder line items of a reservation order have a ProductionStatusType of NotFree. To release one or more PurchaseOrder line items of a reservation order, a buyer can use a standard order or a release order.

StandardOrder

A standard order is a regular one-time order. It defines quantities for one or more products to be purchased and may also define a delivery location and date. A standard order may reference a previous agreement (for example, a quotation, a contract, or a reservation order) for information.

OrganisationUnit

A segment of a business or the entire business.

OrganisationUnitType [attribute]

OrganisationUnitType is mandatory. A single instance is required.

Identifies the type of organisation being communicated

Refer to OrganisationUnitType definition for any enumerations.

(sequence)

The sequence of items below is mandatory. A single instance is required.

OrganisationUnitName

OrganisationUnitName is optional. A single instance might exist.

A description of the organisation unit.

OrganisationUnitCode

OrganisationUnitCode is optional. A single instance might exist.

A short representation for the organisation unit.

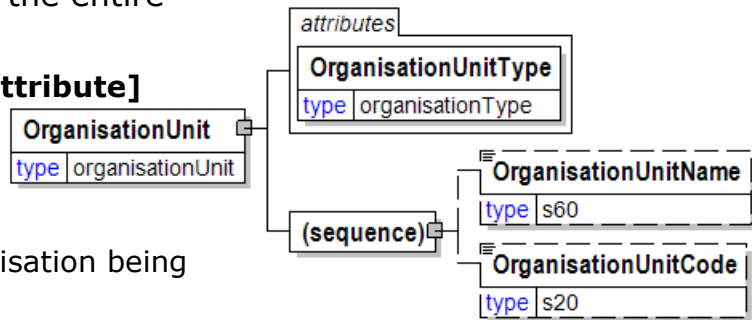

OrganisationUnitCode

A short representation for the organisation unit.

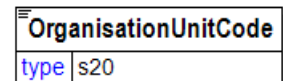

OrganisationUnitName

A description of the organisation unit.

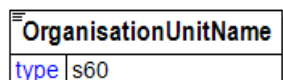

OrganisationUnitType [attribute]

Identifies the type of organisation being communicated

This item is restricted to the following list.

Department

A major division of a business.

Division

An administrative or operating unit of a business

Dock

A place for the unloading or loading of material.

Location

A place marked by some distinguishing feature.

Region

An administrative area of a business.

StorageLocation

A place that supports the functions associated with warehousing of material.

Terminal

A point along a carrier line having facilities for the handling of freight.

Other

Another type of unit, not defined above.

attribute
OrganisationUnitType
type organisationType

OrientationWithFaceWoodPanelGrain [attribute]

Either "Yes" or "No".

This item is restricted to the following list.

Yes

No

attribute
OrientationWithFaceWoodPanelGrain
type yesNo

Original [attribute]

Either "Yes" or "No".

This item is restricted to the following list.

Yes

No

attribute
Original
type yesNo

OtherDate

A date that may not be specifically detailed within a document (example: print date at the PurchaseOrderLineItem).

DateType [attribute]

DateType is mandatory. A single instance is required.

Provides a context for the other date used in the document.

Refer to DateType definition for any enumerations.

(choice)

[choice] is mandatory. A single instance is required.

(sequence)

The sequence of items below is mandatory. A single instance is required.

Date

Date is mandatory. A single instance is required.

A group element that contains the specification of Year, Month, and Day.

Time

Time is optional. A single instance might exist.

Times are treated in a standard XML fashion with a special case used to indicate a generalized "local" time. The standard XML approach to time is hh:mm:ss, hh:mm:ssZ, or hh:mm:ss±hh:mm.

hh:mm:ss±hh:mm is used to represent a time with a time zone. The time zone is communicated as the number of hours offset from the Universal Time Coordinate (UTC), a.k.a. Greenwich Mean Time.

hh:mm:ssZ indicates the time at Zulu (another name for UTC).

hh:mm:ss or hh:mm indicates within papiNet the applicable local time where the associated event is taking place. Caution should be used when processing times of this nature as the papiNet approach may be in discord with other users of XML.

Year

Year is mandatory. A single instance is required.

Identifies the year number when communicating a Calendar date.

YearMonth

YearMonth is mandatory. A single instance is required.

Identifies the month of the calendar year according to format specified by ISO 8601, The ISO 8601 format for the month of the calendar year is YYYY-MM, for example 2016-10.

Week

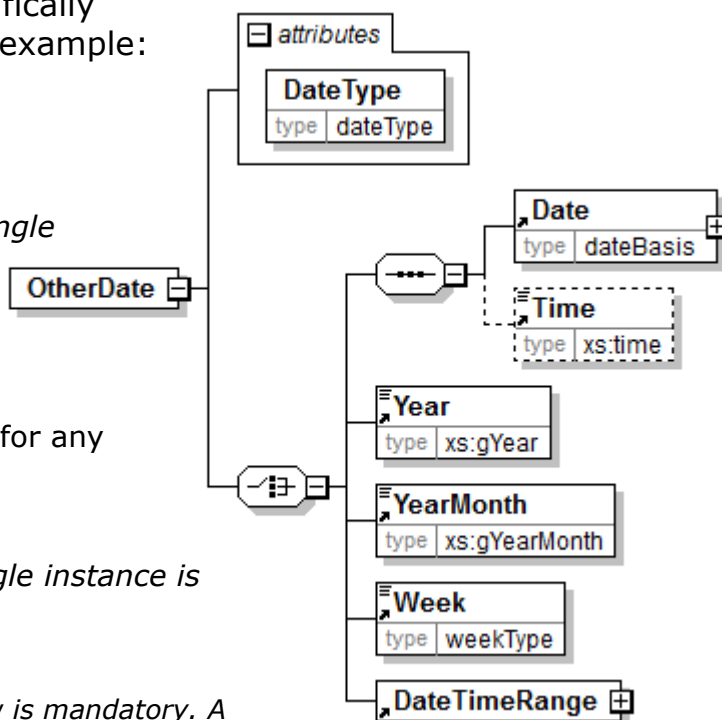

papiNet V2R31

Week is mandatory. A single instance is required.

A field defining the week number of the calendar year. ISO 8601 is used as the basis for this element, "Week 01 of a year is the first week that has the Thursday in this year, which is equivalent to the week that contains the fourth day of January." The ISO week starts on Monday. The ISO 8601 extended format of the week number is yyyy-Www, for example 2016-W51.

DateTimeRange

DateTimeRange is mandatory. A single instance is required.

Specifies a date and/or time range.

OtherDocumentName [attribute]

Defines the document name for documents that are not papiNet e-Documents. These documents are defined in element Document by OtherDocumentName when attribute DocumentName has the value "Other".



OtherDocumentType [attribute]

Defines the document type for a document that is not a papiNet e-Document.

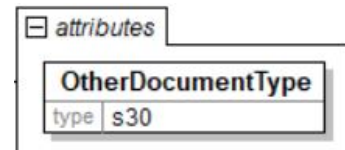

OtherParty

An organisation or business entity other than those specifically detailed within an e-Document.

PartyType [attribute]

PartyType is mandatory. A single instance is required.

Identifies the business role associated with the particular party

Refer to PartyType definition for any enumerations.

LogisticsRole [attribute]

LogisticsRole is optional. A single instance might exist.

Communicates the nature of the logistics role, if any, the party plays in the transaction.

Refer to LogisticsRole definition for any enumerations.

(sequence)

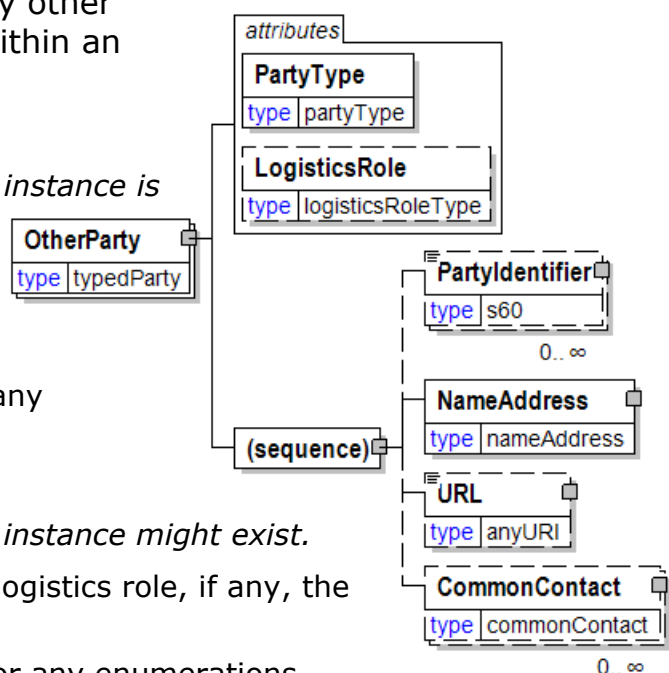

papiNet V2R31

The sequence of items below is mandatory. A single instance is required.

PartyIdentifier

PartyIdentifier is optional. Multiple instances might exist.

A unique identifier of a specific party. This element contains an attribute `PartyIdentifierType` that indicates the type of the identifier.

NameAddress

NameAddress is mandatory. A single instance is required.

A group item containing name and address of an organisation or business entity.

URL

URL is optional. A single instance might exist.

Universal Resource Locator. While typically a web address you could use this field to hold an email address.

CommonContact

CommonContact is optional. Multiple instances might exist.

Identifies a specific individual associated with the party.

OtherProducts

A group item defining the characteristics of other products.

OtherProductsType [attribute]

OtherProductsType is mandatory. A single instance is required.

Defines the type of product for other products.

Refer to `OtherProductsType` definition for any enumerations.

OtherProductsItemType [attribute]

OtherProductsItemType is optional. A single instance might exist.

Defines detail type of items for other product types.

Refer to `OtherProductsItemType` definition for any enumerations.

(sequence)

The sequence of items below is mandatory. A single instance is required.

OtherProductsItemCodeInfo

OtherProductsItemCodeInfo is optional. A single instance might exist.

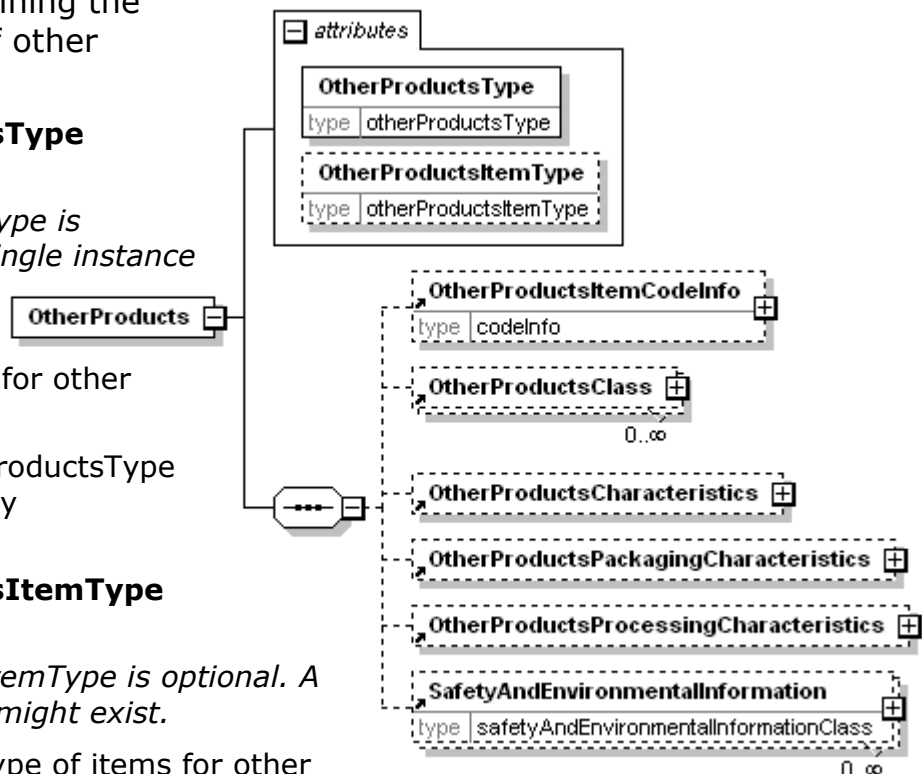

papiNet V2R31

A group item that defines a product item by a code given by an agency. A textual description of the product item can also be given.

OtherProductsClass

OtherProductsClass is optional. Multiple instances might exist.

A group item that details information used for describing classes of other products based on some product properties.

OtherProductsCharacteristics

OtherProductsCharacteristics is optional. A single instance might exist.

A group item that contains characteristics of other products.

OtherProductsPackagingCharacteristics

OtherProductsPackagingCharacteristics is optional. A single instance might exist.

A group item that contains information about packaging of other products.

OtherProductsProcessingCharacteristics

OtherProductsProcessingCharacteristics is optional. A single instance might exist.

A group item that contains information about processing of other products.

SafetyAndEnvironmentalInformation

SafetyAndEnvironmentalInformation is optional. Multiple instances might exist.

Name of certification type, if any, on the goods (For example, FSC, PEFC). SafetyAndEnvironmental needs a value or measurement to communicate the percentage of the product is certified (for example, 75% is certified by the indicated agency).

OtherProductsCharacteristics

A group item that contains characteristics of other products.

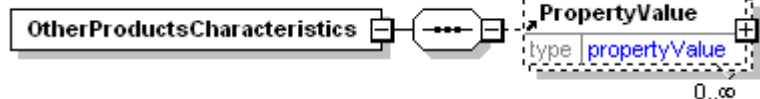

(sequence)

The sequence of items below is mandatory. A single instance is required.

PropertyValue

PropertyValue is optional. Multiple instances might exist.

Specifies a value for a property of an item. The property is defined by the attribute PropertyType. The attribute MeasuringMethod and MeasuringAgency can be used to clarify details for a how a property is measured or calculated, e.g. Diameter for a saw log can be measured "Under Bark" or "Over Bark". The attribute MeasuringMethodType defines how the value is created, e.g. measured automatically, calculated etc. The attribute IsAverageValue indicates if the value is an average value or not.

PropertySubValue can specify a value for a property related to the property specified by the attribute PropertyType of PropertyValue. PropertyValueOfWhichMax and PropertyValueOfWhichMin can specify maximum and minimum values for properties that are part of the property specified by the attribute PropertyType of PropertyValue.

OtherProductsClass

A group item that details information used for describing classes of other products based on some product properties.

OtherProductsClassType [attribute]

OtherProductsClassType is mandatory. A single instance is required.

Defines the type of class for other products.

Refer to OtherProductsClassType definition for any enumerations.

(sequence)

The sequence of items below is mandatory. A single instance is required.

ClassCodeInfo

ClassCodeInfo is mandatory. A single instance is required.

A group item specifying code and description for a class.

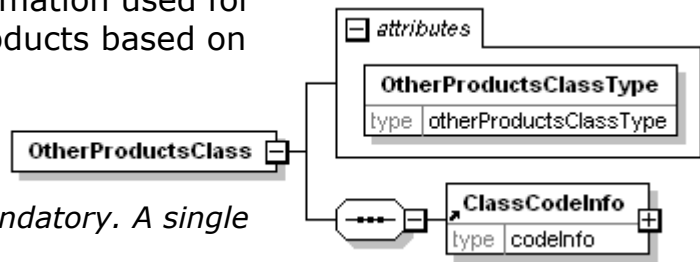

OtherProductsClassType [attribute]

Defines the type of class for other products.

This item is restricted to the following list.

SummerClass

A class for products fulfilling requirements at temperatures over 0 degrees Celcius.

WinterClass

A class for products fulfilling requirements at temperatures under 0 degrees Celsius. For example a class of diesel fuel enhanced to prevent it from gelling in cold weather conditions.

ArcticClass

A class for products fulfilling requirements in arctic climate. For example a class of diesel fuel enhanced to meet arctic climate conditions.



OtherProductsItemCodeInfo

A group item that defines a product item by a code given by an agency. A textual description of the product item can also be given.

Agency [attribute]

Agency is mandatory. A single instance is required.

Describes the agency maintaining the list of codes. To be included in this list the agency must be a recognized standards body or industry organisation.

- For the element that owns this attribute.
- For another attribute in the list of attributes associated with the parent element.

Refer to Agency definition for any enumerations.

(sequence)

The sequence of items below is mandatory. A single instance is required.

Code

Code is mandatory. A single instance is required.

Specifies a code that is defined by an agency. The agency is given for the whole construct containing the code.

CodeValue

CodeValue is optional. A single instance might exist.

A grouping element specifying a value belonging to a code that is defined by an agency.

CodeDescription

CodeDescription is optional. Multiple instances might exist.

A textual description for the meaning of a code that is defined by an agency. When the Code is associated with a CodeValue of type TextValue, then the CodeDescription is a textual description of both the Code and the TextValue.

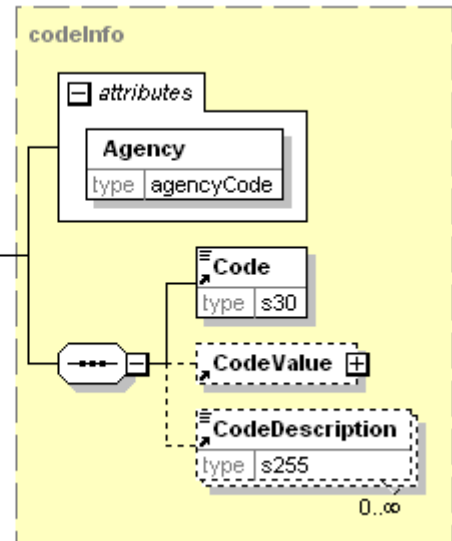
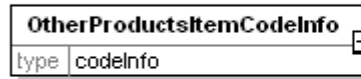

OtherProductsItemType [attribute]

Defines detail type of items for other product types.

This item is restricted to the following list.

Ash

Ash is the residue powder left after the combustion of wood or other bio-based material, such as burning the material in an industrial power plant. Depending on its properties and use value ash can be a commercial product being used



e.g. in landfilling or in cement production or it can be treated as waste.

Biodiesel

Biodiesel refers to a vegetable oil- or animal fat-based diesel fuel consisting of long-chain alkyl (methyl, propyl or ethyl) esters. Biodiesel is typically made by chemically reacting lipids (e.g., vegetable oil, animal fat) with an alcohol producing fatty acid esters.

Biodiesel is meant to be used in standard diesel engines and is thus distinct from the vegetable and waste oils used to fuel converted diesel engines. Biodiesel can be used alone, or blended with petro diesel. Biodiesel can also be used as a low carbon alternative to heating oil.

BlackLiquor

In industrial chemistry, black liquor is the spent cooking liquor from the Kraft process when digesting pulpwood into paper pulp removing lignin, hemicelluloses and other extractives from the wood to free the cellulose fibers.

BrownLiquor

In industrial chemistry, brown liquor is the spent cooking liquor in the sulphite process. Other used names are red liquor, thick liquor and sulphite waste liquor.

ChinaClay

Kaolinite is a clay mineral, part of the group of industrial minerals, with the chemical composition $\text{Al}_2\text{Si}_2\text{O}_5(\text{OH})_4$. It is a layered silicate mineral, with one tetrahedral sheet linked through oxygen atoms to one octahedral sheet of alumina octahedra. Rocks that are rich in kaolinite are known as kaolin or china clay.

The largest use is in the production of paper, including ensuring the gloss on some grades of paper.

CrudeTallOil

A dark, smelling, oil-like product consisting mainly of fatty and rosin acids and, to a lesser extent, unsaponifiable substances. Crude Tall Oil is produced through acidification of black liquor soap skimmings.

Lignin

Lignin is a class of complex organic polymers that form important structural materials in the support tissues of vascular plants and some algae. Lignins are particularly important in the formation of cell walls, especially in wood and bark, because they lend rigidity and do not rot easily. Chemically, lignins are cross-linked phenolic polymers.

Lye

Lye is a corrosive alkaline substance, commonly sodium hydroxide (NaOH, also known as 'caustic soda') or historically potassium hydroxide (KOH, from hydrated potash).

Naphtha

Naphtha normally refers to a number of flammable liquid mixtures of hydrocarbons, i.e. a component of natural gas condensate or a distillation

product from petroleum, coal tar or peat boiling in a certain range and containing certain hydrocarbons. It is a broad term covering among the lightest and most volatile fractions of the liquid hydrocarbons in petroleum. Naphtha is used chiefly as solvents and diluents and as raw materials for conversion to petrol.

Natriumbisulfit

Sodium carbonate solution is saturated with sulphur dioxide and the solution crystallized. Chiefly as a by-product in the production of phenol and resorcinol.

Peat

A dark brown or blackish material that results from the partial decay of plants in water. For example, it can be added to ordinary garden soil to improve it, used as bedding material, or dried for use as fuel.

Petrol

Petrol is a transparent petroleum-derived liquid that is primarily used as a fuel in internal combustion engines. It consists mostly of organic compounds obtained by the fractional distillation of petroleum, enhanced with a variety of additives. Some petrol also contains ethanol as an alternative fuel. In North America the term Gasoline is used, often shortened in colloquial usage to gas.

Pitch

Pitch is the name for any of a number of viscoelastic, solid polymers. Pitch normally exists in coniferous species.

PitchOil

Pitch oil can refer to either creosote-like fluids or kerosene. Creosote is the portion of chemical products obtained by the distillation of a tar that remains heavier than water, notably useful for its anti-septic and preservative properties.

RenewableDiesel

RenewableDiesel, often called "green diesel" or "second generation diesel", refers to petrodiesel like fuels derived from biological sources that are chemically not esters and thus distinct from biodiesel. Renewable diesel is chemically the same as petrodiesel, but is made of recently living biomass.

The term "renewable diesel" will refer to all diesel fuels that are derived from biomass that meet the standards ASTM D975 and are not monoalkyl esters.

RenewableNaphtha

RenewableNaphtha is produced during the processing of renewable feedstocks in processes such as Fischer Tropsch fuel production.

Talc

Talc is a metamorphic mineral resulting from the metamorphism of magnesian minerals such as serpentine, pyroxene, amphibole, olivine, in the presence of carbon dioxide and water. This is known as talc carbonation or steatization and produces a suite of rocks known as talc carbonates.

Talc is used in many industries such as paper making, plastic, paint and coatings, rubber, food, electric cable, pharmaceuticals, cosmetics, ceramics, etc.

Turpentine

Turpentine (also called spirit of turpentine, oil of turpentine, and wood turpentine) is a fluid obtained by the distillation of resin obtained from live trees, mainly pines. It is composed of terpenes, mainly the monoterpenes alpha-pinene and beta-pinene. It is sometimes colloquially known as turps.

OtherProductsPackagingCharacteristics

A group item that contains information about packaging of other products.

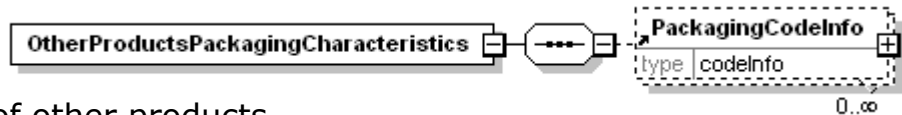

(sequence)

The sequence of items below is mandatory. A single instance is required.

PackagingCodeInfo

PackagingCodeInfo is optional. Multiple instances might exist.

A group item specifying code and description for packaging details.

OtherProductsProcessingCharacteristics

A group item that contains information about processing of other products.

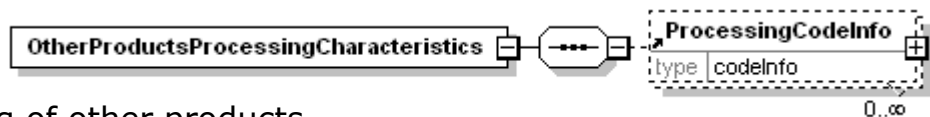

(sequence)

The sequence of items below is mandatory. A single instance is required.

ProcessingCodeInfo

ProcessingCodeInfo is optional. Multiple instances might exist.

A group item specifying code and description for processing details.

OtherProductsType [attribute]

Defines the type of product for other products.

This item is restricted to the following list.

Chemicals

In chemistry, a chemical substance is a form of matter that has constant chemical composition and characteristic properties. It cannot be separated into components by physical separation methods, i.e. without breaking chemical bonds. They can be solids, liquids or gases.

Fuel

Fuel is any material that stores energy that can later be extracted to perform mechanical work in a controlled manner.

Other



Any other product type.

OtherTreatment

Other treatment

(sequence)

The sequence of items below is mandatory. A single instance is required.

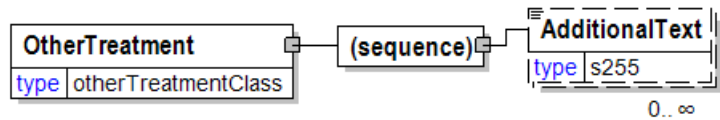

AdditionalText

AdditionalText is optional. Multiple instances might exist.

A text field that is used to communicate information not previously defined or for special instructions. To be used only for circumstances not covered by specific elements.

Overlay

Overlay

OverlaySide [attribute]

OverlaySide is optional. A single instance might exist.

Overlay side

Refer to OverlaySide definition for any enumerations.

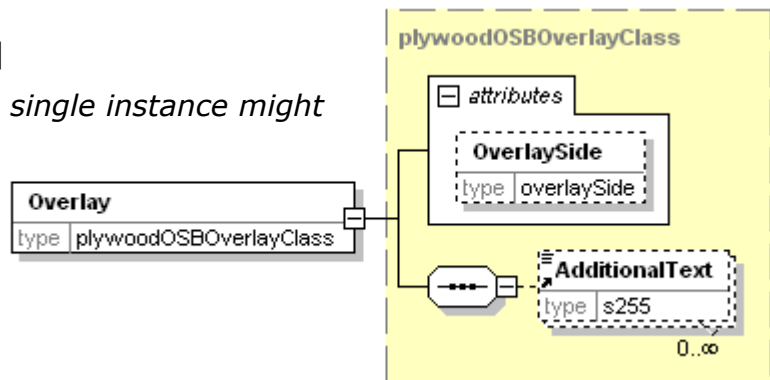

(sequence)

The sequence of items below is mandatory. A single instance is required.

AdditionalText

AdditionalText is optional. Multiple instances might exist.

A text field that is used to communicate information not previously defined or for special instructions. To be used only for circumstances not covered by specific elements.

OverlaySide [attribute]

Overlay side

This item is restricted to the following list.

- 1
- 2

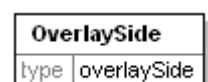

PackageAgency [attribute]

LumberAgency identifies which agency is responsible for assigning the lumber attributes.

This item is restricted to the following list.

attribute
PackageAgency
type lumberAgencyType

BS

BS-EN

British standard based on a European standard.

CEN

European Committee for Standardisation (<http://www.cenorm.be>)

DIN

EN338

EN1912

EN1611-1

EDISAW

Generic

GOST

Russian federal agency on technical regulating and metrology (<http://www.gost.ru>)

ISO

JAS

Japanese Agricultural Standard

NELMA

NLGA

NS

NSLB

RIS

RT

SIS

SPIB

WCLIB

WRCLA

WWPA

Supplier

PackageCharacteristics

The package characteristics.

(sequence)

The sequence of items below is mandatory. A single instance is required.

Height

Height is optional. A single instance might exist.

The height of the object.

Width

Width is optional. A single instance might exist.

The width of the object.

Length

Length is optional. A single instance might exist.

The length of the object.

LengthCutDescription

LengthCutDescription is optional. A single instance might exist.

Length Cut Description.

PropertyValue

PropertyValue is optional. Multiple instances might exist.

Specifies a value for a property of an item. The property is defined by the attribute PropertyType. The attribute MeasuringMethod and MeasuringAgency can be used to clarify details for a how a property is measured or calculated, e.g. Diameter for a saw log can be measured "Under Bark" or "Over Bark". The attribute MeasuringMethodType defines how the value is created, e.g. measured automatically, calculated etc. The attribute IsAverageValue indicates if the value is an average value or not.

PropertySubValue can specify a value for a property related to the property specified by the attribute PropertyType of PropertyValue. PropertyValueOfWhichMax and PropertyValueOfWhichMin can specify maximum and minimum values for properties that are part of the property specified by the attribute PropertyType of PropertyValue.

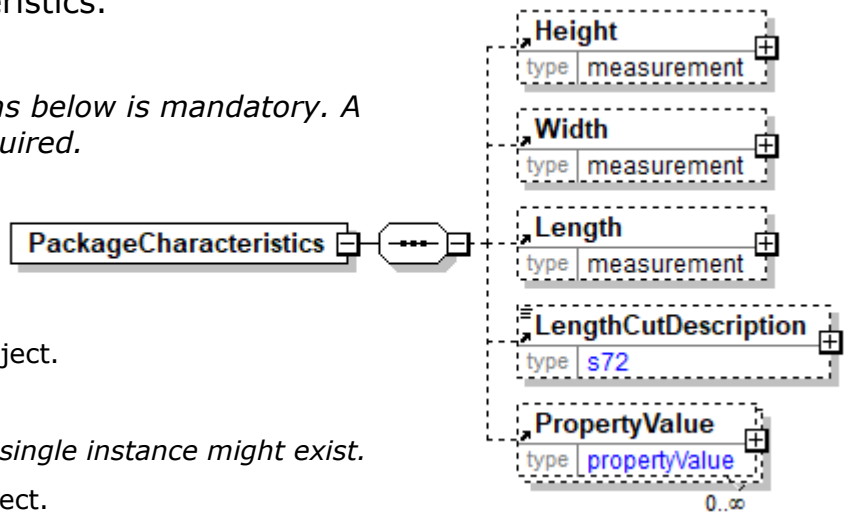

PackageCode

This element is used to identify the package code or identifier. This code can be no-standard and vary among companies or it can be assigned by a recognized agency.

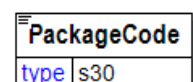

PackageIdentifier

The identifier of the productpackage (such as reel ID or pallet ID) that is used along with the

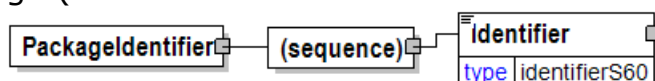

PurchaseOrderLineItemNumber to call off the product.

(sequence)

The sequence of items below is mandatory. A single instance is required.

Identifier

Identifier is mandatory. A single instance is required.

An Identifier is required for packages and items (pallets, reel packages, boxes, ream items, reel items, etc). The Identifier element contains the actual item identifier code. Identifier is repeatable so more than one identifier can be communicated. For example, the printed identifier on a label may be different from the barcode printed on the label.

PackageIDInformation

Group element identifying a lumber (wood) package. The package name may also be communicated.

PackageAgency [attribute]

PackageAgency is optional. A single instance might exist.

LumberAgency identifies which agency is responsible for assigning the lumber attributes.

Refer to PackageAgency definition for any enumerations.

(sequence)

The sequence of items below is mandatory. A single instance is required.

PackageCode

PackageCode is optional. A single instance might exist.

This element is used to identify the package code or identifier. This code can be non-standard and vary among companies or it can be assigned by a recognized agency.

PackageName

PackageName is optional. A single instance might exist.

Element used to identify the name of a package.

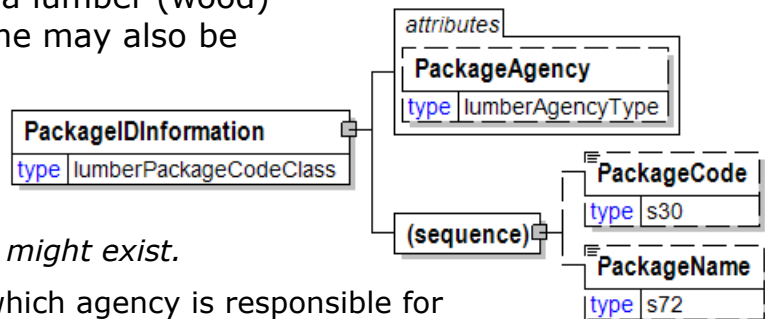

PackageInformation

The purpose of the PackageInformation structure is to clearly identify physical handling items that constitute the delivery.

PackageInformation is the highest level of product packaging it describes the shipping or warehousing unit.

If you are communicating a package, usually for logistics or transport purposes, you should include the PackageType, Identifier, ItemCount, and Quantity. (Note: you still have the ability to describe the item with one of the "named" items.)

If you are communicating one of the named Items there is no need to include PackageType, Identifier, ItemCount, and Quantity.

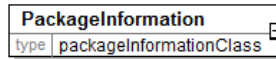

Since either of these two approaches can be used the entire contents of this element are optional even though the parent may be required. It is expected that you will fill in the appropriate details.

PackageType [attribute]

PackageType is optional. A single instance might exist.

Communicates the configuration of the item being reported.

Refer to PackageType definition for any enumerations.

MixedProductPalletIndicator [attribute]

MixedProductPalletIndicator is optional. A single instance might exist.

Specifies whether a product can be mixed with other products on the same pallet

Refer to MixedProductPalletIndicator definition for any enumerations.

PackageLevel [attribute]

PackageLevel is optional. A single instance might exist.

An hierarchical numbering approach that communicates containerization and identity.

(sequence)

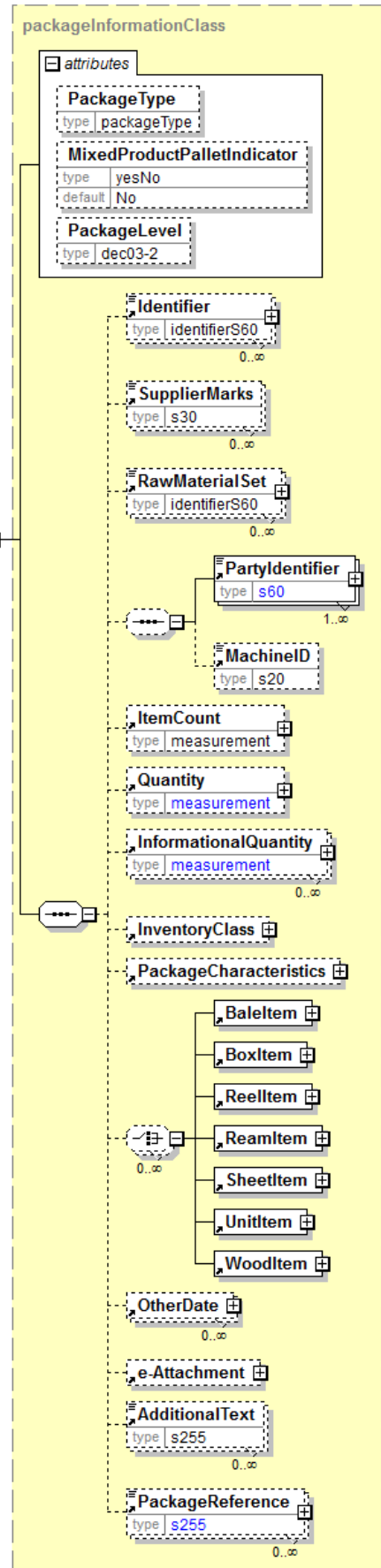

papiNet V2R31

The sequence of items below is mandatory. A single instance is required.

Identifier

Identifier is optional. Multiple instances might exist.

An Identifier is required for packages and items (pallets, reel packages, boxes, ream items, reel items, etc). The Identifier element contains the actual item identifier code. Identifier is repeatable so more than one identifier can be communicated. For example, the printed identifier on a label may be different from the barcode printed on the label.

SupplierMarks

SupplierMarks is optional. Multiple instances might exist.

Supplier provided markings.

RawMaterialSet

RawMaterialSet is optional. Multiple instances might exist.

This identifier derived element indicates a grouping of raw materials that were used to manufacture the product.

(sequence)

The sequence of items below is optional. A single instance might exist.

PartyIdentifier

PartyIdentifier is mandatory. One instance is required, multiple instances might exist.

A unique identifier of a specific party. This element contains an attribute PartyIdentifierType that indicates the type of the identifier.

MachineID

MachineID is optional. A single instance might exist.

An identifier assigned to the particular machine being referenced. For example, a machine could be a paper machine, an off-line coater, a sheeter, or a printing press. The particular machine being referenced will be determined by the business event being supported.

ItemCount

ItemCount is optional. A single instance might exist.

A count of the number of items (examples: a count of the number of boxes on a pallet or of reams in a box).

Quantity

Quantity is optional. A single instance might exist.

The Quantity element contains attributes that provide information about the type of quantity that is being communicated, the context in which the particular quantity is to be viewed, and (if the quantity represents an adjustment) an adjustment type.

The Quantity element contains three child elements that enable you to communicate a range of values for the quantity and a target or actual value. It is at this level (Value, RangeMin, and RangeMax) that the unit of measure is specified. This permits the range to be specified in a different unit of measure than the target.

InformationalQuantity

InformationalQuantity is optional. Multiple instances might exist.

A quantity given in a valid UOM used for information purposes only (not for

papiNet V2R31

calculation). For example, an ordered quantity was 100 reels as opposed to the invoice quantity of 20,000 pounds.

InventoryClass

InventoryClass is optional. A single instance might exist.

A group item containing information about status of inventory and goods items.

PackageCharacteristics

PackageCharacteristics is optional. A single instance might exist.

The package characteristics.

(choice)

[choice] is optional. Multiple instances might exist.

BaleItem

BaleItem is mandatory. A single instance is required.

An individual bale included as part of a delivery.

BoxItem

BoxItem is mandatory. A single instance is required.

A four-sided container for reams or sheet items. A pallet can contain zero or more boxes. The term Carton is a synonym for BoxItem. The term "Box" is used as constraint within the ItemType attribute of the UsageLineItemDetail to refer to a box that contains other boxes.

ReelItem

ReelItem is mandatory. A single instance is required.

A group item representing details of an actual (as opposed to specified) reel. One or several reels can be contained in a package.

ReamItem

ReamItem is mandatory. A single instance is required.

A wrapped quantity of SheetItem(s).

SheetItem

SheetItem is mandatory. A single instance is required.

A group item consisting potentially of the date the sheets were converted into sheets and/or packaged or finished.

UnitItem

UnitItem is mandatory. A single instance is required.

Unit Item.

WoodItem

WoodItem is mandatory. A single instance is required.

Group element containing elements describing a wood industry product.

OtherDate

OtherDate is optional. Multiple instances might exist.

A date that may not be specifically detailed within a document (example: print date at the PurchaseOrderLineItem).

e-Attachment

papiNet V2R31

e-Attachment is optional. A single instance might exist.

e-Attachment enables the sender to provide information about attachments to the document.

Note: BizTalk users may have problems in processing this element. See the papiNet FAQs (papiNet.org) for more information.

AdditionalText

AdditionalText is optional. Multiple instances might exist.

A text field that is used to communicate information not previously defined or for special instructions. To be used only for circumstances not covered by specific elements.

PackageReference

PackageReference is optional. Multiple instances might exist.

An element detailing the relevant references pertaining to a package. The type of reference is identified by the attributes PackageReferenceType and AssignedBy.

PackageLevel [attribute]

An hierarchical numbering approach that communicates containerization and identity.

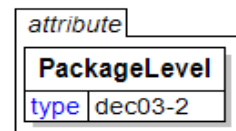

PackageMeasuringInfo

A grouping element that contains information about a measured package or a measured load when the load is treated as one package.

(sequence)

The sequence of items below is mandatory. A single instance is required.

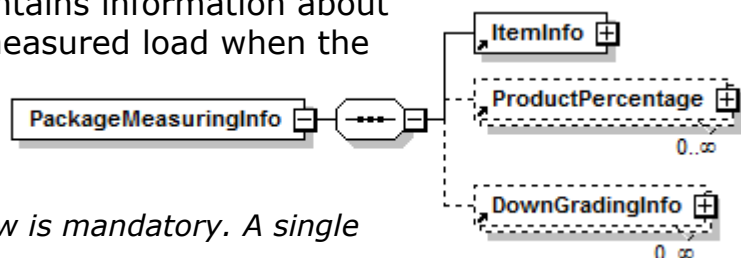

ItemInfo

ItemInfo is mandatory. A single instance is required.

A grouping element that contains information about an item. The attribute ItemType defines the type of physical item. Item Info describes property values of an item as well as tracking information between items processed in the supply chain.

ProductPercentage

ProductPercentage is optional. Multiple instances might exist.

The quantity of a product in percentage of the total quantity for an item containing many products. Attribute QuantityType, QuantityTypeContext and AdjustmentType can be used to define what quantity the percentage is referring to.

DownGradingInfo

DownGradingInfo is optional. Multiple instances might exist.

A grouping element that contains information about downgrading of products.

PackageName

Element used to identify the name of a package.

PackageName	
type	s72

PackageReference

An element detailing the relevant references pertaining to a package. The type of reference is identified by the attributes PackageReferenceType and AssignedBy.

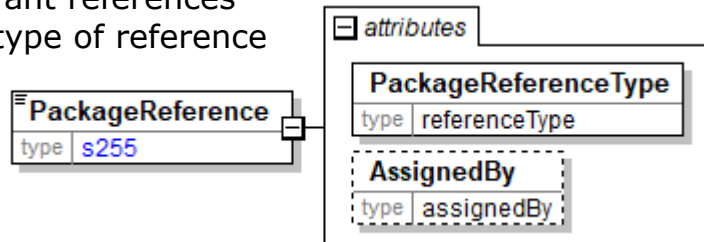

PackageReferenceType [attribute]

PackageReferenceType is mandatory. A single instance is required.

PackageReferenceType provides a contextual explanation of the specific reference identifier. Many items are currently prefixed by "Buyer", "Customer", "Seller", and/or "Supplier". Check for an existing non-prefixed version and use the non-prefixed version instead. In the (yet to be announced release date) version 3.0 the prefixed versions will be removed. Instead the attribute @AssignedBy will communicate the information previously communicated in the prefix.

Refer to PackageReferenceType definition for any enumerations.

AssignedBy [attribute]

AssignedBy is optional. A single instance might exist.

Identifies the type of party or the agency that has assigned the associated item, e.g. a reference of type OrderNumber.

Refer to AssignedBy for any enumerations.

PackageReferenceType [attribute]

PackageReferenceType provides a contextual explanation of the specific reference identifier. Many items are currently prefixed by "Buyer", "Customer", "Seller", and/or "Supplier". Check for an existing non-prefixed version and use the non-prefixed version instead. In the (yet to be announced release date) version 3.0 the prefixed versions will be removed. Instead the attribute @AssignedBy will communicate the information previously communicated in the prefix.

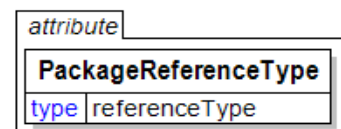

Refer to the [referenceType](#) entry for the list of enumerations and their definitions.

papiNet V2R31

PackagesPerWrap

The number of packages wrapped together.

PackagesPerWrap	
type	nni2

PackageType [attribute]

Communicates the configuration of the item being reported.

This item is restricted to the following list.

attribute	
PackageType	
type	packageType

Bag

A container with handles made of flexible material and used for storage and transportation.

Bale

Unbound materials bulk packed without pieces of board and at least 1 band

Barrel

A large cylindrical container.

Box

Note: Box is the papiNet way of referring to a Carton

Bundle

Unbound materials bulk packed with pieces of board at each end and at least 1 band

Container

Crate

A shipping container used for storage.

Drum

FullWoodPackage

HalfWoodPackage

LengthPackage

Package contains pieces of a single length.

Lift

LogPile

A pile of logs (a virtual type of package).

LooseVolumeItem

A unit containing loose volume products (during transports) (a type of virtual package).

Pail

Pallet

A portable platform.

papiNet V2R31

Piece

PulpUnit

ReelPackage

Sack

A container without handles made of flexible material and used for storage and transportation. Sacks are normally made of jute or any other coarse material.

StepPackage

Package in which pieces are group together by length, with longest length at the bottom of the package and shortest on top.

TankCompartment

A compartment in a divided tank.

TruckPackage

Package contains pieces of mixed random lengths.

UnformedPulp

Vehicle

PackageType

Communicates the configuration of the item being reported.

PackageType	
type	packageType

This item is restricted to the following list.

Bag

A container with handles made of flexible material and used for storage and transportation.

Bale

Unbound materials bulk packed without pieces of board and at least 1 band

Barrel

A large cylindrical container.

Box

Note: Box is the papiNet way of referring to a Carton

Bundle

Unbound materials bulk packed with pieces of board at each end and at least 1 band

Container

Crate

A shipping container used for storage.

Drum

FullWoodPackage

HalfWoodPackage

LengthPackage

Package contains pieces of a single length.

Lift

LogPile

A pile of logs (a virtual type of package).

LooseVolumeItem

A unit containing loose volume products (during transports) (a type of virtual package).

Pail

Pallet

A portable platform.

Piece

PulpUnit

ReelPackage

Sack

A container without handles made of flexible material and used for storage and transportation. Sacks are normally made of jute or any other coarse material.

StepPackage

Package in which pieces are group together by length, with longest length at the bottom of the package and shortest on top.

TankCompartment

A compartment in a divided tank.

TruckPackage

Package contains pieces of mixed random lengths.

UnformedPulp

Vehicle

Packaging

Type of a package that includes individual products.

(sequence)

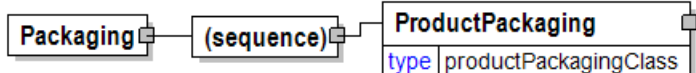

The sequence of items below is mandatory. A single instance is required.

ProductPackaging

ProductPackaging is mandatory. A single instance is required.

Defines the methods and materials used for packaging.

PackagingCharacteristics

An element containing carton or pallet packing information. PackagingCharacteristics can either have the BoxCharacteristics or

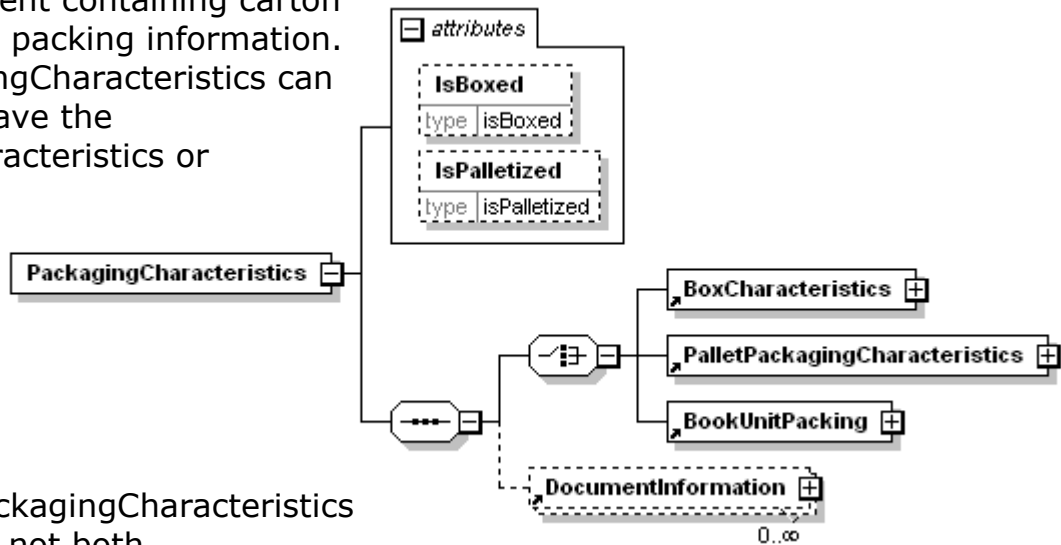

PalletPackagingCharacteristics element not both.

IsBoxed [attribute]

IsBoxed is optional. A single instance might exist.

Refer to IsBoxed definition for any enumerations.

IsPalletized [attribute]

IsPalletized is optional. A single instance might exist.

The buyer's directions for how the item is to be palletized.

Refer to IsPalletized definition for any enumerations.

(sequence)

The sequence of items below is mandatory. A single instance is required.

(choice)

[choice] is mandatory. A single instance is required.

BoxCharacteristics

BoxCharacteristics is mandatory. A single instance is required.

BoxCharacteristics is a group element that contains information about the box (or carton)

PalletPackagingCharacteristics

PalletPackagingCharacteristics is mandatory. A single instance is required.

PalletPackagingCharacteristics details the characteristics of the packaging for a pallet.

BookUnitPacking

BookUnitPacking is mandatory. A single instance is required.

Book unit packing information

DocumentInformation

DocumentInformation is optional. Multiple instances might exist.

A group element containing a specification of required documents in the business process. Additional free text to be printed on documents can also be specified.

PackagingCode

PackagingCode is a code describing the packaging of the product.

Agency [attribute]

Agency is mandatory. A single instance is required.

Describes the agency maintaining the list of codes. To be included in this list the agency must be a recognized standards body or industry organisation.

- For the element that owns this attribute.
- For another attribute in the list of attributes associated with the parent element.

Refer to Agency definition for any enumerations.

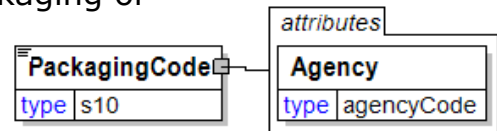

PackagingCodeInfo

A group item specifying code and description for packaging details.

Agency [attribute]

Agency is mandatory. A single instance is required.

Describes the agency maintaining the list of codes. To be included in this list the agency must be a recognized standards body or industry organisation.

- For the element that owns this attribute.
- For another attribute in the list of attributes associated with the parent element.

Refer to Agency definition for any enumerations.

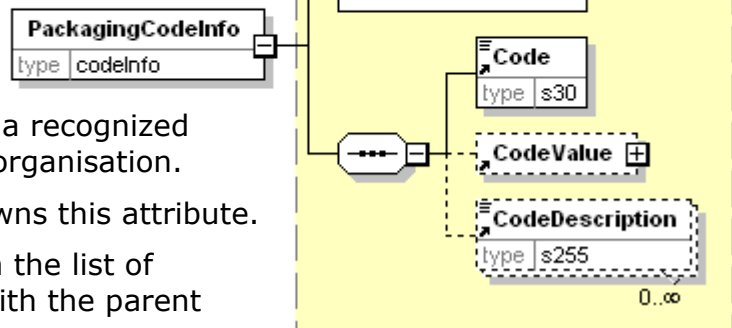

(sequence)

The sequence of items below is mandatory. A single instance is required.

Code

Code is mandatory. A single instance is required.

Specifies a code that is defined by an agency. The agency is given for the whole construct containing the code.

CodeValue

CodeValue is optional. A single instance might exist.

A grouping element specifying a value belonging to a code that is defined by an agency.

CodeDescription

papiNet V2R31

CodeDescription is optional. Multiple instances might exist.

A textual description for the meaning of a code that is defined by an agency. When the Code is associated with a CodeValue of type TextValue, then the CodeDescription is a textual description of both the Code and the TextValue.

PackagingCodeSpecification

A grouping element specifying code and description for packaging details.

(sequence)

The sequence of items below is mandatory. A single instance is required.

PackagingCode

PackagingCode mandatory. A single instance is required.

PackagingCode is a code describing the packaging of the product.

PackagingDescription

PackagingDescription is optional. Multiple instances might exist.

A text field element describing the packaging of a product A text field element describing the packaging of a product.

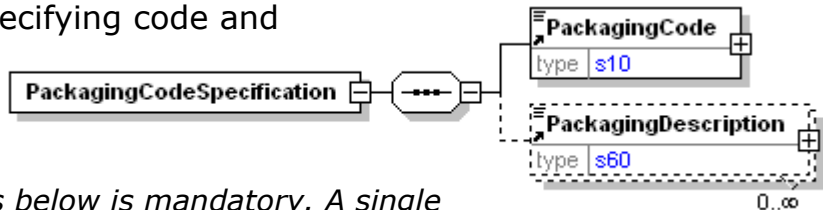

PackagingDescription

A text field element describing the packaging of a product.

Language [attribute]

Language is optional. A single instance might exist.

The valid Alpha 2- and Alpha 3-character list of language codes in the ISO 639-1 and 639-2 international standards.

Information on the content of this attribute is available at:
https://www.loc.gov/standards/iso639-2/php/code_list.php

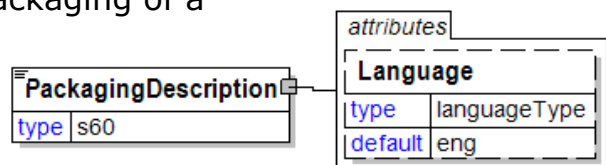

PackagingInformation

Group element construct used to all information associated with the packaging of a product. Measurements, package ID, label, stencil, band, pallet and wrap characteristics may all be detailed.

(sequence)

The sequence of items below is mandatory. A single instance is required.

QuantityInUnit

QuantityInUnit is optional. A single instance might exist.

Used to identify the number of items packed within this package unit.

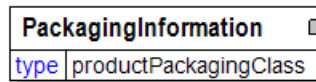

UnitDimension

UnitDimension is optional. A single instance might exist.

Unit Dimension

Weight

Weight is optional. A single instance might exist.

The weight of the item.

PackageIDInformation

PackageIDInformation is optional. A single instance might exist.

Group element identifying a lumber (wood) package. The package name may also be communicated.

LabelCharacteristics

LabelCharacteristics is optional. Multiple instances might exist.

A group item that organises the labeling information.

StencilCharacteristics

StencilCharacteristics is optional. Multiple instances might exist.

A group element specifying attributes of a stencil to be applied to an item, and optional text.

BandCharacteristics

BandCharacteristics is optional. Multiple instances might exist.

A group item that organises the packaging band detail information.

PalletCharacteristics

PalletCharacteristics is optional. Multiple instances might exist.

A group item that provides pallet detail information.

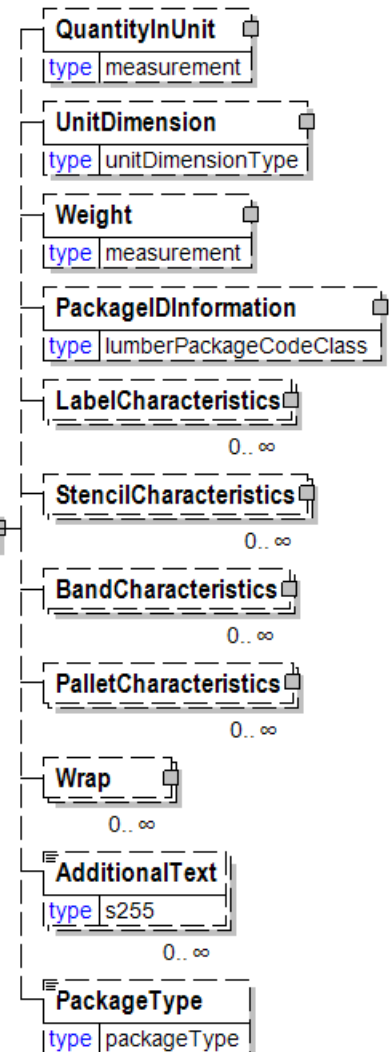

Wrap

Wrap is optional. Multiple instances might exist.

A group item that organises wrapping detail information.

AdditionalText

AdditionalText is optional. Multiple instances might exist.

A text field that is used to communicate information not previously defined or for special instructions. To be used only for circumstances not covered by specific elements.

PackageType

PackageType is optional. A single instance might exist.

Communicates the configuration of the item being reported.

Refer to PackageType definition for any enumerations.

PackingList

The PackingList element is the root element for the PackingList e-Document.

The PackingList e-Document specifies the details of a shipment that is being despatched. The seller should send the PackingList e-Document in sufficient time so that the recipient can process the information before the goods arrive. The recipient can then prepare efficiently for the receipt of the goods.

PackingListStatusType [attribute]

PackingListStatusType is mandatory. A single instance is required.

Attribute is used to identify the PackingList status.

Refer to PackingListStatusType definition for any enumerations.

Reissued [attribute]

Reissued is optional. A single instance might exist.

Either "Yes" or "No".

Refer to Reissued definition for any enumerations.

Language [attribute]

Language is optional. A single instance might exist.

The valid Alpha 2- and Alpha 3-character list of language codes in the ISO 639-1 and 639-2 international standards.

Information on the content of this attribute is available at:
https://www.loc.gov/standards/iso639-2/php/code_list.php

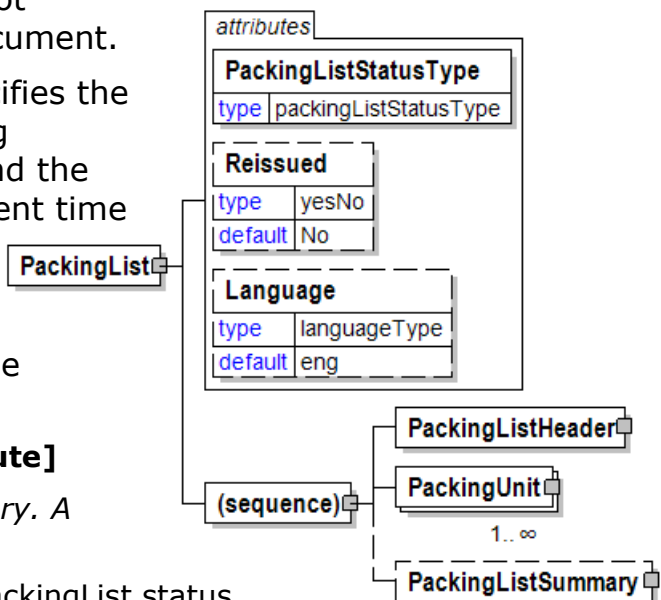

(sequence)

The sequence of items below is mandatory. A single instance is required.

PackingListHeader

PackingListHeader is mandatory. A single instance is required.

Information that is applicable to every item on the PackingList e-Document.

PackingUnit

PackingUnit is mandatory. One instance is required, multiple instances might exist.

Describes the major unit of packing the materials in the shipment.

PackingListSummary

PackingListSummary is optional. A single instance might exist.

PackingListSummary contains summary information applicable to the entire PackingList.

PackingListDate

Used to identify the issue date of the PackingList transaction.

(sequence)

The sequence of items below is mandatory. A single instance is required.

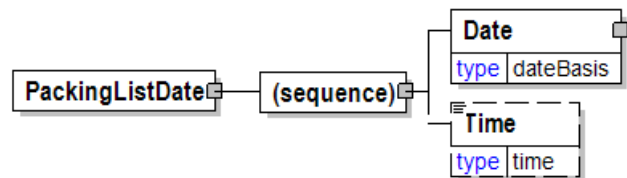

Date

Date is mandatory. A single instance is required.

A group element that contains the specification of Year, Month, and Day.

Time

Time is optional. A single instance might exist.

Times are treated in a standard XML fashion with a special case used to indicate a generalized "local" time. The standard XML approach to time is hh:mm:ss, hh:mm:ssZ, or hh:mm:ss±hh:mm.

hh:mm:ss±hh:mm is used to represent a time with a time zone. The time zone is communicated as the number of hours offset from the Universal Time Coordinate (UTC), a.k.a. Greenwich Mean Time.

hh:mm:ssZ indicates the time at Zulu (another name for UTC).

hh:mm:ss or hh:mm indicates within papiNet the applicable local time where the associated event is taking place. Caution should be used when processing times of this nature as the papiNet approach may be in discord with other users of XML.

PackingListHeader

Information that is applicable to every item on the PackingList e-Document.

(sequence)

The sequence of items below is mandatory. A single instance is required.

PackingListNumber

PackingListNumber is mandatory. A single instance is required.

The PackingList identifying number.

TransactionHistoryNumber

TransactionHistoryNumber is optional. A single instance might exist.

A sequential number that keeps track of the version of a document.

However when the document is a confirmation document, in which case the *TransactionHistoryNumber* refers to the trigger transaction for the confirmation.

PackingListDate

PackingListDate is mandatory. A single instance is required.

Used to identify the issue date of the PackingList transaction.

PackingListReference

PackingListReference is optional. Multiple instances might exist.

Element used to identify any external or associated documents, identifiers, etc.

BuyerParty

BuyerParty is mandatory. A single instance is required.

The legal entity to which the product is sold. Also commonly referred to as the sold-to party or customer. If no *OtherParty* is defined as the Payer, the Buyer is the Payer.

BillToParty

BillToParty is optional. A single instance might exist.

The address where the invoice is to be sent.

SupplierParty

SupplierParty is mandatory. A single instance is required.

The organisation or business entity responsible for providing the product. *SupplierParty* is also the seller of the product, if *Seller* is not specified as *OtherParty* = Seller.

CarrierParty

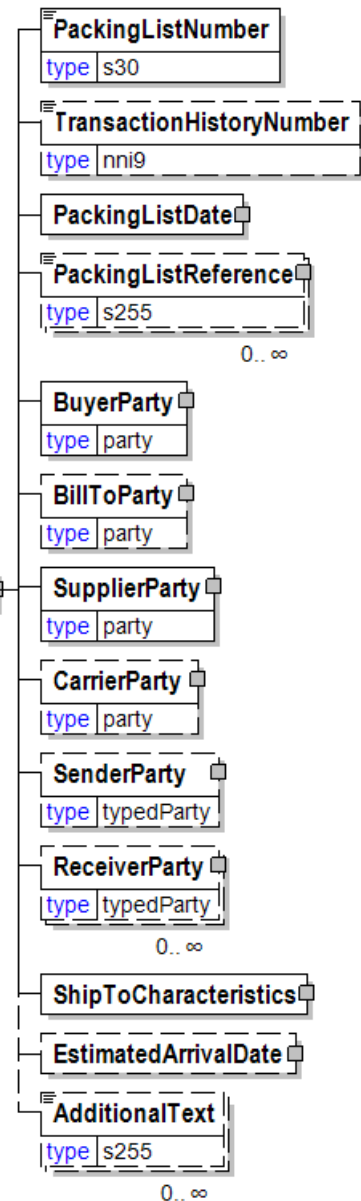

CarrierParty is optional. A single instance might exist.

The party performing the transport of the product from the pickup location to the ship-to location; could be a hauler.

SenderParty

SenderParty is optional. A single instance might exist.

The business entity issuing the e-Document, the source of the document.

The entity responsible for the content. If the sender party has out sourced the message service to a third party the SenderParty is the issuer of the e-Document and not the party performing the transmission service of the electronic message.

ReceiverParty

ReceiverParty is optional. Multiple instances might exist.

The business entity for whom the e-Document is intended, the destination of the document.

The entity interested in the content. If the receiver party has outsourced the message service to a third party the ReceiverParty is the intended party for the e-Document and not the party performing the receiving service of the electronic message.

ShipToCharacteristics

ShipToCharacteristics is mandatory. A single instance is required.

A group item that provides information important for the Ship-To Party.

EstimatedArrivalDate

EstimatedArrivalDate is optional. A single instance might exist.

An estimation of the arrival date.

AdditionalText

AdditionalText is optional. Multiple instances might exist.

A text field that is used to communicate information not previously defined or for special instructions. To be used only for circumstances not covered by specific elements.

PackingListItem

The required element PackingListItem refers to one and only one PurchaseOrder and one and only one PurchaseOrderLineItem of that PurchaseOrder.

PackingListItemType [attribute]

PackingListItemType is mandatory. A single instance is required.

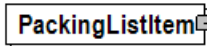

This attribute is used to identify the type of package configuration the item is. To help with physical identification.

Refer to PackingListItemType definition for any enumerations.

(sequence)

The sequence of items below is mandatory. A single instance is required.

PackingListItemNumber

PackingListItemNumber is mandatory. A single instance is required.

Used to uniquely identify this item within the PackingList.

Identifier

Identifier is optional. Multiple instances might exist.

An Identifier is required for packages and items (pallets, reel packages, boxes, ream items, reel items, etc). The Identifier element contains the actual item identifier code. Identifier is repeatable so more than one identifier can be communicated. For example, the printed identifier on a label may be different from the barcode printed on the label.

PurchaseOrderInformation

PurchaseOrderInformation is mandatory. A single instance is required.

A group item containing information unique to this PurchaseOrder, which is provided by the buyer. PurchaseOrderInformation can be optional in the supply chain. Invoices are created without having a PurchaseOrder in Vendor Managed Inventory. Freight invoices also will not have a PurchaseOrder number.

PurchaseOrderLineItemNumber

PurchaseOrderLineItemNumber is optional. A single instance might exist.

The sequential number that uniquely identifies the PurchaseOrder line item.

PackingListReference

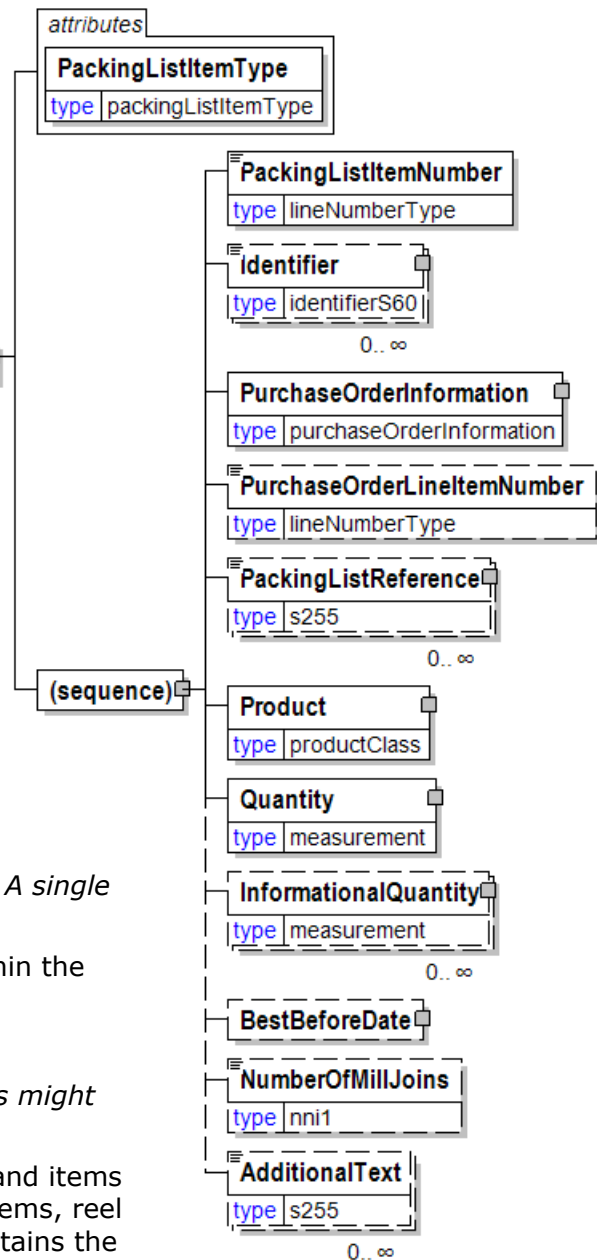

papiNet V2R31

PackingListReference is optional. Multiple instances might exist.

Element used to identify any external or associated documents, identifiers, etc.

Product

Product is mandatory. A single instance is required.

Product is a group item defining the article and its characteristics. Product is used to specify product characteristics organized by ProductIdentifier, ProductDescription, and Classification. Book Manufacturing, Label Stock, Paper, Pulp, Recovered Paper, Wood Products, and Virgin Fibre market segments have defined their product characteristics and conversion features for implementation in papiNet.

Quantity

Quantity is mandatory. A single instance is required.

The Quantity element contains attributes that provide information about the type of quantity that is being communicated, the context in which the particular quantity is to be viewed, and (if the quantity represents an adjustment) an adjustment type.

The Quantity element contains three child elements that enable you to communicate a range of values for the quantity and a target or actual value. It is at this level (Value, RangeMin, and RangeMax) that the unit of measure is specified. This permits the range to be specified in a different unit of measure than the target.

InformationalQuantity

InformationalQuantity is optional. Multiple instances might exist.

A quantity given in a valid UOM used for information purposes only (not for calculation). For example, an ordered quantity was 100 reels as opposed to the invoice quantity of 20,000 pounds.

BestBeforeDate

BestBeforeDate is optional. A single instance might exist.

The date, prior to which, the product is suggested to be used.

NumberOfMillJoins

NumberOfMillJoins is optional. A single instance might exist.

The number of joins in the reel.

AdditionalText

AdditionalText is optional. Multiple instances might exist.

A text field that is used to communicate information not previously defined or for special instructions. To be used only for circumstances not covered by specific elements.

PackingListItemNumber

Used to uniquely identify this item within the PackingList.

PackingListItemNumber
type lineNumberType

PackingListItemType [attribute]

This attribute is used to identify the type of package configuration the item is. To help with physical identification.

This item is restricted to the following list.

- Box**
- Ream**
- Reel**
- Sheet**
- Other**



PackingListNumber

The PackingList identifying number.



PackingListReference

Element used to identify any external or associated documents, identifiers, etc.

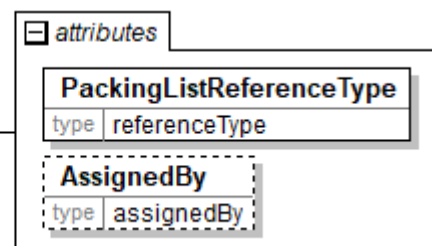

PackingListReferenceType [attribute]

PackingListReferenceType is mandatory. A single instance is required.

Provides a contextual explanation of the specific reference identifier. Many items are currently prefixed by "Buyer", "Forwarder", "Manufacturer", "Mill", "Seller", "Supplier", "Warehouse", or "Vendor". Check for an existing non-prefixed version and use the non-prefixed version instead. In the (yet to be announced release date) version 3.0 the prefixed versions will be removed. Instead the attribute @AssignedBy will communicate the information previously communicated in the prefix.

Refer to PackingListReferenceType definition for any enumerations.

AssignedBy [attribute]

AssignedBy is optional. A single instance might exist.

Identifies the type of party or the agency that has assigned the associated item, e.g. a reference of type OrderNumber.

Refer to AssignedBy for any enumerations.

PackingListReferenceType [attribute]

Provides a contextual explanation of the specific reference identifier. Many items are currently prefixed by "Buyer", "Forwarder", "Manufacturer", "Mill", "Seller", "Supplier", "Warehouse", or "Vendor". Check for an existing non-prefixed version and use the non-prefixed version instead. In the (yet to be announced release date) version 3.0 the prefixed versions will be removed. Instead the attribute @AssignedBy will communicate the information previously communicated in the prefix.

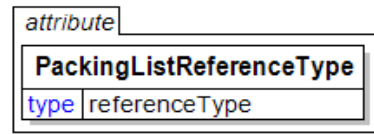

Refer to the [referenceType](#) entry for the list of enumerations and their definitions.

PackingListStatusType [attribute]

Attribute is used to identify the PackingList status.

This item is restricted to the following list.



Cancelled

The supplied information has been cancelled. Items that have been cancelled are not included in totals on the summary levels of the e-Document.

Original

The supplied information is the first version of that information.

Replaced

The supplied information is replacing earlier supplied information. The receiver should revalidate the information in their system based upon the entire information received.

PackingListSummary

PackingListSummary contains summary information applicable to the entire PackingList.

(sequence)

The sequence of items below is mandatory. A single instance is required.

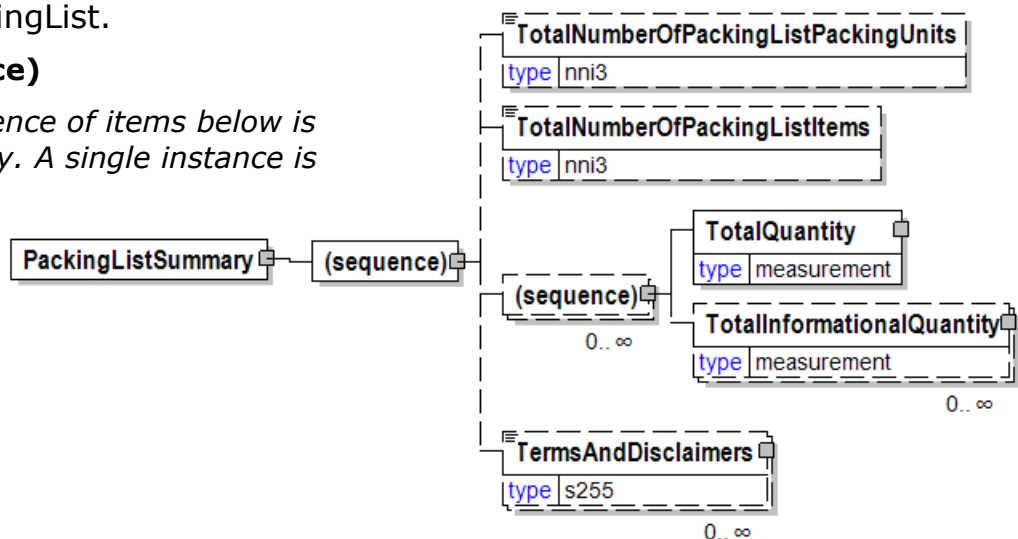

TotalNumberOfPackingListPackingUnits

TotalNumberOfPackingListPackingUnits is optional. A single instance might exist.

TotalNumberOfPackingListPackingUnits

TotalNumberOfPackingListItems

TotalNumberOfPackingListItems is optional. A single instance might exist.

Total Number Of PackingList Items

(sequence)

The sequence of items below is optional. Multiple instances might exist.

TotalQuantity

TotalQuantity is mandatory. A single instance is required.

The total quantity of similar items in the e-Document. TotalQuantity is primarily used in the summary section of documents where it is repeatable to permit totaling for different units of measure.

TotalInformationalQuantity

TotalInformationalQuantity is optional. Multiple instances might exist.

A quantity that is used to communicate related information about the parent element. This element represents a total that is derived from individual line items.

TermsAndDisclaimers

TermsAndDisclaimers is optional. Multiple instances might exist.

An element that contains legal information with an indication of what the Language is.

PackingUnit

Describes the major unit of packing the materials in the shipment.

PackingUnitType [attribute]

PackingUnitType is mandatory. A single instance is required.

Attribute used to identify the type of this packing unit.

Refer to PackingUnitType definition for any enumerations.

(sequence)

The sequence of items below is mandatory. A single instance is required.

PackingUnitSerialNumber

PackingUnitSerialNumber is mandatory. A single instance is required.

The serial number of the packing unit.

Identifier

Identifier is mandatory. One instance is required, multiple instances might exist.

An Identifier is required for packages and items (pallets, reel packages, boxes, ream items, reel items, etc). The Identifier element contains the actual item identifier code. Identifier is repeatable so more than one identifier can be communicated. For example, the printed identifier on a label may be different from the barcode printed on the label.

PackingUnitMeasurements

PackingUnitMeasurements is optional. A single instance might exist.

A group element construct detailing the measurements, height, weight, and length, of the specified packing unit.

PackingListReference

PackingListReference is optional. Multiple instances might exist.

Element used to identify any external or associated documents, identifiers, etc.

Quantity

Quantity is mandatory. A single instance is required.

The Quantity element contains attributes that provide information about the type of quantity that is being communicated, the context in which the particular quantity is to be viewed, and (if the quantity represents an adjustment) an adjustment type.

The Quantity element contains three child elements that enable you to communicate a range of values for the quantity and a target or actual value. It is at this level (Value, RangeMin, and RangeMax) that the unit of measure is specified. This permits the range to be specified in a different unit of measure than the target.

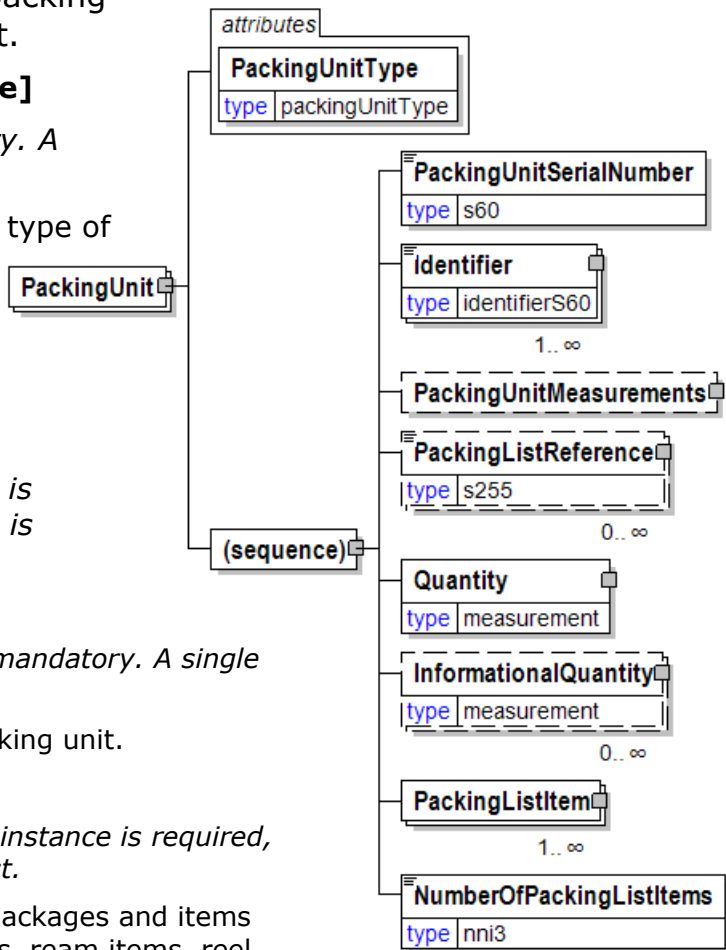

InformationalQuantity

InformationalQuantity is optional. Multiple instances might exist.

A quantity given in a valid UOM used for information purposes only (not for calculation). For example, an ordered quantity was 100 reels as opposed to the invoice quantity of 20,000 pounds.

PackingListItem

PackingListItem is mandatory. One instance is required, multiple instances might exist.

The required element PackingListItem refers to one and only one PurchaseOrder and one and only one PurchaseOrderLineItem of that PurchaseOrder.

NumberOfPackingListItems

NumberOfPackingListItems is mandatory. A single instance is required.

The number of PackingList items in a PackingUnit of the PackingList.

PackingUnitMeasurements

A group element construct detailing the measurements, height, weight, and length, of the specified packing unit.

(sequence)

The sequence of items below is mandatory. A single instance is required.

PackingUnitMeasurements

(sequence)

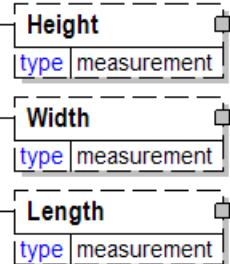

Height

Height is optional. A single instance might exist.

The height of the object.

Width

Width is optional. A single instance might exist.

The width of the object.

Length

Length is optional. A single instance might exist.

The length of the object.

PackingUnitSerialNumber

The serial number of the packing unit.

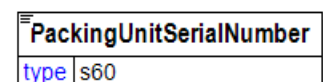

PackingUnitType [attribute]

Attribute used to identify the type of this packing unit.

This item is restricted to the following list.

Container

Pallet

Stack

Other

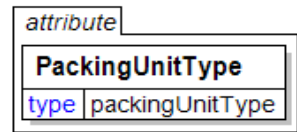

PageCountDetail

A group element construct detailing the different types of page counts.

AssignedBy [attribute]

AssignedBy is optional. A single instance might exist.

Identifies the type of party or the agency that has assigned the associated item, e.g. a reference of type OrderNumber.

Refer to AssignedBy for any enumerations.

(sequence)

The sequence of items below is mandatory. A single instance is required.

Quantity

Quantity is mandatory. A single instance is required.

The Quantity element contains attributes that provide information about the type of quantity that is being communicated, the context in which the particular quantity is to be viewed, and (if the quantity represents an adjustment) an adjustment type.

The Quantity element contains three child elements that enable you to communicate a range of values for the quantity and a target or actual value. It is at this level (Value, RangeMin, and RangeMax) that the unit of measure is specified. This permits the range to be specified in a different unit of measure than the target.

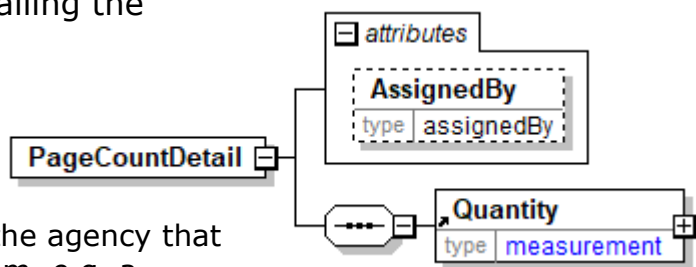

PageSequenceNumber

The physical sequence of the page within the component.

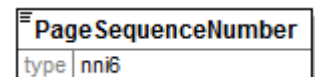

PagesPerSet

Pages per Set

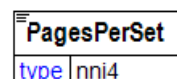

papiNet V2R31

PagesPerSignature

Pages per signature

PagesPerSignature	
type	nni4

Pagination

Number of pages that make up a book.

Pagination	
type	s30

PalletAdditionsType [attribute]

Gives additional characteristics of the pallet

This item is restricted to the following list.

attribute	
PalletAdditionsType	
type	palletAdditionsType

FullPerimeter

The pallet has a full perimeter.

FungicideTreatment

The pallet wood has received a fungicide treatment.

LongSlats

The pallet has long slats.

NoBlockOffset

The pallet is a no-block offset.

Reinforced

The pallet is reinforced.

TrimmedEdges

The pallet has trimmed edges

PalletCharacteristics

A group item that provides pallet detail information.

MixedProductPalletIndicator [attribute]

MixedProductPalletIndicator is optional. A single instance might exist.

Specifies whether a product can be mixed with other products on the same pallet

Refer to MixedProductPalletIndicator definition for any enumerations.

PalletType [attribute]

PalletType is optional. A single instance might exist.

Details the type of pallet that can be used These pallets are common in the industry

Refer to PalletType definition for any enumerations.

PalletLedgeType [attribute]

PalletLedgeType is optional. A single instance might exist.

Details the type of pallet ledges that can be used

Refer to PalletLedgeType definition for any enumerations.

PalletCoverType [attribute]

PalletCoverType is optional. A single instance might exist.

Details the type of cover that can be used on top of the pallet body

Refer to PalletCoverType definition for any enumerations.

PalletAdditionsType [attribute]

PalletAdditionsType is optional. A single instance might exist.

Gives additional characteristics of the pallet

Refer to PalletAdditionsType definition for any enumerations.

PalletTopType [attribute]

PalletTopType is optional. A single instance might exist.

Details the type of pallet top that can be used

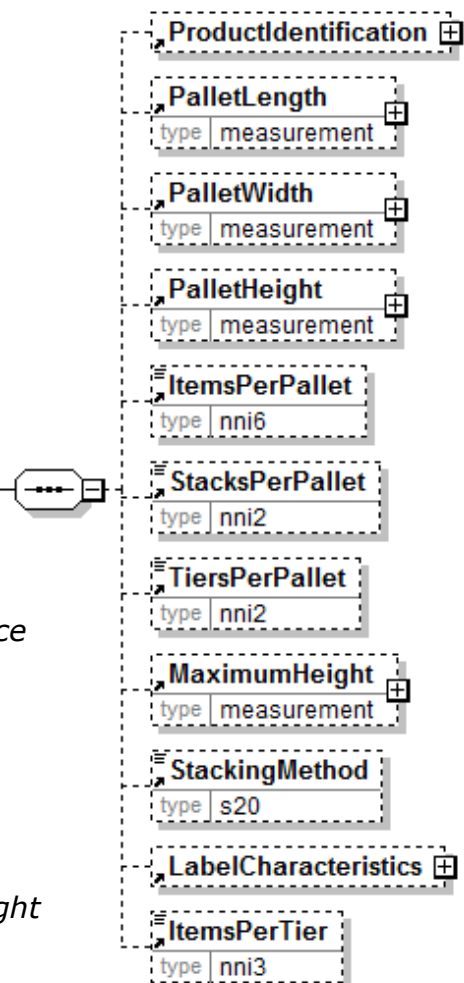
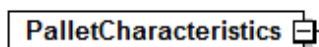
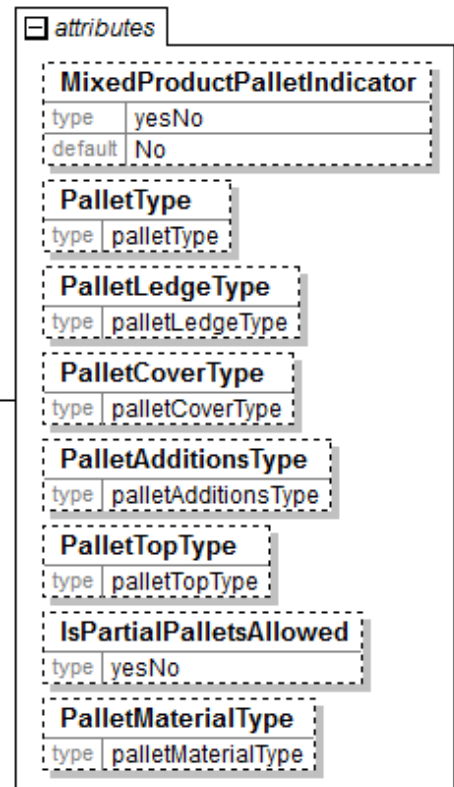

Refer to PalletTopType definition for any enumerations.

IsPartialPalletsAllowed [attribute]

IsPartialPalletsAllowed is optional. A single instance might exist.

Indicates if partial pallets are allowed or not.

This item is restricted to the following list.

Refer to IsPartialPalletsAllowed definition for any enumerations.

PalletMaterialType [attribute]

PalletMaterialType is optional. A single instance might exist.

Defines the type of material that the pallet is made of.

Refer to PalletMaterialType definition for any enumerations.

(sequence)

The sequence of items below is mandatory. A single instance is required.

ProductIdentification

ProductIdentification is optional. A single instance might exist.

A grouping element designed to communicate product identification related to the parent element that contains this item.

PalletLength

PalletLength is optional. A single instance might exist.

The measurement value of the length of the pallet.

PalletWidth

PalletWidth is optional. A single instance might exist.

The measurement value of the width of the pallet.

PalletHeight

PalletHeight is optional. A single instance might exist.

The measurement value of the height of the pallet.

ItemsPerPallet

ItemsPerPallet is optional. A single instance might exist.

The number of items on the pallet (either reels or sheet or sheet-package).

StacksPerPallet

StacksPerPallet is optional. A single instance might exist.

The number of stacks on a pallet, where a stack is a vertical arrangement of items (looking down from above).

TiersPerPallet

TiersPerPallet is optional. A single instance might exist.

The number of tiers on the pallet, where a tier is a layer of items.

MaximumHeight

MaximumHeight is optional. A single instance might exist.

The maximum height allowed including the pallet.

StackingMethod

papiNet V2R31

StackingMethod is optional. A single instance might exist.

A text field describing the pattern used when stacking of pallets.

LabelCharacteristics

LabelCharacteristics is optional. A single instance might exist.

A group item that organises the labeling information.

ItemsPerTier

ItemsPerTier is optional. A single instance might exist.

Number of items on each full tier, e.g. number of boxes, gaylords, loose books etc. on a tier on a pallet.

PalletCoverType [attribute]

Details the type of cover that can be used on top of the pallet body

This item is restricted to the following list.



MetalPlateWithPE

A metal plate covers the pallet with polyethylene on top.

WithoutPE

The pallet cover is without polyethylene on top.

WithPE

The pallet cover is with polyethylene on top.

WithPEUnderCover

The pallet cover is with polyethylene under the wooden plates.

WoodStripWithPE

The pallet cover is made up from a wood strip with polyethylene on top

WoodStripWithoutPE

The pallet cover is made up from a wood strip without polyethylene on top.

PalletHeight

The measurement value of the height of the pallet.

(sequence)

The sequence of items below is mandatory. A single instance is required.

Value

Value is mandatory. A single instance is required.

A numeric value expressed in the unit of measure (UOM).

RangeMin

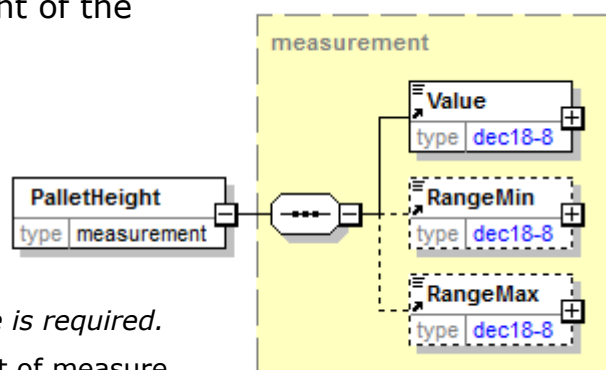

papiNet V2R31

RangeMin is optional. A single instance might exist.

The minimum value (lower boundary) allowed for the Measurement that is the parent of this element.

RangeMax

RangeMax is optional. A single instance might exist.

The maximum value (upper boundary) allowed for the Measurement that is the parent of this element. Some elements use the RangeMax element with an extended list of unit of measures. (Note: the red colour in the picture is an artifact of how the graphic was captured and should be disregarded.)

PalletLedgeType [attribute]

Details the type of pallet ledges that can be used

This item is restricted to the following list.



LongWay

The ledge wood is on the long side of the pallet.

LongWayWithBelt

The ledge wood is on the long side of the pallet, with a packaging belt.

ShortWay

The ledge wood is on the short side of the pallet.

ShortWayWithBelt

The ledge wood is on the short side of the pallet, with a packaging belt

PalletLength

The measurement value of the length of the pallet.

(sequence)

The sequence of items below is mandatory. A single instance is required.

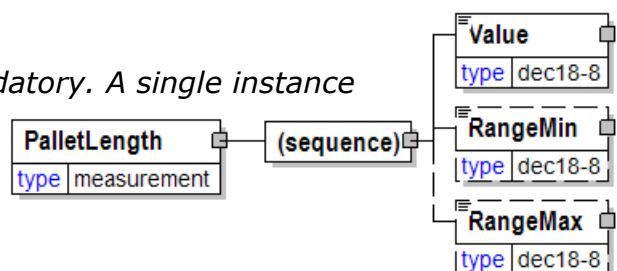

Value

Value is mandatory. A single instance is required.

A numeric value expressed in the unit of measure (UOM).

RangeMin

RangeMin is optional. A single instance might exist.

The minimum value (lower boundary) allowed for the Measurement that is the parent of this element.

RangeMax

RangeMax is optional. A single instance might exist.

The maximum value (upper boundary) allowed for the Measurement that is the parent of this element. Some elements use the RangeMax element with an extended list of unit of measures. (Note: the red colour in the picture is an artifact of how the graphic was captured and should be disregarded.)

PalletMaterialType [attribute]

Defines the type of material that the pallet is made of.

This item is restricted to the following list.

Plastic

Pallet made of plastic.

Steel

Pallet made of steel.

Wood

Pallet made of wood.



PalletPackagingCharacteristics

PalletPackagingCharacteristics details the characteristics of the packaging for a pallet.

(sequence)

The sequence of items below is mandatory. A single instance is required.

PackagingCode

PackagingCode is optional. A single instance might exist.

PackagingCode is a code describing the packaging of the product.

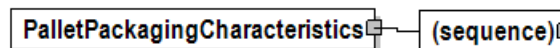

PackagingDescription

PackagingDescription is optional. A single instance might exist.

A text field element describing the packaging of a product.

WrapCharacteristics

WrapCharacteristics is optional. A single instance might exist.

A group element that contains elements that describe the manner in which the item is wrapped.

PalletCharacteristics

PalletCharacteristics is optional. A single instance might exist.

A group item that provides pallet detail information.

BandCharacteristics

BandCharacteristics is optional. A single instance might exist.

A group item that organises the packaging band detail information.



papiNet V2R31

LabelCharacteristics

LabelCharacteristics is optional. Multiple instances might exist.

A group item that organises the labeling information.

StencilCharacteristics

StencilCharacteristics is optional. Multiple instances might exist.

A group element specifying attributes of a stencil to be applied to an item, and optional text.

MaximumHeight

MaximumHeight is optional. A single instance might exist.

The maximum height allowed including the pallet.

MaximumGrossWeight

MaximumGrossWeight is optional. A single instance might exist.

The maximum weight allowed including the pallet.

AdditionalText

AdditionalText is optional. Multiple instances might exist.

A text field that is used to communicate information not previously defined or for special instructions. To be used only for circumstances not covered by specific elements.

PalletTopType [attribute]

Details the type of pallet top that can be used

This item is restricted to the following list.

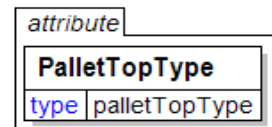

CartonboardCover

The pallet top is composed of carton-board

Chipboard

The pallet top is composed of chipboard.

Corrugated

The pallet top is composed of corrugated board.

EdgeProtection

The pallet top has edge protections for the sheets of paper placed on top. They are placed on the top pallet edges.

FiveStripsOfWood

The pallet top is composed of five strips of wood.

FullyCoverThreeCrossBoards

The pallet top is composed of a fully wooden cover with three cross ledges on top.

FungicTreatWoodFrame

The pallet top is composed of a wooden frame, which is treated with fungicide.

OneStripOfWood

papiNet V2R31

The pallet top is composed of one strip of wood.

PlywoodCover

The pallet top is composed of plywood.

TwoStripsOfWood

The pallet top is composed of two strips of wood.

ThreeStripsOfWood

The pallet top is composed of three strips of wood.

WoodenFrame

The pallet top is composed of a wooden frame

PalletType [attribute]

Details the type of pallet that can be used. These pallets are common in the industry

This item is restricted to the following list.

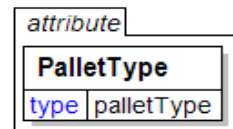

Euro

The pallet is the standardized Euro pallet type.

EuroOneWay

A standardized Euro pallet that is designed and constructed so as to allow fork entry from only the back or front. Euro One-way pallets are ideally used when you know there will be no return.

Export

The pallet is the standardized export pallet type.

ISPM15Treated

Specifies that wood pallet must be treated or fumigated according to the ISPM 15 regulation.

NonPalletised

The product is not on a pallet.

NonStop

The pallet is the standardized non-stop pallet type.

OneWay

A pallet that is designed and constructed so as to allow fork entry from only the back or front. One-way pallets are ideally used when you know there will be no return. The one-way pallet is the preferred load carrier particularly for export and is considered expendable.

Twinned

Two pallets have been joined together

PalletWidth

The measurement value of the width of the pallet.

(sequence)

The sequence of items below is mandatory. A single instance is required.

Value

Value is mandatory. A single instance is required.

A numeric value expressed in the unit of measure (UOM).

RangeMin

RangeMin is optional. A single instance might exist.

The minimum value (lower boundary) allowed for the Measurement that is the parent of this element.

RangeMax

RangeMax is optional. A single instance might exist.

The maximum value (upper boundary) allowed for the Measurement that is the parent of this element. Some elements use the RangeMax element with an extended list of unit of measures. (Note: the red colour in the picture is an artifact of how the graphic was captured and should be disregarded.)

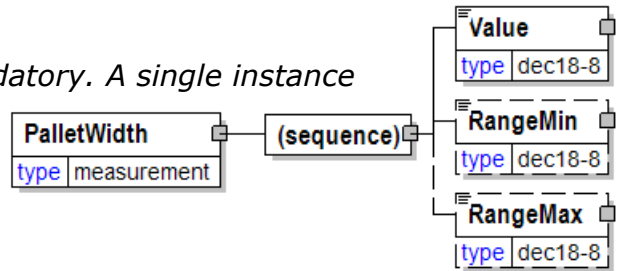

Paper

A group item defining the characteristics of the paper product.

(sequence)

The sequence of items below is mandatory. A single instance is required.

PaperCharacteristics

PaperCharacteristics is optional. A single instance might exist.

The identifying characteristics of paper most important to the ordering of the item. These are the characteristics that, when associated with a given grade, allow the manufacturer to produce but not convert or package, the paper.

(choice)

[choice] is optional. A single instance might exist.

Reel

Reel is mandatory. A single instance is required.

A group item that contains the conversion and packaging characteristics of a reel.

Sheet

Sheet is mandatory. A single instance is required.

A group item that contains the conversion and packaging characteristics for sheets.

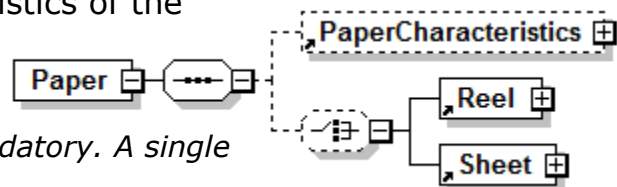

AbsorptionLight

AbsorptionLight is optional. Multiple instances might exist.

A group item used to communicate light absorption target or test value.

AbsorptionWater

AbsorptionWater is optional. Multiple instances might exist.

A group item used to communicate water absorption target or test value.

Appearance

Appearance is optional. Multiple instances might exist.

A group item used to communicate appearance.

Ash

Ash is optional. Multiple instances might exist.

A group item used to communicate the ash content of the product according to a particular TestMethod.

BasisWeight

BasisWeight is optional. Multiple instances might exist.

The weight of the paper expressed as a mass for a given surface area. In countries using the metric system, the basis weight is expressed as the weight in grams of one sheet of paper that is one square meter in area—not dependent on basic sheet size. In countries using the imperial system, the weight is expressed in pounds for a given ProductBasisSizeType.

BendingResistance

BendingResistance is optional. Multiple instances might exist.

Bending resistance

BendingStiffness

BendingStiffness is optional. Multiple instances might exist.

BendingStiffness

Brightness

Brightness is optional. Multiple instances might exist.

A measurement of the degree of light reflectivity of the product.

Bulk

Bulk is optional. Multiple instances might exist.

A group item used to communicate bulking thickness target or test value.

Burst

Burst is optional. Multiple instances might exist.

A group item used to communicate bursting strength target or test value according to a particular TestMethod.

BurstIndex

BurstIndex is optional. Multiple instances might exist.

The burst index.

Caliper

Caliper is optional. Multiple instances might exist.

The thickness of a sheet of paper under standard test conditions.

CoatWeight

CoatWeight is optional. Multiple instances might exist.

A group item used to communicate the coating thickness target or test value according to a particular TestMethod.

ColourDetail

ColourDetail is optional. Multiple instances might exist.

A group item used to communicate details of colour according to the selected colour definition scheme.

Density

Density is optional. Multiple instances might exist.

A group item used to communicate density target or test value according to a particular TestMethod.

Dirt

Dirt is optional. Multiple instances might exist.

A group item used to communicate dirt content target or test value according to a particular TestMethod.

DominantWavelength

DominantWavelength is optional. Multiple instances might exist.

Dominant wavelength

ExcitationPurity

ExcitationPurity is optional. Multiple instances might exist.

Excitation purity

FibreLength

FibreLength is optional. Multiple instances might exist.

A group item used to communicate fibre length target or test value according to a particular TestMethod.

FibreClassification

FibreClassification is optional. Multiple instances might exist.

A group item used to communicate fibre classification according to the specified classification scheme.

Folding

Folding is optional. Multiple instances might exist.

A group item used to communicate folding endurance target or test value according to a particular TestMethod.

Formation

Formation is optional. Multiple instances might exist.

A group item used to communicate sheet formation target or test value according to a particular TestMethod.

Freeness

Freeness is optional. Multiple instances might exist.

Freeness

Friction

Friction is optional. Multiple instances might exist.

A group item used to communicate static and kinetic friction target or test value according to a particular TestMethod.

Gloss

Gloss is optional. Multiple instances might exist.

A group item used to communicate specular gloss target or test value according to a particular TestMethod.

LightScattering

LightScattering is optional. Multiple instances might exist.

A group item used to communicate light scattering coefficients according to a particular TestMethod.

Luminance

Luminance is optional. Multiple instances might exist.

Luminance

Moisture

Moisture is optional. Multiple instances might exist.

Desired percentage, or other indicator, of water in the product at the time of shipment.

Mullen

Mullen is optional. Multiple instances might exist.

Mullen, also called "burst strength", is the amount of pressure required to rupture paper or linerboard when applied to its surface. The unit of measure is KiloPascal (sometimes abbreviated as "kPa").

Opacity

Opacity is optional. Multiple instances might exist.

A group item used to communicate opacity target or test value according to a particular TestMethod.

Permeability

Permeability is optional. Multiple instances might exist.

A group item used to communicate air permeability target or test value according to a particular TestMethod.

pH

pH is optional. Multiple instances might exist.

A group item used to communicate pH (degree of acidity versus basicity) target or test value according to a particular TestMethod.

PlyBond

PlyBond is optional. Multiple instances might exist.

A group item used to communicate internal bond strength target or test value between plies according to a particular TestMethod.

Porosity

Porosity is optional. Multiple instances might exist.

papiNet V2R31

A group item used to communicate a permeability target or test value.

PostConsumerWaste

PostConsumerWaste is optional. Multiple instances might exist.

A group item used to communicate the target or test value percentage of post consumer waste fibre in the product according to a particular TestMethod.

PPI

PPI is optional. Multiple instances might exist.

A group item used to communicate the number of pages in an inch of thickness either as a target or actual value. Equal to the number of sheets per inch times 2.

PreConsumerWaste

PreConsumerWaste is optional. Multiple instances might exist.

A group item used to communicate the target or test value percentage of pre-consumer waste fibre in the product according to a particular TestMethod.

Recycled

Recycled is optional. Multiple instances might exist.

A group item used to communicate the target or test value total percentage of waste fibre in the product according to a particular TestMethod.

Resistance

Resistance is optional. Multiple instances might exist.

A group item used to communicate air resistance target or test value according to a particular TestMethod.

RingCrush

RingCrush is optional. Multiple instances might exist.

Ring Crush

Roughness

Roughness is optional. Multiple instances might exist.

A group item used to communicate surface roughness target or test value according to a particular TestMethod.

RunnabilityIndex

RunnabilityIndex is optional. Multiple instances might exist.

A group item used to communicate the calculated run-ability index target or test value.

ShowThrough

ShowThrough is optional. Multiple instances might exist.

Show through

Sizing

Sizing is optional. Multiple instances might exist.

A group item used to communicate size test of paper by ink resistance target or test value.

Smoothness

Smoothness is optional. Multiple instances might exist.

A group item used to communicate surface smoothness target or test value

according to a particular TestMethod.

Stiffness

Stiffness is optional. Multiple instances might exist.

A group item used to communicate stiffness target or test value.

Stretch

Stretch is optional. Multiple instances might exist.

A group item used to communicate stretch target or test value.

SurfaceStrength

SurfaceStrength is optional. Multiple instances might exist.

Surface Strength

TEA

TEA is optional. Multiple instances might exist.

Tensile Energy Absorption.

Tear

Tear is optional. Multiple instances might exist.

A group item used to communicate tearing resistance target or test value according to a particular TestMethod.

TearIndex

TearIndex is optional. Multiple instances might exist.

TearIndex

Tensile

Tensile is optional. Multiple instances might exist.

A group item used to communicate zero-span tensile strength target or test value according to a particular TestMethod.

TensileIndex

TensileIndex is optional. Multiple instances might exist.

Tensile Index

Whiteness

Whiteness is optional. Multiple instances might exist.

A group item used to communicate degree of whiteness target or test value according to a particular TestMethod.

AdditionalTest

AdditionalTest is optional. A single instance might exist.

AdditionalTest exists to enable the inclusion of a test that has not been identified by papiNet.org. It is always a single-instance element so it is very important that users, who come upon a test that papiNet.org has not identified, communicate the need for this test to us at www.papiNet.org.

NumberOfPlies

NumberOfPlies is optional. Multiple instances might exist.

The number of layers of paper product joined together to make the final saleable product.

PlyAttributes

PlyAttributes is optional. Multiple instances might exist.

The characteristics of the plies of paper or tissue. Manufacturing data relevant to each ply that constitutes the final product

PlySet

PlySet is optional. Multiple instances might exist.

PlySet.

PaperSizeType

A field that defines the sheet size using the DIN standard (DINA4, DINA3, and so on).

PaperSizeType	
type	s20

PartlyMeasuredObjectInfo

A grouping element containing information about an object that is partly measured during several

measuring events. Measuring information reported is per measuring event, when element PartlyMeasuredObjectInfo is used.

N.B. After that measuring is completed, summary measuring information for all measuring events can be reported as a normal measuring event of the object, i.e. PartlyMeasuredObjectInfo is not used.

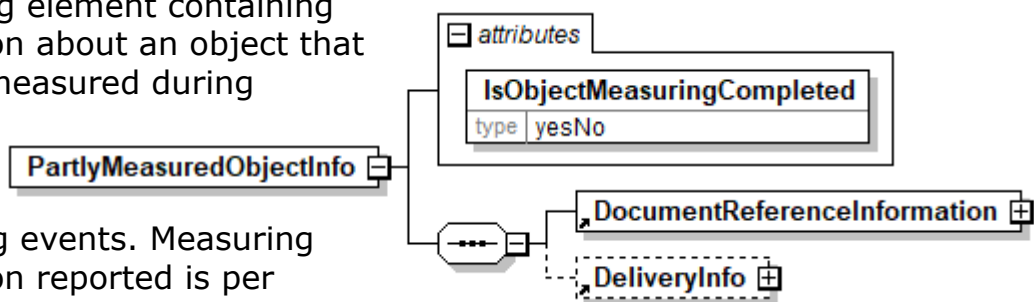

IsObjectMeasuringCompleted [attribute]

IsObjectMeasuringCompleted is mandatory. A single instance is required.

Specifies if measuring is completed or not for the object, when measuring of the object is carried out by having several measuring events.

Refer to IsObjectMeasuringCompleted definition for any enumerations.

(sequence)

The sequence of items below is mandatory. A single instance is required.

DocumentReferenceInformation

DocumentReferenceInformation is mandatory. One instance is required.

A group item containing reference information applicable to a document.

DeliveryInfo

DeliveryInfo is optional. A single instance might exist.

Information about the delivery.

PartyIdentifier

A unique identifier of a specific party. This element contains an attribute PartyIdentifierType that indicates the type of the identifier.

PartyIdentifierType [attribute]

PartyIdentifierType is mandatory. A single instance is required.

Provides a contextual definition for the party identifier value. This party identifier enables the trading partners to use ID codes for the different organisation versus business entities involved in the transaction.

Refer to PartyIdentifierType definition for any enumerations.

Agency [attribute]

Agency is optional. A single instance might exist.

Describes the agency maintaining the list of codes. To be included in this list the agency must be a recognized standards body or industry organisation.

- For the element that owns this attribute.
- For another attribute in the list of attributes associated with the parent element.

Refer to Agency definition for any enumerations.

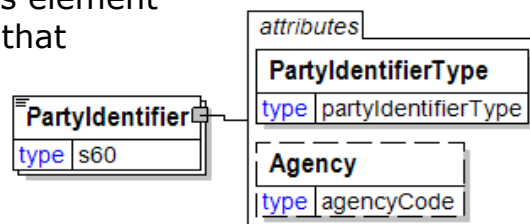

PartyIdentifierType [attribute]

Provides a contextual definition for the party identifier value. This party identifier enables the trading partners to use ID codes for the different organisation versus business entities involved in the transaction.

This item is restricted to the following list.

ABINumber

Associazione Bancaria Italiana – Identifies the bank as an entity in Italy.

ABNNumber

The Australian Business Number (ABN) is a single identifier for dealings with the Australian Taxation Office (ATO). The Australian Business Register assigns it.

AFPA

American Forest and Paper Association identifier.

AssignedByAgency

A unique identifier for the party in question that has been assigned by the agency given in the attribute Agency for the PartyIdentifier. Attribute Agency is mandatory when party identifier type AssignedByAgency is used.

AssignedByBuyer



A unique identifier for the party in question that has been assigned by the buyer (for example, a seller's code).

AssignedByReceiver

A unique identifier for the party in question that has been assigned by the receiver of the e-Document.

AssignedBySeller

A unique identifier for the party in question that has been assigned by the seller (for example, account number for the buyer).

AssignedBySender

A unique identifier for the party in question that has been assigned by the sender of the e-Document.

BankIdentificationCode

A unique country-specific code to identify a bank organisation for electronic transaction. Used to specify the bank routing information needed for electronic remittance. This information is used with the RemitToParty information to effect payment. Examples include:

ACH Number in the United States

Sort Code in the UK

Bankleitzahl in Germany

Code banque/agence in France

BankIdentificationCode should not be mixed up with Bank Identifier Code (BIC). Bank Identifier Code (BIC) is an international standard for identifying Financial Institutions. Please see enumeration SWIFT for more information about BIC.

BankgiroAccountNumber

Defines an account number in the bankgiro system for domestic payments in Sweden. See <http://www.bankgirot.se/> for more information.

CABNumber

Codice Avviamento Bancario – Identifies which branch of the bank in Italy.

ChamberOfCommerceRegistrationNumber

C.C.I.A.A. Number in Italy.

Domicile

Domicile

DunsNumber

A 9-digit identifier maintained by Dun & Bradstreet to uniquely identify a commercial enterprise.

Duns4Number

Similar to the DunsNumber that defines a parent company/organization. The additional 4 digits enable the definition/identification of a sub-entity, such as a mill/plant of this parent company/organisation.

EANNumber

To be deprecated in a future version V3R00. Use GlobalLocationNumber instead.

EORINumber

An Economic Operators Registration and Identification Number. This unique identifier for economic operators within European Community must be communicated to customs authorities within European Community as well as to customers. Mandatory since 26 February 2009 for all communication within customs offices. For more information, please see

https://taxation-customs.ec.europa.eu/customs-4/customs-procedures-import-and-export-0/customs-procedures/economic-operators-registration-and-identification-number-eori_en

GlobalLocationNumber

The globally unique EAN-UCC System identification number for legal entities, functional entities and physical locations. The Global Location Number uses the EAN/UCC-13 Data Structure. Details about the structure and usage are available at the <http://www.gs1.org> website.

IBAN

International Banking Account Number. For payments emanating from and destined for abroad, the European banks (ECBS) have agreed to structure bank accounts in a uniform way.

This uniform structure of the account number is known as IBAN (International Bank Account Number). An IBAN consists of the code of the country where the account is held, 2 numeric check digits and a national account number (your traditional account number).

ISO6523Number

This party identifier type is defined by ISO 6523, Structure for the Identification of Organizations, which defines the standard for a code to be used for party identification in electronic data interchange. The code is globally unique, because of the used structure. The structure of the identifier is, using xxxx99999999(NNNNN) as the example:

xxxx The International Code Designator (ICD-code) is a fixed-length code of four digits that identifies the authority issuing the ISO 6523 organization code; e.g. 0037 is the ICD-code (International Code Designator) for National Board of Taxes in Finland.

99999999 The organization code consists of up to 14 characters. The Code Designator (defined by ICD-code) defines the use of the organization code. The used code can be an existing code or, the code designator assigns the code to companies based on request. The Code Designator makes sure that the codes in their list are unique.

(NNNNN) Optional variable length information, to further identify the organization. The use of this is part defined by the code designator.

LegalSignature

Specifies the legal signature of the party, for example the name of the managing director.

papiNetGlobalPartyIdentifier

papiNet V2R31

A readily available and free identifier supported by IANA (the Internet Assigned Numbers Authority). Private Enterprise Numbers that conforms to proper URI naming conventions are available, free-of-charge from the Internet Assigned Numbers Authority (IANA). The application form is available at the <https://pen.iana.org/pen/PenApplication.page>. Obtaining an IANA Private Enterprise Number (PEN) will permit globally unique trading partner identification.

The format of papiNetGlobalPartyIdentifier is

1.3.6.1.4.1.PrivateEnterpriseNumber[.EnterpriseLocationNumber]

Only characters 0-9 and "." are allowed in the identifier. The PrivateEnterpriseNumber is a positive non-zero integer.

The EnterpriseLocationNumber is optional with values managed by the organisation identified by the Private Enterprise Number. It is a positive non-zero integer, without leading zero(s).

The EnterpriseLocationNumber may be an enumerated list of integers separated by the full-stop character ".". It depicts an organisational sub-tree of integers, where the levels are separated by the full-stop character (.) as a separator.

For example identifier value 1.3.6.1.4.1.14302.10.5 is valid but identifier values 1.3.6.1.4.1.14302.0.5, 1.3.6.1.4.1.14302.ABC, 1.3.6.1.4.1.14302.15-20 and 1.3.6.1.4.1.14302.03 are NOT valid.

The EnterpriseLocationNumber is an optional unique location number within the Enterprise assigned by the Enterprise itself, for example

1.3.6.1.4.1.14302 The Enterprise

1.3.6.1.4.1.14302.4 Location number 4 of the Enterprise, e.g. a paper mill.

1.3.6.1.4.1.14302.12 Location number 12 of the Enterprise, e.g. a pulp mill.

Please refer to sections 3.1.4 and 3.2 in Internet Engineering Task Force RFC 1155 "Structure and Identification of Management Information for TCP/IP based Internets" for further details at <https://tools.ietf.org/html/rfc1155>.

PatenteNumber

A unique four-digit assigned to each Mexican Freight broker.

PayeeAccountNumber

Defines the bank account number of the party receiving payment.

PayeeInternalAccountNumber

The company's internal bank which is used to settle payments between internal units. It's not the bank account.

PayeeFinancialInstitution

The designation of the financial institution of the party receiving the payment.

PayerAccountNumber

Defines the bank account number of the party responsible for making the payment.

PayerFinancialInstitution

The designation of the financial institution of the party responsible for making

the payment.

PlusgiroAccountNumber

Defines an account number in the plusgiro system for domestic payments in Sweden. See www.plusgirot.se for more information.

RegisterOfCompaniesSubscriptionNumber

Iscrizione al Reg. Imprese Nr. In Italy.

StandardAddressNumber

A 7-digit code to uniquely identify an organisation and its location. The number consists of 6 digits with an 11-modulus check digit as the seventh digit. ISAN is the same with the ISO Country code as a prefix. This identifier is solely used by the book industry.

StandardCarrierAlphaCode

A 4-character code identifying a trucking company. The Washington National Motor Freight Association maintains these codes in the United States.

StockCapital

Capitale Sociale in Italy.

SWIFT

SWIFT also refer to as Bank Identifier Code (BIC) is an international standard for identifying Financial Institutions.

The Bank Identifier Code (BIC) developed by SWIFT is adopted by the International Organization for Standardization (ISO). ISO has appointed SWIFT as the registration authority for the assignment of BICs (ISO 9362) and for the publication of BICs in the BIC Directory.

There are two types of BIC, 8 character BIC and 11 character BIC. The 8 character BIC identifies a financial institution in a country or a location. The 11 character BIC identifies the financial institution's branch.

For more information please see

http://www.swift.com/biconline/index.cfm?fuseaction=display_aboutbic

TaxAuthorization

Specifies that the party is authorized for paying tax for employees.

TaxIdentifier

A unique number assigned by the relevant tax authority to identify a party. This constraint is used in relation to tax. Note: This constraint must be specified when the party is tax exempt.

TradeRegNumber

Trade Registration Number

UN/ECE

To be deprecated in a future version V3R00. Use @Agency to indicate this selection.

VATIdentificationNumber

A unique number assigned by the relevant tax authority to identify a party.

This constraint is used in relation to value-added tax (VAT).

Other

Used for any other identification schemes not covered by this list.

PartyType [attribute]

Identifies the business role associated with the particular party

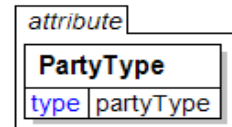

This item is restricted to the following list.

Auditor

A third party that is authorized for making audits and checkings.

Bank

The banking representative.

BillTo

The address where the invoice is to be sent. (Not to be used for logistics BillTo, see LogisticsBillTo.)

BorderCrossing

A geographic location separating two countries authorised to validate customs documentation.

Broker

The organisation acting as a broker for the buyer or supplier.

BusinessChainParty

The organisation or business entity responsible for managing the business chain between business partners when trading of products in many levels of trade.

Buyer

The legal entity to which the product is sold. Also commonly referred to as the sold-to party or customer. If no OtherParty is defined as the "Payer", the "Buyer" is the "Payer". (Not to be used for logistics buyer, see LogisticsBuyer.)

BuyerAgent

The entity acting for the buyer in the transaction. (Not to be used for logistics BuyerAgent, see LogisticsBuyerAgent.)

Carrier

The organisation or business entity that transports goods.

CarrierAssignmentResponsible

The organisation to which the carrier has assigned some task.

ComponentVendor

Vendor producing supplied components.

Compositor

Party that formats written material and illustrations for printing or electronic

display.

Consignee

To be deprecated in a future version V3R00. Use LogisticsRole attribute to communicate this information.

Consignor

To be deprecated in a future version V3R00. Use LogisticsRole attribute to communicate this information.

Consuming

The eventual consumer of the material

ContractParty

The organisation or business entity responsible for managing the contract between business partners.

Converter

The organisation responsible for changing one form of paper into another form, providing specialised functions not available to the supplier.

CreditDepartment

The party responsible for credit authorization.

CrossDock

A third party involved in the transport of goods.

CustomerFacility

The type of the origin or destination location of a transport leg in a route is a buyer facility, usually a print site, or a warehouse owned by the buyer.

CustomerStock

A "virtual" location that indicates that the material is owned by the customer.

Customs

Any customs agency.

CustomsForwarder

A forwarder responsible for managing the transfer of goods through customs.

DeliveryPlanningParty

The organisation responsible for planning of deliveries to delivery destinations.

DomesticForwarder

A forwarder responsible for managing the transfer of goods.

EndUser

EndUser is the party using, consuming, or converting the product. For example, a printer using paper reels to print a job for a publisher (printer is the end user). The final ShipTo destination for a product is normally to the EndUser facilities.

ExportForwarder

A forwarder responsible for managing the export process.

ForestForwarder

The party that transports forest wood products from logging areas to roadside landings.

ForestForwardingRequestor

The party requesting forest forwarding services.

ForestHarvester

The party that harvests forest wood products at logging areas.

ForestHarvestingRequestor

The party requesting forest harvesting services.

Forwarder

The party responsible for shipping arrangements.

FreightPayer

The party responsible for paying freight.

Insurer

The party providing insurance coverage for the goods.

Laboratory

Laboratory is where analysis is done.

Landowner

The party who owns the land upon which the product was produced.

LoadingOperator

A party that is carrying out loading of transport units.

LoggingArea

A geographic location in the forest where logging takes place.

LogisticsBillTo

The address where the logistics invoice is to be sent.

LogisticsBuyer

The buyer of logistics services. The legal entity to which the service is sold. Also commonly referred to as the sold-to party or customer. If no OtherParty is defined as the "LogisticsPayer", the "LogisticsBuyer" is the payer.

LogisticsBuyerAgent

The entity acting for the logistics buyer in the transaction.

LogisticsPayee

The party handling and receiving logistics payments on behalf of another party.

LogisticsPayer

The party handling and sending logistics payments of behalf of another party.

LogisticsPlanningParty

The organisation responsible for planning of logistics services.

LogisticsSeller

The seller of logistics services. LogisticsSupplier is the seller of the service, if logistics seller is not specified as OtherParty = LogisticsSeller.

LogisticsServiceProvider

A party that is responsible for a service in logistics business.

LogisticsServiceProvider (misspelt with an ending space)

The item is misspelt ending with a space. It will be deprecated in a future version V3R00.

Use instead the correctly spelt enumeration LogisticsServiceProvider.

LogisticsSupplier

The party responsible for providing the logistics services. LogisticsSupplier is also the seller of the service, if logistics seller is not specified as OtherParty = LogisticsSeller.

MainCarrier

The primary carrier involved in the movement of goods.

MainForestForwarder

The party responsible for transporting forest wood products from logging areas to roadside landings.

MainForestHarvester

The party responsible for harvesting of forest wood products at logging areas.

Measurer

The party that that is carrying out the measurement of the quantity and/or quality of the products. It can be a person, a piece of equipment or a device.

MeasuringParty

The party that is responsible for the measurements at the measuring location.

Merchant

A third party buying and reselling products.

Mill

A production facility.

NotifyParty

A party that needs to be notified of the status of the transaction.

OnBehalfOf

The activity in question is being made on behalf of this party.

OrderParty

The organisation or business entity placing the order if different from the buyer party.

OriginalBuyer

The first buyer in a supply chain. OriginalBuyer is only used when the first buyer in a supply chain needs to be specified in other e-documents than e-documents belonging to the first level of trade. (Not to be used for the first

buyer in a supply chain of logistics, see OriginalLogisticsBuyer.)

OriginalBuyerAgent

The entity acting for the OriginalBuyer in the transaction. OriginalBuyerAgent is only used when the first buyer agent in a supply chain needs to be specified in other e-documents than e-documents belonging to the first level of trade. (Not to be used for the first buyer agent in a supply chain of logistics, see OriginalLogisticsBuyerAgent.)

OriginalLogisticsBuyer

The first logistics buyer in a supply chain of logistics. OriginalLogisticsBuyer is only used when the first logistics buyer in a supply chain of logistics needs to be specified in other e-documents than e-documents belonging to the first level of logistics trade.

OriginalLogisticsBuyerAgent

The entity acting for the OriginalLogisticsBuyer in the transaction. OriginalLogisticsBuyerAgent is only used when the first logistics buyer agent in a supply chain of logistics needs to be specified in other e-documents than e-documents belonging to the first level of logistics trade.

OriginalLogisticsSeller

The first logistics seller in a supply chain of logistics. OriginalLogisticsSupplier is the OriginalLogisticsSeller of the service, if OriginalLogisticsSeller is not specified as OtherParty = OriginalLogisticsSeller. OriginalLogisticsSeller is only used when the first logistics seller in a supply chain of logistics needs to be specified in other e-documents than e-documents belonging to the first level of logistics trade.

OriginalLogisticsSupplier

The first logistics supplier in a supply chain of logistics. OriginalLogisticsSupplier is also the OriginalLogisticsSeller of the service, if OriginalLogisticsSeller is not specified as OtherParty = OriginalLogisticsSeller. OriginalLogisticsSupplier is only used when the first logistics supplier in a supply chain of logistics needs to be specified in other e-documents than e-documents belonging to the first level of logistics trade.

OriginalOrderParty

Party which ordered the product from the Party sending the first level PurchaseOrder in an indirect purchase order process.

OriginalSeller

The first seller in a supply chain. OriginalSupplier is the OriginalSeller of the product, if OriginalSeller is not specified as OtherParty = OriginalSeller. OriginalSeller is only used when the first seller in a supply chain needs to be specified in other e-documents than e-documents belonging to the first level of trade. (Not to be used for the first seller in a supply chain of logistics, see OriginalLogisticsSeller.)

OriginalSupplier

The first supplier in a supply chain. OriginalSupplier is also the OriginalSeller of the product, if OriginalSeller is not specified as OtherParty = OriginalSeller. OriginalSupplier is only intended to identify the business party, not the origin of the product. OriginalSupplier is only used when the first supplier in a supply

chain needs to be specified in other e-documents than e-documents belonging to the first level of trade. (Not to be used for the first supplier in a supply chain of logistics, see OriginalLogisticsSupplier.)

Payee

The party handling and receiving payments on behalf of another party. (Not to be used for logistics payee, see LogisticsPayee.)

Payer

The party handling and sending payments of behalf of another party. (Not to be used for logistics payer, see LogisticsPayer.)

PlaceFinalDestination

The final destination of the goods.

PlaceOfAccept

The location where acceptance of the goods is to take place.

PlaceOfDespatch

The location where despatch took place.

PlaceOfDischarge

The location where the goods were unloaded.

PlaceOfLoading

The location where loading is to or took place.

PlaceOfMeasuring

The location where the products are measured.

PlaceOfPassingThrough

A location to be passed by a vehicle, e.g. a main intersection on a Route.

PlaceOfReloading

A location where the goods were or will be transferred from one transport to another. It may but does not need to involve a change of transport mode.

Port

The type of the origin or destination location of a transport leg in a route. It is a maritime location.

PreCarrier

The party responsible for activities prior to carrier accepting the goods (but after shipping has taken place).

PriceListParty

The organization or business entity responsible managing for the price list between business partners.

PrinterFacility

The location of the printer who will be using the product.

Producer

The manufacturer of the goods.

papiNet V2R31

ProductAgency

Organization responsible for defining unique product identifiers.

ProFormaInvoice

The organisation or business entity to which the pro-forma invoice will be sent.

Publisher

Individual or corporation responsible for the printing and distribution of digital or printed publications.

RemitTo

The organisation or business entity to which payment will be made.

Requestor

The originator of the original PurchaseOrder requisition (for example, a printing plant ordering through a central purchasing organisation).

RoadKeeper

The party who is responsible for the maintenance of the road.

RoadOwner

The party who is the legal owner of the road.

SalesAgent

The organisation or person responsible for product sales acting on behalf of the seller.

SalesOffice

The functional unit in an organisation or business entity that is responsible for product sales.

Seller

The seller of the product. SupplierParty is the seller of the product, if Seller is not specified as OtherParty = Seller. (Not to be used for logistics seller, see LogisticsSeller.)

ServiceProvider

The party that is responsible for a service in product business.

ShipFromLocation

The location the goods were shipped from.

ShipOwner

The owner of the vessel used to ship the goods.

ShipTo

The address the material should be shipped to.

SubCarrier

A sub carrier of another the shipping company.

Supplier

The organisation or business entity responsible for providing the product. SupplierParty is also the seller of the product, if Seller is not specified as

papiNet V2R31

OtherParty = Seller. (Not to be used for logistics supplier, see LogisticsSupplier.)

SupplyRequirementPlanningParty

The organisation responsible for planning of supply requirements for industries depending on their needs.

Terminal

The type of the origin or destination location of a transport leg in a route. It can be a sea, road or rail terminal.

TerminalOperator

The party providing facilities such as loading, unloading, or warehousing.

UnloadingOperator

A party that is carrying out unloading of transport units.

Warehouse

A storage location. It can be the origin or destination location of a transport leg in a route.

WarehouseOperator

The party operating a warehouse.

WillAdvise

Indicates that party will be identified at a later time

Other

Any other organisation or business entity that may get involved in the transaction and that is not covered by the list.

PasteDiameter

The diameter measurement of a reel when a new reel of paper is glued or pasted to it to continue running.

(sequence)

The sequence of items below is mandatory. A single instance is required.

Value

Value is mandatory. A single instance is required.

A numeric value expressed in the unit of measure (UOM).

RangeMin

RangeMin is optional. A single instance might exist.

The minimum value (lower boundary) allowed for the Measurement that is the parent of this element.

RangeMax

RangeMax is optional. A single instance might exist.

The maximum value (upper boundary) allowed for the Measurement that is the

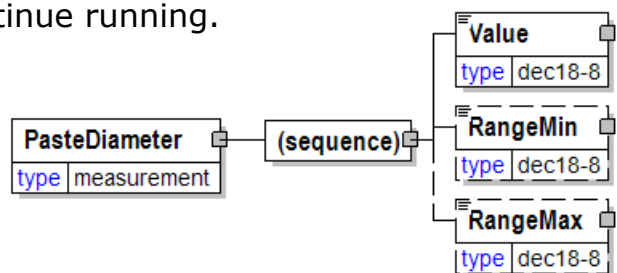

parent of this element. Some elements use the RangeMax element with an extended list of unit of measures. (Note: the red colour in the picture is an artifact of how the graphic was captured and should be disregarded.)

PatternProfile

Defines the pattern used in machining the product.

PatternProfileType [attribute]

PatternProfileType is optional. A single instance might exist.

Defines the name of any pattern or profile applied to the product.

Refer to PatternProfileType definition for any enumerations.

PatternProfileAgency [attribute]

PatternProfileAgency is optional. A single instance might exist.

LumberAgency identifies which agency is responsible for assigning the lumber attributes.

Refer to PatternProfileAgency definition for any enumerations.

(sequence)

The sequence of items below is mandatory. A single instance is required.

PatternProfileCode

PatternProfileCode is optional. A single instance might exist.

Defines the code which is used to describe the pattern profile.

AdditionalText

AdditionalText is optional. A single instance might exist.

A text field that is used to communicate information not previously defined or for special instructions. To be used only for circumstances not covered by specific elements.

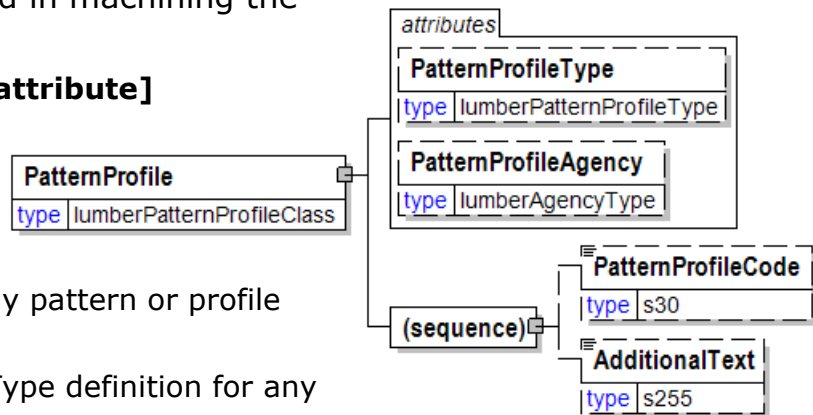

PatternProfileAgency [attribute]

LumberAgency identifies which agency is responsible for assigning the lumber attributes.

This item is restricted to the following list.

BS

BS-EN

British standard based on a European standard.

CEN

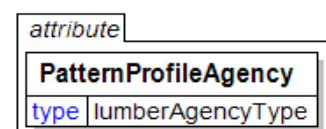

papiNet V2R31

European Committee for Standardisation (<http://www.cenorm.be>)

DIN

EN338

EN1912

EN1611-1

EDISAW

Generic

GOST

Russian federal agency on technical regulating and metrology
(<http://www.gost.ru>)

ISO

JAS

Japanese Agricultural Standard

NELMA

NLGA

NS

NSLB

RIS

RT

SIS

SPIB

WCLIB

WRCLA

WWPA

Supplier

PatternProfileCode

Defines the code which is used to describe the pattern profile.

PatternProfileCode
type s30

PatternProfileType [attribute]

Defines the name of any pattern or profile applied to the product.

This item is restricted to the following list.

Beveled Siding

Wedge shaped boards, installed so that each board is lapped over the edge of the board below.

attribute
PatternProfileType
type LumberPatternProfileType

Bungalow Siding

Channel Rustic Siding

Siding that includes a decorative molding with a concave groove

Colonial Siding

Dolly Varden Siding

Bevel siding, which is a wedge shaped board, installed so that each board is lapped over the edge of the board below, that has the addition of an L-shaped cutout at the edge or side of the wedge, overlapping the top of the board below.

Log Cabin Siding

Siding based on an Early American frontier style of housing, constructed of logs

Boston Pattern

Type of roofing where shingles butt tightly against each other at the hip with alternating shingle courses lapping over the edges of the opposing shingles.

CaulkingSeam

CB1S

Center bead on one side

CB2S

Center bead on two sides

CG2E

Center groove on two edges

CM

Center matched

CM 1/4 T and G

Center matched , 1/4 inch tongued and grooved

CM 3/8 T and G

Center matched, 3/8 inch tongued and grooved Center matched and edge V one side

CM and EV 1S

Center matched and edge V one side

CM and EV 2S

Center matched and edge V two sided

CV1S

Center V on one side

CV2S

Center V on two sides

D and CM

Dressed and center matched

papiNet V2R31

DbI Plowed

E and CB1S

E and CB2S

Edge and center bead one side

E and CV2S

Edge and center bead two sides

EB1S

Edge bead one side

EB2S

Edge bead on two sides

EV1S

Edge V one side

EV2S

Edge V on two sides

Grooved for Splines

Plowed

S2S and CM 1/4 T and G

Surfaced two sides, center matched , 1/4 inch tongued and grooved

S2S and CM 3/8 T and G

Surfaced two sides, center matched , 3/8 inch tongued and grooved

ShipLap

Boards with rabbeted edges overlapping.

ShipLap - 1/2 lap

Boards with 1/2 inch rabbeted edges overlapping.

ShipLap - 3/8 lap

Boards with 3/8 inch rabbeted edges overlapping.

ShipLap and EV1S

Boards with rabbeted edges overlapping and edge V on one side.

T and G

Tongued and grooved

V Rustic

V-CV Rustic

Channel Decking

S2S CM and EV1S Decking

Comnation Ceiling

DbIBeaded Ceiling

Double Beaded Ceiling

E and CB Ceiling
E and CV Ceiling
EB Ceiling
EV Ceiling
V Ceiling
Beaded Partition
DbIBeaded Partition
E and CB Partition
E and CV Partition
V Partition
Flooring
Flooring D and M
Flooring S2S and CM
Special D and M Flooring
EasedEdge
Rabbeted
RadiusEdge
Beaded Shelving 2 Bead
Beaded Shelving 3 Bead
Casket Stock S3S G1E
Casket Stock S3S T1E
Corn Cribbing
Grooved Roofing
Gutter-Boston
Gutter-Ohio
Jamb
Ogee Batten
Patent Lath
Pulley Stile
Still
1
2
3
4
5
6
7

papiNet V2R31

- 8**
- 9**
- 10**
- 11**
- 12**
- 13**
- 14**
- 16**
- 18**
- 20**
- 50**
- 52**
- 54**
- 56**
- 58**
- 60**
- 62**
- 64**
- 66**
- 68**
- 71**
- 101**
- 102**
- 103**
- 104**
- 105**
- 106**
- 109**
- 110**
- 115**
- 116**
- 117**
- 118**
- 119**
- 121**
- 122**
- 123**

- 124**
- 125**
- 130**
- 131**
- 132**
- 133**
- 134**
- 136**
- 137**
- 138**
- 139**
- 140**
- 141**
- 142**
- 143**
- 144**
- 145**
- 153**
- 161**
- 165**
- 166**
- 168**
- 170**
- 171**
- 172**
- 173**
- 173 Spline**
- 174**
- 200**
- 202**
- 204**
- 206**
- 220A**
- 222A**
- 224A**
- 300**
- 302**

- 304
- 305-a
- 305-b
- 305-c
- 305-d
- 305-e
- 405-a
- 405-b
- 405-c
- 405-d
- 405-e
- Other

PerCarton

A field indicating the number of sheets per carton.

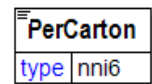

Perforated [attribute]

Either "Yes" or "No".

This item is restricted to the following list.

- Yes**
- No**

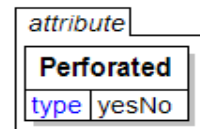

Perforation

Perforation information

PerforationType [attribute]

PerforationType is optional. A single instance might exist.

Perforation type

Refer to PerforationType definition for any enumerations.

(sequence)

The sequence of items below is mandatory. A single instance is required.

DistanceFromEdge

DistanceFromEdge is optional. A single instance might exist.

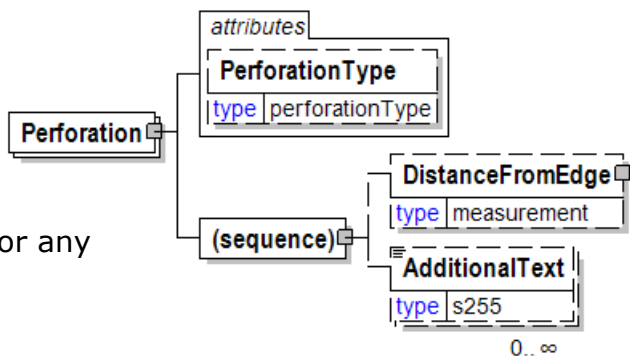

papiNet V2R31

The distance from the edge of the paper. This element is used to communicate where the hole is.

AdditionalText

AdditionalText is optional. Multiple instances might exist.

A text field that is used to communicate information not previously defined or for special instructions. To be used only for circumstances not covered by specific elements.

PerforationType [attribute]

Perforation type

This item is restricted to the following list.

None

Operation is not required.

Pattern

Perforation follows a specific diagram.

Workbook

Perforation is a straight line that runs from the head to the foot of the page at a specified distance from the spine.

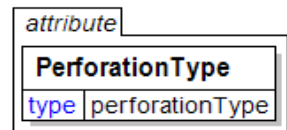

PeriodType [attribute]

Duration of time

This item is restricted to the following list.

Day

The time period is 24 hours specified as a date.

FinancialPeriodBeginning

Will be deprecated in a future version V3R00.

Hour

The time period is one hour specified as a Date and Time.

MonthBeginning

Will be deprecated in a future version V3R00.

Period

The time period is specified as a date time range with a From Date Time and a To Date Time.

QuarterBeginning

Will be deprecated in a future version V3R00.

WeekBeginning

Will be deprecated in a future version V3R00.

WeekNumber

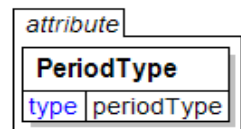

The time period is one week specified as a week number.

ISO 8601 is used as the basis for week numbers, "Week 01 of a year is the first week that has the Thursday in this year, which is equivalent to the week that contains the fourth day of January."

YearBeginning

Will be deprecated in a future version V3R00.

Permeability

A group item used to communicate air permeability target or test value according to a particular TestMethod.

TestMethod [attribute]

TestMethod is optional. A single instance might exist.

The method used to determine the results of the test under consideration.

TestAgency [attribute]

TestAgency is optional. A single instance might exist.

The agency that has set the parameters for the testing

Refer to TestAgency definition for any enumerations.

SampleType [attribute]

SampleType is optional. A single instance might exist.

Communicates how sampling was done to measure the product characteristics.

Refer to SampleType definition for any enumerations.

ResultSource [attribute]

ResultSource is optional. A single instance might exist.

Used to define the data source of the specified test

Refer to ResultSource definition for any enumerations.

(sequence)

The sequence of items below is mandatory. A single instance is required.

DetailValue

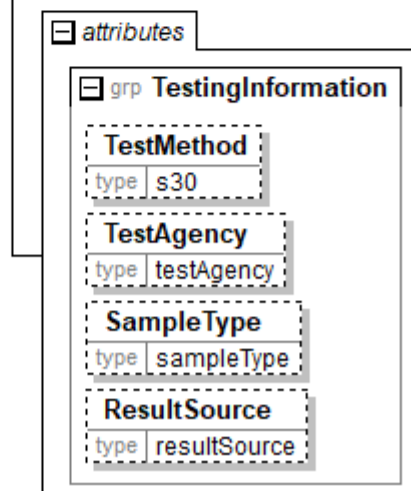
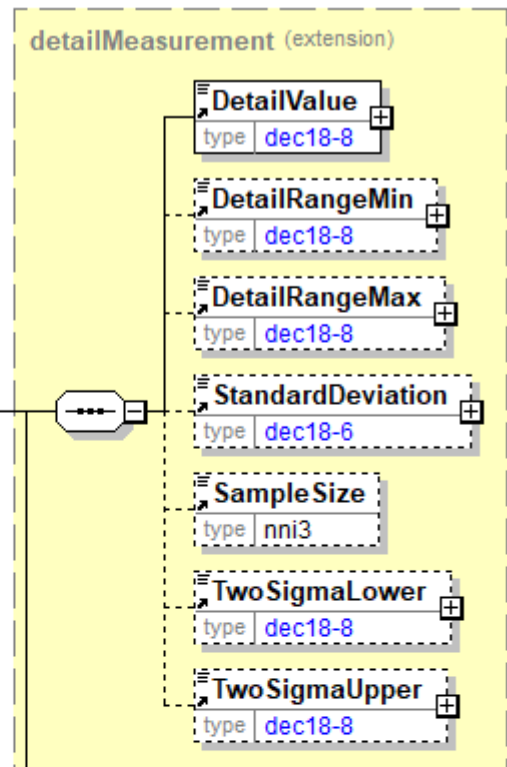
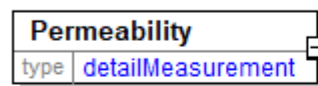

papiNet V2R31

DetailValue is mandatory. A single instance is required.

A numeric value expressed in the unit of measure (UOM).

DetailRangeMin

DetailRangeMin is optional. A single instance might exist.

The minimum value (lower boundary) allowed for the DetailValue that is the parent of this element.

DetailRangeMax

DetailRangeMax is optional. A single instance might exist.

The maximum value (upper boundary) allowed for the DetailValue that is the parent of this element.

StandardDeviation

StandardDeviation is optional. A single instance might exist.

A statistic used as a measure of dispersion in a distribution.

SampleSize

SampleSize is optional. A single instance might exist.

The number of samples used to determine the product characteristic in question.

TwoSigmaLower

TwoSigmaLower is optional. A single instance might exist.

Two sigma (a measure of dispersion associated with standard deviation) on the lower side of the standard deviation.

TwoSigmaUpper

TwoSigmaUpper is optional. A single instance might exist.

Two sigma (a measure of dispersion associated with standard deviation) on the upper side of the standard deviation.

PerPallet

A field indicating the number of sheets on the pallet.

PerPallet	
type	nni6

PerReam

A field indicating the number of sheets per ream.

PerReam	
type	nni4

PerTab

A field indicating the number of sheets per tab marking.

PerTab	
type	nni4

pH

A group item used to communicate pH (degree of acidity versus basicity) target or test value according to a particular TestMethod.

TestMethod [attribute]

TestMethod is optional. A single instance might exist.

The method used to determine the results of the test under consideration.



TestAgency [attribute]

TestAgency is optional. A single instance might exist.

The agency that has set the parameters for the testing

Refer to TestAgency definition for any enumerations.

SampleType [attribute]

SampleType is optional. A single instance might exist.

Communicates how sampling was done to measure the product characteristics.

Refer to SampleType definition for any enumerations.

ResultSource [attribute]

ResultSource is optional. A single instance might exist.

Used to define the data source of the specified test

Refer to ResultSource definition for any enumerations.

(sequence)

The sequence of items below is mandatory. A single instance is required.

DetailValue

DetailValue is mandatory. A single instance is required.

A numeric value expressed in the unit of measure (UOM).

DetailRangeMin

DetailRangeMin is optional. A single instance might exist.

The minimum value (lower boundary) allowed for the DetailValue that is the parent of this element.

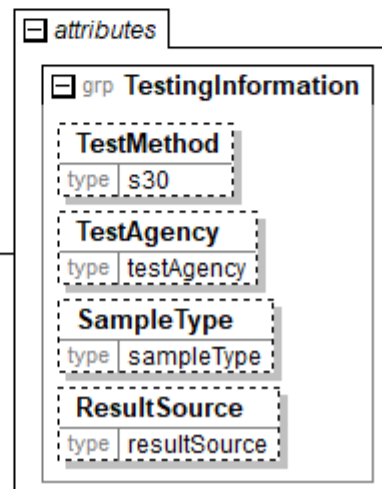
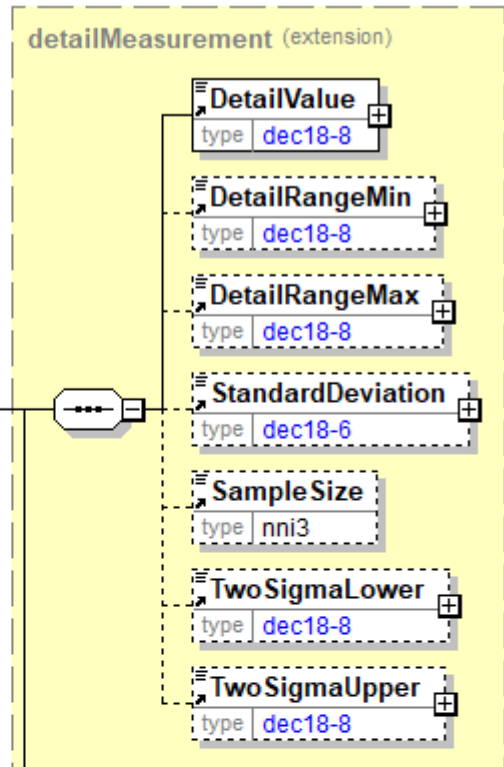

DetailRangeMax

DetailRangeMax is optional. A single instance might exist.

The maximum value (upper boundary) allowed for the DetailValue that is the parent of this element.

StandardDeviation

StandardDeviation is optional. A single instance might exist.

A statistic used as a measure of dispersion in a distribution.

SampleSize

SampleSize is optional. A single instance might exist.

The number of samples used to determine the product characteristic in question.

TwoSigmaLower

TwoSigmaLower is optional. A single instance might exist.

Two sigma (a measure of dispersion associated with standard deviation) on the lower side of the standard deviation.

TwoSigmaUpper

TwoSigmaUpper is optional. A single instance might exist.

Two sigma (a measure of dispersion associated with standard deviation) on the upper side of the standard deviation.

PiecesPerRow

This element details the number of pieces or individual items that are to be placed/packaged in a row within the unit. Usually used to identify the standard number of pieces in a standard packaging unit of the product.

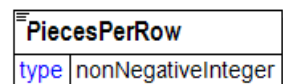

PlacementInOrderOfMatter

Element used to identify where the component is to be placed amongst other components when assembling a book.

PlacementReference [attribute]

PlacementReference is mandatory. A single instance is required.

Placement reference

Refer to PlacementReference definition for any enumerations.

RelativeLocation [attribute]

RelativeLocation is optional. A single instance might exist.

The relative position in the end-item where the component is to be placed.

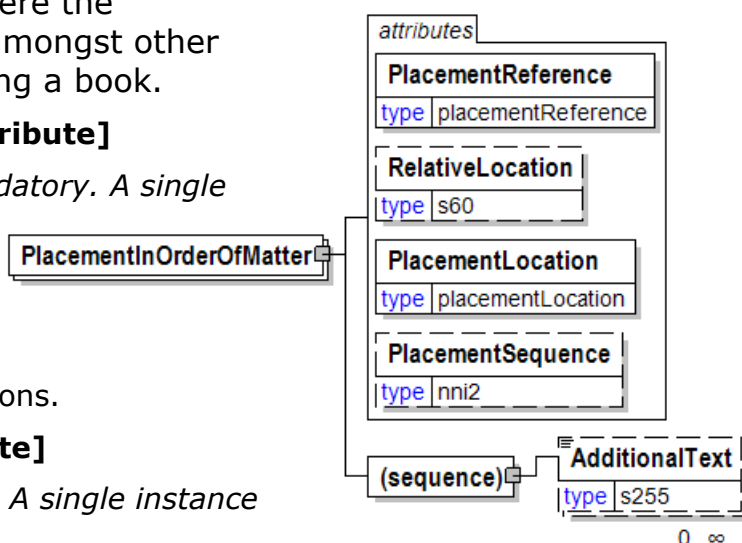

PlacementLocation [attribute]

PlacementLocation is mandatory. A single instance is required.

Placement location.

Refer to PlacementLocation definition for any enumerations.

PlacementSequence [attribute]

PlacementSequence is optional. A single instance might exist.

The placement sequence. Any non negative integer between 1 and 99.

(sequence)

The sequence of items below is mandatory. A single instance is required.

AdditionalText

AdditionalText is optional. Multiple instances might exist.

A text field that is used to communicate information not previously defined or for special instructions. To be used only for circumstances not covered by specific elements.

PlacementLocation [attribute]

Placement location.

This item is restricted to the following list.

Inside

Outside

Before

After



PlacementReference [attribute]

Placement reference

This item is restricted to the following list.

BackCover

BacktEndsheet

Chapter

FrontCover

FrontEndsheet

Item

Page

Signature

Spine

Narrow strip where the cover of a book is joined to the pages.

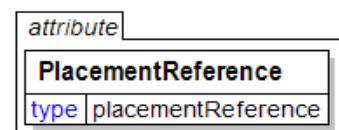

PlacementSequence [attribute]

The placement sequence. Any non negative integer between 1 and 99.

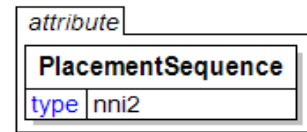

Planning

The Planning element is the root element for the Planning e-Document.

The Planning e-Document provides a tool for trading partners to exchange forecasted or planned information for a specific product or event within a specified timeframe. The e-Document is designed to support a variety of business processes, which may include securing needed supplies or simply the exchange of information.

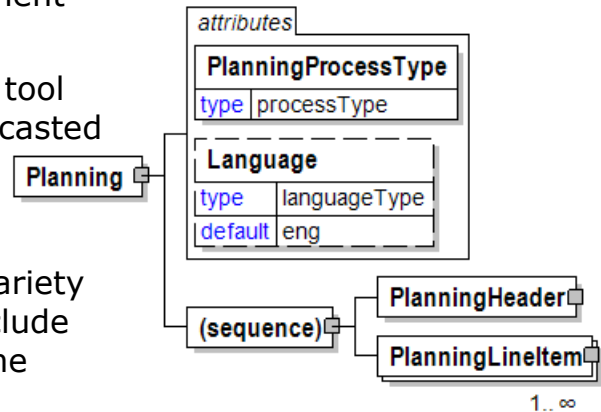

PlanningProcessType [attribute]

PlanningProcessType is mandatory. A single instance is required.

The type of process that the Planning e-Document communicates.

Refer to PlanningProcessType definition for any enumerations.

Language [attribute]

Language is optional. A single instance might exist.

The valid Alpha 2- and Alpha 3-character list of language codes in the ISO 639-1 and 639-2 international standards.

Information on the content of this attribute is available at:
https://www.loc.gov/standards/iso639-2/php/code_list.php

(sequence)

The sequence of items below is mandatory. A single instance is required.

PlanningHeader

PlanningHeader is mandatory. A single instance is required.

Information that applies to all the items on the Planning e-Document.

PlanningLineItem

PlanningLineItem is mandatory. One instance is required, multiple instances might exist.

The PlanningLineItem must reference either a Product or Downtime. The PlanningLineItem presents information for a particular product or downtime event.

PlanningBucket

PlanningBucket groups together the elements required to communicate the time and quantity related information for the parent item (either Product or Downtime).

BucketType [attribute]

BucketType is mandatory. A single instance is required.

The type of planning information being communicated in the bucket.

Refer to BucketType definition for any enumerations.

(sequence)

The sequence of items below is mandatory. A single instance is required.

TimePeriod

TimePeriod is mandatory. A single instance is required.

The TimePeriod element is used to communicate a duration period of time as indicated in PeriodType.

OtherDate

OtherDate is optional. A single instance might exist.

A date that may not be specifically detailed within a document (example: print date at the PurchaseOrderLineItem).

Quantity

Quantity is mandatory. A single instance is required.

The Quantity element contains attributes that provide information about the type of quantity that is being communicated, the context in which the particular quantity is to be viewed, and (if the quantity represents an adjustment) an adjustment type.

The Quantity element contains three child elements that enable you to communicate a range of values for the quantity and a target or actual value. It is at this level (Value, RangeMin, and RangeMax) that the unit of measure is specified. This permits the range to be specified in a different unit of measure than the target.

InformationalQuantity

InformationalQuantity is optional. Multiple instances might exist.

A quantity given in a valid UOM used for information purposes only (not for calculation). For example, an ordered quantity was 100 reels as opposed to the invoice quantity of 20,000 pounds.

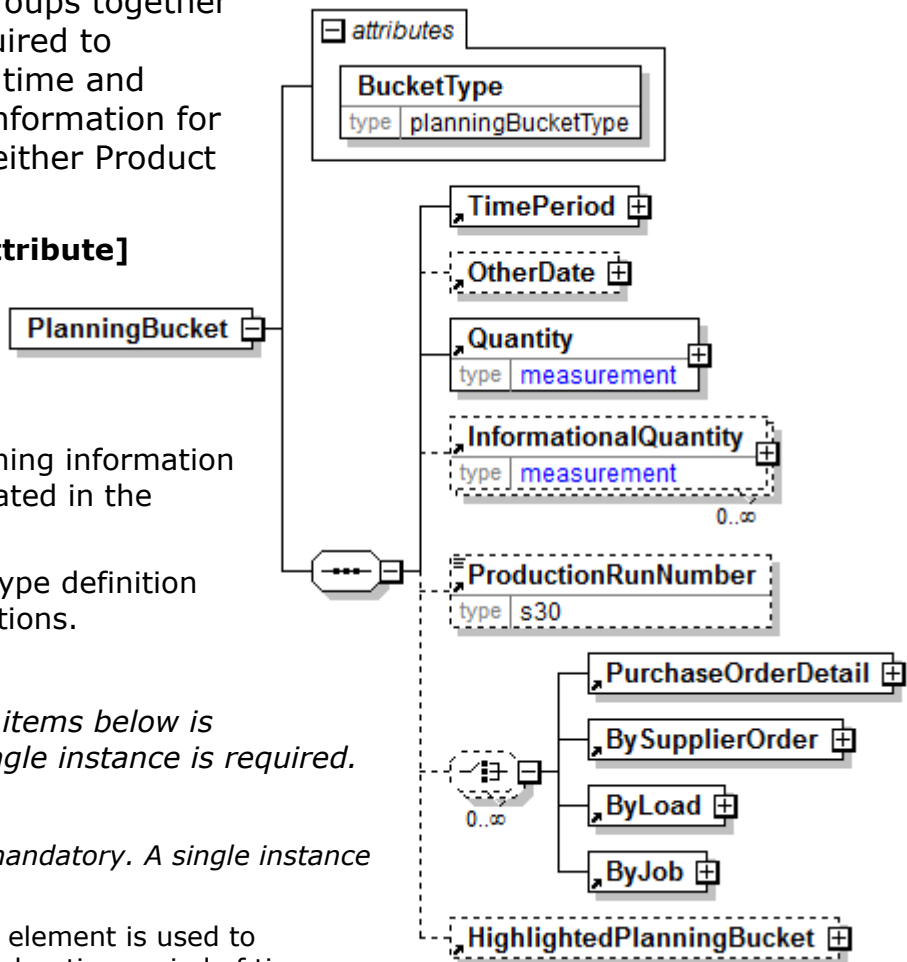

ProductionRunNumber

ProductionRunNumber is optional. A single instance might exist.

The ProductionRunNumber assigned by the issuer.

(choice)

[choice] is optional. Multiple instances might exist.

PurchaseOrderDetail

PurchaseOrderDetail is mandatory. A single instance is required.

Multiple PurchaseOrderDetail instances are allowed.

BySupplierOrder

BySupplierOrder is mandatory. A single instance is required.

Selection criteria for communicating Supplier Order information.

ByLoad

ByLoad is mandatory. A single instance is required.

By Load

ByJob

ByJob is mandatory. A single instance is required.

Information about the job being communicated.

HighlightedPlanningBucket

HighlightedPlanningBucket is optional. A single instance might exist.

Provides an indication and information that the planning bucket should be reviewed.

PlanningBucketStatusType [attribute]

Used to identify the Planning bucket's status. Typically used to highlight a change in status to the receiver of the e-Document.

This item is restricted to the following list.

Amended

The supplied information is changed.

Cancelled

The supplied information has been cancelled. Items that have been cancelled are not included in totals on the summary levels of the e-Document.

New

The information is new and supplied for the first time.

NoAction

The supplied information has not been amended and thereby requires no action.



PlanningDuration

Duration of the planning period.

DurationType [attribute]

DurationType is mandatory. A single instance is required.

Type of duration of the planning period.

Refer to DurationType definition for any enumerations.

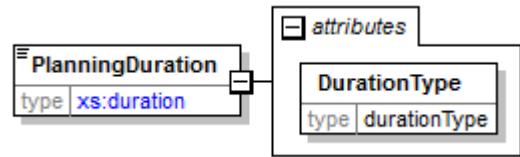

PlanningHeader

Information that applies to all the items on the Planning e-Document.

(sequence)

The sequence of items below is mandatory. A single instance is required.

PlanningMessageNumber

PlanningMessageNumber is mandatory. A single instance is required.

A unique identifier assigned to the Planning e-Document assigned by the issuer that makes this Planning unique. Subsequent Planning e-Documents with updates will use this same PlanningMessageNumber.

PlanningIssueDate

PlanningIssueDate is mandatory. A single instance is required.

The date and time this version of the Planning data was issued.

PlanningIdentifier

PlanningIdentifier is optional. A single instance might exist.

An identifier that communicates the scope or content of the planning. This field is used to communicate which sub-set of planning information is being maintained.

RequestNumber

RequestNumber is optional. A single instance might exist.

A unique tracking number specifically identifying the InfoRequest e-Document to the originator. The tracking number is returned with the "information", the answer, to help match the answer to the request.

SenderParty

SenderParty is optional. A single instance might exist.

The business entity issuing the e-Document, the source of the document.

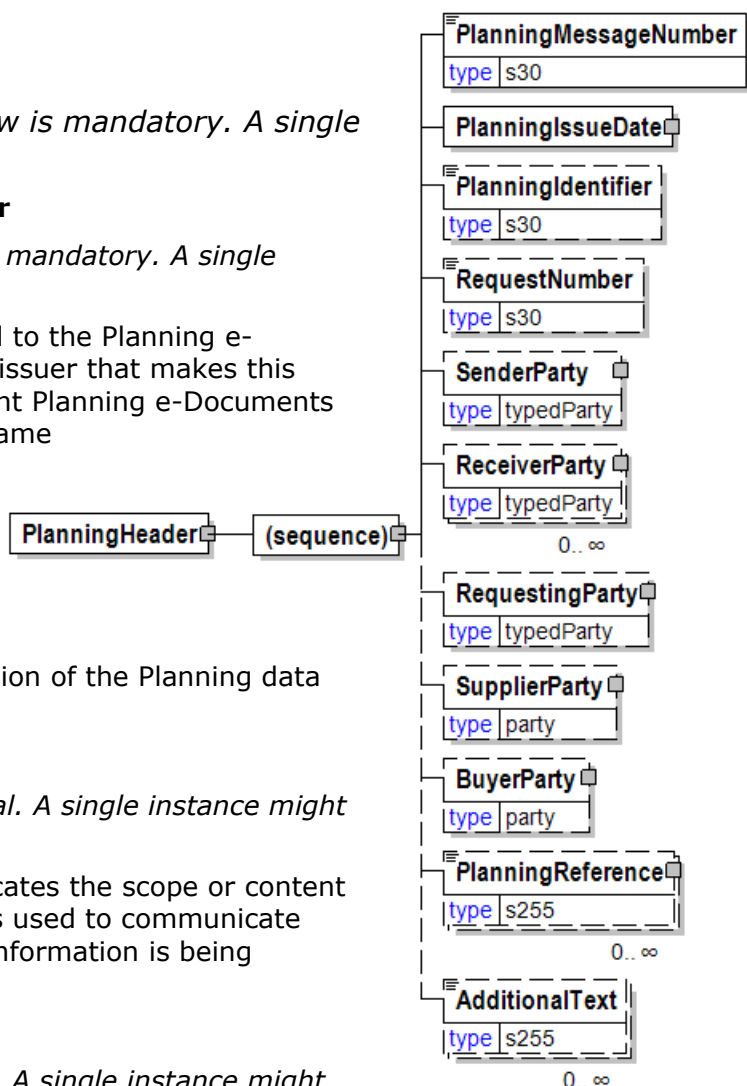

papiNet V2R31

The entity responsible for the content. If the sender party has out sourced the message service to a third party the SenderParty is the issuer of the e-Document and not the party performing the transmission service of the electronic message.

ReceiverParty

ReceiverParty is optional. Multiple instances might exist.

The business entity for whom the e-Document is intended, the destination of the document.

The entity interested in the content. If the receiver party has outsourced the message service to a third party the ReceiverParty is the intended party for the e-Document and not the party performing the receiving service of the electronic message.

RequestingParty

RequestingParty is optional. A single instance might exist.

The party requesting the information.

SupplierParty

SupplierParty is optional. A single instance might exist.

The organisation or business entity responsible for providing the product. SupplierParty is also the seller of the product, if Seller is not specified as OtherParty = Seller.

BuyerParty

BuyerParty is optional. A single instance might exist.

The legal entity to which the product is sold. Also commonly referred to as the sold-to party or customer. If no OtherParty is defined as the Payer, the Buyer is the Payer.

PlanningReference

PlanningReference is optional. Multiple instances might exist.

An element detailing relevant references pertaining to the Planning and DeliveryPlanning e-Documents.

AdditionalText

AdditionalText is optional. Multiple instances might exist.

A text field that is used to communicate information not previously defined or for special instructions. To be used only for circumstances not covered by specific elements.

PlanningIdentifier

An identifier that communicates the scope or content of the planning. This field is used to communicate which sub-set of planning information is being maintained.

PlanningIdentifier
type s30

PlanningInformation

A grouping element that provides information about the planning period and details of the plan.

(sequence)

The sequence of items below is mandatory. A single instance is required.

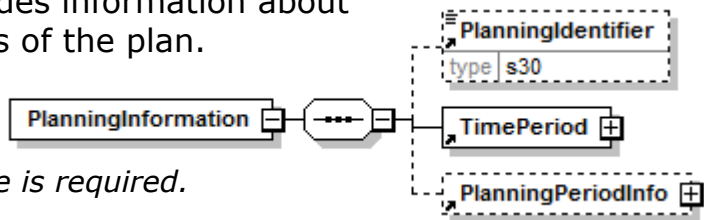

PlanningIdentifier

PlanningIdentifier is optional. A single instance might exist.

An identifier that communicates the scope or content of the planning. This field is used to communicate which sub-set of planning information is being maintained.

TimePeriod

TimePeriod is mandatory. A single instance is required.

The TimePeriod element is used to communicate a duration period of time as indicated in PeriodType.

PlanningPeriodInfo

PlanningPeriodInfo is optional. A single instance might exist.

A grouping element detailing the information about the planning period.

PlanningIssueDate

The date and time this version of the Planning data was issued.

(sequence)

The sequence of items below is mandatory. A single instance is required.

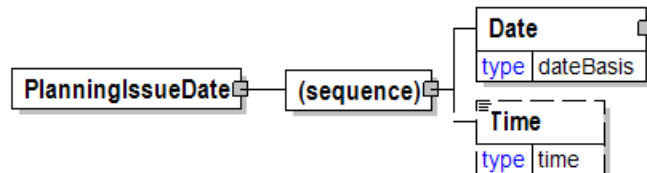

Date

Date is mandatory. A single instance is required.

A group element that contains the specification of Year, Month, and Day.

Time

Time is optional. A single instance might exist.

Times are treated in a standard XML fashion with a special case used to indicate a generalized "local" time. The standard XML approach to time is hh:mm:ss, hh:mm:ssZ, or hh:mm:ss±hh:mm.

hh:mm:ss±hh:mm is used to represent a time with a time zone. The time zone is communicated as the number of hours offset from the Universal Time Coordinate (UTC), a.k.a. Greenwich Mean Time.

hh:mm:ssZ indicates the time at Zulu (another name for UTC).

hh:mm:ss or hh:mm indicates within papiNet the applicable local time where the associated event is taking place. Caution should be used when processing times of this nature as the papiNet approach may be in discord with other users of XML.

PlanningLineItem

The PlanningLineItem must reference either a Product or Downtime. The PlanningLineItem presents information for a particular product or downtime event.

PrintType [attribute]

Defines the printing method.

PrintType is optional. A single instance might exist.

Refer to PrintType definition for any enumerations.

(sequence)

The sequence of items below is mandatory. A single instance is required.

PlanningLineNumber

PlanningLineNumber is mandatory. A single instance is required.

A sequential number that uniquely identifies the PlanningLineItem.

LocationParty

LocationParty is mandatory. A single instance is required.

The organization or business entity where the business event took place or will take place.

MachineID

MachineID is optional. A single instance might exist.

An identifier assigned to the particular machine being referenced. For example, a machine could be a paper machine, an off-line coater, a sheeter, or a printing press. The particular machine being referenced will be determined by the business event being supported.

OtherParty

OtherParty is optional. Multiple instances might exist.

An organisation or business entity other than those specifically detailed within an e-Document.

PlanningReference

PlanningReference is optional. Multiple instances might exist.

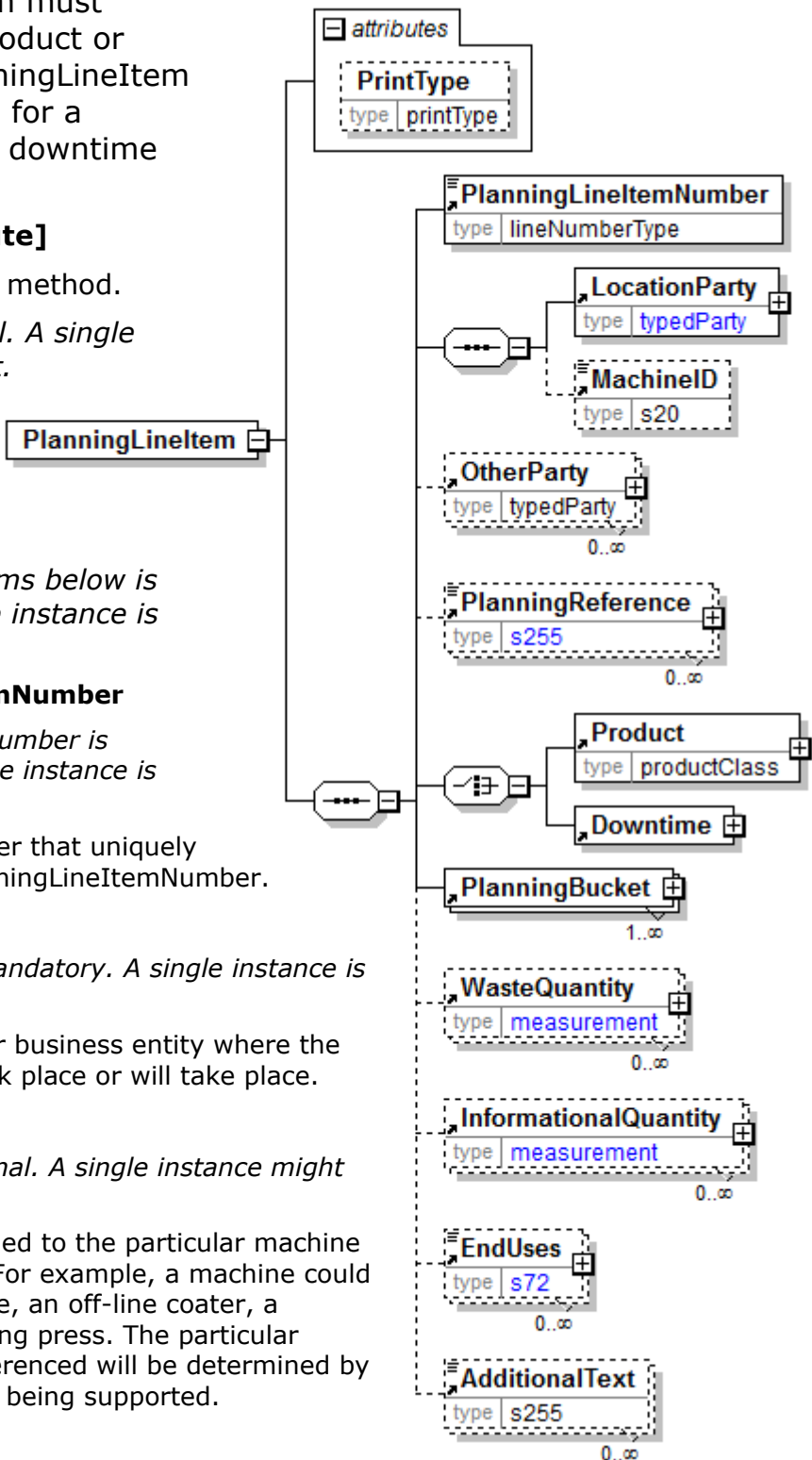

An element detailing relevant references pertaining to the Planning and DeliveryPlanning e-Documents.

(choice)

[choice] is mandatory. A single instance is required.

Product

Product is mandatory. A single instance is required.

Product is a group item defining the article and its characteristics. Product is used to specify product characteristics organized by ProductIdentifier, ProductDescription, and Classification. Book Manufacturing, Label Stock, Paper, Pulp, Recovered Paper, Wood Products, and Virgin Fibre market segments have defined their product characteristics and conversion features for implementation in papiNet.

Downtime

Downtime is mandatory. A single instance is required.

An element used to communicate when equipment is not available for manufacturing purposes.

PlanningBucket

PlanningBucket is mandatory. One instance is required, multiple instances might exist.

PlanningBucket groups together the elements required to communicate the time and quantity related information for the parent item (either Product or Downtime).

WasteQuantity

WasteQuantity is optional. Multiple instances might exist.

The quantity of product wasted.

InformationalQuantity

InformationalQuantity is optional. Multiple instances might exist.

A quantity given in a valid UOM used for information purposes only (not for calculation). For example, an ordered quantity was 100 reels as opposed to the invoice quantity of 20,000 pounds.

EndUses

EndUses is optional. Multiple instances might exist.

A text element used to express in human readable form a list of applicable end uses for a product. Examples of end uses are:

- Magazine
- Book
- Commercial print
- etc

AdditionalText

AdditionalText is optional. Multiple instances might exist.

A text field that is used to communicate information not previously defined or for special instructions. To be used only for circumstances not covered by specific elements.

PlanningLineItemNumber

A sequential number that uniquely identifies the PlanningLineItemNumber.

PlanningLineItemNumber	
type	lineNumberType

PlanningMessageNumber

A unique identifier assigned to the Planning e-Document assigned by the issuer that makes this Planning unique. Subsequent Planning e-Documents with updates will use this same PlanningMessageNumber.

PlanningMessageNumber	
type	s30

PlanningOutcome

A grouping element that communicates the planned, actual, forecasted etc. quantities or resources. Also the deviations and reasons for these can be given.

PlanningOutcomeType [attribute]

PlanningOutcomeType is mandatory. A single instance is required.

PlanningOutcomeType defines the type of PlanningOutcome.

Refer to

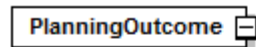

PlanningOutcomeType definition for any enumerations.

PlanningOutcomePeriodType [attribute]

PlanningOutcomePeriodType is optional. A single instance might exist.

Defines the type of period for the planning outcome.

Refer to PlanningOutcomePeriodType definition for any enumerations.

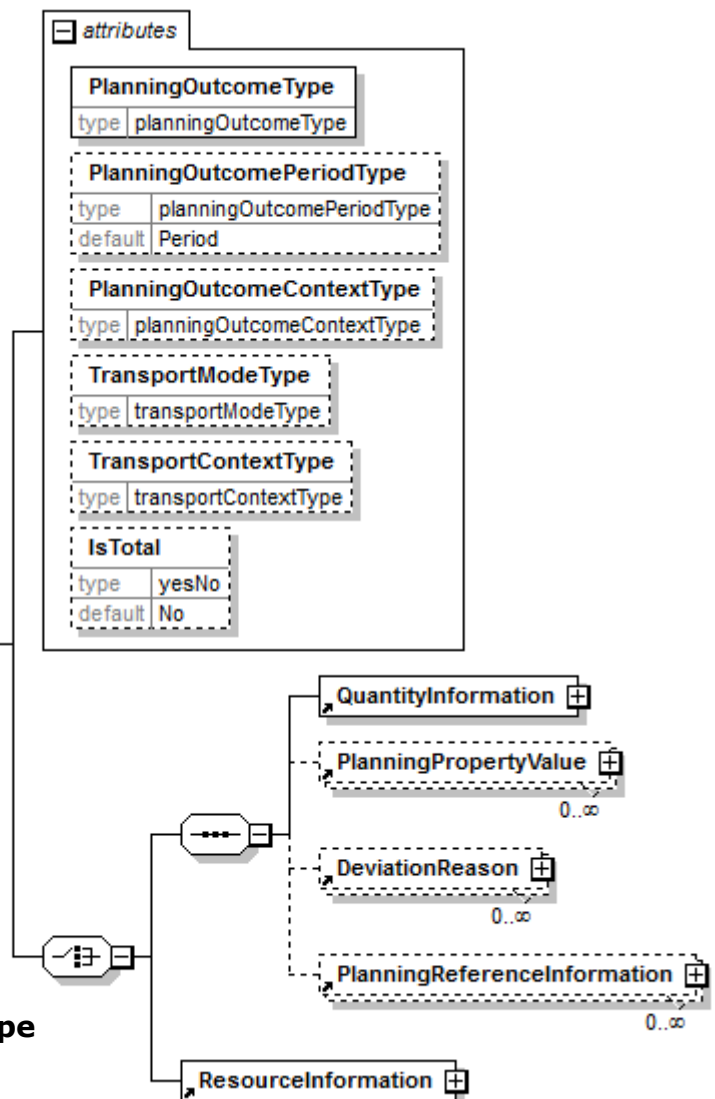

PlanningOutcomeContextType [attribute]

PlanningOutcomeContextType is optional. A single instance might exist.

Defines the context for the planning outcome.

Refer to PlanningOutcomeContextType definition for any enumerations.

TransportModeType [attribute]

TransportModeType is optional. A single instance might exist.

Defines the primary mode of transport for the goods

Refer to TransportModeType definition for any enumerations.

TransportContextType [attribute]

TransportContextType is optional. A single instance might exist.

Provides information about the reason for the transport.

Refer to TransportContextType definition for any enumerations.

IsTotal [attribute]

IsTotal is optional. A single instance might exist.

Specifies if the value is the total value or not.

Refer to IsTotal definition for any enumerations.

(choice)

[choice] is mandatory. A single instance is required.

(sequence)

The sequence is mandatory. A single instance is required.

QuantityInformation

QuantityInformation is mandatory. A single instance is required.

A group item containing information about quantity and informational quantity of similar items.

PlanningPropertyValue

PlanningPropertyValue is optional. Multiple instances might exist.

A group item that specifies a value of a property for the planning.

DeviationReason

DeviationReason is optional. Multiple instances might exist.

A group item containing the reason for deviation from the plan.

PlanningReferenceInformation

PlanningReferenceInformation is optional. Multiple instances might exist.

A grouping element specifying detailed reference information used for the supplied plan in the e-Document. For example if a transport plan is created as a response to a requested delivery plan, then the delivery plan can be referenced with document details such as document date and version.

ResourceInformation

ResourceInformation is mandatory. A single instance is required.

A group item that contains information for specification of resources.

PlanningOutcomeBucket

PlanningOutcomeBucket groups together the elements required to communicate the time and quantity for a planning bucket.

BucketStatusType [attribute]

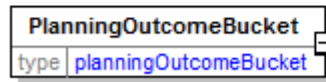

BucketStatusType is optional. A single instance might exist.

BucketStatusType defines the availability status of the location during the indicated period.

Refer to BucketStatusType definition for any enumerations.

(sequence)

The sequence of items below is mandatory. A single instance is required.

TimePeriod

TimePeriod is mandatory. A single instance is required.

The TimePeriod element is used to communicate a duration period of time as indicated in PeriodType.

PlanningOutcome

PlanningOutcome is optional. Multiple instances might exist.

A grouping element that communicates the planned, actual, forecasted etc. quantities or resources. Also the deviations and reasons for these can be given.

AdditionalText

AdditionalText is optional. Multiple instances might exist.

A text field that is used to communicate information not previously defined or for special instructions. To be used only for circumstances not covered by specific elements.

(sequence)

The sequence of items below is mandatory. A single instance is required.

PlanningOutcomeDetailBucket

PlanningOutcomeDetailBucket is optional. Multiple instances might exist.

PlanningOutcomeDetailBucket groups together the elements required to communicate the time and quantity for a planning detail bucket.

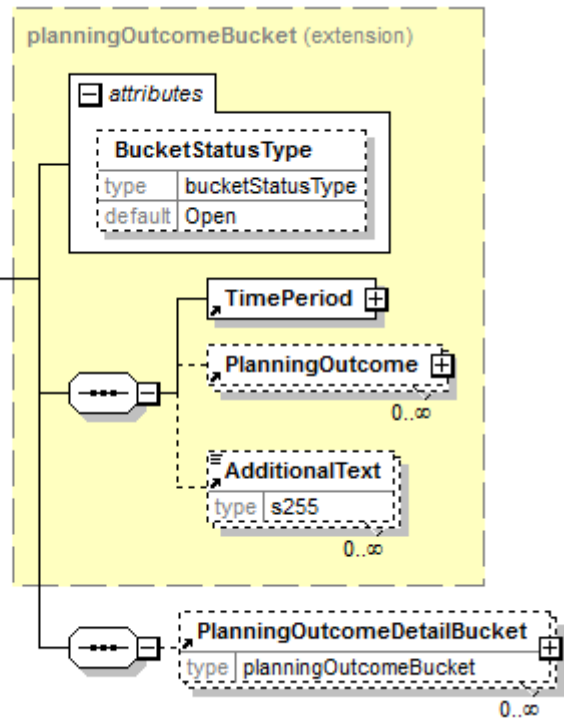

PlanningOutcomeContextType [attribute]

Defines the context for the planning outcome.

This item is restricted to the following list.

Consumption

Planning outcome specifies the consumption.

Delivery

Planning outcome specifies the deliveries.

ForestForwarding

Planning outcome specifies the forest forwarding quantities.

Production

Planning outcome specifies the production quantities.

StockForConsumption

Planning outcome specifies the stocks for consumption.

StockForTransportation

Planning outcome specifies the stocks for transportation.

Transport

Planning outcome specifies the transport quantities.

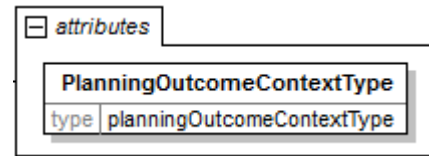

PlanningOutcomeDetailBucket

PlanningOutcomeDetailBucket groups together the elements required to communicate the time and quantity for a planning detail bucket.

BucketStatusType [attribute]

BucketStatusType is optional. A single instance might exist.

BucketStatusType defines the availability status of the location during the indicated period.

Refer to BucketStatusType definition for any enumerations.

(sequence)

The sequence of items below is mandatory. A single instance is required.

TimePeriod

TimePeriod is mandatory. A single instance is required.

The TimePeriod element is used to communicate a duration period of time as

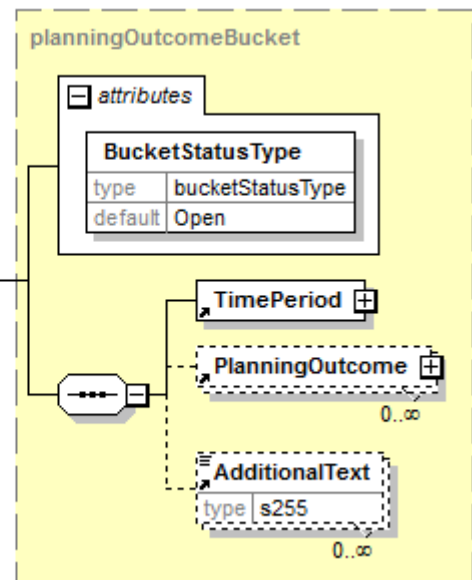

indicated in PeriodType.

PlanningOutcome

PlanningOutcome is optional. Multiple instances might exist.

A grouping element that communicates the planned, actual, forecasted etc. quantities or resources. Also the deviations and reasons for these can be given.

AdditionalText

AdditionalText is optional. Multiple instances might exist.

A text field that is used to communicate information not previously defined or for special instructions. To be used only for circumstances not covered by specific elements.

PlanningOutcomePeriodType [attribute]

Defines the type of period for the planning outcome.

This item is restricted to the following list.

Period

The planning outcome is for the whole planning period.

PeriodToDate

The planning outcome is for the elapsed time of the planning period to date.

PlanningOutcomePeriodType	
type	planningOutcomePeriodType
default	Period

PlanningOutcomeType [attribute]

PlanningOutcomeType defines the type of PlanningOutcome.

This item is restricted to the following list.

Actual

The planning outcome communicates incurred values.

Demand

The planning outcome communicates requested values.

Forecast

The planning outcome communicates estimated values.

Budget

The planning outcome communicates budgeted values.

Plan

The planning outcome communicates planned values.

PlanningOutcomeType	
type	planningOutcomeType

PlanningPeriodInfo

A grouping element detailing the information about the planning period.

(sequence)

The sequence of items below is mandatory. A single instance is required.

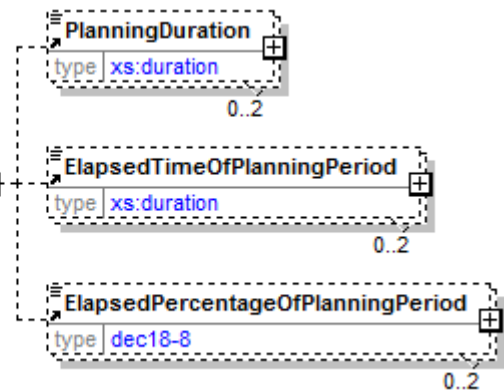
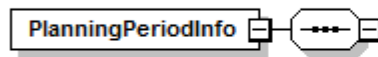

PlanningDuration

PlanningDuration is optional. Two instances might exist.

Duration of the planning period.

ElapsedTimeOfPlanningPeriod

ElapsedTimeOfPlanningPeriod is optional. Two instances might exist.

Time that has elapsed within planning period.

ElapsedPercentageOfPlanningPeriod

ElapsedPercentageOfPlanningPeriod is optional. Two instances might exist.

The percentage of time that has elapsed within planning period.

PlanningProcessType [attribute]

The type of process that the Planning e-Document communicates.

This item is restricted to the following list.

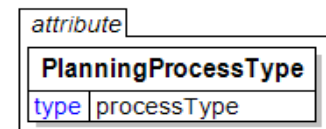

Consumption

Consumed in manufacturing.

DeliveryReceipt

Delivered to the ship-to location.

Despatch

Ready to be shipped.

Inventory

In available inventory at the storage location.

Production

The quantity added to stock through a manufacturing or conversion process.

Sales

A PurchaseOrder has been placed for the product.

PlanningPropertyType [attribute]

PlanningPropertyType defines the type of PlanningPropertyValue.

This item is restricted to the following list.

AllocatedUnloadingCapacity

The unloading capacity that is allocated.

RunningRate

The running rate of how much of the plan will be fulfilled.

UnloadingCapacity

The unloading capacity.



PlanningPropertyValue

A group item that specifies a value of a property for the planning.

PlanningPropertyType [attribute]

PlanningPropertyType is mandatory. A single instance is required.

PlanningPropertyType defines the type of PlanningPropertyValue.

Refer to PlanningPropertyType definition for any enumerations.

(choice)

[choice] is mandatory. A single instance is required.

BinaryValue

BinaryValue is mandatory. A single instance is required.

A value in base-64-encoded binary format.

BooleanValue

BooleanValue is mandatory. A single instance is required.

A value in boolean format.

DateTimeValue

DateTimeValue is mandatory. A single instance is required.

A Date and Time value in the standard W3C xs:dateTime format.

NumericValue

NumericValue is mandatory. A single instance is required.

A grouping element for a numeric value and its statistical measures.

TextValue

TextValue is mandatory. A single instance is required.

A value in text format.

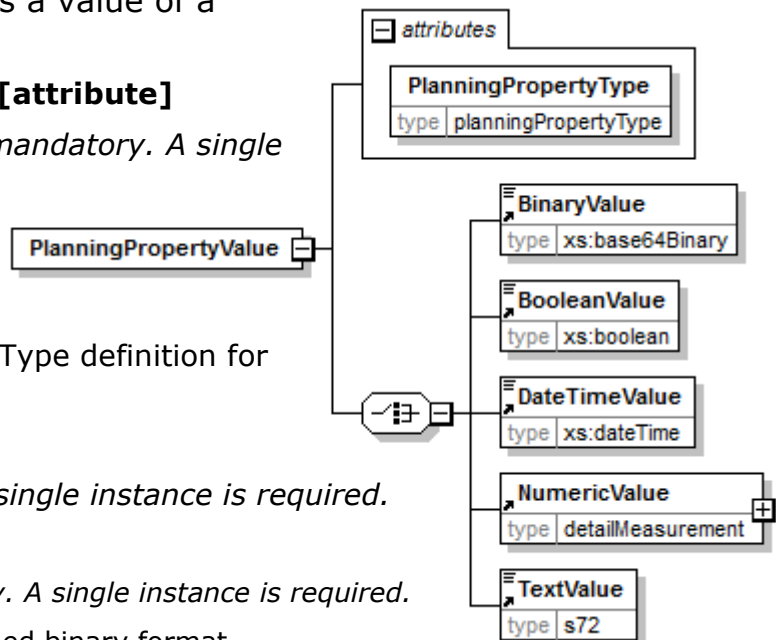

PlanningReference

An element detailing relevant references pertaining to the Planning and DeliveryPlanning e-Documents.

PlanningReferenceType [attribute]

PlanningReferenceType is mandatory. A single instance is required.

Provides a contextual explanation of the specific reference identifier. Many items are currently prefixed by "Buyer", "Forwarder", "Manufacturer", "Mill", "Seller", "Supplier", "Warehouse", or "Vendor". Check for an existing non-prefixed version and use the non-prefixed version instead. In the (yet to be announced release date) version 3.0 the prefixed versions will be removed. Instead the attribute @AssignedBy will communicate the information previously communicated in the prefix.

Refer to PlanningReferenceType definition for any enumerations.

AssignedBy [attribute]

AssignedBy is optional. A single instance might exist.

Identifies the type of party or the agency that has assigned the associated item, e.g. a reference of type OrderNumber.

Refer to AssignedBy for any enumerations.

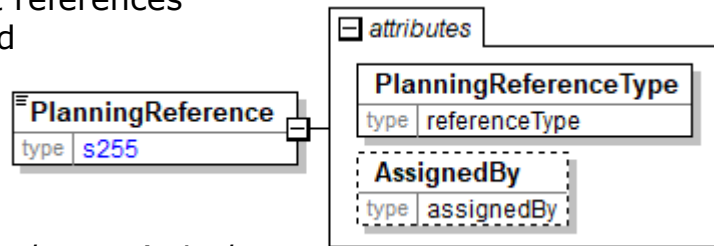

PlanningReferenceInformation

A grouping element specifying detailed reference information used for the

supplied plan in the e-Documents. For example if a transport plan is created as a response to a requested delivery plan, then the delivery plan can be referenced with document details such as document date and version.

(sequence)

The sequence of items below is mandatory. A single instance is required.

Document

Document is mandatory. A single instance is required.

A group item containing information applicable to the original document.

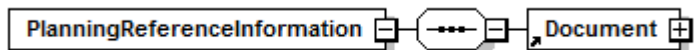

PlanningReferenceType [attribute]

Provides a contextual explanation of the specific reference identifier. Many items are currently prefixed by "Buyer", "Forwarder", "Manufacturer", "Mill", "Seller", "Supplier", "Warehouse", or "Vendor". Check for an existing non-prefixed version and use the non-prefixed version instead. In the (yet to be announced release date) version 3.0 the prefixed versions will be removed. Instead the attribute @AssignedBy will communicate the information previously communicated in the prefix.

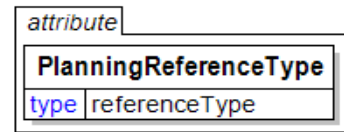

Refer to the [referenceType](#) entry for the list of enumerations and their definitions.

PlanningRequestDetail

A grouping element that provides the parameters to be used when responding with a Planning e-Document.

(sequence)

The sequence of items below is mandatory. A single instance is required.

Product

Product is mandatory. A single instance is required.

Product is a group item defining the article and its characteristics. Product is used to specify product characteristics organized by ProductIdentifier, ProductDescription, and Classification. Book Manufacturing, Label Stock, Paper, Pulp, Recovered Paper, Wood Products, and Virgin Fibre market segments have defined their product characteristics and conversion features for implementation in papiNet.

LocationParty

LocationParty is optional. Multiple instances might exist.

The organization or business entity where the business event took place or will take place.

BuyerParty

BuyerParty is optional. Multiple instances might exist.

The legal entity to which the product is sold. Also commonly referred to as the sold-to party or customer. If no OtherParty is defined as the Payer, the Buyer is the Payer.

ShipToParty

ShipToParty is optional. Multiple instances might exist.

The name and/or address to which the goods should be delivered with the party type indicated by the PartyType attribute.

EndUserParty

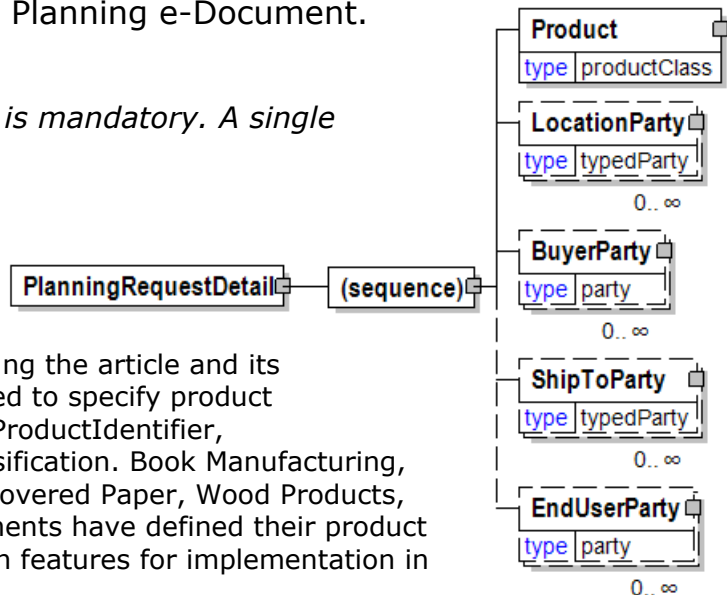

EndUserParty is optional. Multiple instances might exist.

The party using, consuming, or converting the product. For example, a printer using paper reels for a print job for a publisher. The final ShipTo destination for a product is normally to the end user's facilities.

PlasticMaterial

Describes the plastic used in the process.

PlasticPrinting [attribute]

PlasticPrinting is optional. A single instance might exist.

Either "Yes" or "No".

Refer to PlasticPrinting definition for any enumerations.

PlasticMaterialType [attribute]

PlasticMaterialType is optional. A single instance might exist.

The type of plastic material

Refer to PlasticMaterialType definition for any enumerations.

(sequence)

The sequence of items below is mandatory. A single instance is required.

Thickness

Thickness is mandatory. A single instance is required.

Physical dimension of a product.

PlasticPrintingDescription

PlasticPrintingDescription is optional. A single instance might exist.

Plastic printing description

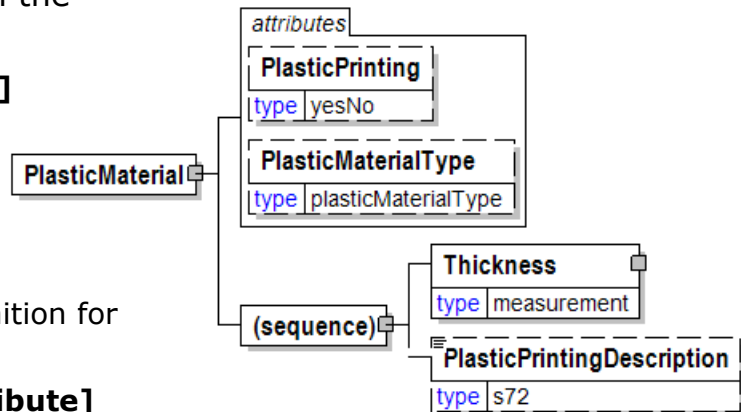

PlasticMaterialType [attribute]

The type of plastic material

This item is restricted to the following list.

PC

PET

PVC

Other



PlasticPrinting [attribute]

Either "Yes" or "No".

This item is restricted to the following list.

Yes

No



PlasticPrintingDescription

Plastic printing description



Plate

The image carrying medium.

(sequence)

The sequence of items below is mandatory. A single instance is required.

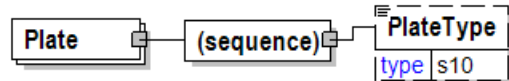

PlateType

PlateType is optional. A single instance might exist.

The category of material used to carry an image to reproduce a print impress.
(paper, metal, plastic, rubber)

PlateType

The category of material used to carry an image to reproduce a print impress. (paper, metal, plastic, rubber)

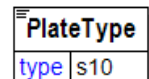

papiNet V2R31

expressed as the weight in grams of one sheet of paper that is one square meter in area—not dependent on basic sheet size. In countries using the imperial system, the weight is expressed in pounds for a given ProductBasisSizeType.

BendingResistance

BendingResistance is optional. Multiple instances might exist.

Bending resistance

BendingStiffness

BendingStiffness is optional. Multiple instances might exist.

BendingStiffness

Brightness

Brightness is optional. Multiple instances might exist.

A measurement of the degree of light reflectivity of the product.

Bulk

Bulk is optional. Multiple instances might exist.

A group item used to communicate bulking thickness target or test value.

Burst

Burst is optional. Multiple instances might exist.

A group item used to communicate bursting strength target or test value according to a particular TestMethod.

BurstIndex

BurstIndex is optional. Multiple instances might exist.

The burst index.

Caliper

Caliper is optional. Multiple instances might exist.

The thickness of a sheet of paper under standard test conditions.

CoatWeight

CoatWeight is optional. Multiple instances might exist.

A group item used to communicate the coating thickness target or test value according to a particular TestMethod.

ColourDetail

ColourDetail is optional. Multiple instances might exist.

A group item used to communicate details of colour according to the selected colour definition scheme.

Density

Density is optional. Multiple instances might exist.

A group item used to communicate density target or test value according to a particular TestMethod.

Dirt

Dirt is optional. Multiple instances might exist.

A group item used to communicate dirt content target or test value according to a particular TestMethod.

DominantWavelength

DominantWavelength is optional. Multiple instances might exist.

Dominant wavelength

FibreLength

FibreLength is optional. Multiple instances might exist.

A group item used to communicate fibre length target or test value according to a particular TestMethod.

FibreClassification

FibreClassification is optional. Multiple instances might exist.

A group item used to communicate fibre classification according to the specified classification scheme.

Folding

Folding is optional. Multiple instances might exist.

A group item used to communicate folding endurance target or test value according to a particular TestMethod.

Formation

Formation is optional. Multiple instances might exist.

A group item used to communicate sheet formation target or test value according to a particular TestMethod.

Freeness

Freeness is optional. Multiple instances might exist.

Freeness

Friction

Friction is optional. Multiple instances might exist.

A group item used to communicate static and kinetic friction target or test value according to a particular TestMethod.

Gloss

Gloss is optional. Multiple instances might exist.

A group item used to communicate specular gloss target or test value according to a particular TestMethod.

LightScattering

LightScattering is optional. Multiple instances might exist.

A group item used to communicate light scattering coefficients according to a particular TestMethod.

Moisture

Moisture is optional. Multiple instances might exist.

Desired percentage, or other indicator, of water in the product at the time of shipment.

Opacity

Opacity is optional. Multiple instances might exist.

A group item used to communicate opacity target or test value according to a particular TestMethod.

Permeability

Permeability is optional. Multiple instances might exist.

A group item used to communicate air permeability target or test value according to a particular TestMethod.

pH

pH is optional. Multiple instances might exist.

A group item used to communicate pH (degree of acidity versus basicity) target or test value according to a particular TestMethod.

PlyBond

PlyBond is optional. Multiple instances might exist.

A group item used to communicate internal bond strength target or test value between plies according to a particular TestMethod.

Porosity

Porosity is optional. Multiple instances might exist.

A group item used to communicate a permeability target or test value.

PostConsumerWaste

PostConsumerWaste is optional. Multiple instances might exist.

A group item used to communicate the target or test value percentage of post consumer waste fibre in the product according to a particular TestMethod.

PPI

PPI is optional. Multiple instances might exist.

A group item used to communicate the number of pages in an inch of thickness either as a target or actual value. Equal to the number of sheets per inch times 2.

PreConsumerWaste

PreConsumerWaste is optional. Multiple instances might exist.

A group item used to communicate the target or test value percentage of pre-consumer waste fibre in the product according to a particular TestMethod.

Recycled

Recycled is optional. Multiple instances might exist.

A group item used to communicate the target or test value total percentage of waste fibre in the product according to a particular TestMethod.

Resistance

Resistance is optional. Multiple instances might exist.

A group item used to communicate air resistance target or test value according to a particular TestMethod.

RingCrush

RingCrush is optional. Multiple instances might exist.

Ring Crush

Roughness

Roughness is optional. Multiple instances might exist.

A group item used to communicate surface roughness target or test value according to a particular TestMethod.

RunnabilityIndex

RunnabilityIndex is optional. Multiple instances might exist.

A group item used to communicate the calculated run-ability index target or test value.

ShowThrough

ShowThrough is optional. Multiple instances might exist.

Show through

Sizing

Sizing is optional. Multiple instances might exist.

A group item used to communicate size test of paper by ink resistance target or test value.

Smoothness

Smoothness is optional. Multiple instances might exist.

A group item used to communicate surface smoothness target or test value according to a particular TestMethod.

Stiffness

Stiffness is optional. Multiple instances might exist.

A group item used to communicate stiffness target or test value.

Stretch

Stretch is optional. Multiple instances might exist.

A group item used to communicate stretch target or test value.

SurfaceStrength

SurfaceStrength is optional. Multiple instances might exist.

Surface Strength

TEA

TEA is optional. Multiple instances might exist.

Tensile Energy Absorption.

Tear

Tear is optional. Multiple instances might exist.

A group item used to communicate tearing resistance target or test value according to a particular TestMethod.

TearIndex

TearIndex is optional. Multiple instances might exist.

TearIndex

Tensile

Tensile is optional. Multiple instances might exist.

A group item used to communicate zero-span tensile strength target or test value according to a particular TestMethod.

TensileIndex

TensileIndex is optional. Multiple instances might exist.

Tensile Index

Whiteness

Whiteness is optional. Multiple instances might exist.

A group item used to communicate degree of whiteness target or test value according to a particular TestMethod.

AdditionalTest

AdditionalTest is optional. A single instance might exist.

AdditionalTest exists to enable the inclusion of a test that has not been identified by papiNet.org. It is always a single-instance element so it is very important that users, who come upon a test that papiNet.org has not identified, communicate the need for this test to us at www.papiNet.org.

PlyBond

A group item used to communicate internal bond strength target or test value between plies according to a particular TestMethod.

TestMethod [attribute]

TestMethod is optional. A single instance might exist.

The method used to determine the results of the test under consideration.

TestAgency [attribute]

TestAgency is optional. A single instance might exist.

The agency that has set the parameters for the testing

Refer to TestAgency definition for any enumerations.

SampleType [attribute]

SampleType is optional. A single instance might exist.

Communicates how sampling was done to measure the product characteristics.

Refer to SampleType definition for any enumerations.

ResultSource [attribute]

ResultSource is optional. A single instance might exist.

Used to define the data source of the specified test

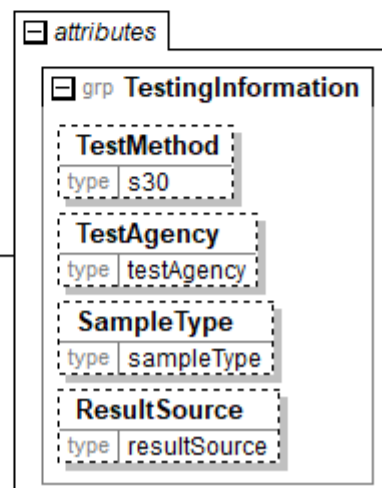
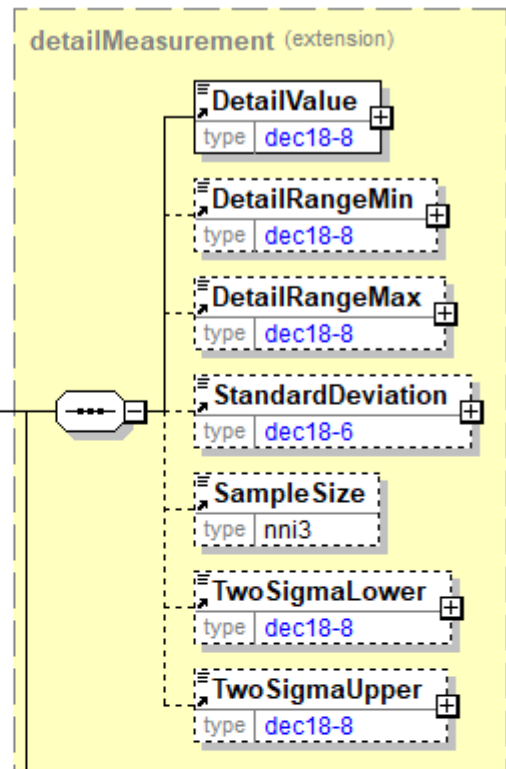

papiNet V2R31

Refer to ResultSource definition for any enumerations.

(sequence)

The sequence of items below is mandatory. A single instance is required.

DetailValue

DetailValue is mandatory. A single instance is required.

A numeric value expressed in the unit of measure (UOM).

DetailRangeMin

DetailRangeMin is optional. A single instance might exist.

The minimum value (lower boundary) allowed for the DetailValue that is the parent of this element.

DetailRangeMax

DetailRangeMax is optional. A single instance might exist.

The maximum value (upper boundary) allowed for the DetailValue that is the parent of this element.

StandardDeviation

StandardDeviation is optional. A single instance might exist.

A statistic used as a measure of dispersion in a distribution.

SampleSize

SampleSize is optional. A single instance might exist.

The number of samples used to determine the product characteristic in question.

TwoSigmaLower

TwoSigmaLower is optional. A single instance might exist.

Two sigma (a measure of dispersion associated with standard deviation) on the lower side of the standard deviation.

TwoSigmaUpper

TwoSigmaUpper is optional. A single instance might exist.

Two sigma (a measure of dispersion associated with standard deviation) on the upper side of the standard deviation.

PlyNumber

Product attributes can be detailed for each ply. If product attributes are defined for the plies this element defines the ply that these product attributes apply to.

PlyNumber
type nni1

PlySet

PlySet.

EdgePaddable [attribute]

EdgePaddable is optional. A single instance might exist.

Refers to the process of applying edge padding glue or adhesive (Yes) or not (No). A liquid adhesive mixture which when brushed or sprayed onto the side of a pile of paper binds the sheets together along one edge, thus forming a pad.

Refer to EdgePaddable definition for any enumerations.

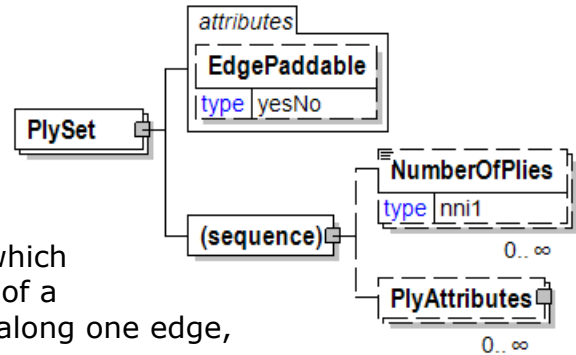

(sequence)

The sequence of items below is mandatory. A single instance is required.

NumberOfPlies

NumberOfPlies is optional. Multiple instances might exist.

The number of layers of paper product joined together to make the final saleable product.

PlyAttributes

PlyAttributes is optional. Multiple instances might exist.

The characteristics of the plies of paper or tissue. Manufacturing data relevant to each ply that constitutes the final product

PlywoodLayupStructure

(sequence)

The sequence of items below is mandatory. A single instance is required.

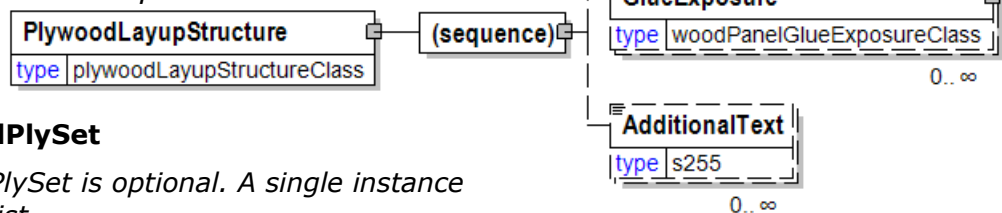

PlywoodPlySet

PlywoodPlySet is optional. A single instance might exist.

GlueExposure

GlueExposure is optional. Multiple instances might exist.

AdditionalText

AdditionalText is optional. Multiple instances might exist.

A text field that is used to communicate information not previously defined or for special instructions. To be used only for circumstances not covered by specific elements.

PlywoodMachining

PlywoodMachining defines the machining made to the panel (for example, grooving).

Agency [attribute]

Agency is mandatory. A single instance is required.

Describes the agency maintaining the list of codes. To be included in this list the agency must be a recognized standards body or industry organisation.

- For the element that owns this attribute.
- For another attribute in the list of attributes associated with the parent element.

Refer to Agency definition for any enumerations.

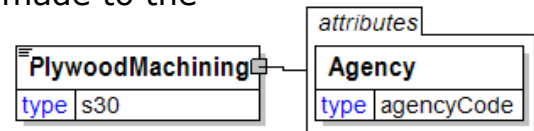

PlywoodOSBGrade

Defines the grade of plywood, OSB product

Face [attribute]

Face is optional. A single instance might exist.

Used to describe which side (or face) of the product that the grade is applicable to.

Refer to Face definition for any enumerations.

(sequence)

The sequence of items below is mandatory. A single instance is required.

SpanRating

SpanRating is optional. A single instance might exist.

Span Rating according to NIST standards and indicated on grade stamp.

Refer to SpanRating definition for any enumerations.

StrengthGroup

StrengthGroup is optional. A single instance might exist.

As defined in the NIST standard, an additional classification of panel strength.

Refer to StrengthGroup definition for any enumerations.

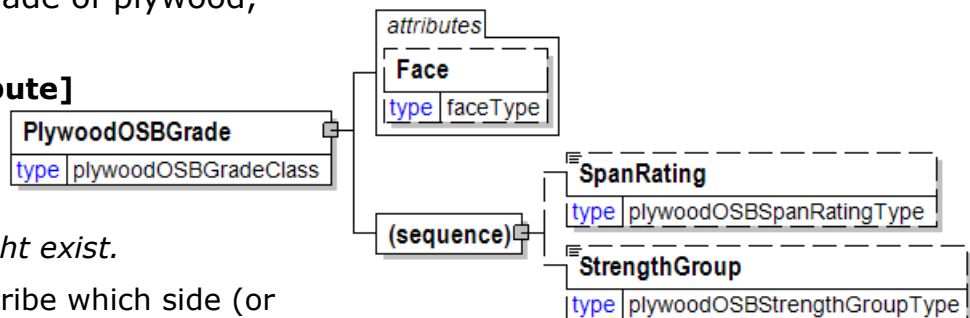

PlywoodOSBSpecies

Defines the raw material species of plywood,OSB product.

This item is restricted to the following list.

- Southern**
- Western**
- Aspen**
- DF**
- Hemlock**
- Larch**
- WhiteFir**

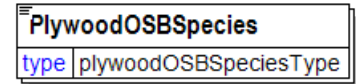

PlywoodPlyCharacteristics

(sequence)

The

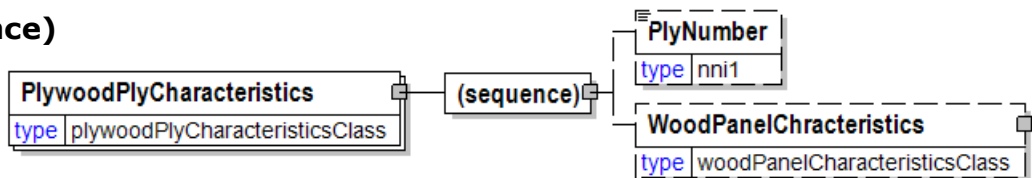

sequence of items below is mandatory. A single instance is required.

PlyNumber

PlyNumber is optional. A single instance might exist.

Product attributes can be detailed for each ply. If product attributes are defined for the plies this element defines the ply that these product attributes apply to.

WoodPanelChracteristics

WoodPanelChracteristics is optional. A single instance might exist.

PlywoodPlyGrade

Defines the grade of one ply, used with Agency to specify the grading agency.

Agency [attribute]

Agency is mandatory. A single instance is required.

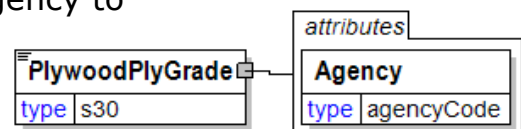

Describes the agency maintaining the list of codes. To be included in this list the agency must be a recognized standards body or industry organisation.

- For the element that owns this attribute.
- For another attribute in the list of attributes associated with the parent element.

Refer to Agency definition for any enumerations.

PlywoodPlySet

(sequence)

The sequence of items below is mandatory. A single instance is required.

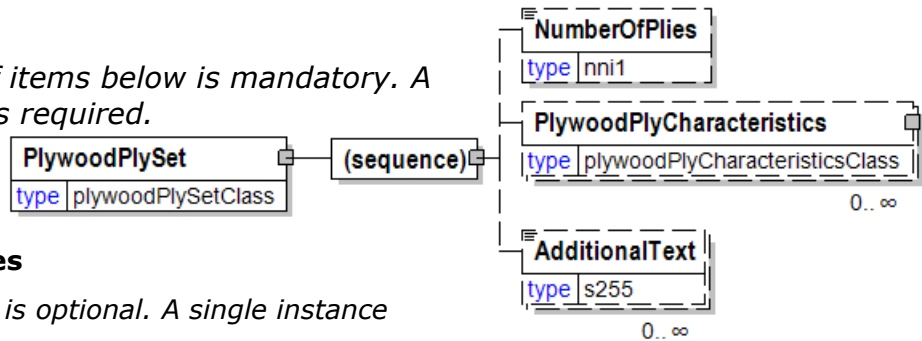

NumberOfPlies

NumberOfPlies is optional. A single instance might exist.

The number of layers of paper product joined together to make the final saleable product.

PlywoodPlyCharacteristics

PlywoodPlyCharacteristics is optional. Multiple instances might exist.

AdditionalText

AdditionalText is optional. Multiple instances might exist.

A text field that is used to communicate information not previously defined or for special instructions. To be used only for circumstances not covered by specific elements.

Porosity

A group item used to communicate a permeability target or test value.

TestMethod [attribute]

TestMethod is optional. A single instance might exist.

The method used to determine the results of the test under consideration.

TestAgency [attribute]

TestAgency is optional. A single instance might exist.

The agency that has set the parameters for the testing

Refer to TestAgency definition for any enumerations.

SampleType [attribute]

SampleType is optional. A single instance might exist.

Communicates how sampling was done to measure the product characteristics.

Refer to SampleType definition for any enumerations.

ResultSource [attribute]

ResultSource is optional. A single instance might exist.

Used to define the data source of the specified test

Refer to ResultSource definition for any enumerations.

(sequence)

The sequence of items below is mandatory. A single instance is required.

DetailValue

DetailValue is mandatory. A single instance is required.

A numeric value expressed in the unit of measure (UOM).

DetailRangeMin

DetailRangeMin is optional. A single instance might exist.

The minimum value (lower boundary) allowed for the DetailValue that is the parent of this element.

DetailRangeMax

DetailRangeMax is optional. A single instance might exist.

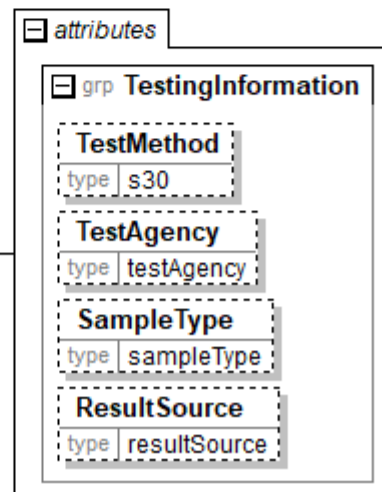
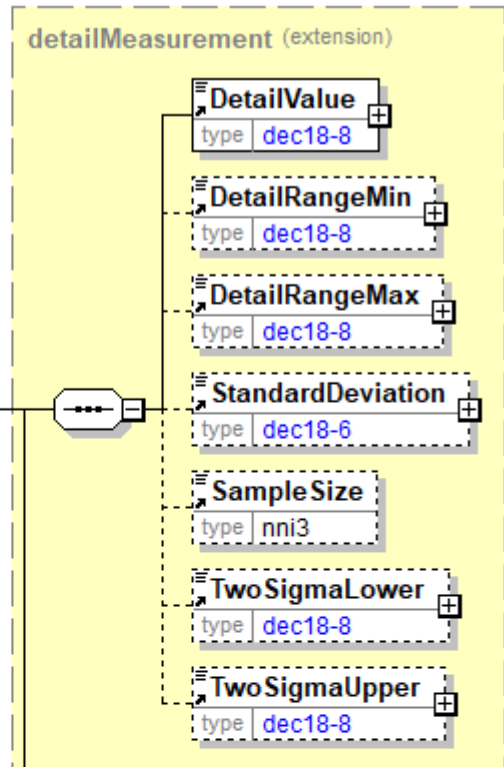

papiNet V2R31

The maximum value (upper boundary) allowed for the DetailValue that is the parent of this element.

StandardDeviation

StandardDeviation is optional. A single instance might exist.

A statistic used as a measure of dispersion in a distribution.

SampleSize

SampleSize is optional. A single instance might exist.

The number of samples used to determine the product characteristic in question.

TwoSigmaLower

TwoSigmaLower is optional. A single instance might exist.

Two sigma (a measure of dispersion associated with standard deviation) on the lower side of the standard deviation.

TwoSigmaUpper

TwoSigmaUpper is optional. A single instance might exist.

Two sigma (a measure of dispersion associated with standard deviation) on the upper side of the standard deviation.

PositionInSheet

Location in the sheet where the defect was identified.

PositionInSheet	
type	s20

PositionMeasuredFrom [attribute]

Defines from where the position is measured on an item.

PositionMeasuredFrom	
type	positionMeasuredFrom

This item is restricted to the following list.

Bottom

The position is measured from the bottom of the item.

BackEnd

The position is measured from the back end of the item.

FrontEnd

The position is measured from the front end of the item.

LargeEnd

The position is measured from the large end of the item.

SmallEnd

The position is measured from the small end of the item.

Top

The position is measured from the top of the item.

PositionOnItem

Specifies a position on an item. The attribute PositionMeasuredFrom defines the reference point for the position.

PositionMeasuredFrom [attribute]

PositionMeasuredFrom is mandatory. A single instance is required.

Specifies how detailed the measurements are done.

Refer to PositionMeasuredFrom definition for any enumerations.

UOM [attribute]

UOM is mandatory. A single instance is required.

Defines the unit of measure for the value.

Refer to UOM definition for any enumerations.

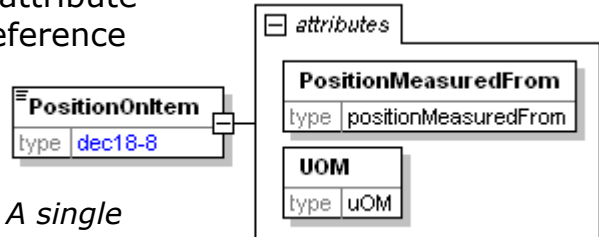

PostalCode

The postal code associated with the address elements.



PostConsumerWaste

A group item used to communicate the target or test value percentage of post consumer waste fibre in the product according to a particular TestMethod.

TestMethod [attribute]

TestMethod is optional. A single instance might exist.

The method used to determine the results of the test under consideration.

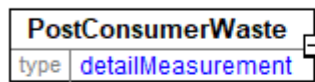

TestAgency [attribute]

TestAgency is optional. A single instance might exist.

- The agency that has set the parameters for the testing

Refer to TestAgency definition for any enumerations.

SampleType [attribute]

SampleType is optional. A single instance might exist.

Communicates how sampling was done to measure the product characteristics.

Refer to SampleType definition for any enumerations.

ResultSource [attribute]

ResultSource is optional. A single instance might exist.

Used to define the data source of the specified test

Refer to ResultSource definition for any enumerations.

(sequence)

The sequence of items below is mandatory. A single instance is required.

DetailValue

DetailValue is mandatory. A single instance is required.

A numeric value expressed in the unit of measure (UOM).

DetailRangeMin

DetailRangeMin is optional. A single instance might exist.

The minimum value (lower boundary) allowed for the DetailValue that is the parent of this element.

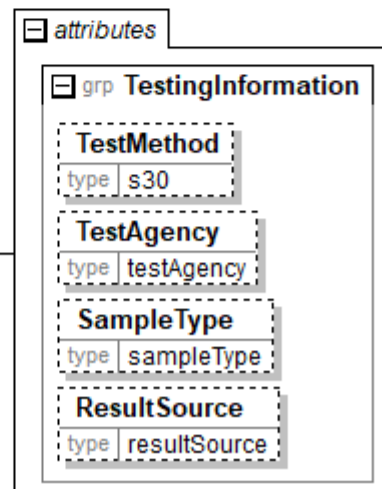
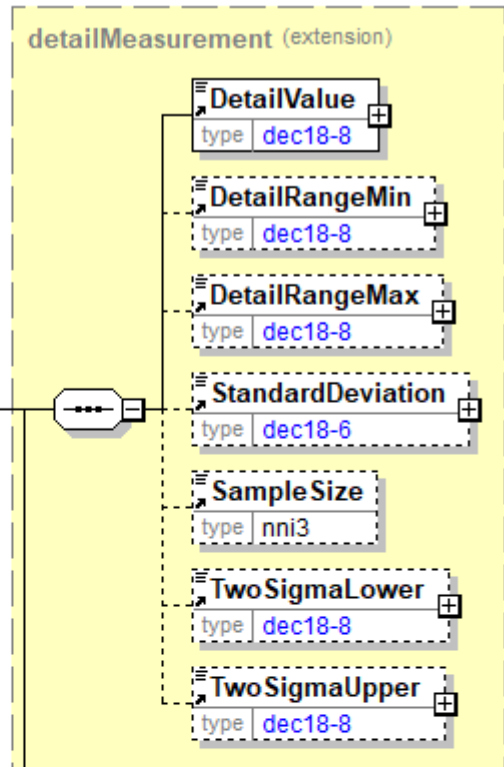

papiNet V2R31

DetailRangeMax

DetailRangeMax is optional. A single instance might exist.

The maximum value (upper boundary) allowed for the DetailValue that is the parent of this element.

StandardDeviation

StandardDeviation is optional. A single instance might exist.

A statistic used as a measure of dispersion in a distribution.

SampleSize

SampleSize is optional. A single instance might exist.

The number of samples used to determine the product characteristic in question.

TwoSigmaLower

TwoSigmaLower is optional. A single instance might exist.

Two sigma (a measure of dispersion associated with standard deviation) on the lower side of the standard deviation.

TwoSigmaUpper

TwoSigmaUpper is optional. A single instance might exist.

Two sigma (a measure of dispersion associated with standard deviation) on the upper side of the standard deviation.

PPI

A group item used to communicate the number of pages in an inch of thickness either as a target or actual value. Equal to the number of sheets per inch times 2.

(sequence)

The sequence of items below is mandatory. A single instance is required.

Value

Value is mandatory. A single instance is required.

A numeric value expressed in the unit of measure (UOM).

RangeMin

RangeMin is optional. A single instance might exist.

The minimum value (lower boundary) allowed for the Measurement that is the parent of this element.

RangeMax

RangeMax is optional. A single instance might exist.

The maximum value (upper boundary) allowed for the Measurement that is the parent of this element. Some elements use the RangeMax element with an extended list of unit of measures. (Note: the red colour in the picture is an artifact of how the graphic was captured and should be disregarded.)

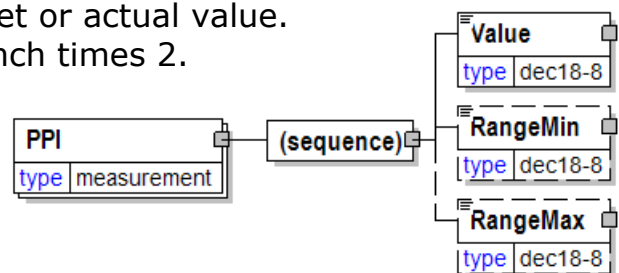

PreConsumerWaste

A group item used to communicate the target or test value percentage of pre-consumer waste fibre in the product according to a particular TestMethod.

TestMethod [attribute]

TestMethod is optional. A single instance might exist.

The method used to determine the results of the test under consideration.

TestAgency [attribute]

TestAgency is optional. A single instance might exist.

The agency that has set the parameters for the testing

Refer to TestAgency definition for any enumerations.

SampleType [attribute]

SampleType is optional. A single instance might exist.

Communicates how sampling was done to measure the product characteristics.

Refer to SampleType definition for any enumerations.

ResultSource [attribute]

ResultSource is optional. A single instance might exist.

Used to define the data source of the specified test

Refer to ResultSource definition for any enumerations.

(sequence)

The sequence of items below is mandatory. A single instance is required.

DetailValue

DetailValue is mandatory. A single instance is required.

A numeric value expressed in the unit of measure (UOM).

DetailRangeMin

DetailRangeMin is optional. A single instance might exist.

The minimum value (lower boundary) allowed for the DetailValue that is the parent of this element.

DetailRangeMax

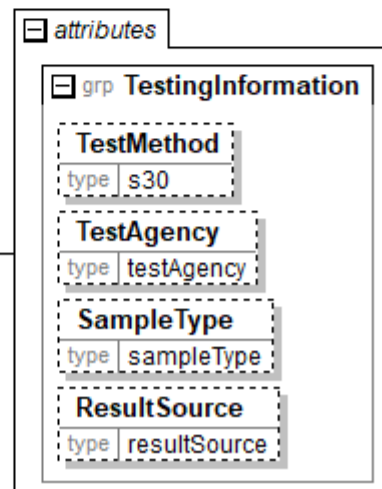
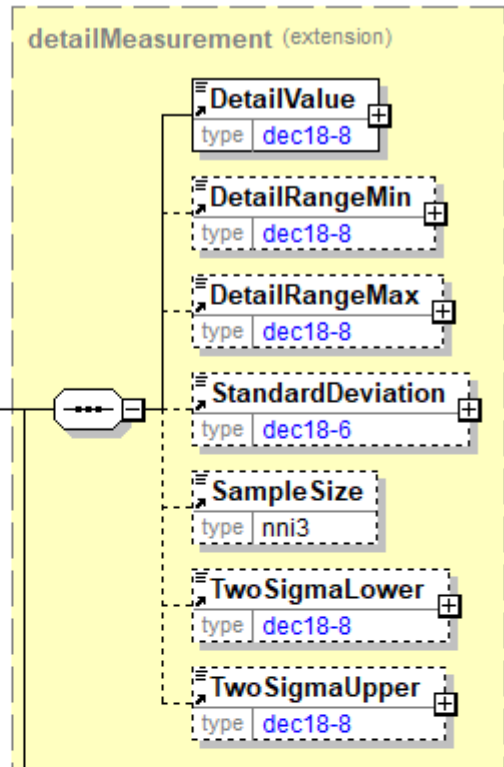

papiNet V2R31

DetailRangeMax is optional. A single instance might exist.

The maximum value (upper boundary) allowed for the DetailValue that is the parent of this element.

StandardDeviation

StandardDeviation is optional. A single instance might exist.

A statistic used as a measure of dispersion in a distribution.

SampleSize

SampleSize is optional. A single instance might exist.

The number of samples used to determine the product characteristic in question.

TwoSigmaLower

TwoSigmaLower is optional. A single instance might exist.

Two sigma (a measure of dispersion associated with standard deviation) on the lower side of the standard deviation.

TwoSigmaUpper

TwoSigmaUpper is optional. A single instance might exist.

Two sigma (a measure of dispersion associated with standard deviation) on the upper side of the standard deviation.

Preflight

The Preflight element is the root element for the Preflight e-Document.

The Preflight e-Document reports the status of prep content files separately, by product or by Purchase Order or to report status of multiple files based upon some specified criteria. The e-Document enables the sender to indicate a primary status as well as an additional secondary status as needed.

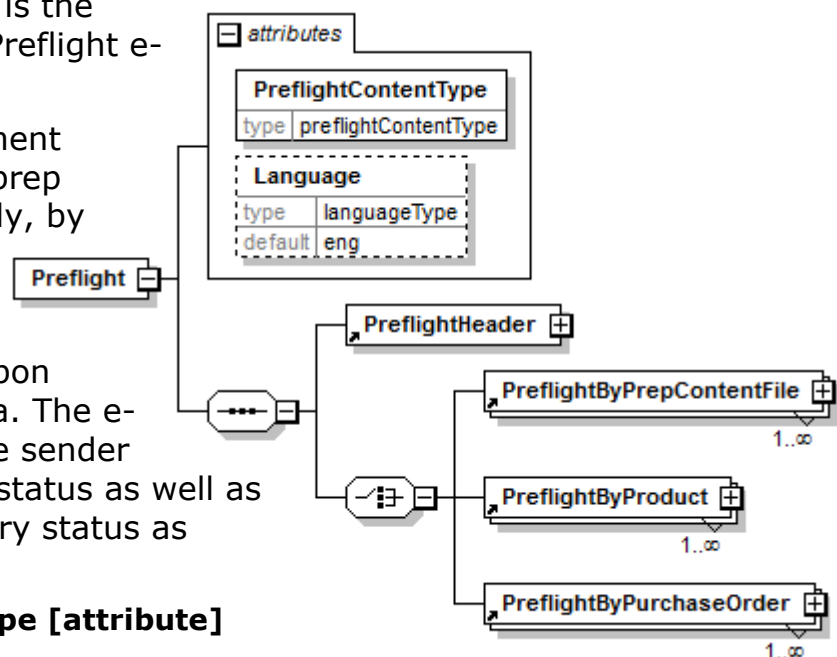

PreflightContentType [attribute]

PreflightContentType is mandatory. A single instance is required.

Communicates the method in which the Preflight detail status has been summarized.

Refer to PreflightContentType definition for any enumerations.

Language [attribute]

Language is optional. A single instance might exist.

papiNet V2R31

The valid Alpha 2- and Alpha 3-character list of language codes in the ISO 639-1 and 639-2 international standards.

Information on the content of this attribute is available at:
https://www.loc.gov/standards/iso639-2/php/code_list.php

(sequence)

The sequence of items below is mandatory. A single instance is required.

PreflightHeader

PreflightHeader is mandatory. A single instance is required.

Information that applies to the entire Preflight e-Document.

(choice)

[choice] is mandatory. A single instance is required.

PreflightByPrepContentFile

PreflightByPrepContentFile is mandatory. One instance is required, multiple instances might exist.

A grouping element that contains information about the Preflight status by prep content file.

PreflightByProduct

PreflightByProduct is mandatory. One instance is required, multiple instances might exist.

A grouping element that contains information about the Preflight status by product.

PreflightByPurchaseOrder

PreflightByPurchaseOrder is mandatory. One instance is required, multiple instances might exist.

A grouping element that contains information about the Preflight status by purchase order.

PreflightByPrepContentFile

A grouping element that contains information about the Preflight status by prep content file.

(sequence)

The sequence of items below is mandatory. A single instance is required.

PrepContent

PrepContent is mandatory. A single instance is required.

A grouping element containing information about the prep content file.

PreflightReference

PreflightReference is optional. Multiple instances might exist.

An element detailing relevant references pertaining to the Preflight as indicated by PreflightReferenceType and AssignedBy.

Product

Product is optional. A single instance might exist.

Product is a group item defining the article and its characteristics. Product is used to specify product characteristics organized by ProductIdentifier, ProductDescription, and Classification. Book Manufacturing, Label Stock, Paper, Pulp, Recovered Paper, Wood Products, and Virgin Fibre market segments have defined their product characteristics and conversion features for implementation in papiNet.

SupplierParty

SupplierParty is optional. A single instance might exist.

The organisation or business entity responsible for providing the product. SupplierParty is also the seller of the product, if Seller is not specified as OtherParty = Seller.

TimePeriod

TimePeriod is optional. A single instance might exist.

The TimePeriod element is used to communicate a duration period of time as indicated in PeriodType.

PriceDetails

PriceDetails is optional. Multiple instances might exist.

An element that groups together price information.

AdditionalText

AdditionalText is optional. Multiple instances might exist.

A text field that is used to communicate information not previously defined or for special instructions. To be used only for circumstances not covered by specific elements.

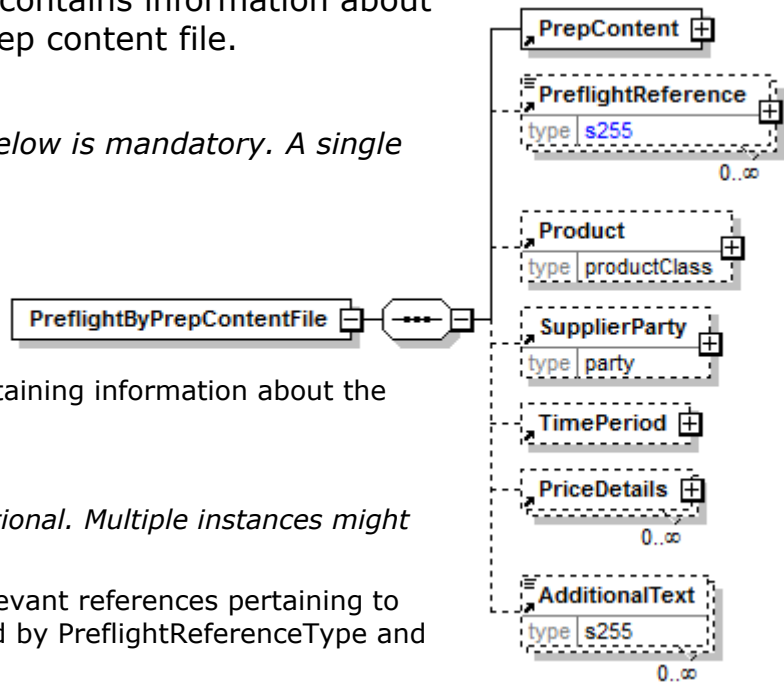

PreflightByProduct

A grouping element that contains information about the Preflight status by product.

(sequence)

The sequence of items below is mandatory. A single instance is required.

Product

Product is mandatory. A single instance is required.

Product is a group item defining the article and its characteristics. Product is used to specify product characteristics organized by ProductIdentifier, ProductDescription, and Classification. Book Manufacturing, Label Stock, Paper, Pulp, Recovered Paper, Wood Products, and Virgin Fibre market segments have defined their product characteristics and conversion features for implementation in papiNet.

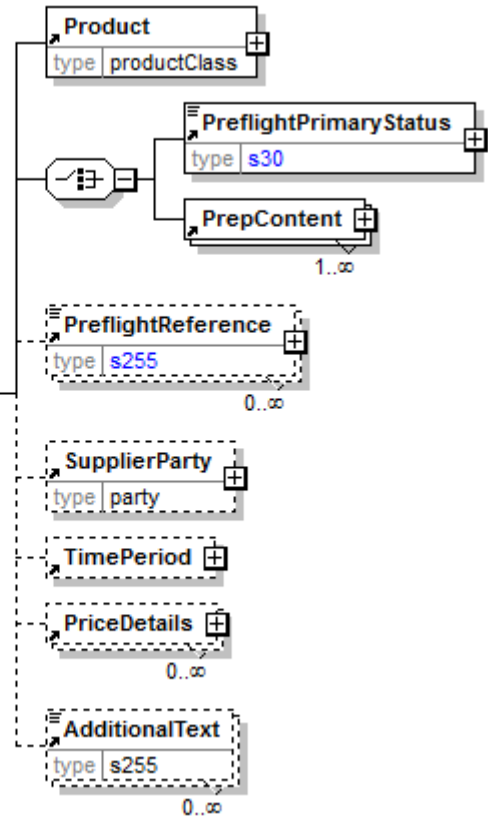
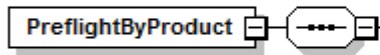

(choice)

[choice] is mandatory. A single instance is required.

PreflightPrimaryStatus

PreflightPrimaryStatus is mandatory. A single instance is required.

A description of the highest level status pertaining to the item being reported: content file, Product or Purchase Order.

PrepContent

PrepContent is mandatory. One instance is required, multiple instances might exist.

A grouping element containing information about the prep content file.

PreflightReference

PreflightReference is optional. Multiple instances might exist.

An element detailing relevant references pertaining to the Preflight as indicated by PreflightReferenceType and AssignedBy.

SupplierParty

SupplierParty is optional. A single instance might exist.

The organisation or business entity responsible for providing the product. SupplierParty is also the seller of the product, if Seller is not specified as OtherParty = Seller.

TimePeriod

TimePeriod is optional. A single instance might exist.

The TimePeriod element is used to communicate a duration period of time as indicated in PeriodType.

PriceDetails

papiNet V2R31

PriceDetails is optional. Multiple instances might exist.

An element that groups together price information.

AdditionalText

AdditionalText is optional. Multiple instances might exist.

A text field that is used to communicate information not previously defined or for special instructions. To be used only for circumstances not covered by specific elements.

PreflightByPurchaseOrder

A grouping element that contains information about the Preflight status by purchase order.

(sequence)

The sequence of items below is mandatory. A single instance is required.

PurchaseOrderInformation

PurchaseOrderInformation is mandatory. A single instance is required.

A group item containing information unique to this PurchaseOrder, which is provided by the buyer.

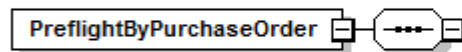

PurchaseOrderInformation can be optional in the supply chain. Invoices are created without having a PurchaseOrder in Vendor Managed Inventory. Freight invoices also will not have a PurchaseOrder number.

PurchaseOrderLineItemNumber

PurchaseOrderLineItemNumber is optional. A single instance might exist.

The sequential number that uniquely identifies the PurchaseOrder line item.

(choice)

[choice] is mandatory. A single instance is required.

PreflightPrimaryStatus

PreflightPrimaryStatus is mandatory. A single instance is required.

A description of the highest level status pertaining to the item being reported: content file, Product or Purchase Order.

PrepContent

PrepContent is mandatory. One instance is required, multiple instances might exist.

A grouping element containing information about the prep content file.

PreflightReference

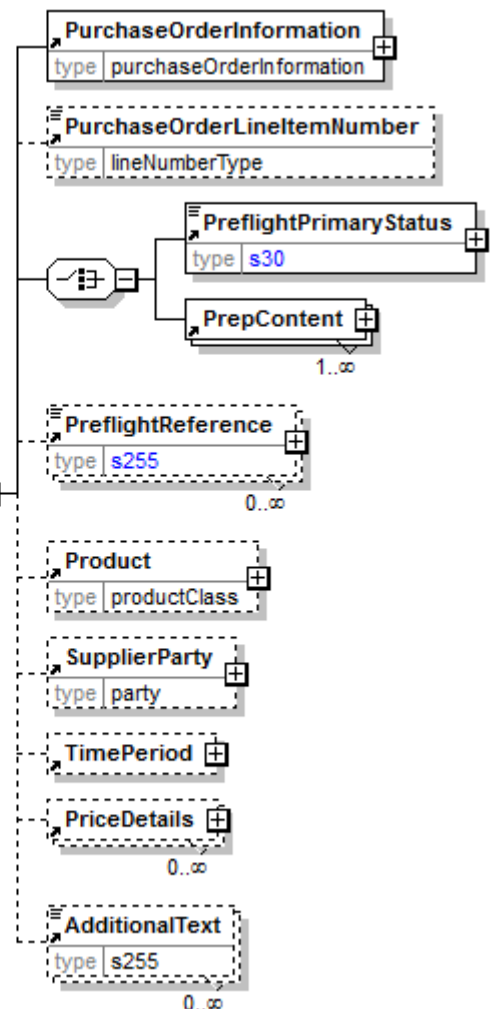

papiNet V2R31

PreflightReference is optional. Multiple instances might exist.

An element detailing relevant references pertaining to the Preflight as indicated by PreflightReferenceType and AssignedBy.

Product

Product is mandatory. A single instance is required.

Product is a group item defining the article and its characteristics. Product is used to specify product characteristics organized by ProductIdentifier, ProductDescription, and Classification. Book Manufacturing, Label Stock, Paper, Pulp, Recovered Paper, Wood Products, and Virgin Fibre market segments have defined their product characteristics and conversion features for implementation in papiNet.

SupplierParty

SupplierParty is optional. A single instance might exist.

The organisation or business entity responsible for providing the product. SupplierParty is also the seller of the product, if Seller is not specified as OtherParty = Seller.

TimePeriod

TimePeriod is optional. A single instance might exist.

The TimePeriod element is used to communicate a duration period of time as indicated in PeriodType.

PriceDetails

PriceDetails is optional. Multiple instances might exist.

An element that groups together price information.

AdditionalText

AdditionalText is optional. Multiple instances might exist.

A text field that is used to communicate information not previously defined or for special instructions. To be used only for circumstances not covered by specific elements.

PreflightContentType [attribute]

Communicates the method in which the Preflight detail status has been summarized.

This item is restricted to the following list.

PreflightByPrepContentFile

Indicates the Preflight status is by prep content file.

PreflightByProduct

Indicates the Preflight status is by product.

PreflightByPurchaseOrder

Indicates the Preflight status is by purchase order.



PreflightHeader

Information that applies to the entire Preflight e-Document.

(sequence)

The sequence of items below is mandatory. A single instance is required.

PreflightNumber

PreflightNumber is mandatory. A single instance is required.

The unique identifier for the Preflight e-Document.

PreflightIssueDate

PreflightIssueDate is mandatory. A single instance is required.

The date and time when the Preflight e-Document was issued.

RequestNumber

RequestNumber is optional. A single instance might exist.

A unique tracking number specifically identifying the InfoRequest e-Document to the originator. The tracking number is returned with the "information", the answer, to help match the answer to the request.

SenderParty

SenderParty is optional. A single instance might exist.

The business entity issuing the e-Document, the source of the document.

- The entity responsible for the content. If the sender party has outsourced the message service to a third party the SenderParty is the issuer of the e-Document and not the party performing the transmission service of the electronic message.

ReceiverParty

ReceiverParty is mandatory. A single instance.

The business entity for whom the e-Document is intended, the destination of the document.

- The entity interested in the content. If the receiver party has outsourced the message service to a third party the ReceiverParty is the intended party for the e-Document and not the party performing the receiving service of the electronic message.

BuyerParty

BuyerParty is mandatory. A single instance is required.

The legal entity to which the product is sold. Also commonly referred to as the sold-to party or customer. If no OtherParty is defined as the Payer, the Buyer is the Payer.

PreflightReference

PreflightReference is optional. Multiple instances might exist.

An element detailing relevant references pertaining to the Preflight as indicated by

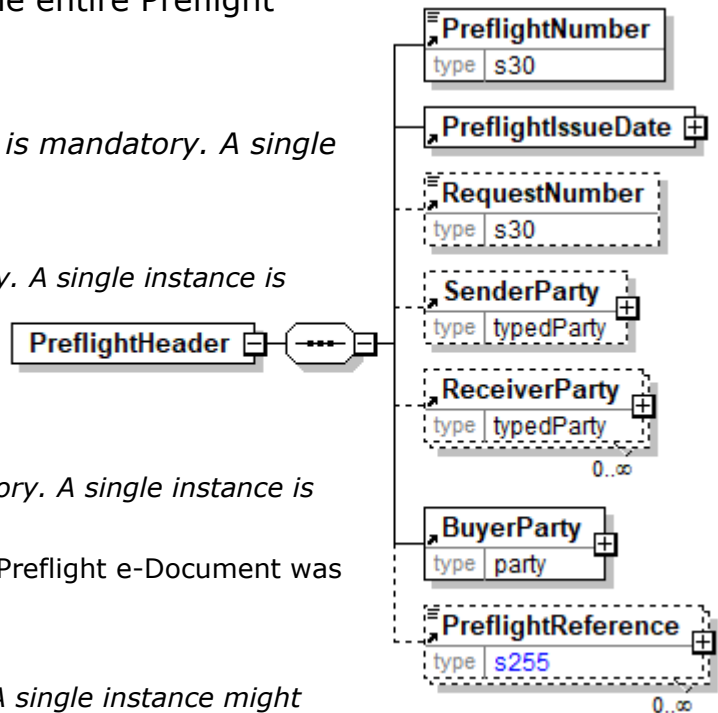

PreflightInformationDate

The date and time when the preflight process was performed.

(sequence)

The sequence of items below is mandatory. A single instance is required.

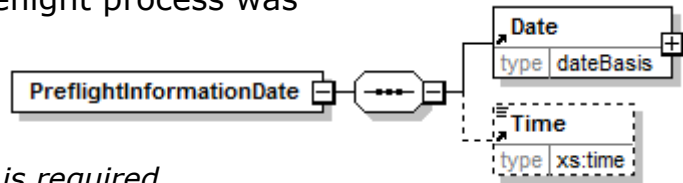

Date

Date is mandatory. A single instance is required.

A group element that contains the specification of Year, Month, and Day.

Time

Time is optional. A single instance might exist.

Times are treated in a standard XML fashion with a special case used to indicate a generalized "local" time. The standard XML approach to time is hh:mm:ss, hh:mm:ssZ, or hh:mm:ss±hh:mm.

- hh:mm:ss±hh:mm is used to represent a time with a time zone. The time zone is communicated as the number of hours offset from the Universal Time Coordinate (UTC), a.k.a. Greenwich Mean Time.
- hh:mm:ssZ indicates the time at Zulu (another name for UTC).
- hh:mm:ss or hh:mm indicates within papiNet the applicable local time where the associated event is taking place. Caution should be used when processing times of this nature as the papiNet approach may be in discord with other users of XML.

PreflightIssueDate

The date and time when the Preflight e-Document was issued.

(sequence)

The sequence of items below is mandatory. A single instance is required.

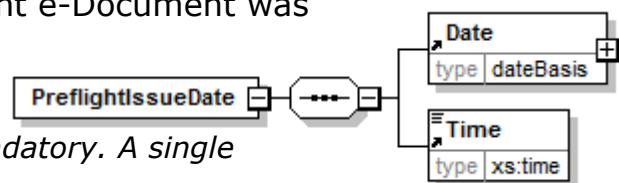

Date

Date is mandatory. A single instance is required.

A group element that contains the specification of Year, Month, and Day.

Time

Time is mandatory. A single instance is required.

Times are treated in a standard XML fashion with a special case used to indicate a generalized "local" time. The standard XML approach to time is hh:mm:ss, hh:mm:ssZ, or hh:mm:ss±hh:mm.

- hh:mm:ss±hh:mm is used to represent a time with a time zone. The time zone is communicated as the number of hours offset from the Universal Time Coordinate (UTC), a.k.a. Greenwich Mean Time.

papiNet V2R31

- hh:mm:ssZ indicates the time at Zulu (another name for UTC).
- hh:mm:ss or hh:mm indicates within papiNet the applicable local time where the associated event is taking place. Caution should be used when processing times of this nature as the papiNet approach may be in discord with other users of XML.

PreflightNumber

The unique identifier for the Preflight e-Document.

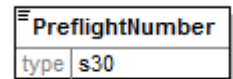

PreflightPrimaryStatus

A description of the highest level status pertaining to the item being reported: content file, Product or Purchase Order.

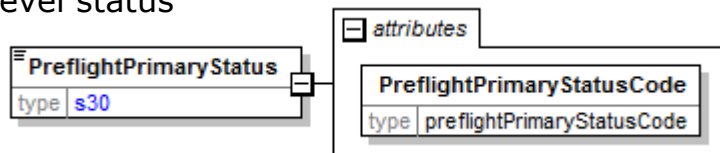

PreflightPrimaryStatusCode [attribute]

PreflightPrimaryStatusCode is mandatory. A single instance is required.

A code communicating the overall status of the PreflightPrimaryStatus.

Refer to PreflightPrimaryStatusCode definition for any enumerations.

PreflightPrimaryStatusCode [attribute]

A code communicating the overall status of the PreflightPrimaryStatus.

This item is restricted to the following list.

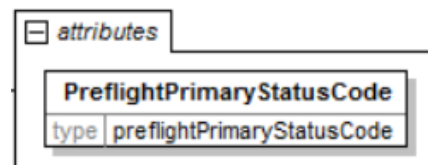

ActiveFree

Accepted or confirmed by the supplier and It is free for production.

ActiveHold

Accepted or confirmed by the supplier but It is not free for production.

Archived

Moved to long term storage.

Destroyed

No longer exists.

NotReceived

Not arrived at the destination.

Pending

Has not been accepted or rejected.

Received

Arrived at the destination.

Rejected

Cannot be used.

Staged

Positioned for production.

PreflightReference

An element detailing relevant references pertaining to the Preflight as indicated by PreflightReferenceType and AssignedBy.

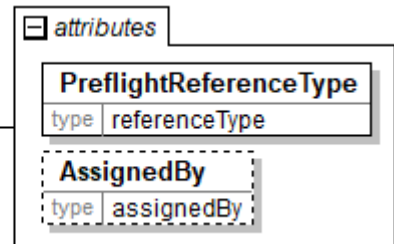
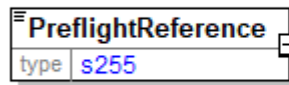

PreflightReferenceType [attribute]

PreflightReferenceType is mandatory. A single instance is required.

Provides a contextual explanation of the specific reference identifier. Many items are currently prefixed by "Buyer", "Forwarder", "Manufacturer", "Mill", "Seller", "Supplier", "Warehouse", or "Vendor". Check for an existing non-prefixed version and use the non-prefixed version instead. In the (yet to be announced release date) version 3.0 the prefixed versions will be removed. Instead the attribute @AssignedBy will communicate the information previously communicated in the prefix.

Refer to PreflightReferenceType definition for any enumerations.

AssignedBy [attribute]

AssignedBy is optional. A single instance might exist.

Identifies the type of party or the agency that has assigned the associated item, e.g. a reference of type OrderNumber.

Refer to AssignedBy for any enumerations.

PreflightReferenceType [attribute]

Provides a contextual explanation of the specific reference identifier. Many items are currently prefixed by "Buyer", "Forwarder", "Manufacturer", "Mill", "Seller", "Supplier", "Warehouse" or "Vendor". Check for an existing non-prefixed version and use the non-prefixed version instead. In the (yet to be announced release date) version 3.0 the prefixed versions will be removed. Instead the attribute AssignedBy will communicate the information previously communicated in the prefix.

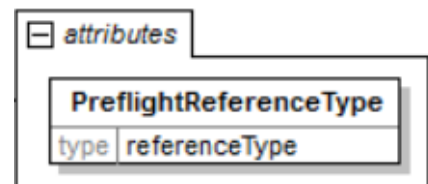

Refer to the [referenceType](#) entry for the list of enumerations and their definitions.

PreflightRequestDetail

A grouping element that provides the parameters to be used when responding with a Preflight e-Document.

PreflightRequestDetailType [attribute]



PreflightRequestDetailType is mandatory. A single instance is required.

Communicates the method in which the Preflight status should be summarized.

Refer to PreflightRequestDetailType definition for any enumerations.

(sequence)

The sequence of items below is mandatory. A single instance is required.

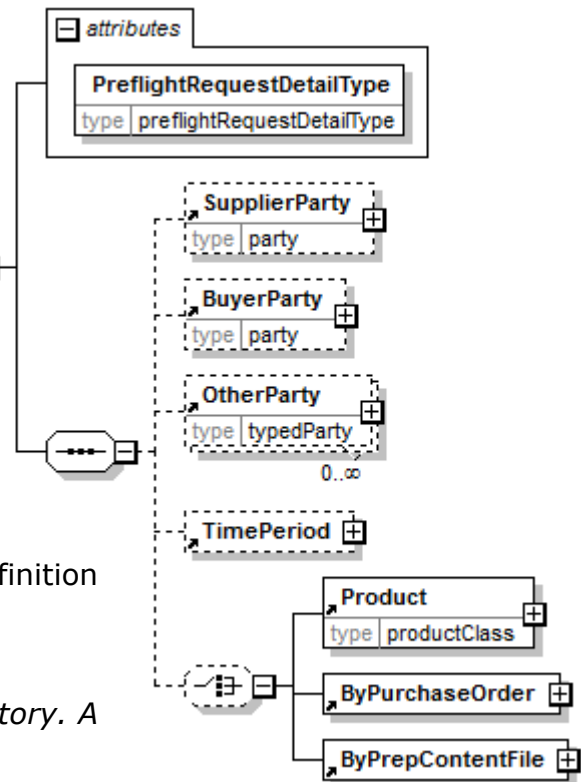

SupplierParty

SupplierParty is optional. A single instance might exist.

The organisation or business entity responsible for providing the product. SupplierParty is also the seller of the product, if Seller is not specified as OtherParty = Seller.

BuyerParty

BuyerParty is optional. A single instance might exist.

The legal entity to which the product is sold. Also commonly referred to as the sold-to party or customer. If no OtherParty is defined as the Payer, the Buyer is the Payer.

OtherParty

OtherParty is optional. Multiple instances might exist.

An organisation or business entity other than those specifically detailed within an e-Document.

TimePeriod

TimePeriod is optional. A single instance might exist.

The TimePeriod element is used to communicate a duration period of time as indicated in PeriodType.

(choice)

[choice] is optional. A single instance might exist.

Product

Product is mandatory. A single instance is required.

Product is a group item defining the article and its characteristics. Product is used to specify product characteristics organized by ProductIdentifier,

papiNet V2R31

ProductDescription, and Classification. Book Manufacturing, Label Stock, Paper, Pulp, Recovered Paper, Wood Products, and Virgin Fibre market segments have defined their product characteristics and conversion features for implementation in papiNet.

ByPurchaseOrder

ByPurchaseOrder is mandatory. A single instance is required.

Selection criteria for communicating purchase order information.

ByPrepContentFile

ByPrepContentFile is mandatory. A single instance is required.

Selection criteria for communicating prep content file information.

PreflightRequestDetailType [attribute]

Communicates the method in which the Preflight status should be summarized.

This item is restricted to the following list.

ByPrepContentFile

By prep content file.

ByProduct

By product

ByPurchaseOrder

By the PurchaseOrder the material was ordered.



PreflightSecondaryStatus

A description of the secondary status of the content file.

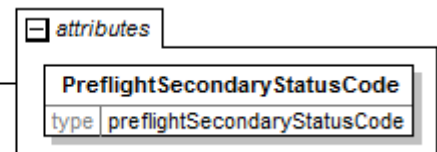
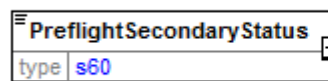

PreflightSecondaryStatusCode [attribute]

PreflightPrimaryStatusCode is mandatory. A single instance is required.

A code communicating the secondary status of the content file primarily used when the primary code is Pending or Rejected.

Refer to PreflightSecondaryStatusCode definition for any enumerations.

PreflightSecondaryStatusCode [attribute]

A code communicating the secondary status of the content file primarily used when the primary code is Pending or Rejected.

This item is restricted to the following list.

Corrupt

Contains errors or alterations.

GenericError

Error occurred.

Incorrect

Does not match the specification.

ProofApproval

Content file is validated before imagesetting or printing.

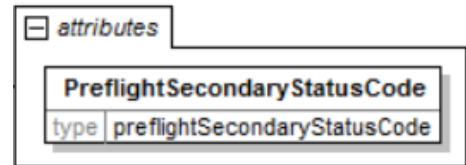

PreflightStatusInformation

The specifics about the status information being communicated for the Preflight.

(sequence)

The sequence of items below is mandatory. A single instance is required.

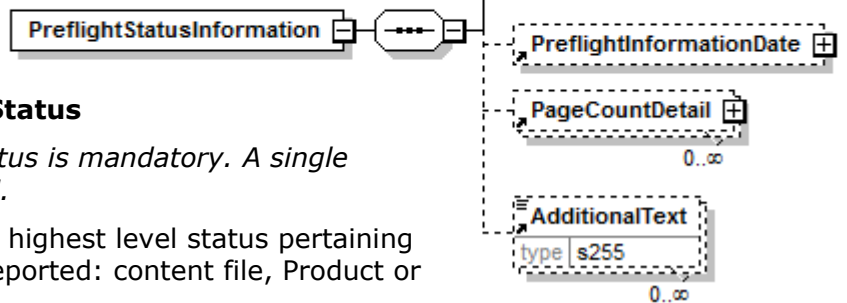

PreflightPrimaryStatus

PreflightPrimaryStatus is mandatory. A single instance is required.

A description of the highest level status pertaining to the item being reported: content file, Product or Purchase Order.

PreflightSecondaryStatus

PreflightSecondaryStatus is optional. Multiple instances might exist.

A description of the secondary status of the content file.

PreflightInformationDate

PreflightInformationDate is optional. A single instance might exist.

The date and time when the preflight process was performed.

PageCountDetail

PageCountDetail is optional. Multiple instances might exist.

A group element construct detailing the different types of page counts.

AdditionalText

AdditionalText is optional. Multiple instances might exist.

A text field that is used to communicate information not previously defined or for special instructions. To be used only for circumstances not covered by specific elements.

PrepContent

A grouping element containing information about the prep content file.

(sequence)

The sequence of items below is mandatory. A single instance is required.

PrepContentName

PrepContentName is mandatory. A single instance is required.

Name of the document or file that contains the content for the associated book or component.

PrepContentVersion

PrepContentVersion is optional. A single instance might exist.

Used to identify the version of the content file.

PrepReceivedDate

PrepReceivedDate is optional. A single instance might exist.

Used to identify the receipt date of the content file.

PressPrepInput

PressPrepInput is optional. A single instance might exist.

Element used to identify press preparation media and type of media required for input to the press component.

PreflightStatusInformation

PreflightStatusInformation is mandatory. A single instance is required.

The specifics about the status information being communicated for the Preflight.

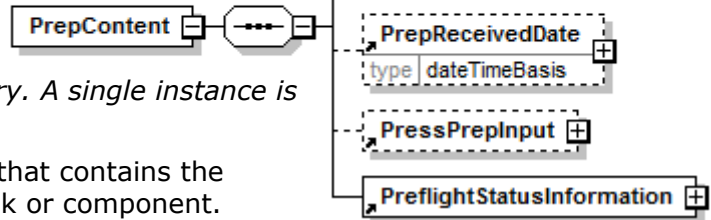

PrepContentDescription

A textual description of the prep content file.

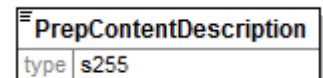

PrepContentName

Name of the document or file that contains the content for the associated book or component.

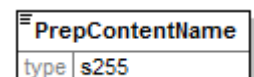

PrepContentOrderOfMatter

Group element used to identify all of the necessary sequencing and pagination requirements for the component.

(sequence)

The sequence of items below is mandatory. A single instance is required.

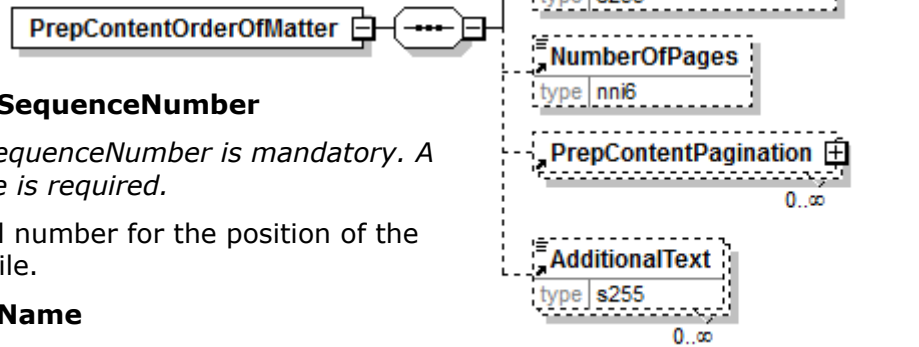

PrepContentSequenceNumber

PrepContentSequenceNumber is mandatory. A single instance is required.

The sequential number for the position of the prep content file.

PrepContentName

PrepContentName is mandatory. A single instance is required.

Name of the document or file that contains the content for the associated book or component.

PrepContentDescription

PrepContentDescription is optional. A single instance might exist.

A textual description of the prep content file.

NumberOfPages

NumberOfPages is optional. A single instance might exist.

The number of pages.

PrepContentPagination

PrepContentPagination is optional. Multiple instances might exist.

Group element used to identify all of the folio pagination.

AdditionalText

AdditionalText is optional. Multiple instances might exist.

A text field that is used to communicate information not previously defined or for special instructions. To be used only for circumstances not covered by specific elements.

PrepContentPaging

Group element used to identify all of the folio pagination.

FolioPosition [attribute]

FolioPosition is optional. A single instance might exist.

Indicator that the Folio is the first or last page in the associated prep content file.

Refer to FolioPosition definition for any enumerations.

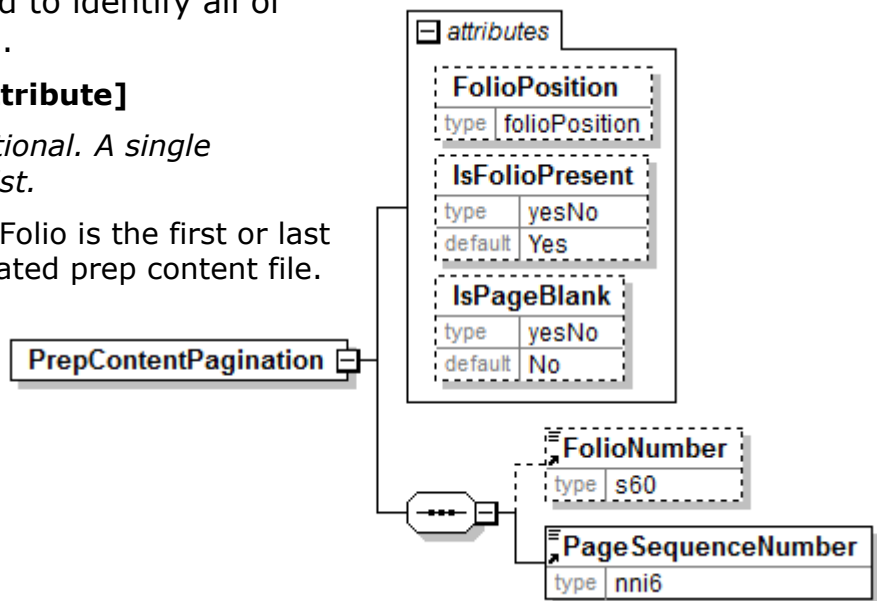

IsFolioPresent [attribute]

IsFolioPresent is optional. A single instance might exist.

Attribute that is used to indicate if the folio number is or is not present on the page.

Refer to IsFolioPresent definition for any enumerations.

IsPageBlank [attribute]

IsPageBlank is optional. A single instance might exist.

Attribute that is used to indicate if the page has been left blank intentionally.

Refer to IsPageBlank definition for any enumerations.

(sequence)

The sequence of items below is mandatory. A single instance is required.

FolioNumber

FolioNumber is optional. A single instance might exist.

The page number in a book that may not be the same as the sequential location of the page.

PageSequenceNumber

PageSequenceNumber is mandatory. A single instance is required.

The physical sequence of the page within the component.

PrepContentSequenceNumber

The sequential number for the position of the prep content file.

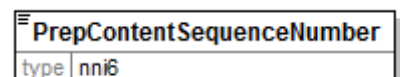

PrepContentVersion

Used to identify the version of the content file.

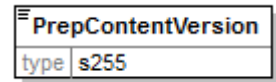

PrepDueDate

The preparation due date.

(sequence)

The sequence of items below is mandatory. A single instance is required.

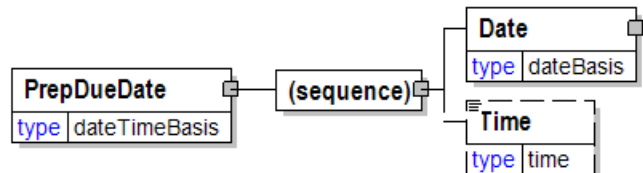

Date

Date is mandatory. A single instance is required.

A group element that contains the specification of Year, Month, and Day.

Time

Time is optional. A single instance might exist.

Times are treated in a standard XML fashion with a special case used to indicate a generalized "local" time. The standard XML approach to time is hh:mm:ss, hh:mm:ssZ, or hh:mm:ss±hh:mm.

hh:mm:ss±hh:mm is used to represent a time with a time zone. The time zone is communicated as the number of hours offset from the Universal Time Coordinate (UTC), a.k.a. Greenwich Mean Time.

hh:mm:ssZ indicates the time at Zulu (another name for UTC).

hh:mm:ss or hh:mm indicates within papiNet the applicable local time where the associated event is taking place. Caution should be used when processing times of this nature as the papiNet approach may be in discord with other users of XML.

PrepInformation

Information related to the preparation of the Book.

PrepType [attribute]

PrepType is optional. A single instance might exist.

The type of input for press preparation

Refer to PrepType definition for any enumerations.

(sequence)

The sequence of items below is mandatory. A single instance is required.

SupplierParty

SupplierParty is mandatory. A single instance is required.

The organisation or business entity responsible for providing the product. SupplierParty is also the seller of the product, if Seller is not specified as OtherParty = Seller.

PrepShipDate

PrepShipDate is optional. A single instance might exist.

The preparation ship date.

PrepDueDate

PrepDueDate is optional. A single instance might exist.

The preparation due date.

PrepNeededDate

PrepNeededDate is optional. A single instance might exist.

The preparations need date.

AdditionalText

AdditionalText is optional. Multiple instances might exist.

A text field that is used to communicate information not previously defined or for special instructions. To be used only for circumstances not covered by specific elements.

PrepReference

PrepReference is optional. Multiple instances might exist.

An element detailing relevant references pertaining to the preparation of a book or a book component. The type of reference is identified by the attributes PrepReferenceType and AssignedBy.

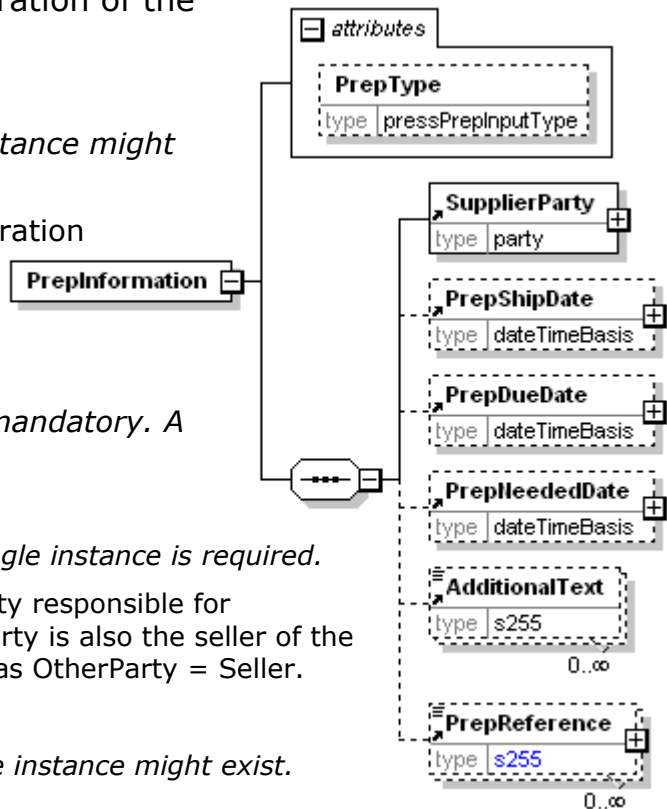

PrepNeededDate

The preparations need date.

(sequence)

The sequence of items below is mandatory. A single instance is required.

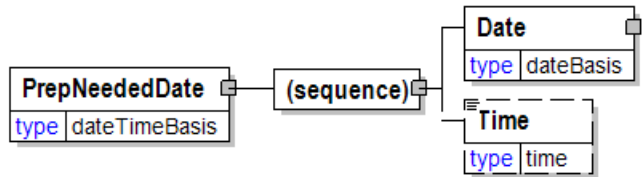

Date

Date is mandatory. A single instance is required.

A group element that contains the specification of Year, Month, and Day.

Time

Time is optional. A single instance might exist.

Times are treated in a standard XML fashion with a special case used to indicate a generalized "local" time. The standard XML approach to time is hh:mm:ss, hh:mm:ssZ, or hh:mm:ss±hh:mm.

hh:mm:ss±hh:mm is used to represent a time with a time zone. The time zone is communicated as the number of hours offset from the Universal Time Coordinate (UTC), a.k.a. Greenwich Mean Time.

hh:mm:ssZ indicates the time at Zulu (another name for UTC).

hh:mm:ss or hh:mm indicates within papiNet the applicable local time where the associated event is taking place. Caution should be used when processing times of this nature as the papiNet approach may be in discord with other users of XML.

PrepReceivedDate

Used to identify the receipt date of the content file.

(sequence)

The sequence of items below is mandatory. A single instance is required.

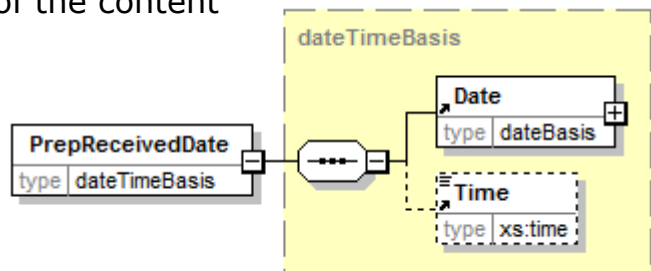

Date

Date is mandatory. A single instance is required.

A group element that contains the specification of Year, Month, and Day.

Time

Time is optional. A single instance might exist.

Times are treated in a standard XML fashion with a special case used to indicate a generalized "local" time. The standard XML approach to time is hh:mm:ss, hh:mm:ssZ, or hh:mm:ss±hh:mm.

- hh:mm:ss±hh:mm is used to represent a time with a time zone. The time zone is communicated as the number of hours offset from the Universal Time Coordinate (UTC), a.k.a. Greenwich Mean Time.
- hh:mm:ssZ indicates the time at Zulu (another name for UTC).
- hh:mm:ss or hh:mm indicates within papiNet the applicable local time where the associated event is taking place. Caution should be used when processing

times of this nature as the papiNet approach may be in discord with other users of XML.

PrepReference

An element detailing relevant references pertaining to the preparation of a book or a book component. The type of reference is identified by the attributes PrepReferenceType and AssignedBy.

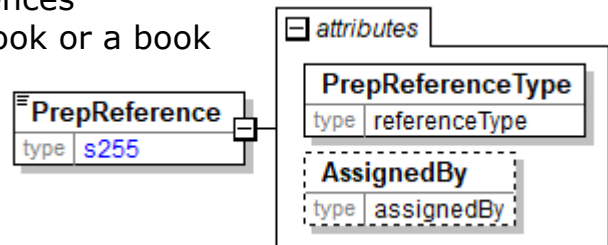

PrepReferenceType [attribute]

PrepReferenceType is mandatory. A single instance is required.

Provides a contextual explanation of the specific reference identifier. Many items are currently prefixed by "Buyer", "Forwarder", "Manufacturer", "Mill", "Seller", "Supplier", "Warehouse", or "Vendor". Check for an existing non-prefixed version and use the non-prefixed version instead. In the (yet to be announced release date) version 3.0 the prefixed versions will be removed. Instead the attribute @AssignedBy will communicate the information previously communicated in the prefix.

Refer to PrepReferenceType definition for any enumerations.

AssignedBy [attribute]

AssignedBy is optional. A single instance might exist.

Identifies the type of party or the agency that has assigned the associated item, e.g. a reference of type OrderNumber.

Refer to AssignedBy for any enumerations.

PrepReferenceType [attribute]

Provides a contextual explanation of the specific reference identifier. Many items are currently prefixed by "Buyer", "Forwarder", "Manufacturer", "Mill", "Seller", "Supplier", "Warehouse", or "Vendor". Check for an existing non-prefixed version and use the non-prefixed version instead. In the (yet to be announced release date) version 3.0 the prefixed versions will be removed. Instead the attribute @AssignedBy will communicate the information previously communicated in the prefix.

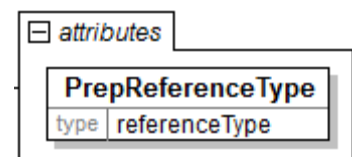

Refer to the [referenceType](#) entry for the list of enumerations and their definitions.

PrepShipDate

The preparation ship date.

(sequence)

The sequence of items below is mandatory. A single instance is required.

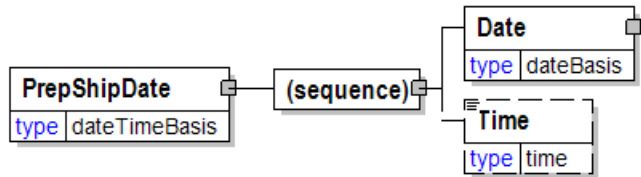

Date

Date is mandatory. A single instance is required.

A group element that contains the specification of Year, Month, and Day.

Time

Time is optional. A single instance might exist.

Times are treated in a standard XML fashion with a special case used to indicate a generalized "local" time. The standard XML approach to time is hh:mm:ss, hh:mm:ssZ, or hh:mm:ss±hh:mm.

hh:mm:ss±hh:mm is used to represent a time with a time zone. The time zone is communicated as the number of hours offset from the Universal Time Coordinate (UTC), a.k.a. Greenwich Mean Time.

hh:mm:ssZ indicates the time at Zulu (another name for UTC).

hh:mm:ss or hh:mm indicates within papiNet the applicable local time where the associated event is taking place. Caution should be used when processing times of this nature as the papiNet approach may be in discord with other users of XML.

PrepType [attribute]

The type of input for press preparation

This item is restricted to the following list.

4PageImposedFilm

8PageImposedFilm

ApplicationFiles

Bookmap

CameraCopy

CopyBook

DuplicateStrip

ElectronicFiles

ElectronicGraphic

Film

FilmPageNegatives

FilmPagePositives

IllustrationFilm

NegativeImposedPlateMakingFilm

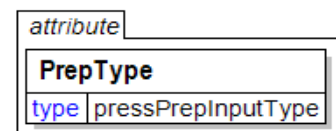

Originals
OriginalArt
Other
Overtakes
PageProof
PDF
PositiveImposedPlateMakingFilm
RachwalFilm
ReflectiveArtBoard
ReproProof
RestripSuppliedFlats
TearSheet
Transparencies

PressBreakLocation

The specific location identified within a printing press.

LocationType [attribute]

LocationType is mandatory. A single instance is required.

Location of Break on the Press. A group item detailing relevant locations on the press to the Performance e-Document.

Refer to LocationType definition for any enumerations.

FloorLocationType [attribute]

FloorLocationType is optional. A single instance might exist.

Floor Location Type

Refer to FloorLocationType definition for any enumerations.

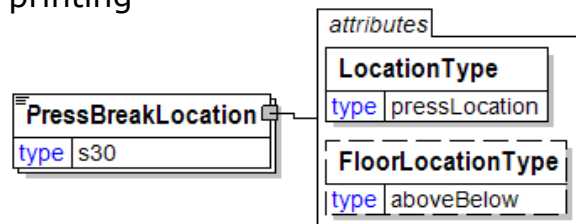

PressComponent

Press Component.

BarcodeSuppliedByPublisher [attribute]

BarcodeSuppliedByPublisher is optional. A single instance might exist.

Barcode supplied by publisher

Refer to

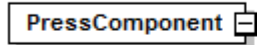

BarcodeSuppliedByPublisher definition for any enumerations.

(sequence)

The sequence of items below is mandatory. A single instance is required.

NumberOfPages

NumberOfPages is optional. A single instance might exist.

The number of pages.

Signatures

Signatures is optional. Multiple instances might exist.

Signatures.

PressPrep

PressPrep is optional. A single instance might exist.

Press preparation information

ManufacturingSpecifications

ManufacturingSpecifications is optional. A single instance might exist.

Manufacturing specifications.

Halftones

Halftones is optional. A single instance might exist.

Halftones are images made up of a series of dots in a specific pattern that simulates the look of a continuous tone image.

Length

Length is optional. A single instance might exist.

The length of the object.

Width

Width is optional. A single instance might exist.

The width of the object.

LineCuts

LineCuts is optional. A single instance might exist.

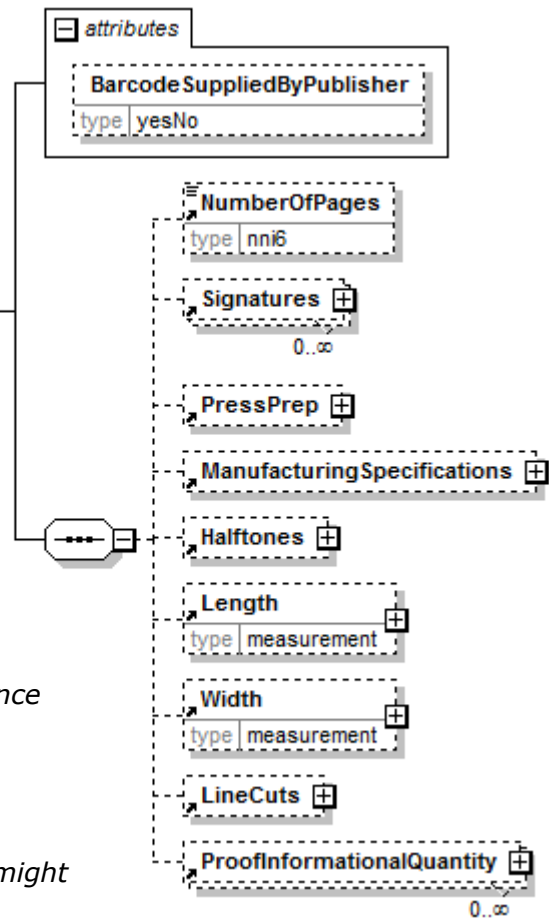

papiNet V2R31

A print obtained from a line drawing.

ProofInformationalQuantity

ProofInformationalQuantity is optional. Multiple instances might exist.

ProofInformationalQuantity.

PressConditions

Construct contains environmental conditions of the press during operations

(sequence)

The sequence of items below is mandatory. A single instance is required.

Humidity

Humidity is optional. Multiple instances might exist.

Humidity

AmbientTemperature

AmbientTemperature is optional. Multiple instances might exist.

The temperature of the surrounding environment.

MachineSpeed

MachineSpeed is optional. Multiple instances might exist.

The rate at which the machine is, was, or should be running.

Impressions

Impressions is optional. Multiple instances might exist.

The work produced by one revolution of the printing cylinder or unit.

Tension

Tension is optional. Multiple instances might exist.

Tension of the web on the printing press.

Alignment

Alignment is optional. Multiple instances might exist.

A measurement of how the reel is aligned on printing press

PrintUnit

PrintUnit is optional. Multiple instances might exist.

PrintUnit identifies the unique qualities associated with the individual unit of the printing press.

PressFormType

PressFormType is optional. A single instance might exist.

Description of press form, expressed as deliveries and number of pages in the signature being printed, e.g. 2X16, 4X4.

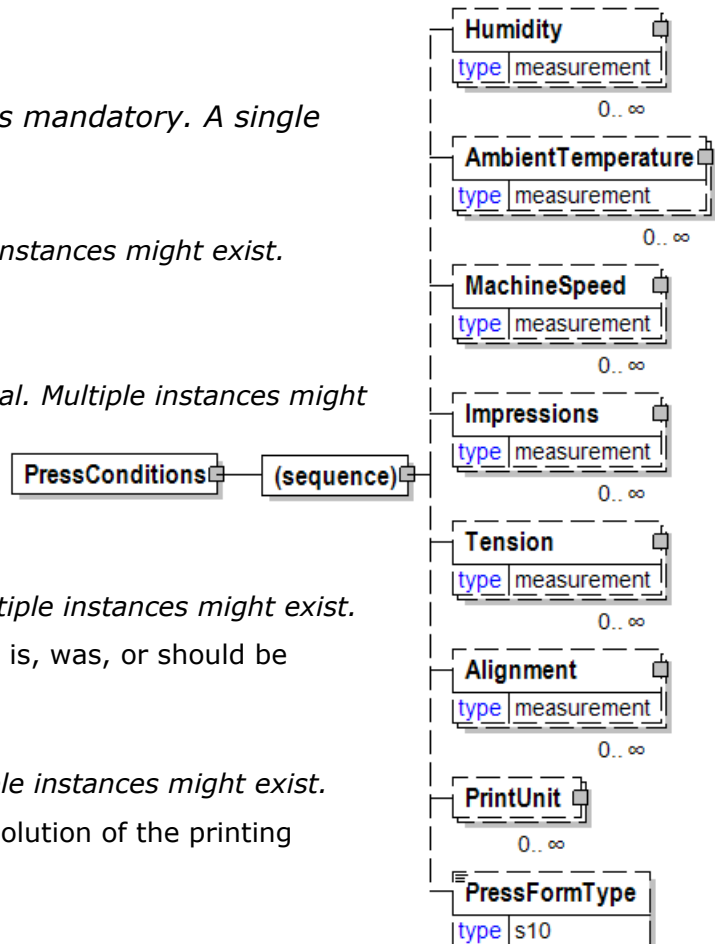

PressFormType

Description of press form, expressed as deliveries and number of pages in the signature being printed, e.g. 2X16, 4X4.

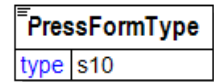

PressImpositionType [attribute]

The type of press imposition

This item is restricted to the following list.

HeadToHead

FootToFoot

HeadToFoot

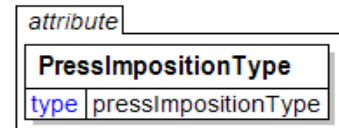

PressPrep

Press preparation information

PressPrepOutputType [attribute]

PressPrepOutputType is optional. A single instance might exist.

The press prep output type.

Refer to PressPrepOutputType definition for any enumerations.

(sequence)

The sequence of items below is mandatory. A single instance is required.

PressPrepInput

PressPrepInput is mandatory. One instance is required, multiple instances might exist.

Element used to identify press preparation media and type of media required for input to the press component.

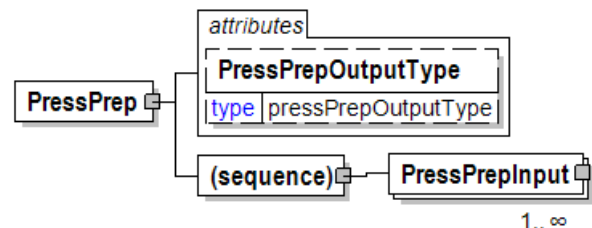

PressPrepInput

Element used to identify press preparation media and type of media required for input to the press component.

MediaType [attribute]

MediaType is optional. A single instance might exist.

The type of media

Refer to MediaType definition for any enumerations.

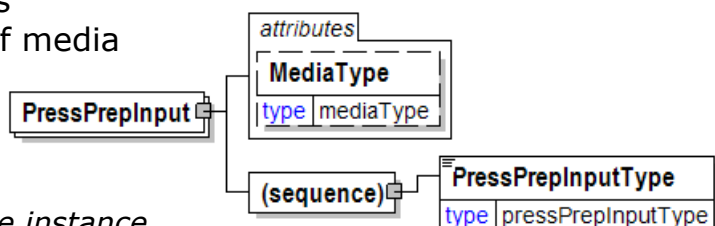

(sequence)

The sequence of items below is mandatory. A single instance is required.

PressPrepInputType

PressPrepInputType is mandatory. A single instance is required.

Press prep input type

Refer to PressPrepInputType definition for any enumerations.

PressPrepInputType

Press prep input type

This item is restricted to the following list.

PressPrepInputType	
type	pressPrepInputType

4PageImposedFilm

8PageImposedFilm

ApplicationFiles

Bookmap

CameraCopy

CopyBook

DuplicateStrip

ElectronicFiles

ElectronicGraphic

Film

FilmPageNegatives

FilmPagePositives

IllustrationFilm

NegativeImposedPlateMakingFilm

Originals

OriginalArt

Other

Overtakes

PageProof

PDF

PositiveImposedPlateMakingFilm

RachwalFilm

ReflectiveArtBoard

ReproProof

RestripSuppliedFlats

TearSheet

Transparencies

PressPrepOutputType [attribute]

The press prep output type.

This item is restricted to the following list.

DirectToFilm
DirectToPlate
DirectToPress
Film

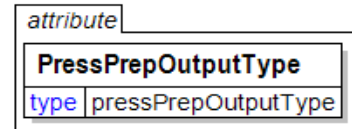

PressType [attribute]

The type of press used.

This item is restricted to the following list.

Cameron

A type of belt press that both prints and binds a book.

ColdsetOffset

An offset printing method suitable for newspapers, in other words, ink dries by penetration into the paper.

Digital

Digital print process that uses electronic files in print production.

DigitalInkJet.

Digital print process that uses inkjet technology.

DigitalToner

Digital print process that uses toner technology.

Electronic

Any technology that reproduces pages without the use of traditional ink, water, chemistry, or plates; also known as plateless printing.

Flexographic

A type of printing that uses rubber printing plates.

Gravure

A method of printing in which the image is etched into the printing plates, as opposed to letterpress printing, in which the image is slightly raised from the rest of the plate. Gravure printing produces consistent quality in long production runs.

HeatsetOffset

An offset printing method.

LetterPress

The oldest printing method, in which the image to be printed is raised from the plate, inked, and applied directly to paper.

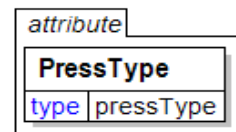

Offset

Use this option when you do not wish to designate which type of offset press approach to use, just that offset printing is the preferred printing method.

SheetFed

A type of printing press that accepts paper in the form of sheets.

SilkScreen

A printing method in which ink is pushed through a stencil, used for imprinting T-shirts and heavier paper stocks.

Web

A printing press that uses rolls (webs) of paper rather than sheets. Also called web-fed press.

PressureTreatment

Method and parameter values of pressure treatment.

(sequence)

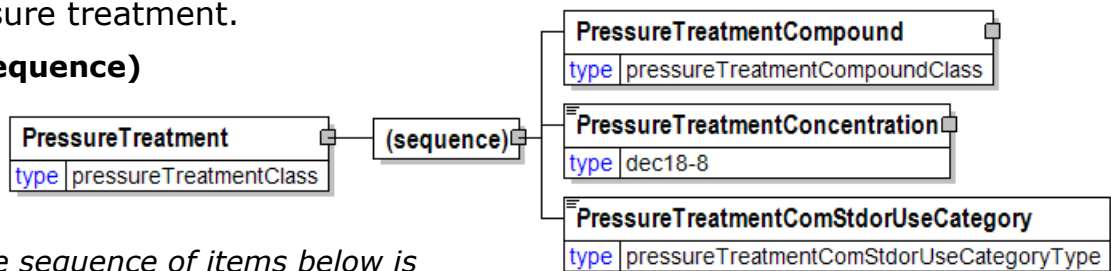

The sequence of items below is mandatory. A single instance is required.

PressureTreatmentCompound

PressureTreatmentCompound is mandatory. A single instance is required.

The substance used for pressure treatment.

PressureTreatmentConcentration

PressureTreatmentConcentration is mandatory. A single instance is required.

Retained concentration of preservative chemical.

PressureTreatmentComStdorUseCategory

PressureTreatmentComStdorUseCategory is mandatory. A single instance is required.

Pressure treatment compound standard or use category

Refer to PressureTreatmentComStdorUseCategory definition for any enumerations.

PressureTreatmentCompound

The substance used for pressure treatment.

CompoundType [attribute]

CompoundType is optional. A single instance might exist.

Defines the type of chemical treatment used.

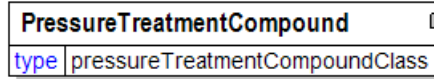

CompoundAgency [attribute]

CompoundAgency is optional. A single instance might exist.

The agency responsible for the compound coding. Defines the trade name of the treatment.

(sequence)

The sequence of items below is mandatory. A single instance is required.

Value

Value is optional. A single instance might exist.

A numeric value expressed in the unit of measure (UOM).

AdditionalText

AdditionalText is optional. Multiple instances might exist.

A text field that is used to communicate information not previously defined or for special instructions. To be used only for circumstances not covered by specific elements.

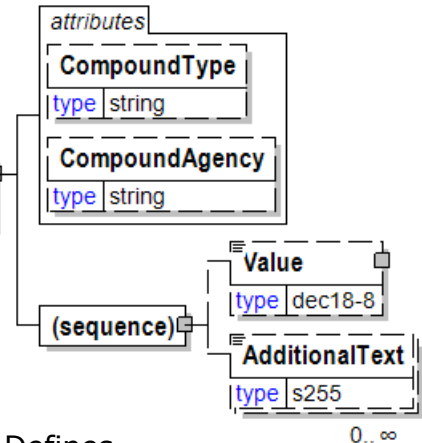

PressureTreatmentComStdorUseCategory

Pressure treatment compound standard or use category

This item is restricted to the following list.

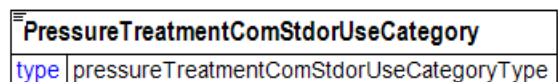

- C2**
- C3**
- C4**
- C5**
- C6**
- C9**
- C11**
- C14**
- C15**
- C17**
- C18**

C20

C22

C23

C24

C25

C27

C28

C29

C30

C31

C32

C33

C34

C35

N1

N2

UC2

UC3A

UC3B

UC4A

UC4B

UC4C

UC5A

UC5B

UC5C

UCFA

UCFB

PressureTreatmentConcentration

Retained concentration of preservative chemical.

UOM [attribute]

UOM is optional. A single instance might exist.

PressureTreatmentConcentration	
type	dec18-8

attributes	
UOM	
type	uOM

Defines the unit of measure for the value.

Refer to UOM definition for any enumerations.

PriceAdjustment

A group item defining a deviation from the PricePerUnit.

(sequence)

The sequence of items below is mandatory. A single instance is required.

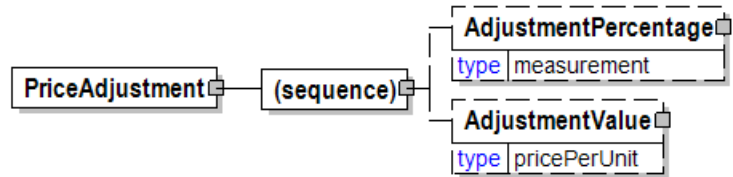

AdjustmentPercentage

AdjustmentPercentage is optional. A single instance might exist.

A percentage, either negative or positive, that is applied to either the price, or a starting amount to determine the value of the particular MonetaryAdjustment.

AdjustmentValue

AdjustmentValue is optional. A single instance might exist.

A group element that contains a currency value, either positive or negative, and a measurement value (in other words a price per unit structure) that will be used in the price adjustment AdjustmentValue.

PriceAndAmountInfo

A grouping element that contains information about price and amounts.

(sequence)

The sequence of items below is mandatory. A single instance is required.

BaseAmountInfo

BaseAmountInfo is optional. A single instance might exist.

A grouping element that contains information about price and base amount without any taxes.

QuantityInformation

QuantityInformation is optional. A single instance might exist.

A group item containing information about quantity and informational quantity of similar items.

MonetaryAdjustment

MonetaryAdjustment is optional. Multiple instances might exist.

The element containing the information necessary for the understanding, calculation, and treatment of an adjustment to a currency amount. MonetaryAdjustment contains an attribute that indicates they type of adjustment being communicated.

ChargeInformation

ChargeInformation is optional. Multiple instances might exist.

A group element that contains elements that describe a charge. ChargeInformation

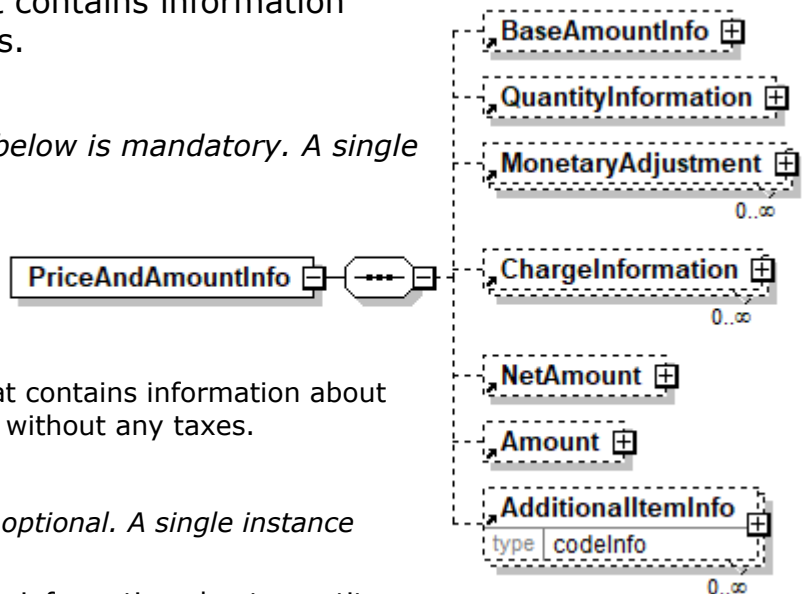

is used when charge details need to be specified by using a code assigned by an agency. It is typically used for freight costs and other costs related to the supply chain.

NetAmount

NetAmount is optional. A single instance might exist.

An element that contains the net amount excluding tax. NetAmount encapsulates CurrencyValue.

Amount

Amount is optional. A single instance might exist.

An element that contains the amount including tax. The Amount encapsulates CurrencyValue.

AdditionalItemInfo

AdditionalItemInfo is optional. Multiple instances might exist.

A grouping element that contains information about additional items specified by an agency. Restricted use of this element is recommended.

PriceDetails

An element that groups together price information.

PriceQuantityBasis [attribute]

PriceQuantityBasis is mandatory. A single instance is required.

The basis for the determination of the price.

Refer to PriceQuantityBasis definition for any enumerations.

PriceTaxBasis [attribute]

PriceTaxBasis is optional. A single instance might exist.

This price provides the basis for tax.

Refer to PriceTaxBasis definition for any enumerations.

(sequence)

The sequence of items below is mandatory. A single instance is required.

PricePerUnit

PricePerUnit is mandatory. A single instance is required.

PricePerUnit is an element designed to support flexibility in price representation.

This structure is read as CurrencyValue per MeasurementValue, or alternatively CurrencyValue per number of UOM(s).

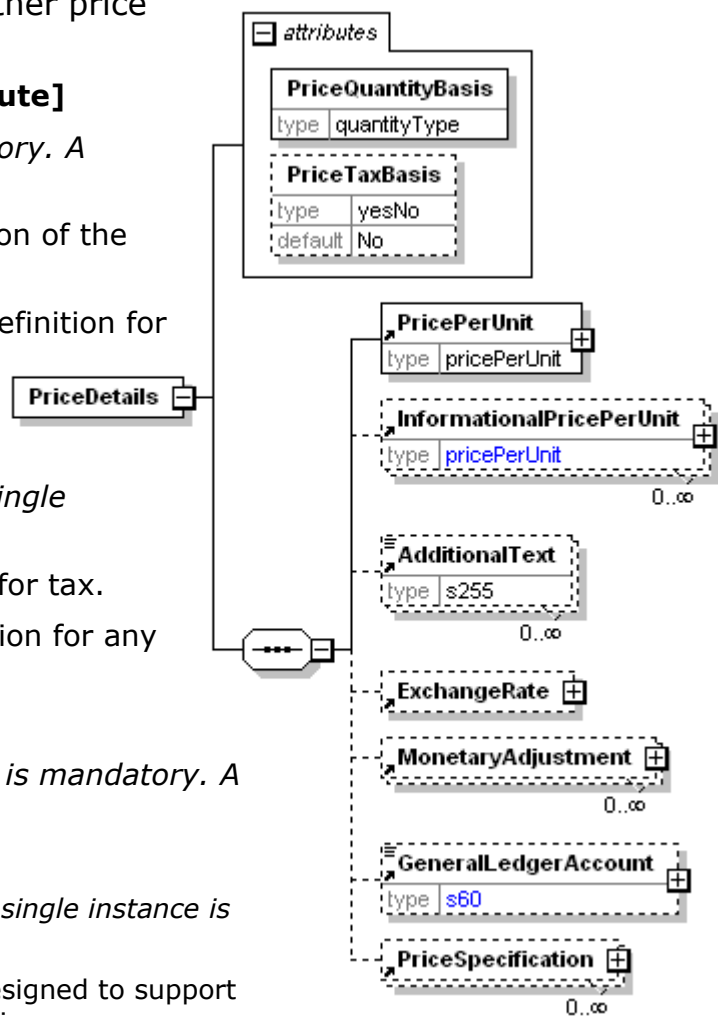

papiNet V2R31

InformationalPricePerUnit

InformationalPricePerUnit is optional. Multiple instances might exist.

A group item containing a currency value and a measurement value used convey a secondary PricePerUnit. For example, where PricePerUnit is dollars per ton. InformationalPricePerUnit could be dollars per kilogram.

AdditionalText

AdditionalText is optional. Multiple instances might exist.

A text field that is used to communicate information not previously defined or for special instructions. To be used only for circumstances not covered by specific elements.

ExchangeRate

ExchangeRate is optional. A single instance might exist.

The exchange rate as of the date included in the element.

MonetaryAdjustment

MonetaryAdjustment is optional. Multiple instances might exist.

The element containing the information necessary for the understanding, calculation, and treatment of an adjustment to a currency amount. MonetaryAdjustment contains an attribute that indicates they type of adjustment being communicated.

GeneralLedgerAccount

GeneralLedgerAccount is optional. A single instance might exist.

The general ledger account to be referenced for the item.

PriceSpecification

PriceSpecification is optional. Multiple instances might exist.

A grouping element that specifies what is included in the price.

PricePerUnit

PricePerUnit is an element designed to support flexibility in price representation.

This structure is read as CurrencyValue per MeasurementValue, or alternatively CurrencyValue per number of UOM(s).

(sequence)

The sequence of items below is mandatory. A single instance is required.

CurrencyValue

CurrencyValue is mandatory. A single instance is required.

The amount in the referenced currency as defined by the CurrencyType attribute.

Value

Value is mandatory. A single instance is required.

A numeric value expressed in the unit of measure (UOM).

RangeMin

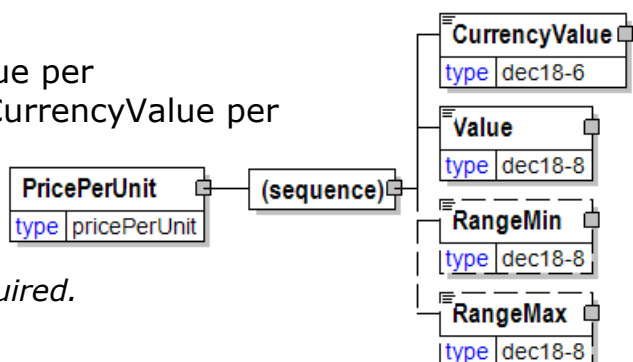

papiNet V2R31

RangeMin is optional. A single instance might exist.

The minimum value (lower boundary) allowed for the Measurement that is the parent of this element.

RangeMax

RangeMax is optional. A single instance might exist.

The maximum value (upper boundary) allowed for the Measurement that is the parent of this element. Some elements use the RangeMax element with an extended list of unit of measures. (Note: the red colour in the picture is an artifact of how the graphic was captured and should be disregarded.)

PriceQuantityBasis [attribute]

The basis for the determination of the price.

This item is restricted to the following list.

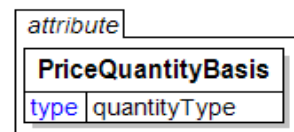

ActualVolume

Actual product space.

AirDryWeight

Contains a normal amount of moisture.

Area

A number that represents the length multiplied by the width is being communicated.

BoneDry

Contains insignificant moisture.

Count

The number of items.

Distance

The quantity being communicated is a distance.

GrossWeight

The weight including all packaging and furnishing. The gross weight of the deliveries includes tare weight.

Energy

The quantity represents energy content.

Length

The length of the object.

LogisticsGrossWeight

The weight of the vehicle including transport units before unloading goods at a delivery destination.

LogisticsNetWeight

The weight of the vehicle including transport units after unloading goods delivered to a delivery destination. The transport units can be empty or can contain goods when co-loading is used to subsequent delivery destinations.

papiNet V2R31

LogPileGrossVolume

To be deprecated in a future version V3R00. Should not be used in new implementations.

LogPileVolume

The volume of a pile of logs, including gaps. The product specification defines what is included in this volume, for example if rejects or other deductions are included or not.

NetWeight

The net weight of the product is being used, does not include tare weights. May include certain conversion components.

NetNetWeight

The net weight of the product without any packaging or conversion materials. Note: In Forest Wood Supply business the product specification defines what is included in this net weight, for example if rejects or other deductions are included or not.

NominalWeight

A calculated weight that is derived from another measurement. For example, the length of paper multiplied by the specified basis weight could be used to derive a nominal weight.

Percent

The number being communicated is a percentage.

RunningLength

The length of the reel.

ShortLengthVolume

SolidWoodGrossVolume

To be deprecated in a future version V3R00. Should not be used in new implementations.

SolidWoodVolume

The volume of logs, stems, chips, etc. without bark and gaps. The product specification defines what is included in this volume, for example if rejects or other deductions are included or not.

TareWeight

The weight of the previously agreed to packaging and furnishing.

Time

The number being communicated represents an amount of time.

TippedLooseGrossVolume

To be deprecated in a future version V3R00. Should not be used in new implementations.

TippedLooseVolume

The volume of tipped loose content, including gaps. Often used as a quantity type for piles of chips, sawdust, etc. The product specification defines what is

papiNet V2R31

included in this volume, for example if rejects or other deductions are included or not.

Volume

WoodGrossVolume

To be deprecated in a future version V3R00. Should not be used in new implementations.

WoodVolume

The volume of logs, stems, chips, etc. without gaps but including bark. The product specification defines what is included in this volume, for example if rejects or other deductions are included or not.

PriceSpecification

A grouping element that specifies what is included in the price.

(sequence)

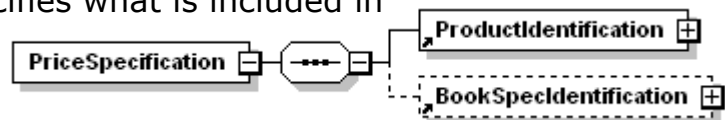

The sequence of items below is mandatory. A single instance is required.

ProductIdentification

ProductIdentification is mandatory. A single instance is required.

A grouping element designed to communicate product identification related to the parent element that contains this item.

BookSpecIdentification

BookSpecIdentification is optional. A single instance might exist

A grouping element that contains information identifying a book specification.

PriceTaxBasis [attribute]

This price provides the basis for tax.

This item is restricted to the following list.

Yes

No

PriceTaxBasis	
type	yesNo
default	No

PrintedMediaSpecs

Printed media specifications

Perforated [attribute]

Perforated is optional. A single instance might exist.

Either "Yes" or "No".

Refer to Perforated definition for any enumerations.

Scored [attribute]

Scored is optional. A single instance might exist.

Is this item scored?

Refer to Scored definition for any enumerations.

Folded [attribute]

Folded is optional. A single instance might exist.

Either "Yes" or "No".

Refer to Folded definition for any enumerations.

Collated [attribute]

Collated is optional. A single instance might exist.

Either "Yes" or "No".

Refer to Collated definition for any enumerations.

RoundCornered [attribute]

RoundCornered is optional. A single instance might exist.

Is the item round cornered?

Refer to RoundCornered definition for any enumerations.

Drilled [attribute]

Drilled is optional. A single instance might exist.

Either "Yes" or "No".

Refer to Drilled definition for any enumerations.

DieCut [attribute]

DieCut is optional. A single instance might exist.

Either "Yes" or "No".

Refer to DieCut definition for any enumerations.

(sequence)

The sequence of items below is mandatory. A single instance is required.

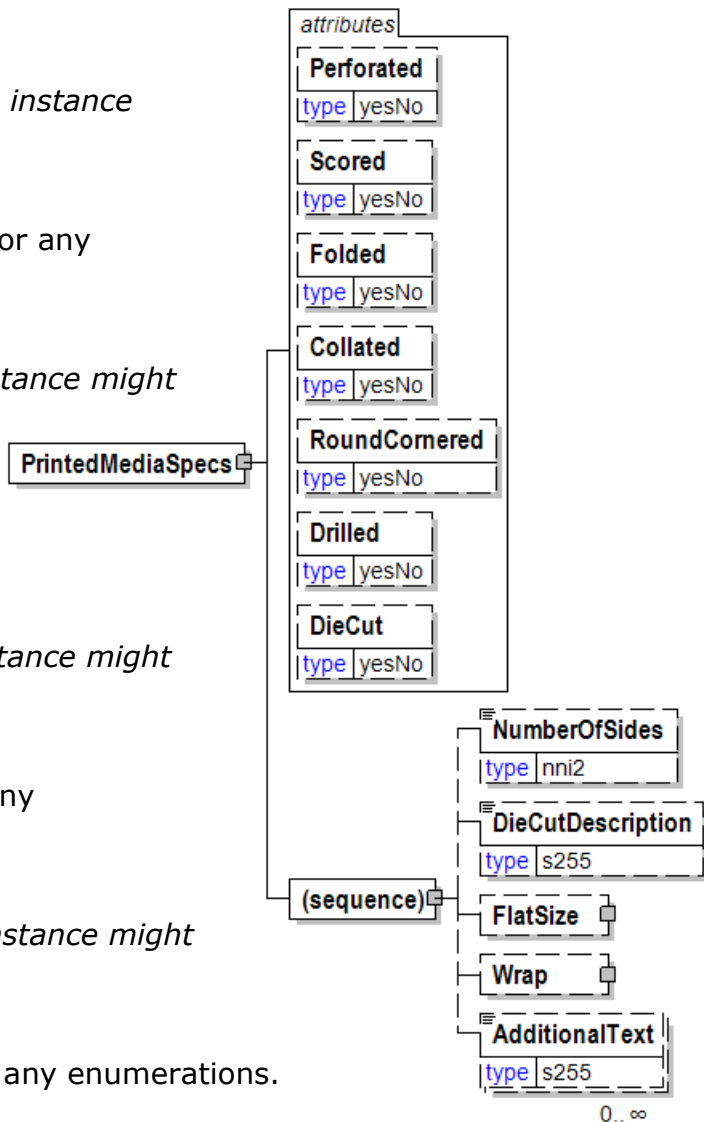

papiNet V2R31

NumberOfSides

NumberOfSides is optional. A single instance might exist.

The number of sides.

DieCutDescription

DieCutDescription is optional. A single instance might exist.

Die cut description

FlatSize

FlatSize is optional. A single instance might exist.

Flat size

Wrap

Wrap is optional. A single instance might exist.

A group item that organises wrapping detail information.

AdditionalText

AdditionalText is optional. Multiple instances might exist.

A text field that is used to communicate information not previously defined or for special instructions. To be used only for circumstances not covered by specific elements.

PrintingMaterials

Printing materials information.

(sequence)

The sequence of items below is mandatory. A single instance is required.

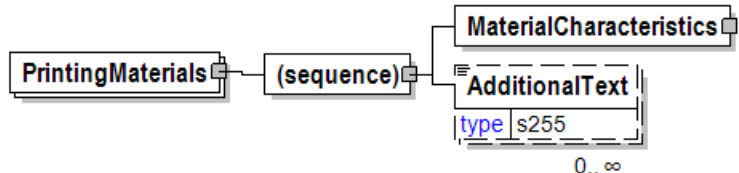

MaterialCharacteristics

MaterialCharacteristics is mandatory. A single instance is required.

Material characteristics.

AdditionalText

AdditionalText is optional. Multiple instances might exist.

A text field that is used to communicate information not previously defined or for special instructions. To be used only for circumstances not covered by specific elements.

PrintParameters

PrintParameters is optional. The set up parameters of how a print machine or print job is within this construct.

PrintType [attribute]

Defines the printing method.

PrintType is optional. A single instance might exist.

Refer to PrintType definition for any enumerations.

(sequence)

The sequence of items below is mandatory. A single instance is required.

WebConfiguration

WebConfiguration is optional. A single instance might exist.

The way the web runs through the press.

Webbing

Webbing is optional. A single instance might exist.

The webbing that is used in the printing process.

InkDelivery

InkDelivery is optional. A single instance might exist.

The delivery mechanism used in the printing process.

PasteDiameter

PasteDiameter is optional. A single instance might exist.

The diameter measurement of a reel when a new reel of paper is glued or pasted to it to continue running.

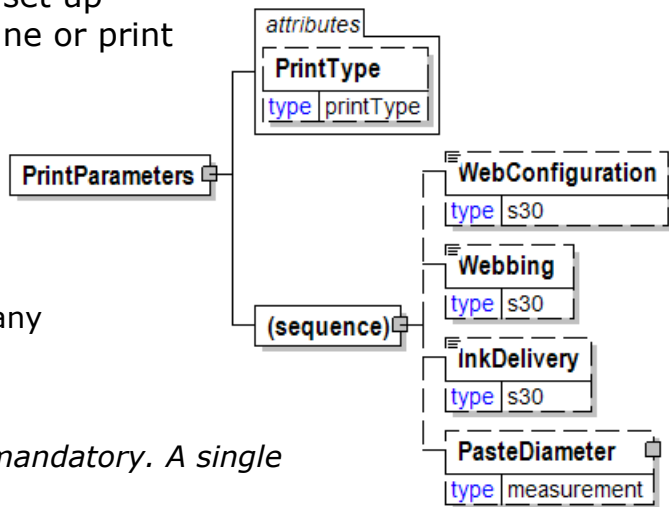

PrintType [attribute]

Defines the printing method.

This item is restricted to the following list.

ColdsetOffset

An offset printing method suitable for newspapers, in other words, ink dries by penetration into the paper.

ContinuousForms

An offset printing method, generally without a hot drying section and suitable for reels.

Digital

An electrostatic printing method, typically a large black-and-white or multicolour printer/copier.

Flexography

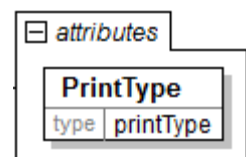

papiNet V2R31

A special printing method, which is a follow-up of letter print with advanced print cylinder surface. Suitable for sheets.

FoilPrint

A special printing/finishing method suitable for foils through embossed print plate/cylinder; flat/flat, or circle/flat (form to sheet).

Forms

An offset printing method, generally without a hot drying section and suitable for sheets.

Gravure

A standard printing method with embossed print cylinders. Suitable for sheets.

HeatsetOffset

An offset printing method.

InkJet

An inkjet printing method, typically a large black-and-white or multicolour printer.

InstantOffset

A standard flat printing method (for example, wet offset, or waterless offset) suitable for small print orders and small sheet sizes (for example, max. DIN A3).

Laser

A laser-based printing method, typically a large black-and-white or multicolour printer/copier.

Letterpress

A special printing method suitable for books or newspapers (old style) with advanced letters. Suitable for sheets.

LightPrint

- A printing method similar to a facsimile print, a photo-like print with a specific prepared cylinder surface on photo basis or an artificial print.

MiniWeb

A digital printing method suitable for reels less than 20 inch wide.

RotoFlexography

RotoGravure

RotoLetterpress

RotoSilkScreen

SheetfedOffset

SilkScreen

WebOffset

PrintUnit

PrintUnit identifies the unique qualities associated with the individual unit of the printing press.

PrintUnitType [attribute]

PrintUnitType is optional. A single instance might exist.

Print UnitT ype

Refer to PrintUnitType definition for any enumerations.

(sequence)

The sequence of items below is mandatory. A single instance is required.

PrintUnitNumber

PrintUnitNumber is mandatory. A single instance is required.

The number of the print unit.

Ink

Ink is optional. Multiple instances might exist.

A grouping element that describes the ink used in the process.

Blanket

Blanket is optional. Multiple instances might exist.

Blanket is a group element that contains elements that describe this component of the printing process.

Plate

Plate is optional. Multiple instances might exist.

The image carrying medium.

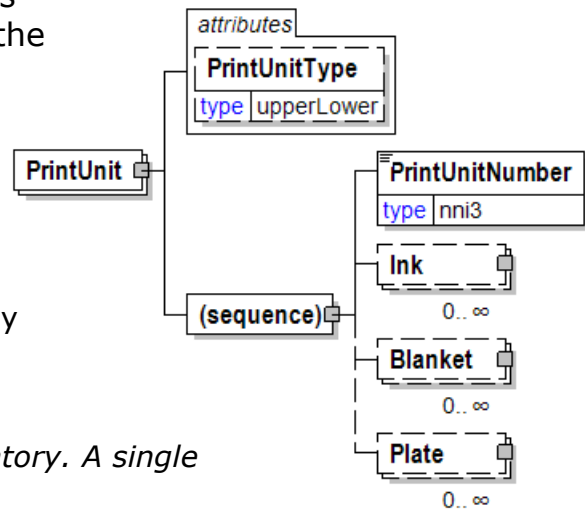

PrintUnitNumber

The number of the print unit.

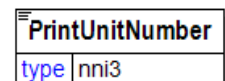

PrintUnitType [attribute]

Print UnitT ype

This item is restricted to the following list.

Upper

Lower

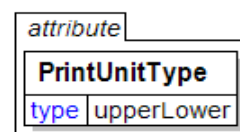

PrioritisedMeasuringType [attribute]

Attribute PrioritisedMeasuringType is used for specifying a measuring type as an alternative measuring type, when alternative measuring types are allowed to be used. The enumeration value of attribute PrioritisedMeasuringType specifies which measuring type is prioritised of the alternative measuring types.

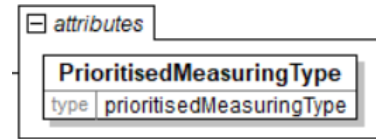

This item is restricted to the following list.

ByItem

ByItem is the prioritised measuring type of the alternative measuring types.

ByLoad

ByLoad is the prioritised measuring type of the alternative measuring types.

ByPackage

ByPackage is the prioritised measuring type of the alternative measuring types.

PriorityOrder [attribute]

Specifies the priority order of the item as a two digit positive integer. Value 1 is the highest priority.

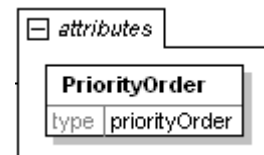

ProcessingCode

A code defining processing details for a product.

Agency [attribute]

Agency is mandatory. A single instance is required.

Describes the agency maintaining the list of codes. To be included in this list the agency must be a recognized standards body or industry organisation.

- For the element that owns this attribute.
- For another attribute in the list of attributes associated with the parent element.

Refer to Agency definition for any enumerations.

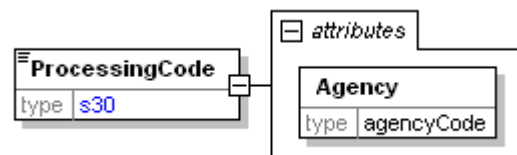

ProcessingCodeInfo

A group item specifying code and description for processing details.

Agency [attribute]

Agency is mandatory. A single instance is required.

Describes the agency maintaining the list of codes. To be included in this list the agency must be a recognized standards body or industry organisation.

- For the element that owns this attribute.
- For another attribute in the list of attributes associated with the parent element.

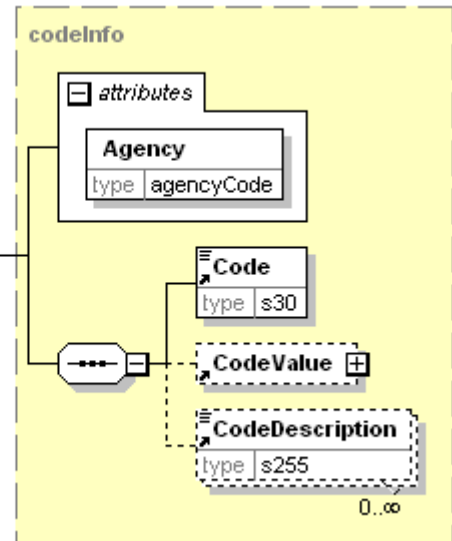
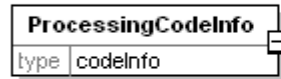

Refer to Agency definition for any enumerations.

(sequence)

The sequence of items below is mandatory. A single instance is required.

Code

Code is mandatory. A single instance is required.

Specifies a code that is defined by an agency. The agency is given for the whole construct containing the code.

CodeValue

CodeValue is optional. A single instance might exist.

A grouping element specifying a value belonging to a code that is defined by an agency.

CodeDescription

CodeDescription is optional. Multiple instances might exist.

A textual description for the meaning of a code that is defined by an agency. When the Code is associated with a CodeValue of type TextValue, then the CodeDescription is a textual description of both the Code and the TextValue.

ProcessingCodeSpecification

A grouping element specifying code and description for processing details.

(sequence)

The sequence of items below is mandatory. A single instance is required.

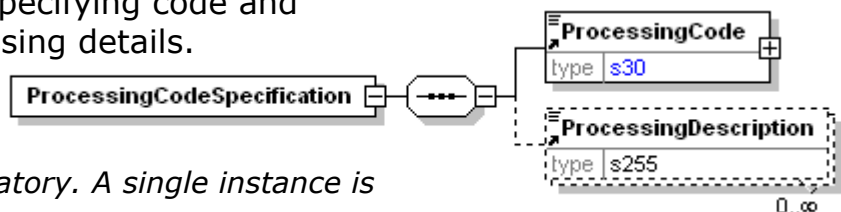

ProcessingCode

ProcessingCode is mandatory. A single instance is required.

A code defining processing details for a product.

ProcessingDescription

ProcessingDescription is optional. Multiple instances might exist.

A text element describing processing details for a product.

ProcessingDescription

A text element describing processing details for a product.

ProcessingDescription	
type	s255

Product

Product is a group item defining the article and its characteristics. Product is used to specify product characteristics organized by ProductIdentifier, ProductDescription, and Classification. Book Manufacturing, Forest Wood, Label Stock, Paper, Pulp, Recovered Paper, Wood Products, and Virgin Fibre market segments have defined their product characteristics and conversion features for implementation in papiNet.

Product	
type	productClass

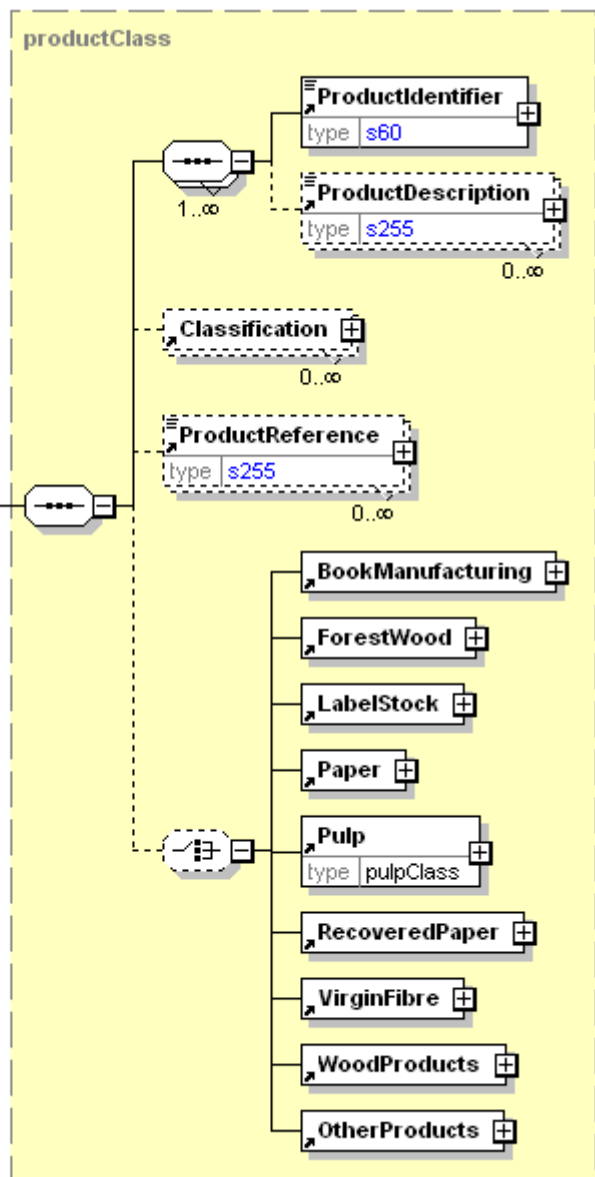

(sequence)

The sequence of items below is mandatory. A single instance is required.

(sequence)

The sequence of items below is mandatory. One instance is required, multiple instances might exist.

ProductIdentifier

ProductIdentifier is mandatory. A single instance is required.

Used to communicate the code of the article, in a variety of formats designated by the type.

ProductDescription

ProductDescription is optional. Multiple instances might exist.

An element used to communicate a human readable description of the product in the language specified by the Language attribute.

Classification

Classification is optional. Multiple instances might exist.

A group item that details the product classification according to a particular organization's scheme. An item across multiple classifications would still be recognized as the same item. Examples of some product classifications are: Containerboard, Pulp-Dissolving, or Newsprint.

ProductReference

ProductReference is optional. Multiple instances might exist.

An element detailing relevant references pertaining to the Product as indicated by ProductReferenceType and AssignedBy.

(choice)

[choice] is optional. A single instance might exist.

BookManufacturing

BookManufacturing is mandatory. A single instance is required.

BookManufacturing is a group element that contains the elements that describe the book manufacturing process.

ForestWood

ForestWood is mandatory. A single instance is required.

A grouping element with information about characteristics for Forest Wood products.

LabelStock

LabelStock is mandatory. A single instance is required.

LabelStock contains the attributes and characteristics that define the label stock product.

Paper

Paper is mandatory. A single instance is required.

A group item defining the characteristics of the paper product.

Pulp

Pulp is mandatory. A single instance is required.

A group item defining the characteristics of pulp that are not dependent on a particular conversion process.

RecoveredPaper

RecoveredPaper is mandatory. A single instance is required.

A group item defining the characteristics of recycled fibre that are not dependent on a particular conversion process.

VirginFibre

VirginFibre is mandatory. A single instance is required.

Virgin Fibre

WoodProducts

WoodProducts is mandatory. A single instance is required.

A grouping element for all wood products.

OtherProducts

OtherProducts is mandatory. A single instance is required.

A group item defining the characteristics of other products.

ProductAdaptedFor

A group element containing information about a specific business party for which the product is adapted.

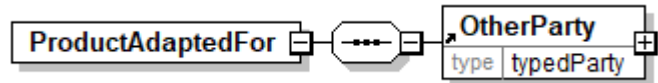

(sequence)

The sequence of items below is mandatory. A single instance is required.

OtherParty

OtherParty is mandatory. A single instance is required.

An organisation or business entity other than those specifically detailed within an e-Document.

ProductAttributes

The ProductAttributes element is the root element for the ProductAttributes e-Document.

The ProductAttributes e-Document provides the means to communicate information about products between business partners.

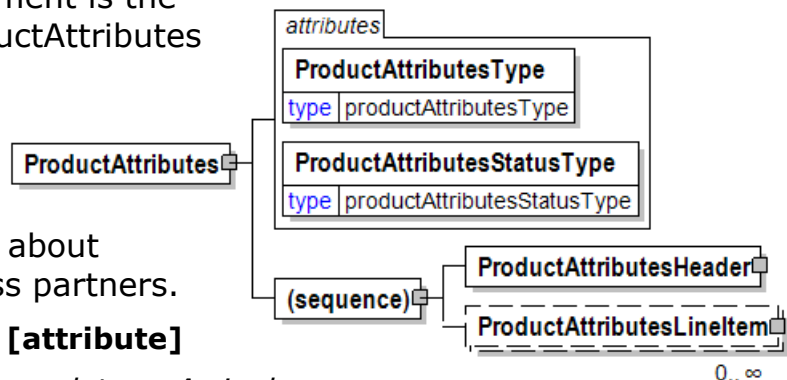

ProductAttributesType [attribute]

ProductAttributesType is mandatory. A single instance is required.

The type of information being communicated in the ProductAttributes e-Document

Refer to ProductAttributesType definition for any enumerations.

ProductAttributesStatusType [attribute]

ProductAttributesStatusType is mandatory. A single instance is required.

Defines the status of the entire ProductAttributes e-Document, in other words, at the root level

Refer to ProductAttributesStatusType definition for any enumerations.

(sequence)

The sequence of items below is mandatory. A single instance is required.

ProductAttributesHeader

ProductAttributesHeader is mandatory. A single instance is required.

Information that applies to the entire ProductAttributes e-Document.

ProductAttributesLineItem

ProductAttributesLineItem is optional. Multiple instances might exist.

A group element that contains data relevant to the Product described on the line item.

ProductAttributesHeader

Information that applies to the entire ProductAttributes e-Document.

(sequence)

The sequence of items below is mandatory. A single instance is required.

ProductAttributesNumber

ProductAttributesNumber is optional. A single instance might exist.

The unique identifier of the ProductAttributes e-Document.

ProductAttributesIssueDate

ProductAttributesIssueDate is mandatory. A single instance is required.

The Date and Time the ProductAttributes are issued. (Compare to ValidityPeriod.)

TransactionHistoryNumber

TransactionHistoryNumber is optional. A single instance might exist.

A sequential number that keeps track of the version of a document.

However when the document is a confirmation document, in which case the TransactionHistoryNumber refers to the trigger transaction for the confirmation.

RequestNumber

RequestNumber is optional. A single instance might exist.

A unique tracking number specifically identifying the InfoRequest e-Document to the originator. The tracking number is returned with the "information", the answer, to help match the answer to the request.

SenderProductAttributesIdentifier

SenderProductAttributesIdentifier is mandatory. A single instance is required.

A unique identifier assigned to the

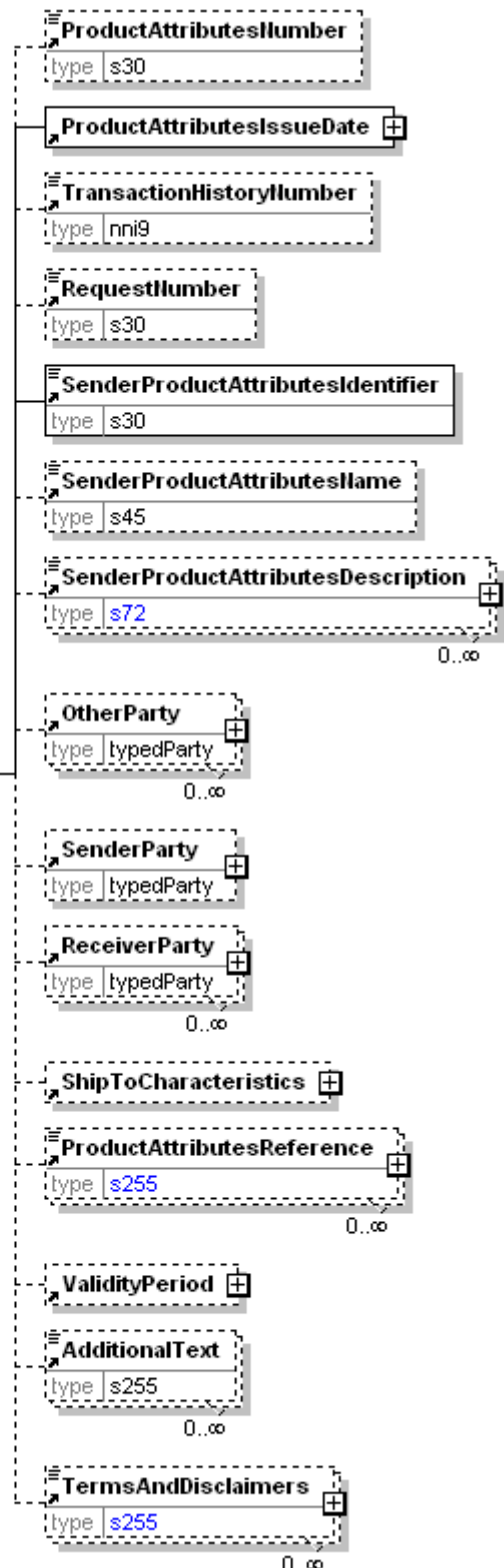

combination of products, properties, and ReceivingParty that makes this list of ProductAttributes unique from the SendingParty's point of view. Subsequent ProductAttributes with updates will use this same identifier.

SenderProductAttributesName

SenderProductAttributesName is optional. A single instance might exist.

The name given to the set of products sent in the ProductAttributes e-Document.

SenderProductAttributesDescription

SenderProductAttributesDescription is optional. Multiple instances might exist.

An element containing free text used to describe the set of products sent in the ProductAttributes.

OtherParty

OtherParty is optional. Multiple instances might exist.

An organisation or business entity other than those specifically detailed within an e-Document.

SenderParty

SenderParty is optional. A single instance might exist.

The business entity issuing the e-Document, the source of the document.

The entity responsible for the content. If the sender party has out sourced the message service to a third party the SenderParty is the issuer of the e-Document and not the party performing the transmission service of the electronic message.

ReceiverParty

ReceiverParty is optional. Multiple instances might exist.

The business entity for whom the e-Document is intended, the destination of the document.

The entity interested in the content. If the receiver party has outsourced the message service to a third party the ReceiverParty is the intended party for the e-Document and not the party performing the receiving service of the electronic message.

ShipToCharacteristics

ShipToCharacteristics is optional. A single instance might exist.

A group item that provides information important for the Ship-To Party.

ProductAttributesReference

ProductAttributesReference is optional. Multiple instances might exist.

References that apply to the ProductAttributes e-Document, contains the ProductAttributesReferenceType attribute.

ValidityPeriod

ValidityPeriod is optional. A single instance might exist.

The validity period for a specific item, e.g. the validity period for an e-Document.

AdditionalText

AdditionalText is optional. Multiple instances might exist.

A text field that is used to communicate information not previously defined or for special instructions. To be used only for circumstances not covered by specific elements.

papiNet V2R31

TermsAndDisclaimers

TermsAndDisclaimers is optional. Multiple instances might exist.

An element that contains legal information with an indication of what the Language is.

ProductAttributesIssueDate

The Date and Time the ProductAttributes are issued.
(Compare to ValidityPeriod.)

(sequence)

The sequence of items below is mandatory. A single instance is required.

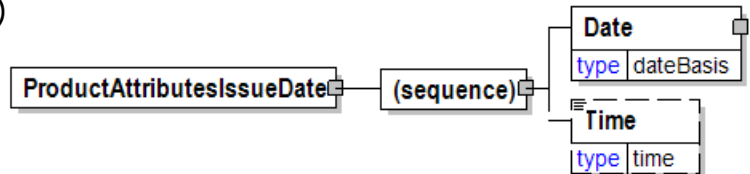

Date

Date is mandatory. A single instance is required.

A group element that contains the specification of Year, Month, and Day.

Time

Time is optional. A single instance might exist.

Times are treated in a standard XML fashion with a special case used to indicate a generalized "local" time. The standard XML approach to time is hh:mm:ss, hh:mm:ssZ, or hh:mm:ss±hh:mm.

hh:mm:ss±hh:mm is used to represent a time with a time zone. The time zone is communicated as the number of hours offset from the Universal Time Coordinate (UTC), a.k.a. Greenwich Mean Time.

hh:mm:ssZ indicates the time at Zulu (another name for UTC).

hh:mm:ss or hh:mm indicates within papiNet the applicable local time where the associated event is taking place. Caution should be used when processing times of this nature as the papiNet approach may be in discord with other users of XML.

ProductAttributesLineItem

A group element that contains data relevant to the Product described on the line item.

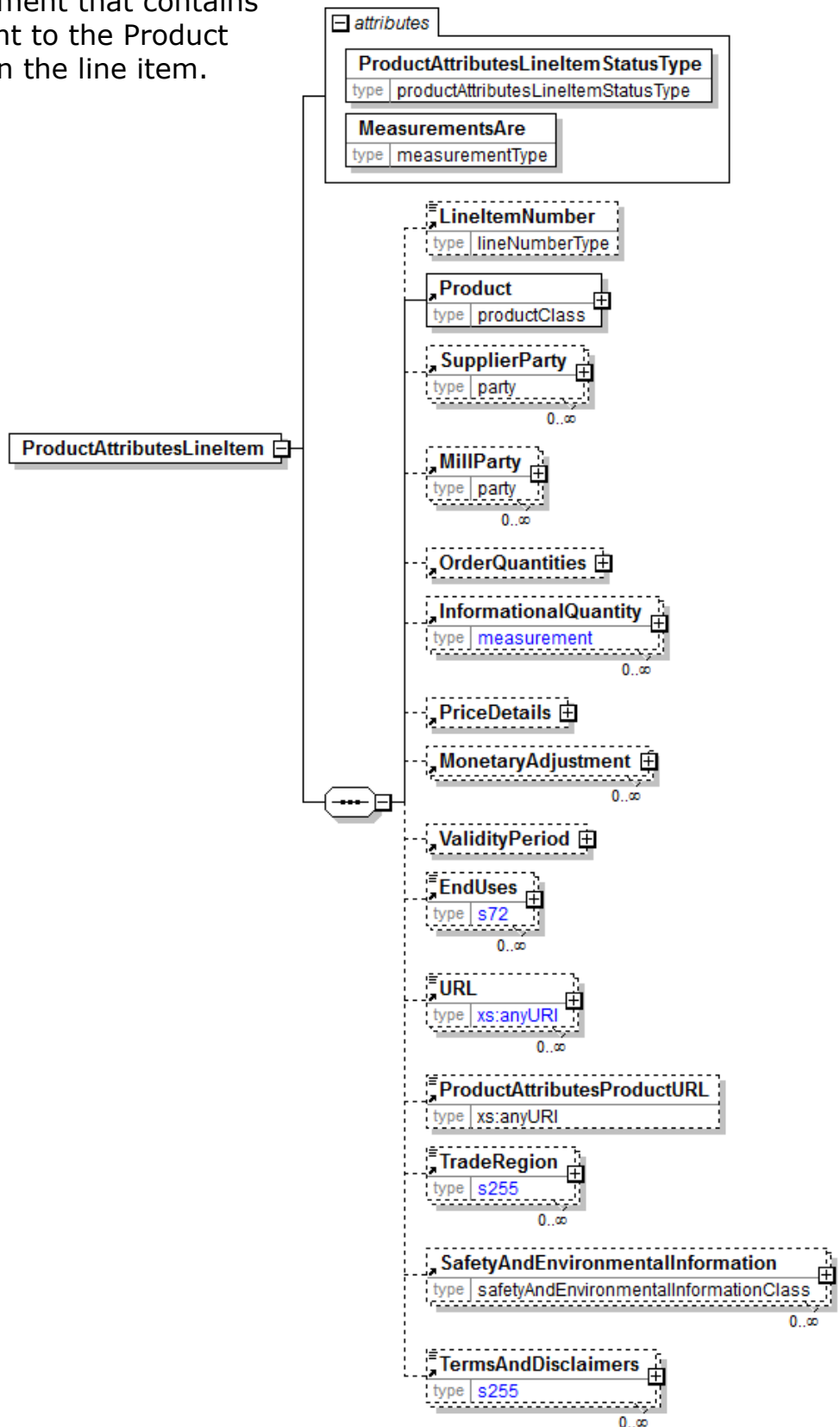

ProductAttributesLineItemStatusType [attribute]

ProductAttributesLineItemStatusType is mandatory. A single instance is required.

Defines the status of the ProductAttributesLineItem

Refer to ProductAttributesLineItemStatusType definition for any enumerations.

MeasurementsAre [attribute]

MeasurementsAre is mandatory. A single instance is required.

Used to define for a product whether the details provided are ranges and lists of properties, or whether they are discrete, single properties of the product.

Refer to MeasurementsAre definition for any enumerations.

(sequence)

The sequence of items below is mandatory. A single instance is required.

LineItemNumber

LineItemNumber is optional. A single instance might exist.

A sequential number that uniquely identifies the line item of an e-Document.

Product

Product is mandatory. A single instance is required.

Product is a group item defining the article and its characteristics. Product is used to specify product characteristics organized by ProductIdentifier, ProductDescription, and Classification. Book Manufacturing, Label Stock, Paper, Pulp, Recovered Paper, Wood Products, and Virgin Fibre market segments have defined their product characteristics and conversion features for implementation in papiNet.

SupplierParty

SupplierParty is optional. Multiple instances might exist.

The organisation or business entity responsible for providing the product. SupplierParty is also the seller of the product, if Seller is not specified as OtherParty = Seller.

MillParty

MillParty is optional. Multiple instances might exist.

The organisation or business entity that actually produces the product.

OrderQuantities

OrderQuantities is optional. A single instance might exist.

An element that contains the quantities that can be used for ordering.

InformationalQuantity

InformationalQuantity is optional. Multiple instances might exist.

A quantity given in a valid UOM used for information purposes only (not for calculation). For example, an ordered quantity was 100 reels as opposed to the invoice quantity of 20,000 pounds.

PriceDetails

PriceDetails is optional. A single instance might exist.

An element that groups together price information.

MonetaryAdjustment

MonetaryAdjustment is optional. Multiple instances might exist.

The element containing the information necessary for the understanding, calculation, and treatment of an adjustment to a currency amount. MonetaryAdjustment contains an attribute that indicates the type of adjustment being communicated.

ValidityPeriod

ValidityPeriod is optional. A single instance might exist.

The validity period for a specific item, e.g. the validity period for an e-Document.

EndUses

EndUses is optional. Multiple instances might exist.

A text element used to express in human readable form a list of applicable end uses for a product. Examples of end uses are:

- Magazine
- Book
- Commercial print
- etc

URL

URL is optional. Multiple instances might exist.

Universal Resource Locator. While typically a web address you could use this field to hold an email address.

ProductAttributesProductURL

ProductAttributesProductURL is optional. A single instance might exist.

The web address of information pertinent to a particular product.

TradeRegion

TradeRegion is optional. Multiple instances might exist.

A geographic area for product availability communication.

SafetyAndEnvironmentalInformation

SafetyAndEnvironmentalInformation is optional. Multiple instances might exist.

Name of certification type, if any, on the goods (For example, FSC, PEFC). SafetyAndEnvironmental needs a value or measurement to communicate the percentage of the product is certified (for example, 75% is certified by the indicated agency).

TermsAndDisclaimers

TermsAndDisclaimers is optional. Multiple instances might exist.

An element that contains legal information with an indication of what the language is.

ProductAttributesLineItemStatusType [attribute]

Defines the status of the ProductAttributesLineItem

ProductAttributesLineItemStatusType	
type	productAttributesLineItemStatusType

This item is restricted to the following list.

Amended

The supplied information is changed.

Cancelled

The supplied information has been cancelled. Items that have been cancelled are not included in totals on the summary levels of the e-Document.

Original

The supplied information is the first version of that information.

ProductAttributesNumber

The unique identifier of the ProductAttributes e-Document.

ProductAttributesNumber	
type	s30

ProductAttributesProductURL

The web address of information pertinent to a particular product.

ProductAttributesProductURL	
type	anyURI

ProductAttributesReference

References that apply to the ProductAttributes e-Document, contains the

ProductAttributesReference	
type	s255

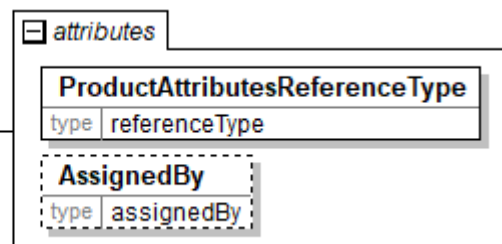

ProductAttributesReferenceType attribute.

ProductAttributesReferenceType [attribute]

ProductAttributesReferenceType is mandatory. A single instance is required.

Provides a contextual explanation of the specific reference identifier. Many items are currently prefixed by "Buyer", "Forwarder", "Manufacturer", "Mill", "Seller", "Supplier", "Warehouse", or "Vendor". Check for an existing non-prefixed version and use the non-prefixed version instead. In the (yet to be announced release date) version 3.0 the prefixed versions will be removed. Instead the attribute @AssignedBy will communicate the information previously communicated in the prefix.

papiNet V2R31

Refer to ProductAttributesReferenceType definition for any enumerations.

AssignedBy [attribute]

AssignedBy is optional. A single instance might exist.

Identifies the type of party or the agency that has assigned the associated item, e.g. a reference of type OrderNumber.

Refer to AssignedBy for any enumerations.

ProductAttributesReferenceType [attribute]

Provides a contextual explanation of the specific reference identifier. Many items are currently prefixed by "Buyer", "Forwarder", "Manufacturer", "Mill", "Seller", "Supplier", "Warehouse", or "Vendor". Check for an existing non-prefixed version and use the non-prefixed version instead. In the (yet to be announced release date) version 3.0 the prefixed versions will be removed. Instead the attribute @AssignedBy will communicate the information previously communicated in the prefix.

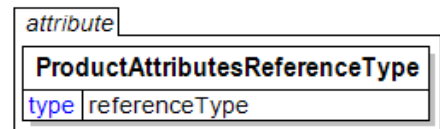

Refer to the [referenceType](#) entry for the list of enumerations and their definitions.

ProductAttributesRequestDetail

A grouping element that provides the parameters to be used when responding with a ProductAttributes e-Document.

ProductAttributesRequestDetailType [attribute]

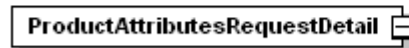

ProductAttributesRequestDetailType is mandatory. A single instance is required.

Communicates the method in which the ProductAttributes should be reported.

Refer to ProductAttributesRequestDetailType definition for any enumerations.

(sequence)

The sequence of items below is mandatory. A single instance is required.

Product

Product is optional. A single instance might exist.

Product is a group item defining the article and its characteristics. Product is used

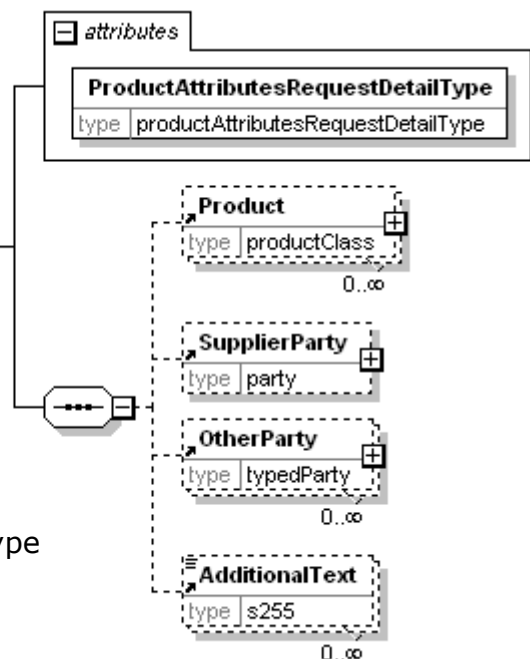

papiNet V2R31

to specify product characteristics organized by ProductIdentifier, ProductDescription, and Classification. Book Manufacturing, Label Stock, Paper, Pulp, Recovered Paper, Wood Products, and Virgin Fibre market segments have defined their product characteristics and conversion features for implementation in papiNet.

SupplierParty

SupplierParty is optional. A single instance might exist.

The organisation or business entity responsible for providing the product. SupplierParty is also the seller of the product, if Seller is not specified as OtherParty = Seller.

OtherParty

OtherParty is optional. Multiple instances might exist.

An organisation or business entity other than those specifically detailed within an e-Document.

AdditionalText

AdditionalText is optional. Multiple instances might exist.

A text field that is used to communicate information not previously defined or for special instructions. To be used only for circumstances not covered by specific elements.

ProductAttributesRequestDetailType [attribute]

Communicates the method in which the ProductAttributes should be reported.

This item is restricted to the following list.

PriceList

Request for a price list.

ProductCrossReference

Request for product cross reference information.

ProductProperties

Request for properties of the products.

UniqueProductIdentifier

Request for unique product identifiers.



ProductAttributesStatusType [attribute]

Defines the status of the entire ProductAttributes e-Document, in other words, at the root level

This item is restricted to the following list.

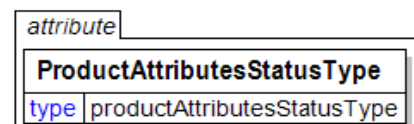

Amended

The supplied information is changed.

Cancelled

The supplied information has been cancelled. Items that have been cancelled are not included in totals on the summary levels of the e-Document.

Original

The supplied information is the first version of that information.

Replaced

The supplied information is replacing earlier supplied information. The receiver should revalidate the information in their system based upon the entire information received.

ProductAttributesType [attribute]

The type of information being communicated in the ProductAttributes e-Document

This item is restricted to the following list.



PriceList

The information represents a price list.

ProductCrossReference

The information contains product cross reference information

ProductProperties

The information is a representation of the properties of the products.

UniqueProductIdentifier

The information contains unique product identifiers.

ProductBasisSizeType [attribute]

An attribute list that indicates the size of paper used as the base for the basis weight calculation

This item is restricted to the following list.

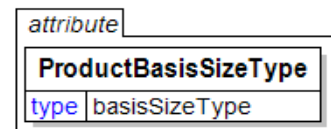

GramsPerSquareMeter

The basis size type is in metric measurement of grams per square meter.

16x18

The surface area of a ream (500 sheets) is 16x18 in inches.

17x22

The surface area of a ream (500 sheets) is 17x22 in inches. This size is also known as Bond.

20x26

The surface area of a ream (500 sheets) is 20x26 in inches. This size is also

papiNet V2R31

known as Cover.

20x30

The surface area of a ream (500 sheets) is 20x30 in inches.

22.5x22.5

The surface area of a ream (500 sheets) is 22.5x22.5 in inches.

22.5x28.5

The surface area of a ream (500 sheets) is 22.5x28.5 in inches.

24x26

The surface area of a ream (500 sheets) is 24x26 in inches.

24x36

The surface area of a ream (500 sheets) is 24x36 in inches. This size is also known as Newsprint.

25x38

The surface area of a ream (500 sheets) is 25x38 in inches. This size is also known as Book.

25x40

The surface area of a ream (500 sheets) is 25x40 in inches.

25.5x28.5

The surface area of a ream (500 sheets) is 25.5x28.5 in inches.

25.5x30.5

The surface area of a ream (500 sheets) is 25.5x30.5 in inches.

35.5x30.5

The surface area of a ream (500 sheets) is 35.5x30.5 in inches.

1000SqFt

The surface area of one sheet is 1000 square feet.

ProductDescription

An element used to communicate a human readable description of the product in the language specified by the Language attribute.

Language [attribute]

Language is optional. A single instance might exist.

The valid Alpha 2- and Alpha 3-character list of language codes in the ISO 639-1 and 639-2 international standards.

Information on the content of this attribute is available at:
https://www.loc.gov/standards/iso639-2/php/code_list.php

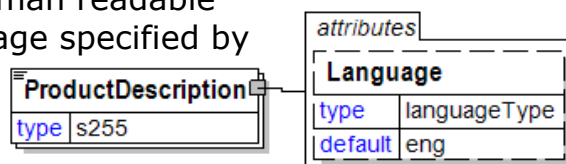

ProductSummary

ProductSummary is optional. A single instance might exist.

Group of elements to provide summary information on product level.

LengthSpecification

LengthSpecification is optional. Multiple instances might exist.

Length specification of the wood product.

ProductIdentification

A grouping element designed to communicate product identification related to the parent element that contains this item.

(sequence)

The sequence of items

below is mandatory. A single instance is required.

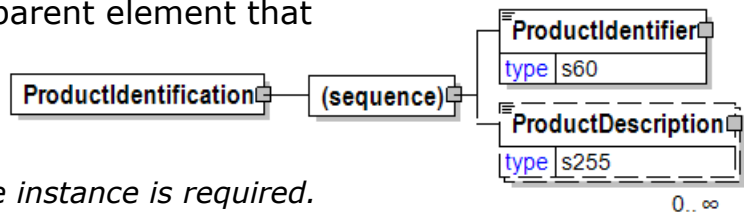

ProductIdentifier

ProductIdentifier is mandatory. A single instance is required.

Used to communicate the code of the article, in a variety of formats designated by the type.

ProductDescription

ProductDescription is optional. Multiple instances might exist.

An element used to communicate a human readable description of the product in the language specified by the Language attribute.

ProductIdentifier

Used to communicate the code of the article, in a variety of formats designated by the type.

Agency [attribute]

Agency is mandatory. A single instance is required.

Describes the agency maintaining the list of codes. To be included in this list the agency must be a recognized standards body or industry organisation.

- For the element that owns this attribute.
- For another attribute in the list of attributes associated with the parent element.

Refer to Agency definition for any enumerations.

ProductIdentifierType [attribute]

ProductIdentifierType is mandatory. A single instance is required.

Provides a contextual definition to the product identifier value.

Refer to ProductIdentifierType definition for any enumerations.

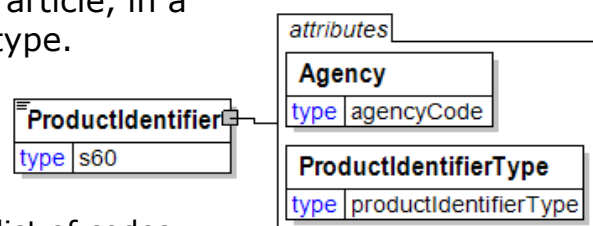

ProductIdentifierType [attribute]

Provides a contextual definition to the product identifier value.

This item is restricted to the following list.

attribute
ProductIdentifierType
type productIdentifierType

BrandName

A specific product brand name for which the owner or the source is specified in the Agency attribute.

CASNumber

Chemical Abstracts Service (CAS) numbers are universally used to provide a unique, unmistakable identifier for chemical substances. A CAS number itself has no inherent chemical significance but provides an unambiguous way to identify a chemical substance or molecular structure when there are many possible systematic, generic, proprietary or trivial names. CAS numbers are created and maintained by American Chemical Society. (<http://www.cas.org>)

CatalogueNumber

A unique reference for a product in a catalogue. The owner or the source is specified in the Agency attribute.

CustomsTariffNumber

EAN8

To be deprecated in a future version V3R00. GS1 has renamed it to GTIN-8. Use GTIN8 instead.

EAN13

To be deprecated in a future version V3R00. GS1 has renamed it to GTIN-13. Use GTIN13 instead.

ExportHarmonisedSystemCode

The Harmonised System Code is an international goods classification system developed by the Customs Co-operation Council.

USA: It is a 10-digit number, the first 6 of which compose the harmonised code. The remaining 4 digits represent statistical subdivisions. The schedule is a statistical classification of domestic and foreign commodities exported from the United States.

Canada: Canadians have adopted the scheme as a basis for a new Canadian Tariff and Statistical Classification System. The Canadian export number consists of 8 digits prefixed by "HS" and is shown in the format HS5911.31.10, for example.

EWCNumber

The European Waste Catalogue (EWC) is a hierarchical list of waste codes established by decision (2014/955/EU) of the EU Commission. The different types of waste are fully defined by a six-digit code listed in 3 groups of 2 digits, e.g. 03 01 01 and 03 01 04*. Waste codes are communicated in papiNet as a six-digit code without spaces and ending asterisk (*), e.g. 030101 and 030104.

papiNet V2R31

In EU, anyone who runs a business of recycling or disposal requiring environmental permits or operating a heating plant that is using waste as fuel must take cognizance of the wastes category that is described in the EWC list.

<https://eur-lex.europa.eu/eli/dec/2014/955/oj>

FinishedGoodIdentifier

Product Identifier assigned by an Agency, e.g. a Publisher, to identify the finished product.

GradeCode

A specific product code for which the owner or the source is specified in the Agency attribute.

GradeName

A specific product name for which the owner or the source is specified in the Agency attribute (for example, ImprovedNewsprint-45-1479).

GTIN8

An 8 digit identifier GTIN-8 defined by GS1 for trade items, Earlier referred to as European Article Number EAN-8. GTIN-8s will be encoded in an EAN-8 bar code. See also GTIN14 for more information. <http://www.gs1.org/>

GTIN12

A 12 digit identifier GTIN-12 defined by GS1 for trade items, Earlier referred to as Universal Product Code. GTIN-12s can be encoded in UPC-A, UPC-E, ITF-14, or GS1-128 bar codes. GTIN-12 is primarily used in North America. See also GTIN14 for more information. <http://www.gs1us.org/>

GTIN13

A 13 digit identifier GTIN-13 defined by GS1 for trade items, Earlier referred to as European Article Number EAN-13. GTIN-13s can be encoded in EAN-13, ITF-14 or GS1-128 bar codes. See also GTIN14 for more information. <http://www.gs1.org/>

GTIN14

A 14 digit Global Trade Item Number (GTIN) defined by GS1. It is one of the main building blocks of the GS1 System and is used to uniquely identify trade items, which are products and services that are priced, ordered or invoiced at any point in the supply chain.

GTINs can be 8, 12, 13, or 14 digits in length. GS1 recommends that every GTIN be represented in software applications as 14 digits by right justifying and zero filling left, as appropriate. The following table demonstrates the structure of GTINs in a GTIN-compliant database

Type of GTIN	GTIN Digit													
	1	2	3	4	5	6	7	8	9	10	11	12	13	14
GTIN-8	0	0	0	0	0	0	N	N	N	N	N	N	N	C
GTIN-12	0	0	N	N	N	N	N	N	N	N	N	N	N	C
GTIN-13	0	N	N	N	N	N	N	N	N	N	N	N	N	C
GTIN-14	N	N	N	N	N	N	N	N	N	N	N	N	N	C

papiNet V2R31

<http://www.gs1.org/>

ImportHarmonisedSystemCode

The Harmonised System Code is an international goods classification system developed by the Customs Co-operation Council.

USA: It is a 10-digit number, the first 6 of which compose the harmonised code. The remaining 4 digits represent statistical subdivisions. The schedule is a statistical classification of domestic and foreign commodities exported from the United States.

Canada: Canadians have adopted the scheme as a basis for a new Canadian Tariff and Statistical Classification System. The Canadian export number consists of 8 digits prefixed by "HS" and is shown in the format HS5911.31.10, for example.

ManufacturingGradeCode

A specific grade code to the actual manufactured product which may be different to the grade code under which the product is sold. These codes generally refer to a product manufactured on a pulp or paper machine. The owner or the source is specified in the Agency attribute.

ManufacturingGradeName

A specific grade name assigned to the actual manufactured product which may be different to the grade name under which the product is sold. These codes generally refer to a product manufactured on a pulp or paper machine. The owner or the source is specified in the Agency attribute.

Ondule

A product code issued by the Groupement Ondulé, which is the European Association of Corrugated Base Papers Manufacturers.

PartNumber

An equivalent to the Stock Keeping Unit (SKU) for which the owner or the source is specified in the Agency attribute. In other words, this code fully defines the product.

RFQPartNumber

The part number communicated as part of the RFQ process. This may be a form of the RFQ number itself. This field is designed to handle the situation where there is no part number assigned to the particular blend of product characteristics. The owner or the source is specified in the Agency attribute.

SKU

The Stock Keeping Unit that is assigned by the buyer or supplier and that includes all relevant information to make an individual item ready for shipping. The owner or the source is specified in the Agency attribute.

UPC

To be deprecated in a future version V3R00. GS1 US has defined the UPC code to be a Global Trade Item Number GTIN-12. Use GTIN12 instead. See also IdentifierFormatType UPC_A for more information. <http://www.gs1us.org/>

Other

Used for any other product identifier type that is not covered by the list.

ProductInformationText

An element used to communicate human readable information about the Product in the language specified by the Language attribute.



Language [attribute]

Language is optional. A single instance might exist.

The valid Alpha 2- and Alpha 3-character list of language codes in the ISO 639-1 and 639-2 international standards.

Information on the content of this attribute is available at:
https://www.loc.gov/standards/iso639-2/php/code_list.php

ProductionLastDateOfChange

The final Date and Time that a line item or delivery line may be amended or cancelled by the buyer.

(sequence)

The sequence of items below is mandatory. A single instance is required.

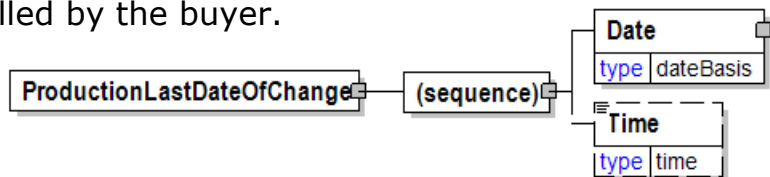

Date

Date is mandatory. A single instance is required.

A group element that contains the specification of Year, Month, and Day.

Time

Time is optional. A single instance might exist.

Times are treated in a standard XML fashion with a special case used to indicate a generalized "local" time. The standard XML approach to time is hh:mm:ss, hh:mm:ssZ, or hh:mm:ss±hh:mm.

hh:mm:ss±hh:mm is used to represent a time with a time zone. The time zone is communicated as the number of hours offset from the Universal Time Coordinate (UTC), a.k.a. Greenwich Mean Time.

hh:mm:ssZ indicates the time at Zulu (another name for UTC).

hh:mm:ss or hh:mm indicates within papiNet the applicable local time where the associated event is taking place. Caution should be used when processing times of this nature as the papiNet approach may be in discord with other users of XML.

ProductionRunNumber

The ProductionRunNumber assigned by the issuer.

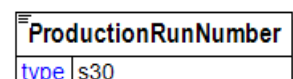

ProductionStatus

A group item used to communicate the release of a delivery line number.

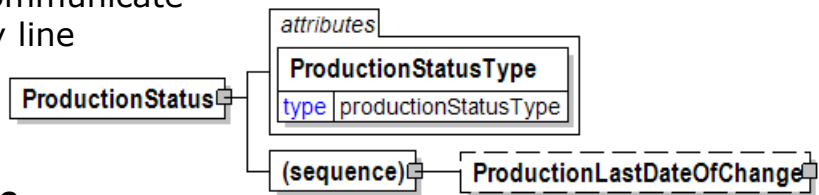

ProductionStatusType [attribute]

ProductionStatusType is mandatory. A single instance is required.

Indicates whether the ordered quantities to which it refers are allowed to be produced.

When goods are free for delivery but the buyer wants to specify a more detailed DeliverySchedule, a CallOff is used.

PurchaseOrder - Typically, a buyer sets ProductionStatusType for an order to "Free", which means the seller can produce the product(s) on the order. A PurchaseOrder of type ReservationOrder is an exception because the buyer is booking capacity at the mill but not making a commitment to buy; for this type of order, the status is "NotFree". The buyer uses one or more ReleaseOrder(s) referring to the ReservationOrder to change the ProductionStatusType to "Free" for one or more products on the ReservationOrder.

The level of specification in the DeliverySchedule element is used will indicate whether the PurchaseOrder is "Free" for delivery.

Refer to ProductionStatusType definition for any enumerations.

(sequence)

The sequence of items below is mandatory. A single instance is required.

ProductionLastDateOfChange

ProductionLastDateOfChange is optional. A single instance might exist.

The final Date and Time that a line item or delivery line may be amended or cancelled by the buyer.

ProductionStatusType [attribute]

Indicates whether the ordered quantities to which it refers are allowed to be produced.

When goods are free for delivery but the buyer wants to specify a more detailed DeliverySchedule, a CallOff is used.

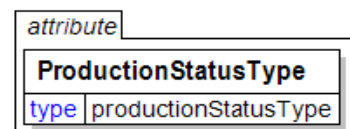

PurchaseOrder - Typically, a buyer sets ProductionStatusType for an order to "Free", which means the seller can produce the product(s) on the order. A PurchaseOrder of type ReservationOrder is an exception because the buyer is booking capacity at the mill but not making a commitment to buy; for this type of order, the status is "NotFree". The buyer uses one or more ReleaseOrder(s) referring to the ReservationOrder to change the ProductionStatusType to "Free" for one or more products on the

papiNet V2R31

ReservationOrder.

The level of specification in the DeliverySchedule element is used will indicate whether the PurchaseOrder is "Free" for delivery.

This item is restricted to the following list.

Free

The ordered quantities to which it refers can be produced, in other words, are free to make.

NotFree

The ordered quantities to which it refers cannot be produced, in other words, are not free to make

ProductPackaging

Defines the methods and materials used for packaging.

(sequence)

The sequence of items below is mandatory. A single instance is required.

QuantityInUnit

QuantityInUnit is optional. A single instance might exist.

Used to identify the number of items packed within this package unit.

UnitDimension

UnitDimension is optional. A single instance might exist.

Unit
Dimension

Weight

Weight is optional. A single instance might exist.

The weight of the item.

PackageIDInformation

PackageIDInformation is optional. A single instance might exist.

Group element identifying a lumber (wood) package. The package name may also be communicated.

LabelCharacteristics

LabelCharacteristics is optional. Multiple instances might exist.

A group item that organises the labeling information.

StencilCharacteristics

StencilCharacteristics is optional. Multiple instances might exist.

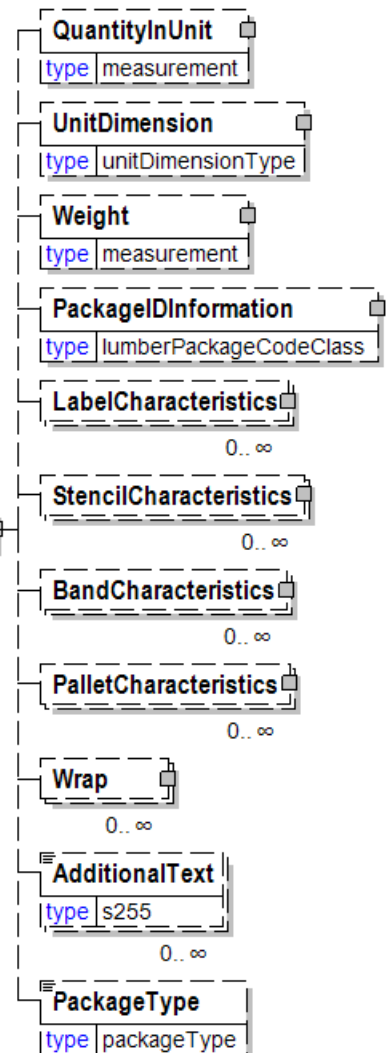

papiNet V2R31

A group element specifying attributes of a stencil to be applied to an item, and optional text.

BandCharacteristics

BandCharacteristics is optional. Multiple instances might exist.

A group item that organises the packaging band detail information.

PalletCharacteristics

PalletCharacteristics is optional. Multiple instances might exist.

A group item that provides pallet detail information.

Wrap

Wrap is optional. Multiple instances might exist.

A group item that organises wrapping detail information.

AdditionalText

AdditionalText is optional. Multiple instances might exist.

A text field that is used to communicate information not previously defined or for special instructions. To be used only for circumstances not covered by specific elements.

PackageType

PackageType is optional. A single instance might exist.

Communicates the configuration of the item being reported.

Refer to PackageType definition for any enumerations.

ProductPercentage

The quantity of a product in percentage of the total quantity for an item containing many products. Attribute QuantityType, QuantityTypeContext and AdjustmentType can be used to define what quantity the percentage is referring to.

QuantityType [attribute]

QuantityType is optional. A single instance might exist.

QuantityType communicates information about the type of quantity being communicated and how the receiver might use the information.

Refer to QuantityType definition for any enumerations.

QuantityTypeContext [attribute]

QuantityTypeContext is optional. A single instance might exist.

Provides the location in the value chain where the quantity is being reported.

Refer to QuantityTypeContext definition for any enumerations.

AdjustmentType [attribute]

AdjustmentType is optional. A single instance might exist.

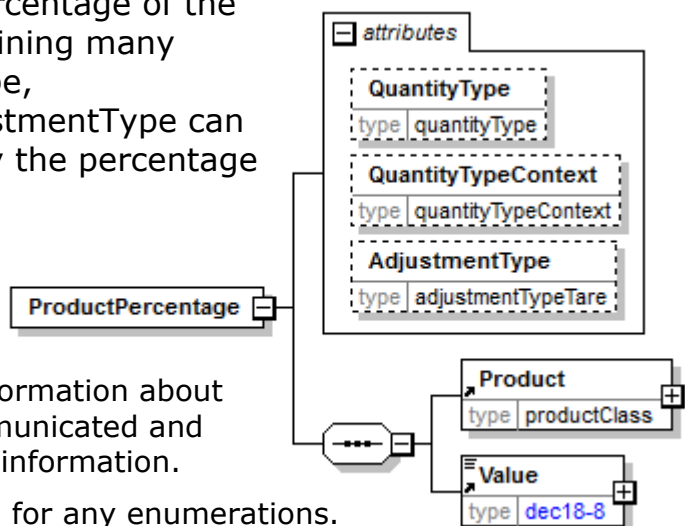

papiNet V2R31

Describes the type of adjustment associated with a quantity.

Refer to AdjustmentType definition for any enumerations.

(sequence)

The sequence of items below is mandatory. A single instance is required.

Product

Product is mandatory. A single instance is required.

Product is a group item defining the article and its characteristics. Product is used to specify product characteristics organized by ProductIdentifier, ProductDescription, and Classification. Book Manufacturing, Label Stock, Paper, Pulp, Recovered Paper, Wood Products, and Virgin Fibre market segments have defined their product characteristics and conversion features for implementation in papiNet.

Value

Value is mandatory. A single instance is required.

A numeric value expressed in the unit of measure (UOM).

ProductPerformance

The ProductPerformance element is the root element for the ProductPerformance e-Document.

The ProductPerformance e-Document is created by the product consumer

in order to communicate back to the manufacturer the performance of the product. This e-Document will enable the manufacturer to focus on improvements related to product defects that create inefficiency during performance. The aggregation of performance factors by product will provide the mechanism for achieving the value aspect of the e-Document. The goal is to keep the products of the Pulp & Paper Industry attractive versus competing alternatives.

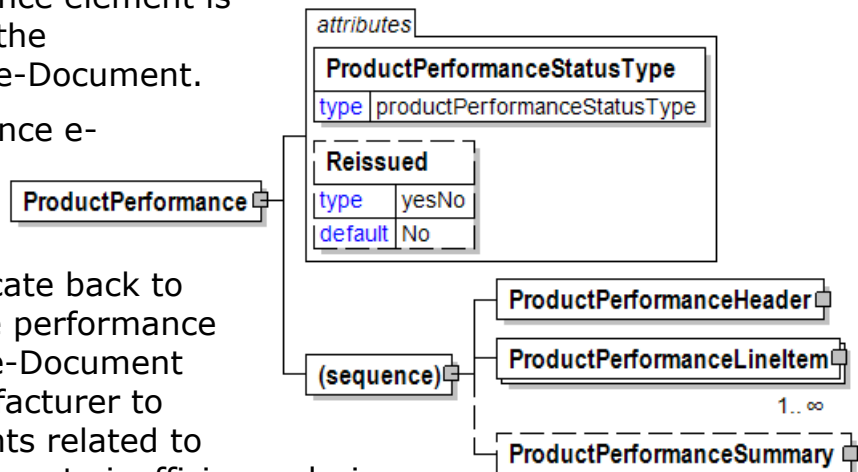

ProductPerformanceStatusType [attribute]

ProductPerformanceStatusType is mandatory. A single instance is required.

ProductPerformanceStatusType

Refer to ProductPerformanceStatusType definition for any enumerations.

Reissued [attribute]

Reissued is optional. A single instance might exist.

Either "Yes" or "No".

Refer to Reissued definition for any enumerations.

(sequence)

The sequence of items below is mandatory. A single instance is required.

ProductPerformanceHeader

ProductPerformanceHeader is mandatory. A single instance is required.

Information that applies to the entire ProductPerformance e-Document.

ProductPerformanceLineItem

ProductPerformanceLineItem is mandatory. One instance is required, multiple instances might exist.

Information for each item in the ProductPerformance e-Document.

ProductPerformanceSummary

ProductPerformanceSummary is optional. A single instance might exist.

Summary information for the items on the ProductPerformance e-Document

ProductPerformanceConcerns

A grouping element used to hold information about the product performance concerns.

ConcernIndicatorType [attribute]

ConcernIndicatorType is mandatory. A single instance is required.

Either "Yes" or "No".

Refer to ConcernIndicatorType definition for any enumerations.

(choice)

[choice] is optional. Multiple instances might exist.

WebConcerns

WebConcerns is mandatory. A single instance is required.

A grouping element that contains the information about a web break.

SheeterConcerns

SheeterConcerns is mandatory. A single instance is required.

SheeterConcerns is a group element that provides information about an event on a sheeter.

PulpConcerns

PulpConcerns is mandatory. A single instance is required.

If the ConcernIndicatorType is "Y" for a pulp related product then a defect cause must be give.

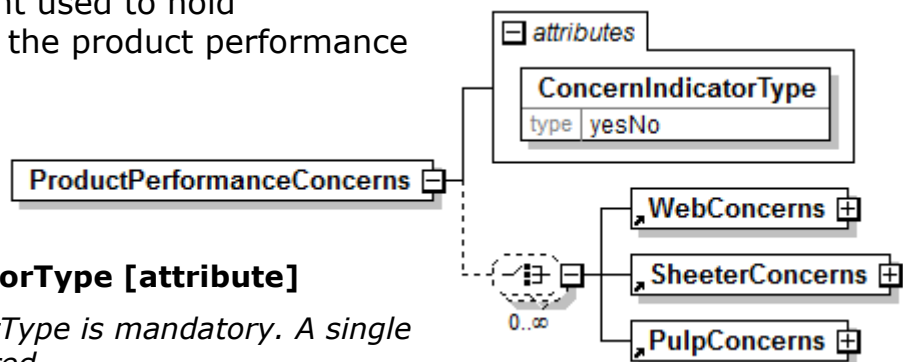

ProductPerformanceConditions

The ProductPerformanceConditions, while not absolutely necessary to determine whether there is a product concern is available.

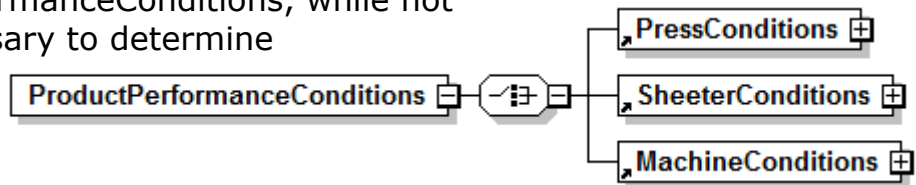

(choice)

[choice] is mandatory. A single instance is required.

PressConditions

PressConditions is mandatory. A single instance is required.

Construct contains environmental conditions of the press during operations

SheeterConditions

SheeterConditions is mandatory. A single instance is required.

Identifies the environmental conditions when the sheet was printed on.

MachineConditions

MachineConditions is mandatory. A single instance is required.

A grouping element for all the environmental measurement at the time of the run.

ProductPerformanceDate

The date the e-Document was issued.

(sequence)

The sequence of items

below is mandatory. A single instance is required.

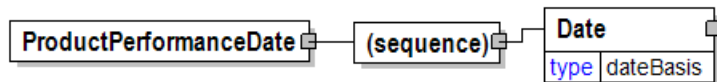

Date

Date is mandatory. A single instance is required.

A group element that contains the specification of Year, Month, and Day.

ProductPerformanceHeader

Information that applies to the entire ProductPerformance e-Document.

(sequence)

The sequence of items below is mandatory. A single instance is required.

ProductPerformanceNumber

ProductPerformanceNumber is mandatory. A single instance is required.

The report number used to identify the entire ProductPerformance.

ProductPerformanceIssueDate

ProductPerformanceIssueDate is



mandatory. A single instance is required.

The date and time the ProductPerformance was issued.

TransactionHistoryNumber

TransactionHistoryNumber is optional. A single instance might exist.

A sequential number that keeps track of the version of a document.

However when the document is a confirmation document, in which case the TransactionHistoryNumber refers to the trigger transaction for the confirmation.

ProductPerformanceReference

ProductPerformanceReference is optional. Multiple instances might exist.

Reference back to another e-Document.

EndUserParty

EndUserParty is mandatory. A single instance is required.

The party using, consuming, or converting the product. For example, a printer using paper reels for a print job for a publisher. The final ShipTo destination for a product is normally to the end user's facilities.

SupplierParty

SupplierParty is mandatory. A single instance is required.

The organisation or business entity responsible for providing the product. SupplierParty is also the seller of the product, if Seller is not specified as OtherParty = Seller.

MillParty

MillParty is optional. A single instance might exist.

The organisation or business entity that actually produces the product.

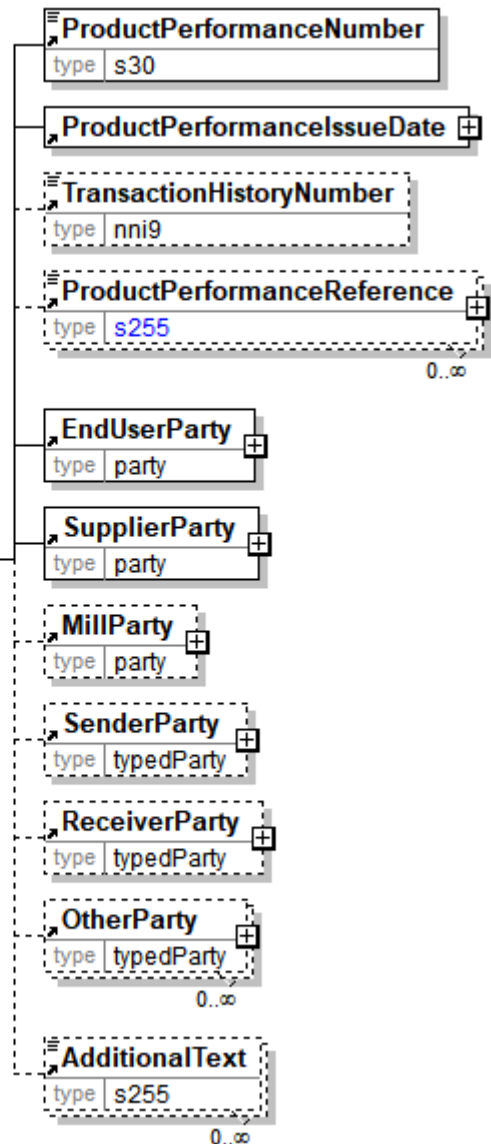

papiNet V2R31

SenderParty

SenderParty is optional. A single instance might exist.

The business entity issuing the e-Document, the source of the document.

The entity responsible for the content. If the sender party has out sourced the message service to a third party the SenderParty is the issuer of the e-Document and not the party performing the transmission service of the electronic message.

ReceiverParty

ReceiverParty is optional. A single instance might exist.

The business entity for whom the e-Document is intended, the destination of the document.

The entity interested in the content. If the receiver party has outsourced the message service to a third party the ReceiverParty is the intended party for the e-Document and not the party performing the receiving service of the electronic message.

OtherParty

OtherParty is optional. Multiple instances might exist.

An organisation or business entity other than those specifically detailed within an e-Document.

AdditionalText

AdditionalText is optional. Multiple instances might exist.

A text field that is used to communicate information not previously defined or for special instructions. To be used only for circumstances not covered by specific elements.

ProductPerformanceIssueDate

The date and time the ProductPerformance was issued.

(sequence)

The sequence of items below is mandatory. A single instance is required.

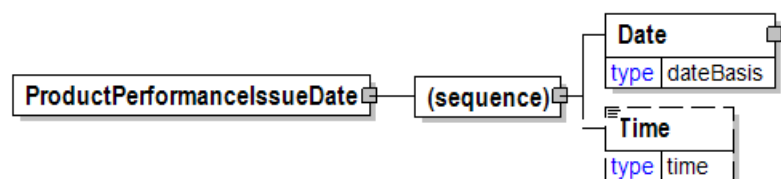

Date

Date is mandatory. A single instance is required.

A group element that contains the specification of Year, Month, and Day.

Time

Time is optional. A single instance might exist.

Times are treated in a standard XML fashion with a special case used to indicate a generalized "local" time. The standard XML approach to time is hh:mm:ss, hh:mm:ssZ, or hh:mm:ss±hh:mm.

hh:mm:ss±hh:mm is used to represent a time with a time zone. The time zone is communicated as the number of hours offset from the Universal Time Coordinate (UTC), a.k.a. Greenwich Mean Time.

hh:mm:ssZ indicates the time at Zulu (another name for UTC).

hh:mm:ss or hh:mm indicates within papiNet the applicable local time where the associated event is taking place. Caution should be used when processing times of this nature as the papiNet approach may be in discord with other users of XML.

ProductPerformanceLineItem

Information for each item in the ProductPerformance e-Document.

ItemType [attribute]

ItemType is mandatory. A single instance is required.

Indicates the form of the item being

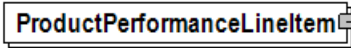

reported as being used. Many of the ItemType(s) indicated here have a corresponding named element equivalent, which is referenced here for definition purposes.

Refer to ItemType definition for any enumerations.

(sequence)

The sequence of items below is mandatory. A single instance is required.

ProductPerformanceLineNumber

ProductPerformanceLineNumber is mandatory. A single instance is required.

The line item identifying the one line being communicated from the Printer to Supplier.

ProductPerformanceReference

ProductPerformanceReference is optional. Multiple instances might exist.

Reference back to another e-Document.

Identifier

Identifier is mandatory. One instance is required, multiple instances might exist.

An Identifier is required for packages and items (pallets, reel packages, boxes, ream items, reel items, etc). The Identifier element contains the actual item identifier code. Identifier is repeatable so more than one identifier can be communicated. For example, the printed identifier on a label may be different from the barcode printed on the label.

LocationParty

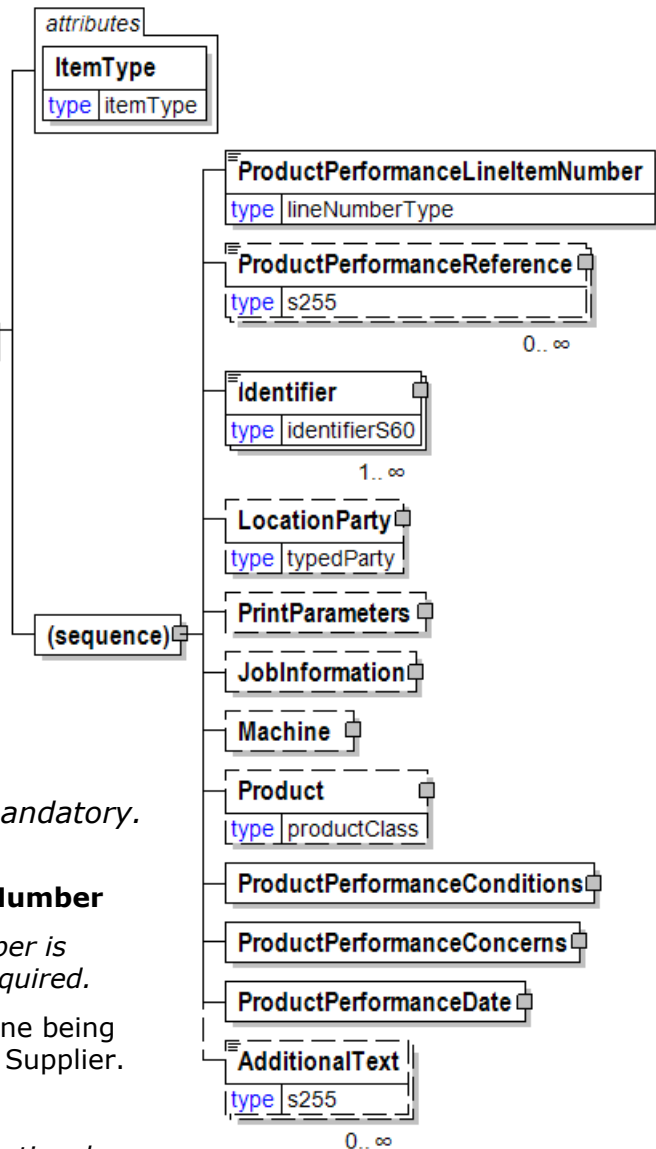

LocationParty is optional. A single instance might exist.

The organization or business entity where the business event took place or will take place.

PrintParameters

PrintParameters is optional. A single instance might exist.

PrintParameters is optional. The set up parameters of how a print machine or print job is within this construct.

JobInformation

JobInformation is optional. A single instance might exist.

JobInformation is optional. This construct captures information specific to the entire job set up.

Machine

Machine is optional. A single instance might exist.

Machine is used to capture information specific to the particular machine used in the conversion or consumption process.

Product

Product is optional. A single instance might exist.

Product is a group item defining the article and its characteristics. Product is used to specify product characteristics organized by ProductIdentifier, ProductDescription, and Classification. Book Manufacturing, Label Stock, Paper, Pulp, Recovered Paper, Wood Products, and Virgin Fibre market segments have defined their product characteristics and conversion features for implementation in papiNet.

ProductPerformanceConditions

ProductPerformanceConditions is mandatory. A single instance is required.

The ProductPerformanceConditions, while not absolutely necessary to determine whether there is a product concern is available.

ProductPerformanceConcerns

ProductPerformanceConcerns is mandatory. A single instance is required.

A grouping element used to hold information about the product performance concerns.

ProductPerformanceDate

ProductPerformanceDate is mandatory. A single instance is required.

The date the e-Document was issued.

AdditionalText

AdditionalText is optional. Multiple instances might exist.

A text field that is used to communicate information not previously defined or for special instructions. To be used only for circumstances not covered by specific elements.

ProductPerformanceLineItemNumber

The line item identifying the one line being communicated from the Printer to Supplier.

ProductPerformanceLineItemNumber	
type	lineNumberType

ProductPerformanceNumber

The report number used to identify the entire ProductPerformance.

ProductPerformanceNumber	
type	s30

ProductPerformanceReference

Reference back to another e-Document.

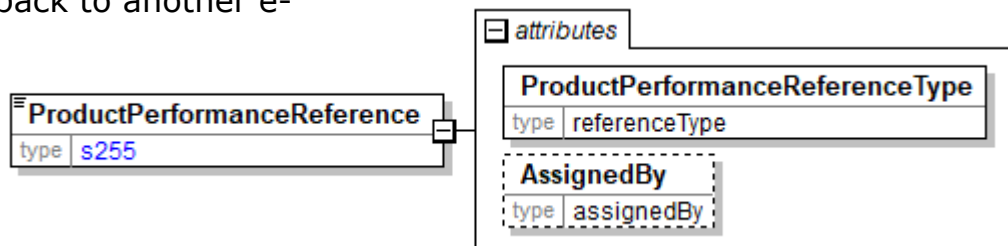

ProductPerformanceReferenceType [attribute]

ProductPerformanceReferenceType is mandatory. A single instance is required.

Provides a contextual explanation of the specific reference identifier. Many items are currently prefixed by "Buyer", "Forwarder", "Manufacturer", "Mill", "Seller", "Supplier", "Warehouse", or "Vendor". Check for an existing non-prefixed version and use the non-prefixed version instead. In the (yet to be announced release date) version 3.0 the prefixed versions will be removed. Instead the attribute @AssignedBy will communicate the information previously communicated in the prefix.

Refer to ProductPerformanceReferenceType definition for any enumerations.

AssignedBy [attribute]

AssignedBy is optional. A single instance might exist.

Identifies the type of party or the agency that has assigned the associated item, e.g. a reference of type OrderNumber.

Refer to AssignedBy for any enumerations.

ProductPerformanceReferenceType [attribute]

Provides a contextual explanation of the specific reference identifier. Many items are currently prefixed by "Buyer", "Forwarder", "Manufacturer", "Mill", "Seller", "Supplier", "Warehouse", or "Vendor". Check for an existing non-prefixed version and use the non-prefixed version instead. In the (yet to be announced release date)

attribute	
ProductPerformanceReferenceType	
type	referenceType

version 3.0 the prefixed versions will be removed. Instead the attribute @AssignedBy will communicate the information previously communicated in the prefix.

Refer to the [referenceType](#) entry for the list of enumerations and their definitions.

ProductPerformanceStatusType [attribute]

ProductPerformanceStatusType

This item is restricted to the following list.

Original

The supplied information is the first version of that information.

Replaced

The supplied information is replacing earlier supplied information. The receiver should revalidate the information in their system based upon the entire information received.

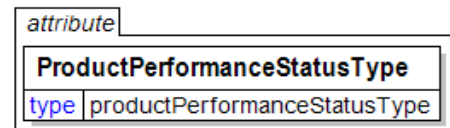

ProductPerformanceSummary

Summary information for the items on the ProductPerformance e-Document

(sequence)

The sequence of items below is mandatory. A single instance is required.

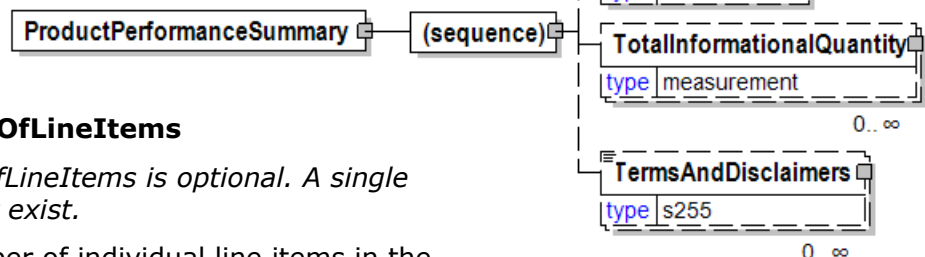

TotalNumberOfLineItems

TotalNumberOfLineItems is optional. A single instance might exist.

The total number of individual line items in the document, regardless of the status or type.

TotalQuantity

TotalQuantity is optional. A single instance might exist.

The total quantity of similar items in the e-Document. TotalQuantity is primarily used in the summary section of documents where it is repeatable to permit totaling for different units of measure.

TotalInformationalQuantity

TotalInformationalQuantity is optional. Multiple instances might exist.

A quantity that is used to communicate related information about the parent element. This element represents a total that is derived from individual line items.

TermsAndDisclaimers

TermsAndDisclaimers is optional. Multiple instances might exist.

An element that contains legal information with an indication of what the Language is.

ProductQuality

The ProductQuality element is the root element for the ProductQuality e-Document.

The

ProductQuality e-Document supports the exchange of quality data for individual items. The agreed properties of the product that are exchanged can include statistical values such as minimum and maximum, standard deviation, sample size, two sigma (lower-limit, upper-limit).

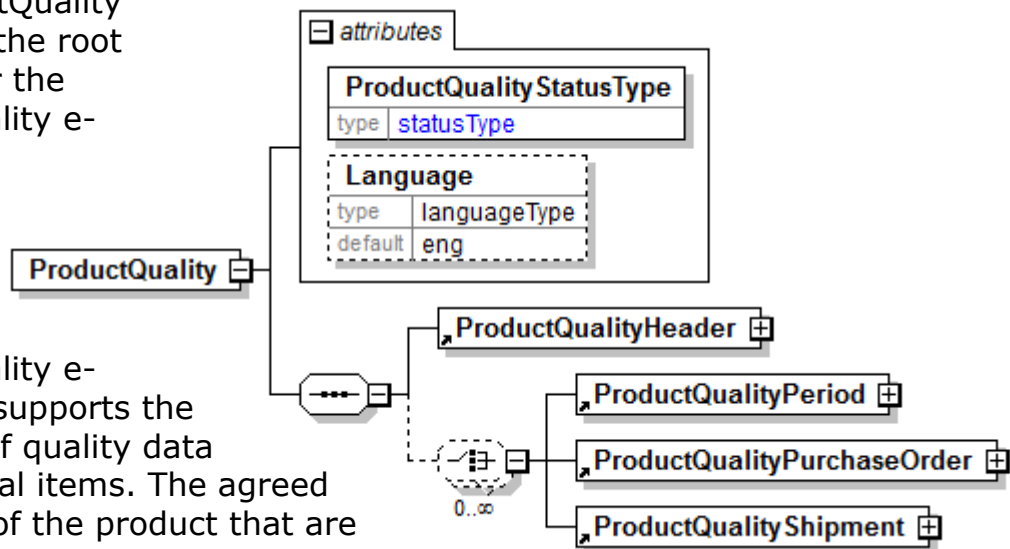

ProductQualityStatusType [attribute]

ProductQualityStatusType is mandatory. A single instance is required.

Communicates the status of the ProductQuality e-Document

Refer to ProductQualityStatusType definition for any enumerations.

Language [attribute]

Language is optional. A single instance might exist.

The valid Alpha 2- and Alpha 3-character list of language codes in the ISO 639-1 and 639-2 international standards.

Information on the content of this attribute is available at:
https://www.loc.gov/standards/iso639-2/php/code_list.php

(sequence)

The sequence of items below is mandatory. A single instance is required.

ProductQualityHeader

ProductQualityHeader is mandatory. A single instance is required.

Information the common to all items on the ProductQuality e-Document.

(choice)

[choice] is optional. Multiple instances might exist.

ProductQualityPeriod

ProductQualityPeriod is mandatory. A single instance is required.

ProductQualityPeriod

ProductQualityPurchaseOrder

ProductQualityPurchaseOrder is mandatory. A single instance is required.

Multiple instances of purchase order information is allowed to support a list of purchase orders manufactured during the indicated period. Alternatively, ProductQualityPeriod may be repeated with the same TimePeriod for each PurchaseOrder if the quality data is available at this level of detail.

ProductQualityShipment

ProductQualityShipment is mandatory. A single instance is required.

Product quality information communicated by shipment.

ProductQualityHeader

Information the common to all items on the ProductQuality e-Document.

(sequence)

The sequence of items below is mandatory. A single instance is required.

ProductQualityIssueDate

ProductQualityIssueDate is mandatory. A single instance is required.

The date and time the ProductQuality was issued.

ProductQualityMessageNumber

ProductQualityMessageNumber is mandatory. A single instance is required.

A unique identifier assigned to each e-Document for identification purposes.

Subsequent ProductQuality e-Documents with updates or cancellations will use this same ProductQualityMessageNumber.

RequestNumber

RequestNumber is optional. A single instance might exist.

A unique tracking number specifically identifying the InfoRequest e-Document to the originator. The tracking number is returned with the "information", the answer, to help match the answer to the request.

TransactionHistoryNumber

TransactionHistoryNumber is optional. A single instance might exist.

A sequential number that keeps track of the version of a document.

However when the document is a confirmation document, in which case the TransactionHistoryNumber refers to the trigger transaction for the confirmation.

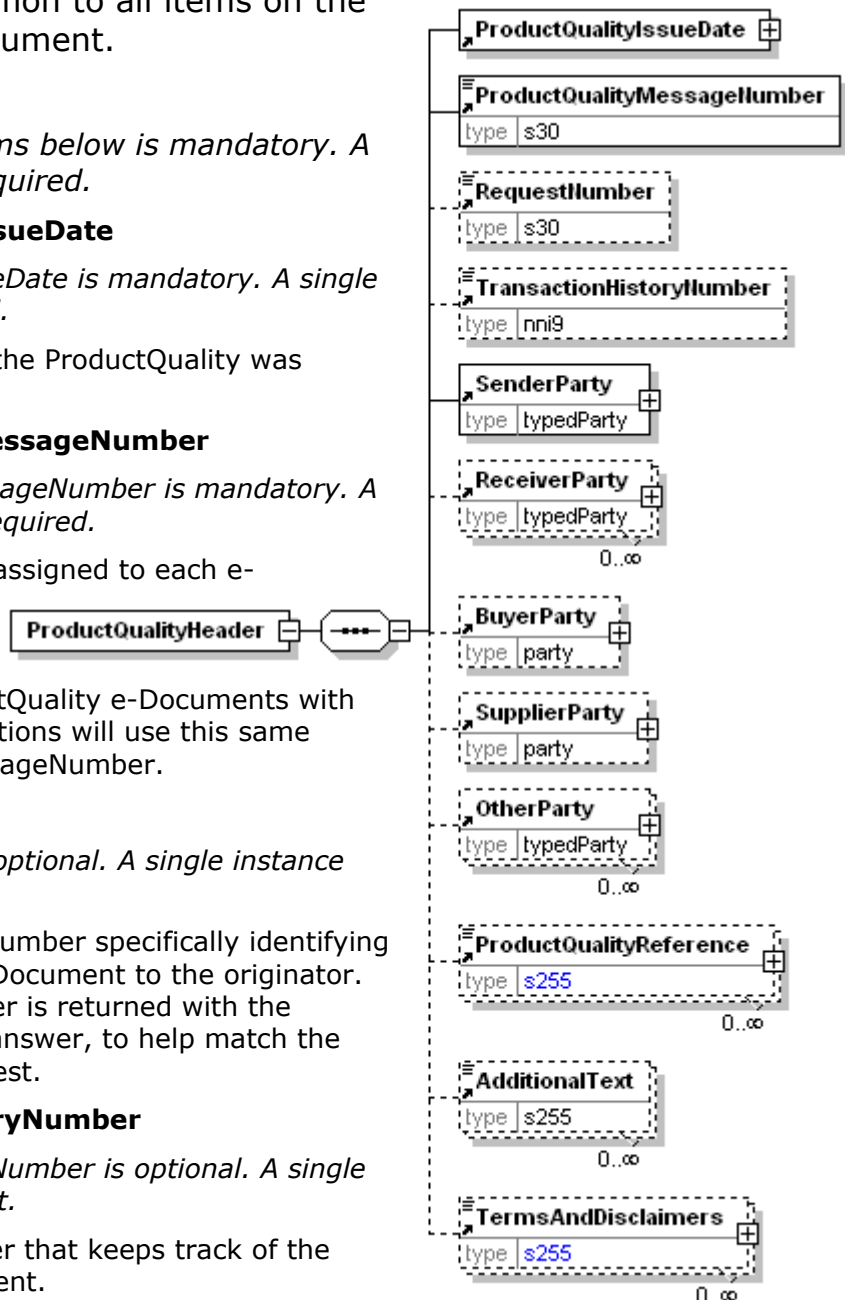

SenderParty

SenderParty is optional. A single instance might exist.

The business entity issuing the e-Document, the source of the document.

The entity responsible for the content. If the sender party has out sourced the message service to a third party the SenderParty is the issuer of the e-Document and not the party performing the transmission service of the electronic message.

ReceiverParty

ReceiverParty is optional. Multiple instances might exist.

The business entity for whom the e-Document is intended, the destination of the document.

The entity interested in the content. If the receiver party has outsourced the message service to a third party the ReceiverParty is the intended party for the e-Document and not the party performing the receiving service of the electronic message.

BuyerParty

BuyerParty is optional. A single instance might exist.

The legal entity to which the product is sold. Also commonly referred to as the sold-to party or customer. If no OtherParty is defined as the Payer, the Buyer is the Payer.

SupplierParty

SupplierParty is optional. A single instance might exist.

The organisation or business entity responsible for providing the product. SupplierParty is also the seller of the product, if Seller is not specified as OtherParty = Seller.

OtherParty

OtherParty is optional. Multiple instances might exist.

An organisation or business entity other than those specifically detailed within an e-Document.

ProductQualityReference

ProductQualityReference is optional. Multiple instances might exist.

An element detailing relevant references pertaining to the ProductQuality.

AdditionalText

AdditionalText is optional. Multiple instances might exist.

A text field that is used to communicate information not previously defined or for special instructions. To be used only for circumstances not covered by specific elements.

TermsAndDisclaimers

TermsAndDisclaimers is optional. Multiple instances might exist.

An element that contains legal information with an indication of what the Language is.

ProductQualityIssueDate

The date and time the ProductQuality was issued.

(sequence)

The sequence of items below is mandatory. A single instance is required.

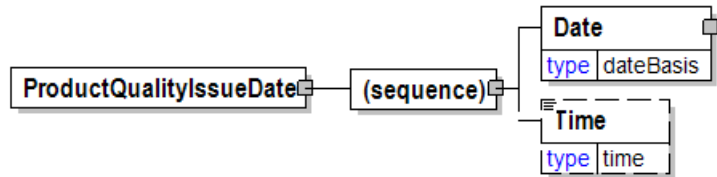

Date

Date is mandatory. A single instance is required.

A group element that contains the specification of Year, Month, and Day.

Time

Time is optional. A single instance might exist.

Times are treated in a standard XML fashion with a special case used to indicate a generalized "local" time. The standard XML approach to time is hh:mm:ss, hh:mm:ssZ, or hh:mm:ss±hh:mm.

hh:mm:ss±hh:mm is used to represent a time with a time zone. The time zone is communicated as the number of hours offset from the Universal Time Coordinate (UTC), a.k.a. Greenwich Mean Time.

hh:mm:ssZ indicates the time at Zulu (another name for UTC).

hh:mm:ss or hh:mm indicates within papiNet the applicable local time where the associated event is taking place. Caution should be used when processing times of this nature as the papiNet approach may be in discord with other users of XML.

ProductQualityMessageNumber

A unique identifier assigned to each e-Document for identification purposes. Subsequent ProductQuality e-Documents with updates or cancellations will use this same ProductQualityMessageNumber.



ProductQualityPeriod

ProductQualityPeriod

(sequence)

The sequence of items below is mandatory. A single instance is required.

TimePeriod

TimePeriod is mandatory. A single instance is required.

The TimePeriod element is used to communicate a duration period of time as indicated in PeriodType.

Product

Product is mandatory. A single instance is required.

Product is a group item defining the article and its characteristics. Product is used to specify product characteristics organized by ProductIdentifier, ProductDescription, and



Classification. Book Manufacturing, Label Stock, Paper, Pulp, Recovered Paper, Wood Products, and Virgin Fibre market segments have defined their product characteristics and conversion features for implementation in papiNet.

(sequence)

The sequence of items below is optional. Multiple instances might exist.

PurchaseOrderInformation

PurchaseOrderInformation is mandatory. A single instance is required.

A group item containing information unique to this PurchaseOrder, which is provided by the buyer. PurchaseOrderInformation can be optional in the supply chain. Invoices are created without having a PurchaseOrder in Vendor Managed Inventory. Freight invoices also will not have a PurchaseOrder number.

PurchaseOrderLineNumber

PurchaseOrderLineNumber is optional. A single instance might exist.

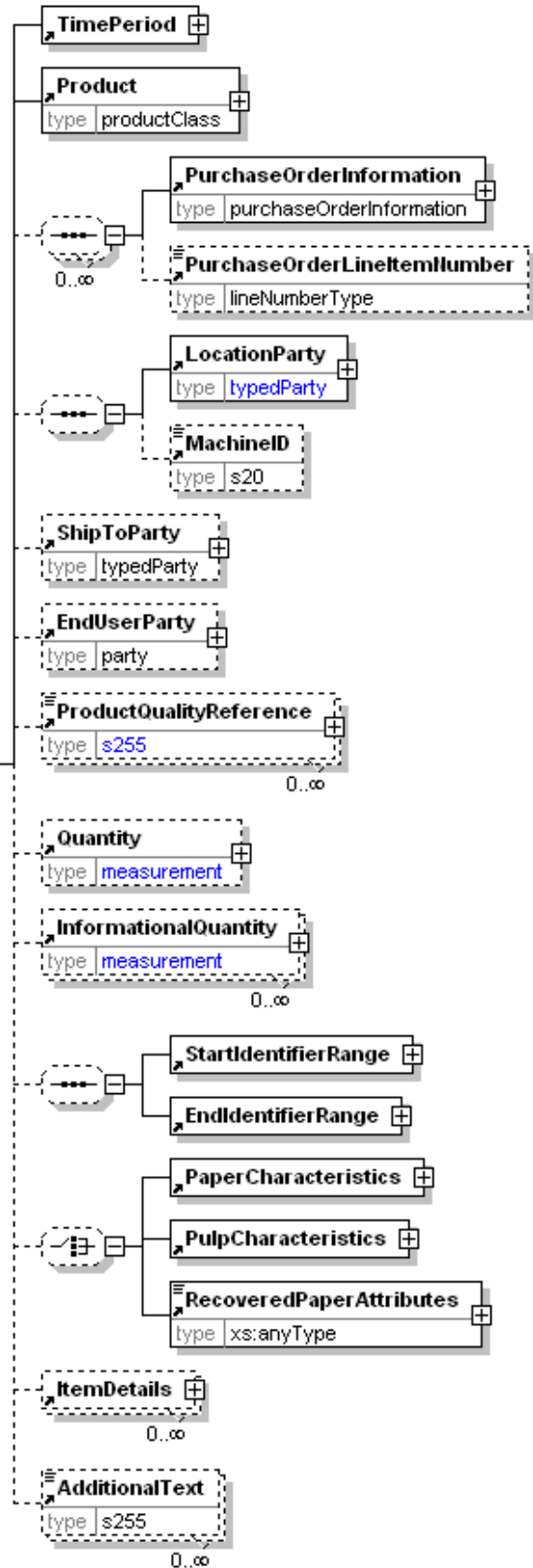

papiNet V2R31

The sequential number that uniquely identifies the PurchaseOrder line item.

(sequence)

The sequence of items below is optional. A single instance might exist.

LocationParty

LocationParty is mandatory. A single instance is required.

The organization or business entity where the business event took place or will take place.

MachineID

MachineID is optional. A single instance might exist.

An identifier assigned to the particular machine being referenced. For example, a machine could be a paper machine, an off-line coater, a sheeter, or a printing press. The particular machine being referenced will be determined by the business event being supported.

ShipToParty

ShipToParty is optional. A single instance might exist.

The name and/or address to which the goods should be delivered with the party type indicated by the PartyType attribute.

EndUserParty

EndUserParty is optional. A single instance might exist.

The party using, consuming, or converting the product. For example, a printer using paper reels for a print job for a publisher. The final ShipTo destination for a product is normally to the end user's facilities.

ProductQualityReference

ProductQualityReference is optional. Multiple instances might exist.

An element detailing relevant references pertaining to the ProductQuality.

Quantity

Quantity is optional. A single instance might exist.

The Quantity element contains attributes that provide information about the type of quantity that is being communicated, the context in which the particular quantity is to be viewed, and (if the quantity represents an adjustment) an adjustment type.

The Quantity element contains three child elements that enable you to communicate a range of values for the quantity and a target or actual value. It is at this level (Value, RangeMin, and RangeMax) that the unit of measure is specified. This permits the range to be specified in a different unit of measure than the target.

InformationalQuantity

InformationalQuantity is optional. Multiple instances might exist.

A quantity given in a valid UOM used for information purposes only (not for calculation). For example, an ordered quantity was 100 reels as opposed to the invoice quantity of 20,000 pounds.

(sequence)

The sequence of items below is optional. A single instance might exist.

StartIdentifierRange

StartIdentifierRange is mandatory. A single instance is required.

papiNet V2R31

An element that identifies the starting item identifier in the range of items that contributed to the aggregated measurements for the range.

EndIdentifierRange

EndIdentifierRange is mandatory. A single instance is required.

A group element that identifies the ending item identifier in the range of items that contributed to the aggregated measurements for the range.

(choice)

[choice] is optional. A single instance might exist.

PaperCharacteristics

PaperCharacteristics is mandatory. A single instance is required.

The identifying characteristics of paper most important to the ordering of the item. These are the characteristics that, when associated with a given grade, allow the manufacturer to produce but not convert or package, the paper.

PulpCharacteristics

PulpCharacteristics is mandatory. A single instance is required.

The physical and chemical characteristics of the pulp product regardless of the form that it is taking.

RecoveredPaperAttributes

RecoveredPaperAttributes is mandatory. A single instance is required.

The attributes of Recovered Paper.

ItemDetails

ItemDetails is optional. Multiple instances might exist.

A group element that identifies a specific item and measured attribute values for that item.

AdditionalText

AdditionalText is optional. Multiple instances might exist.

A text field that is used to communicate information not previously defined or for special instructions. To be used only for circumstances not covered by specific elements.

ProductQualityPurchaseOrder

Multiple instances of PurchaseOrder information is allowed to support a list of purchase orders manufactured during the indicated period. Alternatively, ProductQualityPeriod may be repeated with the same TimePeriod for each PurchaseOrder if the quality data is available at this level of detail.

(sequence)

The sequence of items below is mandatory. A single instance is required.

PurchaseOrderInformation

PurchaseOrderInformation is mandatory. A single instance is required.

A group item containing information unique to this PurchaseOrder, which

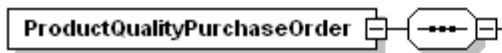

is provided by the buyer. PurchaseOrderInformation can be optional in the supply chain. Invoices are created without having a PurchaseOrder in Vendor Managed Inventory. Freight invoices also will not have a PurchaseOrder number.

PurchaseOrderLineNumber

PurchaseOrderLineNumber is optional. A single instance might exist.

The sequential number that uniquely identifies the PurchaseOrder line item.

Product

Product is mandatory. A single instance is required.

Product is a group item defining the article and its characteristics. Product is used to specify product characteristics organized by ProductIdentifier, ProductDescription, and Classification. Book Manufacturing, Label Stock, Paper, Pulp, Recovered Paper, Wood Products, and Virgin Fibre market segments have defined their product characteristics and conversion features for implementation in papiNet.

(sequence)

The sequence of items below is optional. A single instance might exist.

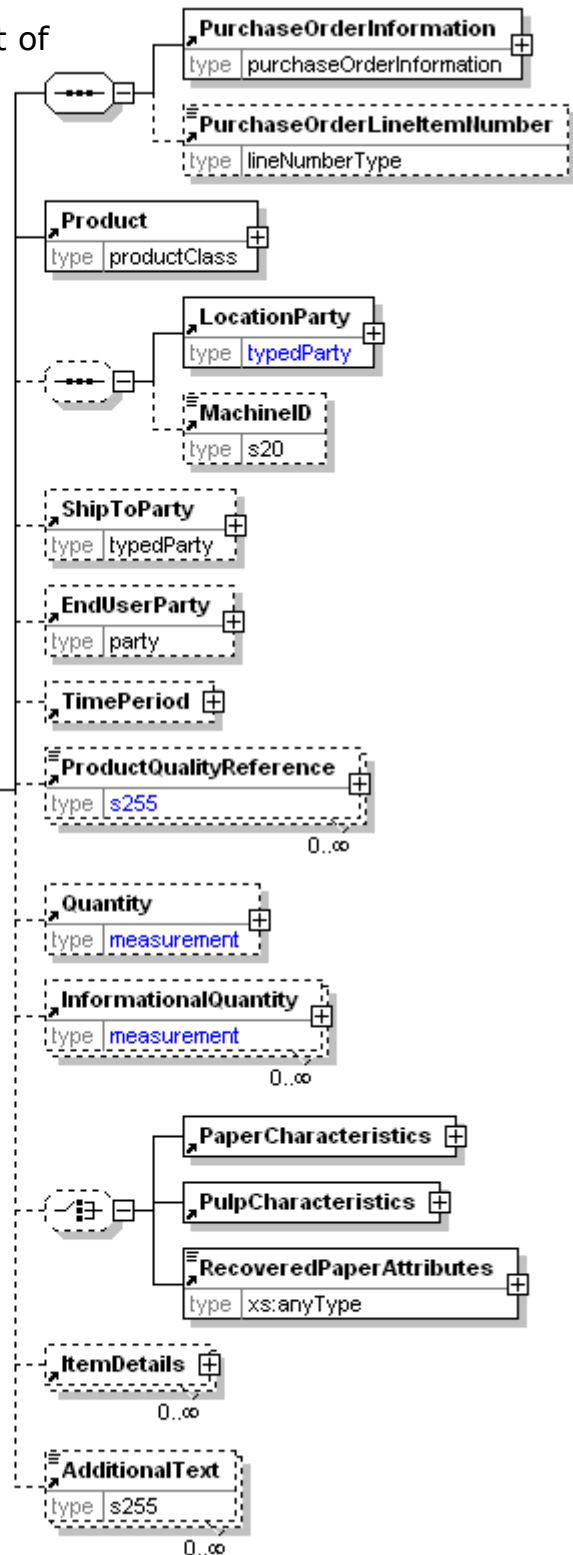

LocationParty

LocationParty is mandatory. A single instance is required.

The organization or business entity where the business event took place or will take place.

MachineID

MachineID is optional. A single instance might exist.

An identifier assigned to the particular machine being referenced. For example, a machine could be a paper machine, an off-line coater, a sheeter, or a printing press. The particular machine being referenced will be determined by the business event being supported.

ShipToParty

ShipToParty is optional. A single instance might exist.

The name and/or address to which the goods should be delivered with the party type indicated by the PartyType attribute.

EndUserParty

EndUserParty is optional. A single instance might exist.

The party using, consuming, or converting the product. For example, a printer using paper reels for a print job for a publisher. The final ShipTo destination for a product is normally to the end user's facilities.

TimePeriod

TimePeriod is optional. A single instance might exist.

The TimePeriod element is used to communicate a duration period of time as indicated in PeriodType.

ProductQualityReference

ProductQualityReference is optional. Multiple instances might exist.

An element detailing relevant references pertaining to the ProductQuality.

Quantity

Quantity is optional. A single instance might exist.

The Quantity element contains attributes that provide information about the type of quantity that is being communicated, the context in which the particular quantity is to be viewed, and (if the quantity represents an adjustment) an adjustment type.

The Quantity element contains three child elements that enable you to communicate a range of values for the quantity and a target or actual value. It is at this level (Value, RangeMin, and RangeMax) that the unit of measure is specified. This permits the range to be specified in a different unit of measure than the target.

InformationalQuantity

InformationalQuantity is optional. Multiple instances might exist.

A quantity given in a valid UOM used for information purposes only (not for calculation). For example, an ordered quantity was 100 reels as opposed to the invoice quantity of 20,000 pounds.

(choice)

[choice] is optional. A single instance might exist.

PaperCharacteristics

papiNet V2R31

PaperCharacteristics is mandatory. A single instance is required.

The identifying characteristics of paper most important to the ordering of the item. These are the characteristics that, when associated with a given grade, allow the manufacturer to produce but not convert or package, the paper.

PulpCharacteristics

PulpCharacteristics is mandatory. A single instance is required.

The physical and chemical characteristics of the pulp product regardless of the form that it is taking.

RecoveredPaperAttributes

RecoveredPaperAttributes is mandatory. A single instance is required.

The attributes of Recovered Paper.

ItemDetails

ItemDetails is optional. Multiple instances might exist.

A group element that identifies a specific item and measured attribute values for that item.

AdditionalText

AdditionalText is optional. Multiple instances might exist.

A text field that is used to communicate information not previously defined or for special instructions. To be used only for circumstances not covered by specific elements.

ProductQualityReference

An element detailing relevant references pertaining to the ProductQuality.

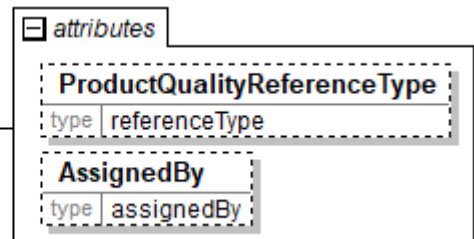
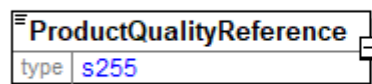

ProductQualityReferenceType [attribute]

ProductQualityReferenceType is optional. A single instance might exist.

Provides a contextual explanation of the specific reference identifier. Many items are currently prefixed by "Buyer", "Forwarder", "Manufacturer", "Mill", "Seller", "Supplier", "Warehouse", or "Vendor". Check for an existing non-prefixed version and use the non-prefixed version instead. In the (yet to be announced release date) version 3.0 the prefixed versions will be removed. Instead the attribute @AssignedBy will communicate the information previously communicated in the prefix.

Refer to ProductQualityReferenceType definition for any enumerations.

AssignedBy [attribute]

AssignedBy is optional. A single instance might exist.

Identifies the type of party or the agency that has assigned the associated item, e.g. a reference of type OrderNumber.

Refer to AssignedBy definition for any enumerations.

ProductQualityReferenceType [attribute]

Provides a contextual explanation of the specific reference identifier. Many items are currently prefixed by "Buyer", "Forwarder", "Manufacturer", "Mill", "Seller", "Supplier", "Warehouse", or "Vendor". Check for an existing non-prefixed version and use the non-prefixed version instead. In the (yet to be announced release date) version 3.0 the prefixed versions will be removed. Instead the attribute @AssignedBy will communicate the information previously communicated in the prefix.

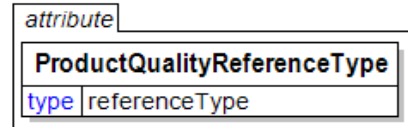

Refer to the [referenceType](#) entry for the list of enumerations and their definitions.

ProductQualityRequestDetail

A grouping element that provides the parameters to be used when responding with a ProductQuality e-Document.

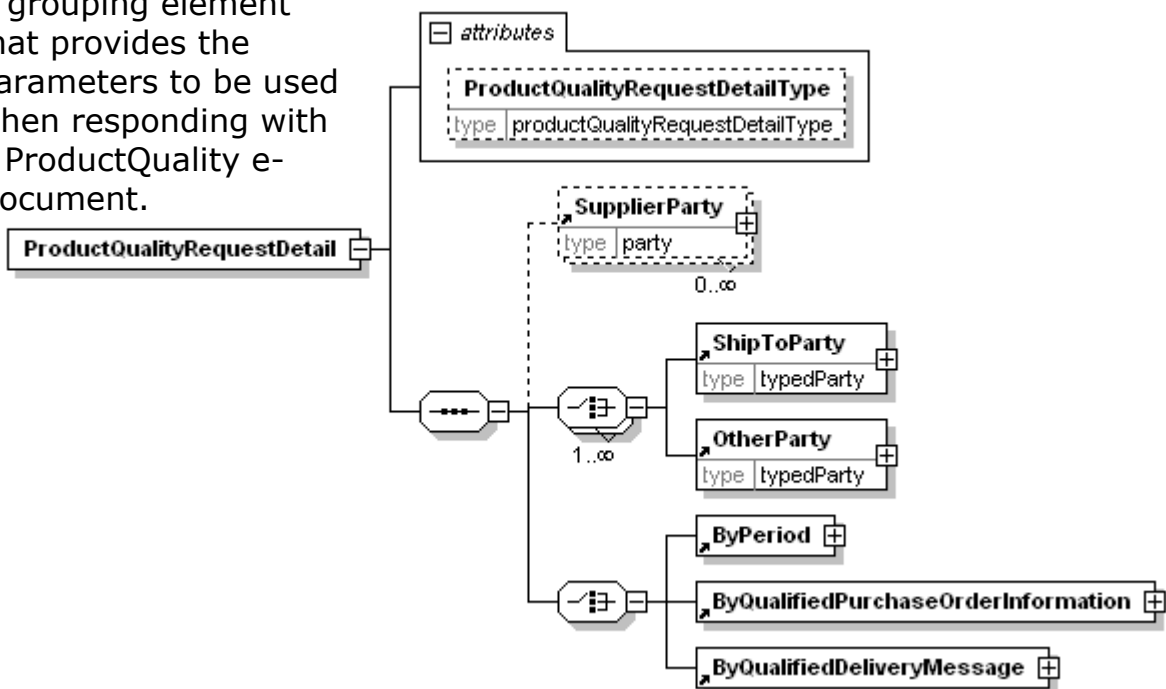

ProductQualityRequestDetailType [attribute]

ProductQualityRequestDetailType is optional. A single instance might exist. Communicates the method in which the ProductQuality should be reported. Refer to ProductQualityRequestDetailType definition for any enumerations.

(sequence)

The sequence of items below is mandatory. A single instance is required.

SupplierParty

SupplierParty is optional. Multiple instances might exist.

papiNet V2R31

The organisation or business entity responsible for providing the product. SupplierParty is also the seller of the product, if Seller is not specified as OtherParty = Seller.

(choice)

[choice] is mandatory. One instance is required, multiple instances might exist.

ShipToParty

ShipToParty is mandatory. A single instance is required.

The name and/or address to which the goods should be delivered with the party type indicated by the PartyType attribute.

OtherParty

OtherParty is mandatory. A single instance is required.

An organisation or business entity other than those specifically detailed within an e-Document.

(choice)

[choice] is mandatory. A single instance is required.

ByPeriod

ByPeriod is mandatory. A single instance is required.

The information is supplied by the specified period.

ByQualifiedPurchaseOrderInformation

ByQualifiedPurchaseOrderInformation is mandatory. A single instance is required.

Specifies that the information is supplied by a PurchaseOrder. The use of the term "qualified" is to indicate that PurchaseOrderInformation is qualified by the use of PurchaseOrderLineNumber.

ByQualifiedDeliveryMessage

ByQualifiedDeliveryMessage is mandatory. A single instance is required.

Specifies that the information is supplied by a DeliveryMessage. The use of the term "qualified" is to indicate that DeliveryMessageNumber is qualified by the use of DeliveryMessageLineNumber.

ProductQualityRequestDetailType [attribute]

Communicates the method in which the ProductQuality should be reported.

This item is restricted to the following list.

ByPeriod

The information is supplied by the specified period.

ByQualifiedPurchaseOrderInformation

The information is supplied by a PurchaseOrder that has additional items associated with it.

ByShipment

The information is supplied by a shipment, i.e. by a DeliveryMessage.

ProductQualityShipment

Product quality information communicated by shipment.

(sequence)

The sequence of items below is mandatory. A single instance is required.

DeliveryMessageNumber

DeliveryMessageNumber is mandatory. A single instance is required.

A unique delivery identifier assigned to each DeliveryMessage as agreed between the trading partners.

DeliveryMessageLineItemNumber

DeliveryMessageLineItemNumber is optional. A single instance might exist.

The sequential number that uniquely identifies the delivery line item.

TransportVehicleCharacteristics

TransportVehicleCharacteristics is optional. A single instance might exist.

A group item containing information about a transport vehicle, e.g. a truck. A transport vehicle has its own power and can be used to pull, push, carry, or tow a transport unit loaded with goods.

TransportUnitCharacteristics

TransportUnitCharacteristics is optional. A single instance might exist.

A group item containing information about a transport unit, e.g. a trailer. Transport units contain goods and move using power from another source, the transport vehicle.

Product

Product is mandatory. A single instance is required.

Product is a group item defining the article and its characteristics. Product is used to specify product characteristics organized by ProductIdentifier, ProductDescription, and Classification. Book Manufacturing, Label Stock, Paper, Pulp, Recovered Paper, Wood Products, and Virgin Fibre market segments have defined their product characteristics and conversion features for implementation in papiNet.

(sequence)

The sequence of items below is optional. A single instance might exist.

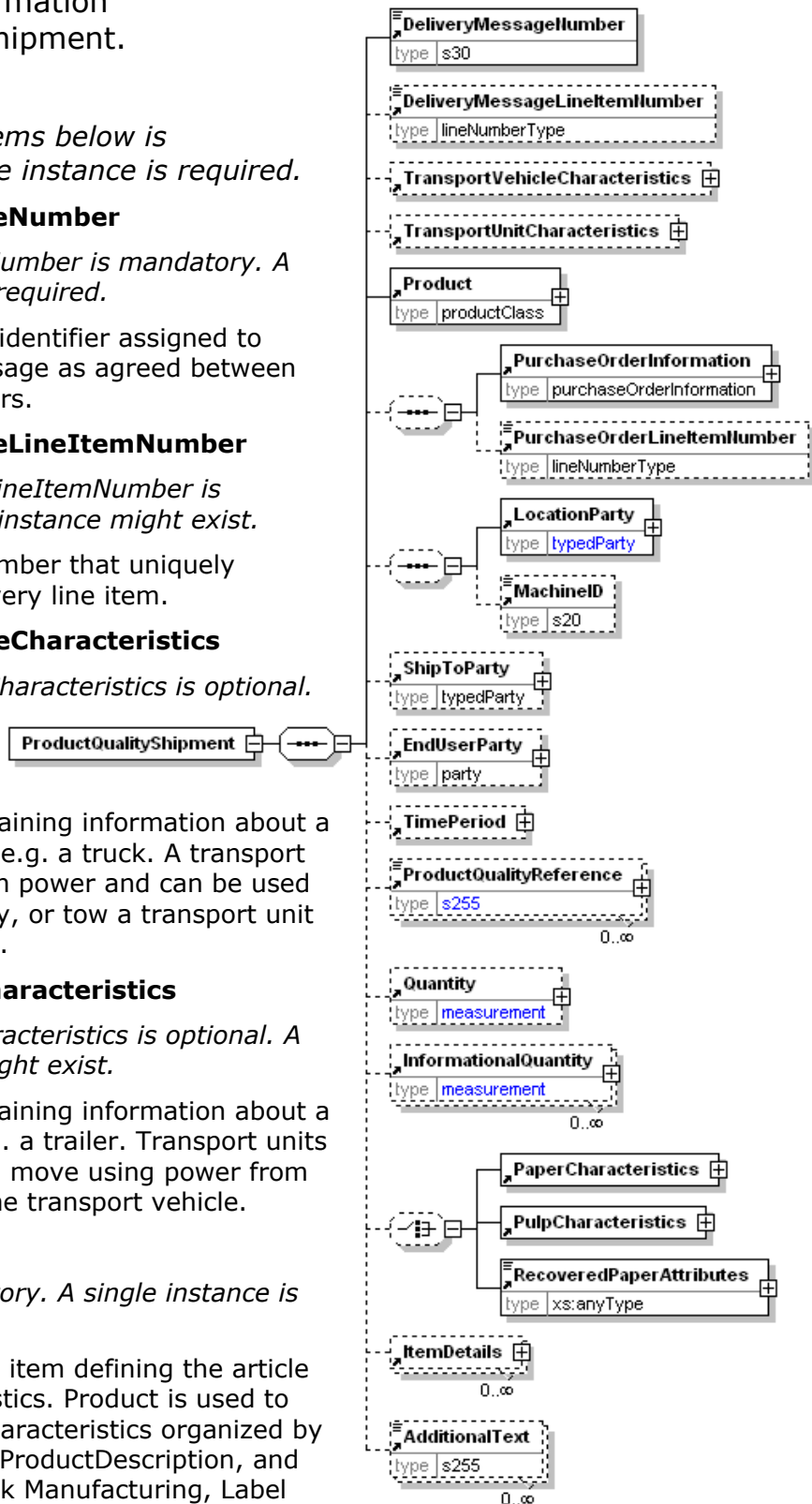

PurchaseOrderInformation

PurchaseOrderInformation is mandatory. A single instance is required.

A group item containing information unique to this PurchaseOrder, which is provided by the buyer. PurchaseOrderInformation can be optional in the supply chain. Invoices are created without having a PurchaseOrder in Vendor Managed Inventory. Freight invoices also will not have a PurchaseOrder number.

PurchaseOrderLineItemNumber

PurchaseOrderLineItemNumber is optional. A single instance might exist.

The sequential number that uniquely identifies the PurchaseOrder line item.

(sequence)

The sequence of items below is optional. A single instance might exist.

LocationParty

LocationParty is mandatory. A single instance is required.

The organization or business entity where the business event took place or will take place.

MachineID

MachineID is optional. A single instance might exist.

An identifier assigned to the particular machine being referenced. For example, a machine could be a paper machine, an off-line coater, a sheeter, or a printing press. The particular machine being referenced will be determined by the business event being supported.

ShipToParty

ShipToParty is optional. A single instance might exist.

The name and/or address to which the goods should be delivered with the party type indicated by the PartyType attribute.

EndUserParty

EndUserParty is optional. A single instance might exist.

The party using, consuming, or converting the product. For example, a printer using paper reels for a print job for a publisher. The final ShipTo destination for a product is normally to the end user's facilities.

TimePeriod

TimePeriod is optional. A single instance might exist.

The TimePeriod element is used to communicate a duration period of time as indicated in PeriodType.

ProductQualityReference

ProductQualityReference is optional. Multiple instances might exist.

An element detailing relevant references pertaining to the ProductQuality.

Quantity

Quantity is optional. A single instance might exist.

The Quantity element contains attributes that provide information about the type of quantity that is being communicated, the context in which the particular quantity is to be viewed, and (if the quantity represents an adjustment) an adjustment type.

The Quantity element contains three child elements that enable you to communicate a range of values for the quantity and a target or actual value. It is at

papiNet V2R31

this level (Value, RangeMin, and RangeMax) that the unit of measure is specified. This permits the range to be specified in a different unit of measure than the target.

InformationalQuantity

InformationalQuantity is optional. Multiple instances might exist.

A quantity given in a valid UOM used for information purposes only (not for calculation). For example, an ordered quantity was 100 reels as opposed to the invoice quantity of 20,000 pounds.

(choice)

[choice] is optional. A single instance might exist.

PaperCharacteristics

PaperCharacteristics is mandatory. A single instance is required.

The identifying characteristics of paper most important to the ordering of the item. These are the characteristics that, when associated with a given grade, allow the manufacturer to produce but not convert or package, the paper.

PulpCharacteristics

PulpCharacteristics is mandatory. A single instance is required.

The physical and chemical characteristics of the pulp product regardless of the form that it is taking.

RecoveredPaperAttributes

RecoveredPaperAttributes is mandatory. A single instance is required.

The attributes of Recovered Paper.

ItemDetails

ItemDetails is optional. Multiple instances might exist.

A group element that identifies a specific item and measured attribute values for that item.

AdditionalText

AdditionalText is optional. Multiple instances might exist.

A text field that is used to communicate information not previously defined or for special instructions. To be used only for circumstances not covered by specific elements.

ProductQualityStatusType [attribute]

Communicates the status of the ProductQuality e-Document

This item is restricted to the following list.

Cancelled

The supplied information has been cancelled. Items that have been cancelled are not included in totals on the summary levels of the e-Document.

Original

The supplied information is the first version of that information.

Replaced

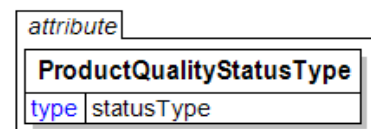

The supplied information is replacing earlier supplied information. The receiver should revalidate the information in their system based upon the entire information received.

ProductRankingOrder [attribute]

Defines the order of products to choose when available product properties are applicable to specifications of more than one product. ProductRankingOrder is a positive number. Value 1 has the highest rank.



ProductReference

An element detailing relevant references pertaining to the Product as indicated by ProductReferenceType and AssignedBy.

ProductReferenceType [attribute]

ProductReferenceType is mandatory. A single instance is required.

Provides a contextual explanation of the specific reference identifier. Many items are currently prefixed by "Buyer", "Forwarder", "Manufacturer", "Mill", "Seller", "Supplier", "Warehouse", or "Vendor". Check for an existing non-prefixed version and use the non-prefixed version instead. In the (yet to be announced release date) version 3.0 the prefixed versions will be removed. Instead the attribute @AssignedBy will communicate the information previously communicated in the prefix.

Refer to ProductReferenceType definition for any enumerations.

AssignedBy [attribute]

AssignedBy is optional. A single instance might exist.

Identifies the type of party or the agency that has assigned the associated item, e.g. a reference of type OrderNumber.

Refer to AssignedBy for any enumerations.

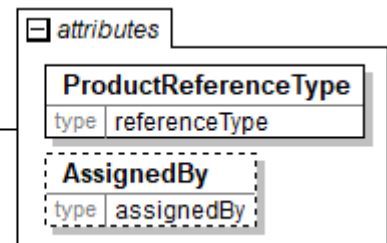
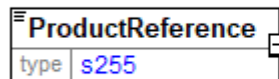

ProductReferenceType [attribute]

Provides a contextual explanation of the specific reference identifier. Many items are currently prefixed by "Buyer", "Forwarder", "Manufacturer", "Mill", "Seller", "Supplier", "Warehouse" or "Vendor". Check for an existing non-prefixed version and use the non-prefixed version instead.

In the (yet to be announced release date) version 3.0 the prefixed versions will be removed. Instead the attribute AssignedBy will communicate the information previously

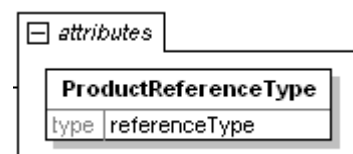

communicated in the prefix.

Refer to the [referenceType](#) entry for the list of enumerations and their definitions.

ProductSummary

Group of elements to provide summary information on product level.

(sequence)

The sequence of items below is mandatory. A single instance is required.

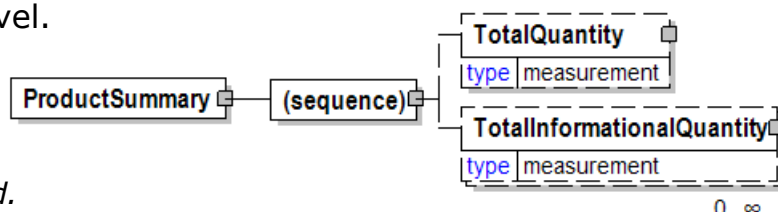

TotalQuantity

TotalQuantity is optional. A single instance might exist.

The total quantity of similar items in the e-Document. TotalQuantity is primarily used in the summary section of documents where it is repeatable to permit totaling for different units of measure.

TotalInformationalQuantity

TotalInformationalQuantity is optional. Multiple instances might exist.

A quantity that is used to communicate related information about the parent element. This element represents a total that is derived from individual line items.

ProductTradingRights

Identifies a country to which products can or cannot be sold or distributed.

IsCountryAllowed [attribute]

IsCountryAllowed is optional. A single instance might exist.

Indicates if sale or distribution of the product is allowed or not allowed in the country.

Refer to IsCountryAllowed definition for any enumerations.

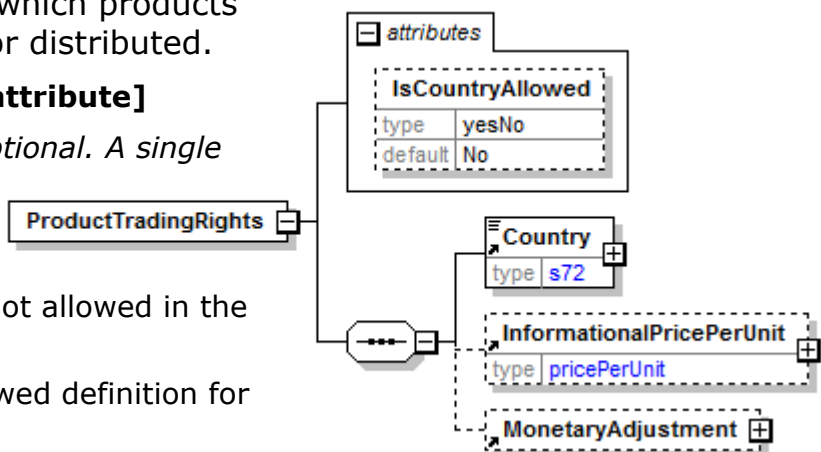

(sequence)

The sequence of items below is mandatory. A single instance is required.

Country

Country is mandatory. A single instance is required.

The name of the country associated with the address elements. To ensure reliable matching of addresses, it is suggested to use the attribute ISOCountryCode as well.

InformationalPricePerUnit

InformationalPricePerUnit is optional. A single instance might exist.

papiNet V2R31

A group item containing a currency value and a measurement value used convey a secondary PricePerUnit. For example, where PricePerUnit is dollars per ton. InformationalPricePerUnit could be dollars per kilogram.

MonetaryAdjustment

MonetaryAdjustment is optional. A single instance might exist.

The element containing the information necessary for the understanding, calculation, and treatment of an adjustment to a currency amount. MonetaryAdjustment contains an attribute that indicates they type of adjustment being communicated.

ProofApprovalDate

Date field indicating when proofs will be approved.

(sequence)

The sequence of items below is mandatory. A single instance is required.

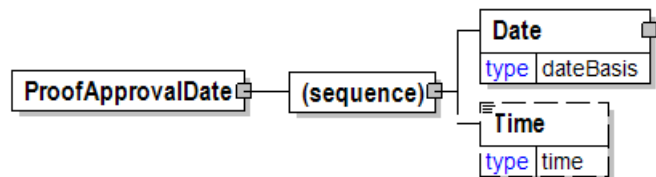

Date

Date is mandatory. A single instance is required.

A group element that contains the specification of Year, Month, and Day.

Time

Time is optional. A single instance might exist.

Times are treated in a standard XML fashion with a special case used to indicate a generalized "local" time. The standard XML approach to time is hh:mm:ss, hh:mm:ssZ, or hh:mm:ss±hh:mm.

hh:mm:ss±hh:mm is used to represent a time with a time zone. The time zone is communicated as the number of hours offset from the Universal Time Coordinate (UTC), a.k.a. Greenwich Mean Time.

hh:mm:ssZ indicates the time at Zulu (another name for UTC).

hh:mm:ss or hh:mm indicates within papiNet the applicable local time where the associated event is taking place. Caution should be used when processing times of this nature as the papiNet approach may be in discord with other users of XML.

ProofColourType [attribute]

Specifies the colouring style of the proof output.

This item is restricted to the following list.

BlackAndWhite

Colouring style is black and white.

Colour

Colouring style is with colour.



ProofDueDate

Proof due date

(sequence)

The sequence of items below is mandatory. A single instance is required.

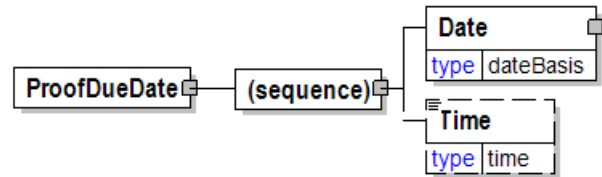

Date

Date is mandatory. A single instance is required.

A group element that contains the specification of Year, Month, and Day.

Time

Time is optional. A single instance might exist.

Times are treated in a standard XML fashion with a special case used to indicate a generalized "local" time. The standard XML approach to time is hh:mm:ss, hh:mm:ssZ, or hh:mm:ss±hh:mm.

hh:mm:ss±hh:mm is used to represent a time with a time zone. The time zone is communicated as the number of hours offset from the Universal Time Coordinate (UTC), a.k.a. Greenwich Mean Time.

hh:mm:ssZ indicates the time at Zulu (another name for UTC).

hh:mm:ss or hh:mm indicates within papiNet the applicable local time where the associated event is taking place. Caution should be used when processing times of this nature as the papiNet approach may be in discord with other users of XML.

ProofInformationalQuantity

ProofInformationalQuantity

ProofType [attribute]

ProofType is optional. A single instance might exist.

Proof Type

Refer to ProofType definition for any enumerations.

ProofColourType [attribute]

ProofColourType is optional. A single instance might exist.

Specifies the colouring style of the proof output.

Refer to ProofColourType definition for any enumerations.

(sequence)

The sequence of items below is mandatory. A single instance is required.

Quantity

Quantity is mandatory. A single instance is required.

The Quantity element contains attributes that provide information about the type of quantity that is being communicated, the context in which the particular quantity is to be viewed, and (if the quantity represents an adjustment) an adjustment type.

The Quantity element contains three child elements that enable you to communicate a range of values for the quantity and a target or actual value. It is at this level (Value, RangeMin, and RangeMax) that the unit of measure is specified. This permits the range to be specified in a different unit of measure than the target.

InformationalQuantity

InformationalQuantity is optional. Multiple instances might exist.

A quantity given in a valid UOM used for information purposes only (not for calculation). For example, an ordered quantity was 100 reels as opposed to the invoice quantity of 20,000 pounds.

OtherParty

OtherParty is optional. A single instance might exist.

An organisation or business entity other than those specifically detailed within an e-Document.

ProofApprovalDate

ProofApprovalDate is optional. A single instance might exist.

Date field indicating when proofs will be approved.

ProofDueDate

ProofDueDate is optional. A single instance might exist.

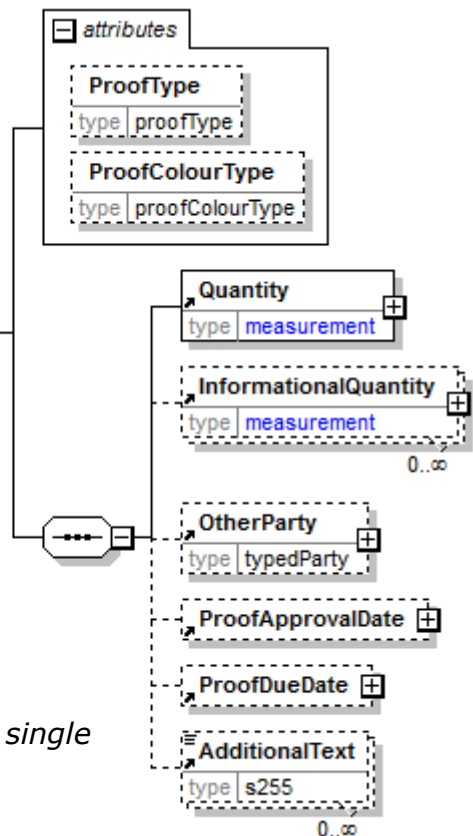

Proof due date

AdditionalText

AdditionalText is optional. Multiple instances might exist.

A text field that is used to communicate information not previously defined or for special instructions. To be used only for circumstances not covered by specific elements.

ProofType [attribute]

Type of trial impression of a page or printed work.

This item is restricted to the following list.

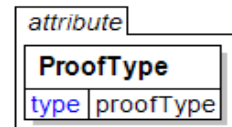

Blues

Photographic proof from film negatives where all colours are shown in blue.

ColorKey

Overlay proof created from the film separations that places each ink color on a separate clear acetate sheet, then assembles them together over white paper.

Cromalin

A versatile toner based proofing system patented by Dupont that offers the broadest variety of process, Pantone®, fluorescent, pastel and metallic colors that work in a positive film environment.

CustomCromalin

A customized version of the Dupont toner based proofing system.

DigitalBlueLine

A proof printed directly from the digital file where all colours are shown in blue.

DigitalProofs

Proofs are printed directly from a digital file.

Dylux

A DuPont Dylux® instant image proofing system that produces dry, instant image blueline proofs without processing.

FilmProofs

Proofs made from the separate plates in color process work, showing the sequence of printing and the result after each additional color has been applied.

FoldedGathered

A folded, gathered assembly of prints.

InkDrawDown

When printing a PMS match color on a colored paper, an ink draw-down involves the substitution of opaque white in the ink formula, increasing covering qualities of the ink.

papiNet V2R31

Iris

A large-format color printer from the Iris Graphics division of CreoScitex (www.creoscitex.com) that is used for digital proofing. Iris printers use a patented continuous ink jet technology to produce consistent, continuous-tone, photorealistic output on several varieties of paper, canvas, silk, linen and other low-fiber textiles. Iris prints are widely noted for their color accuracy and ability to match printing and proofing standards. They are also known for their low-cost consumables compared to other technologies.

MatchPrint

Trade name for 3M integral color proof.

PressProofs

Proof made on press using the plates, paper, and ink specified for the order.

ReferenceCDCassette

To be deprecated in a future version V3R00.

Samples

Finished product to be used for sample only and not to be sold.

SoftProof

A proof that is viewed on a computer monitor.

T-Print

To be deprecated in a future version V3R00.

Other

PropertyAverageValue

Specifies an average value for a property for a number of items. The property is defined by the attribute PropertyType. The attribute MeasuringMethod and MeasuringAgency can be used to clarify details for a how a property is measured or calculated, e.g. Diameter for a saw log can be measured "Under Bark" or "Over Bark". The attribute MeasuringMethodType defines how the value is created, e.g. measured automatically,

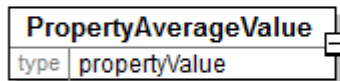

calculated etc.

PropertySubValue can specify a value for a property related to the property specified by the attribute PropertyType of PropertyAverageValue.

PropertyType [attribute]

PropertyType is mandatory. A single instance is required.

Defines the type of property for an item.

Refer to PropertyType definition for any enumerations.

MeasuringMethodType [attribute]

MeasuringMethodType is optional. A single instance might exist.

Specifies how a measurement value is created.

Refer to MeasuringMethodType definition for any enumerations.

MeasuringAgency [attribute]

MeasuringAgency is optional. A single instance might exist.

The agency defining measuring methods.

Refer to MeasuringAgency definition for any enumerations.

MeasuringMethod [attribute]

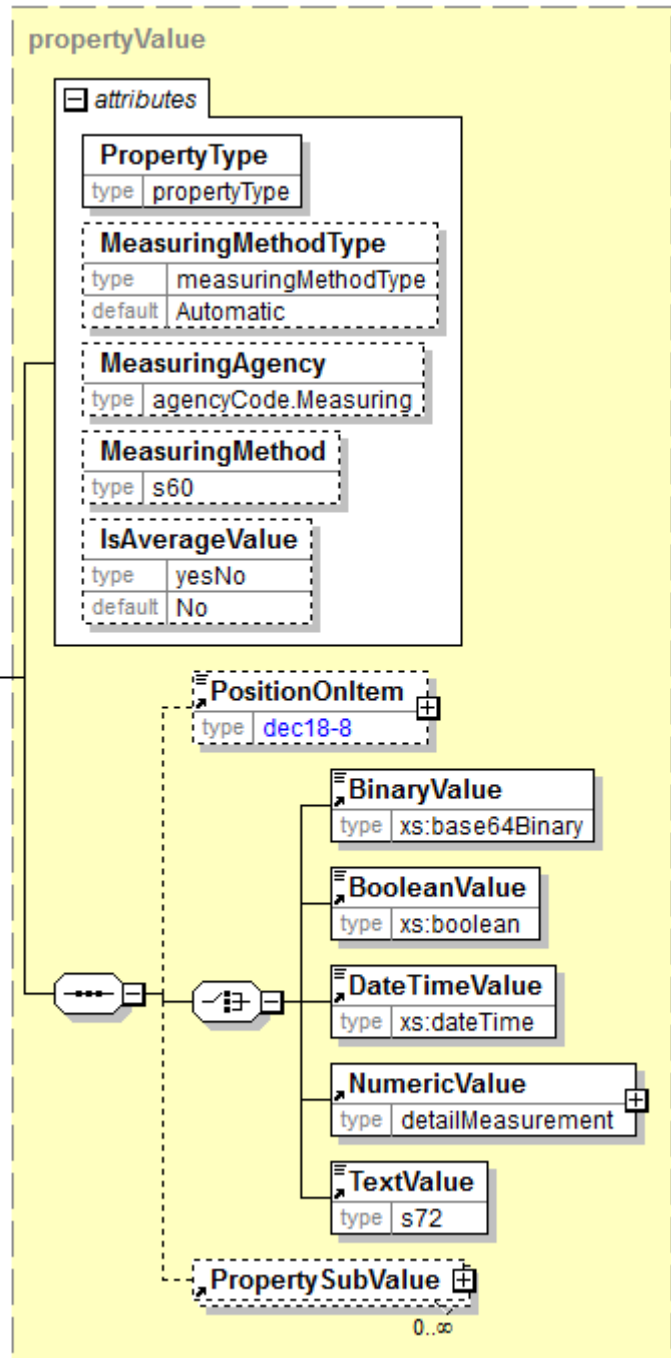

MeasuringMethod is optional. A single instance might exist.

The method used to determine how the item under consideration is measured. Measuring methods are defined by the measuring agency.

IsAverageValue [attribute]

IsAverageValue is optional. A single instance might exist.

Indicates if the value is an average value or not.

Refer to IsAverageValue definition for any enumerations.

(sequence)

The sequence of items below is mandatory. A single instance is required.

PositionOnItem

PositionOnItem is optional. A single instance might exist.

Specifies a position on an item. The attribute PositionMeasuredFrom defines the reference point for the position

(choice)

Choice is mandatory. A single instance is required.

BinaryValue

BinaryValue is mandatory. A single instance is required.

A value in base-64-encoded binary format.

BooleanValue

BooleanValue is mandatory. A single instance is required.

A value in boolean format.

DateTimeValue

DateTimeValue is mandatory. A single instance is required.

A Date and Time value in the standard W3C xs:dateTime format.

NumericValue

NumericValue is mandatory. A single instance is required.

A grouping element for a numeric value and its statistical measures.

TextValue

TextValue is mandatory. A single instance is required.

A value in text format.

PropertySubValue

PropertySubValue is optional. Multiple instances might exist.

A child element of PropertyValue. It specifies a value for a property related to the property specified by the attribute PropertyType of the mother element, e.g. the diameter of the property KnotUnSound. The property is defined by the attribute PropertyType. The attribute MeasuringMethod and MeasuringAgency can be used to clarify details for a how a property is measured or calculated, e.g. Diameter of a log can be measured "Under Bark" or "Over Bark". The attribute MeasuringMethodType defines how the value is created, e.g. measured automatically, calculated etc. The attribute IsAverageValue indicates if the value is an average value or not.

PropertyCode

A code defining a property specified by an Agency.

Agency [attribute]

Agency is mandatory. A single instance is required.

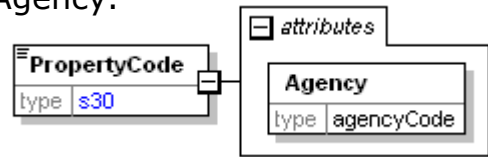

Describes the agency maintaining the list of codes. To be included in this list the agency must be a recognized standards body or industry organisation.

- For the element that owns this attribute.
- For another attribute in the list of attributes associated with the parent element.

Refer to Agency definition for any enumerations.

PropertyDescription

An element used to communicate a human readable description of the property.



PropertySpecification

A grouping element that contains a specification of properties that should be measured or are measured.

PropertyType [attribute]

PropertyType is mandatory. A single instance is required.

Defines the type of property for an item.

Refer to PropertyType definition for any enumerations.

MeasuringMethodType [attribute]

MeasuringMethodType is optional. A single instance might exist.

Specifies how a measurement value is created.

Refer to MeasuringMethodType definition for any enumerations.

MeasuringAgency [attribute]

MeasuringAgency is optional. A single instance might exist.

The agency defining measuring methods.

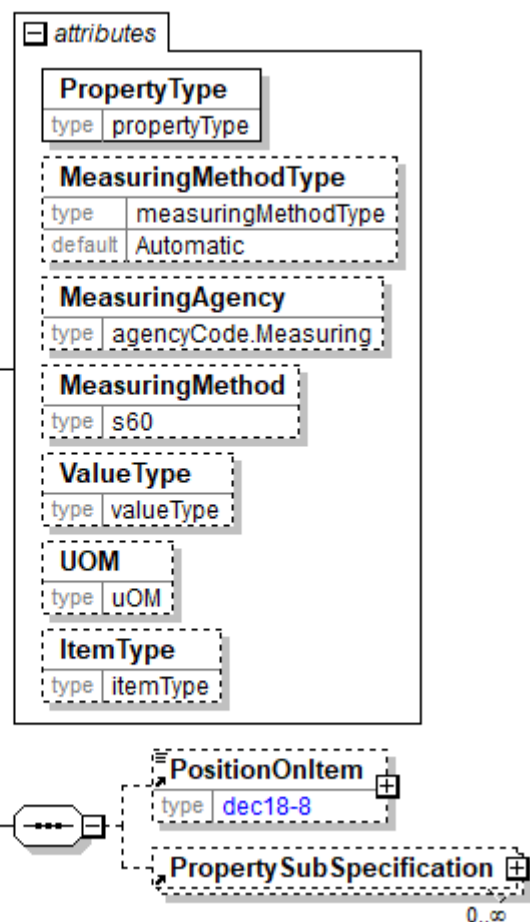

Refer to MeasuringAgency definition for any enumerations.

MeasuringMethod [attribute]

MeasuringMethod is optional. A single instance might exist.

The method used to determine how the item under consideration is measured. Measuring methods are defined by the measuring agency.

ValueType [attribute]

ValueType is optional. A single instance might exist.

Specifies the type of the value requested or reported.

Refer to ValueType definition for any enumerations.

UOM [attribute]

UOM is optional. A single instance might exist.

Defines the unit of measure for the value.

Refer to UOM definition for any enumerations.

ItemType [attribute]

ItemType is optional. A single instance might exist.

Indicates the form of the item being reported as being used. Many of the ItemType(s) indicated here have a corresponding named element equivalent, which is referenced here for definition purposes.

Refer to ItemType definition for any enumerations.

(sequence)

The sequence of items below is mandatory. A single instance is required.

PositionOnItem

PositionOnItem is optional. A single instance might exist.

Specifies a position on an item. The attribute PositionMeasuredFrom defines the reference point for the position.

PropertySubSpecification

PropertySubSpecification is optional. Multiple instances might exist.

A child element of PropertySpecification. It contains a specification of properties that should be measured or are measured for a property specified by the mother element PropertySpecification. E.g. if the property KnotUnSound is specified by the mother element PropertySpecification, then PropertySubSpecification can specify that the diameter of the unsound knot should be measured or is measured.

PropertySubSpecification

A child element of PropertySpecification. It contains a specification of properties that should be measured or are measured for a property specified by the mother element PropertySpecification. E.g. if the property KnotUnSound is specified by the mother element PropertySpecification, then PropertySubSpecification can specify that the diameter of the unsound knot should be measured or is measured.

PropertyType [attribute]

PropertyType is mandatory. A single instance is required.

Defines the type of property for an item.

Refer to PropertyType definition for any enumerations.

MeasuringMethodType [attribute]

MeasuringMethodType is optional. A single instance might exist.

Specifies how a measurement value is created.

Refer to MeasuringMethodType definition for any enumerations.

MeasuringAgency [attribute]

MeasuringAgency is optional. A single instance might exist.

The agency defining measuring methods.

Refer to MeasuringAgency definition for any enumerations.

MeasuringMethod [attribute]

MeasuringMethod is optional. A single instance might exist.

The method used to determine how the item under consideration is measured. Measuring methods are defined by the measuring agency.

ValueType [attribute]

ValueType is optional. A single instance might exist.

Specifies the type of the value requested or reported.

Refer to ValueType definition for any enumerations.

UOM [attribute]

UOM is optional. A single instance might exist.

Defines the unit of measure for the value.

Refer to UOM definition for any enumerations.

ItemType [attribute]

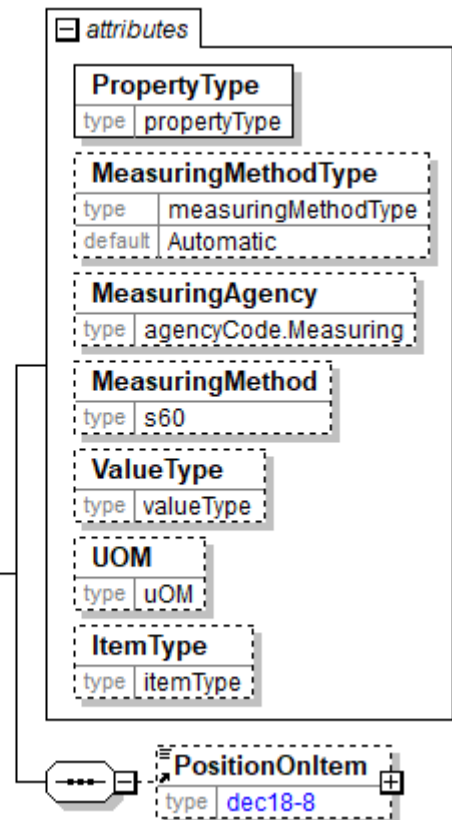

ItemType is optional. A single instance might exist.

Indicates the form of the item being reported as being used. Many of the ItemType(s) indicated here have a corresponding named element equivalent, which is referenced here for definition purposes.

Refer to ItemType definition for any enumerations.

(sequence)

The sequence of items below is mandatory. A single instance is required.

PositionOnItem

PositionOnItem is optional. A single instance might exist.

Specifies a position on an item. The attribute PositionMeasuredFrom defines the reference point for the position.

PropertySubValue

A child element of PropertyValue. It specifies a value for a property related to the property specified by the attribute PropertyType of the mother element, e.g. the diameter of the property KnotUnSound. The property is defined by the attribute PropertyType. The attribute MeasuringMethod and MeasuringAgency can be used to clarify details for a how a property is measured or calculated, e.g. Diameter of a log can be measured "Under Bark" or "Over Bark". The attribute MeasuringMethodType defines how the value is created, e.g. measured automatically, calculated etc. The attribute IsAverageValue indicates if the value is an average value or not.

PropertySubValue

PropertyType [attribute]

PropertyType is mandatory. A single instance is required.

Defines the type of property for an item.

Refer to PropertyType definition for any enumerations.

MeasuringMethodType [attribute]

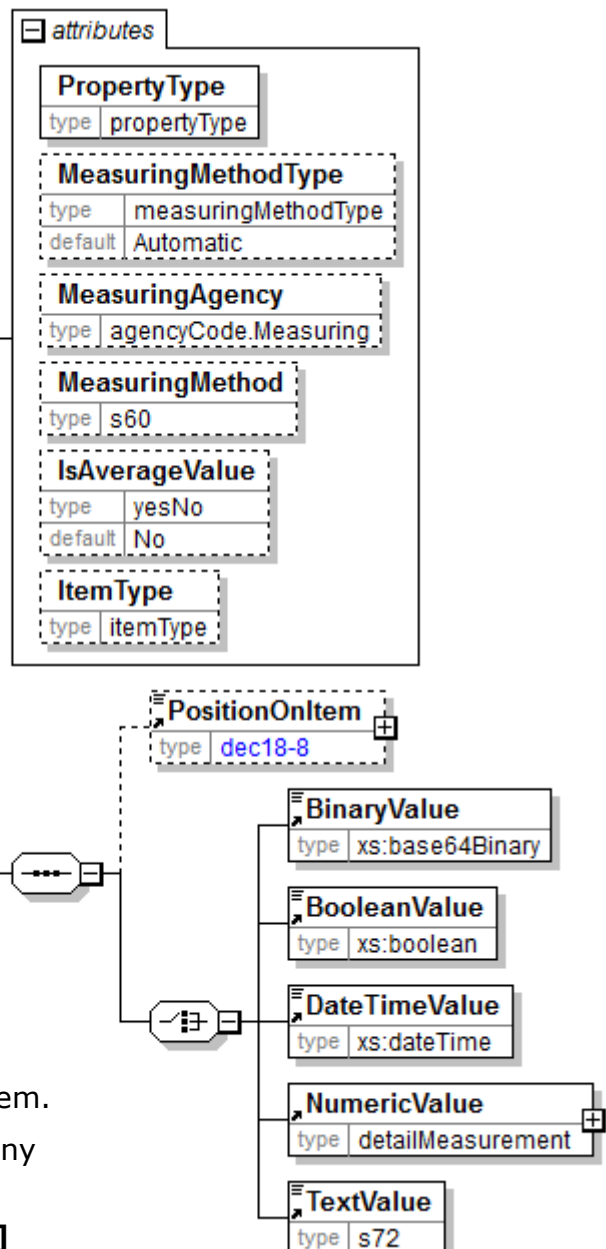

MeasuringMethodType is optional. A single instance might exist.

Specifies how a measurement value is created.

Refer to MeasuringMethodType definition for any enumerations.

MeasuringAgency [attribute]

MeasuringAgency is optional. A single instance might exist.

The agency defining measuring methods.

Refer to MeasuringAgency definition for any enumerations.

MeasuringMethod [attribute]

MeasuringMethod is optional. A single instance might exist.

The method used to determine how the item under consideration is measured. Measuring methods are defined by the measuring agency.

IsAverageValue [attribute]

IsAverageValue is optional. A single instance might exist.

Indicates if the value is an average value or not.

Refer to IsAverageValue definition for any enumerations.

ItemType [attribute]

ItemType is optional. A single instance might exist.

Indicates the form of the item being reported as being used. Many of the ItemType(s) indicated here have a corresponding named element equivalent, which is referenced here for definition purposes.

Refer to ItemType definition for any enumerations.

(sequence)

The sequence of items below is mandatory. A single instance is required.

PositionOnItem

PositionOnItem is optional. A single instance might exist.

Specifies a position on an item. The attribute PositionMeasuredFrom defines the reference point for the position

(choice)

Choice is mandatory. A single instance is required.

BinaryValue

BinaryValue is mandatory. A single instance is required.

A value in base-64-encoded binary format.

BooleanValue

BooleanValue is mandatory. A single instance is required.

A value in boolean format.

DateTimeValue

DateTimeValue is mandatory. A single instance is required.

A Date and Time value in the standard W3C xs:dateTime format.

NumericValue

NumericValue is mandatory. A single instance is required.

A grouping element for a numeric value and its statistical measures.

TextValue

TextValue is mandatory. A single instance is required.

A value in text format.

PropertyType [attribute]

Defines the type of property for an item.

This item is restricted to the following list.

PropertyType	
type	propertyType

AcidValue

Acid value (or "neutralization number" or "acid number" or "acidity") is the mass of potassium hydroxide (KOH) in milligrams that is required to neutralize one gram of chemical substance.

The acid value is used to quantify the amount of acid present, for example in a sample of biodiesel. Acid value is a measure of mineral acids and free fatty acids contained in a fuel sample. . High fuel acidity is linked with corrosion and engine deposits. A Numeric value.

AlkaliMetals(Na+K)

Content of sodium (Na) and potassium (K). A Numeric value.

AnnualRings

Growth ring corresponding to an annual period of growth. A growth ring is a layer of wood produced in one growing season. A Numeric value.

Area

Area of an item. A Numeric value

Aromaticity

Aromaticity is a chemical property describing the way in which a conjugated ring of unsaturated bonds, lone pairs, or empty orbitals exhibits stabilization stronger than would be expected by the stabilization of conjugation alone. A Numeric value.

AshContent

Noncombustible impurities left after the burning of a material. A Numeric Value.

BarkClassCode

Classification of bark. A Text value.

BarkContent

The amount of bark content in an item. Often reported as a percentage. A Numeric value.

BarkContentCorrection

A value to correct the quantity of the bark of an item. Normally reported as millimeter, litre, decilitre or a percentage. A Numeric value.

BarkFunction

The name of the bark function used for calculation of the bark thickness of a stem or a log. A Text value.

BarkPocket

Bark that is partly or wholly enclosed in wood. A Boolean value.

BarkThickness

The double bark thickness of an item, e.g. bark thickness of a log measured across the diameter of the log on two sides. A Numeric value.

BenzeneContent

Content of benzene. Benzene is a natural constituent of crude oil, and is one of the most basic petrochemicals. Benzene is an aromatic hydrocarbon. A Numeric value.

BlackStreak

Dark zone in some species of hardwood along a growth ring. A Boolean value.

BlueDeep

Blue stain that cannot be removed by surface planing. A Boolean value and/or a Numeric value.

BlueDeepClassCode

The category class for blue stain that cannot be removed by surface planing. A Text value.

BlueStain

Stain, caused by fungi, where the discoloration ranges from pale blue to black. A Boolean value and/or a Numeric value.

BlueStainClassCode

The category class for stain, caused by fungi, where the discoloration ranges from pale blue to black. A Text value.

BoilingPoint

The boiling point of a substance is the temperature at which the vapour pressure of the liquid equals the pressure surrounding the liquid and the liquid changes into a vapour. A Numeric value.

BoreHole

Hole or tunnel in timber caused by insects. A Boolean value.

BowDefectLength

The length of an item that can't be used because of a bow on the item. A Numeric value.

BowDiameterReduction

Reduction of the small end diameter of an item because a bow is effecting the usability of the item. A Numeric value.

BowHeight

Bow height of an item. E.g. Maximum distance between cross sectional centre of a log and a straight line between centres of each log end. A Numeric value.

BowLengthReduction

Reduction of the length of an item because a bow is effecting the usability of the item. A Numeric value.

Burl

Protrusion around a group of epicormic shoots, dormant buds and possibly twigs. A Boolean value and/or a Numeric value.

ButtEndProfileExtrapolationFunction

The name of the butt end profile extrapolation function used for calculation of the butt end of a stem that cannot be measured by a harvester. A Text value.

Buttress

Projecting rib at the lower end of the stem. A Boolean value and/or a Numeric value.

CalorificIntensity

The temperature of a fuel attained by its combustion. A Numeric value.

Canker

Cavity or protrusion on the surface of round timber, caused in the living tree by a fungus or a micro fungus. A Boolean value.

CarbonResidueRemnant

Carbon residue remnant (at 10% distillation remnant). A Numeric value.

CetaneIndex

Cetane index is used as a substitute for the cetane number of diesel fuel. The cetane index is calculated based on the fuel's density and distillation range. A Numeric value.

CetaneNumber

Cetane number or CN is a measurement of the combustion quality of diesel fuel during compression ignition. It is a significant expression of the quality of a diesel fuel.

Cetane number or CN is a measure of a fuel's ignition delay; the time period between the start of injection and the first identifiable pressure increase during combustion of the fuel. In a particular diesel engine, higher cetane fuels will have shorter ignition delay periods than lower cetane fuels. Cetane numbers are only used for the relatively light distillate diesel oils. For heavy (residual) fuel oil two other scales are used CCAI and CII. In short, the higher the Cetane number the more easily the fuel will combust in a compression setting (such as a diesel engine). A Numeric value.

ChipQualityNumber

Quality value of industrial wood chips based on user specific chip sample analyses and calculation factors (UOM=None). A Numeric value.

ColdFilterPluggingPoint

Defines a temperature at which a fuel is no longer filterable within a specified time limit. A Numeric value.

CopperBandCorrosion

This is defined as the likelihood to cause corrosion to copper, zinc and bronze parts of an engine. A polished metallic strip is heated at 50°C for 3 hours, washed and compared to standards. Corrosion is likely to be caused by free acids or sulfur compounds. A Text value

CrackFrost

Radial fissure cause by frost action on the standing tree that extends from the sapwood towards the pith and for a distance longitudinally. A Boolean value.

DateMeasuring

The date and time when measuring of an item was performed. A DateTime value.

DateProduction

Date and time when an item was produced. A DateTime value.

Density

The density of a material is its mass per unit volume. A Numeric value.

Diameter

Diameter of an item. A Numeric value.

DiameterClassCode

The category class for the diameter of an item. A Text value.

DiameterLargeEnd

Diameter at largest end of a item, often referred to as butt diameter. A Numeric value.

DiameterMid

Diameter at mid point of an item. A Numeric value.

DiameterMidHorizontal

Diameter at mid point on the item and measured on the horizontal. A Numeric value.

DiameterMidVertical

Diameter at mid point on the item and measured on the vertical. A Numeric value.

DiameterReduction

Diameter reduction of an item, value to reduce from the items actual diameter. A Numeric value.

DiameterSmallEnd

Diameter at smallest end of an item, often referred to as top diameter. A Numeric value.

DiameterStemLastCutSawlog

The diameter of a stem where the last cross cut for sawlogs are done. I.e. the same as the small end diameter for the last sawlog cut from a stem. A Numeric value.

DiGlycerideContent

Content of diglyceride. A Numeric value.

Dote

Early stage of rot, characterized by discoloured streaks or patches in the wood, where the general texture and strength properties remain more or less unchanged. A Boolean value.

Dryness

Amount of dry solids content. Expressed as percentage. A Numeric value.

EccentricPith

Pith that is at a significant distance from the geometric centre of the cross section of round timber. A Numeric value.

EsterContent

Ester content. A Numeric value.

Evaporation

Evaporation is a type of vaporization of a liquid that occurs only on the surface of a liquid measured at certain temperature. A Numeric value.

ExistentGumContent

Content of existent gum, also called washed gum. A Numeric value.

FilterAbility

The filterability characteristic of a fluid can be defined as its ability to pass through a filter without giving rise to undue pressure drop. A Numeric value.

FlashPoint

The flash point of a volatile material is the lowest temperature at which it can vaporize to form an ignitable mixture in air. Measuring a flash point requires an ignition source. At the flash point, the vapour may cease to burn when the source of ignition is removed. A Numeric value.

Fluting

Longitudinal narrow depressions and / or ridges on the surface of round timber. A Boolean value.

ForeignBody

Foreign object in the log. A Boolean value.

ForestRot

The amount of an items content of rot originating from growing trees. A Numeric value.

FreeGlycerineContent

Content of free glycerine. A Numeric value.

FreshDensity

Density of fresh wood. Calculated as fresh weight divided by fresh volume. Density is usually needed for calculations of wood quantity. A Numeric value.

FreshDensityCalculationDate

Date and time when a fresh density value was calculated. A DateTime value.

FreshDensityModelCalibrationDate

Date and time when a fresh density estimation model was calibrated. A DateTime value.

GroupIMetals

Content of Sodium and Potassium in a product, normally expressed in parts per million (ppm). A Numeric value.

GroupIIMetals

Content of Calcium and Magnesium in a product normally expressed in parts per million (ppm). A Numeric value.

HeartDotyRed

Unsound red heart of beech which appears at the ends of round wood in a star-like form. A Boolean value.

HeartRed

Red of brown stain affecting the central portion of beech wood sharply defined. A Boolean value.

HeatingEnergy

Heating energy of a raw material per mass unit. A Numeric value.

Height

Height of an item. A Numeric value.

HeightDeviationToNominalHeight

The height deviation measured for an item to the nominal height of the item. A Numeric value

HydrogenBounded

Chemical bounded hydrogen in a material. A Numeric Value.

IodineValue

The iodine value (or "iodine adsorption value" or "iodine number" or "iodine index") in chemistry is the mass of iodine in grams that is consumed by 100 grams of a chemical substance. Iodine values are often used to determine the amount of unsaturation in fatty acids.

Iodine value is a measure of total unsaturation (double bonds) within the Fatty Acid Methyl Esters (FAME) product. It is expressed as the grams Iodine required to react with 100g of FAME sample. High Iodine value is related to polymerization of fuels, leading to injector fouling. It is also linked to poor storage stability. A Numeric value.

IsBioEnergyAdaptedHarvesting

Operator of forest harvester registers whether harvesting was adapted for extraction of bio energy products, in most cases harvesting residues in the form of branches and tops. A Boolean value.

IsManualCrossCut

Specifies if the cross cut of an item is decided and executed manually by the operator or not. A Boolean value.

IsRandomlySelected

The item is randomly selected. A Boolean value.

ItemClassCode

The category class of an item. A Text Value.

KnotCluster

Knots grouped together as a unit with the fibers of the wood deflected around the entire unit. A Boolean value and/or a Numeric value.

KnotCovered

Knot that is not visible on the curved surface of round timber. A Boolean value and/or a Numeric value.

KnotDead

A knot whose fibers are not intergrown with those of the surrounding wood. A Boolean value and/or a Numeric value.

KnotEncased

A knot more or less surrounded by bark within the surrounding wood. A Boolean value and/or a Numeric value.

KnotSound

Knot showing no indication of rot. A Boolean value and/or a Numeric value.

KnotSpike

Acutely angled branches. A normal branch which has formed on a steep angle in terms of the stem. A Boolean value and/or a Numeric value.

KnotUnsound

Knot affected by rot. A Boolean value and/or a Numeric value.

LeadContent

Content of lead. A Numeric value.

Length

Length of an item. A Numeric value.

LengthClassCode

The category class for the length of an item. A Text value.

LengthExcess

An extra length margin of a product. For example the difference between the measured length and the classified length. A Numeric value.

LengthReduction

Length reduction of an item, value to reduce from the items actual length. A Numeric value.

LengthStemTop

The length of a stem above the last cross cut of the stem. A Numeric value.

LoggingDamage

Defines damages on a Forest Wood product caused by logging. These damages normally cause an adjustment of the product price. A Text value.

LogPositionInStem

Position of a log in a stem detected during log measuring. Allowed values are restricted to ButtEnd, Middle or TopEnd. A Text value.

Lubricity

Lubricity is the measure of the reduction in friction of a lubricant. A Numeric value.

MeltingPoint

The melting point of a solid is the temperature at which it changes state from solid to liquid. A Numeric value.

MethanolContent

Content of methanol. A Numeric value.

Moisture

Moisture content in a material. Moisture content is the percentage of water weight contained in material relative to the total weight. A Numeric value.

MoistureAnalyseDry

Moisture content in biomass measured at dry basis. Moisture content is the percentage of water weight contained in biomass relative to the total weight of the dry biomass ($Mad = \text{Moisture, analyse dry, air dry}$). Mad is usually used by sawmilling sector. Measuring method of moisture content is standardized by ISO 18134. A Numeric value.

MoistureAsReceived

Moisture content in biomass measured at wet basis. Moisture content is the percentage of water weight contained in biomass relative to the total weight of the wet biomass ($Mar = \text{Moisture, as received}$). Mar is usually used by forestry and energy sector. Measuring method of moisture content is standardized by ISO 18134. A Numeric value.

MoistureClassCode

The category class for the moisture content of an item.

MolecularValue

The numerical value of the molecular mass expressed in unified atomic mass units. A Numeric value.

MonoGlycerideContent

Content of monoglyceride. A Numeric value.

MultiTreeBunch

A number identifying which trees have been felled together. All stems and logs felled and processed together in a forest harvester are given the same number. Measurement accuracy is lower in case of multi tree harvesting compared to normal harvesting. A Numeric value.

NitrogenContent

Content of nitrogen. A Numeric value.

OctaneNumber

Octane rating or octane number is a standard measure of the performance of

papiNet V2R31

a motor or aviation fuel. The higher the octane number, the more compression the fuel can withstand before detonating. In broad terms, fuels with a higher octane rating are used in high-compression engines that generally have higher performance. A Numeric value.

OlefinsContent

Content of olefins. Olefins are a type of hydrocarbon. A Numeric value.

OperatorUserID

The user id for an operator of a machine. E.g. The user id for the person operating a harvester. A Text value.

Ovality

Cross section of round timber where there is a significant difference between the larger and smaller diameters. A Numeric value.

OxidationStability

The resistance of a petroleum product to oxidation and, therefore, a measure of its potential service or storage life.

The Oxidative stability specification is defined as a minimum Rancimat induction period of six hours. Essentially a fuel is heated at 110°C in a constant air stream and the formation of volatile organic acids is detected. This property relates to the overall storage stability of the fuel and the higher the degree of unsaturation (double bonds) within the Fatty Acid Methyl Esters (FAME) molecules gives a decrease in oxidative stability. This can be improved with the addition of antioxidant additives. A Numeric value.

OxygenatesContent

Content of oxygenates. Oxygenated chemical compounds contain oxygen as a part of their chemical structure. The term usually refers to oxygenated fuels. Oxygenates are usually employed as petrol additives to reduce carbon monoxide that is created during the burning of the fuel. A Numeric value.

OxygenContent

Content of oxygen. A Numeric value.

PhosphorusContent

Content of phosphorus. A Numeric value.

PinHole

Small hole or tunnel in timber caused by insects. A Boolean value.

Polyaromatics

An aromatic hydrocarbon or arene (or sometimes aryl hydrocarbon) is a hydrocarbon with alternating double and single bonds between carbon atoms forming rings. A Numeric value.

PopulationGrossCorrectionFactor1

A correction factor used for correction of gross quantities during phase 1 of corrections based on measuring statistics for a population of products.

PopulationGrossCorrectionFactor2

A correction factor used for correction of gross quantities during phase 2 of corrections based on measuring statistics for a population of products.

PopulationNetCorrectionFactor1

A correction factor used for correction of net quantities during phase 1 of corrections based on measuring statistics for a population of products.

PopulationNetCorrectionFactor2

A correction factor used for correction of net quantities during phase 2 of corrections based on measuring statistics for a population of products.

PourPoint

The pour point of a liquid is the lowest temperature at which it becomes semi solid and loses its flow characteristics. A Numeric value.

PredeterminedCompensationLength

The predetermined fixed length to use in compensation calculation. A Numeric value.

QualityClassCode

The category class for the quality of an item. A Text value.

ReactionWood

Wood with distinctive anatomical characters, formed typically in parts of leaning or crooked stems and in branches when the tree tends to restore the original position, if this has been disturbed.

Note: In hardwoods, it is known as tension wood and in softwoods as compression wood.

A Boolean value and/or a Numeric value.

ReasonClassCode

The class is based on the reason assigned to items. Typically it is used for specifying the reason why an item has been downgraded to a lower quality. A Text value.

ReidVapourPressure

Reid vapour pressure (RVP) is a common measure of the volatility of petrol. It is defined as the absolute vapour pressure exerted by a liquid at 100 °F (37.8 °C) as determined by the test method ASTM-D-323. A Numeric value.

ResinPocket

Lens-shaped cavity in timber containing, or that has contained resin. A Boolean value.

Rot

Decomposition of wood by fungi or other micro-organisms resulting in softening, progressive loss of mass and strength, and often a change of texture and colour. A Boolean value and/or a Numeric value.

RotSoft

Rot caused by micro fungi that attack cellulose and hemicellulose and considerably reduce the strength properties of timber. A Boolean value.

SamplingAllowed

Indicates that an item is allowed or not allowed to be included in a sample measurement. A Boolean value. Default value is true.

SapwoodRot

Rot confined to sapwood. A Boolean value.

Scar

Surface wound that has been wholly or partly enclosed by the growth of a tree. A Boolean value and/or a Numeric value.

ScarCovered

An occluded scar where the damage consists of bark and is indicated in the bark by a sign on the mantle surface. A Boolean value and/or a Numeric value.

ShakeFelling

Fissure caused by felling, appearing at the butt end of round timber and extending in the longitudinal direction. A Boolean value.

ShakeHeart

Radial end shake originating at the pith. A Boolean value and/or a Numeric value.

SizeClassCode

The category class for the size of an item.

SolidWoodPercentage

SolidWoodVolume expressed as a percentage of the measured volume of an item, e.g. a logpile. A Numeric value.

SpiralGrain

Grain that follows a spiral course around the pith. A Numeric value.

StainBrown

Attack, originating in the standing tree, appearing as a black mark on the smooth parts of the bark. A Boolean value.

StainBrown (misspelt with an ending space)

The item is misspelt ending with a space. It will be deprecated in a future version V3R00. Use instead the correctly spelt enumeration StainBrown.

StemCode

The stem code provides a code value that has been allocated to a stem. For example a stem code in accordance with the StanForD standard. A Text value.

StorageDuration

Duration of storage of a product. A Numeric value.

N.B. The MeasuringMethodType specifies if the value of StorageDuration is Calculated or VisualEstimated.

StorageRot

The amount of an items content of rot caused by storage. A Numeric value.

StratumAreaCode

A code of the geographic area of stratum for a property to which the product belongs to in stratified sampling. A StratumAreaCode for a property may only

be reported in PropertySubValue when a property is reported in PropertyValue. A Text value.

StratumAreaName

A name of the geographic area of stratum for a property to which the product belongs to in stratified sampling. A StratumAreaName for a property may only be reported in PropertySubValue when a property is reported in PropertyValue. A Text value.

StratumID

An identifier of the computational stratum for a property to which the product belongs to in stratified sampling.

A StratumID for a property may only be reported in PropertySubValue when the property is reported in PropertyValue. A Text value.

SulfatedAshContent

Sulfated ash content. A Numeric value.

SulfurContent

The amount of sulphur. A Numeric value.

SurfaceWithoutBark

Surface of an item not covered by bark. Normally measured as percentage of the total surface area of the item. A Numeric value.

Sweep

Deviation of the longitudinal axis of round timber from a straight line. A Numeric value.

SweepMultiple

Sweep characterized by two or more bends in one or several planes. A Numeric value.

SweepSimple

Sweep characterized by one bend only. A Numeric value.

Taper

Taper of an item, the difference in diameter over a length interval. A Numeric value.

TarRemnant

Tar remnant (at 10% distillation remnant). A Numeric value.

Temperature

A measure of the warmth or coldness of an object or substance. A Numeric value.

TopRupture

Grain deviation caused by damage to the top of a growing tree. A Boolean value.

TotalGlycerineContent

Content of total glycerine. Total glycerine is the sum of the bound and free glycerine. A Numeric value.

TreeAge

The age of a tree. A Numeric value.

TreeDiameterBreastHeight

Diameter at breast height (1.3 m from ground) of a tree. A Numeric value.

TreeHeight

Height of a tree from ground to the top of the tree. A Numeric value.

TreeLogOrder

Log number based on order of logs from the stump and to the small end of the tree. A Numeric value.

TreeProcessingCategory

Defines how trees are harvested. For example as single tree processing, multi tree processing, single tree felling and multi tree felling according to StanForD. A Text value.

TreeSpeciesGroupCode

A code defining tree species or groups of tree species. A Text value.

TreeSpeciesGroupCodePercentage

The quantity percentage of the reported TreeSpeciesGroupCode.

TreeSpeciesGroupCodePercentage may only be reported in PropertySubValue and then only when the property TreeSpeciesGroupCode is reported in PropertyValue. A Numeric value.

TriGlycerideContent

Content of triglyceride. A Numeric value.

TurbidityPoint

The temperature at which a clear liquid petroleum product becomes hazy or cloudy due to the appearance of wax crystals when the test is conducted under standardised conditions. A Numeric value.

UsageClassCode

The category class for the usage of an item. A Text value.

VaporizationHeat

Vaporization heat is the energy required to transform a given quantity of a substance into a gas. A Numeric Value.

Viscosity

Viscosity is a measure of the resistance of a fluid which is being deformed by either shear stress or tensile stress. The SI physical unit of dynamic viscosity is the pascal-second (Pa•s). A Numeric value.

VolumeConcentrationPercentage

Volume-based concentration of the material expressed as a percentage. A Numeric value.

VolumeStemDefectLogs

The volume of the roundwood logs that were produced from stem parts with

defect(s) in the stem. A Numeric value.

Typically, a defect part of the stem causes a log that fits the requested dimensions of a saw timber log, to be designated as some other product.

VolumeStemTopCrown

The volume of the tree crown above the last cross cut of the stem. This volume includes the volumes of the stem top, the branches and the twigs. A Numeric value.

VolumeTariff

The tariff (volume table) used to calculate volume of product. A Text value.

WaterContent

Water content is the quantity of water contained in a material. Water content is used in a wide range of scientific and technical areas, and is expressed as a ratio, which can range from 0 (completely dry) to the value of the materials' porosity at saturation. It can be given on a volumetric or mass (gravimetric) basis. A ratio is expressed in a unit of measure, e.g. Milligram/Kilogram. A Numeric value.

WeatherExposureDuration

Duration of the exposure of a product to weather conditions ending at the arrival to the delivery destination. A numeric value.

WeightConcentrationPercentage

Weight-based concentration of the material expressed as a percentage. A Numeric value.

Width

Width of an item. A Numeric value.

WoodPercentage

Wood volume without gaps but including bark expressed as a percentage of the measured volume of an Item, e.g. a logpile. A Numeric value.

PropertyValue

Specifies a value for a property of an item. The property is defined by the attribute PropertyType. The attribute MeasuringMethod and MeasuringAgency can be used to clarify details for a how a property is measured or calculated, e.g. Diameter for a saw log can be measured "Under Bark" or "Over Bark". The attribute MeasuringMethodType defines how the value is created, e.g. measured automatically, calculated etc. The attribute IsAverageValue indicates if the value is an average value or not.



PropertySubValue can specify a value for a property related to the property specified by the attribute PropertyType of PropertyValue. PropertyValueOfWhichMax and PropertyValueOfWhichMin can specify maximum and minimum values for properties that are part of the property specified by the attribute PropertyType of PropertyValue.

PropertyType [attribute]

PropertyType is mandatory. A single instance is required.

Defines the type of property for an item.

Refer to PropertyType definition for any enumerations.

MeasuringMethodType [attribute]

MeasuringMethodType is optional. A single instance might exist.

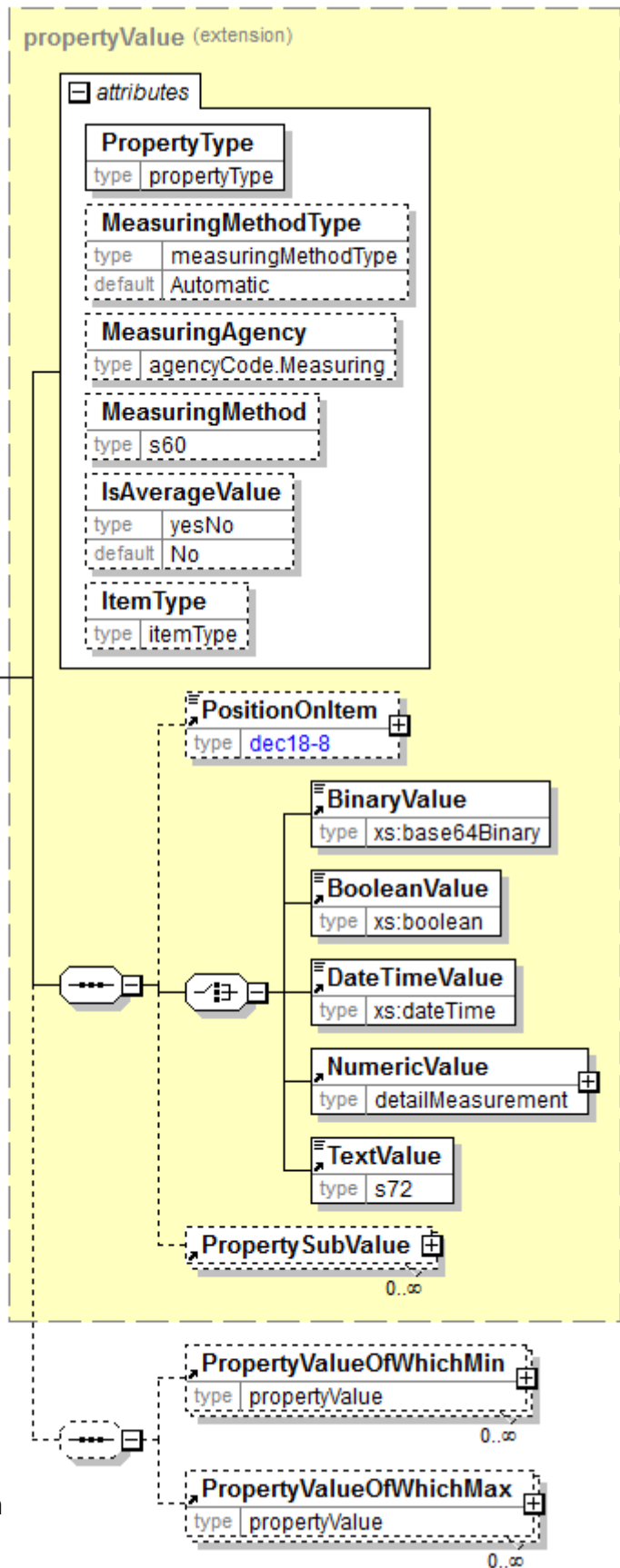

Specifies how a measurement value is created.

Refer to MeasuringMethodType definition for any enumerations.

MeasuringAgency [attribute]

MeasuringAgency is optional. A single instance might exist.

The agency defining measuring methods.

Refer to MeasuringAgency definition for any enumerations.

MeasuringMethod [attribute]

MeasuringMethod is optional. A single instance might exist.

The method used to determine how the item under consideration is measured. Measuring methods are defined by the measuring agency.

IsAverageValue [attribute]

IsAverageValue is optional. A single instance might exist.

Indicates if the value is an average value or not.

Refer to IsAverageValue definition for any enumerations.

ItemType [attribute]

ItemType is optional. A single instance might exist.

Indicates the form of the item being reported as being used. Many of the ItemType(s) indicated here have a corresponding named element equivalent, which is referenced here for definition purposes.

Refer to ItemType definition for any enumerations.

(sequence)

The sequence of items below is mandatory. A single instance is required.

PositionOnItem

PositionOnItem is optional. A single instance might exist.

Specifies a position on an item. The attribute PositionMeasuredFrom defines the reference point for the position

(choice)

Choice is mandatory. A single instance is required.

BinaryValue

BinaryValue is mandatory. A single instance is required.

A value in base-64-encoded binary format.

BooleanValue

BooleanValue is mandatory. A single instance is required.

A value in boolean format.

DateTimeValue

DateTimeValue is mandatory. A single instance is required.

A Date and Time value in the standard W3C xs:dateTime format.

NumericValue

NumericValue is mandatory. A single instance is required.

A grouping element for a numeric value and its statistical measures.

TextValue

TextValue is mandatory. A single instance is required.

A value in text format.

PropertySubValue

PropertySubValue is optional. Multiple instances might exist.

A child element of PropertyValue. It specifies a value for a property related to the property specified by the attribute PropertyType of the mother element, e.g. the diameter of the property KnotUnSound. The property is defined by the attribute PropertyType. The attribute MeasuringMethod and MeasuringAgency can be used to clarify details for a how a property is measured or calculated, e.g. Diameter of a log can be measured "Under Bark" or "Over Bark". The attribute MeasuringMethodType defines how the value is created, e.g. measured automatically, calculated etc. The attribute IsAverageValue indicates if the value is an average value or not.

(sequence)

The sequence of items below is optional. A single instance might exist.

PropertyValueOfWhichMin

PropertyValueOfWhichMin is optional. Multiple instances might exist.

A child element of PropertyValue. It specifies a minimum value for a property that is part of the property specified by the attribute PropertyType of the mother element PropertyValue, e.g. the minimum number of the property KnotSound contained in the number of the property Knot specified by the attribute PropertyType of PropertyValue. The property is defined by the attribute PropertyType. The attribute MeasuringMethod and MeasuringAgency can be used to clarify details for a how a property is measured or calculated, e.g. Diameter of a log can be measured "Under Bark" or "Over Bark". The attribute MeasuringMethodType defines how the value is created, e.g. measured automatically, calculated etc. The attribute IsAverageValue indicates if the value is an average value or not.

PropertyValueOfWhichMax

PropertyValueOfWhichMax is optional. Multiple instances might exist.

A child element of PropertyValue. It specifies a maximum value for a property that is part of the property specified by the attribute PropertyType of the mother element PropertyValue, e.g. the maximum number of the property KnotUnSound contained in the number of the property Knot specified by the attribute PropertyType of PropertyValue. The property is defined by the attribute PropertyType. The attribute MeasuringMethod and MeasuringAgency can be used to clarify details for a how a property is measured or calculated, e.g. Diameter of a log can be measured "Under Bark" or "Over Bark". The attribute MeasuringMethodType defines how the value is created, e.g. measured automatically, calculated etc. The attribute IsAverageValue indicates if the value is an average value or not.

PropertyValueOfWhichMax

A child element of PropertyValue. It specifies a maximum value for a property that is part of the property specified by the attribute PropertyType of the mother element PropertyValue, e.g. the maximum number of the property KnotUnSound contained in the number of the property Knot specified by the attribute PropertyType of PropertyValue. The property is defined by the attribute PropertyType. The attribute MeasuringMethod and MeasuringAgency can be used to

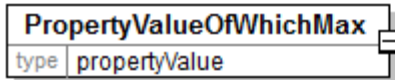

clarify details for a how a property is measured or calculated, e.g. Diameter of a log can be measured "Under Bark" or "Over Bark". The attribute MeasuringMethodType defines how the value is created, e.g. measured automatically, calculated etc. The attribute IsAverageValue indicates if the value is an average value or not.

PropertyType [attribute]

PropertyType is mandatory. A single instance is required.

Defines the type of property for an item.

Refer to PropertyType definition for any enumerations.

MeasuringMethodType [attribute]

MeasuringMethodType is optional. A single instance might exist.

Specifies how a measurement value is created.

Refer to MeasuringMethodType definition for any enumerations.

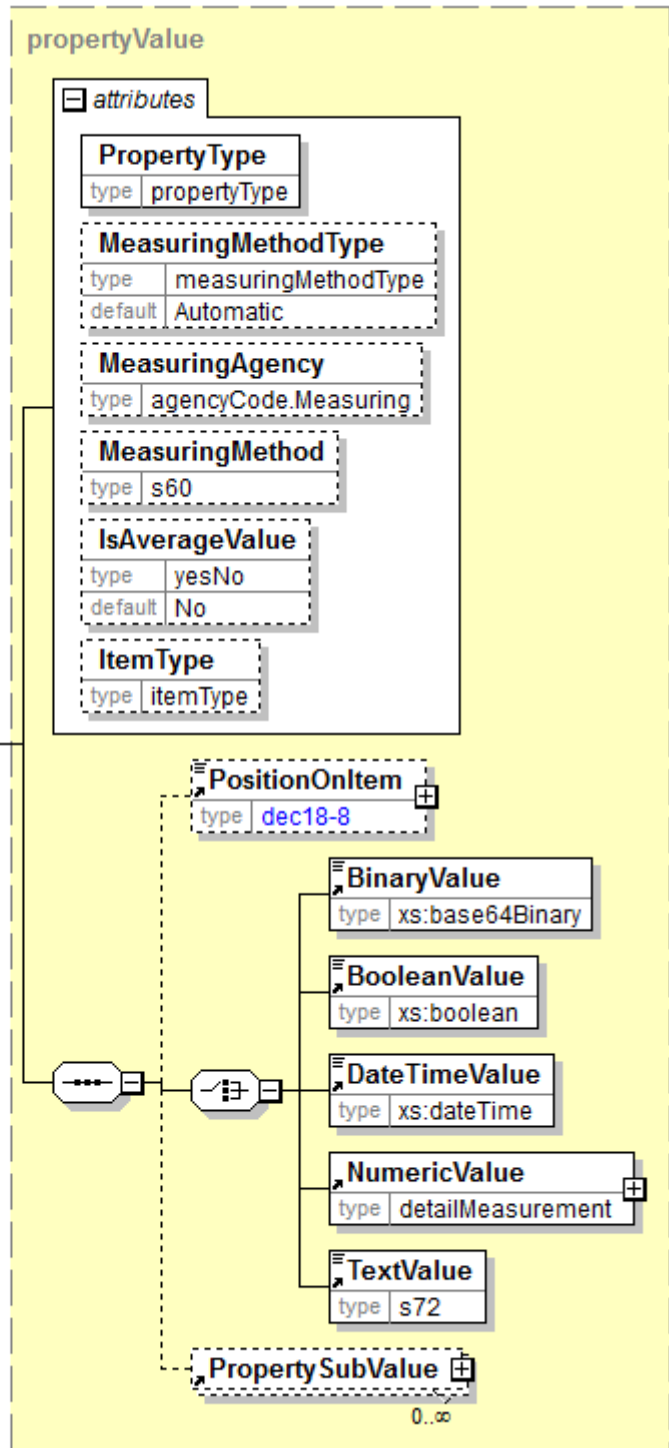

MeasuringAgency [attribute]

MeasuringAgency is optional. A single instance might exist.

The agency defining measuring methods.

Refer to MeasuringAgency definition for any enumerations.

MeasuringMethod [attribute]

MeasuringMethod is optional. A single instance might exist.

The method used to determine how the item under consideration is measured. Measuring methods are defined by the measuring agency.

IsAverageValue [attribute]

IsAverageValue is optional. A single instance might exist.

Indicates if the value is an average value or not.

Refer to IsAverageValue definition for any enumerations.

ItemType [attribute]

ItemType is optional. A single instance might exist.

Indicates the form of the item being reported as being used. Many of the ItemType(s) indicated here have a corresponding named element equivalent, which is referenced here for definition purposes.

Refer to ItemType definition for any enumerations.

(sequence)

The sequence of items below is mandatory. A single instance is required.

PositionOnItem

PositionOnItem is optional. A single instance might exist.

Specifies a position on an item. The attribute PositionMeasuredFrom defines the reference point for the position

(choice)

Choice is mandatory. A single instance is required.

BinaryValue

BinaryValue is mandatory. A single instance is required.

A value in base-64-encoded binary format.

BooleanValue

BooleanValue is mandatory. A single instance is required.

A value in boolean format.

DateTimeValue

DateTimeValue is mandatory. A single instance is required.

A Date and Time value in the standard W3C xs:dateTime format.

NumericValue

NumericValue is mandatory. A single instance is required.

A grouping element for a numeric value and its statistical measures.

TextValue

TextValue is mandatory. A single instance is required.

A value in text format.

PropertySubValue

PropertySubValue is optional. Multiple instances might exist.

A child element of PropertyValue. It specifies a value for a property related to the property specified by the attribute PropertyType of the mother element, e.g. the diameter of the property KnotUnSound. The property is defined by the attribute PropertyType. The attribute MeasuringMethod and MeasuringAgency can be used to clarify details for a how a property is measured or calculated, e.g. Diameter of a log can be measured "Under Bark" or "Over Bark". The attribute MeasuringMethodType defines how the value is created, e.g. measured automatically, calculated etc. The attribute IsAverageValue indicates if the value is an average value or not.

PropertyValueOfWhichMin

A child element of PropertyValue. It specifies a minimum value for a property that is part of the property specified by the attribute PropertyType of the mother element PropertyValue, e.g. the minimum number of the property KnotSound contained in the number of the property Knot specified by the attribute PropertyType of PropertyValue. The property is defined by the attribute PropertyType. The attribute MeasuringMethod and MeasuringAgency can be used to

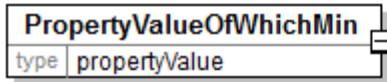

clarify details for a how a property is measured or calculated, e.g. Diameter of a log can be measured "Under Bark" or "Over Bark". The attribute MeasuringMethodType defines how the value is created, e.g. measured automatically, calculated etc. The attribute IsAverageValue indicates if the value is an average value or not.

PropertyType [attribute]

PropertyType is mandatory. A single instance is required.

Defines the type of property for an item.

Refer to PropertyType definition for any enumerations.

MeasuringMethodType [attribute]

MeasuringMethodType is optional. A single instance might exist.

Specifies how a measurement value is created.

Refer to MeasuringMethodType definition for any enumerations.

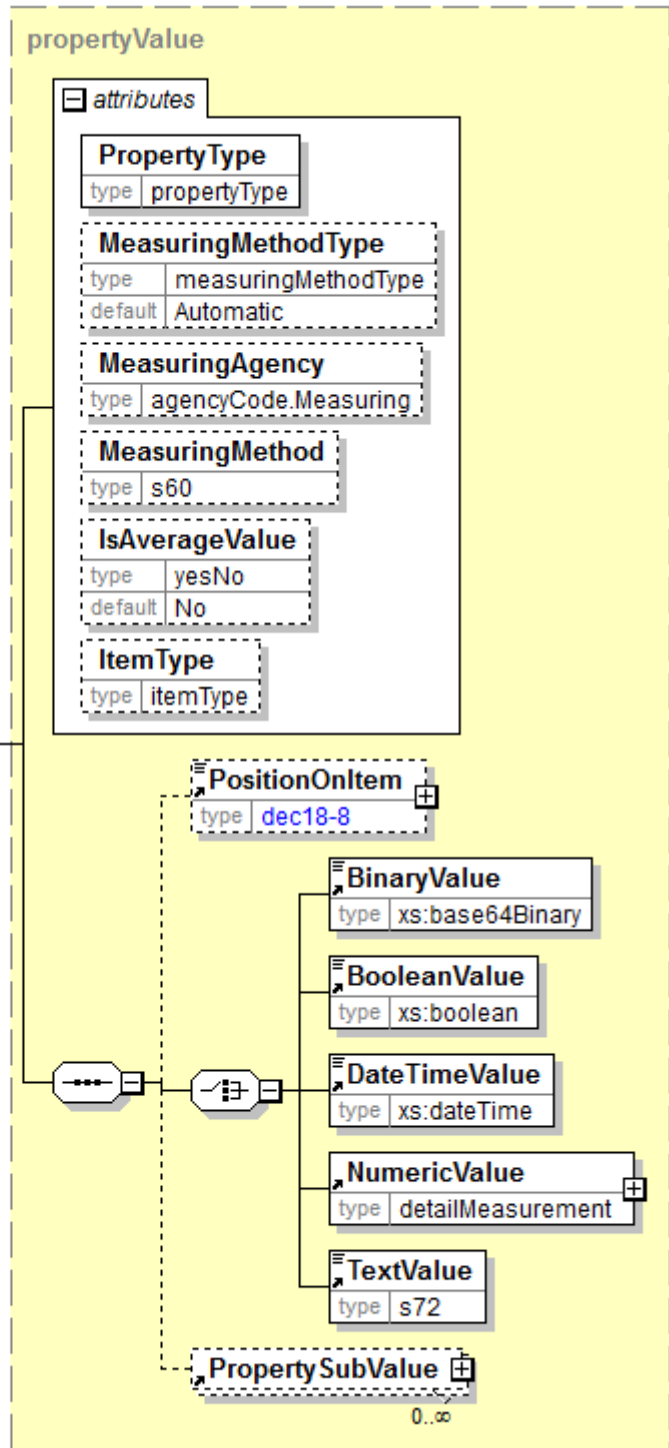

MeasuringAgency [attribute]

MeasuringAgency is optional. A single instance might exist.

The agency defining measuring methods.

Refer to MeasuringAgency definition for any enumerations.

MeasuringMethod [attribute]

MeasuringMethod is optional. A single instance might exist.

The method used to determine how the item under consideration is measured. Measuring methods are defined by the measuring agency.

IsAverageValue [attribute]

IsAverageValue is optional. A single instance might exist.

Indicates if the value is an average value or not.

Refer to IsAverageValue definition for any enumerations.

ItemType [attribute]

ItemType is optional. A single instance might exist.

Indicates the form of the item being reported as being used. Many of the ItemType(s) indicated here have a corresponding named element equivalent, which is referenced here for definition purposes.

Refer to ItemType definition for any enumerations.

(sequence)

The sequence of items below is mandatory. A single instance is required.

PositionOnItem

PositionOnItem is optional. A single instance might exist.

Specifies a position on an item. The attribute PositionMeasuredFrom defines the reference point for the position

(choice)

Choice is mandatory. A single instance is required.

BinaryValue

BinaryValue is mandatory. A single instance is required.

A value in base-64-encoded binary format.

BooleanValue

BooleanValue is mandatory. A single instance is required.

A value in boolean format.

DateTimeValue

DateTimeValue is mandatory. A single instance is required.

A Date and Time value in the standard W3C xs:dateTime format.

NumericValue

NumericValue is mandatory. A single instance is required.

A grouping element for a numeric value and its statistical measures.

TextValue

TextValue is mandatory. A single instance is required.

A value in text format.

PropertySubValue

PropertySubValue is optional. Multiple instances might exist.

A child element of PropertyValue. It specifies a value for a property related to the property specified by the attribute PropertyType of the mother element, e.g. the diameter of the property KnotUnSound. The property is defined by the attribute PropertyType. The attribute MeasuringMethod and MeasuringAgency can be used to clarify details for a how a property is measured or calculated, e.g. Diameter of a log can be measured "Under Bark" or "Over Bark". The attribute MeasuringMethodType defines how the value is created, e.g. measured automatically, calculated etc. The attribute IsAverageValue indicates if the value is an average value or not.

Pulp

A group item defining the characteristics of pulp that are not dependent on a particular conversion process.

(sequence)

The sequence of items below is mandatory. A single instance is required.

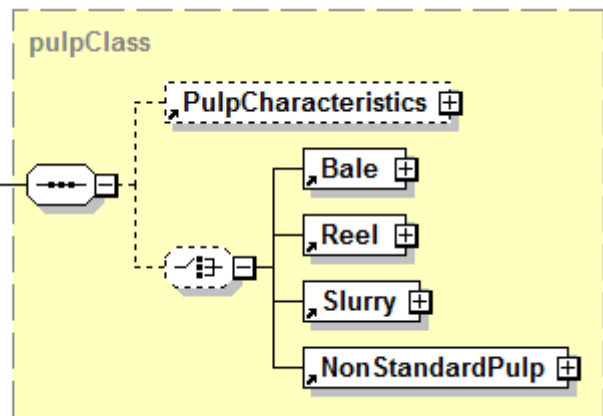
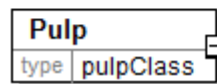

PulpCharacteristics

PulpCharacteristics is optional. A single instance might exist.

The physical and chemical characteristics of the pulp product regardless of the form that it is taking.

(choice)

[choice] is optional. A single instance might exist.

Bale

Bale is mandatory. A single instance is required.

A single or rectangular grouping of product

Reel

Reel is mandatory. A single instance is required.

A group item that contains the conversion and packaging characteristics of a reel.

Slurry

Slurry is mandatory. A single instance is required.

Product that has moisture content high enough to prevent formation of a sheet, and which can be delivered in liquid form.

Examples:

Product that has moisture content high enough to prevent formation of a sheet, and which can be delivered in liquid form. Examples: Noodle pulp, is

papiNet V2R31

pumped into trucks as thick slurry, and then pumped directly into the hydropulper. It has the higher strength properties of never dried pulp.

Product that has moisture content high enough to prevent formation of a sheet, and which can be delivered in liquid form. Examples: Noodle pulp, is pumped into trucks as thick slurry, and then pumped directly into the hydropulper. It has the higher strength properties of never dried pulp. Liquid pulp, never dried pulp, often pumped directly, using a flow meter to measure the moisture and fibre content. Sold by weight of the fibre.

NonStandardPulp

NonStandardPulp is mandatory. A single instance is required.

The characteristics of the form that pulp in a nonstandard presentation takes.

PulpCharacteristics

The physical and chemical characteristics of the pulp product regardless of the form that it is taking.

PulpingProcess [attribute]

PulpingProcess is optional. A single instance might exist.

Communicates the pulping method used to produce the pulp fibre

Refer to PulpingProcess definition for any enumerations.

BleachingProcess [attribute]

BleachingProcess is optional. A single instance might exist.

Communicates the type of bleaching process used to make the pulp fibre

Refer to BleachingProcess definition for any enumerations.

FibreSource [attribute]

FibreSource is optional. A single instance might exist.

Communicates the source of the pulp fibre

Refer to FibreSource definition for any enumerations.

(sequence)

The sequence of items below is mandatory. A single instance is required.

Ash

Ash is optional. Multiple instances might exist.

A group item used to communicate the ash content of the product according to a particular TestMethod.

BasisWeight

BasisWeight is optional. Multiple instances might exist.

The weight of the paper expressed as a mass for a given surface area. In countries using the metric system, the basis weight is expressed as the weight in grams of one sheet of paper that is one square meter in area—not dependent on basic sheet size. In countries using the imperial system, the weight is expressed in pounds for a given ProductBasisSizeType.

Brightness

Brightness is optional. Multiple instances might exist.

A measurement of the degree of light reflectivity of the product.

Burst

Burst is optional. Multiple instances might exist.

A group item used to communicate bursting strength target or test value according to a particular TestMethod.

BurstIndex

BurstIndex is optional. Multiple instances might exist.

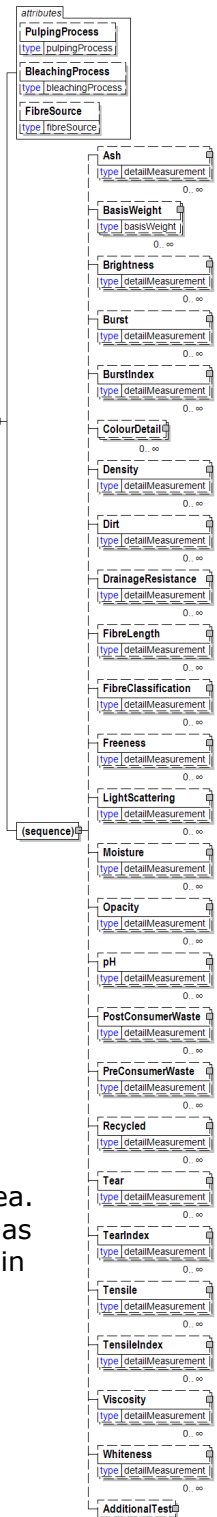

The burst index.

ColourDetail

ColourDetail is optional. Multiple instances might exist.

A group item used to communicate details of colour according to the selected colour definition scheme.

Density

Density is optional. Multiple instances might exist.

A group item used to communicate density target or test value according to a particular TestMethod.

Dirt

Dirt is optional. Multiple instances might exist.

A group item used to communicate dirt content target or test value according to a particular TestMethod.

DrainageResistance

DrainageResistance is optional. Multiple instances might exist.

A group item used to communicate drainage resistance target or test value.

FibreLength

FibreLength is optional. Multiple instances might exist.

A group item used to communicate fibre length target or test value according to a particular TestMethod.

FibreClassification

FibreClassification is optional. Multiple instances might exist.

A group item used to communicate fibre classification according to the specified classification scheme.

Freeness

Freeness is optional. Multiple instances might exist.

Freeness

LightScattering

LightScattering is optional. Multiple instances might exist.

A group item used to communicate light scattering coefficients according to a particular TestMethod.

Moisture

Moisture is optional. Multiple instances might exist.

Desired percentage, or other indicator, of water in the product at the time of shipment.

Opacity

Opacity is optional. Multiple instances might exist.

A group item used to communicate opacity target or test value according to a particular TestMethod.

pH

pH is optional. Multiple instances might exist.

A group item used to communicate pH (degree of acidity versus basicity) target or

test value according to a particular TestMethod.

PostConsumerWaste

PostConsumerWaste is optional. Multiple instances might exist.

A group item used to communicate the target or test value percentage of post consumer waste fibre in the product according to a particular TestMethod.

PreConsumerWaste

PreConsumerWaste is optional. Multiple instances might exist.

A group item used to communicate the target or test value percentage of pre-consumer waste fibre in the product according to a particular TestMethod.

Recycled

Recycled is optional. Multiple instances might exist.

A group item used to communicate the target or test value total percentage of waste fibre in the product according to a particular TestMethod.

Tear

Tear is optional. Multiple instances might exist.

A group item used to communicate tearing resistance target or test value according to a particular TestMethod.

TearIndex

TearIndex is optional. Multiple instances might exist.

TearIndex

Tensile

Tensile is optional. Multiple instances might exist.

A group item used to communicate zero-span tensile strength target or test value according to a particular TestMethod.

TensileIndex

TensileIndex is optional. Multiple instances might exist.

Tensile Index

Viscosity

Viscosity is optional. Multiple instances might exist.

Viscosity

Whiteness

Whiteness is optional. Multiple instances might exist.

A group item used to communicate degree of whiteness target or test value according to a particular TestMethod.

AdditionalTest

AdditionalTest is optional. A single instance might exist.

AdditionalTest exists to enable the inclusion of a test that has not been identified by papiNet.org. It is always a single-instance element so it is very important that users, who come upon a test that papiNet.org has not identified, communicate the need for this test to us at www.papiNet.org.

PulpConcernCode

A group of codes that qualifies the defect or issue with a particular unit of pulp.

Agency [attribute]

Agency is mandatory. A single instance is required.

Describes the agency maintaining the list of codes. To be included in this list the agency must be a recognized standards body or industry organisation.

- For the element that owns this attribute.
- For another attribute in the list of attributes associated with the parent element.

Refer to Agency definition for any enumerations.

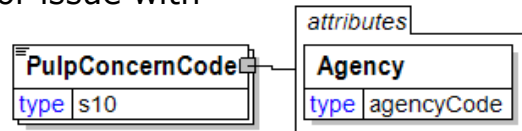

PulpConcernDescription

A narrative to correspond to the concern code.

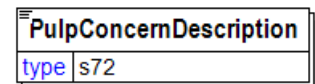

PulpConcerns

If the ConcernIndicatorType is "Y" for a pulp related product then a defect cause must be give.

MachineStoppage [attribute]

MachineStoppage is optional. A single instance might exist.

An indicator on whether the production had to be periodically stopped.

Refer to MachineStoppage definition for any enumerations.

(sequence)

The sequence of items below is mandatory. A single instance is required.

PulpConcernCode

PulpConcernCode is mandatory. One instance is required, multiple instances might exist.

A group of codes that qualifies the defect or issue with a particular unit of pulp.

PulpConcernDescription

PulpConcernDescription is optional. Multiple instances might exist.

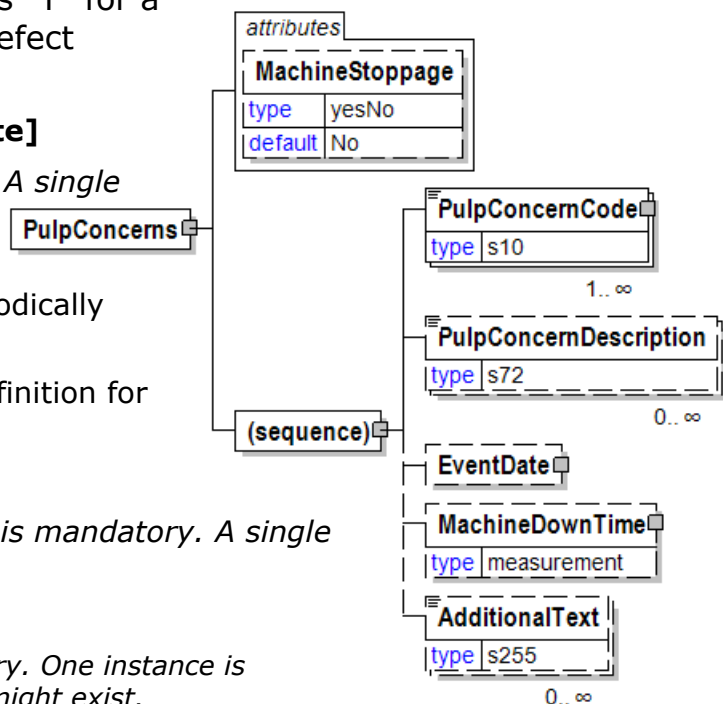

A narrative to correspond to the concern code.

EventDate

EventDate is optional. A single instance might exist.

The date the incident or delay on press was recorded.

MachineDownTime

MachineDownTime is optional. A single instance might exist.

The length of loss production time that a machine experienced due to malfunction regardless of cause.

AdditionalText

AdditionalText is optional. Multiple instances might exist.

A text field that is used to communicate information not previously defined or for special instructions. To be used only for circumstances not covered by specific elements.

PulpingProcess [attribute]

Communicates the pulping method used to produce the pulp fibre

This item is restricted to the following list.

attribute
PulpingProcess
type pulpingProcess

ChemicalPulp

In chemical pulping, wood is cooked in a digester at elevated pressure with a solution of the appropriate chemicals which dissolve the lignin and leave behind the cellulose.

ChemoThermoMechanicalPulp

Semi-chemical pulping process uses a combination of chemical, thermal and mechanical methods. The wood chips are partially cooked with chemicals, then heated, and the remainder of the pulping is accomplished mechanically.

DeinkedPulp

Pulp produced from deinked wastepaper, like old newsprint and old magazines.

RefinerGroundwood

Mechanical pulping process where the wood is pressed against a grinder which physically separates the fibers.

StoneGroundwood

The oldest of the large scale methods of pulping, dating back to the late 1840's is the groundwood process, in which debarked logs are forced against a huge revolving abrasive stone which shreds the fibres from the wood.

ThermoMechanical

This process, which reached commercial viability in the early 1970's, involves an initial stage in which wood chips, before entering a pressurized refiner, are softened by steam. This facilitates the separation of the cellulose and reduces damage to the individual fibres.

PulpUnitCharacteristics

A group element that contains information primarily of use for ordering.

(sequence)

The sequence of items below is mandatory. A single instance is required.

PackagingDescription

PackagingDescription is optional. A single instance might exist.

A text field element describing the packaging of a product.

Wrap

Wrap is optional. A single instance might exist.

A group item that organises wrapping detail information.

PalletCharacteristics

PalletCharacteristics is optional. A single instance might exist.

A group item that provides pallet detail information.

BalesPerUnit

BalesPerUnit is optional. A single instance might exist.

The number of bales included on the shipping, handling, or delivery unit.

LayersPerUnit

LayersPerUnit is optional. A single instance might exist.

The number of layers on the shipping, handling, or delivery unit. (This element uses pattern matching to ensure the appropriate format for latitude.)

LabelCharacteristics

LabelCharacteristics is optional. A single instance might exist.

A group item that organises the labeling information.

StencilCharacteristics

StencilCharacteristics is optional. Multiple instances might exist.

A group element specifying attributes of a stencil to be applied to an item, and optional text.

MaximumGrossWeight

MaximumGrossWeight is optional. A single instance might exist.

The maximum weight allowed including the pallet.

AdditionalText

AdditionalText is optional. Multiple instances might exist.

A text field that is used to communicate information not previously defined or for special instructions. To be used only for circumstances not covered by specific elements.

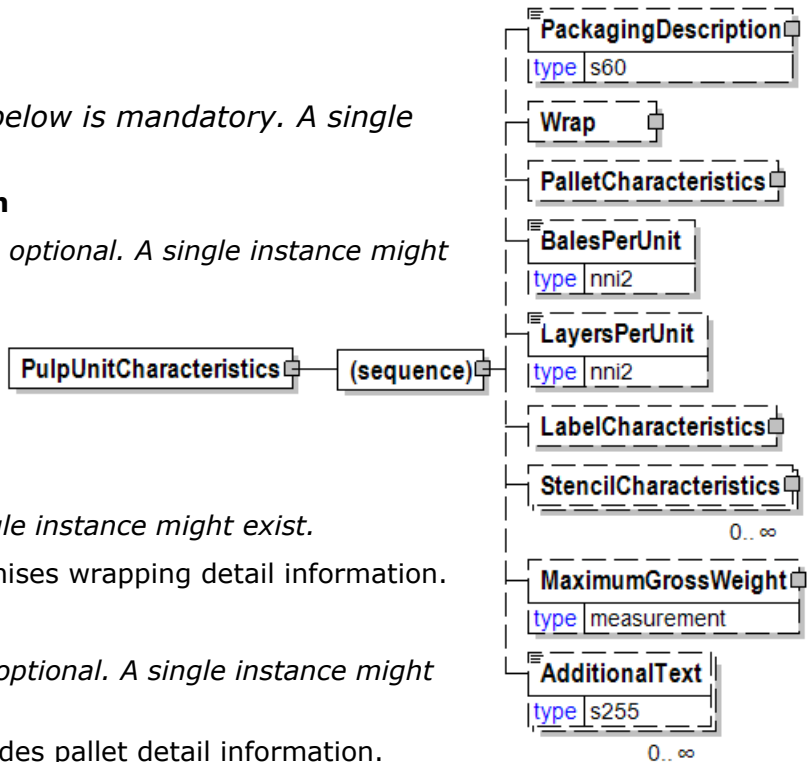

PunchedHoleDetails

A grouping element that will contain the configuration information for punched holes.

(sequence)

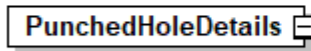

The sequence of items below is mandatory. A single instance is required.

NumberOfHoles

NumberOfHoles is optional. A single instance might exist.

The number of holes punched in a sheet of paper.

HoleReinforcement

HoleReinforcement is optional. A single instance might exist.

Hole reinforcement

Refer to HoleReinforcement definition for any enumerations.

(choice)

[choice] is optional. A single instance might exist.

HolePunchType

HolePunchType is mandatory. A single instance is required.

Hole punch type.

Refer to HolePunchType definition for any enumerations.

(sequence)

The sequence of items below is mandatory. A single instance is required.

StandardSpacing

StandardSpacing is optional. A single instance might exist.

Is the spacing standard?

Refer to StandardSpacing definition for any enumerations.

SizeOfHolePunch

SizeOfHolePunch is optional. A single instance might exist.

A definition of the size and shape of the punched holes.

HoleSpacing

HoleSpacing is optional. A single instance might exist.

The HoleSpacing element is used to communicate the distance between holes.

DistanceFromEdge

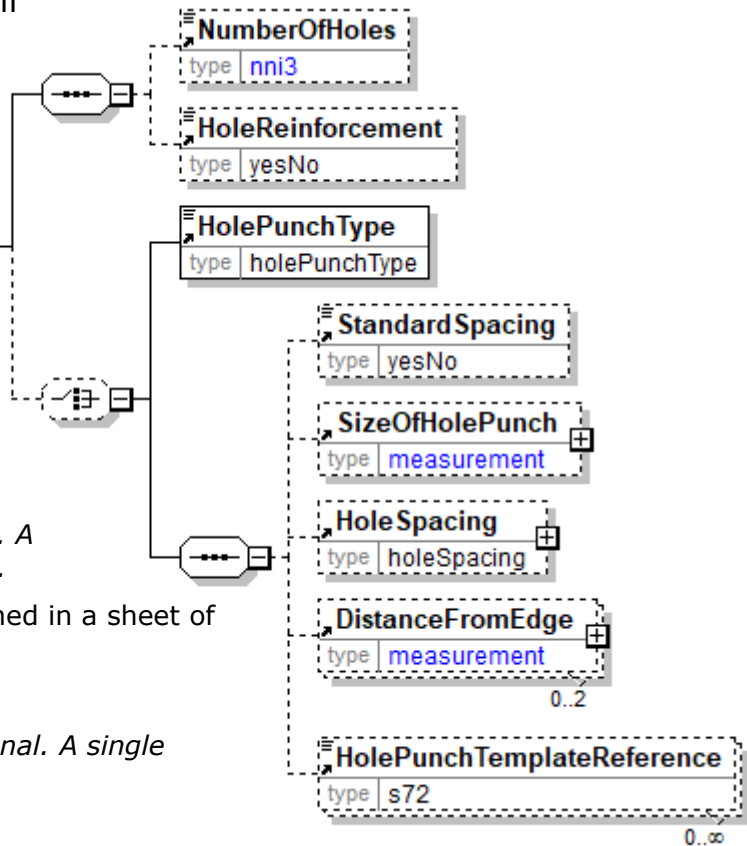

DistanceFromEdge is optional.

The distance from the edge of the paper. This element is used to communicate where the hole is.

HolePunchTemplateReference

HolePunchTemplateReference is optional. Multiple instances might exist.

Hole punch template reference

PurchaseOrder

The PurchaseOrder element is the root element for the PurchaseOrder e-Document.

A buyer sends a PurchaseOrder e-Document to a supplier to initiate a trade transaction. This e-Document, which is a request for product, usually represents a firm commitment to buy. (For one type of PurchaseOrder, called a reservation order, the PurchaseOrder is not a firm commitment to buy).

PurchaseOrderType [attribute]

PurchaseOrderType is mandatory. A single instance is required.

Defines the type of PurchaseOrder issued.

Refer to PurchaseOrderType definition for any enumerations.

PurchaseOrderStatusType [attribute]

PurchaseOrderStatusType is mandatory. A single instance is required.

Defines the status of the entire PurchaseOrder e-Document, in other words, at the root level

Refer to PurchaseOrderStatusType definition for any enumerations.

Reissued [attribute]

Reissued is optional. A single instance might exist.

Either "Yes" or "No".

Refer to Reissued definition for any enumerations.

Language [attribute]

Language is optional. A single instance might exist.

The valid Alpha 2- and Alpha 3-character list of language codes in the ISO 639-1 and 639-2 international standards.

Information on the content of this attribute is available at:

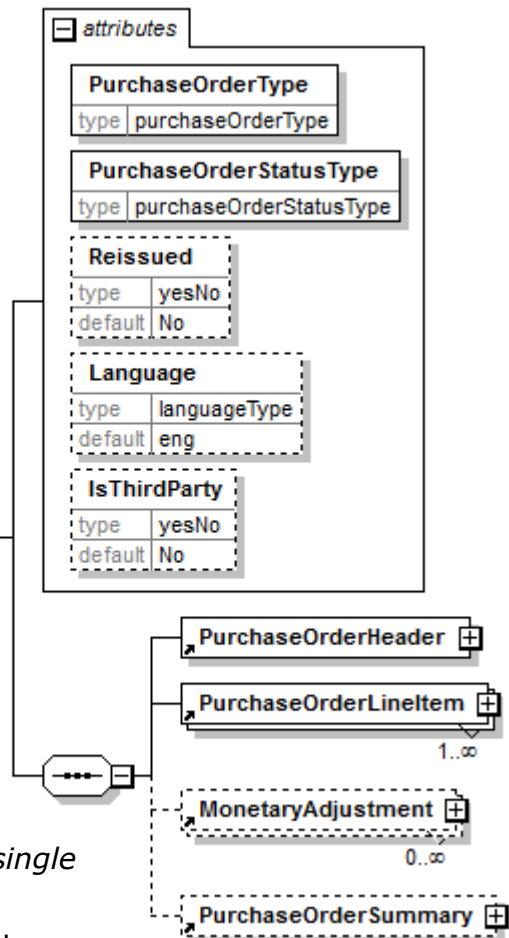
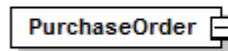

https://www.loc.gov/standards/iso639-2/php/code_list.php

IsThirdParty [attribute]

IsThirdParty is optional. A single instance might exist.

Indication of an indirect business process.

Refer to IsThirdParty definition for any enumerations.

(sequence)

The sequence of items below is mandatory. A single instance is required.

PurchaseOrderHeader

PurchaseOrderHeader is mandatory. A single instance is required.

The header level of information for the PurchaseOrder containing information that relates to the entire PurchaseOrder.

PurchaseOrderLineItem

PurchaseOrderLineItem is mandatory. One instance is required, multiple instances might exist.

A group item containing information that relates to a line on the purchase order.

MonetaryAdjustment

MonetaryAdjustment is optional. Multiple instances might exist.

The element containing the information necessary for the understanding, calculation, and treatment of an adjustment to a currency amount. MonetaryAdjustment contains an attribute that indicates they type of adjustment being communicated.

PurchaseOrderSummary

PurchaseOrderSummary is optional. A single instance might exist.

A group item containing summary information applicable to the entire purchase order.

PurchaseOrderDetail

Multiple PurchaseOrderDetail instances are allowed.

(sequence)

The sequence of items below is mandatory. A single instance is required.

PurchaseOrderInformation

PurchaseOrderInformation is optional. A single instance might exist.

A group item containing information unique to this PurchaseOrder, which is provided by the buyer. PurchaseOrderInformation can be optional in the supply chain. Invoices are created without having a PurchaseOrder in Vendor Managed

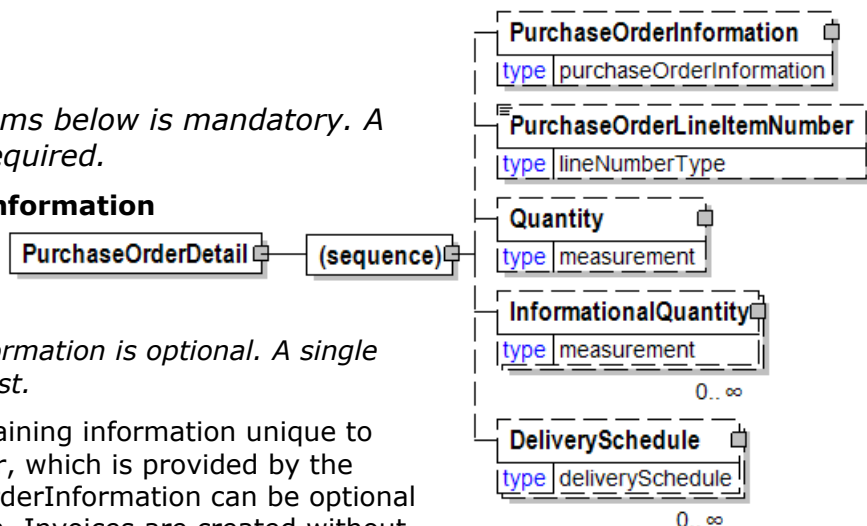

Inventory. Freight invoices also will not have a PurchaseOrder number.

PurchaseOrderLineItemNumber

PurchaseOrderLineItemNumber is optional. A single instance might exist.

The sequential number that uniquely identifies the PurchaseOrder line item.

Quantity

Quantity is optional. A single instance might exist.

The Quantity element contains attributes that provide information about the type of quantity that is being communicated, the context in which the particular quantity is to be viewed, and (if the quantity represents an adjustment) an adjustment type.

The Quantity element contains three child elements that enable you to communicate a range of values for the quantity and a target or actual value. It is at this level (Value, RangeMin, and RangeMax) that the unit of measure is specified. This permits the range to be specified in a different unit of measure than the target.

InformationalQuantity

InformationalQuantity is optional. Multiple instances might exist.

A quantity given in a valid UOM used for information purposes only (not for calculation). For example, an ordered quantity was 100 reels as opposed to the invoice quantity of 20,000 pounds.

DeliverySchedule

DeliverySchedule is optional. Multiple instances might exist.

A group item defining a series of DeliveryDateWindow(s) in which specified quantities must be delivered.

PurchaseOrderHeader

The header level of information for the PurchaseOrder containing information that relates to the entire PurchaseOrder.

PurchaseOrderHeaderStatusType [attribute]

PurchaseOrderHeaderStatusType is mandatory. A single instance is required.

Defines the status of the PurchaseOrder header

Refer to PurchaseOrderHeaderStatusType definition for any enumerations.

(sequence)

The sequence of items below is mandatory. A single instance is required.

PurchaseOrderInformation

PurchaseOrderInformation is mandatory. A single instance is required.

A group item containing information unique to this PurchaseOrder, which is provided by the buyer. PurchaseOrderInformation can be optional in the supply chain. Invoices are created without having a PurchaseOrder in Vendor Managed Inventory. Freight invoices also will not have a PurchaseOrder number.

TransactionHistoryNumber

TransactionHistoryNumber is optional. A single instance might exist.

A sequential number that keeps track of the version of a document.

However when the document is a confirmation document, in which case the TransactionHistoryNumber refers to the trigger transaction for the confirmation.

BuyerParty

BuyerParty is mandatory. A single instance is required.

The legal entity to which the product is sold. Also commonly referred to as the sold-to party or customer. If no OtherParty is defined as the Payer, the Buyer is the Payer.

BillToParty

BillToParty is optional. A single instance might exist.

The address where the invoice is to be sent.

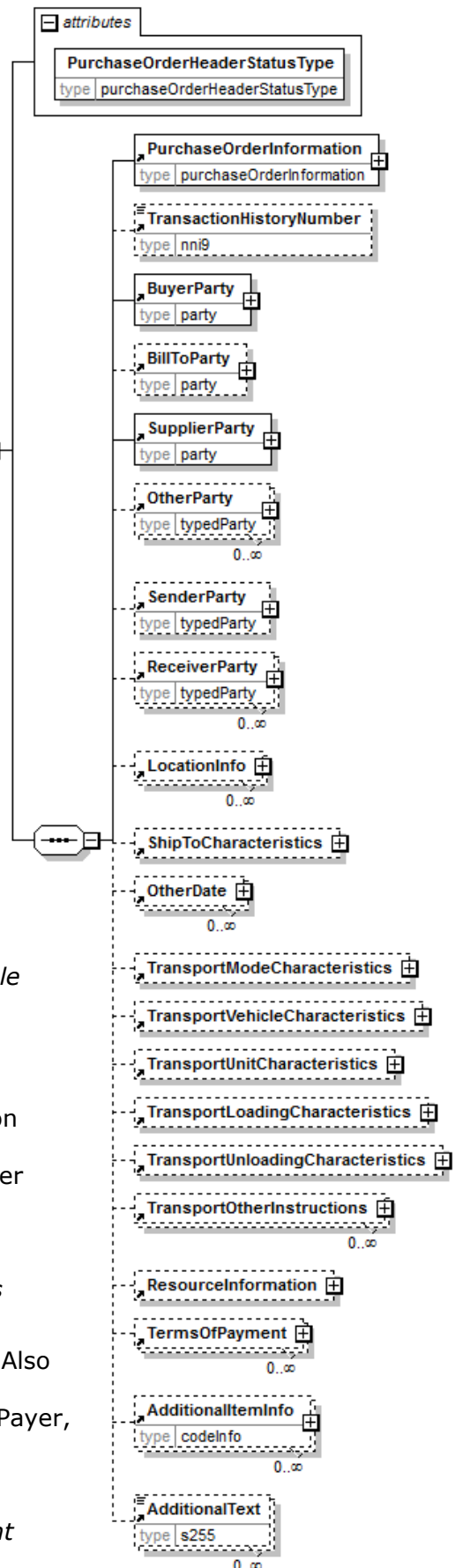

SupplierParty

SupplierParty is mandatory. A single instance is required.

The organisation or business entity responsible for providing the product. SupplierParty is also the seller of the product, if Seller is not specified as OtherParty = Seller.

OtherParty

OtherParty is optional. Multiple instances might exist.

An organisation or business entity other than those specifically detailed within an e-Document.

SenderParty

SenderParty is optional. A single instance might exist.

The business entity issuing the e-Document, the source of the document.

The entity responsible for the content. If the sender party has out sourced the message service to a third party the SenderParty is the issuer of the e-Document and not the party performing the transmission service of the electronic message.

ReceiverParty

ReceiverParty is optional. Multiple instances might exist.

The business entity for whom the e-Document is intended, the destination of the document.

The entity interested in the content. If the receiver party has outsourced the message service to a third party the ReceiverParty is the intended party for the e-Document and not the party performing the receiving service of the electronic message.

LocationInfo

LocationInfo is optional. Multiple instances might exist.

A grouping element that contains information about a geographical location.

ShipToCharacteristics

ShipToCharacteristics is optional. A single instance might exist.

A group item that provides information important for the Ship-To Party.

OtherDate

OtherDate is optional. Multiple instances might exist.

A date that may not be specifically detailed within a document (example: print date at the PurchaseOrderLineItem).

TransportModeCharacteristics

TransportModeCharacteristics is optional. A single instance might exist.

A group item defining the primary mode of transport.

TransportVehicleCharacteristics

TransportVehicleCharacteristics is optional. A single instance might exist.

A group item containing information about a transport vehicle, e.g. a truck. A transport vehicle has its own power and can be used to pull, push, carry, or tow a transport unit loaded with goods.

TransportUnitCharacteristics

papiNet V2R31

TransportUnitCharacteristics is optional. A single instance might exist.

A group item containing information about a transport unit, e.g. a trailer. Transport units contain goods and move using power from another source, the transport vehicle.

TransportLoadingCharacteristics

TransportLoadingCharacteristics is optional. A single instance might exist.

A group item defining how the transported items are to be loaded.

TransportUnloadingCharacteristics

TransportUnloadingCharacteristics is optional. A single instance might exist.

A group item defining how the transported items are to be unloaded.

TransportOtherInstructions

TransportOtherInstructions is optional. Multiple instances might exist.

A group item defining any other instructions for the transport not covered in the description of transport mode, vehicle, unit, and loading characteristics or defining an alternative description for the categories mentioned above.

ResourceInformation

ResourceInformation is optional. A single instance might exist.

A group item that contains information for specification of resources.

TermsOfPayment

TermsOfPayment is optional. Multiple instances might exist.

A group item that contains agreed-to terms defining when, how, and under what conditions the payment is to be made.

When TermsOfPayment is optional; if omitted, TermsOfPayment is controlled through previous negotiation.

AdditionalItemInfo

AdditionalItemInfo is optional. Multiple instances might exist.

A grouping element that contains information about additional items specified by an agency. Restricted use of this element is recommended.

AdditionalText

AdditionalText is optional. Multiple instances might exist.

A text field that is used to communicate information not previously defined or for special instructions. To be used only for circumstances not covered by specific elements.

PurchaseOrderHeaderStatusType [attribute]

Defines the status of the PurchaseOrder header

This item is restricted to the following list.

Amended

The supplied information is changed.

Cancelled

attribute
PurchaseOrderHeaderStatusType
type purchaseOrderHeaderStatusType

papiNet V2R31

The supplied information has been cancelled. Items that have been cancelled are not included in totals on the summary levels of the e-Document.

New

The supplied information is new and supplied for the first time.

NoAction

The supplied information has not been amended and thereby requires no action.

PurchaseOrderInformation

A group item containing information unique to this PurchaseOrder, which is provided by the buyer. PurchaseOrderInformation can be optional in the supply chain. Invoices are created without having a PurchaseOrder in Vendor Managed Inventory. Freight invoices also will not have a PurchaseOrder number.



(sequence)

The sequence of items below is mandatory. A single instance is required.

PurchaseOrderNumber

PurchaseOrderNumber is optional. A single instance might exist.

The unique order identifier as designated by the customer.

PurchaseOrderReleaseNumber

PurchaseOrderReleaseNumber is optional. A single instance might exist.

The version or release of the PurchaseOrder.

PurchaseOrderIssuedDate

PurchaseOrderIssuedDate is optional. A single instance might exist.

The Date and Time on which the PurchaseOrder was issued within the buyer's system.

OrderTitle

OrderTitle is optional. Multiple instances might exist.

A text describing the context of the order

PurchaseOrderReference

PurchaseOrderReference is optional. Multiple instances might exist.

An item detailing relevant references (such as contract number) pertaining to the PurchaseOrder. The type of reference is identified by the

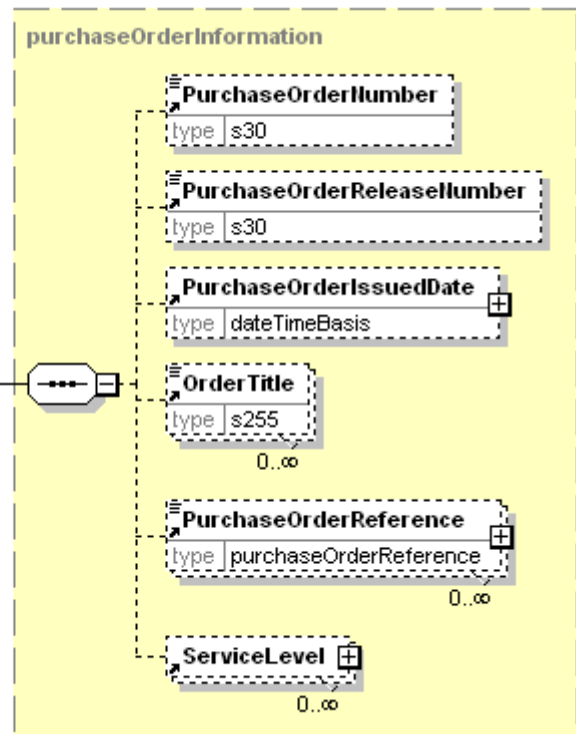

PurchaseOrderReferenceType attribute.

ServiceLevel

ServiceLevel is optional. Multiple instances might exist.

A grouping element containing information about a service level. The service level can be specified in a Service Level Agreement (SLA) detailing requirements such as delivery, performance, pricing, quality, etc.

PurchaseOrderIssuedDate

The Date and Time on which the PurchaseOrder was issued within the buyer's system.

(sequence)

The sequence of items below is mandatory. A single instance is required.

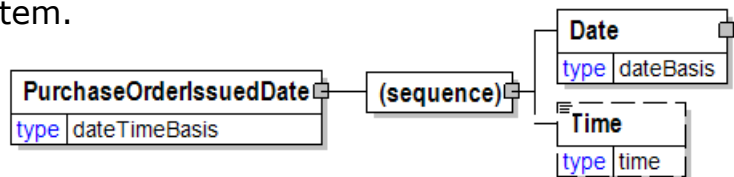

Date

Date is mandatory. A single instance is required.

A group element that contains the specification of Year, Month, and Day.

Time

Time is optional. A single instance might exist.

Times are treated in a standard XML fashion with a special case used to indicate a generalized "local" time. The standard XML approach to time is hh:mm:ss, hh:mm:ssZ, or hh:mm:ss±hh:mm.

hh:mm:ss±hh:mm is used to represent a time with a time zone. The time zone is communicated as the number of hours offset from the Universal Time Coordinate (UTC), a.k.a. Greenwich Mean Time.

hh:mm:ssZ indicates the time at Zulu (another name for UTC).

hh:mm:ss or hh:mm indicates within papiNet the applicable local time where the associated event is taking place. Caution should be used when processing times of this nature as the papiNet approach may be in discord with other users of XML.

PurchaseOrderLineItem

A group item containing information that relates to a line on the purchase order.

PurchaseOrderLineItemStatusType [attribute]

PurchaseOrderLineItemStatusType is mandatory. A single instance is required.

Defines the status of the PurchaseOrder line item

Refer to PurchaseOrderLineItemStatusType definition for any enumerations.

PurchaseOrderLineItemDocumentStatus [attribute]

PurchaseOrderLineItemDocumentStatus is optional. A single instance might exist.

Defines the actual document status for the PurchaseOrderLineItem.

Refer to PurchaseOrderLineItemDocumentStatus definition for any enumerations.

Billable [attribute]

Billable is optional. A single instance might exist.

Either "Yes" or "No".

Refer to Billable definition for any enumerations.

(sequence)

The sequence of items below is mandatory. A single instance is required.

PurchaseOrderLineItemNumber

PurchaseOrderLineItemNumber is mandatory. A single instance is required.

The sequential number that uniquely identifies the PurchaseOrder line item.

PurchaseOrderReference

PurchaseOrderReference is optional. Multiple instances might exist.

An item detailing relevant references (such as contract number) pertaining to the PurchaseOrder. The type of reference is identified by the PurchaseOrderReferenceType attribute.

Product

Product is mandatory. A single instance is required.

Product is a group item defining the article and its characteristics. Product is used to specify product characteristics organized by ProductIdentifier, ProductDescription, and Classification. Book Manufacturing, Label Stock, Paper, Pulp, Recovered Paper, Wood Products, and Virgin Fibre market segments have defined their

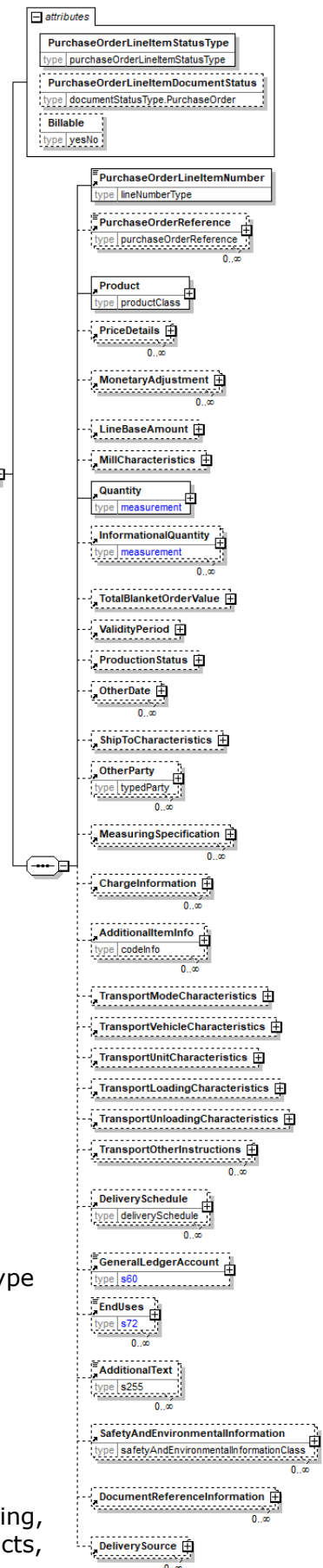

product characteristics and conversion features for implementation in papiNet.

PriceDetails

PriceDetails is optional. Multiple instances might exist.

An element that groups together price information.

MonetaryAdjustment

MonetaryAdjustment is optional. Multiple instances might exist.

The element containing the information necessary for the understanding, calculation, and treatment of an adjustment to a currency amount. MonetaryAdjustment contains an attribute that indicates they type of adjustment being communicated.

LineBaseAmount

LineBaseAmount is optional. A single instance might exist.

For the particular e-Document being communicated the LineBaseAmount represents the quantity times the base unit price.

MillCharacteristics

MillCharacteristics is optional. A single instance might exist.

A group item defining the mill party and machine identifier where a product is or was produced.

Quantity

Quantity is mandatory. A single instance is required.

The Quantity element contains attributes that provide information about the type of quantity that is being communicated, the context in which the particular quantity is to be viewed, and (if the quantity represents an adjustment) an adjustment type.

The Quantity element contains three child elements that enable you to communicate a range of values for the quantity and a target or actual value. It is at this level (Value, RangeMin, and RangeMax) that the unit of measure is specified. This permits the range to be specified in a different unit of measure than the target.

InformationalQuantity

InformationalQuantity is optional. Multiple instances might exist.

A quantity given in a valid UOM used for information purposes only (not for calculation). For example, an ordered quantity was 100 reels as opposed to the invoice quantity of 20,000 pounds.

TotalBlanketOrderValue

TotalBlanketOrderValue is optional. A single instance might exist.

The authorized amount of the blanket PurchaseOrder.

ValidityPeriod

ValidityPeriod is optional. A single instance might exist.

The validity period for a specific item, e.g. the validity period for an e-Document.

ProductionStatus

ProductionStatus is optional. A single instance might exist.

A group item used to communicate the release of a delivery line number.

OtherDate

OtherDate is optional. Multiple instances might exist.

A date that may not be specifically detailed within a document (example: print date at the PurchaseOrderLineItem).

ShipToCharacteristics

ShipToCharacteristics is optional. A single instance might exist.

A group item that provides information important for the Ship-To Party.

OtherParty

OtherParty is optional. Multiple instances might exist.

An organisation or business entity other than those specifically detailed within an e-Document.

MeasuringSpecification

MeasuringSpecification is optional. Multiple instances might exist.

A grouping element that contains a specification for measurement procedures for a measuring party at a measuring location

ChargeInformation

ChargeInformation is optional. Multiple instances might exist.

A group element that contains elements that describe a charge. ChargeInformation is used when charge details need to be specified by using a code assigned by an agency. It is typically used for freight costs and other costs related to the supply chain.

AdditionalItemInfo

AdditionalItemInfo is optional. Multiple instances might exist.

A grouping element that contains information about additional items specified by an agency. Restricted use of this element is recommended.

TransportModeCharacteristics

TransportModeCharacteristics is optional. A single instance might exist.

A group item defining the primary mode of transport.

TransportVehicleCharacteristics

TransportVehicleCharacteristics is optional. A single instance might exist.

A group item containing information about a transport vehicle, e.g. a truck. A transport vehicle has its own power and can be used to pull, push, carry, or tow a transport unit loaded with goods.

TransportUnitCharacteristics

TransportUnitCharacteristics is optional. A single instance might exist.

A group item containing information about a transport unit, e.g. a trailer. Transport units contain goods and move using power from another source, the transport vehicle.

TransportLoadingCharacteristics

TransportLoadingCharacteristics is optional. A single instance might exist.

A group item defining how the transported items are to be loaded.

TransportUnloadingCharacteristics

TransportUnloadingCharacteristics is optional. A single instance might exist.

A group item defining how the transported items are to be unloaded.

TransportOtherInstructions

TransportOtherInstructions is optional. Multiple instances might exist.

A group item defining any other instructions for the transport not covered in the description of transport mode, vehicle, unit, and loading characteristics or defining an alternative description for the categories mentioned above.

DeliverySchedule

DeliverySchedule is optional. Multiple instances might exist.

A group item defining a series of DeliveryDateWindow(s) in which specified quantities must be delivered.

GeneralLedgerAccount

GeneralLedgerAccount is optional. A single instance might exist.

The general ledger account to be referenced for the item.

EndUses

EndUses is optional. Multiple instances might exist.

A text element used to express in human readable form a list of applicable end uses for a product. Examples of end uses are:

- Magazine
- Book
- Commercial print
- etc

AdditionalText

AdditionalText is optional. Multiple instances might exist.

A text field that is used to communicate information not previously defined or for special instructions. To be used only for circumstances not covered by specific elements.

SafetyAndEnvironmentalInformation

SafetyAndEnvironmentalInformation is optional. Multiple instances might exist.

Name of certification type, if any, on the goods (For example, FSC, PEFC). SafetyAndEnvironmental needs a value or measurement to communicate the percentage of the product is certified (for example, 75% is certified by the indicated agency).

DocumentReferenceInformation

DocumentReferenceInformation is optional. Multiple instances might exist.

A group item containing reference information applicable to a document.

DeliverySource

DeliverySource is optional. Multiple instances might exist.

A grouping element with information that identifies and specifies the source of a delivery, e.g. a logging area.

PurchaseOrderLineItemDocumentStatus [attribute]

Defines the actual document status for the PurchaseOrderLineItem.

This item is restricted to the following list.

attribute
PurchaseOrderLineItemDocumentStatus
type documentStatusType.PurchaseOrder

Cancelled

The supplied information of the document item is cancelled. Items that have been cancelled are not included in totals on the summary level of e-Documents.

Requested

The supplied information of the document item is ordered.

PurchaseOrderLineItemNumber

The sequential number that uniquely identifies the PurchaseOrder line item.

PurchaseOrderLineItemNumber
type lineNumberType

PurchaseOrderLineItemStatusType [attribute]

Defines the status of the PurchaseOrder line item

This item is restricted to the following list.

attribute
PurchaseOrderLineItemStatusType
type purchaseOrderLineItemStatusType

Amended

The supplied information is changed.

Cancelled

The supplied information has been cancelled. Items that have been cancelled are not included in totals on the summary levels of the e-Document.

New

The supplied information is new and supplied for the first time.

NoAction

The supplied information has not been amended and thereby requires no action.

PurchaseOrderNumber

The unique order identifier as designated by the customer.

PurchaseOrderNumber
type s30

PurchaseOrderReference

An item detailing relevant references (such as contract number) pertaining to the PurchaseOrder. The type of reference is identified by the

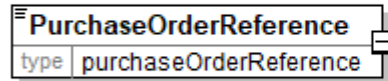

PurchaseOrderReferenceType attribute.

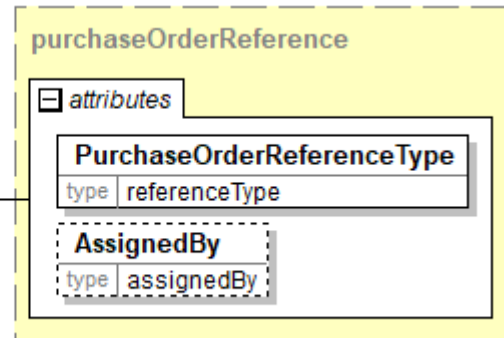

PurchaseOrderReferenceType [attribute]

PurchaseOrderReferenceType is mandatory. A single instance is required.

Provides a contextual explanation of the specific reference identifier. Many items are currently prefixed by "Buyer", "Forwarder", "Manufacturer", "Mill", "Seller", "Supplier", "Warehouse", or "Vendor". Check for an existing non-prefixed version and use the non-prefixed version instead. In the (yet to be announced release date) version 3.0 the prefixed versions will be removed. Instead the attribute @AssignedBy will communicate the information previously communicated in the prefix.

Refer to PurchaseOrderReferenceType definition for any enumerations.

AssignedBy [attribute]

AssignedBy is optional. A single instance might exist.

Identifies the type of party or the agency that has assigned the associated item, e.g. a reference of type OrderNumber.

Refer to AssignedBy for any enumerations.

PurchaseOrderReferenceType [attribute]

Provides a contextual explanation of the specific reference identifier. Many items are currently prefixed by "Buyer", "Forwarder", "Manufacturer", "Mill", "Seller", "Supplier", "Warehouse", or "Vendor". Check for an existing non-prefixed version and use the non-prefixed version instead. In the (yet to be announced release date) version 3.0 the prefixed versions will be removed. Instead the attribute @AssignedBy will communicate the information previously communicated in the prefix.

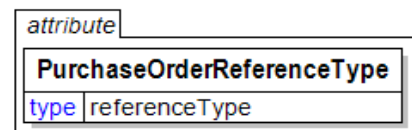

Refer to the [referenceType](#) entry for the list of enumerations and their definitions.

PurchaseOrderReleaseNumber

The version or release of the PurchaseOrder.

PurchaseOrderReleaseNumber	
type	s30

PurchaseOrderStatusType [attribute]

Defines the status of the entire PurchaseOrder e-Document, in other words, at the root level

This item is restricted to the following list.

attribute	
PurchaseOrderStatusType	
type	purchaseOrderStatusType

Amended

The supplied information is changed.

Cancelled

The supplied information has been cancelled. Items that have been cancelled are not included in totals on the summary levels of the e-Document.

Original

The supplied information is the first version of that information.

PurchaseOrderSummary

A group item containing summary information applicable to the entire purchase order.

(sequence)

The sequence of items below is mandatory. A single instance is required.

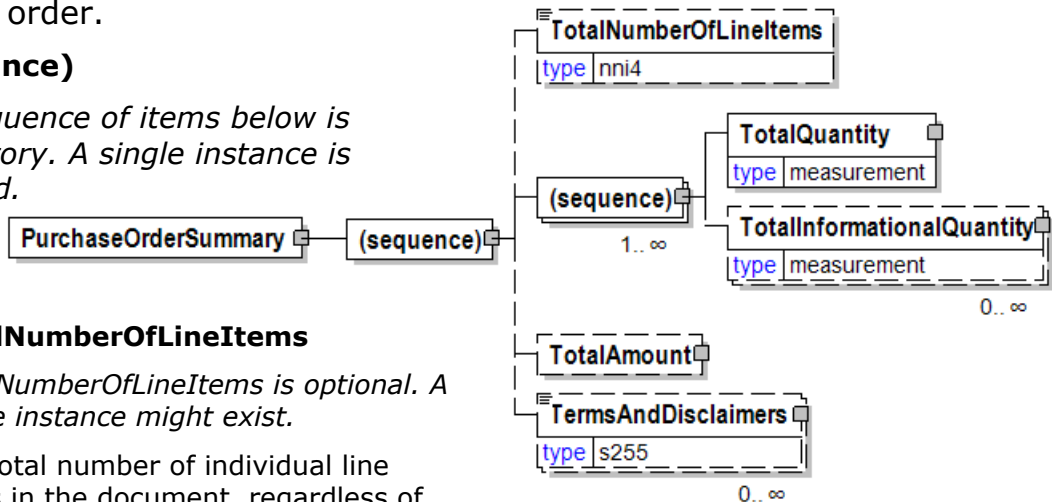

TotalNumberOfLineItems

TotalNumberOfLineItems is optional. A single instance might exist.

The total number of individual line items in the document, regardless of the status or type.

(sequence)

The sequence of items below is mandatory. One instance is required, multiple instances might exist.

TotalQuantity

TotalQuantity is mandatory. A single instance is required.

The total quantity of similar items in the e-Document. TotalQuantity is primarily used in the summary section of documents where it is repeatable to permit totaling for different units of measure.

TotalInformationalQuantity

TotalInformationalQuantity is optional. Multiple instances might exist.

A quantity that is used to communicate related information about the parent element. This element represents a total that is derived from individual line items.

TotalAmount

TotalAmount is optional. A single instance might exist.

The total amount including tax (when tax is specified in the e-Document).

In e-Documents claiming payment this is the amount due for payment based on the terms of payment. Decimal rounding might be applied to this amount.

TermsAndDisclaimers

TermsAndDisclaimers is optional. Multiple instances might exist.

An element that contains legal information with an indication of what the Language is.

PurchaseOrderType [attribute]

Defines the type of PurchaseOrder issued.

This item is restricted to the following list.

<i>attribute</i>
PurchaseOrderType
<i>type</i> purchaseOrderType

BlanketOrder

An order that communicates the same information as a StandardOrder but also indicates that the order may be completed over a period of time or, until a certain volume is achieved or, until a certain currency amount is spent.

ConfirmingOrder

A confirming order is used to electronically confirm an order that has not been placed electronically by the customer that is, it was placed using another mean such as fax, phone or email.

ConsumptionOrder

A PurchaseOrder that is based upon consumption for a particular period of time or instance.

ReleaseOrder

A release order is used to release a product to be made. This type of order refers to a previous order or agreement, such as a reservation order, a contract, or a blanket order. A release number version which is an incremented number, is used in this type.

ReservationOrder

A reservation order is used to book a paper supplier's capacity for specific quantities of specific products, but it is not yet a firm commitment to buy. Consequently, all line items of a reservation order have a ProductionStatusType of NotFree. To release one or more PurchaseOrder line items of a reservation order, a buyer can use a standard order or a release order.

StandardOrder

A standard order is a regular one-time order. It defines quantities for one or

more products to be purchased and may also define a delivery location and date. A standard order may reference a previous agreement (for example, a quotation, a contract, or a reservation order) for information.

TrialOrder

A trial order is used whenever a seller has agreed to have a buyer sample a product. The seller needs to process this order differently from other orders, because a trial order may include a product sold at a discounted rate or even provided for free. A trial order typically is for small quantities.

PurchaseOrderWood

The PurchaseOrderWood element is the root element for the PurchaseOrderWood e-Document.

A PurchaseOrderWood e-Document is set up between a buyer and a seller. In some cases an agent acts on behalf of the seller or the buyer when setting up the contract.

However, the contract is not valid until signed by the buyer and the seller. A PurchaseOrderWood may cover one delivery of merchandise on one occasion or cover a time period with several deliveries. This PurchaseOrderWood refers to a standardised contract form containing all legal details.

PurchaseOrderWood

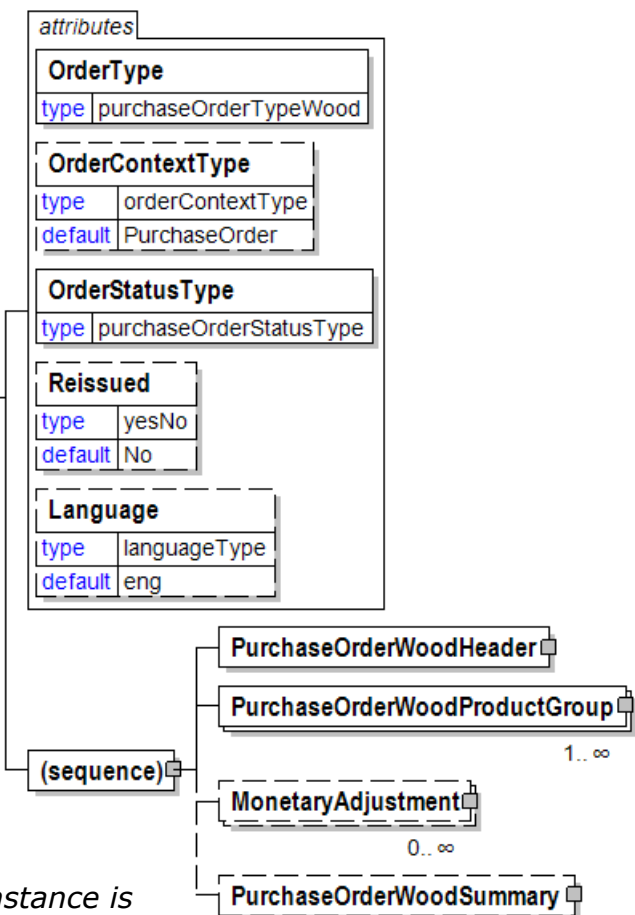

OrderType [attribute]

OrderType is mandatory. A single instance is required.

Defines the type of PurchaseOrder issued.

Refer to OrderType definition for any enumerations.

OrderContextType [attribute]

OrderContextType is optional. A single instance might exist.

Qualifies the source of the PurchaseOrder.

Refer to OrderContextType definition for any enumerations.

OrderStatusType [attribute]

OrderStatusType is mandatory. A single instance is required.

Defines the status of the entire PurchaseOrder e-Document, in other words, at

the root level

Refer to OrderStatusType definition for any enumerations.

Reissued [attribute]

Reissued is optional. A single instance might exist.

Either "Yes" or "No".

Refer to Reissued definition for any enumerations.

Language [attribute]

Language is optional. A single instance might exist.

The valid Alpha 2- and Alpha 3-character list of language codes in the ISO 639-1 and 639-2 international standards.

Information on the content of this attribute is available at:
https://www.loc.gov/standards/iso639-2/php/code_list.php

(sequence)

The sequence of items below is mandatory. A single instance is required.

PurchaseOrderWoodHeader

PurchaseOrderWoodHeader is mandatory. A single instance is required.

PurchaseOrderWood Header

PurchaseOrderWoodProductGroup

PurchaseOrderWoodProductGroup is mandatory. One instance is required, multiple instances might exist.

PurchaseOrderWoodProductGroup is a required, multiple instances element.

MonetaryAdjustment

MonetaryAdjustment is optional. Multiple instances might exist.

The element containing the information necessary for the understanding, calculation, and treatment of an adjustment to a currency amount. MonetaryAdjustment contains an attribute that indicates the type of adjustment being communicated.

PurchaseOrderWoodSummary

PurchaseOrderWoodSummary is optional. A single instance might exist.

Summary section of PurchaseOrderWood for wood vertical.

PurchaseOrderWoodHeader

PurchaseOrderWood Header

OrderHeaderStatusType [attribute]

OrderHeaderStatusType is mandatory. A single instance is required.

Defines the status of the PurchaseOrder header

Refer to OrderHeaderStatusType definition for any enumerations.

(sequence)

The sequence of items below is mandatory. A single instance is required.

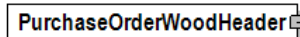

PurchaseOrderInformation

PurchaseOrderInformation is mandatory. A single instance is required.

A group item containing information unique to this PurchaseOrder, which is provided by the buyer. PurchaseOrderInformation can be optional in the supply chain. Invoices are created without having a PurchaseOrder in Vendor Managed Inventory. Freight invoices also will not have a PurchaseOrder number.

TransactionHistoryNumber

TransactionHistoryNumber is optional. A single instance might exist.

A sequential number that keeps track of the version of a document.

However when the document is a confirmation document, in which case the TransactionHistoryNumber refers to the trigger transaction for the confirmation.

OrderDocumentRequired

OrderDocumentRequired is optional. Multiple instances might exist.

Group element used to identify any external documents that need to be referenced and how many of those documents are required. Typically, used to identify hard copy documents.

This element will be deprecated in a future version V3R00. Use the DocumentInformation element instead.

BuyerParty

BuyerParty is mandatory. A single instance is required.

The legal entity to which the product is sold. Also commonly referred to as the sold-to party or customer. If no OtherParty is defined as the Payer, the Buyer is the Payer.

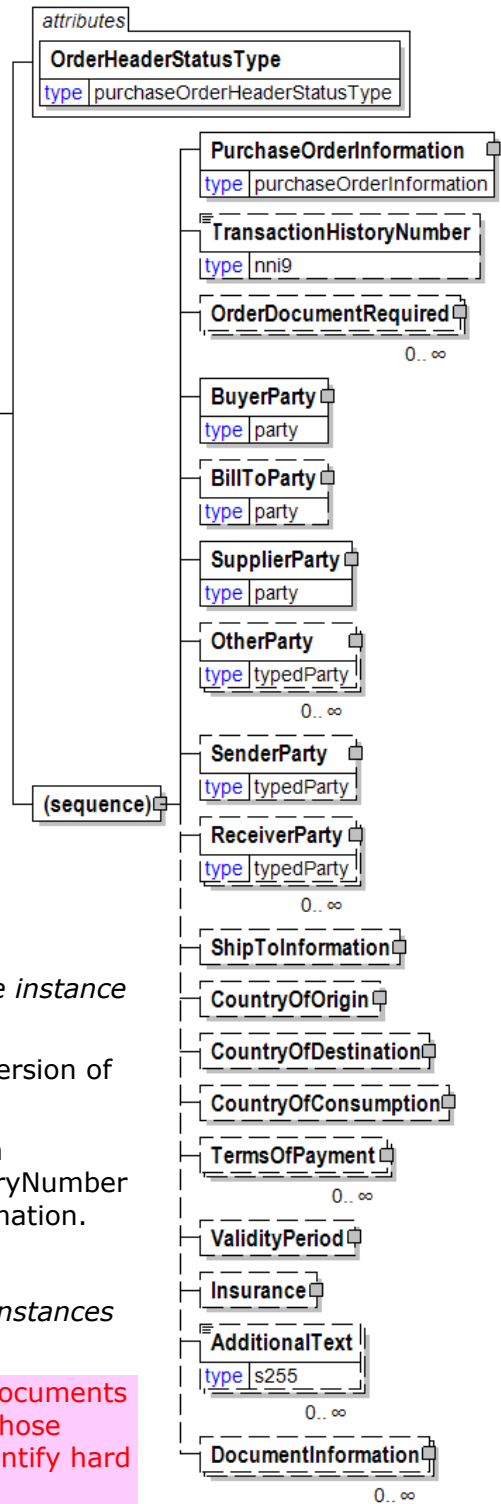

BillToParty

BillToParty is optional. A single instance might exist.

The address where the invoice is to be sent.

SupplierParty

SupplierParty is mandatory. A single instance is required.

The organisation or business entity responsible for providing the product.

SupplierParty is also the seller of the product, if Seller is not specified as OtherParty = Seller.

OtherParty

OtherParty is optional. Multiple instances might exist.

An organisation or business entity other than those specifically detailed within an e-Document.

SenderParty

SenderParty is optional. A single instance might exist.

The business entity issuing the e-Document, the source of the document.

The entity responsible for the content. If the sender party has out sourced the message service to a third party the SenderParty is the issuer of the e-Document and not the party performing the transmission service of the electronic message.

ReceiverParty

ReceiverParty is optional. Multiple instances might exist.

The business entity for whom the e-Document is intended, the destination of the document.

The entity interested in the content. If the receiver party has outsourced the message service to a third party the ReceiverParty is the intended party for the e-Document and not the party performing the receiving service of the electronic message.

ShipToInformation

ShipToInformation is optional. A single instance might exist.

Group element containing information about the ship to and delivery of a product.

CountryOfOrigin

CountryOfOrigin is optional. A single instance might exist.

The country of origin for the material.

CountryOfDestination

CountryOfDestination is optional. A single instance might exist.

The country where the goods will be, or were, shipped to.

CountryOfConsumption

CountryOfConsumption is optional. A single instance might exist.

The country of consumption for the material.

TermsOfPayment

TermsOfPayment is optional. Multiple instances might exist.

A group item that contains agreed-to terms defining when, how, and under what conditions the payment is to be made.

When TermsOfPayment is optional; if omitted, TermsOfPayment is controlled through previous negotiation.

ValidityPeriod

ValidityPeriod is optional. A single instance might exist.

The validity period for a specific item, e.g. the validity period for an e-Document.

Insurance

Insurance is optional. A single instance might exist.

Group element containing information about insurance

AdditionalText

AdditionalText is optional. Multiple instances might exist.

A text field that is used to communicate information not previously defined or for special instructions. To be used only for circumstances not covered by specific elements.

DocumentInformation

DocumentInformation is optional. Multiple instances might exist.

A group element containing a specification of required documents in the business process. Additional free text to be printed on documents can also be specified.

PurchaseOrderWoodLineItem

PurchaseOrderWood Line Item

OrderLineItemStatusType [attribute]

OrderLineItemStatusType is mandatory. A single instance is required.

Defines the status of the PurchaseOrder line item

Refer to OrderLineItemStatusType definition for any enumerations.

OrderLineItemDocumentStatus [attribute]

OrderLineItemDocumentStatus is optional. A single instance might exist.

Defines the actual document status for the PurchaseOrderLineItem.

Refer to OrderLineItemDocumentStatus definition for any enumerations.

(sequence)

The sequence of items below is mandatory. A single instance is required.

PurchaseOrderLineItemNumber

PurchaseOrderLineItemNumber is mandatory. A single instance is required.

The sequential number that uniquely identifies the PurchaseOrder line item.

DocumentReferenceInformation

DocumentReferenceInformation is optional. Multiple instances might exist.

A group item containing reference information applicable to a document.

Product

Product is mandatory. A single instance is required.

Product is a group item defining the article and its characteristics. Product is used to specify product characteristics organized by ProductIdentifier, ProductDescription, and Classification. Book Manufacturing, Label Stock, Paper, Pulp, Recovered Paper, Wood Products, and Virgin Fibre market segments have defined their product characteristics and conversion features for implementation in papiNet.

EndsDiscountInformation

EndsDiscountInformation is optional. A single

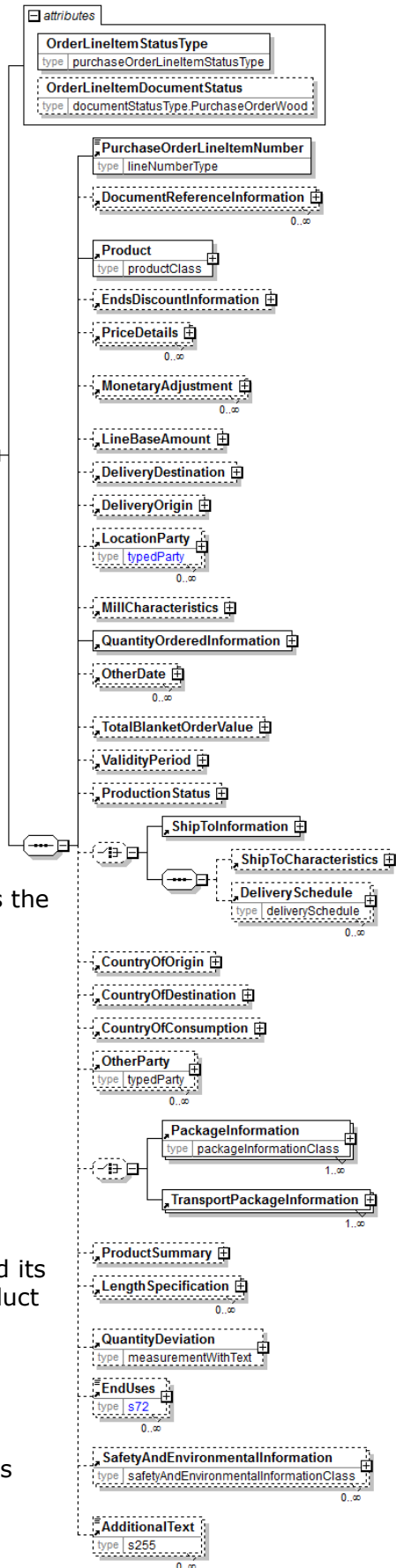

instance might exist.

Rule for calculating the ends discount, expressed by a code.

PriceDetails

PriceDetails is optional. Multiple instances might exist.

An element that groups together price information.

MonetaryAdjustment

MonetaryAdjustment is optional. Multiple instances might exist.

The element containing the information necessary for the understanding, calculation, and treatment of an adjustment to a currency amount.

MonetaryAdjustment contains an attribute that indicates they type of adjustment being communicated.

LineBaseAmount

LineBaseAmount is optional. A single instance might exist.

For the particular e-Document being communicated the LineBaseAmount represents the quantity times the base unit price.

DeliveryDestination

DeliveryDestination is optional. A single instance might exist.

The DeliveryDestination specifies the end of one leg of the delivery. In order to comply with the US Trade Act of 2002 you would use this element with a LocationParty/@PartyType of Port.

DeliveryOrigin

DeliveryOrigin is optional. A single instance might exist.

A group item that represents the start of one leg in a route. Compare to DeliveryDestination.

The DeliveryOrigin specifies the start of one leg of the delivery.

In order to comply with the US Trade Act of 2002 you would use this element with a LocationParty/@PartyType of Port.

LocationParty

LocationParty is optional. Multiple instances might exist.

The organization or business entity where the business event took place or will take place.

MillCharacteristics

MillCharacteristics is optional. A single instance might exist.

A group item defining the mill party and machine identifier where a product is or was produced.

QuantityOrderedInformation

QuantityOrderedInformation is mandatory. A single instance is required.

Used to identify quantity. The construct provides via InformationalQuantity the ability to provide the Quantity in another UOM. Length is also provided to further specify the quantity.

OtherDate

OtherDate is optional. Multiple instances might exist.

A date that may not be specifically detailed within a document (example: print

date at the PurchaseOrderLineItem).

TotalBlanketOrderValue

TotalBlanketOrderValue is optional. A single instance might exist.

The authorized amount of the blanket PurchaseOrder.

ValidityPeriod

ValidityPeriod is optional. A single instance might exist.

The validity period for a specific item, e.g. the validity period for an e-Document.

ProductionStatus

ProductionStatus is optional. A single instance might exist.

A group item used to communicate the release of a delivery line number.

(choice)

[choice] is optional. A single instance might exist.

ShipToInformation

ShipToInformation is mandatory. A single instance is required.

Group element containing information about the ship to and delivery of a product.

(sequence)

The sequence of items below is mandatory. A single instance is required.

ShipToCharacteristics

ShipToCharacteristics is optional. A single instance might exist.

A group item that provides information important for the Ship-To Party.

DeliverySchedule

DeliverySchedule is optional. Multiple instances might exist.

A group item defining a series of DeliveryDateWindow(s) in which specified quantities must be delivered.

CountryOfOrigin

CountryOfOrigin is optional. A single instance might exist.

The country of origin for the material.

CountryOfDestination

CountryOfDestination is optional. A single instance might exist.

The country where the goods will be, or were, shipped to.

CountryOfConsumption

CountryOfConsumption is optional. A single instance might exist.

The country of consumption for the material.

OtherParty

OtherParty is optional. Multiple instances might exist.

An organisation or business entity other than those specifically detailed within an e-Document.

(choice)

[choice] is optional. A single instance might exist.

PackageInformation

PackageInformation is mandatory. One instance is required, multiple instances might exist.

The purpose of the PackageInformation structure is to clearly identify physical handling items that constitute the delivery.

PackageInformation is the highest level of product packaging it describes the shipping or warehousing unit.

If you are communicating a package, usually for logistics or transport purposes, you should include the PackageType, Identifier, ItemCount, and Quantity. (Note: you still have the ability to describe the item with one of the "named" items.)

If you are communicating one of the named Items there is no need to include PackageType, Identifier, ItemCount, and Quantity.

Since either of these two approaches can be used the entire contents of this element are optional even though the parent may be required. It is expected that you will fill in the appropriate details.

TransportPackageInformation

TransportPackageInformation is mandatory. One instance is required, multiple instances might exist.

Information of a package used in transportation, can include several normal packages.

ProductSummary

ProductSummary is optional. A single instance might exist.

Group of elements to provide summary information on product level.

LengthSpecification

LengthSpecification is optional. Multiple instances might exist.

Length specification of the wood product.

QuantityDeviation

QuantityDeviation is optional. A single instance might exist.

To be deprecated in a future version V3R00. Use the Quantity element with a QuantityContext of "Deviation".

EndUses

EndUses is optional. Multiple instances might exist.

A text element used to express in human readable form a list of applicable end uses for a product. Examples of end uses are:

- Magazine
- Book
- Commercial print
- etc

SafetyAndEnvironmentalInformation

SafetyAndEnvironmentalInformation is optional. Multiple instances might exist.

Name of certification type, if any, on the goods (For example, FSC, PEFC). SafetyAndEnvironmental needs a value or measurement to communicate the percentage of the product is certified (for example, 75% is certified by the

indicated agency).

AdditionalText

AdditionalText is optional. Multiple instances might exist.

A text field that is used to communicate information not previously defined or for special instructions. To be used only for circumstances not covered by specific elements.

PurchaseOrderWoodProductGroup

PurchaseOrderWoodProductGroup is a required, multiple instances element.

(sequence)

The

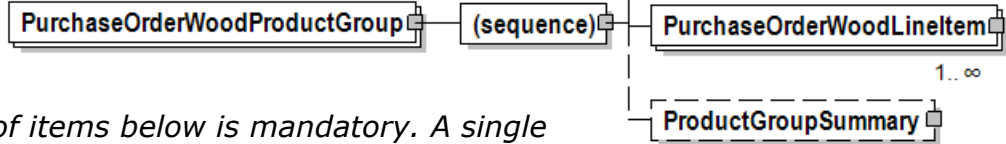

sequence of items below is mandatory. A single instance is required.

ProductGroupID

ProductGroupID is optional. A single instance might exist.

Possibility to group packages or Shipments. Example: Creating temporary group ID's for logistic reasons or lot number.

PurchaseOrderWoodLineItem

PurchaseOrderWoodLineItem is mandatory. One instance is required, multiple instances might exist.

PurchaseOrderWood Line Item

ProductGroupSummary

ProductGroupSummary is optional. A single instance might exist.

Group of elements to provide summary information on product level.

PurchaseOrderWoodSummary

Summary section of PurchaseOrderWood for wood vertical.

(sequence)

The sequence of items below is mandatory. A single instance is required.

TotalNumberOfLineItems

TotalNumberOfLineItems is optional. A single instance might exist.

The total number of individual line items in the document, regardless of the status or type.

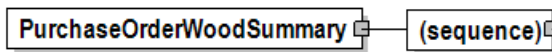

(sequence)

The sequence of items below is optional. Multiple instances might exist.

TotalQuantity

TotalQuantity is mandatory. A single instance is required.

The total quantity of similar items in the e-Document. TotalQuantity is primarily used in the summary section of documents where it is repeatable to permit totaling for different units of measure.

TotalInformationalQuantity

TotalInformationalQuantity is optional. Multiple instances might exist.

A quantity that is used to communicate related information about the parent element. This element represents a total that is derived from individual line items.

ProductSummary

ProductSummary is optional. A single instance might exist.

Group of elements to provide summary information on product level.

LengthSpecification

LengthSpecification is optional. Multiple instances might exist.

Length specification of the wood product.

QuantityDeviation

QuantityDeviation is optional. A single instance might exist.

To be deprecated in a future version V3R00. Use the Quantity element with a QuantityContext of "Deviation".

TotalTaxAmount

TotalTaxAmount is optional. A single instance might exist.

The CurrencyValue of TotalTaxAmount contains the sum of all instances of

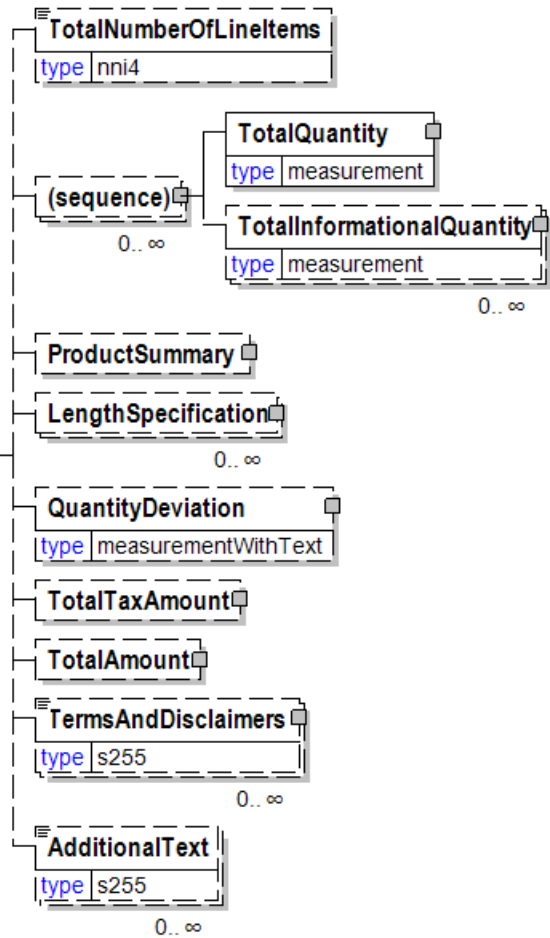

papiNet V2R31

TaxAdjustment in the document. TotalTaxAmount contains the sum of all instances of the MonetaryAdjustmentAmount for tax adjustments.

TotalAmount

TotalAmount is optional. A single instance might exist.

The total amount including tax (when tax is specified in the e-Document).

In e-Documents claiming payment this is the amount due for payment based on the terms of payment. Decimal rounding might be applied to this amount.

TermsAndDisclaimers

TermsAndDisclaimers is optional. Multiple instances might exist.

An element that contains legal information with an indication of what the Language is.

AdditionalText

AdditionalText is optional. Multiple instances might exist.

A text field that is used to communicate information not previously defined or for special instructions. To be used only for circumstances not covered by specific elements.

Quantity

The Quantity element contains attributes that provide information about the type of quantity that is being communicated, the context in which the particular quantity is to be viewed, and (if the quantity represents an adjustment) an adjustment type.

The Quantity element contains three child elements that enable you to communicate a range of values for the quantity and a target or actual value. It is at this level (Value, RangeMin, and RangeMax) that the unit of measure is specified. This permits the range to be specified in a different unit of measure than the target.

QuantityType [attribute]

QuantityType is mandatory. A single instance is required.

QuantityType communicates information about the type of quantity being communicated and how the receiver might use the information.

Refer to QuantityType definition for any enumerations.

QuantityTypeContext [attribute]

QuantityTypeContext is optional. A single instance might exist.

Provides the location in the value chain where the quantity is being reported.

Refer to QuantityTypeContext definition for any enumerations.

AdjustmentType [attribute]

AdjustmentType is optional. A single instance might exist.

Describes the type of adjustment associated with a quantity.

Refer to AdjustmentType definition for any enumerations.

MeasuringMethodType [attribute]

MeasuringMethodType is optional. A single instance might exist.

Specifies how a measurement value is created.

Refer to MeasuringMethodType definition for any enumerations.

MeasuringAgency [attribute]

MeasuringAgency is optional. A single instance might exist.

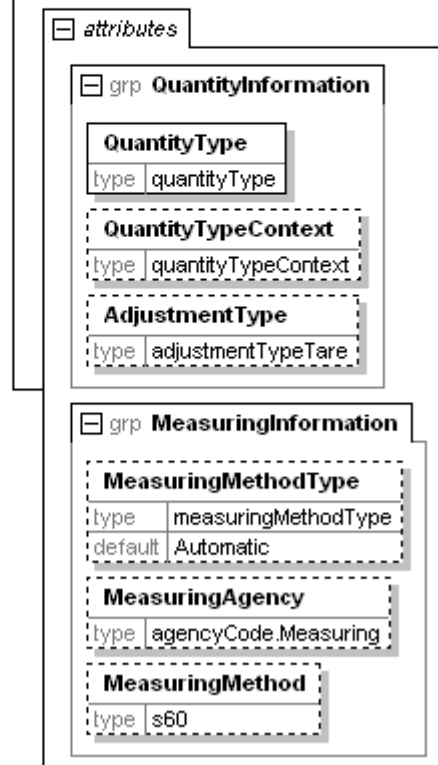
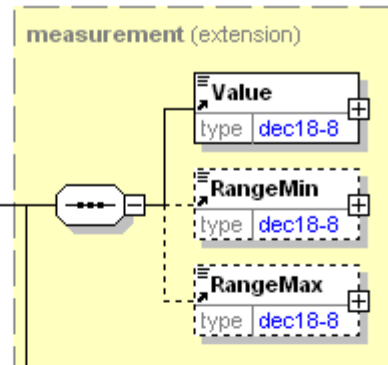
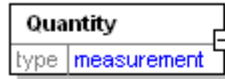

The agency defining measuring methods.

Refer to MeasuringAgency definition for any enumerations.

MeasuringMethod [attribute]

MeasuringMethod is optional. A single instance might exist.

The method used to determine how the item under consideration is measured. Measuring methods are defined by the measuring agency.

(sequence)

The sequence of items below is mandatory. A single instance is required.

Value

Value is mandatory. A single instance is required.

A numeric value expressed in the unit of measure (UOM).

RangeMin

RangeMin is optional. A single instance might exist.

The minimum value (lower boundary) allowed for the Measurement that is the parent of this element.

RangeMax

RangeMax is optional. A single instance might exist.

The maximum value (upper boundary) allowed for the Measurement that is the parent of this element. Some elements use the RangeMax element with an extended list of unit of measures. (Note: the red colour in the picture is an artifact of how the graphic was captured and should be disregarded.)

QuantityByProperty

A grouping element that contains specification of quantities per property value.

(sequence)

The sequence of items below is mandatory. A single instance is required.

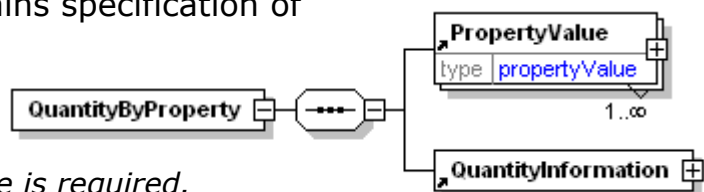

PropertyValue

PropertyValue is mandatory. Multiple instances might exist.

Specifies a value for a property of an item. The property is defined by the attribute PropertyType. The attribute MeasuringMethod and MeasuringAgency can be used to clarify details for a how a property is measured or calculated, e.g. Diameter for a saw log can be measured "Under Bark" or "Over Bark". The attribute MeasuringMethodType defines how the value is created, e.g. measured automatically, calculated etc. The attribute IsAverageValue indicates if the value is an average value or not.

PropertySubValue can specify a value for a property related to the property specified by the attribute PropertyType of PropertyValue. PropertyValueOfWhichMax and PropertyValueOfWhichMin can specify maximum and minimum values for properties that are part of the property specified by the attribute PropertyType of PropertyValue.

QuantityInformation

QuantityInformation is mandatory. A single instance is required.

A group item containing information about quantity and informational quantity of similar items.

QuantityDeviation

To be deprecated in a future version V3R00. Use the Quantity element with a QuantityContext of "Deviation".

(sequence)

The sequence of items below is mandatory. A single instance is required.

Value

Value is mandatory. A single instance is required.

A numeric value expressed in the unit of measure (UOM).

RangeMin

RangeMin is optional. A single instance might exist.

The minimum value (lower boundary) allowed for the Measurement that is the parent of this element.

RangeMax

RangeMax is optional. A single instance might exist.

The maximum value (upper boundary) allowed for the Measurement that is the parent of this element. Some elements use the RangeMax element with an extended list of unit of measures. (Note: the red colour in the picture is an artifact of how the graphic was captured and should be disregarded.)

AdditionalText

AdditionalText is optional. A single instance might exist.

A text field that is used to communicate information not previously defined or for special instructions. To be used only for circumstances not covered by specific elements.

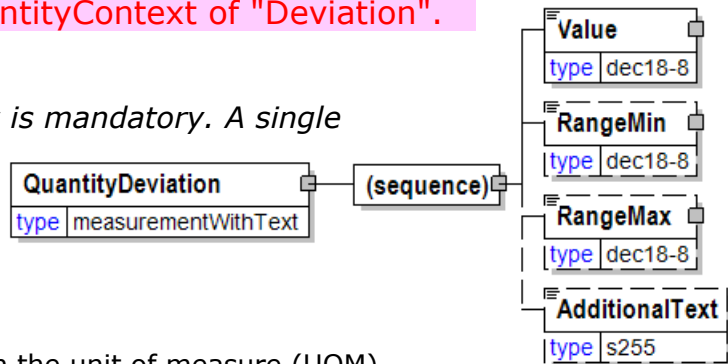

QuantityInformation

A group item containing information about quantity and informational quantity of similar items.

(sequence)

The sequence of items below is mandatory. A single instance is required.

Quantity

Quantity is mandatory. A single instance is required.

The Quantity element contains attributes that provide information about the type of quantity that is being communicated, the context in which the particular quantity is

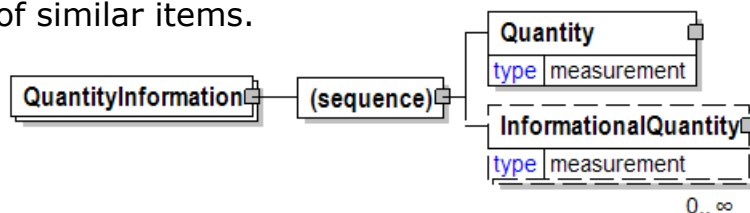

to be viewed, and (if the quantity represents an adjustment) an adjustment type.

The Quantity element contains three child elements that enable you to communicate a range of values for the quantity and a target or actual value. It is at this level (Value, RangeMin, and RangeMax) that the unit of measure is specified. This permits the range to be specified in a different unit of measure than the target.

InformationalQuantity

InformationalQuantity is optional. Multiple instances might exist.

A quantity given in a valid UOM used for information purposes only (not for calculation). For example, an ordered quantity was 100 reels as opposed to the invoice quantity of 20,000 pounds.

QuantityInUnit

Used to identify the number of items packed within this package unit.

(sequence)

The sequence of items below is mandatory. A single instance is required.

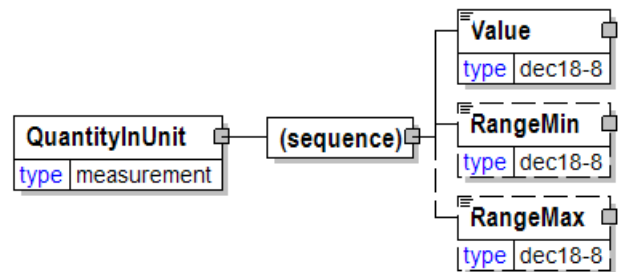

Value

Value is mandatory. A single instance is required.

A numeric value expressed in the unit of measure (UOM).

RangeMin

RangeMin is optional. A single instance might exist.

The minimum value (lower boundary) allowed for the Measurement that is the parent of this element.

RangeMax

RangeMax is optional. A single instance might exist.

The maximum value (upper boundary) allowed for the Measurement that is the parent of this element. Some elements use the RangeMax element with an extended list of unit of measures. (Note: the red colour in the picture is an artifact of how the graphic was captured and should be disregarded.)

QuantityOrderedInformation

Used to identify quantity. The construct provides via InformationalQuantity the ability to provide the Quantity in another UOM. Length is also provided to further specify the quantity.

(sequence)

The sequence of items below is mandatory. A single instance is required.

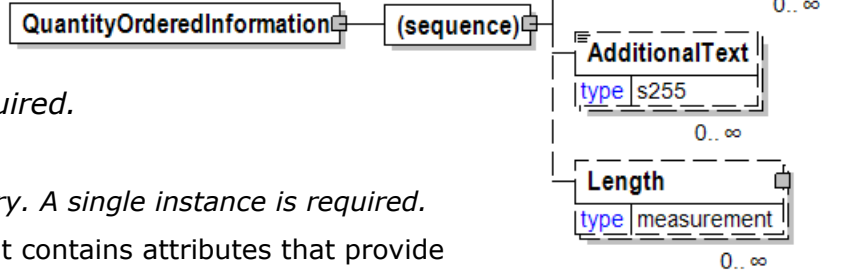

Quantity

Quantity is mandatory. A single instance is required.

The Quantity element contains attributes that provide information about the type of quantity that is being communicated, the context in which the particular quantity is to be viewed, and (if the quantity represents an adjustment) an adjustment type.

The Quantity element contains three child elements that enable you to communicate a range of values for the quantity and a target or actual value. It is at this level (Value, RangeMin, and RangeMax) that the unit of measure is specified. This permits the range to be specified in a different unit of measure than the target.

InformationalQuantity

InformationalQuantity is optional. Multiple instances might exist.

A quantity given in a valid UOM used for information purposes only (not for calculation). For example, an ordered quantity was 100 reels as opposed to the invoice quantity of 20,000 pounds.

AdditionalText

AdditionalText is optional. Multiple instances might exist.

A text field that is used to communicate information not previously defined or for special instructions. To be used only for circumstances not covered by specific elements.

Length

Length is optional. Multiple instances might exist.

The length of the object.

QuantitySpecification

A grouping element that contains a specification of quantities that should be measured or are measured.

QuantityType [attribute]

QuantityType is mandatory. A single instance is required.

QuantityType communicates information about the type of quantity being communicated and how the receiver might use the information.

Refer to QuantityType definition for any enumerations.

QuantitySpecification

QuantityTypeContext [attribute]

QuantityTypeContext is optional. A single instance might exist.

Provides the location in the value chain where the quantity is being reported.

Refer to QuantityTypeContext definition for any enumerations.

AdjustmentType [attribute]

AdjustmentType is optional. A single instance might exist.

Describes the type of adjustment associated with a quantity.

Refer to AdjustmentType definition for any enumerations.

MeasuringMethodType [attribute]

MeasuringMethodType is optional. A single instance might exist.

Specifies how a measurement value is created.

Refer to MeasuringMethodType definition for any enumerations.

MeasuringAgency [attribute]

MeasuringAgency is optional. A single instance might exist.

The agency defining measuring methods.

Refer to MeasuringAgency definition for any enumerations.

MeasuringMethod [attribute]

MeasuringMethod is optional. A single instance might exist.

The method used to determine how the item under consideration is measured. Measuring methods are defined by the measuring agency.

UOM [attribute]

UOM is optional. A single instance might exist.

Defines the unit of measure for the value.

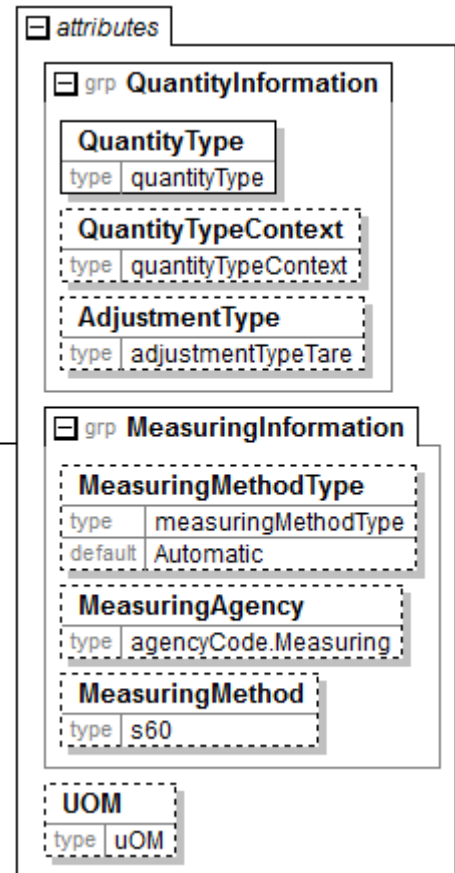

Refer to UOM definition for any enumerations.

QuantityType [attribute]

QuantityType communicates information about the type of quantity being communicated and how the receiver might use the information.

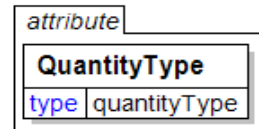

This item is restricted to the following list.

ActualVolume

Actual product space.

AirDryWeight

Contains a normal amount of moisture.

Area

A number that represents the length multiplied by the width is being communicated.

BoneDry

Contains insignificant moisture.

Count

The number of items.

Distance

The quantity being communicated is a distance.

GrossWeight

The weight including all packaging and furnishing. The gross weight of the deliveries includes tare weight.

Energy

The quantity represents energy content.

Length

The length of the object.

LogisticsGrossWeight

The weight of the vehicle including transport units before unloading goods at a delivery destination.

LogisticsNetWeight

The weight of the vehicle including transport units after unloading goods delivered to a delivery destination. The transport units can be empty or can contain goods when co-loading is used to subsequent delivery destinations.

LogPileGrossVolume

To be deprecated in a future version V3R00. Should not be used in new implementations.

LogPileVolume

The volume of a pile of logs, including gaps. The product specification defines

papiNet V2R31

what is included in this volume, for example if rejects or other deductions are included or not.

NetWeight

The net weight of the product is being used, does not include tare weights. May include certain conversion components.

NetNetWeight

The net weight of the product without any packaging or conversion materials. Note: In Forest Wood Supply business the product specification defines what is included in this net weight, for example if rejects or other deductions are included or not.

NominalWeight

A calculated weight that is derived from another measurement. For example, the length of paper multiplied by the specified basis weight could be used to derive a nominal weight.

Percent

The number being communicated is a percentage.

RunningLength

The length of the reel.

ShortLengthVolume

SolidWoodGrossVolume

To be deprecated in a future version V3R00. Should not be used in new implementations.

SolidWoodVolume

The volume of logs, stems, chips, etc. without bark and gaps. The product specification defines what is included in this volume, for example if rejects or other deductions are included or not.

TareWeight

The weight of the previously agreed to packaging and furnishing.

Time

The number being communicated represents an amount of time.

TippedLooseGrossVolume

To be deprecated in a future version V3R00. Should not be used in new implementations.

TippedLooseVolume

The volume of tipped loose content, including gaps. Often used as a quantity type for piles of chips, sawdust, etc. The product specification defines what is included in this volume, for example if rejects or other deductions are included or not.

Volume

WoodGrossVolume

To be deprecated in a future version V3R00. Should not be used in new

implementations.

WoodVolume

The volume of logs, stems, chips, etc. without gaps but including bark. The product specification defines what is included in this volume, for example if rejects or other deductions are included or not.

QuantityTypeContext [attribute]

Provides the location in the value chain where the quantity is being reported.

This item is restricted to the following list.

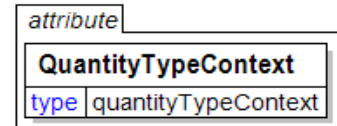

AgreedToClaimValue

A quantity that has been agreed to as a result of a claim.

Allocated

A quantity put aside, in general terms for a particular customer, process, or use. (Compare to "Reserved".)

AllowableSpoilage

Specifies the manufacturing spoilage quantity that the publisher, or other involved party, will allow.

Balance

A remaining quantity.

CalledOff

A quantity put aside to be sent to the customer on a call off.

Consumed

Consumed in manufacturing

Contracted

A quantity that has been agreed, e.g. in a contract.

Credited

A quantity for which a credit has been issued.

CutOff

A quantity that has been cut off.

Damaged

A quantity that has been damaged.

Delivered

Delivered to the ship-to location.

Destroyed

The product, for secure reasons, has been made unusable both for content and the actual product.

Deviation

Used to identify the deviation quantity accepted for this product.

Quantity deviation is partly an ancient/traditional thing in timber trade and refers more to sea transport than others. Quantity deviation can concern both line level quantities and total quantities. Total quantity deviation is meant to really restrict volumes to exceed ship's capacity.

Example Quantity deviations used for total quantities are:

CA./Max: for example, CA./max 1000 M3 = maximum quantity 1000 m3, but can be -10 % less (so 900 - 1000 m3 in this case)

Min but Max: for example, min 45 max 50 m3 = volume to be between 45 and 50

Min/Max: for example, min/max 500 m3 = have to be roughly accurate 500 m3

CA: for example, CA 500 m3 = +-10 % (450 - 550 m3)

In some contracts, at the line level, it is said that product level variation can be +- 10% (at the same time we can have deviation for total quantity)

For example: You can have +-10 % volumes in line levels but total quantity must meet the following requirement - Min/Max 1000 m3.

Forecasted

A quantity that is predicted during follow-up of an existing plan. Not to be used for quantities that are derived from a planning process, please see Planned.

Freight

The quantity to be used for freight costing.

Handled

The quantity moved, e.g. in a warehouse, or otherwise handled in a logistics or material handling capacity.

Imposed

Quantity of pages after arrangement of the printed product's pages on the printer's sheet.

Intransit

A quantity that is undergoing the transportation process and is (usually) not available for immediate use.

Invoiced

A quantity that is qualified for compensation.

Loaded

A quantity that is loaded on a transport vehicle but has not left. That is, not in-transit yet.

Measured

A quantity that has been measured by a Measuring Party.

MeasuredCorrected

papiNet V2R31

A measured quantity that has been corrected based on measuring statistics for populations of products.

NotBillable

A quantity that is not qualified for compensation.

OnHand

In available inventory at the storage location.

Ordered

A PurchaseOrder has been placed for the product.

Packed

A quantity that is prepared for storage or, transport or, some other state from which it has to be unpacked (work applied) in order to use it.

Planned

A quantity that is derived from a planning process. Not to be used for quantities predicted during follow-up of an existing plan, please see Forecasted.

Produced

The quantity added to stock through a manufacturing or conversion process.

Rejected

A quantity that has been rejected.

Released

The quantity that has been authorized to be moved on to the next stage or phase in the manufacturing process or supply chain.

Reorder

A quantity that has been ordered.

ReorderPoint

A quantity on hand below which triggers a re-order.

Reserved

A quantity assigned to a specific customer order, job order, or delivery order. (Compare to "Allocated".)

Scrapped

Scrapped specifies that a product has been removed from inventory at the location where warehoused and has not been shipped to the owner.

Stored

The quantity refers to goods which have been stored in a warehouse, terminal etc.

Tested

A quantity that is analysed, e.g. the quantity of a random sample taken for measuring of product properties.

Transported

The quantity that is transported in logistics business.

Trimmed

A quantity that has been scheduled for production on a winder or a sheeter as part of the manufacturing process.

Unloaded

A quantity removed from a transport vehicle.

UnspecifiedDamage

Damage is being communicated in the element. In order to understand the type of damage the AdjustmentType will need to be considered.

ValueClaimed

A quantity that relates to the value claimed.

VendorSupplied

A quantity that is vendor supplied.

Wound

A quantity that has been placed in a reel form or otherwise put on a core.

Wrapped

A quantity that has been protectively covered in preparation for storage or shipment.

QuantityValue

The QuantityValue element contains attributes that provide information about the type of quantity that is being communicated, the context in which the particular quantity is to be viewed, and (if the quantity represents an adjustment) an adjustment type.

The QuantityValue element contains three child elements that enable you to communicate a range of values for the quantity and a target or actual value. It is at this level (Value, RangeMin, and RangeMax) that the unit of measure is specified. This permits the range to be specified in a different unit of measure than the target.

QuantityType [attribute]

QuantityType is mandatory. A single instance is required.

QuantityType communicates information about the type of quantity being communicated and how the receiver might use the information.

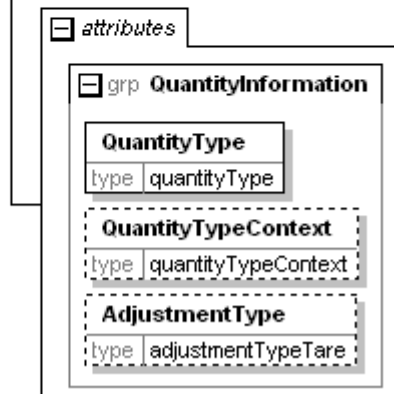
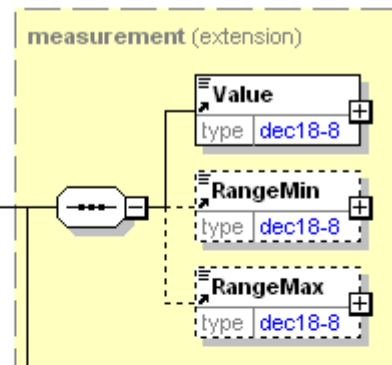

papiNet V2R31

Refer to QuantityType definition for any enumerations.

QuantityTypeContext [attribute]

QuantityTypeContext is optional. A single instance might exist.

Provides the location in the value chain where the quantity is being reported.

Refer to QuantityTypeContext definition for any enumerations.

AdjustmentType [attribute]

AdjustmentType is optional. A single instance might exist.

Describes the type of adjustment associated with a quantity.

Refer to AdjustmentType definition for any enumerations.

(sequence)

The sequence of items below is mandatory. A single instance is required.

Value

Value is mandatory. A single instance is required.

A numeric value expressed in the unit of measure (UOM).

RangeMin

RangeMin is optional. A single instance might exist.

The minimum value (lower boundary) allowed for the Measurement that is the parent of this element.

RangeMax

RangeMax is optional. A single instance might exist.

The maximum value (upper boundary) allowed for the Measurement that is the parent of this element. Some elements use the RangeMax element with an extended list of unit of measures. (Note: the red colour in the picture is an artifact of how the graphic was captured and should be disregarded.)

QuoteInCurrency

Indicates that the quote is to be provided in the currency specified.

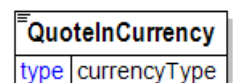

A three-character ISO 4217 currency code in capital letters. The ISO standard classification for currencies.

Refer to the ISO standard for information about the choices for the enumerations.

<https://www.iso.org/iso-4217-currency-codes.html>

RangeMax

The maximum value (upper boundary) allowed for the Measurement that is the parent of this element.

Some elements use the RangeMax element with an extended list of unit of measures. (Note: the red colour in the picture is an artifact of how the graphic was captured and should be disregarded.)

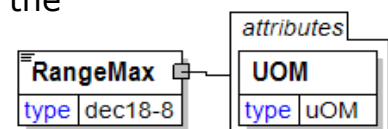

UOM [attribute]

UOM is mandatory. A single instance is required.

Defines the unit of measure for the value.

Refer to UOM definition for any enumerations.

RangeMin

The minimum value (lower boundary) allowed for the Measurement that is the parent of this element.

UOM [attribute]

UOM is mandatory. A single instance is required.

Defines the unit of measure for the value.

Refer to UOM definition for any enumerations.

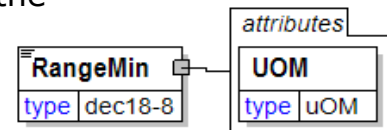

RawMaterialSet

This identifier derived element indicates a grouping of raw materials that were used to manufacture the product.

IdentifierCodeType [attribute]

IdentifierCodeType is mandatory. A single instance is required.

Defines the type of product identifier used (for example, reel number, ream number, bar code). This code type specifies how to decode the identifier value.

Refer to IdentifierCodeType definition for any enumerations.

IdentifierType [attribute]

IdentifierType is mandatory. A single instance is required.

This attribute specifies whether the Identifier is the primary way to identify the product or a secondary way. Only one of the given identifiers can be primary. In addition, this attribute also specifies the physical support used to code the identifier (for example, a Radio Frequency (RF) Tag).

Refer to IdentifierType definition for any enumerations.

IdentifierFormatType [attribute]

IdentifierFormatType is optional. A single instance might exist.

IdentifierFormatType defines the technical format used to make an IdentifierCodeType readable by technical devices or humans. The IdentifierCodeType specifies how to decode the identifier value

Refer to IdentifierFormatType definition for any enumerations.

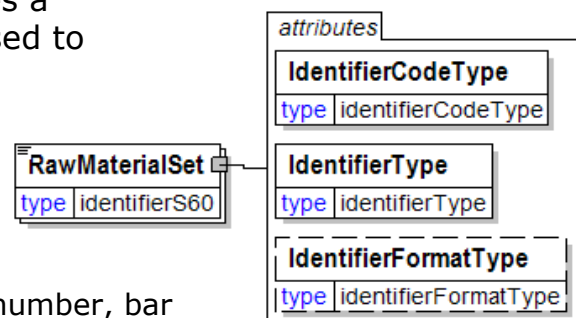

ReamItem

A wrapped quantity of SheetItem(s).

(sequence)

The sequence of items below is mandatory. A single instance is required.

Identifier

Identifier is optional. Multiple instances might exist.

An Identifier is required for packages and items (pallets, reel packages, boxes, ream items, reel items, etc). The Identifier element contains the actual item identifier code. Identifier is repeatable so more than one identifier can be communicated. For example, the printed identifier on a label may be different from the barcode printed on the label.

ItemCount

ItemCount is mandatory. A single instance is required.

A count of the number of items (examples: a count of the number of boxes on a pallet or of reams in a box).

Quantity

Quantity is optional. A single instance might exist.

The Quantity element contains attributes that provide information about the type of quantity that is being communicated, the context in which the particular quantity is to be viewed, and (if the quantity represents an adjustment) an adjustment type.

The Quantity element contains three child elements that enable you to communicate a range of values for the quantity and a target or actual value. It is at this level (Value, RangeMin, and RangeMax) that the unit of measure is specified. This permits the range to be specified in a different unit of measure than the target.

InformationalQuantity

InformationalQuantity is optional. Multiple instances might exist.

A quantity given in a valid UOM used for information purposes only (not for calculation). For example, an ordered quantity was 100 reels as opposed to the invoice quantity of 20,000 pounds.

SheetItem

SheetItem is optional. A single instance might exist.

A group item consisting potentially of the date the sheets were converted into sheets and/or packaged or finished.

SafetyAndEnvironmentalInformation

SafetyAndEnvironmentalInformation is optional. Multiple instances might exist.

Name of certification type, if any, on the goods (For example, FSC, PEFC). SafetyAndEnvironmental needs a value or measurement to communicate the

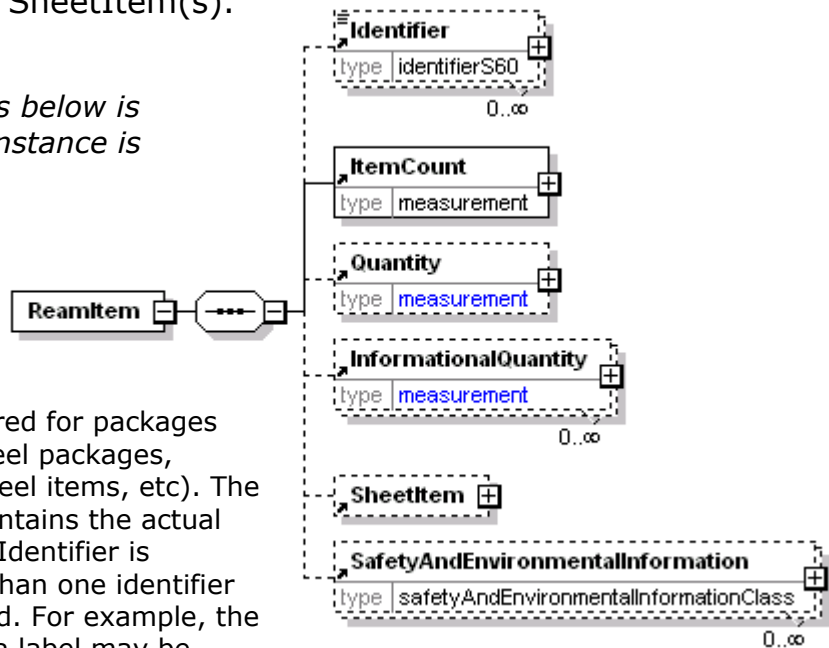

percentage of the product is certified (for example, 75% is certified by the indicated agency).

ReamType

The textual description of the method used to make up the reams.

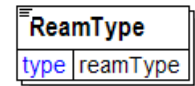

This item is restricted to the following list.

Any

Any ream type is acceptable

BoxedWithInnerReam

Boxed with inner ream

BoxedWithoutInnerReam

Boxed without inner ream

BulkPackedNonTabbed

Sheets are packed without ream wrapping and without sheet count markers.

BulkPackedTabbed

Sheets are packed without ream wrapping, but with sheet count markers at predefined intervals.

ReamWrapped

Sheets are packed ream wrapped

ReamWeight

The target weight of a ream of paper.

(sequence)

The sequence of items below is mandatory. A single instance is required.

Value

Value is mandatory. A single instance is required.

A numeric value expressed in the unit of measure (UOM).

RangeMin

RangeMin is optional. A single instance might exist.

The minimum value (lower boundary) allowed for the Measurement that is the parent of this element.

RangeMax

RangeMax is optional. A single instance might exist.

The maximum value (upper boundary) allowed for the Measurement that is the parent of this element. Some elements use the RangeMax element with an extended list of unit of measures. (Note: the red colour in the picture is an artifact of how the graphic was captured and should be disregarded.)

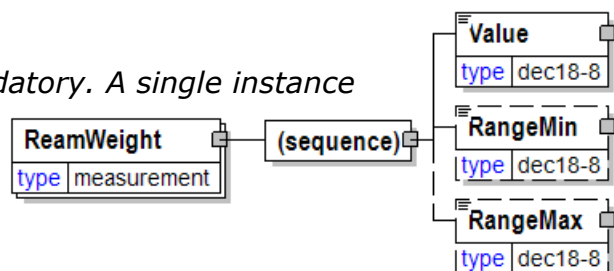

RearCouplingType [attribute]

Specifies the rear coupling device that attaches a vehicle or a transport unit to the transport unit. For example attaches a truck to a trailer or a trailer to another trailer.

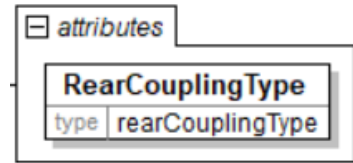

This item is restricted to the following list.

FifthWheelPlate

A heavy metal disc with a "V" shaped slot attached horizontally to the chassis. The "V" slot contains a locking device. The "V" slot is the mechanism that locks it to a coupling of type FifthWheelKingPin.

None

No coupling device present.

TowBar

A coupling device that is attached to the rear end of the chassis for towing, It may have the form of a tow ball to allow swivelling and articulation of a trailer.

ReasonCode [attribute]

Free-form text providing the Reason Code for the item. An Agency attribute may exist at the same level as this attribute to provide an indication of the nature of the text.

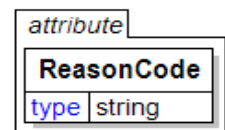

ReasonDescription

Text associated with a particular ReasonIdentifier

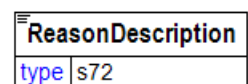

ReceiverParty

The business entity for whom the e-Document is intended, the destination of the document.

The entity interested in the content. If the receiver party has outsourced the message service to a third party the ReceiverParty is the intended party for the e-Document and not the party performing the receiving service of the electronic message.

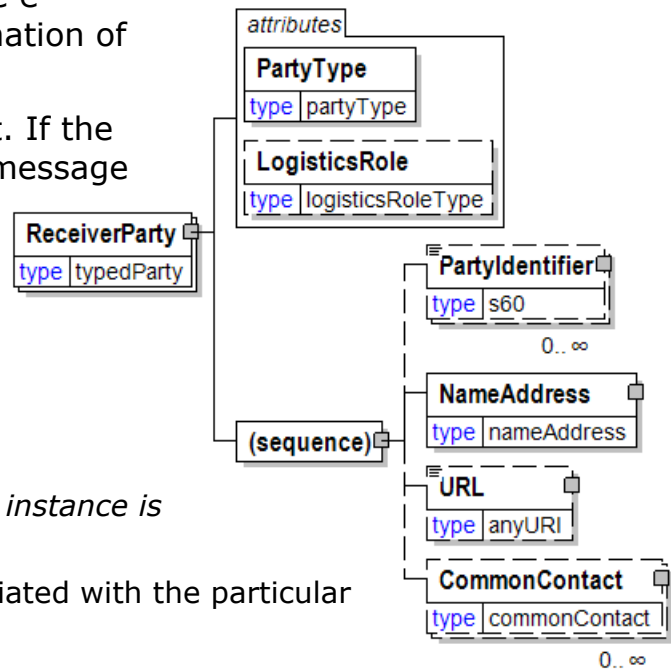

PartyType [attribute]

PartyType is mandatory. A single instance is required.

Identifies the business role associated with the particular party

Refer to PartyType definition for any enumerations.

LogisticsRole [attribute]

LogisticsRole is optional. A single instance might exist.

Communicates the nature of the logistics role, if any, the party plays in the transaction.

Refer to LogisticsRole definition for any enumerations.

(sequence)

The sequence of items below is mandatory. A single instance is required.

PartyIdentifier

PartyIdentifier is optional. Multiple instances might exist.

A unique identifier of a specific party. This element contains an attribute PartyIdentifierType that indicates the type of the identifier.

NameAddress

NameAddress is mandatory. A single instance is required.

A group item containing name and address of an organisation or business entity.

URL

URL is optional. A single instance might exist.

Universal Resource Locator. While typically a web address you could use this field to hold an email address.

CommonContact

CommonContact is optional. Multiple instances might exist.

Identifies a specific individual associated with the party.

RecoveredPaper

A group item defining the characteristics of recycled fibre that are not dependent on a particular conversion process.

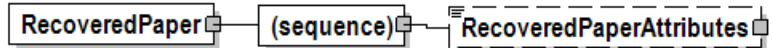

(sequence)

The sequence of items below is mandatory. A single instance is required.

RecoveredPaperAttributes

RecoveredPaperAttributes is optional. A single instance might exist.

The attributes of Recovered Paper.

RecoveredPaperAttributes

The attributes of Recovered Paper.

(sequence)

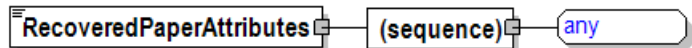

The sequence of items below is mandatory. A single instance is required.

[Any Type]

Any type of content is permitted at this point.

Recycled

A group item used to communicate the target or test value total percentage of waste fibre in the product according to a particular TestMethod.

TestMethod [attribute]

TestMethod is optional. A single instance might exist.

The method used to determine the results of the test under consideration.

TestAgency [attribute]

TestAgency is optional. A single instance might exist.

The agency that has set the parameters for the testing

Refer to TestAgency definition for any enumerations.

SampleType [attribute]

SampleType is optional. A single instance might exist.

Communicates how sampling was done to measure the product characteristics.

Refer to SampleType definition for any enumerations.

ResultSource [attribute]

ResultSource is optional. A single instance might exist.

Used to define the data source of the specified test

Refer to ResultSource definition for any enumerations.

(sequence)

The sequence of items below is mandatory. A single instance is required.

DetailValue

DetailValue is mandatory. A single instance is required.

A numeric value expressed in the unit of measure (UOM).

DetailRangeMin

DetailRangeMin is optional. A single instance might exist.

The minimum value (lower boundary) allowed for the DetailValue that is the parent of this element.

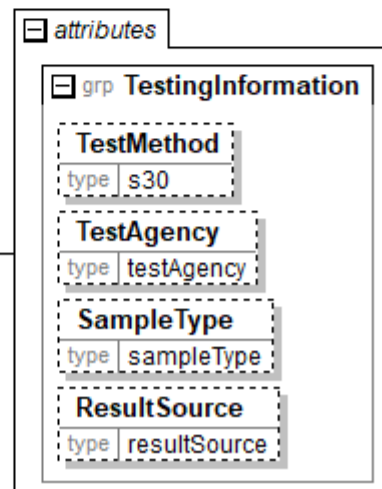
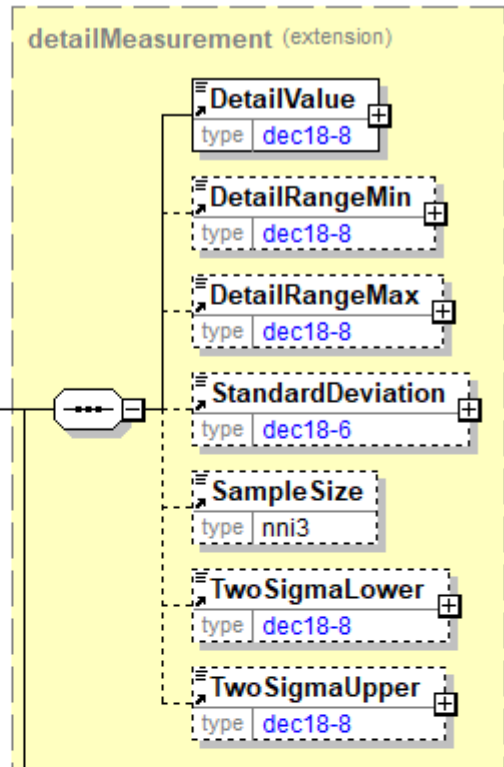

DetailRangeMax

DetailRangeMax is optional. A single instance might exist.

The maximum value (upper boundary) allowed for the DetailValue that is the parent of this element.

StandardDeviation

StandardDeviation is optional. A single instance might exist.

A statistic used as a measure of dispersion in a distribution.

SampleSize

SampleSize is optional. A single instance might exist.

The number of samples used to determine the product characteristic in question.

TwoSigmaLower

TwoSigmaLower is optional. A single instance might exist.

Two sigma (a measure of dispersion associated with standard deviation) on the lower side of the standard deviation.

TwoSigmaUpper

TwoSigmaUpper is optional. A single instance might exist.

Two sigma (a measure of dispersion associated with standard deviation) on the upper side of the standard deviation.

RecycledCharacteristics

RecycledCharacteristics groups together the concepts associated with recycled material.

RecycledRequired [attribute]

RecycledRequired is optional. A single instance might exist.

Indicates if Recycled Material is required

Refer to RecycledRequired definition for any enumerations.

(sequence)

The sequence of items below is mandatory. A single instance is required.

Recycled

Recycled is optional. A single instance might exist.

A group item used to communicate the target or test value total percentage of waste fibre in the product according to a particular TestMethod.

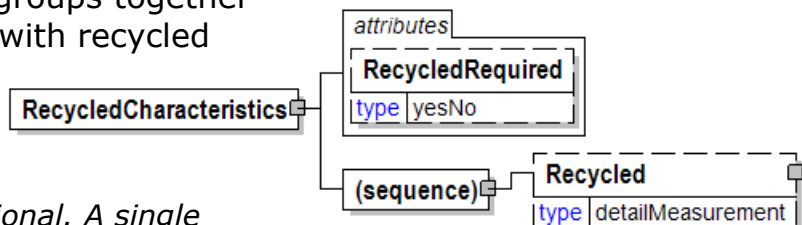

RecycledRequired [attribute]

Indicates if Recycled Material is required

This item is restricted to the following list.

Yes

No

attribute	
RecycledRequired	
type	yesNo

Red

The "Red" portion of the method of representing colour termed RGB.

(sequence)

The sequence of items below is mandatory. A single instance is required.

DetailValue

DetailValue is mandatory. A single instance is required.

A numeric value expressed in the unit of measure (UOM).

Red
type detailMeasurement

(sequence)

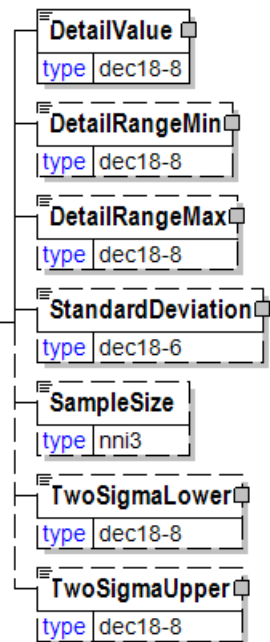

DetailRangeMin

DetailRangeMin is optional. A single instance might exist.

The minimum value (lower boundary) allowed for the DetailValue that is the parent of this element.

DetailRangeMax

DetailRangeMax is optional. A single instance might exist.

The maximum value (upper boundary) allowed for the DetailValue that is the parent of this element.

StandardDeviation

StandardDeviation is optional. A single instance might exist.

A statistic used as a measure of dispersion in a distribution.

SampleSize

SampleSize is optional. A single instance might exist.

The number of samples used to determine the product characteristic in question.

TwoSigmaLower

TwoSigmaLower is optional. A single instance might exist.

Two sigma (a measure of dispersion associated with standard deviation) on the lower side of the standard deviation.

TwoSigmaUpper

TwoSigmaUpper is optional. A single instance might exist.

Two sigma (a measure of dispersion associated with standard deviation) on the upper side of the standard deviation.

Reel

A group item that contains the conversion and packaging characteristics of a reel.

(sequence)

The sequence of items below is mandatory. A single instance is required.

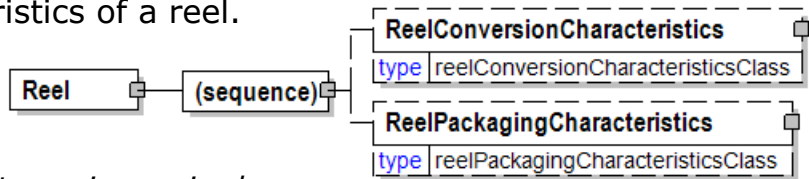

ReelConversionCharacteristics

ReelConversionCharacteristics is optional. A single instance might exist.

A group item that lists the conversion elements describing how a reel is converted from a tambour.

ReelPackagingCharacteristics

ReelPackagingCharacteristics is optional. A single instance might exist.

A group item that lists the packaging elements describing how a reel should be packed.

ReelArm

The reel arm number.

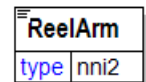

ReelBreakDiameter

The diameter of a reel at which the web break occurred. This is measured from the core to outside diameter.

(sequence)

The sequence of items below is mandatory. A single instance is required.

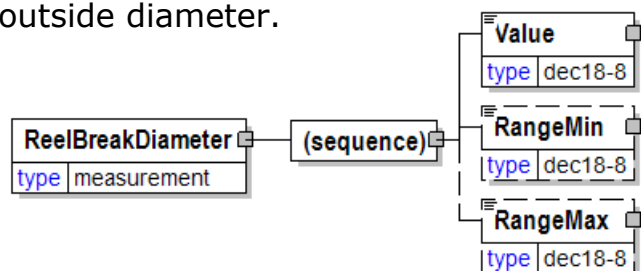

Value

Value is mandatory. A single instance is required.

A numeric value expressed in the unit of measure (UOM).

RangeMin

RangeMin is optional. A single instance might exist.

The minimum value (lower boundary) allowed for the Measurement that is the parent of this element.

RangeMax

RangeMax is optional. A single instance might exist.

The maximum value (upper boundary) allowed for the Measurement that is the parent of this element. Some elements use the RangeMax element with an extended list of unit of measures. (Note: the red colour in the picture is an artifact of how the graphic was captured and should be disregarded.)

ReelConversionCharacteristics

A group item that lists the conversion elements describing how a reel is converted from a tambour.

(sequence)

The sequence of items below is mandatory. A single instance is required.

ConversionCode

ConversionCode is optional. A single instance might exist.

A code, as assigned by an Agency, used to identify a group of conversion characteristics.

WindingDirection

WindingDirection is optional. A single instance might exist.

An element that indicates how the material is wound on the reel.

Refer to

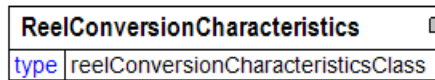

WindingDirection definition for any enumerations.

MakeTo

MakeTo is optional. A single instance might exist.

Indicates upon which constraint production should be based on (length or diameter). Specifies the basis of the finished diameter of a reel, either a Diameter specification or a Length of paper specification

Refer to MakeTo definition for any enumerations.

ReelWidth

ReelWidth is optional. Multiple instances might exist.

The width of reel from edge to edge excluding packaging.

ReelDiameter

ReelDiameter is optional. Multiple instances might exist.

The diameter measurement of reel excluding packaging.

ReelLength

ReelLength is optional. Multiple instances might exist.

The total length of the paper on the reel.

TargetProductWeight

TargetProductWeight is optional. A single instance might exist.

The desired weight of the finished product.

CoreCharacteristics

CoreCharacteristics is optional. Multiple instances might exist.

A group item that details information used to fully define a core.

Embossing

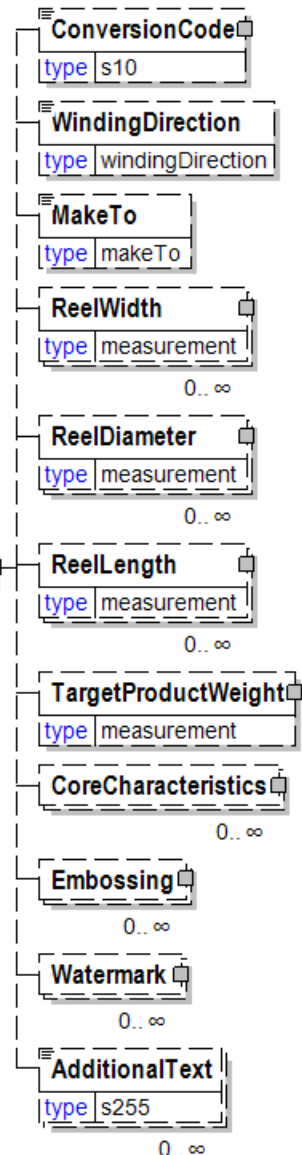

Embossing is optional. Multiple instances might exist.

Embossing requirements for sheets and reels. Embossing involves a physical deformation of the paper surface as part of the conversion process. Embossing is applied either in-line (directly after the paper machine) or off-line. Refer to the attribute FinishType for additional information.

Watermark

Watermark is optional. Multiple instances might exist.

Watermark information

AdditionalText

AdditionalText is optional. Multiple instances might exist.

A text field that is used to communicate information not previously defined or for special instructions. To be used only for circumstances not covered by specific elements.

ReelDiameter

The diameter measurement of reel excluding packaging.

(sequence)

The sequence of items below is mandatory. A single instance is required.

Value

Value is mandatory. A single instance is required.

A numeric value expressed in the unit of measure (UOM).

RangeMin

RangeMin is optional. A single instance might exist.

The minimum value (lower boundary) allowed for the Measurement that is the parent of this element.

RangeMax

RangeMax is optional. A single instance might exist.

The maximum value (upper boundary) allowed for the Measurement that is the parent of this element. Some elements use the RangeMax element with an extended list of unit of measures. (Note: the red colour in the picture is an artifact of how the graphic was captured and should be disregarded.)

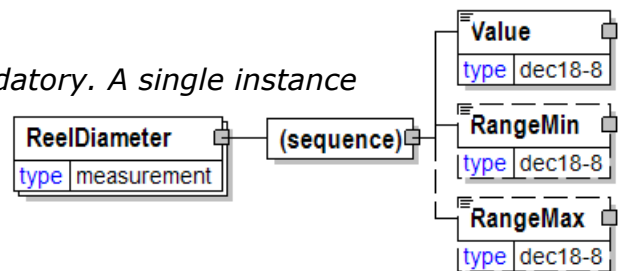

ReelItem

A group item representing details of an actual (as opposed to specified) reel. One or several reels can be contained in a package.

(sequence)

The sequence of items below is mandatory. A single instance is required.

Identifier

Identifier is mandatory. One instance is required, multiple instances might exist.

An Identifier is required for packages and items (pallets, reel packages, boxes, ream items, reel items, etc). The Identifier element contains the actual item identifier code. Identifier is repeatable so more than one identifier can be communicated. For example, the printed identifier on a label may be different from the barcode printed on the label.

(sequence)

The sequence of items below is optional. A single instance might exist.

PartyIdentifier

PartyIdentifier is mandatory. One instance is required, multiple instances might exist.

A unique identifier of a specific party. This element contains an attribute PartyIdentifierType that indicates the type of the identifier.

MachineID

MachineID is optional. A single instance might exist.

An identifier assigned to the particular machine being referenced. For example, a machine could be a paper machine, an off-line coater, a sheeter, or a printing press. The particular machine being referenced will be determined by the business event being supported.

DeliveryMessageReelCharacteristics

DeliveryMessageReelCharacteristics is optional. A single instance might exist.

A group item for actual measurement and manufacturing characteristics. DeliveryMessageReelCharacteristics is intended to indicate the actual measurements that apply to a reel.

InventoryClass

InventoryClass is optional. A single instance might exist.

A group item containing information about status of inventory and goods items.

MillOrderNumber

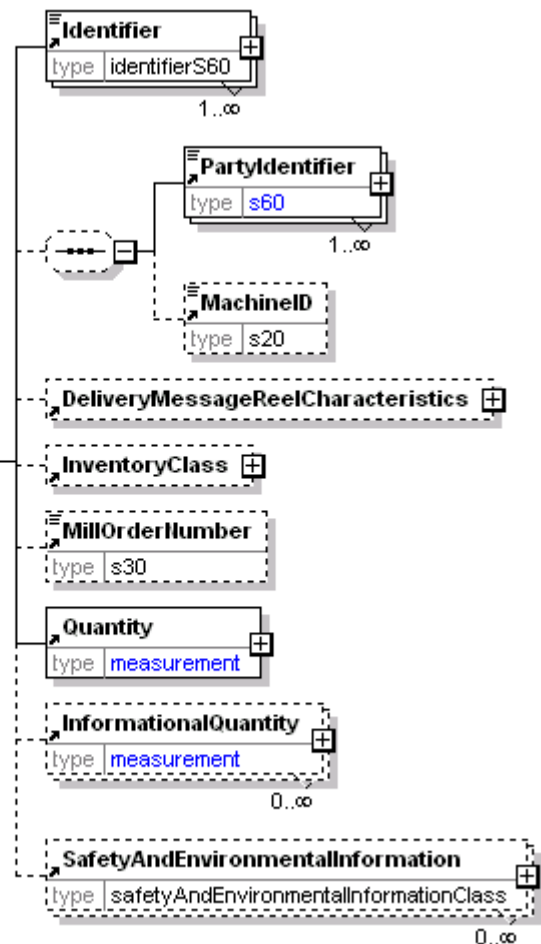

papiNet V2R31

MillOrderNumber is optional. A single instance might exist.

The manufacturing order number the mill uses.

Quantity

Quantity is mandatory. A single instance is required.

The Quantity element contains attributes that provide information about the type of quantity that is being communicated, the context in which the particular quantity is to be viewed, and (if the quantity represents an adjustment) an adjustment type.

The Quantity element contains three child elements that enable you to communicate a range of values for the quantity and a target or actual value. It is at this level (Value, RangeMin, and RangeMax) that the unit of measure is specified. This permits the range to be specified in a different unit of measure than the target.

InformationalQuantity

InformationalQuantity is optional. Multiple instances might exist.

A quantity given in a valid UOM used for information purposes only (not for calculation). For example, an ordered quantity was 100 reels as opposed to the invoice quantity of 20,000 pounds.

SafetyAndEnvironmentalInformation

SafetyAndEnvironmentalInformation is optional. Multiple instances might exist.

Name of certification type, if any, on the goods (For example, FSC, PEFC). SafetyAndEnvironmental needs a value or measurement to communicate the percentage of the product is certified (for example, 75% is certified by the indicated agency).

ReelLength

The total length of the paper on the reel.

(sequence)

The sequence of items below is mandatory. A single instance is required.

Value

Value is mandatory. A single instance is required.

A numeric value expressed in the unit of measure (UOM).

RangeMin

RangeMin is optional. A single instance might exist.

The minimum value (lower boundary) allowed for the Measurement that is the parent of this element.

RangeMax

RangeMax is optional. A single instance might exist.

The maximum value (upper boundary) allowed for the Measurement that is the parent of this element. Some elements use the RangeMax element with an extended list of unit of measures. (Note: the red colour in the picture is an artifact of how the graphic was captured and should be disregarded.)

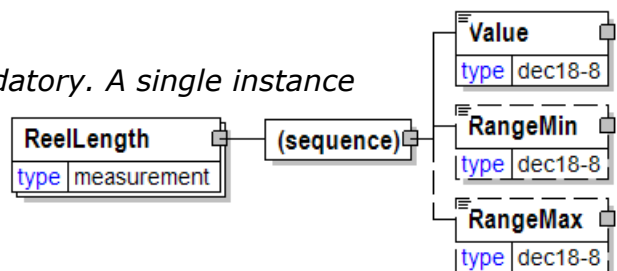

ReelPackagingCharacteristics

A group item that lists the packaging elements describing how a reel should be packed.

ActionType [attribute]

ActionType is optional. A single instance might exist.

Used to trigger an action concerning the element to which it refers.

Refer to ActionType definition for any

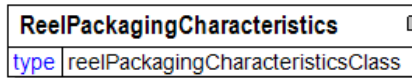

enumerations.

(sequence)

The sequence of items below is mandatory. A single instance is required.

PackagingCode

PackagingCode is optional. A single instance might exist.

PackagingCode is a code describing the packaging of the product.

PackagingDescription

PackagingDescription is optional. A single instance might exist.

A text field element describing the packaging of a product.

ReelsPerPack

ReelsPerPack is optional. A single instance might exist.

The number of reels within a package.

Wrap

Wrap is optional. Multiple instances might exist.

A group item that organises wrapping detail information.

EndCaps

EndCaps is optional. Multiple instances might exist.

A cover to protect the ends of the reel, usually circle shaped and made from Kraft paper or plywood.

CorePlugs

CorePlugs is optional. Multiple instances might exist.

An element that indicates if plugs are to be inserted into the ends of the core. Core plugs can be made of various materials and are used to protect the core ends.

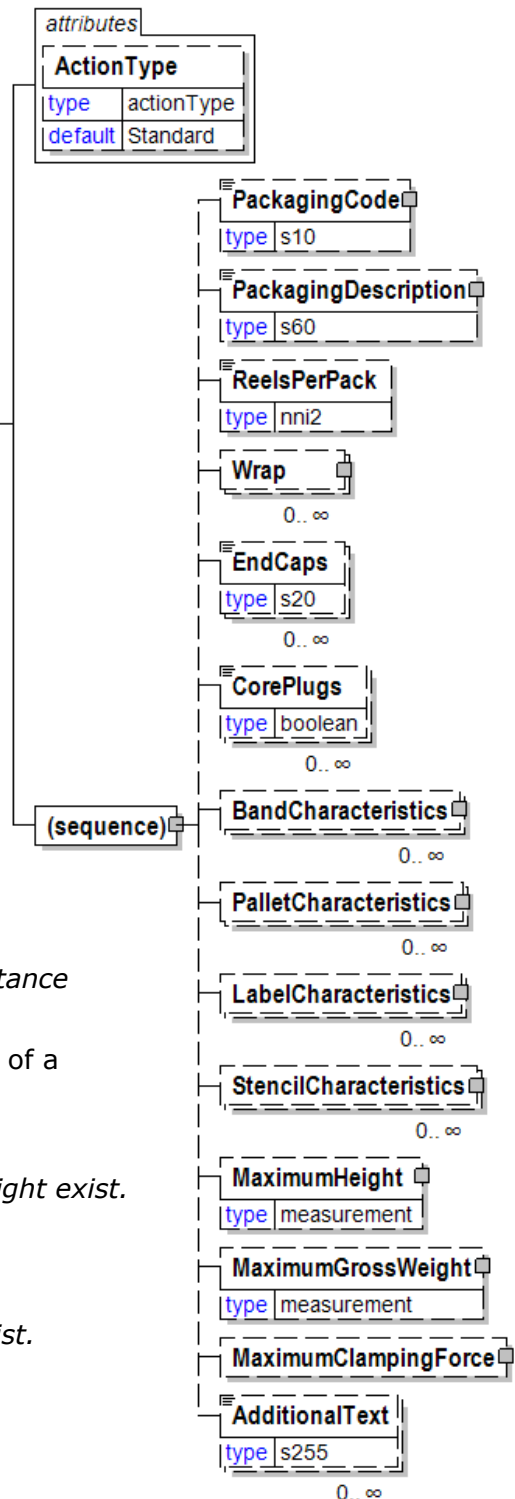

papiNet V2R31

Note: A conversion error took place between Version 1.0 of papiNet and Version 2.0 of papiNet and this item was inadvertently converted from true/false (1.0) to nni1 (2.0). this item has been reinstated to a boolean value. However, please note that for reasons of backward compatibility it is highly recommended that you use the 1/0 approach to communicating true or false where 1 = true and 0 = false. Our apologies for any issues.

BandCharacteristics

BandCharacteristics is optional. Multiple instances might exist.

A group item that organises the packaging band detail information.

PalletCharacteristics

PalletCharacteristics is optional. Multiple instances might exist.

A group item that provides pallet detail information.

LabelCharacteristics

LabelCharacteristics is optional. Multiple instances might exist.

A group item that organises the labeling information.

StencilCharacteristics

StencilCharacteristics is optional. Multiple instances might exist.

A group element specifying attributes of a stencil to be applied to an item, and optional text.

MaximumHeight

MaximumHeight is optional. A single instance might exist.

The maximum height allowed including the pallet.

MaximumGrossWeight

MaximumGrossWeight is optional. A single instance might exist.

The maximum weight allowed including the pallet.

MaximumClampingForce

MaximumClampingForce is optional. A single instance might exist.

Specifies maximum clamp force allowed during handling of an item.

AdditionalText

AdditionalText is optional. Multiple instances might exist.

A text field that is used to communicate information not previously defined or for special instructions. To be used only for circumstances not covered by specific elements.

ReelsPerPack

The number of reels within a package.

ReelsPerPack	
type	nni2

ReelStandUnit

The reelstand unit number.

ReelStandUnit	
type	s10

ReelWidth

The width of reel from edge to edge excluding packaging.

(sequence)

The sequence of items below is mandatory. A single instance is required.

Value

Value is mandatory. A single instance is required.

A numeric value expressed in the unit of measure (UOM).

RangeMin

RangeMin is optional. A single instance might exist.

The minimum value (lower boundary) allowed for the Measurement that is the parent of this element.

RangeMax

RangeMax is optional. A single instance might exist.

The maximum value (upper boundary) allowed for the Measurement that is the parent of this element. Some elements use the RangeMax element with an extended list of unit of measures. (Note: the red colour in the picture is an artifact of how the graphic was captured and should be disregarded.)

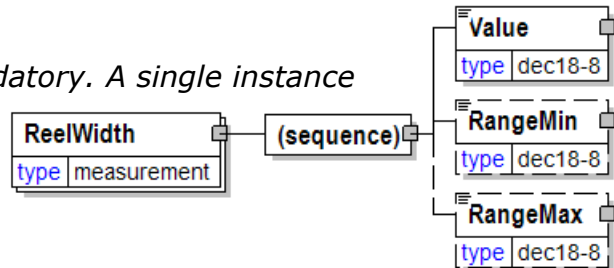

referenceType [simple type]

This entry provides the definitions for the named reference types that papiNet provides. As there are 45+ of them and they all have the same enumerations and definition, presenting a single entry serves to save space. The standard definition for all reference types and their enumerations follows.

Provides a contextual explanation of the specific reference identifier. Many items are currently prefixed by "Buyer", "Forwarder", "Manufacturer", "Mill", "Publisher", "Seller", "Supplier", "Warehouse", or "Vendor". Check for an existing non-prefixed version and use the non-prefixed version instead. In the (yet to be announced release date) version 3.0 the prefixed versions will be removed. Instead the attribute @AssignedBy will communicate the information previously communicated in the prefix.

This item is restricted to the following list.

AccountNumber

The unique reference number given to a financial account of the party involved in the transaction.

AudioVideoSelectionNumber

Unique number given to every audio master. Used by duplicators and replicators.

Author

Name of the author of the product or book.

BarCodedSerialNumber

The serial number in bar code form.

BillAndHoldInvoiceNumber

The invoice number used in a bill and hold arrangement.

BillOfLadingMark

Assigning party's reference mark on each package used for logistic purposes (a mark which is painted to packages just to make handling easier). Not to be confused with Bill of Lading Number.

BillOfLadingNumber

The unique reference number given to a bill of lading document given to the carrier transporting the product; the bill of lading is a legal document that lists all the products that are being transported.

BindingStyleType

BindingStyleType indicates the method used to hold the pages of the issue together. Examples are Saddle Stitch (staple through the middle fold) and Perfect Bound (glue).

BookLanguage

The language of the text of the book.

BookingNumber

The reference number used for the booking of logistics services.

BookVolumeNumber

A number assigned to a book that denotes the sequential order when several books are either bound in an identical format or are part of a series or set.

BudgetCenter

An internal cost-centre identifier.

BusinessChainNumber

The unique identifier of a business chain.

BuyerBudgetCenter

To be deprecated in a future version V3R00. Refer to "BudgetCenter" for the definition and use the attribute "AssignedBy" for buyer.

BuyerClaimNumber

To be deprecated in a future version V3R00. Refer to "ClaimNumber" for the definition and use the attribute "AssignedBy" for buyer.

BuyerDivisionIdentifier

To be deprecated in a future version V3R00. Refer to "DivisionIdentifier" for

the definition and use the attribute "AssignedBy" for buyer.

BuyerImprint

To be deprecated in a future version V3R00. Refer to "Imprint" for the definition and use the attribute "AssignedBy" for buyer.

BuyerJobNumber

To be deprecated in a future version V3R00. Refer to "JobNumber" for the definition and use the attribute "AssignedBy" for buyer.

BuyerRetailPrice

To be deprecated in a future version V3R00. Refer to "RetailPrice" for the definition and use the attribute "AssignedBy" for buyer.

CallOffConfirmationLineItemNumber

The specific line item number for a calloff confirmation document.

CallOffConfirmationNumber

The unique reference number given to a calloff confirmation document.

CallOffLineItemNumber

The specific line item number for a calloff document.

CallOffNumber

The unique reference number given to a calloff document. The calloff number of a previously sent calloff can be referenced. For example, a seller can refer to a calloff number in a DeliveryMessage.

CallOffReferenceNumber

A general informational reference (either textual or numeric) given to a CallOff. The CallOff reference number of a previously sent CallOff can be indicated. For example, a seller can refer to a CallOff reference number in a DeliveryMessage.

CatalogueReferenceNumber

A unique reference for a catalogue.

CHEDPPNumber

A unique identifier for Common Health Entry Document for consignments of Plants and Plant products. The CHED-PP reference is managed by TRACES (Trade Control and Expert System). TRACES is European Commission's online sanitary and phytosanitary certification platform. This reference number is AssignedBy "EU".

For more information please see

https://webgate.ec.europa.eu/cfcas3/tracesnt-webhelp/Content/L_CHED-PP/Intro.htm

CIMNumber

The unique reference number given to an international freight document for rail transport.

CMRNumber

The unique reference number given to an international freight document for road transport.

CoLoadingNumber

A reference to the identifier for the CoLoading communication.

CompensationCalculationID

A unique reference number given to a calculation of compensation. For example, compensation for a delivered product can be calculated based on quantity, price per unit, additions and deductions.

In many cases, this reference is unique only if also the version of the calculation is specified. New versions of the calculation can be created, if input values used in the calculation are changed. The version of the calculation is referenced by using DocumentVersionNumber in the papiNet construct DocumentReferenceInformation.

CompensationChainNumber

The unique identifier of a compensation chain.

ComplaintNumber

The reference number associated with a complaint.

ComplaintLineItemNumber

A number that uniquely identifies the line item of a complaint document.

ComplaintResponseNumber

The reference number associated with a complaint response document.

ComplaintResponseLineItemNumber

A number that uniquely identifies a line item of a complaint response document.

ConsigneeOrderNumber

To be deprecated in a future version V3R00. Refer to "OrderNumber" for the definition and use the attribute "AssignedBy" for consignee.

ContainerReference

The reference number of the container.

ContentLanguage

ContentOrderOfMatterNumber

The unique identifier of a content order of matter document.

ContentOrderOfMatterVersionNumber

A value that keeps track of the version of content order of matter document

ContractGroupReferenceNumber

A reference number to a group of contracts relevant to a particular business item.

ContractLineNumber

A particular line number of a contract. Note: To reference a contract line number, the seller or buyer must include a clear reference to the corresponding contract elsewhere in the document.

ContractNumber

The unique reference number given to a mutual commercial/trading agreement between a buyer and a seller. The agreement can cover a quote, a bid, a contract, pricing, invoicing, and/or payment terms.

ConvertingReportNumber

An identifier used to communicate which converting report is being referred to.

Copyright

The year of publication copyright.

CorrelationReferenceNumber

A reference number used for grouping of related e-Documents or related items within e-Documents, e.g. invoice line items.

CreditAuthorizationNumber

The number of the credit authorization.

CreditDebitNoteNumber

To be deprecated in a future version V3R00. Use either CreditNoteNumber or DebitNoteNumber.

CreditNoteNumber

The number of the referenced credit note document.

CustomerBookingNumber

To be deprecated in a future version V3R00. Refer to "BookingNumber" for the definition and use the attribute "AssignedBy" for customer.

CustomerJobNumber

To be deprecated in a future version V3R00. Refer to "JobNumber" for the definition and use the attribute "AssignedBy" for customer.

CustomerJobTitle

To be deprecated in a future version V3R00. Refer to "JobTitle" for the definition and use the attribute "AssignedBy" for customer.

CustomerOrderNumber

To be deprecated in a future version V3R00. Refer to "OrderNumber" for the definition and use the attribute "AssignedBy" for customer.

CustomerReferenceNumber

To be deprecated in a future version V3R00. Refer to "ReferenceNumber" for the definition and use the attribute "AssignedBy" for customer.

CustomerSpecificationNumber

To be deprecated in a future version V3R00. Refer to "SpecificationReferenceNumber" for the definition and use the attribute "AssignedBy" for customer.

DebitNoteNumber

The number of the referenced debit note document.

DeliveryBookingNumber

A number use to schedule deliveries at their site.

DeliveryInstructionNumber

The unique identifier given to a delivery instruction document.

DeliveryInstructionSequenceNumber

The unique reference number given to a delivery instruction sequence.

DeliveryInstructionSequenceLineNumber

A sequential number that uniquely identifies a line item of a delivery instruction sequence.

DeliveryLocation

The location to which product is to be delivered.

DeliveryMessageNumber

The identifier of a delivery message document.

DeliveryMessageLineItemNumber

A number that uniquely identifies a line item of a delivery message document.

DeliveryNumber

Alternate delivery number when the party uses secondary documents to manage their own system.

DeliveryPlanningNumber

The identifier of a delivery planning document.

DeliveryPlanningSequenceNumber

The reference number given to a sequence in a delivery planning document.

DeliverySourceNumber

The identifier of the delivery source in the supply chain.

DepartmentIdentifier

A major division of a business.

DespatchInformationNumber

The unique reference number of the despatch information document.

DespatchInstructionNumber

The unique reference number of the despatch instruction document. For example the despatch instructions sent from the mill to the warehouse.

DivisionIdentifier

The internal division identifier for the party.

DropOffNumber

The identifier for the stop or location that the delivery vehicle will make.

Edition

Identifies the version of the product for which copies were printed and published at one time; For example in book manufacturing values might be 1st, 2nd, etc

EditionState

List of state abbreviations. The term "National" may also be used.

EditionSubject

Subject Heading as designated by Book Industry Study Group BISG.

EditionSubjectNumber

Number defined by Book Industry Study Group BISG to codify the subject matter of the book.

EducationSubject

Identifies the subject matter of a text book (such as Math, Science, etc.).

EKAERNumber

EKAER stands for Electronic Trade and Transport Control System ('elektronikus közúti áruforgalom-ellenőrző rendszer'). The new regulations making the use of the system mandatory in Hungary will take effect as of January 1st, 2015. aiming to filter out VAT fraud and minimize their possibility in public road transit to the fullest possible extent. Therefore it will monitor goods trafficking inside Hungary and also goods transported on public roads between member states of the European Union.

When communicating the EKAERNumber within the papiNet e-Document the enumeration "Customs" should be used in AssignedBy, as the EKAERNumber is issued by the National Tax and Customs Administration of Hungary (NTCA).

<http://ekaer.hu/en/>

EndCallOffDate

The last date that a call off can be placed.

EnergyCalculationReferenceNumber

A reference to the specification for how energy content should be calculated for a material.

EntrySummaryDeclarationNumber

The identifier assigned to an Entry Summary Declaration. An Entry Summary Declaration must be submitted before goods are moved into the customs territory of the European Union directly from countries outside the Union. The Entry Summary Declaration is used for submitting the so-called safety and security data in advance, which is mandatory for all modes of transport in the European Union. The data in the declaration is used for making electronic risk analysis concerning safety and security. This reference number is AssignedBy "Customs".

For more information please see

<https://trade.ec.europa.eu/tradehelp/eu-import-procedures>

FlightNumber

The reference number given to a flight number.

ForestUsageDeclarationNumber

An official number of a forest usage declaration allowing proof of felling of trees in a logging area given by the national forest authority.

FormID

Identifies the Form that the reference is associated with.

FormLowFolio

An additional identifier of a Form.

FormPages

The number of pages associated with a Form's Delivery (Pages on a Signature).

FormType

Type of printed signature.

For book manufacturing, examples are: web, sheet, folded and gathered signature.

For magazine publishing examples are: Advance, Cover, or Current.

Advance denotes those pages other than Cover and Current. They are usually advertisements and other pages that are less subject to change and can be printed further in advance of the issue date.

Cover denotes the cover pages of the issue.

Current denotes those pages that are more subject to edit changes and are therefore printed closer to the issue date.

ForwarderReference

To be deprecated in a future version V3R00. Refer to "ReferenceNumber" for the definition and use the attribute "AssignedBy" for forwarder.

FromPurchaseOrderNumber

The PurchaseOrder that is used as the source of information.

FromSalesOrderNumber

The sales order that is used as the source of information.

FSCNumber

A certificate registration code for a site that has been certified in accordance with the requirements of the Forest Stewardship Council A.C. for delivering of FSC certified products. This number would also be communicated in the LicenceNumber element of the SafetyAndEnvironmentalInformation.

GeneralAgreement

The particular standard industry contract is being used to indicate incoterms agreements, arbitration rules, chartering, insurance, payment & freight, claims, etc.

GoodsArrivalNumber

The unique reference number given to each goods when arriving on a transport to a location. It is assigned by the party operating the location.

GoodsInBillOfLadingNumber

The unique reference number given to a bill of lading number for a transport which delivered goods into a location.

GoodsInDeliveryNumber

The unique reference number given to a delivery number for a transport which delivered goods into a location.

GoodsInTransportUnitIdentifier

The reference number given to a unit identifier for a transport which delivered goods into a location.

GoodsInTransportVehicleIdentifier

The reference number given to a vehicle identifier for a transport which delivered goods into a location.

GoodsReceiptNumber

The number of the GoodsReceipt transaction that is being referred to.

GoodsReceiptLineItemNumber

The line item number of the GoodsReceipt transaction that is being referred to.

Imprint

Identifies the imprint to which this product belongs. When communicating the "publisher's imprint" use an assigned by of "Buyer".

IndentOrderNumber

A unique reference number given to an order, which is to be delivered directly to the buyer's own customer (typically a paper merchant). The reference value is passed from the buyer to the seller and the information content is meaningful only to the buyer.

InitialShipmentAdviceNumber

The unique reference number given to an initial shipment advice. The number of a previously sent initial shipment advice can be referenced. For example, a seller can refer to an initial shipment advice number in a DeliveryMessage.

IntraStatNumber

The unique reference number given to product groups by the international authority Intrastat for statistical purposes. This number must be on the invoice when importing or exporting goods.

InventoryChangeLineItemNumber

An identifier for an inventory change line item.

InventoryChangeLineItemNumber (misspelt with an ending space)

The item is misspelt ending with a space. It will be deprecated in a future version V3R00. Use instead the correctly spelt enumeration `InventoryChangeLineItemNumber`.

InventoryChangeNumber

The identifier for an inventory change document.

InventoryDispositionInstructionsNumber

The unique reference number given to an inventory disposition instructions document.

InventoryDispositionInstructionsLineNumber

The sequential reference number given to a inventory disposition line number.

InventoryStatusLineItemNumber

An identifier that allows for unique identification of an inventory status line item.

InventoryStatusNumber

An identifier that allows for unique identification of an inventory status document.

InvoiceNumber

The number associated with a invoice document.

ISBN10

10 digit ISBN code without dashes

ISBN10Dash

10 digit ISBN code with dashes

ISBN13

13 digit ISBN code.

ISBN13Dash

A 13 character ISBN with dashes; example of ISBN-13 with dashes: 978-1-873671-00-0.

ISODocumentReference

A unique ISO 9002 / 9001 document identifier.

IssueEvent

A task, or other type of event, related to the creation of an issue of a publication.

JobNumber

An identifier for a step in the production, publication, or manufacturing process. Usually a job has as its scope the amount of work performed by a defined resource (person or equipment).

JobTitle

A name of a specific job or task to which the forecast data is to apply, along with location and item.

LoadingInstructionNumber

The unique reference number given to a loading instruction.

LoadingInstructionSequenceNumber

A sequential number that uniquely identifies the sequence in a loading instruction.

LoadingInstructionSequenceLineNumber

A sequential number that uniquely identifies a line number in a sequence of a loading instruction.

LoadingOrderNumber

The identifier for the loading order.

LoadingOrderLineNumber

The line item number a the loading order.

LoadPlanNumber

A reference number given to a general unique load plan number generated in the planning phase before any physical loads exist.

LoadReleaseNumber

The identifier for the Load Release.

LoadTenderNumber

The identifier for a load tender document.

LoadTenderResponseNumber

The identifier for a load tender response document.

LoadTenderResponseSegmentNumber

The identifier for a load tender response segment.

LoadTenderSegmentNumber

The identifier for a load tender segment.

LocationReferenceIdentifier

An identifier for referencing a location.

LotIdentifier

A unique code used to identify a grouping of product with one set of quality statistics common to all members of that group. Synonym: Lot Number

MagazineCode

A code used to identify a magazine.

ManufacturerMaterialSafetyDataSheetNumber

To be deprecated in a future version V3R00. Refer to "MaterialSafetyDataSheet" for the definition and use the attribute "AssignedBy" for producer (manufacturer).

MarketType

Mass Market, Picture Books, Trade, Education, etc.

MarketplaceReferenceNumber

To be deprecated in a future version V3R00. Refer to "ReferenceNumber" for the definition and use the attribute "AssignedBy" for marketplace.

MasterBillOfLading

The unique reference number given to a master bill of lading document, which contains multiple bills of lading. This is a legal document given to the carrier that transports the goods to multiple customers, each of which then receive a unique bill of lading document.

MasterContractNumber

Contract number that is broader in terms of doing business between partners which for the book industry may, or may not include pricing.

MasterISBN10

Refers to the ISBN10 of a product where the product being ordered is a part

MasterISBN13

Refers to the ISBN13 of a product where the product being ordered is a part

MasterPurchaseOrder

Refers to a Buyer's PurchaseOrder Number under which separate purchase orders are generated but the master PO will never be sent to the supplier.

MaterialSafetyDataSheetNumber

A U.S. document describing the safety, environmental and physical issues, if any, for a product.

MeasuringCheckSampleNumber

The unique identifier of a control measuring check sample.

MeasuringInstructionNumber

The unique identifier of a measuring instruction document.

MeasuringInstructionSequenceLineItemNumber

A sequential number that uniquely identifies a line item of a measuring instruction sequence.

MeasuringInstructionSequenceNumber

A sequential number that uniquely identifies the sequence in a measuring instruction document.

MeasuringNumber

A unique identifier for the measuring information communicated in a MeasuringTicketSequence.

The measuring information in the MeasuringTicketSequence can have different identifiers depending on the source of the information, such as a measuring event, a calculation of quantities based on a measuring event and a calculation of compensation based on quantities and prices, as well as on the MeasuringTicketType and the MeasuringTicketContextType of the MeasuringTicket.

MeasuringTicketNumber

The unique identifier of a measuring ticket document.

MeasuringTicketSequenceNumber

A sequential number that uniquely identifies the sequence in a measuring ticket document.

MeasuringTicketSequenceLineItemNumber

A sequential number that uniquely identifies a line item of a measuring ticket sequence.

MillOrderLineItemNumber

To be deprecated in a future version V3R00. Refer to "OrderLineItemNumber" for the definition and use the attribute "AssignedBy" for mill.

MillOrderNumber

To be deprecated in a future version V3R00. Refer to "OrderNumber" for the

definition and use the attribute "AssignedBy" for mill.

MillSalesOfficeNumber

To be deprecated in a future version V3R00. Refer to "SalesOfficeNumber" for the definition and use the attribute "AssignedBy" for mill.

MovementReferenceNumber

Movement Reference Number (MRN), also named as Master Reference Number, is given by European customs authorities. This is the reference number of the goods shipment in all European custom systems. This reference number is AssignedBy "Customs". For more information please see <https://data.europa.eu/euodp/en/data/dataset/transit-movement-reference-number>

NonconformanceReportNumber

The number assigned to a non-conformance report.

OrderConfirmationNumber

The number of the order confirmation document that is used to identify the transaction, or portion of the transaction.

OrderConfirmationLineItemNumber

The line item on the order confirmation document (identified by the OrderConfirmationNumber).

OrderNumber

The number of the order that is used to identify the transaction, or portion of the transaction.

OrderLineItemNumber

The line item on the order (identified by OrderNumber).

OrderPartyReferenceNumber

To be deprecated in a future version V3R00. Refer to "ReferenceNumber" for the definition and use the attribute "AssignedBy" of "OrderParty".

OriginalComplaintResponseNumber

Reference number of the original complaint response document.

OriginalDeliveryNumber

The unique reference number given to a DeliveryMessage number sent previously that has been replaced in the meantime.

OriginalGoodsReceiptNumber

The original unique identifier of the goods receipt document that is to be replaced.

OriginalInvoiceNumber

To be deprecated in a future version V3R00. Use InvoiceNumber.

OriginalProductQualityMessageNumber

The unique reference number given to a product quality document sent previously that has been replaced in the meantime.

OriginalPurchaseOrderNumber

The unique reference number given to a purchase order document sent previously that has been replaced (through amendment or cancellation) in the meantime.

OriginalSalesOrderNumber

The unique reference number given to a sales order previously communicated that has been replaced (through amendment or cancellation) in the meantime.

OriginalScaleTicketNumber

The unique reference number given to the original scale ticket document.

OriginalUsageNumber

The unique reference number given to a usage document previously sent that has been replaced (through amendment or cancellation) in the meantime.

PackageMark

A mark applied to packages. The package mark is mainly used for logistics purposes by grouping of packages together and making handling and storing easier.

PackageNumber

The unique reference number given to a manufacturer's product packaging designation.

PackageSpecificationNumber

The reference number given to a set of packing specifications.

PackageSpecificationLineNumber

The reference number given to one line of a set of packing specifications.

PageCount

Number of text pages in the book or component.

PageCountTotal

Total number of pages including inserts.

PaymentReferenceNumber

Payment reference number is used when paying the invoice. It associates the payment to the right invoice in an electronic payment scenario.

PEFCNumber

A certificate registration code for a site that has been certified in accordance with the requirements of the Programme for the Endorsement of Forest Certification. This number would also be communicated in the LicenceNumber element of the SafetyAndEnvironmentalInformation.

PickUpNumber

Indicates the route number for the pick-up location for a transport order.

PlanningMessageNumber

The unique reference number to a planning document that includes estimated volumes for the product being called off.

PopulationNumber

A reference number identifying a group of clearly-defined items with similar characteristics. Currently used by Forest Wood Supply for statistical Calculation adjustments.

PrepContentName

Name of the document or file that contains the content for the associated book or component

PriceContractNumber

Contract number that is specific to pricing.

PriceQuoteNumber

Quote number that is specific to pricing.

PriceList

The number used to identify the price list.

PriceListItem

The reference number used to identify an item in a price list.

PriceListLineItem

The reference number used to identify the line item of a price list.

PrintingCode

Identifies the book as a New Boo, Reprint, New Adoption, etc.

PrintingNumber

A reference to the sequential print run number.

PriorPurchaseOrderNumber

The preceding purchase order number.

ProductAttributesNumber

The unique identifier of the product attributes document.

ProductOriginIdentifier

A reference number identifying the origin of the product. It is typically used as a tracking reference.

ProductOriginMark

A mark applied to items of products manufactured at the same location. For example, this mark can be applied to the butt end of logs at a logging area in Forest Wood Supply & Bioproducts business.

ProductReferenceNumber

A unique reference number (either textual or numeric) given to a product for which the owner or source is specified in the "@AssignedBy" attribute.

ProFormaInvoiceNumber

The identification number for the pro forma invoice.

ProNumber

A (Progressively) sequential numbering system used to identify logistics bills. Referred to, in Europe, as Verification Number.

Example: ANC5376559

ProfitCenter

Profit center identifier

ProgramID

Identifies that the item is associated with a series. In the book manufacturing industry examples would be, "Science Series 2007, "Math Series 2009".

PromotionNumber

The sales promotion number.

PubName

The publication name.

PubNumber

The publication number.

PublisherReferenceNumber

To be deprecated in a future version V3R00. Refer to "ReferenceNumber" for the definition and use the attribute "AssignedBy" for Publisher.

PupilsTeachers

Description of the pupils/teachers edition specific to educational book products.

PurchaseOrderCorrelationID

Contains a reference value which is used to identify a group of purchase orders for products that are priced based on being manufactured together because of common components.

PurchaseOrderNumber

The unique reference number given to a purchase order. The purchase order number of a previously sent order can be referenced. For example, a seller can refer to a purchase order number in an invoice.

PurchaseOrderLineItemCorrelationID

Contains a reference value which is used to identify a group of PurchaseOrder Line Items that refer to the same product.

PurchaseOrderLineItemNumber

A sequential number that uniquely identifies the PurchaseOrder line item.

PurchaseOrderReleaseNumber

The version or release of the PurchaseOrder.

QualityReportNumber

A number that uniquely identifies a quality report.

QuantityCalculationID

A unique reference number given to a calculation of quantities. For example, quantity for a delivered product can be calculated based on measured properties of the delivered product.

In many cases, this reference is unique only if also the version of the

calculation is specified. New versions of the calculation can be created, if some measured values and/or used parameters are changed. The version of the calculation is referenced by using DocumentVersionNumber in the papiNet construct DocumentReferenceInformation.

RandomSampleNumber

The unique identifier of a random sample.

RealEstatePropertyNumber

An official number identifying a real estate property.

ReferenceNumber

An informational reference (either textual or numeric) for which the owner or source is specified in the "@AssignedBy" attribute

ReleaseNumber

The unique identifier (either textual or numeric) given to the release of a reservation order, a contract, or a blanket order.

ResourceInformationNumber

The unique identifying number of a ResourceInformation.

RetailPrice

Cover price of the finished product.

RFQLineItemNumber

The number used to identify a line item in a RFQ document.

RFQNumber

The identifier of a RFQ document. Usually provided when opening a purchase order that is derived from a request for quote (RFQ).

RunNumber

The unique reference number given to a paper-manufacturing slot on the mill production line (for example, paper machine or sheet cutter). Paper for several orders is manufactured in one run before resetting the machines for new manufacturing results.

SalesOfficeNumber

The number used to identify the sales office.

SalesOrderLineItemNumber

A number that uniquely identifies the sales order line item.

SalesOrderNumber

The unique reference number given to a sales order.

SampleNumber

SampleNumber is a unique identifier given to a physical sample that has been taken from the product.

SampleStorageLocation

The location where samples are stored

ScaleTicketNumber

The identifier for a scale ticket document.

SchoolGrade

Grade level indicator of the book product, specific to educational text books such as grade 3. (K=Kindergarten, 1 through 12, CO=College)

SchoolGradeLevel

Further definition of the Grade level of the book product, specific to educational text books such as grade 3 level A.

SellersInvoiceNumber

To be deprecated in a future version V3R00. Refer to "InvoiceNumber" for the definition and use the attribute "AssignedBy" for seller.

ServiceInstructionLineItemNumber

A sequential number that uniquely identifies a line item of a service instruction document.

ServiceInstructionNumber

The unique identifier of a service instruction document.

ServiceNumber

The product number for the service.

ShipmentEventIdentifier

A unique identifier of a Shipment Event.

ShipmentStatusNumber

The unique identifier for a shipment status document.

ShippingInstructionsLineItemNumber

Line number reference of a shipping instructions document for book shipments.

ShippingInstructionsNumber

Sequential number of a shipping instructions document.

SimplifiedCustomsNumber

A number that identifies the applicable simplified customs arrangement.

SpecificationNumber

The unique reference number given to a book specification document. For example, the SpecificationNumber of a previously sent book specification document can be referenced by a buyer in a purchase order.

SpecificationReferenceNumber

To be deprecated in a future version V3R00. Use instead SpecificationNumber.

SpecificationVersion

The unique version number given to a book specification document. For example, the SpecVersion of a previously sent book specification document can be referenced by a buyer in a purchase order.

StanForDForwardedProductionNumber

papiNet V2R31

The identifier of the forwarded production file in the StanForD standard used by forest machines.

StanForDHarvestedProductionNumber

The identifier of the harvested production file in the StanForD standard used by forest machines.

StanForDHarvestingQualityControlNumber

The identifier of the harvesting quality control file in the StanForD standard used by forest machines.

StockOrderLineItemNumber

A number that uniquely identifies the line item of a stock order. The stock order is identified by the StockOrderNumber.

StockOrderNumber

The unique reference number given to an order, which is to be delivered to the buyer's designated stock location (typically a paper merchant). The reference value is passed from the buyer to the supplier and the information content is meaningful only to the buyer.

StorageLocationProductBatchIdentifier

The unique identifier given to a transporting or measurement batch expressed as a combination of a product and a storage location.

SupplierCallOffNumber

To be deprecated in a future version V3R00. Refer to "CallOffNumber" for the definition and use the attribute "AssignedBy" for supplier.

SupplierClaimNumber

To be deprecated in a future version V3R00. Refer to "ClaimNumber" for the definition and use the attribute "AssignedBy" for supplier.

SupplierJobNumber

To be deprecated in a future version V3R00. Refer to "JobNumber" for the definition and use the attribute "AssignedBy" for supplier.

SupplierReferenceNumber

To be deprecated in a future version V3R00. Refer to "ReferenceNumber" for the definition and use the attribute "AssignedBy" for supplier.

SupplierVoyageNumber

To be deprecated in a future version V3R00. Refer to "VoyageNumber" for the definition and use the attribute "AssignedBy" for supplier.

T2L

T2L is a customs clearance document. It demonstrates that the goods in question originate from free trade in the European Community.

TimeTableNumber

The reference number given to a timetable.

Title

Proper title of a book product.

TitleAlias

Alternate title description for book products, usually for security purposes.

ToPurchaseOrderNumber

The destination of purchase order information.

TrackingNumber

TrackingNumber is a logistics identifier assigned to a shipment.

TransactionID

Unique system-wide identifier for a transaction used as a source for creation of the papiNet e-Document, e.g. an SAP IDoc number.

TransportArrivalNumber

The unique reference number given to a transport when arriving to a location. It is assigned by the party operating the location.

TransportUnitIdentifier

The reference number given to a transport unit. The transport unit is the portion of the vehicle that is holds the goods.

TransportVehicleIdentifier

The reference number given to a vehicle used for transport.

UniversalProductIdentifier

Unique identifier for the book, component of a book product, and many other products.

URLReferenceNumber

An informational reference given as and an URL (Universal Resource Locator).

UsageNumber

The number used to identify the usage activity being referred to.

UsageLineItemNumber

The line item number used to identify the usage activity being referred to.

VehicleTourNumber

A reference number used to identify a specific one-time tour that a single vehicle is either scheduled for or is travelling. One single VehicleTourNumber can be referred as the vehicle travels and makes several stops for loading and unloading.

VendorReferenceNumber

To be deprecated in a future version V3R00. Refer to "ReferenceNumber" for the definition and use the attribute "AssignedBy" for seller.

VesselShipNotice

Ship notice for the vessel.

VolumeTariff

The unique reference number given to a tariff (volume table) when calculating volume of a product.

VoucherNumber

The unique reference number given to a document serving as evidence for some claimed transaction, e.g. as the receipt or expenditure of money.

VoyageNumber

The assigning party's unique reference number (own internal code) given to a voyage. This may or may not be the port authority's number.

WarehouseDeliveryNumber

To be deprecated in a future version V3R00. Refer to "DeliveryNumber" for the definition and use the attribute "AssignedBy" for warehouse.

WaybillIdentifier

Identifies the document that acknowledges receipt of the goods being shipped and specifying the terms of delivery.

WoodExportQuotaLicenceNumber

The licence number admitted by the local authority or Customs to a wood exporting company for export quota based on tariff-rates or other grounds. (SIGL, <http://trade.ec.europa.eu/sigl/>).

WoodImportQuotaLicenceNumber

The licence number admitted by the local authority or the Customs to a wood importing company for import quota based on tariff-rates or other grounds. (SIGL, <http://trade.ec.europa.eu/sigl/>)

Other

Used for any other reference that is not covered by this attribute list.

Reissued [attribute]

Either "Yes" or "No".

This item is restricted to the following list.

Yes

No

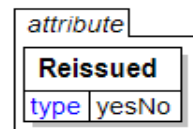

RelatedProduct

Specifies a related product to a product in a product hierarchy.

RelatedProductGranularity [attribute]

RelatedProductGranularity is mandatory. A single instance is required.

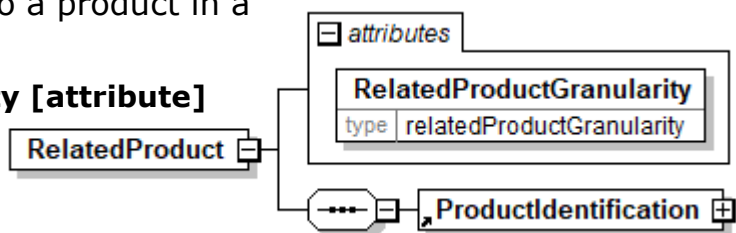

Specifies the levelling of the related product in the product hierarchy.

Refer to RelatedProductGranularity definition for any enumerations.

(sequence)

papiNet V2R31

The sequence of items below is mandatory. A single instance is required.

ProductIdentification

ProductIdentification is mandatory. A single instance is required.

A grouping element designed to communicate product identification related to the parent element that contains this item.

RelatedProductGranularity [attribute]

Specifies the levelling of the related product in the product hierarchy.

This item is restricted to the following list.

Less

The related product is higher in the product hierarchy.

More

The related product is lower in the product hierarchy.



RelativeLocation [attribute]

The relative position in the end-item where the component is to be placed.



RemitToParty

A group item containing details of the party to whom payment will be made. The RemitToParty contains all information related to remittance.

LogisticsRole [attribute]

LogisticsRole is optional. A single instance might exist.

Communicates the nature of the logistics role, if any, the party plays in the transaction.

Refer to LogisticsRole definition for any enumerations.

(sequence)

The sequence of items below is mandatory. A single instance is required.

PartyIdentifier

PartyIdentifier is optional. Multiple instances might exist.

A unique identifier of a specific party. This element contains an attribute

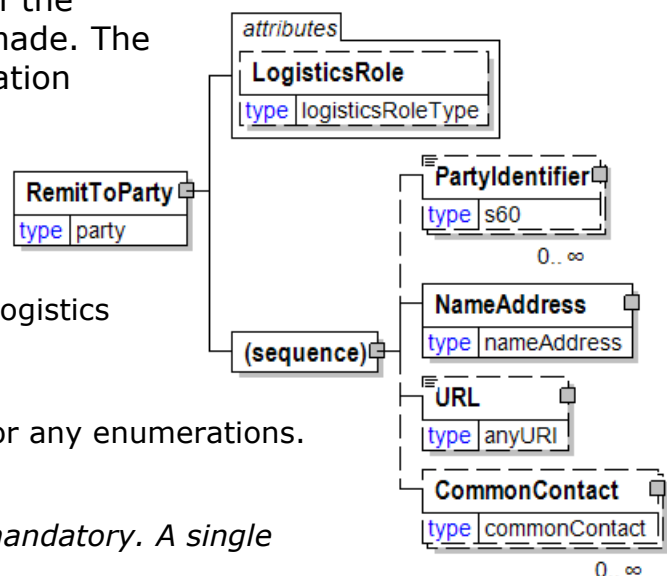

papiNet V2R31

PartyIdentifierType that indicates the type of the identifier.

NameAddress

NameAddress is mandatory. A single instance is required.

A group item containing name and address of an organisation or business entity.

URL

URL is optional. A single instance might exist.

Universal Resource Locator. While typically a web address you could use this field to hold an email address.

CommonContact

CommonContact is optional. Multiple instances might exist.

Identifies a specific individual associated with the party.

RequestedAction

The element that enables the party making the complaint (i.e. SenderParty) to specify what they want done regarding the Complaint (send a credit, send disposition instructions, etc.)

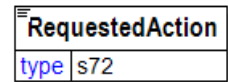

RequestingParty

The party requesting the information.

PartyType [attribute]

PartyType is mandatory. A single instance is required.

Identifies the business role associated with the particular party

Refer to PartyType definition for any enumerations.

LogisticsRole [attribute]

LogisticsRole is optional. A single instance might exist.

Communicates the nature of the logistics role, if any, the party plays in the transaction.

Refer to LogisticsRole definition for any enumerations.

(sequence)

The sequence of items below is mandatory. A single instance is required.

PartyIdentifier

PartyIdentifier is optional. Multiple instances might exist.

A unique identifier of a specific party. This element contains an attribute PartyIdentifierType that indicates the type of the identifier.

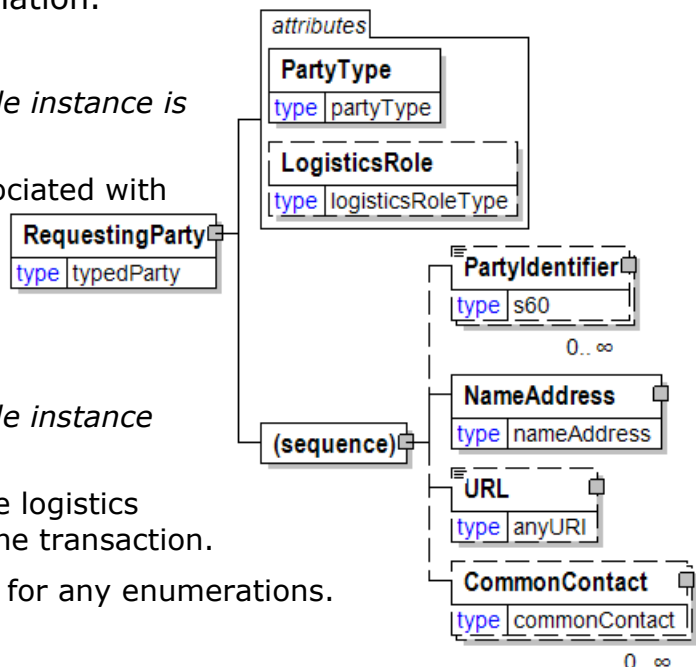

papiNet V2R31

NameAddress

NameAddress is mandatory. A single instance is required.

A group item containing name and address of an organisation or business entity.

URL

URL is optional. A single instance might exist.

Universal Resource Locator. While typically a web address you could use this field to hold an email address.

CommonContact

CommonContact is optional. Multiple instances might exist.

Identifies a specific individual associated with the party.

RequestNumber

A unique tracking number specifically identifying the InfoRequest e-Document to the originator. The tracking number is returned with the "information", the answer, to help match the answer to the request.

RequestNumber
type s30

Resistance

A group item used to communicate air resistance target or test value according to a particular TestMethod.

TestMethod [attribute]

TestMethod is optional. A single instance might exist.

The method used to determine the results of the test under consideration.

TestAgency [attribute]

TestAgency is optional. A single instance might exist.

The agency that has set the parameters for the testing

Refer to TestAgency definition for any enumerations.

SampleType [attribute]

SampleType is optional. A single instance might exist.

Communicates how sampling was done to measure the product characteristics.

Refer to SampleType definition for any enumerations.

ResultSource [attribute]

ResultSource is optional. A single instance might exist.

Used to define the data source of the specified test

Refer to ResultSource definition for any enumerations.

(sequence)

The sequence of items below is mandatory. A single instance is required.

DetailValue

DetailValue is mandatory. A single instance is required.

A numeric value expressed in the unit of measure (UOM).

DetailRangeMin

DetailRangeMin is optional. A single instance might exist.

The minimum value (lower boundary) allowed for the DetailValue that is the parent of this element.

DetailRangeMax

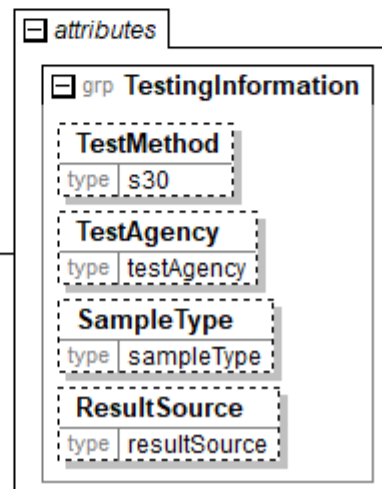
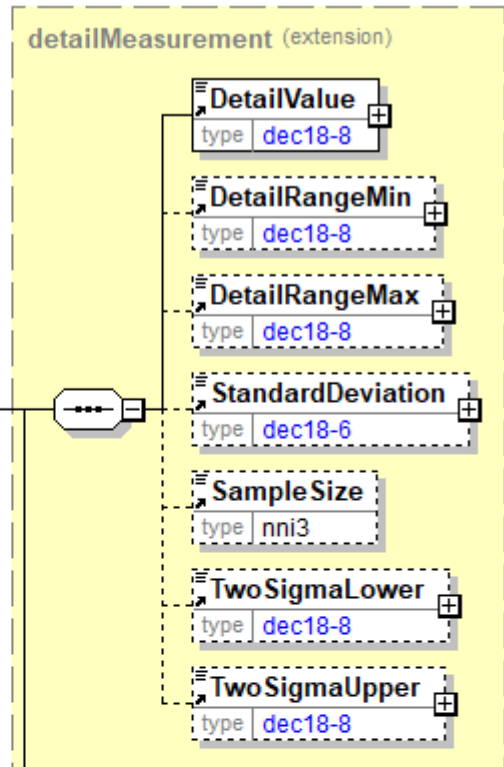

DetailRangeMax is optional. A single instance might exist.

The maximum value (upper boundary) allowed for the DetailValue that is the parent of this element.

StandardDeviation

StandardDeviation is optional. A single instance might exist.

A statistic used as a measure of dispersion in a distribution.

SampleSize

SampleSize is optional. A single instance might exist.

The number of samples used to determine the product characteristic in question.

TwoSigmaLower

TwoSigmaLower is optional. A single instance might exist.

Two sigma (a measure of dispersion associated with standard deviation) on the lower side of the standard deviation.

TwoSigmaUpper

TwoSigmaUpper is optional. A single instance might exist.

Two sigma (a measure of dispersion associated with standard deviation) on the upper side of the standard deviation.

ResourceAvailability

A group item containing information about the availability of a specific resource.

(sequence)

The sequence of items below is mandatory. A single instance is required.

DateTimeRange

DateTimeRange is optional. Multiple instances might exist.

Specifies a date and/or time range.

ResourceShiftInformation

ResourceShiftInformation is optional. Multiple instances might exist.

A group item defining working shift structure of the resource.

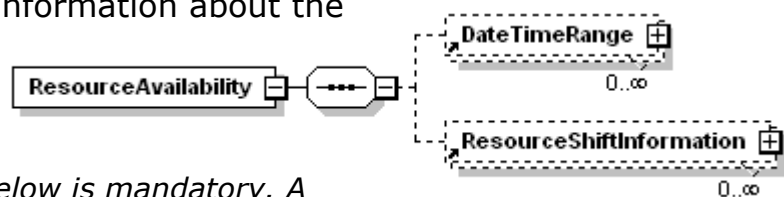

ResourceCharacteristics

A group item that specifies characteristics for a resource.

(sequence)

The sequence of items below is mandatory. A single instance is required.

ResourceTypeCode

ResourceTypeCode is mandatory. A single instance is required.

A code specifying the type of a resource. The ResourceCode is defined by an Agency.

ResourceTypeDescription

ResourceTypeDescription is optional. Multiple instances might exist.

An element used to communicate a human readable description for the type of a resource.

ResourceIDInfo

ResourceIDInfo is mandatory. One instance is required. Multiple instances might exist.

A group item that defines an identifier for a resource.

ResourceReferenceIDInfo

ResourceReferenceIDInfo is optional. Multiple instances might exist.

A group item that binds a referenced resource to another resource. Attribute ResourceReferenceIDType describes the relationship of the referenced resource to another resource.

ResourceReference

ResourceReference is optional. Multiple instances might exist.

An element detailing relevant references pertaining to the resource as indicated by the attribute ResourceReferenceType and AssignedBy.

ResourceIntroductionDate

ResourceIntroductionDate is optional. A single instance might exist.

This is the date when the resource has been taken in use in the specific company.

ResourceAvailability

ResourceAvailability is optional. A single instance might exist.

A group item containing information about the availability of a specific resource.

OtherParty

OtherParty is optional. Multiple instances might exist.

An organisation or business entity other than those specifically detailed within an e-Document.

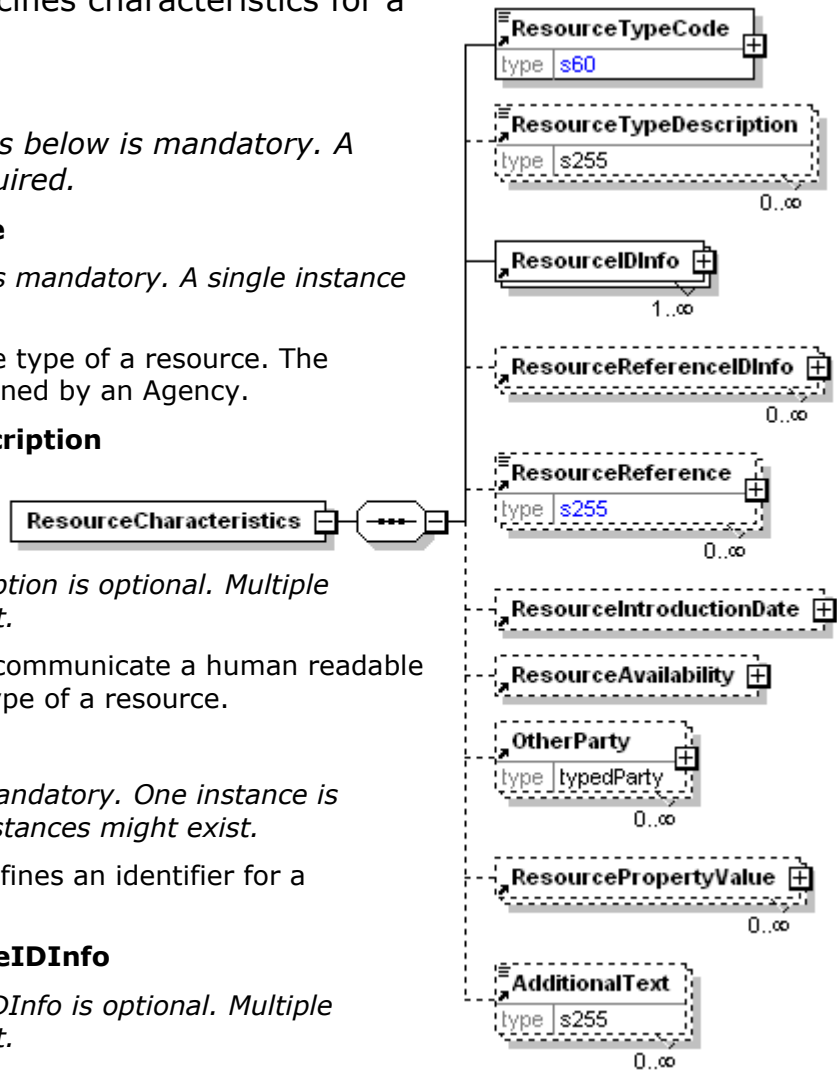

ResourcePropertyValue

ResourcePropertyValue is optional. Multiple instances might exist.

A group item that specifies a value for a property of a resource.

AdditionalText

AdditionalText is optional. Multiple instances might exist.

A text field that is used to communicate information not previously defined or for special instructions. To be used only for circumstances not covered by specific elements.

ResourceDescription

An element used to communicate a human readable description for a specific resource.

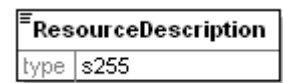

ResourceIdentifier

The unique identifier of a resource. The type of identifier is specified by the attribute ResourceIdentifierType. This identifier can be used to reference a specific resource.

ResourceIdentifierType [attribute]

ResourceIdentifierType is mandatory. A single instance is required.

Defines the type of the identifier for a resource. For example this can be the manufacturing number of the resource.

Refer to ResourceIdentifierType definition for any enumerations.

Agency [attribute]

Agency is optional. A single instance might exist.

Describes the agency maintaining the list of codes. To be included in this list the agency must be a recognized standards body or industry organisation.

- For the element that owns this attribute.
- For another attribute in the list of attributes associated with the parent element.

Refer to Agency definition for any enumerations.

StateOrProvince [attribute]

StateOrProvince is optional. A single instance might exist.

The political designation or boundary of a specific area of land.

ISOCountryCode [attribute]

ISOCountryCode is optional. A single instance might exist.

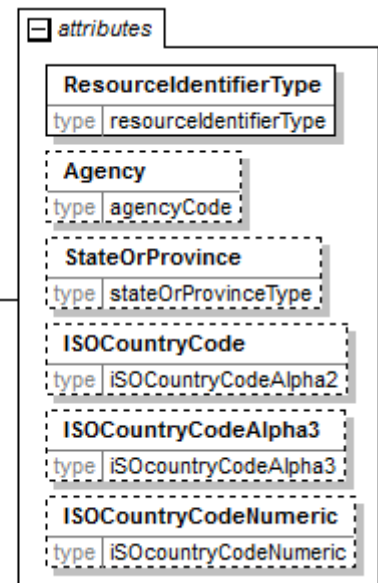
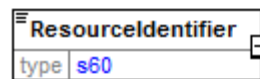

papiNet V2R31

The valid Alpha 2-character list of officially assigned country codes in the ISO 3166-1 international standard.

Information on the content of this attribute is available at:

<https://www.iso.org/obp/ui/#search>

ISOCountryCodeAlpha3 [attribute]

ISOCountryCodeAlpha3 is optional. A single instance might exist.

The valid Alpha 3-character list of officially assigned country codes in the ISO 3166-1 international standard.

Information on the content of this attribute is available at:

<https://www.iso.org/obp/ui/#search>

ISOCountryCodeNumeric [attribute]

ISOCountryCodeNumeric is optional. A single instance might exist.

The valid Numeric 3-digit list of officially assigned country codes in the ISO 3166-1 international standard.

Information on the content of this attribute is available at:

<https://www.iso.org/obp/ui/#search>

ResourceIdentifierType [attribute]

Defines the type of the identifier for a resource. For example this can be the manufacturing number of the resource.

This item is restricted to the following list.



AssignedByAgencyID

A unique identifier that has been assigned by the agency given in the attribute Agency. Attribute Agency is mandatory when AssignedByAgencyID is used.

AssignedByMachineOwnerID

A unique identifier that has been assigned by the owner of the machine.

ContainerID

Defines a container identifier.

CassetteID

Defines a cassette identifier.

DriverLicenseID

The identifier for a driving licence.

EquipmentID

A unique identifier of specific equipment.

IMONumber

An identifier type for a Vessel.

MachineID

A globally unique identifier for the machine. It is an identifier belonging to the

machine independent of the owner of the machine, e.g. a GUID number.

LicencePlateNumber

A licence plate number issued by an official authority.

PassportID

The identifier for a passport.

PersonalID

The identifier for a human being.

RadioCallSign

An identifier type for a Vessel.

RailCarID

A rail car identifier.

RFTagSerialNumber

The fixed built-in identifier of a RFID unit.

TrailerID

An identifier that may be used for a DrawBarCombination, a RigidLorry and a Trailer.

Note: papiNet recommends to use LicencePlateNumber instead of TrailerID in new implementations, if the identifier of the TransportUnit indeed is a licence plate number.

VesselName

The registered name of the vessel.

Other

Used for any other resource identifier not covered by above list.

ResourceIDInfo

A group item that defines an identifier for a resource.

(sequence)

The sequence of items below is mandatory. A single instance is required.

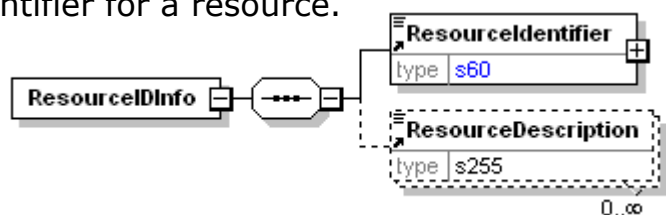

ResourceIdentifier

ResourceIdentifier is mandatory. A single instance is required.

The unique identifier of a resource. The type of identifier is specified by the attribute ResourceIdentifierType. This identifier can be used to reference a specific resource.

ResourceDescription

ResourceDescription is optional. Multiple instances might exist.

An element used to communicate a human readable description for a specific resource.

ResourceInformation

A group item that contains information for specification of resources.

(sequence)

The sequence of items below is mandatory. A single instance is required.

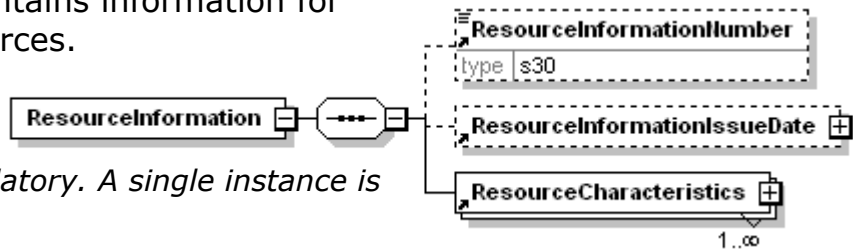

ResourceInformationNumber

ResourceInformationNumber is optional. A single instance might exist.

An element that contains the unique identifying number of the ResourceInformation.

ResourceInformationIssueDate

ResourceInformationIssueDate is optional. A single instance might exist.

The date and time when the ResourceInformation was issued.

ResourceCharacteristics

ResourceCharacteristics is mandatory. One instance is required, multiple instances might exist.

A group item that specifies characteristics for a resource.

ResourceInformationIssueDate

The date and time when the ResourceInformation was issued.

(sequence)

The sequence of items below is mandatory. A single instance is required.

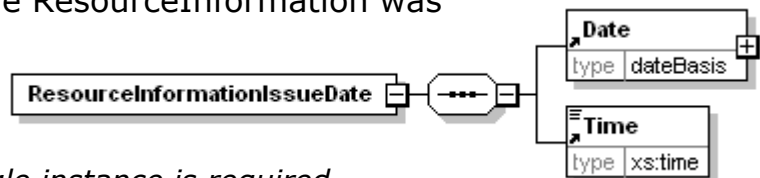

Date

Date is mandatory. A single instance is required.

A group element that contains the specification of Year, Month, and Day.

Time

Time is mandatory. A single instance is required.

Times are treated in a standard XML fashion with a special case used to indicate a generalized "local" time. The standard XML approach to time is hh:mm:ss, hh:mm:ssZ, or hh:mm:ss±hh:mm.

- hh:mm:ss±hh:mm is used to represent a time with a time zone. The time zone is communicated as the number of hours offset from the Universal Time Coordinate (UTC), a.k.a. Greenwich Mean Time.
- hh:mm:ssZ indicates the time at Zulu (another name for UTC).
- hh:mm:ss or hh:mm indicates within papiNet the applicable local time where the associated event is taking place. Caution should be used when processing times of this nature as the papiNet approach may be in discord with other users of XML.

ResourceInformationNumber

An element that contains the unique identifying number of the ResourceInformation.

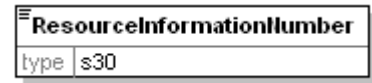

ResourceIntroductionDate

This is the date when the resource has been taken in use in the specific company.

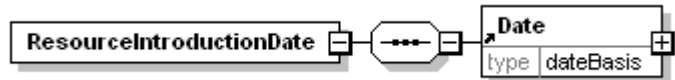

(sequence)

The sequence of items below is mandatory. A single instance is required.

Date

Date is mandatory. A single instance is required.

A group element that contains the specification of Year, Month, and Day.

ResourcePropertyValue

A group item that specifies a value for a property of a resource.

(sequence)

The sequence of items below is mandatory. A single instance is required.

PropertyCode

PropertyCode is mandatory.

A single instance is required.

A code defining a property specified by an Agency.

PropertyDescription

PropertyDescription is optional. Multiple instances might exist.

An element used to communicate a human readable description of the property.

(choice)

Choice is mandatory. A single instance is required.

BinaryValue

BinaryValue is mandatory. A single instance is required.

A value in base-64-encoded binary format.

BooleanValue

BooleanValue is mandatory. A single instance is required.

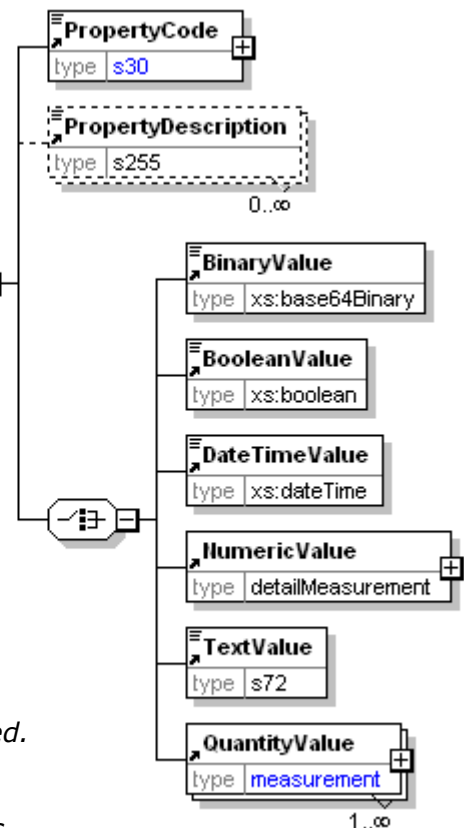

A value in boolean format.

DateTimeValue

DateTimeValue is mandatory. A single instance is required.

A Date and Time value in the standard W3C xs:dateTime format.

NumericValue

NumericValue is mandatory. A single instance is required.

A grouping element for a numeric value and its statistical measures.

TextValue

TextValue is mandatory. A single instance is required.

A value in text format.

QuantityValue

QuantityValue is mandatory. One instance is required, multiple instances might exist.

The QuantityValue element contains attributes that provide information about the type of quantity that is being communicated, the context in which the particular quantity is to be viewed, and (if the quantity represents an adjustment) an adjustment type.

The QuantityValue element contains three child elements that enable you to communicate a range of values for the quantity and a target or actual value. It is at this level (Value, RangeMin, and RangeMax) that the unit of measure is specified. This permits the range to be specified in a different unit of measure than the target.

ResourceReference

An element detailing relevant references pertaining to the resource as indicated by the attribute

ResourceReferenceType and AssignedBy.

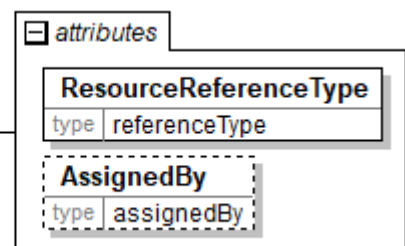
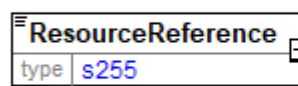

ResourceReferenceType [attribute]

ResourceReferenceType is mandatory. A single instance is required.

Provides a contextual explanation of the specific reference identifier. Many items are currently prefixed by "Buyer", "Forwarder", "Manufacturer", "Mill", "Seller", "Supplier", "Warehouse", or "Vendor". Check for an existing non-prefixed version and use the non-prefixed version instead. In the (yet to be announced release date) version 3.0 the prefixed versions will be removed. Instead the attribute @AssignedBy will communicate the information previously communicated in the prefix.

Refer to ResourceReferenceType definition for any enumerations.

AssignedBy [attribute]

AssignedBy is optional. A single instance might exist.

Identifies the type of party or the agency that has assigned the associated item, e.g. a reference of type OrderNumber.

Refer to AssignedBy for any enumerations.

ResourceReferenceIDInfo

A group item that binds a referenced resource to another resource. Attribute ResourceReferenceIDType describes the relationship of the referenced resource to another resource.

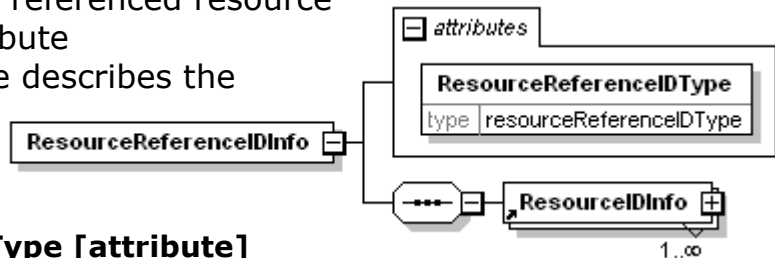

ResourceReferenceIDType [attribute]

ResourceReferenceIDType is mandatory. A single instance is required.

Defines the relationship of the referenced resource to another resource.

Refer to ResourceReferenceIDType definition for any enumerations.

(sequence)

The sequence of items below is mandatory. A single instance is required.

ResourceIDInfo

ResourceIDInfo is mandatory. One instance is required. Multiple instances might exist.

A group item that defines an identifier for a resource.

ResourceReferenceIDType [attribute]

Defines the relationship of the referenced resource to another resource.

This item is restricted to the following list.

Child

The referenced resource is attached to the actual resource. For example a referenced weight scale is connected to a specific truck.

Parent

The actual resource is attached to the referenced resource. For example a weight scale is connected to a specific referenced truck.

Unknown

The relationship is not known or not relevant.

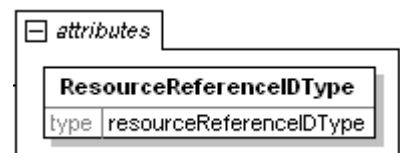

ResourceReferenceType [attribute]

Provides a contextual explanation of the specific reference identifier. Many items are currently prefixed by "Buyer", "Forwarder", "Manufacturer", "Mill", "Seller", "Supplier", "Warehouse" or "Vendor". Check for an existing non-prefixed version and use the non-prefixed version instead. In the (yet to be

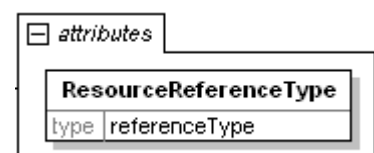

announced release date) version 3.0 the prefixed versions will be removed. Instead the attribute AssignedBy will communicate the information previously communicated in the prefix.

Refer to the [referenceType](#) entry for the list of enumerations and their definitions.

ResourceShiftCode

A code defining working shifts for a resource specified by an Agency.

Agency [attribute]

Agency is mandatory. A single instance is required.

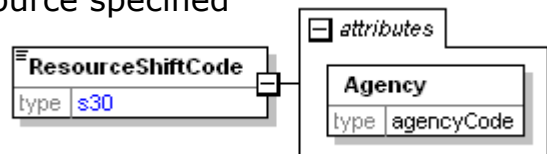

Describes the agency maintaining the list of codes. To be included in this list the agency must be a recognized standards body or industry organisation.

- For the element that owns this attribute.
- For another attribute in the list of attributes associated with the parent element.

Refer to Agency definition for any enumerations.

ResourceShiftDescription

An element used to communicate a human readable description of the used working shifts for a resource.

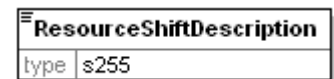

ResourceShiftInformation

A group item defining working shift structure of the resource.

(sequence)

The sequence of items below is mandatory. A single instance is required

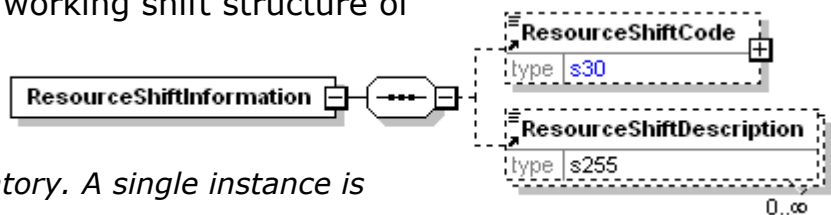

ResourceShiftCode

ResourceShiftCode is optional. A single instance might exist.

A code defining working shifts for a resource specified by an Agency.

ResourceShiftDescription

ResourceShiftDescription is optional. Multiple instances might exist.

An element used to communicate a human readable description of the used working shifts for a resource.

ResourceTypeCode

A code specifying the type of a resource. The ResourceCode is defined by an Agency.

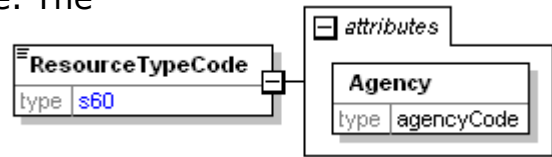

Agency [attribute]

Agency is mandatory. A single instance is required.

Describes the agency maintaining the list of codes. To be included in this list the agency must be a recognized standards body or industry organisation.

- For the element that owns this attribute.
- For another attribute in the list of attributes associated with the parent element.

Refer to Agency definition for any enumerations.

ResourceTypeDescription

An element used to communicate a human readable description for the type of a resource.

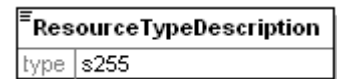

RespondByDate

The date that a response to the query if required.

(sequence)

The sequence of items below is mandatory. A single instance is required.

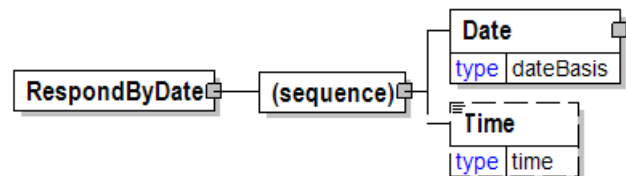

Date

Date is mandatory. A single instance is required.

A group element that contains the specification of Year, Month, and Day.

Time

Time is optional. A single instance might exist.

Times are treated in a standard XML fashion with a special case used to indicate a generalized "local" time. The standard XML approach to time is hh:mm:ss, hh:mm:ssZ, or hh:mm:ss±hh:mm.

hh:mm:ss±hh:mm is used to represent a time with a time zone. The time zone is communicated as the number of hours offset from the Universal Time Coordinate (UTC), a.k.a. Greenwich Mean Time.

hh:mm:ssZ indicates the time at Zulu (another name for UTC).

hh:mm:ss or hh:mm indicates within papiNet the applicable local time where the associated event is taking place. Caution should be used when processing times of this nature as the papiNet approach may be in discord with other users of XML.

RespondToParty

The party the document should be responded to.

PartyType [attribute]

PartyType is mandatory. A single instance is required.

Identifies the business role associated with the particular party

Refer to PartyType definition for any enumerations.

LogisticsRole [attribute]

LogisticsRole is optional. A single instance might exist.

Communicates the nature of the logistics role, if any, the party plays in the transaction.

Refer to LogisticsRole definition for any enumerations.

(sequence)

The sequence of items below is mandatory. A single instance is required.

PartyIdentifier

PartyIdentifier is optional. Multiple instances might exist.

A unique identifier of a specific party. This element contains an attribute PartyIdentifierType that indicates the type of the identifier.

NameAddress

NameAddress is mandatory. A single instance is required.

A group item containing name and address of an organisation or business entity.

URL

URL is optional. A single instance might exist.

Universal Resource Locator. While typically a web address you could use this field to hold an email address.

CommonContact

CommonContact is optional. Multiple instances might exist.

Identifies a specific individual associated with the party.

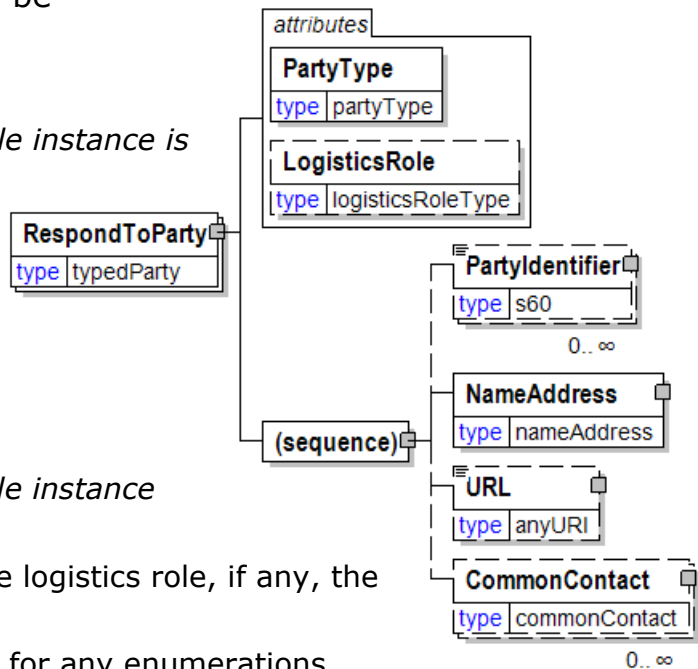

ResultSource [attribute]

Used to define the data source of the specified test

This item is restricted to the following list.

AutoLab

The data that gave rise to the value reported for this test came from an automated laboratory testing device.

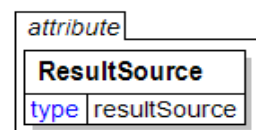

Calculated

ManualLab

The data that gave rise to the value reported for this test came from a manually performed laboratory test.

OnMachine

The data that gave rise to the value reported for this test came from an on-machine scanning device.

Predicted

The value indicated for this test is a target value and not the result of performing a paper test

ReturnReason

A group item containing the reason for the Return

ReturnType [attribute]

ReturnType is optional. A single instance might exist.

Specifies the type of return.

This item is restricted to the following list:

ReturnFromBuyer

Product was returned from the Buyer

ReturnFromShipper

Product was returned from the Shipper

ReturnFromThirdParty

Product was returned from an end user

(sequence)

The sequence of items below is mandatory. A single instance is required.

ReturnReasonCode

ReturnReasonCode is optional. A single instance might exist.

A code for quickly communicating the type of Return Reason. The Agency responsible for the code is associated with the element.

ReturnReasonDescription

ReturnReasonDescription is optional. Multiple instances might exist.

A text field element describing the reason for the Return.

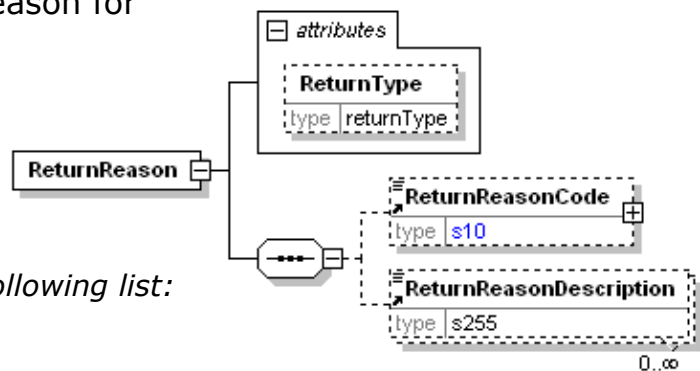

ReturnReasonCode

A code for quickly communicating the type of Return Reason. The Agency responsible for the code is associated with the element.

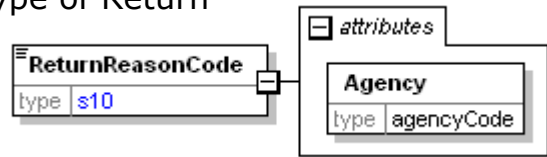

Agency [attribute]

Agency is mandatory. A single instance is required.

Describes the agency maintaining the list of codes. To be included in this list the agency must be a recognized standards body or industry organisation.

- For the element that owns this attribute.
- For another attribute in the list of attributes associated with the parent element.

Refer to Agency definition for any enumerations.

ReturnReasonDescription

A text field element describing the reason for the Return.

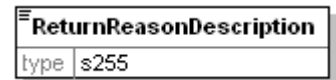

ReturnType [attribute]

Specifies the type of return.

This item is restricted to the following list.

ReturnFromBuyer

Product was returned from the Buyer

ReturnFromShipper

Product was returned from the Shipper

ReturnFromThirdParty

Product was returned from an end user

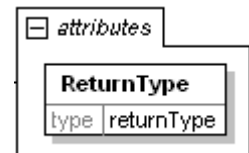

RewoundIndicator [attribute]

Is the date being communicated the the rewind date (Yes) or the date of original winding (No)?

This item is restricted to the following list.

Yes

No

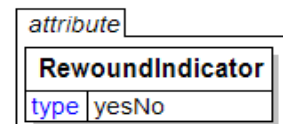

RFQ

The RFQ element is the root element for the RFQ e-Document.

A buyer sends an RFQ e-Document to a supplier to initiate a request for quotation. This e-Document, which is a request for product information, represents a request for the supplier to provide a quotation for product availability, shipping, and price.

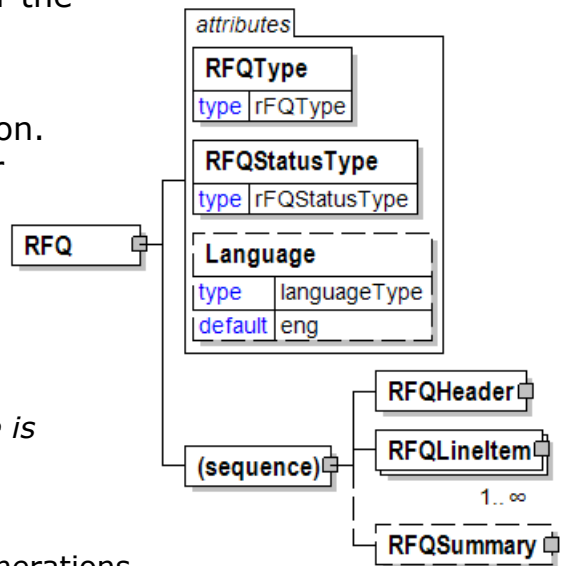

RFQType [attribute]

RFQType is mandatory. A single instance is required.

Defines the type of RFQ issued.

Refer to RFQType definition for any enumerations.

RFQStatusType [attribute]

RFQStatusType is mandatory. A single instance is required.

This attribute acts as a flag indicating what processing may be required.

Refer to RFQStatusType definition for any enumerations.

Language [attribute]

Language is optional. A single instance might exist.

The valid Alpha 2- and Alpha 3-character list of language codes in the ISO 639-1 and 639-2 international standards.

Information on the content of this attribute is available at:
https://www.loc.gov/standards/iso639-2/php/code_list.php

(sequence)

The sequence of items below is mandatory. A single instance is required.

RFQHeader

RFQHeader is mandatory. A single instance is required.

A group item containing information applicable to the entire RFQ e-Document.

RFQLineItem

RFQLineItem is mandatory. One instance is required, multiple instances might exist.

The repetitive detail for the RFQ e-Document.

RFQSummary

RFQSummary is optional. A single instance might exist.

Summary information that applies to the RFQ e-Document.

The organisation or business entity responsible for providing the product. SupplierParty is also the seller of the product, if Seller is not specified as OtherParty = Seller.

OtherParty

OtherParty is optional. Multiple instances might exist.

An organisation or business entity other than those specifically detailed within an e-Document.

SenderParty

SenderParty is optional. A single instance might exist.

The business entity issuing the e-Document, the source of the document.

The entity responsible for the content. If the sender party has out sourced the message service to a third party the SenderParty is the issuer of the e-Document and not the party performing the transmission service of the electronic message.

ReceiverParty

ReceiverParty is optional. Multiple instances might exist.

The business entity for whom the e-Document is intended, the destination of the document.

The entity interested in the content. If the receiver party has outsourced the message service to a third party the ReceiverParty is the intended party for the e-Document and not the party performing the receiving service of the electronic message.

ShipToCharacteristics

ShipToCharacteristics is optional. A single instance might exist.

A group item that provides information important for the Ship-To Party.

TransportModeCharacteristics

TransportModeCharacteristics is optional. A single instance might exist.

A group item defining the primary mode of transport.

TransportVehicleCharacteristics

TransportVehicleCharacteristics is optional. A single instance might exist.

A group item containing information about a transport vehicle, e.g. a truck. A transport vehicle has its own power and can be used to pull, push, carry, or tow a transport unit loaded with goods.

TransportUnitCharacteristics

TransportUnitCharacteristics is optional. A single instance might exist.

A group item containing information about a transport unit, e.g. a trailer. Transport units contain goods and move using power from another source, the transport vehicle.

TransportLoadingCharacteristics

TransportLoadingCharacteristics is optional. A single instance might exist.

A group item defining how the transported items are to be loaded.

TransportUnloadingCharacteristics

TransportUnloadingCharacteristics is optional. A single instance might exist.

A group item defining how the transported items are to be unloaded.

TransportOtherInstructions

TransportOtherInstructions is optional. A single instance might exist.

A group item defining any other instructions for the transport not covered in the description of transport mode, vehicle, unit, and loading characteristics or defining an alternative description for the categories mentioned above.

TermsOfPayment

TermsOfPayment is optional. Multiple instances might exist.

A group item that contains agreed-to terms defining when, how, and under what conditions the payment is to be made.

When TermsOfPayment is optional; if omitted, TermsOfPayment is controlled through previous negotiation.

AdditionalText

AdditionalText is optional. Multiple instances might exist.

A text field that is used to communicate information not previously defined or for special instructions. To be used only for circumstances not covered by specific elements.

RFQHeaderStatusType [attribute]

Defines the status of the RFQ header

This item is restricted to the following list.



Accepted

The supplied information is accepted.

Amended

The supplied information is changed.

Cancelled

The supplied information has been cancelled. Items that have been cancelled are not included in totals on the summary levels of the e-Document.

New

The supplied information is new and supplied for the first time.

NoAction

The supplied information has not been amended and thereby requires no action.

RFQInformation

A group item containing information unique to this RFQ which is provided by the buyer.

(sequence)

The sequence of items below is mandatory. A single instance is required.

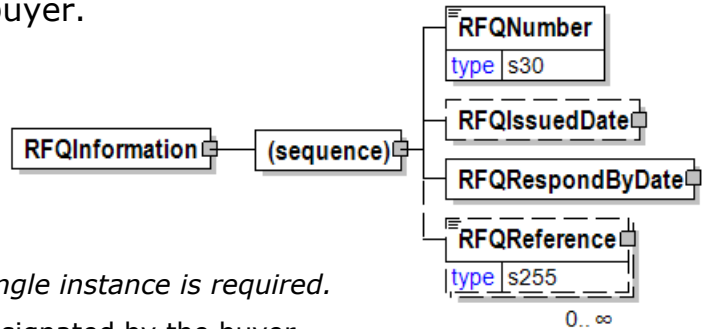

RFQNumber

RFQNumber is mandatory. A single instance is required.

The unique RFQ identifier as designated by the buyer.

RFQIssuedDate

RFQIssuedDate is optional. A single instance might exist.

The Date and Time the RFQ was issued.

RFQRespondByDate

RFQRespondByDate is mandatory. A single instance is required.

The Date and Time by which a response needs to be received by the RFQ issuer.

RFQReference

RFQReference is optional. Multiple instances might exist.

A repeatable element that details the relevant references (such as contract number) pertaining to the RFQ. The RFQReference is defined by RFQReferenceType.

RFQIssuedDate

The Date and Time the RFQ was issued.

(sequence)

The sequence of items below is mandatory. A single instance is required.

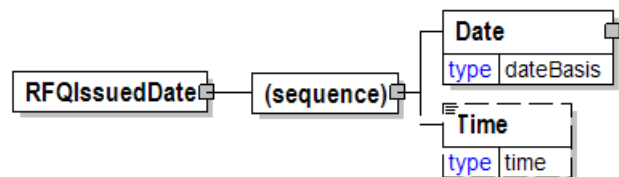

Date

Date is mandatory. A single instance is required.

A group element that contains the specification of Year, Month, and Day.

Time

Time is optional. A single instance might exist.

Times are treated in a standard XML fashion with a special case used to indicate a generalized "local" time. The standard XML approach to time is hh:mm:ss, hh:mm:ssZ, or hh:mm:ss±hh:mm.

hh:mm:ss±hh:mm is used to represent a time with a time zone. The time zone is communicated as the number of hours offset from the Universal Time Coordinate (UTC), a.k.a. Greenwich Mean Time.

hh:mm:ssZ indicates the time at Zulu (another name for UTC).

hh:mm:ss or hh:mm indicates within papiNet the applicable local time where the associated event is taking place. Caution should be used when processing

times of this nature as the papiNet approach may be in discord with other users of XML.

RFQLineItem

The repetitive detail for the RFQ e-Document.

RFQLineItemStatusType [attribute]

RFQLineItemStatusType is mandatory. A single instance is required.

Defines the status of the RFQ line item

Refer to RFQLineItemStatusType definition for any enumerations.

RFQLineItemDocumentStatus [attribute]

RFQLineItemDocumentStatus is optional. A single instance might exist.

Defines the actual document status for the RFQLineItem.

Refer to RFQLineItemDocumentStatus definition for any enumerations.

(sequence)

The sequence of items below is mandatory. A single instance is required.

RFQLineItemNumber

RFQLineItemNumber is mandatory. A single instance is required.

A sequential number that uniquely identifies the RFQ line item.

RFQReference

RFQReference is optional. Multiple instances might exist.

A repeatable element that details the relevant references (such as contract number) pertaining to the RFQ. The RFQReference is defined by RFQReferenceType.

Product

Product is mandatory. A single instance is required.

Product is a group item defining the article and its characteristics. Product is used to specify product characteristics organized by ProductIdentifier,

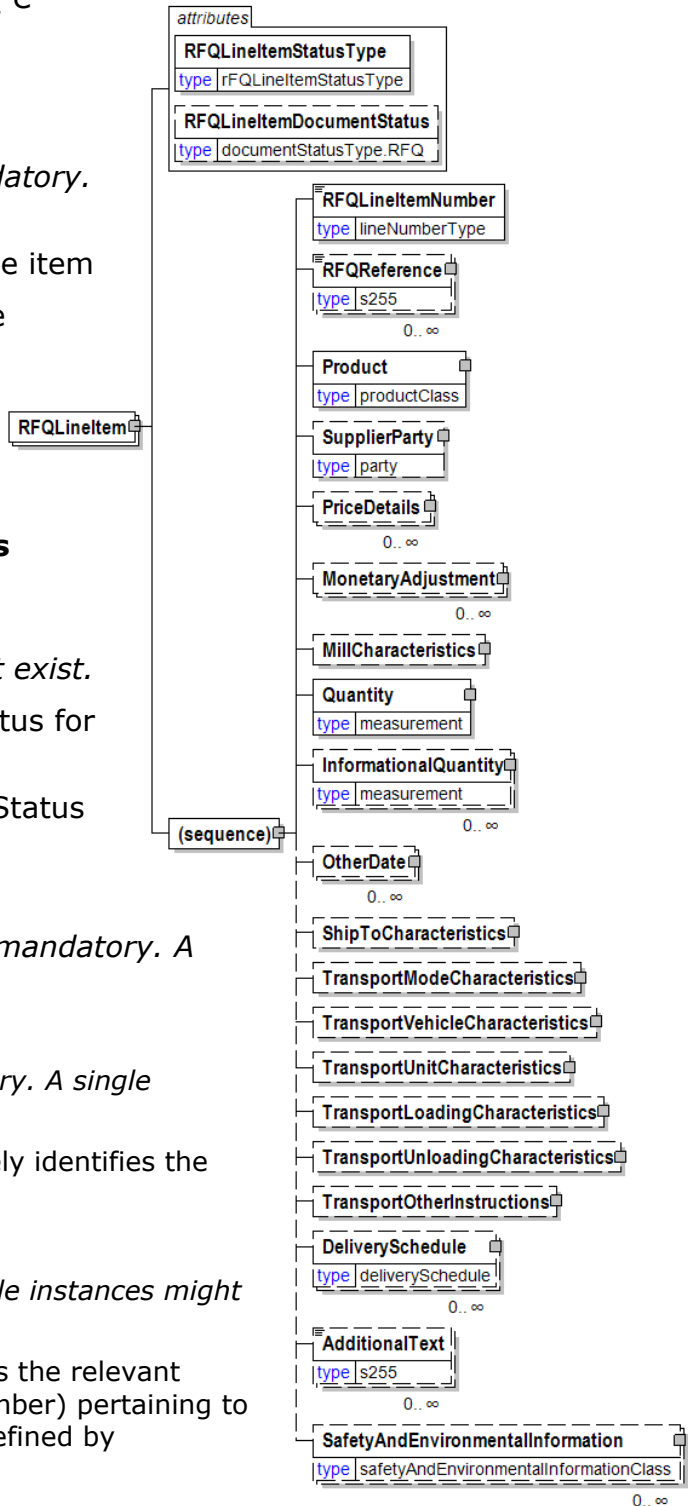

ProductDescription, and Classification. Book Manufacturing, Label Stock, Paper, Pulp, Recovered Paper, Wood Products, and Virgin Fibre market segments have defined their product characteristics and conversion features for implementation in papiNet.

SupplierParty

SupplierParty is optional. A single instance might exist.

The organisation or business entity responsible for providing the product. SupplierParty is also the seller of the product, if Seller is not specified as OtherParty = Seller.

PriceDetails

PriceDetails is optional. Multiple instances might exist.

An element that groups together price information.

MonetaryAdjustment

MonetaryAdjustment is optional. Multiple instances might exist.

The element containing the information necessary for the understanding, calculation, and treatment of an adjustment to a currency amount. MonetaryAdjustment contains an attribute that indicates the type of adjustment being communicated.

MillCharacteristics

MillCharacteristics is optional. A single instance might exist.

A group item defining the mill party and machine identifier where a product is or was produced.

Quantity

Quantity is mandatory. A single instance is required.

The Quantity element contains attributes that provide information about the type of quantity that is being communicated, the context in which the particular quantity is to be viewed, and (if the quantity represents an adjustment) an adjustment type.

The Quantity element contains three child elements that enable you to communicate a range of values for the quantity and a target or actual value. It is at this level (Value, RangeMin, and RangeMax) that the unit of measure is specified. This permits the range to be specified in a different unit of measure than the target.

InformationalQuantity

InformationalQuantity is optional. Multiple instances might exist.

A quantity given in a valid UOM used for information purposes only (not for calculation). For example, an ordered quantity was 100 reels as opposed to the invoice quantity of 20,000 pounds.

OtherDate

OtherDate is optional. Multiple instances might exist.

A date that may not be specifically detailed within a document (example: print date at the PurchaseOrderLineItem).

ShipToCharacteristics

ShipToCharacteristics is optional. A single instance might exist.

A group item that provides information important for the Ship-To Party.

TransportModeCharacteristics

TransportModeCharacteristics is optional. A single instance might exist.

A group item defining the primary mode of transport.

TransportVehicleCharacteristics

TransportVehicleCharacteristics is optional. A single instance might exist.

A group item containing information about a transport vehicle, e.g. a truck. A transport vehicle has its own power and can be used to pull, push, carry, or tow a transport unit loaded with goods.

TransportUnitCharacteristics

TransportUnitCharacteristics is optional. A single instance might exist.

A group item containing information about a transport unit, e.g. a trailer. Transport units contain goods and move using power from another source, the transport vehicle.

TransportLoadingCharacteristics

TransportLoadingCharacteristics is optional. A single instance might exist.

A group item defining how the transported items are to be loaded.

TransportUnloadingCharacteristics

TransportUnloadingCharacteristics is optional. A single instance might exist.

A group item defining how the transported items are to be unloaded.

TransportOtherInstructions

TransportOtherInstructions is optional. A single instance might exist.

A group item defining any other instructions for the transport not covered in the description of transport mode, vehicle, unit, and loading characteristics or defining an alternative description for the categories mentioned above.

DeliverySchedule

DeliverySchedule is optional. Multiple instances might exist.

A group item defining a series of DeliveryDateWindow(s) in which specified quantities must be delivered.

AdditionalText

AdditionalText is optional. Multiple instances might exist.

A text field that is used to communicate information not previously defined or for special instructions. To be used only for circumstances not covered by specific elements.

SafetyAndEnvironmentalInformation

SafetyAndEnvironmentalInformation is optional. Multiple instances might exist.

Name of certification type, if any, on the goods (For example, FSC, PEFC). SafetyAndEnvironmental needs a value or measurement to communicate the percentage of the product is certified (for example, 75% is certified by the indicated agency).

RFQLineItemDocumentStatus [attribute]

Defines the actual document status for the RFQLineItem.

This item is restricted to the following list.

Cancelled

The supplied information of the document item is cancelled. Items that have been cancelled are not included in totals on the summary level of e-Documents.

Requested

The supplied information of the document item is ordered.

attribute
RFQLineItemDocumentStatus
type documentStatusType.RFQ

RFQLineItemNumber

A sequential number that uniquely identifies the RFQ line item.

RFQLineItemNumber
type lineNumberType

RFQLineItemStatusType [attribute]

Defines the status of the RFQ line item

This item is restricted to the following list.

Accepted

The supplied information is accepted.

Amended

The supplied information is changed.

Cancelled

The supplied information has been cancelled. Items that have been cancelled are not included in totals on the summary levels of the e-Document.

New

The supplied information is new and supplied for the first time.

NoAction

The supplied information has not been amended and thereby requires no action.

attribute
RFQLineItemStatusType
type rFQLineItemStatusType

RFQNumber

The unique RFQ identifier as designated by the buyer.

RFQNumber
type s30

RFQReference

A repeatable element that details the relevant references (such as contract number) pertaining to the RFQ. The RFQReference is defined by RFQReferenceType.

RFQReferenceType [attribute]

RFQReferenceType is mandatory. A single instance is required.

Provides a contextual explanation of the specific reference identifier. Many items are currently prefixed by "Buyer", "Forwarder", "Manufacturer", "Mill", "Seller", "Supplier", "Warehouse", or "Vendor". Check for an existing non-prefixed version and use the non-prefixed version instead. In the (yet to be announced release date) version 3.0 the prefixed versions will be removed. Instead the attribute @AssignedBy will communicate the information previously communicated in the prefix.

Refer to RFQReferenceType definition for any enumerations.

AssignedBy [attribute]

AssignedBy is optional. A single instance might exist.

Identifies the type of party or the agency that has assigned the associated item, e.g. a reference of type OrderNumber.

Refer to AssignedBy for any enumerations.

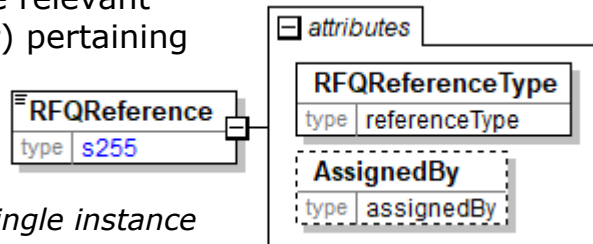

RFQReferenceType [attribute]

Provides a contextual explanation of the specific reference identifier. Many items are currently prefixed by "Buyer", "Forwarder", "Manufacturer", "Mill", "Seller", "Supplier", "Warehouse", or "Vendor". Check for an existing non-prefixed version and use the non-prefixed version instead. In the (yet to be announced release date) version 3.0 the prefixed versions will be removed. Instead the attribute @AssignedBy will communicate the information previously communicated in the prefix.

Refer to the [referenceType](#) entry for the list of enumerations and their definitions.

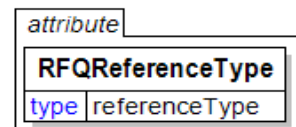

RFQRespondByDate

The Date and Time by which a response needs to be received by the RFQ issuer.

(sequence)

The sequence of items below is mandatory. A single instance is required.

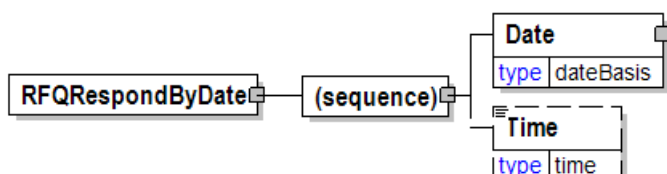

papiNet V2R31

Date

Date is mandatory. A single instance is required.

A group element that contains the specification of Year, Month, and Day.

Time

Time is optional. A single instance might exist.

Times are treated in a standard XML fashion with a special case used to indicate a generalized "local" time. The standard XML approach to time is hh:mm:ss, hh:mm:ssZ, or hh:mm:ss±hh:mm.

hh:mm:ss±hh:mm is used to represent a time with a time zone. The time zone is communicated as the number of hours offset from the Universal Time Coordinate (UTC), a.k.a. Greenwich Mean Time.

hh:mm:ssZ indicates the time at Zulu (another name for UTC).

hh:mm:ss or hh:mm indicates within papiNet the applicable local time where the associated event is taking place. Caution should be used when processing times of this nature as the papiNet approach may be in discord with other users of XML.

RFQResponse

The RFQResponse element is the root element for the RFQResponse e-Document.

A supplier sends an RFQResponse e-Document to a buyer as a response to an RFQ e-Document from the buyer. The e-Document specifies a quotation for product availability, shipping, and price.

RFQResponse

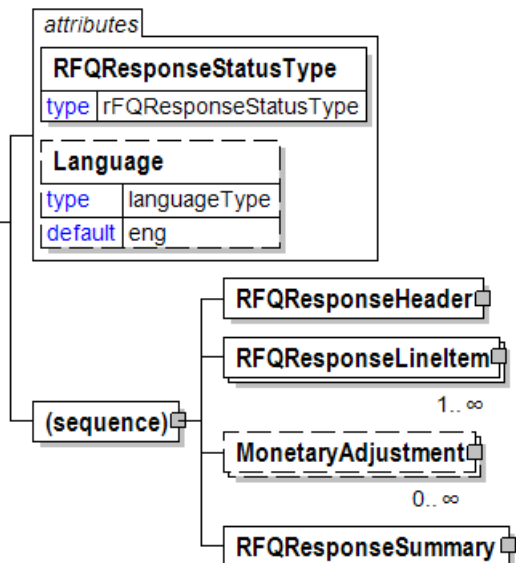

RFQResponseStatusType [attribute]

RFQResponseStatusType is mandatory. A single instance is required.

This attribute acts as a flag indicating what processing may be required.

Refer to RFQResponseStatusType definition for any enumerations.

Language [attribute]

Language is optional. A single instance might exist.

The valid Alpha 2- and Alpha 3-character list of language codes in the ISO 639-1 and 639-2 international standards.

Information on the content of this attribute is available at:
https://www.loc.gov/standards/iso639-2/php/code_list.php

(sequence)

The sequence of items below is mandatory. A single instance is required.

RFQResponseHeader

papiNet V2R31

RFQResponseHeader is mandatory. A single instance is required.

Information that pertains to the entire RFQResponse.

RFQResponseLineItem

RFQResponseLineItem is mandatory. One instance is required, multiple instances might exist.

A group element that contains the response details provided by the party responding to the RFQ.

MonetaryAdjustment

MonetaryAdjustment is optional. Multiple instances might exist.

The element containing the information necessary for the understanding, calculation, and treatment of an adjustment to a currency amount. MonetaryAdjustment contains an attribute that indicates the type of adjustment being communicated.

RFQResponseSummary

RFQResponseSummary is mandatory. A single instance is required.

A group element that contains information that summarizes the contents of the RFQResponse.

RFQResponseHeader

Information that pertains to the entire RFQResponse.

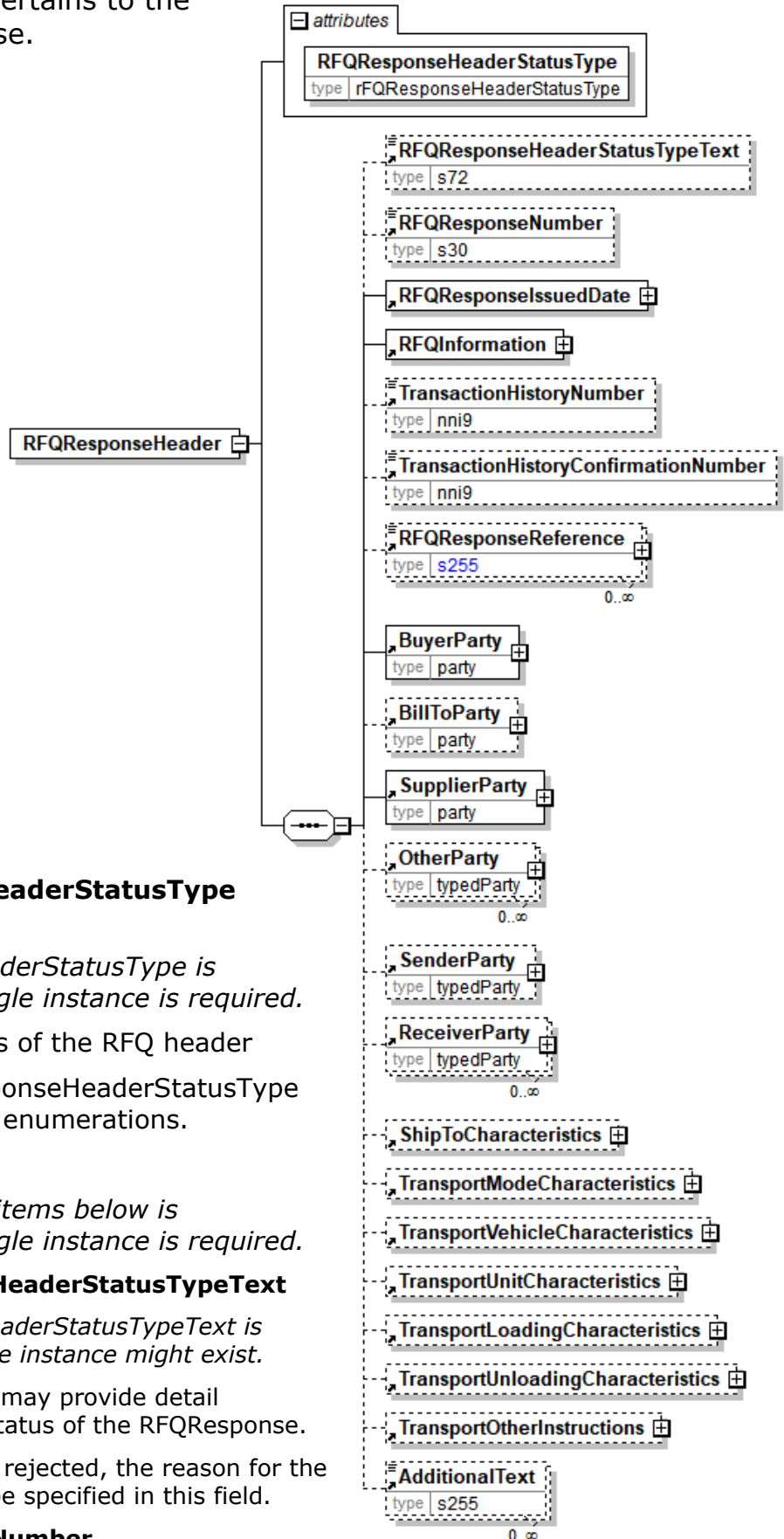

RFQResponseHeaderStatusType [attribute]

RFQResponseHeaderStatusType is mandatory. A single instance is required.

Defines the status of the RFQ header

Refer to RFQResponseHeaderStatusType definition for any enumerations.

(sequence)

The sequence of items below is mandatory. A single instance is required.

RFQResponseHeaderStatusTypeText

RFQResponseHeaderStatusTypeText is optional. A single instance might exist.

A text field that may provide detail explaining the status of the RFQResponse.

When an RFQ is rejected, the reason for the rejection must be specified in this field.

RFQResponseNumber

RFQResponseNumber is optional. A single instance might exist.

The identifying number of the RFQResponse.

RFQResponseIssuedDate

RFQResponseIssuedDate is mandatory. A single instance is required.

The Date and Time when the response to the RFQResponse was issued.

RFQInformation

RFQInformation is mandatory. A single instance is required.

A group item containing information unique to this RFQ which is provided by the buyer.

TransactionHistoryNumber

TransactionHistoryNumber is optional. A single instance might exist.

A sequential number that keeps track of the version of a document.

However when the document is a confirmation document, in which case the TransactionHistoryNumber refers to the trigger transaction for the confirmation.

TransactionHistoryConfirmationNumber

TransactionHistoryConfirmationNumber is optional. A single instance might exist.

A sequential number that keeps track the version of a confirmation document.

When the document is a confirmation document, then the TransactionHistoryNumber refers to the trigger transaction for the confirmation.

RFQResponseReference

RFQResponseReference is optional. Multiple instances might exist.

An element that details the relevant references (such as contract number) pertaining to the RFQResponse. RFQResponseReferenceType indicates what type of reference is being communicated.

BuyerParty

BuyerParty is mandatory. A single instance is required.

The legal entity to which the product is sold. Also commonly referred to as the sold-to party or customer. If no OtherParty is defined as the Payer, the Buyer is the Payer.

BillToParty

BillToParty is optional. A single instance might exist.

The address where the invoice is to be sent.

SupplierParty

SupplierParty is mandatory. A single instance is required.

The organisation or business entity responsible for providing the product. SupplierParty is also the seller of the product, if Seller is not specified as OtherParty = Seller.

OtherParty

OtherParty is optional. Multiple instances might exist.

An organisation or business entity other than those specifically detailed within an e-Document.

SenderParty

SenderParty is optional. A single instance might exist.

The business entity issuing the e-Document, the source of the document.

The entity responsible for the content. If the sender party has out sourced the message service to a third party the SenderParty is the issuer of the e-Document and not the party performing the transmission service of the electronic message.

ReceiverParty

ReceiverParty is optional. Multiple instances might exist.

The business entity for whom the e-Document is intended, the destination of the document.

The entity interested in the content. If the receiver party has outsourced the message service to a third party the ReceiverParty is the intended party for the e-Document and not the party performing the receiving service of the electronic message.

ShipToCharacteristics

ShipToCharacteristics is optional. A single instance might exist.

A group item that provides information important for the Ship-To Party.

TransportModeCharacteristics

TransportModeCharacteristics is optional. A single instance might exist.

A group item defining the primary mode of transport.

TransportVehicleCharacteristics

TransportVehicleCharacteristics is optional. A single instance might exist.

A group item containing information about a transport vehicle, e.g. a truck. A transport vehicle has its own power and can be used to pull, push, carry, or tow a transport unit loaded with goods.

TransportUnitCharacteristics

TransportUnitCharacteristics is optional. A single instance might exist.

A group item containing information about a transport unit, e.g. a trailer. Transport units contain goods and move using power from another source, the transport vehicle.

TransportLoadingCharacteristics

TransportLoadingCharacteristics is optional. A single instance might exist.

A group item defining how the transported items are to be loaded.

TransportUnloadingCharacteristics

TransportUnloadingCharacteristics is optional. A single instance might exist.

A group item defining how the transported items are to be unloaded.

TransportOtherInstructions

TransportOtherInstructions is optional. A single instance might exist.

A group item defining any other instructions for the transport not covered in the description of transport mode, vehicle, unit, and loading characteristics or defining an alternative description for the categories mentioned above.

AdditionalText

AdditionalText is optional. Multiple instances might exist.

A text field that is used to communicate information not previously defined or for special instructions. To be used only for circumstances not covered by specific

elements.

RFQResponseHeaderStatusType [attribute]

Defines the status of the RFQ header

This item is restricted to the following list.

Accepted

The supplied information is accepted.

Amended

The supplied information is changed

Counterproposal

The sender is presenting a different proposal.

NoAction

The supplied information has not been amended and thereby requires no action.

Pending

The supplied information is not complete and will be updated later.

Rejected

The supplied information is rejected.

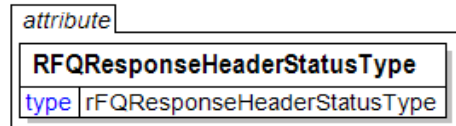

RFQResponseHeaderStatusTypeText

A text field that may provide detail explaining the status of the RFQResponse.

When an RFQ is rejected, the reason for the rejection must be specified in this field.

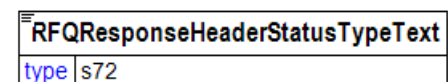

RFQResponseIssuedDate

The Date and Time when the response to the RFQResponse was issued.

(sequence)

The sequence of items below is mandatory. A single instance is required.

Date

Date is mandatory. A single instance is required.

A group element that contains the specification of Year, Month, and Day.

Time

Time is optional. A single instance might exist.

Times are treated in a standard XML fashion with a special case used to indicate a

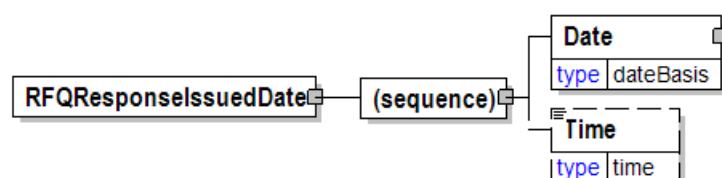

papiNet V2R31

generalized "local" time. The standard XML approach to time is hh:mm:ss, hh:mm:ssZ, or hh:mm:ss±hh:mm.

hh:mm:ss±hh:mm is used to represent a time with a time zone. The time zone is communicated as the number of hours offset from the Universal Time Coordinate (UTC), a.k.a. Greenwich Mean Time.

hh:mm:ssZ indicates the time at Zulu (another name for UTC).

hh:mm:ss or hh:mm indicates within papiNet the applicable local time where the associated event is taking place. Caution should be used when processing times of this nature as the papiNet approach may be in discord with other users of XML.

RFQResponseLineItem

A group element that contains the response details provided by the party responding to the RFQ.

RFQResponseLineItemStatusType [attribute]

RFQResponseLineItemStatusType is mandatory. A single instance is required.

RFQResponse Line Item Status Type

Refer to RFQResponseLineItemStatusType definition for any enumerations.

RFQResponseLineItemDocumentStatus [attribute]

RFQResponseLineItemDocumentStatus is optional. A single instance might exist.

Defines the actual document status for the RFQResponseLineItem.

Refer to RFQResponseLineItemDocumentStatus definition for any enumerations.

(sequence)

The sequence of items below is mandatory. A single instance is required.

RFQResponseLineItemStatusTypeText

RFQResponseLineItemStatusTypeText is optional. A single instance might exist.

A text field that may provide detail explaining the status of the RFQResponseLineItem.

When an RFQLineItem is rejected, the reason for the rejection must be specified in this field.

RFQResponseValidityDate

RFQResponseValidityDate is mandatory. A single instance is required.

The Date and Time within which a response to the RFQ is valid.

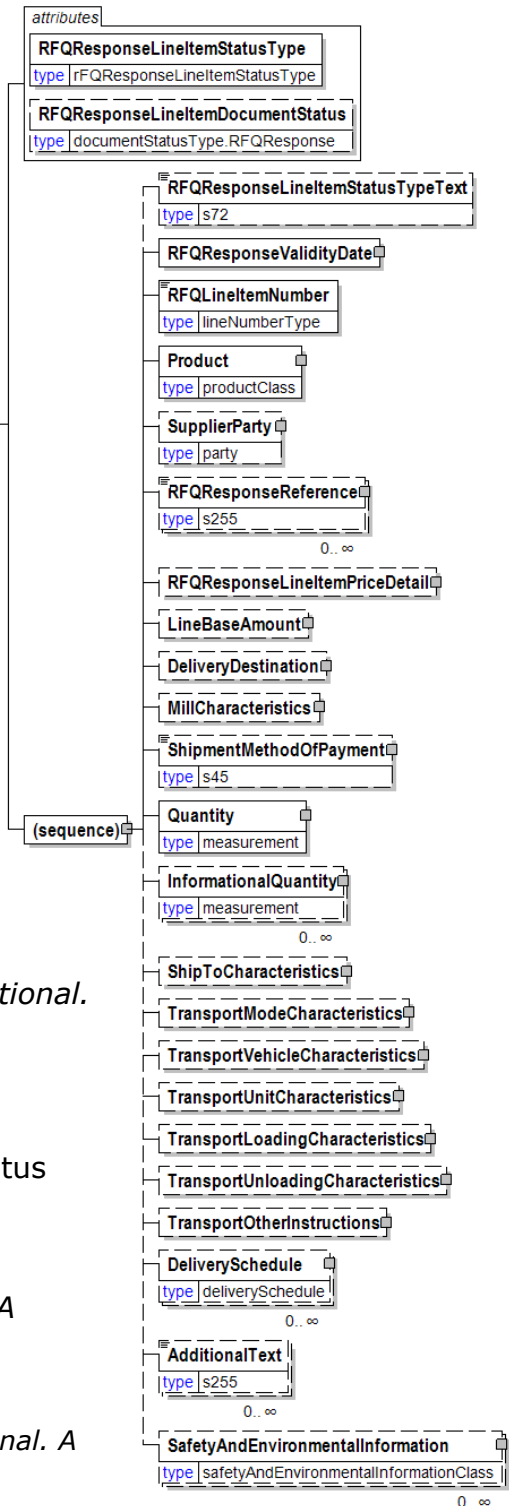

RFQLineItemNumber

RFQLineItemNumber is mandatory. A single instance is required.

A sequential number that uniquely identifies the RFQ line item.

Product

Product is mandatory. A single instance is required.

Product is a group item defining the article and its characteristics. Product is used to specify product characteristics organized by ProductIdentifier, ProductDescription, and Classification. Book Manufacturing, Label Stock, Paper, Pulp, Recovered Paper, Wood Products, and Virgin Fibre market segments have defined their product characteristics and conversion features for implementation in papiNet.

SupplierParty

SupplierParty is optional. A single instance might exist.

The organisation or business entity responsible for providing the product. SupplierParty is also the seller of the product, if Seller is not specified as OtherParty = Seller.

RFQResponseReference

RFQResponseReference is optional. Multiple instances might exist.

An element that details the relevant references (such as contract number) pertaining to the RFQResponse. RFQResponseReferenceType indicates what type of reference is being communicated.

RFQResponseLineItemPriceDetail

RFQResponseLineItemPriceDetail is optional. A single instance might exist.

The pricing information associated with the response to an RFQ.

LineBaseAmount

LineBaseAmount is optional. A single instance might exist.

For the particular e-Document being communicated the LineBaseAmount represents the quantity times the base unit price.

DeliveryDestination

DeliveryDestination is optional. A single instance might exist.

The DeliveryDestination specifies the end of one leg of the delivery. In order to comply with the US Trade Act of 2002 you would use this element with a LocationParty/@PartyType of Port.

MillCharacteristics

MillCharacteristics is optional. A single instance might exist.

A group item defining the mill party and machine identifier where a product is or was produced.

ShipmentMethodOfPayment

ShipmentMethodOfPayment is optional. A single instance might exist.

An element communicating responsibility of freight payment and when transfer of ownership will occur.

Quantity

Quantity is mandatory. A single instance is required.

The Quantity element contains attributes that provide information about the type of

quantity that is being communicated, the context in which the particular quantity is to be viewed, and (if the quantity represents an adjustment) an adjustment type.

The Quantity element contains three child elements that enable you to communicate a range of values for the quantity and a target or actual value. It is at this level (Value, RangeMin, and RangeMax) that the unit of measure is specified. This permits the range to be specified in a different unit of measure than the target.

InformationalQuantity

InformationalQuantity is optional. Multiple instances might exist.

A quantity given in a valid UOM used for information purposes only (not for calculation). For example, an ordered quantity was 100 reels as opposed to the invoice quantity of 20,000 pounds.

ShipToCharacteristics

ShipToCharacteristics is optional. A single instance might exist.

A group item that provides information important for the Ship-To Party.

TransportModeCharacteristics

TransportModeCharacteristics is optional. A single instance might exist.

A group item defining the primary mode of transport.

TransportVehicleCharacteristics

TransportVehicleCharacteristics is optional. A single instance might exist.

A group item containing information about a transport vehicle, e.g. a truck. A transport vehicle has its own power and can be used to pull, push, carry, or tow a transport unit loaded with goods.

TransportUnitCharacteristics

TransportUnitCharacteristics is optional. A single instance might exist.

A group item containing information about a transport unit, e.g. a trailer. Transport units contain goods and move using power from another source, the transport vehicle.

TransportLoadingCharacteristics

TransportLoadingCharacteristics is optional. A single instance might exist.

A group item defining how the transported items are to be loaded.

TransportUnloadingCharacteristics

TransportUnloadingCharacteristics is optional. A single instance might exist.

A group item defining how the transported items are to be unloaded.

TransportOtherInstructions

TransportOtherInstructions is optional. A single instance might exist.

A group item defining any other instructions for the transport not covered in the description of transport mode, vehicle, unit, and loading characteristics or defining an alternative description for the categories mentioned above.

DeliverySchedule

DeliverySchedule is optional. Multiple instances might exist.

A group item defining a series of DeliveryDateWindow(s) in which specified quantities must be delivered.

AdditionalText

papiNet V2R31

AdditionalText is optional. Multiple instances might exist.

A text field that is used to communicate information not previously defined or for special instructions. To be used only for circumstances not covered by specific elements.

SafetyAndEnvironmentalInformation

SafetyAndEnvironmentalInformation is optional. Multiple instances might exist.

Name of certification type, if any, on the goods (For example, FSC, PEFC). SafetyAndEnvironmental needs a value or measurement to communicate the percentage of the product is certified (for example, 75% is certified by the indicated agency).

RFQResponseLineItemDocumentStatus [attribute]

Defines the actual document status for the RFQResponseLineItem.

This item is restricted to the following list.

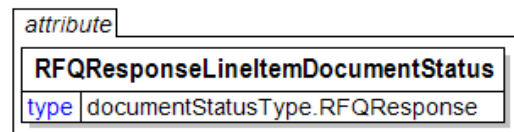

Cancelled

The supplied information of the document item is cancelled. Items that have been cancelled are not included in totals on the summary level of e-Documents.

Confirmed

The supplied information of the document item is agreed. If a requested change or cancellation of an existing document item can not be accepted, then the earlier agreed information of the document item will be re-confirmed.

Pending

The supplied information of the document item is being investigated.

Rejected

The supplied information of the document item can not be accepted. The document item is new or not earlier confirmed.

RFQResponseLineItemPriceDetail

The pricing information associated with the response to an RFQ.

(sequence)

The sequence of items below is mandatory. A single instance is required.

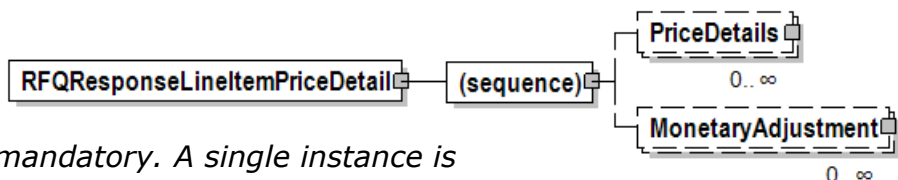

PriceDetails

PriceDetails is optional. Multiple instances might exist.

An element that groups together price information.

MonetaryAdjustment

MonetaryAdjustment is optional. Multiple instances might exist.

The element containing the information necessary for the understanding, calculation, and treatment of an adjustment to a currency amount. MonetaryAdjustment contains an attribute that indicates they type of adjustment being communicated.

RFQResponseLineItemStatusType [attribute]

RFQResponse Line Item Status Type

This item is restricted to the following list.

Accepted

The supplied information is accepted.

Amended

The supplied information is changed.

Counterproposal

The sender is presenting a different proposal.

NoAction

The supplied information has not been amended and thereby requires no action.

Pending

The supplied information is not complete and will be updated later.

Rejected

The supplied information is rejected.

attribute
RFQResponseLineItemStatusType
type rFQResponseLineItemStatusType

RFQResponseLineItemStatusTypeText

A text field that may provide detail explaining the status of the RFQResponseLineItem.

When an RFQLineItem is rejected, the reason for the rejection must be specified in this field.

RFQResponseLineItemStatusTypeText
type s72

RFQResponseNumber

The identifying number of the RFQResponse.

RFQResponseNumber
type s30

RFQResponseReference

An element that details the relevant references (such as contract number) pertaining to the RFQResponse.

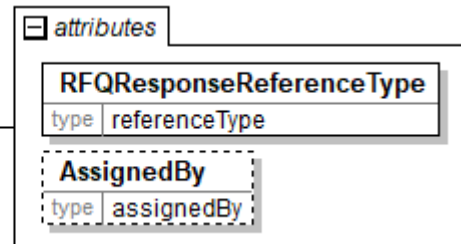

RFQResponseReferenceType indicates what type of reference is being communicated.

RFQResponseReferenceType [attribute]

RFQResponseReferenceType is mandatory. A single instance is required.

Provides a contextual explanation of the specific reference identifier. Many items are currently prefixed by "Buyer", "Forwarder", "Manufacturer", "Mill", "Seller", "Supplier", "Warehouse", or "Vendor". Check for an existing non-prefixed version and use the non-prefixed version instead. In the (yet to be announced release date) version 3.0 the prefixed versions will be removed. Instead the attribute @AssignedBy will communicate the information previously communicated in the prefix.

Refer to RFQResponseReferenceType definition for any enumerations.

AssignedBy [attribute]

AssignedBy is optional. A single instance might exist.

Identifies the type of party or the agency that has assigned the associated item, e.g. a reference of type OrderNumber.

Refer to AssignedBy for any enumerations.

RFQResponseReferenceType [attribute]

Provides a contextual explanation of the specific reference identifier. Many items are currently prefixed by "Buyer", "Forwarder", "Manufacturer", "Mill", "Seller", "Supplier", "Warehouse", or "Vendor". Check for an existing non-prefixed version and use the non-prefixed version instead. In the (yet to be announced release date) version 3.0 the prefixed versions will be removed. Instead the attribute @AssignedBy will communicate the information previously communicated in the prefix.

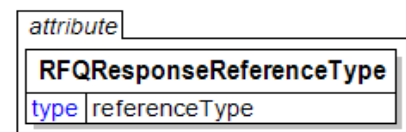

Refer to the [referenceType](#) entry for the list of enumerations and their definitions.

RFQResponseStatusType [attribute]

This attribute acts as a flag indicating what processing may be required.

This item is restricted to the following list.



Accepted

The supplied information is accepted.

Amended

The supplied information is changed.

Cancelled

The supplied information has been cancelled. Items that have been cancelled are not included in totals on the summary levels of the e-Document.

Counterproposal

The sender is presenting a different proposal.

Rejected

The supplied information is rejected.

RFQResponseSummary

A group element that contains information that summarizes the contents of the RFQResponse.

(sequence)

The sequence of items below is mandatory. A single instance is required.

TotalNumberOfLineItems

TotalNumberOfLineItems is optional. A single instance might exist.

The total number of individual line items in the document, regardless of the status or type.

(sequence)

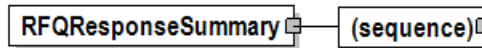

The sequence of items below is mandatory. One instance is required, multiple instances might exist.

TotalQuantity

TotalQuantity is mandatory. A single instance is required.

The total quantity of similar items in the e-Document. TotalQuantity is primarily used in the summary section of documents where it is repeatable to permit totaling for different units of measure.

TotalInformationalQuantity

TotalInformationalQuantity is optional. Multiple instances might exist.

A quantity that is used to communicate related information about the parent element. This element represents a total that is derived from individual line items.

LineItemSubTotal

LineItemSubTotal is optional. A single instance might exist.

The total amount of all base amounts on e-Document line items. The base amount contains the result of the calculation quantity times the base unit price. As such it does not include any taxes. For example, in an Invoice claiming payment for products LineItemSubTotal is equal to the sum of all InvoiceLineBaseAmount.

TotalAdjustments

TotalAdjustments is optional. A single instance might exist.

The CurrencyValue of TotalAdjustments contains the total of all adjustments and charges excluding tax. For example, in the Invoice TotalAdjustments is equal to the sum of the signed values of the MonetaryAdjustmentAmount for all instances of MonetaryAdjustment with PriceAdjustment and FlatAmountAdjustment and plus the sum of the signed values of the ChargeNetAmount for all instances of

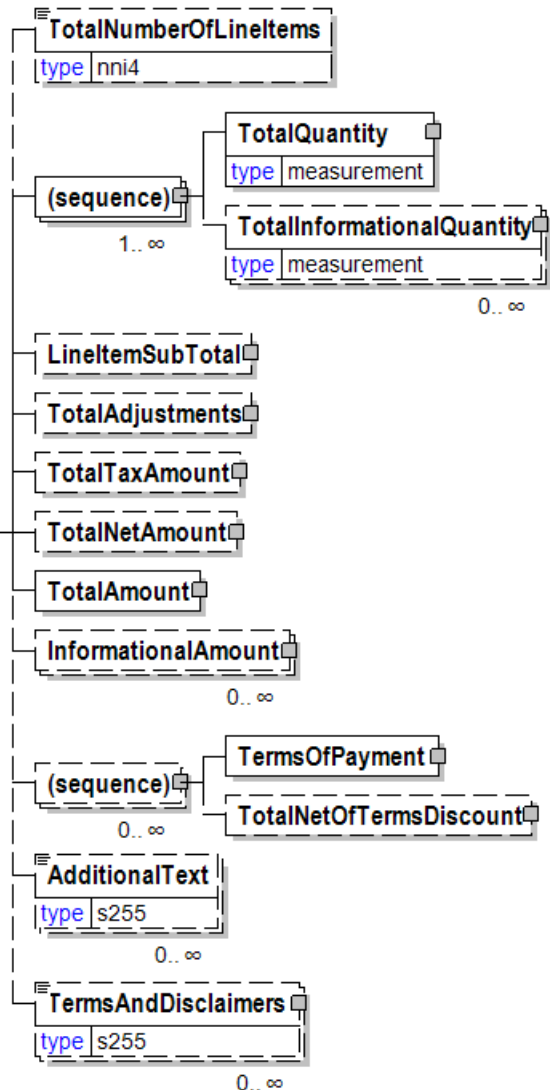

ChargeInformation.

TotalTaxAmount

TotalTaxAmount is optional. A single instance might exist.

The CurrencyValue of TotalTaxAmount contains the sum of all instances of TaxAdjustment in the document. TotalTaxAmount contains the sum of all instances of the MonetaryAdjustmentAmount for tax adjustments.

TotalNetAmount

TotalNetAmount is optional. A single instance might exist.

A field containing total amount excluding tax. For example, in the Invoice TotalNetAmount is equal to the sum of LineItemSubTotal plus TotalAdjustments. TotalNetAmount encapsulates CurrencyValue.

TotalAmount

TotalAmount is mandatory. A single instance is required.

The total amount including tax (when tax is specified in the e-Document).

In e-Documents claiming payment this is the amount due for payment based on the terms of payment. Decimal rounding might be applied to this amount.

InformationalAmount

InformationalAmount is optional. Multiple instances might exist.

A monetary amount used for information purposes only (not for calculation). For example, the invoice price adjustment subtotal is expressed in sterling pounds, and the buyer wants this information expressed in U.S. dollars.

CreditDebitNote and Invoice - The TaxAmount is displayed in the currency that is applicable throughout the e-Document. When a TaxAmount needs to be displayed in a different national currency, this field is used.

(sequence)

The sequence of items below is optional. Multiple instances might exist.

TermsOfPayment

TermsOfPayment is mandatory. A single instance is required.

A group item that contains agreed-to terms defining when, how, and under what conditions the payment is to be made.

When TermsOfPayment is optional; if omitted, TermsOfPayment is controlled through previous negotiation.

TotalNetOfTermsDiscount

TotalNetOfTermsDiscount is optional. A single instance might exist.

The components of the amount to be paid if prompt payment discount terms are met, including the amount that is subject to the payment terms discount, the discount amount, and the amount due after prompt payment discount.

AdditionalText

AdditionalText is optional. Multiple instances might exist.

A text field that is used to communicate information not previously defined or for special instructions. To be used only for circumstances not covered by specific elements.

TermsAndDisclaimers

TermsAndDisclaimers is optional. Multiple instances might exist.

An element that contains legal information with an indication of what the Language is.

RFQResponseValidityDate

The Date and Time within which a response to the RFQ is valid.

(sequence)

The sequence of items below is mandatory. A single instance is required.

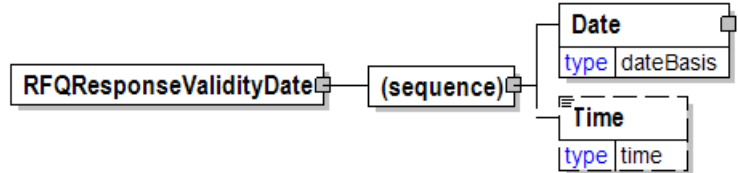

Date

Date is mandatory. A single instance is required.

A group element that contains the specification of Year, Month, and Day.

Time

Time is optional. A single instance might exist.

Times are treated in a standard XML fashion with a special case used to indicate a generalized "local" time. The standard XML approach to time is hh:mm:ss, hh:mm:ssZ, or hh:mm:ss±hh:mm.

hh:mm:ss±hh:mm is used to represent a time with a time zone. The time zone is communicated as the number of hours offset from the Universal Time Coordinate (UTC), a.k.a. Greenwich Mean Time.

hh:mm:ssZ indicates the time at Zulu (another name for UTC).

hh:mm:ss or hh:mm indicates within papiNet the applicable local time where the associated event is taking place. Caution should be used when processing times of this nature as the papiNet approach may be in discord with other users of XML.

RFQStatusType [attribute]

This attribute acts as a flag indicating what processing may be required.

This item is restricted to the following list.

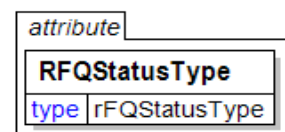

Amended

The supplied information is changed.

Cancelled

The supplied information has been cancelled. Items that have been cancelled are not included in totals on the summary levels of the e-Document.

Original

The supplied information is the first version of that information.

RFQSummary

Summary information that applies to the RFQ e-Document.

(sequence)

The sequence of items below is mandatory. A single instance is required.

TotalNumberOfLineItems

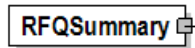

TotalNumberOfLineItems is optional. A single instance might exist.

The total number of individual line items in the document, regardless of the status or type.

(sequence)

The sequence of items below is mandatory. One instance is required, multiple instances might exist.

TotalQuantity

TotalQuantity is mandatory. A single instance is required.

The total quantity of similar items in the e-Document. TotalQuantity is primarily used in the summary section of documents where it is repeatable to permit totaling for different units of measure.

InformationalQuantity

InformationalQuantity is optional. Multiple instances might exist.

A quantity given in a valid UOM used for information purposes only (not for calculation). For example, an ordered quantity was 100 reels as opposed to the invoice quantity of 20,000 pounds.

TotalAmount

TotalAmount is optional. A single instance might exist.

The total amount including tax (when tax is specified in the e-Document).

In e-Documents claiming payment this is the amount due for payment based on the terms of payment. Decimal rounding might be applied to this amount.

TermsAndDisclaimers

TermsAndDisclaimers is optional. Multiple instances might exist.

An element that contains legal information with an indication of what the Language is.

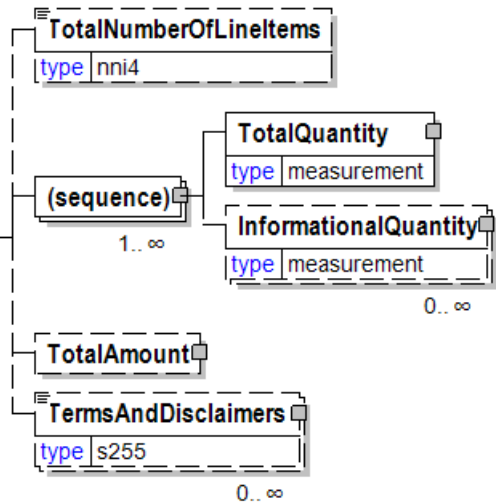

RFQType [attribute]

Defines the type of RFQ issued.

This item is restricted to the following list.

StandardRFQ

The only type of RFQ.

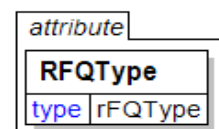

RGB

A definition of colour using the RGB protocol.

TestMethod [attribute]

TestMethod is optional. A single instance might exist.

The method used to determine the results of the test under consideration.

TestAgency [attribute]

TestAgency is optional. A single instance might exist.

The agency that has set the parameters for the testing

Refer to TestAgency definition for any enumerations.

SampleType [attribute]

SampleType is optional. A single instance might exist.

Communicates how sampling was done to measure the product characteristics.

Refer to SampleType definition for any enumerations.

ResultSource [attribute]

ResultSource is optional. A single instance might exist.

Used to define the data source of the specified test

Refer to ResultSource definition for any enumerations.

(sequence)

The sequence of items below is mandatory. A single instance is required.

Red

Red is mandatory. A single instance is required.

The "Red" portion of the method of representing colour termed RGB.

Green

Green is mandatory. A single instance is required.

The "Green" portion of the method of representing colour termed RGB

Blue

Blue is mandatory. A single instance is required.

The "Blue" portion of the method of representing colour termed RGB.

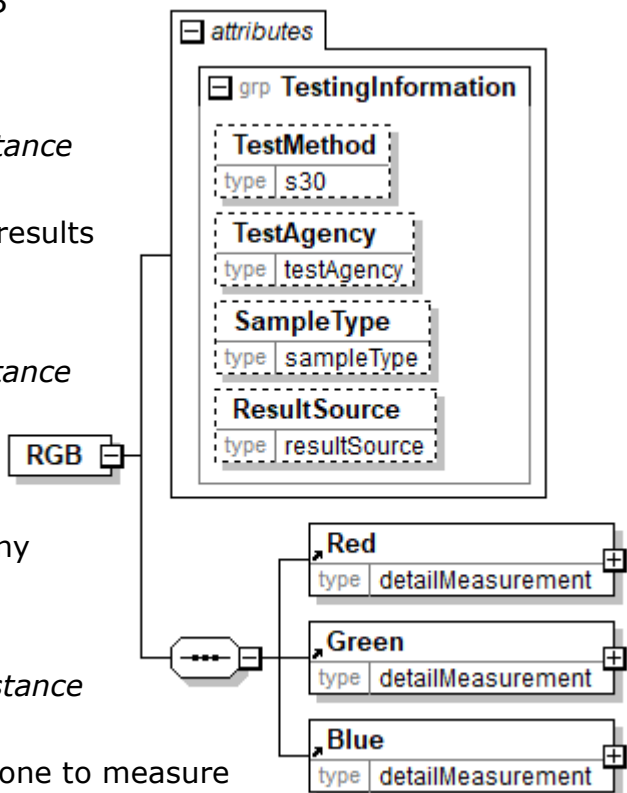

Ribbon

Ribbon information.

(sequence)

The sequence of items below is mandatory. A single instance is required.

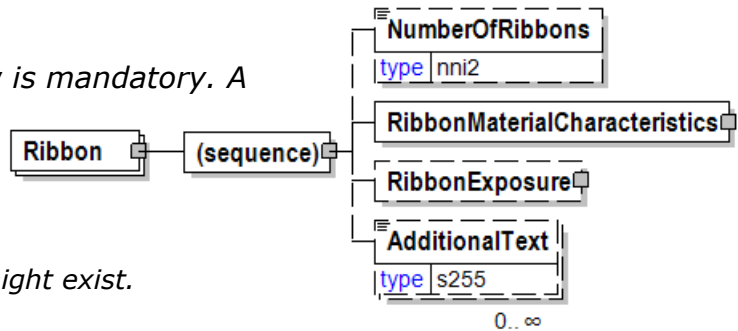

NumberOfRibbons

NumberOfRibbons is optional. A single instance might exist.

The number of ribbons.

RibbonMaterialCharacteristics

RibbonMaterialCharacteristics is mandatory. A single instance is required.

Ribbon material characteristics.

RibbonExposure

RibbonExposure is optional. A single instance might exist.

Ribbon exposure

AdditionalText

AdditionalText is optional. Multiple instances might exist.

A text field that is used to communicate information not previously defined or for special instructions. To be used only for circumstances not covered by specific elements.

RibbonExposure

Ribbon exposure

(sequence)

The sequence of items below is mandatory. A single instance is required.

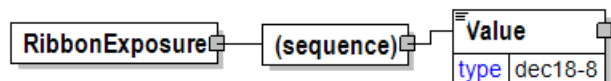

Value

Value is mandatory. A single instance is required.

A numeric value expressed in the unit of measure (UOM).

RibbonFacingType [attribute]

The type of ribbon facing

This item is restricted to the following list.

Double

Single

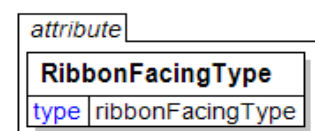

RibbonMaterialCharacteristics

Ribbon material characteristics.

RibbonFacingType [attribute]

RibbonFacingType is optional. A single instance might exist.

The type of ribbon facing

Refer to RibbonFacingType definition for any enumerations.

(sequence)

The sequence of items below is mandatory. A single instance is required.

BindingMaterialCharacteristics

BindingMaterialCharacteristics is mandatory. A single instance is required.

Binding Material Characteristics

Width

Width is optional. A single instance might exist.

The width of the object.

AdditionalText

AdditionalText is optional. Multiple instances might exist.

A text field that is used to communicate information not previously defined or for special instructions. To be used only for circumstances not covered by specific elements.

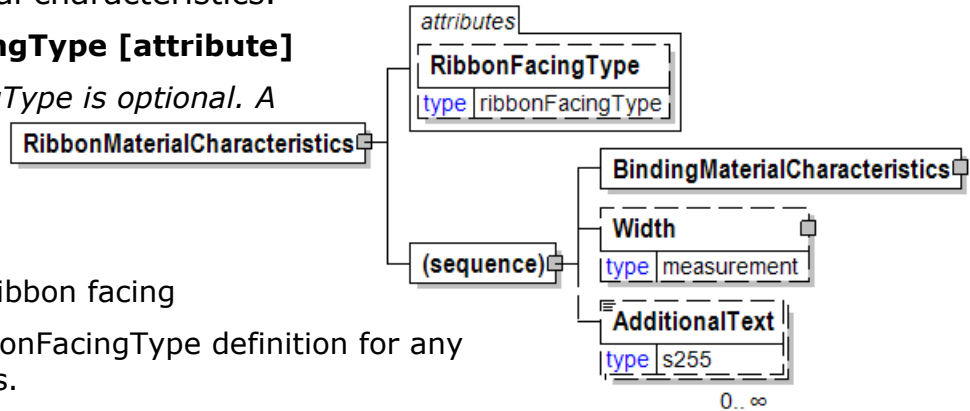

RingCrush

Ring Crush

TestMethod [attribute]

TestMethod is optional. A single instance might exist.

The method used to determine the results of the test under consideration.

TestAgency [attribute]

TestAgency is optional. A single instance might exist.

The agency that has set the parameters for the testing

Refer to TestAgency definition for any enumerations.

SampleType [attribute]

SampleType is optional. A single instance might exist.

Communicates how sampling was done to measure the product characteristics.

Refer to SampleType definition for any enumerations.

ResultSource [attribute]

ResultSource is optional. A single instance might exist.

Used to define the data source of the specified test

Refer to ResultSource definition for any enumerations.

(sequence)

The sequence of items below is mandatory. A single instance is required.

DetailValue

DetailValue is mandatory. A single instance is required.

A numeric value expressed in the unit of measure (UOM).

DetailRangeMin

DetailRangeMin is optional. A single instance might exist.

The minimum value (lower boundary) allowed for the DetailValue that is the parent of this element.

DetailRangeMax

DetailRangeMax is optional. A single instance might exist.

The maximum value (upper boundary) allowed for the DetailValue that is the

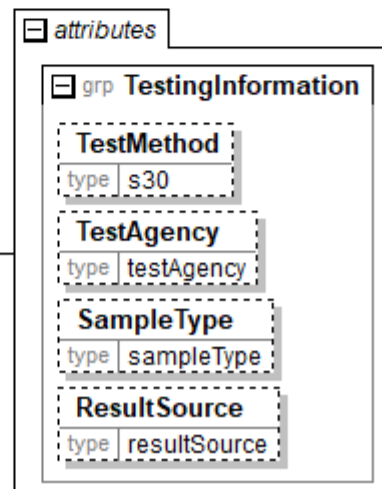
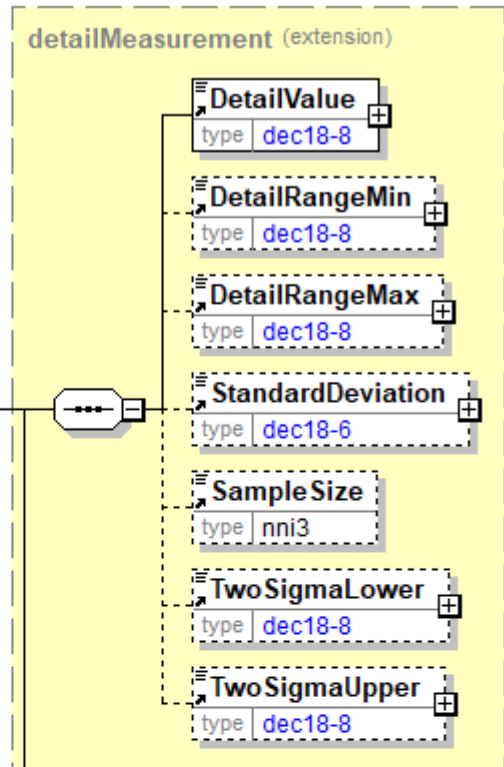
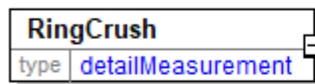

parent of this element.

StandardDeviation

StandardDeviation is optional. A single instance might exist.

A statistic used as a measure of dispersion in a distribution.

SampleSize

SampleSize is optional. A single instance might exist.

The number of samples used to determine the product characteristic in question.

TwoSigmaLower

TwoSigmaLower is optional. A single instance might exist.

Two sigma (a measure of dispersion associated with standard deviation) on the lower side of the standard deviation.

TwoSigmaUpper

TwoSigmaUpper is optional. A single instance might exist.

Two sigma (a measure of dispersion associated with standard deviation) on the upper side of the standard deviation.

RoadAccessibilityType [attribute]

Defines the largest vehicle and transport unit combination that can access the road according to the road curving, bends, hills and slopes.

This item is restricted to the following list.

Trailer

Road is accessible for a truck with trailer.

DrawBarCombination

Road is accessible for a drawbar combination.

DrawBarCombinationWithAdjustableBogie

Road is accessible for a drawbar combination with trailer equipped with adjustable bogie.

RigidLorry

Road is accessible for shorter vehicles that is, a rigid lorry without trailer.



RoadAvailability

Defines when in the year or season the road is available.

This item is restricted to the following list.

AllYear

Road is available all year for all kind of traffic.

NotAvailable

Road is temporarily not available for transporting



NotInHeavyRain

Road is not available for trucks in heavy rain periods.

NotInSevereThawing

Road is not available for trucks in severe soil frost thawing.

NotInWinter

Road is not available in winter season. Only available in spring, summer and autumn season.

InWinter

Road is available for trucks only in winter season. In the Nordic region it is common with ice-roads over lakes etc in the winter season.

RoadBearingCapacity

The capacity for the road to bear a load without being damaged.

RoadBearingCapacityType [attribute]

RoadBearingCapacityType is optional. A single instance might exist.

Type of burden restriction for the road that is specified by RoadBearingCapacity.

Refer to RoadBearingCapacityType definition for any enumerations.

(sequence)

The sequence of items below is mandatory. A single instance is required.

Value

Value is mandatory. A single instance is required.

A numeric value expressed in the unit of measure (UOM).

RangeMin

RangeMin is optional. A single instance might exist.

The minimum value (lower boundary) allowed for the Measurement that is the parent of this element.

RangeMax

RangeMax is optional. A single instance might exist.

The maximum value (upper boundary) allowed for the Measurement that is the parent of this element. Some elements use the RangeMax element with an extended list of unit of measures. (Note: the red colour in the picture is an artifact of how the graphic was captured and should be disregarded.)

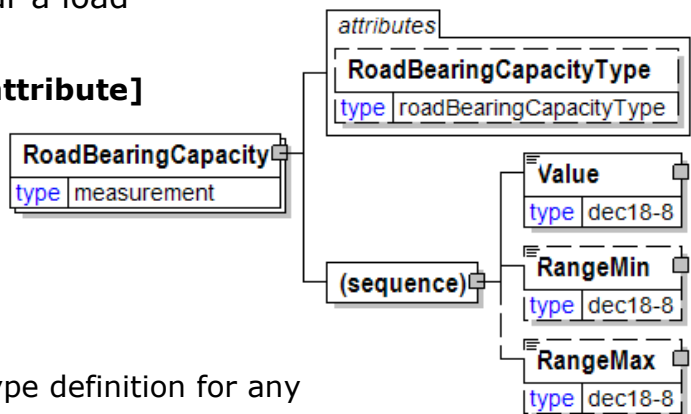

RoadBearingCapacityType [attribute]

Type of burden restriction for the road that is specified by RoadBearingCapacity.

This item is restricted to the following list.

attribute
RoadBearingCapacityType
type roadBearingCapacityType

BogieLoad

Maximum load for a bogie (tandem axles).

SingleAxleLoad

Maximum axle load.

TripleAxleLoad

Maximum load for a triple axle.

TotalVehicleLoad

Maximum total load (gross weight) for a vehicle.

RoadCharacteristics

A grouping element containing items describing characteristics specific for a road.

RoadOwnerType [attribute]

RoadOwnerType is optional. A single instance might exist.

Defines the ownership for the road.

Refer to RoadOwnerType definition for any enumerations.

RoadKeeperType [attribute]

RoadKeeperType is optional. A single instance might exist.

Defines the party responsible for the maintenance of the road.

Refer to RoadKeeperType definition for any enumerations.

RoadAccessibilityType [attribute]

RoadAccessibilityType is optional. A single instance might exist.

Defines the largest vehicle and transport unit combination that can access the road according to the road curving, bends, hills and slopes.

Refer to RoadAccessibilityType definition for any enumerations.

RoadTurningPossibilityType [attribute]

RoadTurningPossibilityType is optional. A single instance might exist.

Defines what kind of vehicle that can turn around.

Refer to RoadTurningPossibilityType definition for any enumerations.

RoadTurningPointType [attribute]

RoadTurningPointType is optional. A single instance might exist.

Defines the shape of the turning point.

Refer to RoadTurningPointType definition for any enumerations.

RoadPassingPossibility [attribute]

RoadPassingPossibility is optional. A single instance might exist.

Defines if it is possible for two vehicles to pass each other on the road.

Refer to RoadPassingPossibility definition for any enumerations.

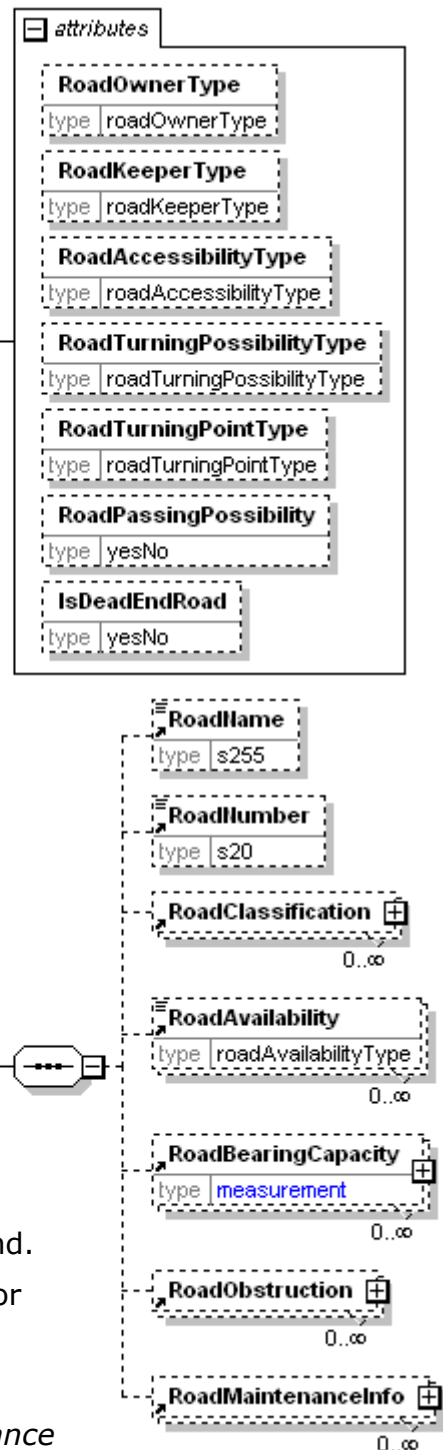

IsDeadEndRoad [attribute]

IsDeadEndRoad is optional. A single instance might exist.

A road with only one way in or out.

(sequence)

The sequence of items below is mandatory. A single instance is required.

RoadName

RoadName is optional. A single instance might exist.

Defines the name of the road.

RoadNumber

RoadNumber is optional. A single instance might exist.

Defines the official number of the road.

RoadClassification

RoadClassification is optional. Multiple instances might exist.

Grouping element for items describing how roads are classified.

RoadAvailability

RoadAvailability is optional. Multiple instances might exist.

Defines when in the year or season the road is available.

Refer to RoadAvailability definition for any enumerations.

RoadBearingCapacity

RoadBearingCapacity is optional. Multiple instances might exist.

The capacity for the road to bear a load without being damaged.

RoadObstruction

RoadObstruction is optional. Multiple instances might exist.

A grouping element containing items describing details for an obstruction on a road. If a MapPoint or MapCoordinates are specified then it marks the start point of the obstruction.

RoadMaintenanceInfo

RoadMaintenanceInfo is optional. Multiple instances might exist.

A grouping element that contains information about road maintenance.

RoadClassification

Grouping element for items describing how roads are classified.

(sequence)

The sequence of items below is mandatory. A single instance is required.

RoadClassificationCode

RoadClassificationCode is mandatory. A single instance is required.

Classification code for the road. Code is assigned by agency.

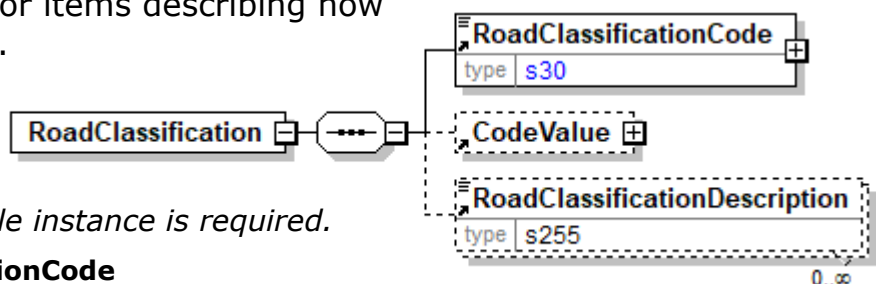

CodeValue

CodeValue is optional. A single instance might exist.

A grouping element specifying a value belonging to a code that is defined by an agency.

RoadClassificationDescription

RoadClassificationDescription is optional. Multiple instances might exist.

Description of the road classification.

RoadClassificationCode

Classification code for the road. Code is assigned by agency.

Agency [attribute]

Agency is mandatory. A single instance is required.

Describes the agency maintaining the list of codes. To be included in this list the agency must be a recognized standards body or industry organisation.

- For the element that owns this attribute.
- For another attribute in the list of attributes associated with the parent element.

Refer to Agency definition for any enumerations.

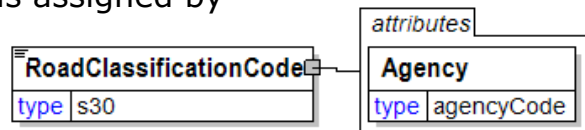

RoadClassificationDescription

Description of the road classification.

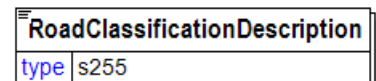

RoadKeeperType [attribute]

Defines the party responsible for the maintenance of the road.

This item is restricted to the following list.

Public

Private



RoadMaintenanceCodeInfo

A grouping element that specifies information about a road maintenance code defined by an agency.

Agency [attribute]

Agency is mandatory. A single instance is required.

Describes the agency maintaining the list of codes. To be included in this list the agency must be a recognized standards body or industry organisation.

- For the element that owns this attribute.
- For another attribute in the list of attributes associated with the parent element.

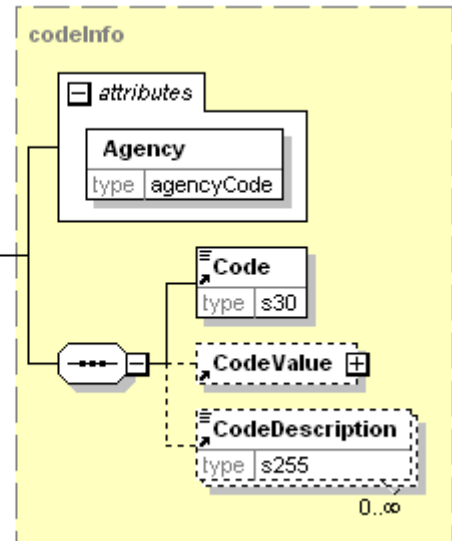
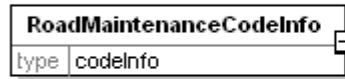

Refer to Agency definition for any enumerations.

(sequence)

The sequence of items below is mandatory. A single instance is required.

Code

Code is mandatory. A single instance is required.

Specifies a code that is defined by an agency. The agency is given for the whole construct containing the code.

CodeValue

CodeValue is optional. A single instance might exist.

A grouping element specifying a value belonging to a code that is defined by an agency.

CodeDescription

CodeDescription is optional. Multiple instances might exist.

A textual description for the meaning of a code that is defined by an agency. When the Code is associated with a CodeValue of type TextValue, then the CodeDescription is a textual description of both the Code and the TextValue.

RoadMaintenanceInfo

A grouping element that contains information about road maintenance.

(sequence)

The sequence of items below is mandatory. A single instance is required.

RoadMaintenanceCodeInfo

RoadMaintenanceCodeInfo is optional. A single

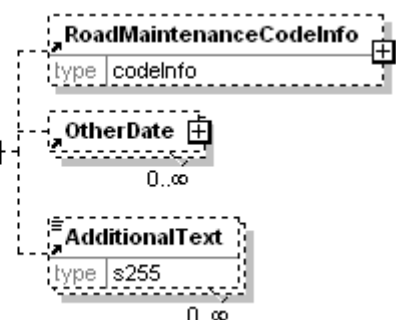
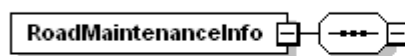

papiNet V2R31

instance might exist.

A grouping element that specifies information about a road maintenance code defined by an agency.

OtherDate

OtherDate is optional. Multiple instances might exist.

A date that may not be specifically detailed within a document (example: print date at the PurchaseOrderLineItem).

AdditionalText

AdditionalText is optional. Multiple instances might exist.

A text field that is used to communicate information not previously defined or for special instructions. To be used only for circumstances not covered by specific elements.

RoadName

Defines the name of the road.

RoadName
type s255

RoadNumber

Defines the official number of the road.

RoadNumber
type s20

RoadObstruction

A grouping element containing items describing details for an obstruction on a road. If a MapPoint or MapCoordinates are specified then it marks the start point of the obstruction.

RoadObstructionType [attribute]

RoadObstructionType is required. A single instance must exist.

Defines the type of hazard or obstruction on a road.

(sequence)

The sequence of items below is mandatory. A single instance is required.

MapPointName

MapPointName is optional. A single instance might exist.

A unique name for a point on a map. It is also normally the name of the corresponding waypoint in a GPS.

MapPointComment

MapPointComment is optional. Multiple instances might exist.

A descriptive text for a point on a map. It is also normally shown in a GPS as a comment for the corresponding waypoint.

MapCoordinates

MapCoordinates is optional. Multiple instances might exist.

A group item defining and containing position coordinates of a location.

RoadSlopePercent

RoadSlopePercent is optional. A single instance may exist.

Specifies the gradient in percent for a road. A positive value indicates an uphill slope and a negative value a downhill slope

RoadBearingCapacity

RoadBearingCapacity is optional. Multiple instances might exist.

The capacity for the road to bear a load without being damaged.

Length

Length is optional. A single instance might exist.

The length of the object

Width

Width is optional. A single instance might exist.

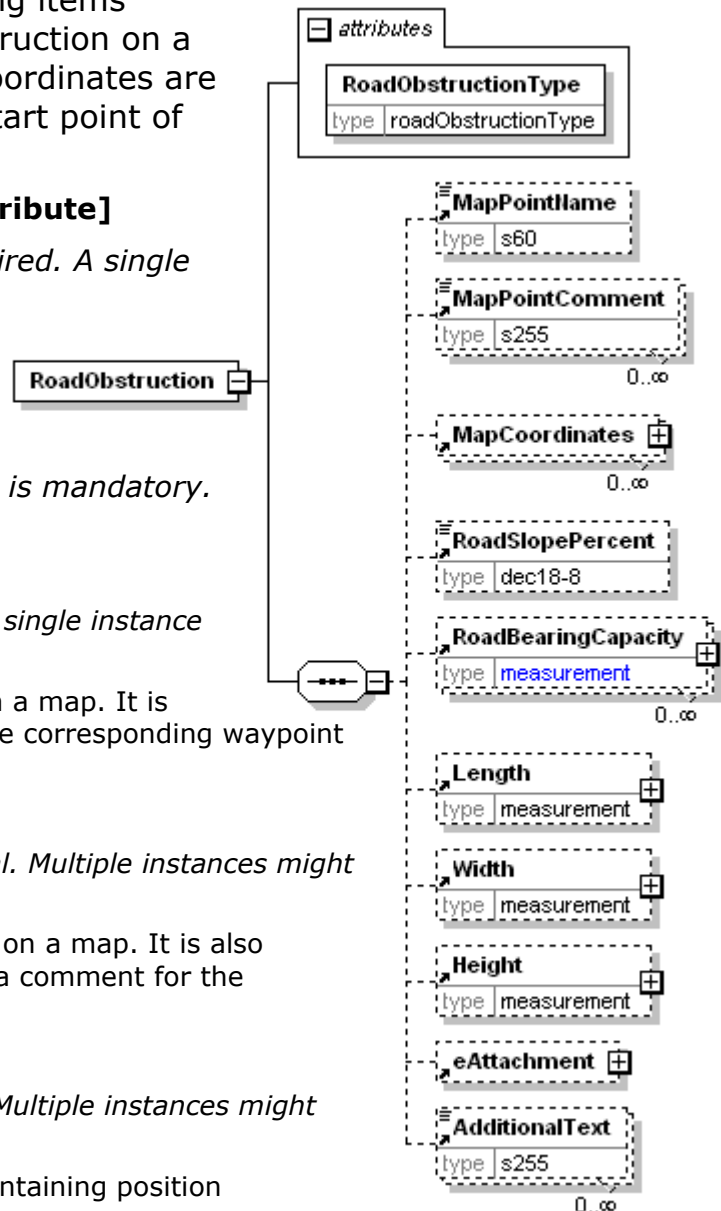

The width of the object

Height

Height is optional. A single instance might exist.

The height of the object.

eAttachment

eAttachment is optional. A single instance might exist.

eAttachment enables the sender to provide information about attachments to the document.

Note: An element "e-Attachment" also exists. papiNet will no longer use hyphens in our element and attribute names as this causes issues with BizTalk.

AdditionalText

AdditionalText is optional. Multiple instances might exist.

A text field that is used to communicate information not previously defined or for special instructions. To be used only for circumstances not covered by specific elements.

RoadObstructionType [attribute]

Defines the type of hazard or obstruction on a road.

This item is restricted to the following list.



Bridge

A bridge, e.g. for crossing over a river. A bridge might be restricted by width and bearing capacity.

Ferry

A ferry crossing with restrictions along a road. Typically restricted by width and bearing capacity.

Passage

A section or crossing with restrictions along a road. Typically restricted by width.

RoadWorks

Repairs to a road forming a hazard or obstruction to traffic.

Slope

A section of a road with a gradient forming obstruction to traffic

UnderPass

A section of a road that passes under another road, railway line, etc. Typically restricted by height and width.

RoadOwnerType [attribute]

Defines the ownership for the road.

This item is restricted to the following list.

Public

Private



RoadPassingPossibility [attribute]

Defines if it is possible for two vehicles to pass each other on the road.

This item is restricted to the following list.

Yes

No

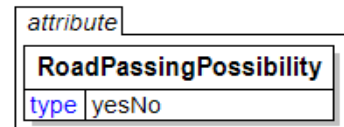

RoadSlopePercent

Specifies the gradient in percent for a road. A positive value indicates an uphill slope and a negative value a downhill slope.



RoadTurningPointType [attribute]

Defines the shape of the turning point.

This item is restricted to the following list.

Circle

Circle shaped turning place.

T-crossing

T-cross shaped intersection.

X-crossing

X-shaped intersection.



RoadTurningPossibilityType [attribute]

Defines what kind of vehicle that can turn around.

This item is restricted to the following list.

DrawBarCombination

Turning possibility for a drawbar combination.

DrawBarCombinationWithAdjustableBogie

Turning possibility for a drawbar combination with trailer equipped with adjustable bogie.

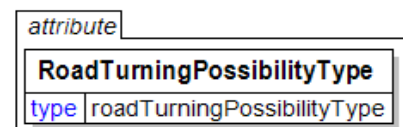

NoTurningPossibility

There is no turning possibility, the truck has to go in reverse direction when returning.

RigidLorry

Turning possibility for a rigid lorry without trailer.

ThroughAccessNoTurning

There is a through access but no turning possibility.

Trailer

Turning possibility for a truck with trailer.

Roof

Defines parts and complete roofing systems.

(sequence)

The sequence of items below is mandatory. A single instance is required.

(choice)

[choice] is mandatory. A single instance is required.

RoofPanel

RoofPanel is mandatory. A single instance is required.

Describes the roofing surface.

RoofPackage

RoofPackage is mandatory. A single instance is required.

Roof package

RoofTruss

RoofTruss is mandatory. A single instance is required.

Describes the supporting material under roofing surface.

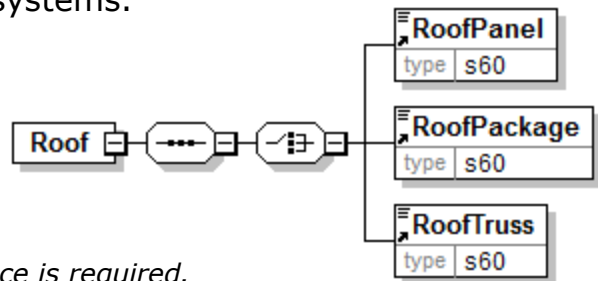

RoofingSidingDeckingFencing

A grouping element that contains the

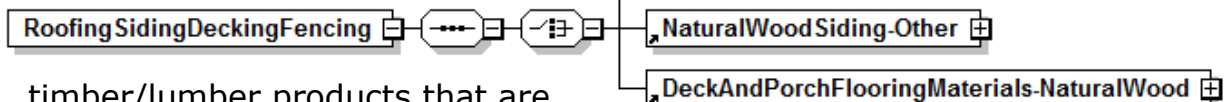

timber/lumber products that are used in roofing, siding, decking, or fencing.

(sequence)

The sequence of items below is mandatory. A single instance is required.

(choice)

papiNet V2R31

[choice] is mandatory. A single instance is required.

NaturalWoodSiding

NaturalWoodSiding is mandatory. A single instance is required.

Natural wood siding

NaturalWoodSiding-Other

NaturalWoodSiding-Other is mandatory. A single instance is required.

Natural Wood Siding - Other

DeckAndPorchFlooringMaterials-NaturalWood

DeckAndPorchFlooringMaterials-NaturalWood is mandatory. A single instance is required.

Deck and porch flooring materials that are used in natural wood products.

RoofPackage

Roof package

RoofPackage
type s60

RoofPanel

Describes the roofing surface.

RoofPanel
type s60

RoofTruss

Describes the supporting material under roofing surface.

RoofTruss
type s60

Roughness

A group item used to communicate surface roughness target or test value according to a particular TestMethod.

TestMethod [attribute]

TestMethod is optional. A single instance might exist.

The method used to determine the results of the test under consideration.

TestAgency [attribute]

TestAgency is optional. A single instance might exist.

The agency that has set the parameters for the testing

Refer to TestAgency definition for any enumerations.

SampleType [attribute]

SampleType is optional. A single instance might exist.

Communicates how sampling was done to measure the product characteristics.

Refer to SampleType definition for any enumerations.

ResultSource [attribute]

ResultSource is optional. A single instance might exist.

Used to define the data source of the specified test

Refer to ResultSource definition for any enumerations.

(sequence)

The sequence of items below is mandatory. A single instance is required.

DetailValue

DetailValue is mandatory. A single instance is required.

A numeric value expressed in the unit of measure (UOM).

DetailRangeMin

DetailRangeMin is optional. A single instance might exist.

The minimum value (lower boundary) allowed for the DetailValue that is the parent of this element.

DetailRangeMax

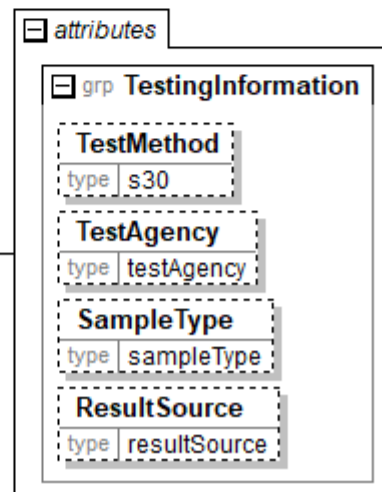
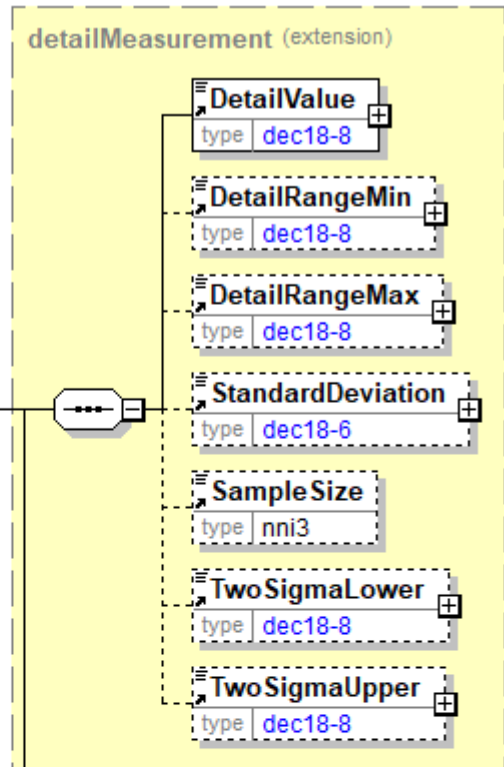

papiNet V2R31

DetailRangeMax is optional. A single instance might exist.

The maximum value (upper boundary) allowed for the DetailValue that is the parent of this element.

StandardDeviation

StandardDeviation is optional. A single instance might exist.

A statistic used as a measure of dispersion in a distribution.

SampleSize

SampleSize is optional. A single instance might exist.

The number of samples used to determine the product characteristic in question.

TwoSigmaLower

TwoSigmaLower is optional. A single instance might exist.

Two sigma (a measure of dispersion associated with standard deviation) on the lower side of the standard deviation.

TwoSigmaUpper

TwoSigmaUpper is optional. A single instance might exist.

Two sigma (a measure of dispersion associated with standard deviation) on the upper side of the standard deviation.

RoundCornered [attribute]

Is the item round cornered?

This item is restricted to the following list.

Yes

No

<i>attribute</i>
RoundCornered
<i>type</i> yesNo

Route

Route defines directions and characteristics for how to transport goods between two locations. A route starts at delivery origin or at the supplypoint belonging to the delivery origin.

RouteType [attribute]

RouteType is mandatory. A single instance is required.

Defines type of start and end points for the route.

Refer to RouteType definition for any enumerations.

IsWithLoad [attribute]

IsWithLoad is optional. A single instance might exist.

Indicates if a vehicle is carrying a load or if it is possible to carry a load or not.

Refer to IsWithLoad definition for any enumerations.

RouteSeasonType [attribute]

RouteSeasonType is optional. A single instance might exist.

Defines for what season the route is specified. For example a shorter route maybe specified during winter time when roads are frozen.

Refer to RouteSeasonType definition for any enumerations.

IsRouteAsInstructed [attribute]

IsRouteAsInstructed is optional. A single instance might exist.

Indicates if the route is the same as the earlier instructed route, e.g. in a DeliveryInstruction e-Document. A route is indicated as not the same if any route information is different compared to the earlier instructed route. It is recommended to inform the reason for the change/new of the route.

Refer to IsRouteAsInstructed definition for any enumerations.

(sequence)

The sequence of items below is mandatory. A single instance is required.

RouteName

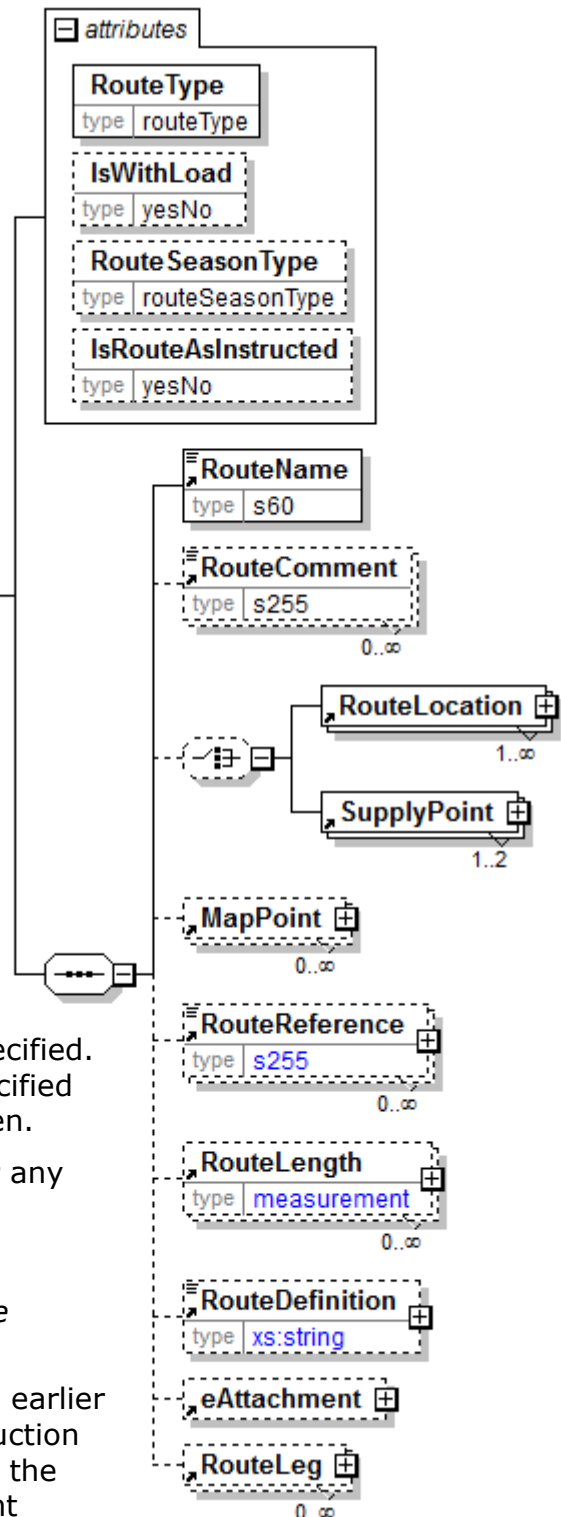

papiNet V2R31

RouteName is mandatory. A single instance is required.

A unique name of a route. It is also normally the name of the route in a GPS.

RouteComment

RouteComment is optional. Multiple instances might exist.

A descriptive text for a route. It is also normally shown in a GPS as a route comment.

(choice)

[choice] is optional. A single instance might exist.

RouteLocation

RouteLocation is mandatory. A single instance is required.

A grouping element specifying a location in a Route.

SupplyPoint

SupplyPoint is mandatory. A single instance is required. Two instances might exist.

Grouping element that contains items describing a supply point. A SupplyPoint belongs to a LocationParty, e.g. in a DeliveryOrigin or DeliveryDestination, and describes where goods are stored and can be loaded or unloaded. A SupplyPoint can for example be a loading or unloading gate at a warehouse or a road side landing at a logging area in the forest.

MapPoint

MapPoint is optional. Multiple instances might exist.

A grouping element for items describing a point on a map. A mappoint is normally named waypoint in a GPS.

RouteReference

RouteReference is optional. Multiple instances might exist.

An element detailing relevant references pertaining to the Route as indicated by RouteReferenceType and AssignedBy.

RouteLength

RouteLength is optional. Multiple instances might exist.

The length for the route.

RouteDefinition

RouteDefinition is optional. A single instance might exist.

List of waypoints describing the route.

eAttachment

eAttachment is optional. A single instance might exist.

eAttachment enables the sender to provide information about attachments to the document.

Note: An element "e-Attachment" also exists. papiNet will no longer use hyphens in our element and attribute names as this causes issues with BizTalk.

RouteLeg

RouteLeg is optional. Multiple instances might exist.

A grouping element contains items describing the route leg. A route leg is a part of a route. A route leg has its own characteristics.

RouteComment

A descriptive text for a route. It is also normally shown in a GPS as a route comment.

RouteComment	
type	s255

RouteDefinition

List of waypoints describing the route.

RouteDefinitionFormat [attribute]

RouteDefinitionFormat is mandatory. A single instance is required.

The format of the RouteDefinition.

Refer to RouteDefinitionFormat definition for any enumerations.

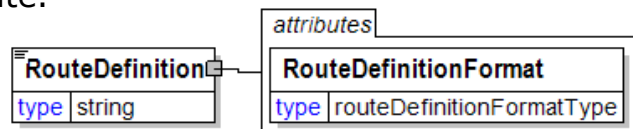

RouteDefinitionFormat [attribute]

The format of the RouteDefinition.

This item is restricted to the following list.

gpx

GPX (the GPS Exchange Format) is a light-weight XML data format for the interchange of GPS data (waypoints, routes, and tracks) between applications and Web services on the Internet.

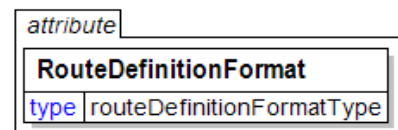

RouteLeg

A grouping element contains items describing the route leg. A route leg is a part of a route. A route leg has its own characteristics.

(sequence)

The sequence of items below is mandatory. A single instance is required.

RouteLegNumber

RouteLegNumber is mandatory. A single instance is required.

A sequential number for the legs of the route.

RouteLegName

RouteLegName is optional. A single instance might exist.

A unique name for a route leg.

OtherParty

OtherParty is optional. Multiple instances might exist.

An organisation or business entity other than those specifically detailed within an e-Document.

MapPoint

MapPoint is optional. Multiple instances might exist.

A grouping element for items describing a point on a map. A mappoint is normally named waypoint in a GPS.

RouteReference

RouteReference is optional. Multiple instances might exist.

An element detailing relevant references pertaining to the Route as indicated by RouteReferenceType and AssignedBy.

RouteLegLength

RouteLegLength is optional. Multiple instances might exist.

The length for the route leg.

RoadCharacteristics

RoadCharacteristics is optional. A single instance might exist.

A grouping element containing items describing characteristics specific for a road.

eAttachment

eAttachment is optional. A single instance might exist.

eAttachment enables the sender to provide information about attachments to the document.

Note: An element "e-Attachment" also exists. papiNet will no longer use hyphens in our element and attribute names as this causes issues with BizTalk.

AdditionalText

AdditionalText is optional. Multiple instances might exist.

A text field that is used to communicate information not previously defined or for

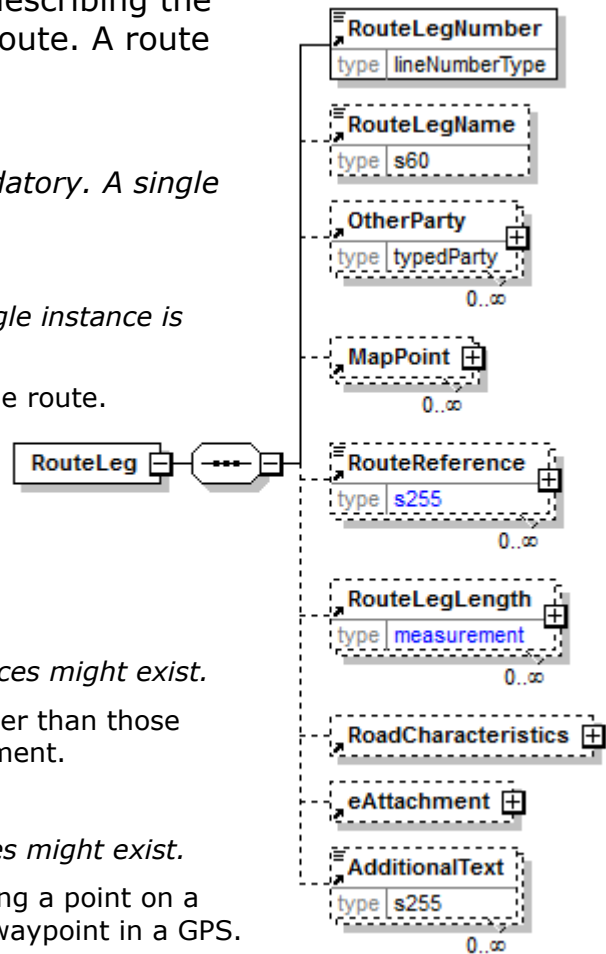

special instructions. To be used only for circumstances not covered by specific elements.

RouteLegLength

The length for the route leg.

LengthType

LengthType is optional. A single instance might exist.

Defines the type of source for how length is given. The attribute Agency can define the source.

LengthTypeVersion

LengthTypeVersion is optional. A single instance might exist.

Specifies the version of the source for a length type.

Agency [attribute]

Agency is optional. A single instance might exist.

Describes the agency maintaining the list of codes. To be included in this list the agency must be a recognized standards body or industry organisation.

- For the element that owns this attribute.
- For another attribute in the list of attributes associated with the parent element.

Refer to Agency definition for any enumerations.

(sequence)

The sequence of items below is mandatory. A single instance is required.

Value

Value is mandatory. A single instance is required.

A numeric value expressed in the unit of measure (UOM).

RangeMin

RangeMin is optional. A single instance might exist.

The minimum value (lower boundary) allowed for the Measurement that is the parent of this element.

RangeMax

RangeMax is optional. A single instance might exist.

The maximum value (upper boundary) allowed for the Measurement that is the parent of this element. Some elements use the RangeMax element with an extended list of unit of measures. (Note: the red colour in the picture is an artifact of how the graphic was captured and should be disregarded.)

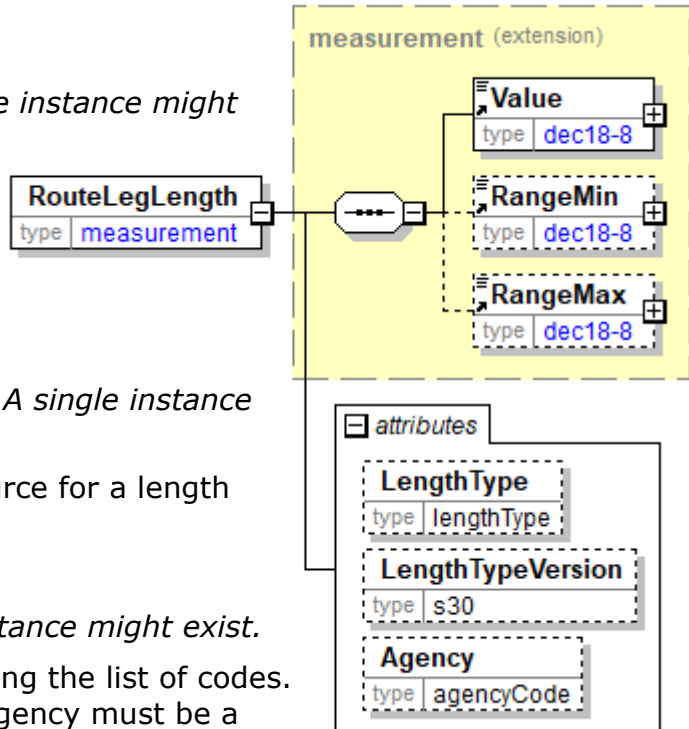

RouteLegName

A unique name for a route leg.

RouteLegName	
type	s60

RouteLegNumber

A sequential number for the legs of the route.

RouteLegNumber	
type	lineNumberType

RouteLength

The length for the route.

LengthType

LengthType is optional. A single instance might exist.

Defines the type of source for how length is given. The attribute Agency can define the source.

LengthTypeVersion

LengthTypeVersion is optional. A single instance might exist.

Specifies the version of the source for a length type.

Agency [attribute]

Agency is optional. A single instance might exist.

Describes the agency maintaining the list of codes. To be included in this list the agency must be a recognized standards body or industry organisation.

- For the element that owns this attribute.
- For another attribute in the list of attributes associated with the parent element.

Refer to Agency definition for any enumerations.

(sequence)

The sequence of items below is mandatory. A single instance is required.

Value

Value is mandatory. A single instance is required.

A numeric value expressed in the unit of measure (UOM).

RangeMin

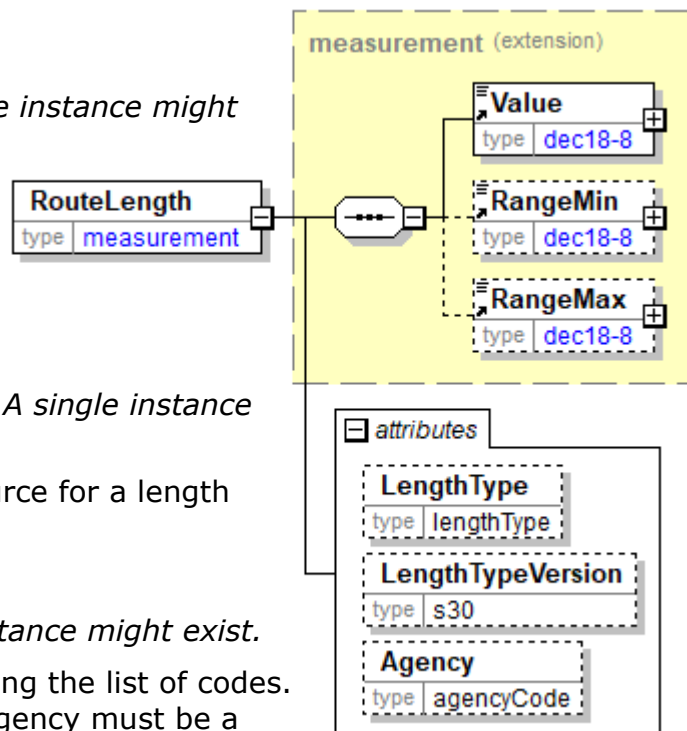

papiNet V2R31

RangeMin is optional. A single instance might exist.

The minimum value (lower boundary) allowed for the Measurement that is the parent of this element.

RangeMax

RangeMax is optional. A single instance might exist.

The maximum value (upper boundary) allowed for the Measurement that is the parent of this element. Some elements use the RangeMax element with an extended list of unit of measures. (Note: the red colour in the picture is an artifact of how the graphic was captured and should be disregarded.)

RouteLocation

A grouping element specifying a location in a Route.

(sequence)

The sequence of items below is mandatory. A single instance is required.

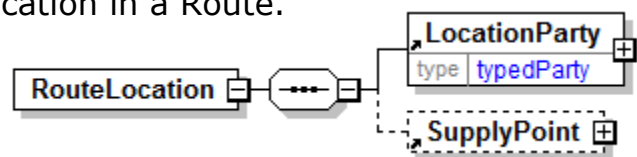

LocationParty

LocationParty is mandatory. A single instance is required.

The organization or business entity where the business event took place or will take place.

SupplyPoint

SupplyPoint is optional. A single instance might exist.

Grouping element that contains items describing a supply point. A SupplyPoint belongs to a LocationParty, e.g. in a DeliveryOrigin or DeliveryDestination, and describes where goods are stored and can be loaded or unloaded. A SupplyPoint can for example be a loading or unloading gate at a warehouse or a road side landing at a logging area in the forest.

RouteName

A unique name of a route. It is also normally the name of the route in a GPS.

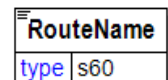

RouteReference

An element detailing relevant references pertaining to the Route as indicated by RouteReferenceType and AssignedBy.

RouteReferenceType [attribute]

RouteReferenceType is mandatory. A single instance is required.

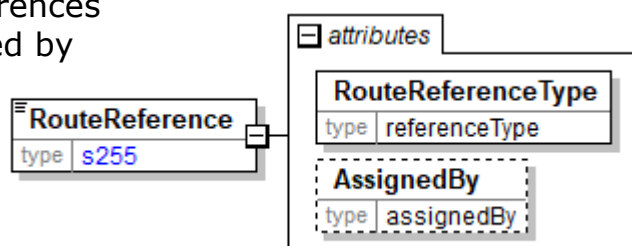

Provides a contextual explanation of the specific reference identifier. Many items are currently prefixed by "Buyer", "Forwarder", "Manufacturer", "Mill", "Seller", "Supplier", "Warehouse", or "Vendor". Check for an existing non-prefixed version and use the non-prefixed version instead. In the (yet to be announced release date) version 3.0 the prefixed versions will be removed. Instead the attribute @AssignedBy will communicate the information previously communicated in the prefix.

Refer to RouteReferenceType definition for any enumerations.

AssignedBy [attribute]

AssignedBy is optional. A single instance might exist.

Identifies the type of party or the agency that has assigned the associated item, e.g. a reference of type OrderNumber.

Refer to AssignedBy for any enumerations.

RouteReferenceType [attribute]

Provides a contextual explanation of the specific reference identifier. Many items are currently prefixed by "Buyer", "Forwarder", "Manufacturer", "Mill", "Seller", "Supplier", "Warehouse", or "Vendor". Check for an existing non-prefixed version and use the non-prefixed version instead. In the (yet to be announced release date) version 3.0 the prefixed versions will be removed. Instead the attribute @AssignedBy will communicate the information previously communicated in the prefix.

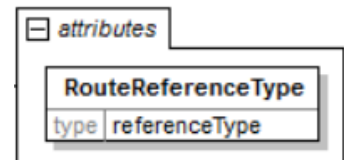

Refer to the [referenceType](#) entry for the list of enumerations and their definitions.

RouteSeasonType [attribute]

Defines for what season the route is specified. For example a shorter route maybe specified during winter time when roads are frozen.

This item is restricted to the following list.

Summer

The route is specified for summer conditions.

Winter

The route is specified for winter conditions



RouteType [attribute]

Defines type of start and end points for the route.

This item is restricted to the following list.

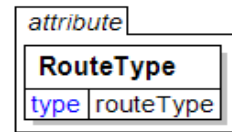

DeliveryDestinationToDeliveryOrigin

The route is specified from a previous delivery destination to a delivery origin.

DeliveryDestinationToMainIntersection

The route is specified from a previous delivery destination to a main road intersection.

DeliveryDestinationToSupplyPoint

The route is specified from a previous delivery destination to a supply point within a delivery origin.
To be deprecated in a future version V3R00. Use enumeration `DeliveryDestinationToDeliveryOrigin` instead.

DeliveryOriginToDeliveryDestination

The route is specified from a delivery origin to a delivery destination.

DeliveryOriginToMainIntersection

The route is specified from a delivery origin to a main road intersection.

DeliveryOriginToPlaceOfMeasuring

The route is specified from a delivery origin to a place of measuring.

DeliveryOriginToVehicleTerminal

The route is specified from a delivery origin to a vehicle terminal.

MainIntersectionToDeliveryDestination

The route is specified from a main road intersection to a delivery destination.

MainIntersectionToDeliveryOrigin

The route is specified from a main road intersection to a delivery origin.

MainIntersectionToPlaceOfMeasuring

The route is specified from a main road intersection to a place of measuring.

MainIntersectionToVehicleTerminal

The route is specified from a main road intersection to a vehicle terminal.

PlaceOfMeasuringToDeliveryDestination

The route is specified from a place of measuring to a delivery destination.

PlaceOfMeasuringToDeliveryOrigin

The route is specified from a place of measuring to a delivery origin.

PlaceOfMeasuringToMainIntersection

The route is specified from a place of measuring to a main road intersection.

SupplyPointToDeliveryDestination

The route is specified from a supply point within a delivery origin to a delivery

destination.

To be deprecated in a future version V3R00. Use enumeration DeliveryOriginToDeliveryDestination instead.

SupplyPointToMainIntersection

The route is specified from a supply point within a delivery origin to a main road intersection.

To be deprecated in a future version V3R00. Use enumeration DeliveryOriginToMainIntersection instead.

SupplyPointToVehicleTerminal

The route is specified from a supply point within a delivery origin to a vehicle terminal.

To be deprecated in a future version V3R00. Use enumeration DeliveryOriginToVehicleTerminal instead.

VehicleTerminalToDeliveryDestination

The route is specified from a vehicle terminal to a delivery destination.

VehicleTerminalToDeliveryOrigin

The route is specified from a vehicle terminal to a delivery origin.

VehicleTerminalToMainIntersection

The route is specified from a vehicle terminal to a main road intersection.

VehicleTerminalToPlaceOfMeasuring

The route is specified from a vehicle terminal to a place of measuring.

VehicleTerminalToSupplyPoint

The route is specified from a vehicle terminal to a supply point within a delivery origin.

To be deprecated in a future version V3R00. Use enumeration VehicleTerminalToDeliveryOrigin instead.

VehicleTour

The route is specified as a vehicle tour that is a specific one-time tour that a single vehicle is either scheduled for or is travelling. The tour can consist of many route legs and many different deliveries.

RowsPerUnit

The number of rows of items, are to be placed/packaged within the unit. Usually used to identify the standard number of rows in a standard packaging unit of the product.

RowsPerUnit
type nonNegativeInteger

RunnabilityIndex

A group item used to communicate the calculated run-ability index target or test value.

TestMethod [attribute]

TestMethod is optional. A single instance might exist.

The method used to determine the results of the test under consideration.

TestAgency [attribute]

TestAgency is optional. A single instance might exist.

The agency that has set the parameters for the testing

Refer to TestAgency definition for any enumerations.

SampleType [attribute]

SampleType is optional. A single instance might exist.

Communicates how sampling was done to measure the product characteristics.

Refer to SampleType definition for any enumerations.

ResultSource [attribute]

ResultSource is optional. A single instance might exist.

Used to define the data source of the specified test

Refer to ResultSource definition for any enumerations.

(sequence)

The sequence of items below is mandatory. A single instance is required.

DetailValue

DetailValue is mandatory. A single instance is required.

A numeric value expressed in the unit of measure (UOM).

DetailRangeMin

DetailRangeMin is optional. A single instance might exist.

The minimum value (lower boundary) allowed for the DetailValue that is the parent of this element.

DetailRangeMax

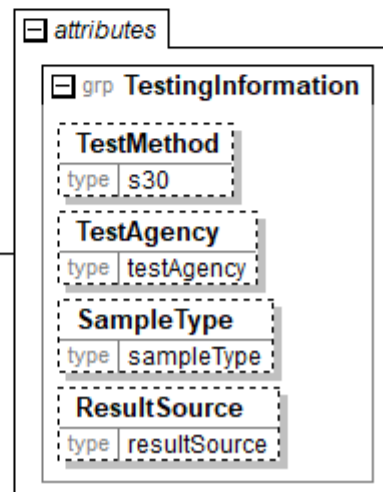
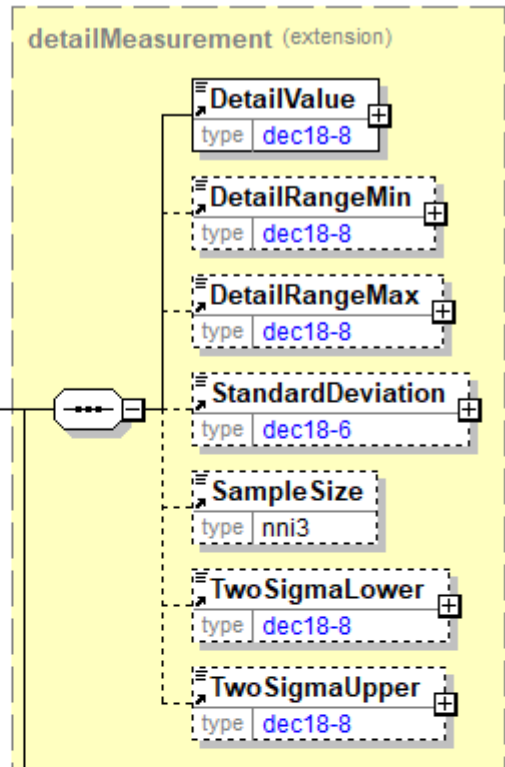

papiNet V2R31

DetailRangeMax is optional. A single instance might exist.

The maximum value (upper boundary) allowed for the DetailValue that is the parent of this element.

StandardDeviation

StandardDeviation is optional. A single instance might exist.

A statistic used as a measure of dispersion in a distribution.

SampleSize

SampleSize is optional. A single instance might exist.

The number of samples used to determine the product characteristic in question.

TwoSigmaLower

TwoSigmaLower is optional. A single instance might exist.

Two sigma (a measure of dispersion associated with standard deviation) on the lower side of the standard deviation.

TwoSigmaUpper

TwoSigmaUpper is optional. A single instance might exist.

Two sigma (a measure of dispersion associated with standard deviation) on the upper side of the standard deviation.

SafetyAndEnvironmentalCertification

Safety and Environmental Certification

(sequence)

The sequence of items below is mandatory. A single instance is required.

Value

Value is mandatory. A single instance is required.

A numeric value expressed in the unit of measure (UOM).

RangeMin

RangeMin is optional. A single instance might exist.

The minimum value (lower boundary) allowed for the Measurement that is the parent of this element.

RangeMax

RangeMax is optional. A single instance might exist.

The maximum value (upper boundary) allowed for the Measurement that is the parent of this element. Some elements use the RangeMax element with an extended list of unit of measures. (Note: the red colour in the picture is an artifact of how the graphic was captured and should be disregarded.)

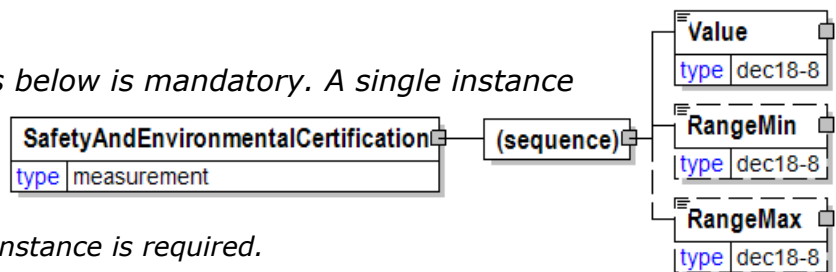

SafetyAndEnvironmentalInformation

Name of certification type, if any, on the goods (For example, FSC, PEFC). SafetyAndEnvironmental needs a value or measurement to communicate the percentage of the product is certified (for example, 75%



is certified by the indicated agency).

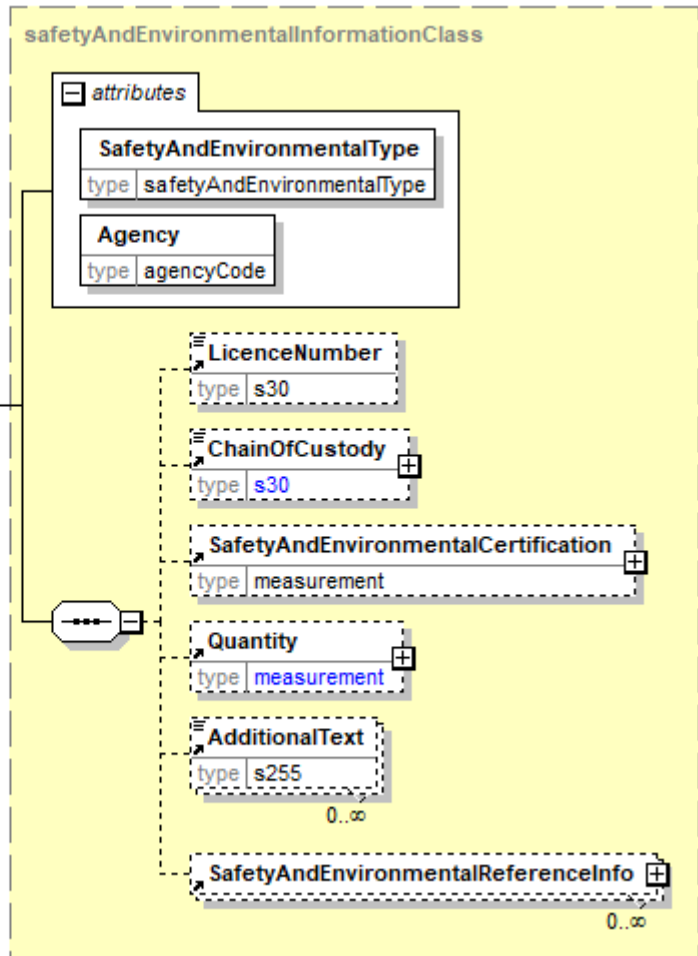

SafetyAndEnvironmentalType [attribute]

SafetyAndEnvironmentalType is mandatory. A single instance is required.

The type of safety and environmental information being communicated. Defines any additional information relating to safety and/or environmental matters.

Refer to SafetyAndEnvironmentalType definition for any enumerations.

Agency [attribute]

Agency is mandatory. A single instance is required.

Describes the agency maintaining the list of codes. To be included in this list the agency must be a recognized standards body or industry organisation.

- For the element that owns this attribute.
- For another attribute in the list of attributes associated with the parent element.

Refer to Agency definition for any enumerations.

(sequence)

The sequence of items below is mandatory. A single instance is required.

LicenceNumber

LicenceNumber is optional. A single instance might exist.

Licence number.

Note: the spelling of this element conforms to papiNet's use of UK English.

ChainOfCustody

ChainOfCustody is optional. A single instance might exist.

The chain of custody.

SafetyAndEnvironmentalCertification

SafetyAndEnvironmentalCertification is optional. A single instance might exist.

Safety and Environmental Certification

Quantity

Quantity is optional. A single instance might exist.

The Quantity element contains attributes that provide information about the type of quantity that is being communicated, the context in which the particular quantity is to be viewed, and (if the quantity represents an adjustment) an adjustment type.

The Quantity element contains three child elements that enable you to communicate a range of values for the quantity and a target or actual value. It is at this level (Value, RangeMin, and RangeMax) that the unit of measure is specified. This permits the range to be specified in a different unit of measure than the target.

AdditionalText

AdditionalText is optional. Multiple instances might exist.

A text field that is used to communicate information not previously defined or for special instructions. To be used only for circumstances not covered by specific elements.

SafetyAndEnvironmentalReferenceInfo

SafetyAndEnvironmentalReferenceInfo is optional. Multiple instances might exist.

A group item containing reference information applicable to SafetyAndEnvironmentalInformation.

SafetyAndEnvironmentalReferenceID

Identification for the item being

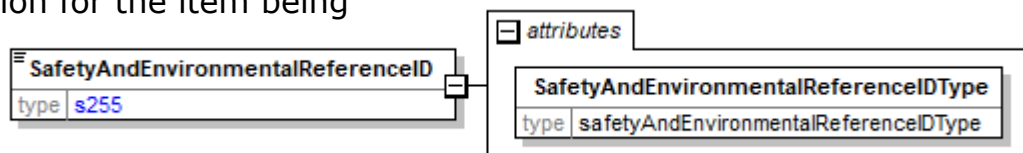

referenced.

SafetyAndEnvironmentalReferenceIDType [attribute]

SafetyAndEnvironmentalReferenceIDType is mandatory. A single instance is required.

Provides a contextual explanation of the specific reference identifier.

Refer to SafetyAndEnvironmentalReferenceIDType definition for any enumerations.

SafetyAndEnvironmentalReferenceIDType [attribute]

Provides a contextual explanation of the specific reference identifier.

This item is restricted to the following list.

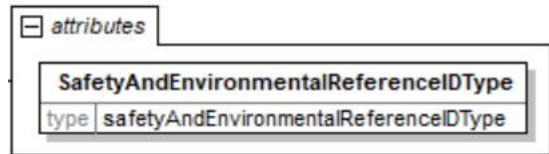

EUDRDueDiligenceStatementReferenceNumber

The unique reference number of a due diligence statement registered in the information system of the EU Commission, as mandated by the EU Deforestation Regulation. It is assigned by the EU information system as the due diligence statement is created in the system.

Regulation (EU) 2023/1115 of the European parliament and of the Council is usually called the EU Deforestation Regulation and is abbreviated EUDR. <https://eur-lex.europa.eu/legal-content/EN/TXT/?uri=CELEX%3A32023R1115>

WasteNotificationNumber

The notification number in a notification document for transboundary movements/shipments of waste (ANNEX IA). For more information, please see the EU commission regulation (EC) No 1379/2007, <https://eur-lex.europa.eu>

SafetyAndEnvironmentalReferenceInfo

A group item containing reference information applicable to SafetyAndEnvironmentalInformation.

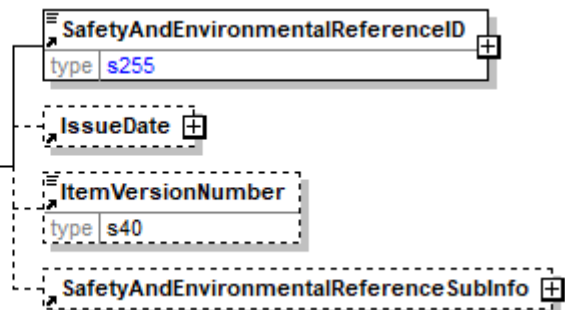

(sequence)

The sequence of items below is mandatory. A single instance is required.

SafetyAndEnvironmentalReferenceID

SafetyAndEnvironmentalReferenceID is mandatory. A single instance is required.
Identification for the item being referenced.

IssueDate

IssueDate is optional. A single instance might exist
The date and time when the item was issued.

ItemVersionNumber

ItemVersionNumber is optional. A single instance might exist
The assigned version number of an information item.
For example, version 2.1 of an item.

SafetyAndEnvironmentalReferenceSubInfo

SafetyAndEnvironmentalReferenceSubInfo is optional. A single instance might exist.

A group item containing reference information applicable to SafetyAndEnvironmentalReferenceInfo.

SafetyAndEnvironmentalReferenceSubID

Identification for the item being

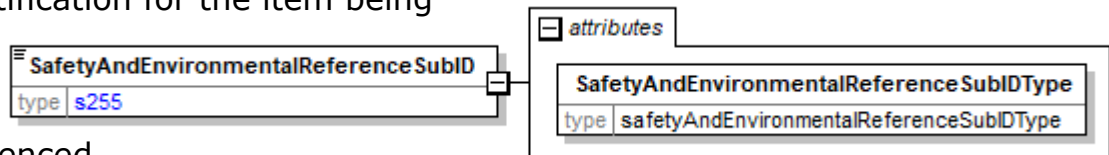

referenced.

SafetyAndEnvironmentalReferenceSubIDType [attribute]

SafetyAndEnvironmentalReferenceSubIDType is mandatory. A single instance is required.

Provides a contextual explanation of the specific reference identifier.

Refer to SafetyAndEnvironmentalReferenceSubIDType definition for any enumerations.

SafetyAndEnvironmentalReferenceSubIDType [attribute]

Provides a contextual explanation of the specific reference identifier.

This item is restricted to the following list.

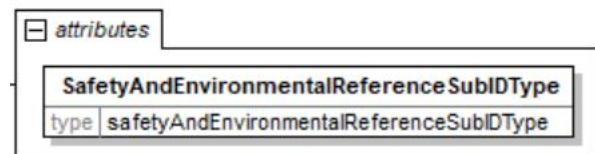

EUDRDueDiligenceStatementVerificationNumber

The verification number for accessing data of a due diligence statement registered in the information system of the EU Commission, as mandated by the EU Deforestation Regulation. It is assigned by the EU information system as the due diligence statement is created in this system.

This verification number must be provided to the information system of the EU Commission when requesting access to data of a particular due diligence statement in addition to its unique reference number.

Regulation (EU) 2023/1115 of the European parliament and of the Council is usually called the EU Deforestation Regulation and is abbreviated EUDR.

<https://eur-lex.europa.eu/legal-content/EN/TXT/?uri=CELEX%3A32023R1115>

WasteNotificationSerialNumber

The serial number in a movement document for transboundary movements/shipments of waste (ANNEX IB). For more information, please see the EU commission regulation (EC) No 1379/2007, <https://eur-lex.europa.eu>

SafetyAndEnvironmentalType [attribute]

The type of safety and environmental information being communicated. Defines any additional information relating to safety and/or environmental matters.

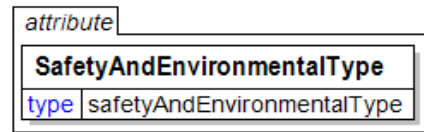

This item is restricted to the following list.

Agricultural

Biodegradable

CarbonFootprint

Total greenhouse gas (GHG) emissions caused by an organization, event, product or person, usually expressed in equivalent tonnes of carbon dioxide (CO₂).

Certified

Chemical

CSA

Canadian Standards Authority

Deforestation

Regulation for prevention of deforestation.

EMAS

The Eco-Management and Audit Scheme, EMAS, is a voluntary environmental management tool for companies and other organisations to evaluate, report and improve their environmental performance. EMAS promotes continuous evaluation and improvements in the environmental performance of participating organisations. (<http://ec.europa.eu/environment/emas/>)

Energy

FlamabilityReactivity

FSC

To be deprecated in a future version V3R00, use instead FSC100%, FSCMix_x%, FSCMixCredit, FSCRecycled_x%, FSCRecycledCredit or FSCControlledWood.

FSC100%

FSC-certified virgin material originating in FSC-certified forests or plantations that has not been mixed with material of another material category throughout the supply chain. FSC 100% products are eligible to be used in FSC 100% or FSC Mix product groups. (Forest Stewardship Council, <http://www.fsc.org>).

FSCControlledWood

Material originating in non FSC-certified forests or plantations supplied with an FSC claim by a supplier which has been assessed by an FSC-accredited certification body for conformity with FSC Chain of Custody and/or FSC Controlled Wood requirements (FSC-STD-40-005 or FSC-STD-30-010). (Forest Stewardship Council, <http://www.fsc.org>).

FSCMix_x%

FSC-certified virgin material based on input from FSC-certified, controlled and/or reclaimed sources, and supplied with a percentage claim. FSC Mix material is only eligible to be used in FSC Mix product groups.

(Forest Stewardship Council, <http://www.fsc.org>)

FSCMixCredit

FSC-certified virgin material based on input from FSC-certified, controlled and/or reclaimed sources, and supplied with a credit claim. FSC Mix material is only eligible to be used in FSC Mix product groups.

(Forest Stewardship Council, <http://www.fsc.org>)

FSCMixed

To be deprecated in a future version V3R00, use instead FSCMix_x% or FSCMixCredit,

Material contains a mixture of Forest Stewardship Council (FSC) certified material, reclaimed (recycled) material and/or controlled wood. It has been processed by an FSC chain of custody certified company, and has been identified as FSC Mixed. For more information about the Forest Stewardship Council, visit www.fsc.org.

FSCPure

To be deprecated in a future version V3R00, use instead FSC100%.

Material is 100% FSC material from a Forest Stewardship Council (FSC) certified forest. It has been sold and/or processed by an FSC chain of custody certified company, and has been identified as FSC Pure. For more information about the Forest Stewardship Council, visit <http://www.fsc.org>.

FSCRecycled

To be deprecated in a future version V3R00, use instead FSCRecycled_x% or FSCRecycledCredit.

This Forest Stewardship Council (FSC) product group contains 100% postconsumer reclaimed. Post-consumer reclaimed material includes wood and/or wood fiber that has been reclaimed from a product after that product has been used for its intended end-use purpose by individuals or businesses. For more information about the Forest Stewardship Council, visit www.fsc.org.

FSCRecycled_x%

FSC-certified reclaimed material based on exclusive input from reclaimed sources, and supplied with a percentage claim. FSC Recycled material or products are eligible to be used in FSC Mix or FSC Recycled product groups.

(Forest Stewardship Council, <http://www.fsc.org>)

FSCRecycledCredit

FSC-certified reclaimed material based on exclusive input from reclaimed sources, and supplied with a credit claim. FSC Recycled material or products are eligible to be used in FSC Mix or FSC Recycled product groups.

(Forest Stewardship Council, <http://www.fsc.org>)

HazardousMaterial

ISO14001

papiNet V2R31

ISO 14001 specifies the actual requirements for an environmental management system. It applies to those environmental aspects which the organization has control and over which it can be expected to have an influence.

ISO 14001 is often seen as the corner stone standard of the ISO 14000 series. However, it is not only the most well known, but is the only ISO 14000 standard against which it is currently possible to be certified by an external certification authority. Having stated this, it does not itself state specific environmental performance criteria.

This standard is applicable to any organization that wishes to:

- implement, maintain and improve an environmental management system
- assure itself of its conformance with its own stated environmental policy (those policy commitments of course must be made)
- demonstrate conformance
- ensure compliance with environmental laws and regulations
- seek certification of its environmental management system by an external third party organization
- make a self-determination of conformance

(<http://www.iso14000-iso14001-environmental-management.com/>)

MaterialSafetyData

MTCC

Malaysian Timber Certification Council

PEFC

To be deprecated in a future version V3R00, use instead X%_PEFCcertified. Program for the Endorsement of Forest Certification.

PEFCControlledSources

Material originating in non PEFC certified forests or plantations. "PEFC Controlled Sources" is material category "other material" and not "certified material" in PEFC due diligence system. Basic principle is to use "PEFC Controlled Sources" for all output products that cannot be sold as "X% PEFC Certified". Selling products as "PEFC Controlled Sources" requires full Chain of Custody certification. It also demonstrates that the PEFC due diligence system has been implemented and compliance with EU Timber Regulation.(PEFC, <http://pefc.org>)

PlantHealthInspection

Product is subject to plant health inspection. Samples may be taken of the material in order to inspect possible harmful insects or plant diseases.

Recycled

SFI

Sustainable Forestry Initiative

TransportationSafetyAlert

WasteMovement

Regulation for transboundary movements of waste.

X%_PEFCcertified

The claim "x % PEFC certified" shall be used when communicating the content of PEFC certified material.

Programme for the Endorsement of Forest Certification, <http://www.pefc.org>).

SalesOfficeParty

This named party represents the sales office involved in the business transaction. This party is only used in the communication of OrderStatus otherwise it is handled via OtherParty.

LogisticsRole [attribute]

LogisticsRole is optional. A single instance might exist.

Communicates the nature of the logistics role, if any, the party plays in the transaction.

Refer to LogisticsRole definition for any enumerations.

(sequence)

The sequence of items below is mandatory. A single instance is required.

PartyIdentifier

PartyIdentifier is optional. Multiple instances might exist.

A unique identifier of a specific party. This element contains an attribute PartyIdentifierType that indicates the type of the identifier.

NameAddress

NameAddress is mandatory. A single instance is required.

A group item containing name and address of an organisation or business entity.

URL

URL is optional. A single instance might exist.

Universal Resource Locator. While typically a web address you could use this field to hold an email address.

CommonContact

CommonContact is optional. Multiple instances might exist.

Identifies a specific individual associated with the party.

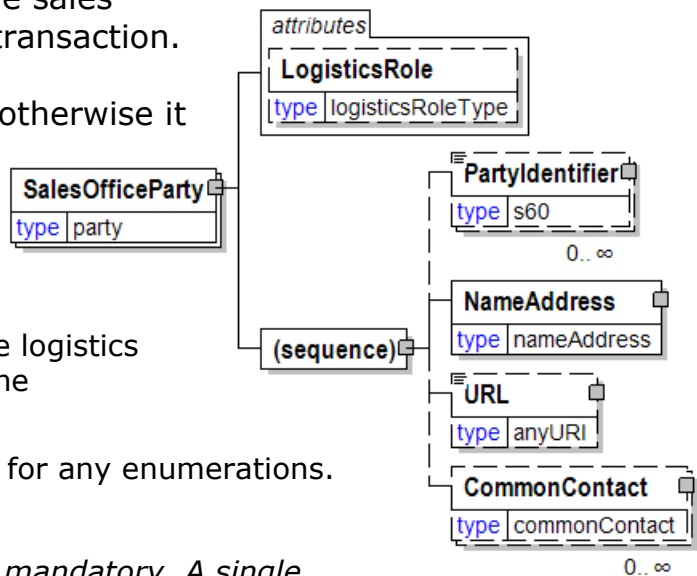

SampleCharacteristics

A grouping element that contains information related to a sample.

SampleReason [attribute]

SampleReason is optional. A single instance might exist.

Specifies the reason for selecting a sample.

Refer to SampleReason definition for any enumerations.

SampleSelectionType [attribute]

SampleSelectionType is optional. A single instance might exist.

Specifies the method for how the sample is selected.

Refer to SampleSelectionType definition for any enumerations.

(sequence)

The sequence of items below is mandatory. A single instance is required.

OtherParty

OtherParty is optional. Multiple instances might exist.

An organisation or business entity other than those specifically detailed within an e-Document.

QuantityInformation

QuantityInformation is optional. A single instance might exist.

A group item containing information about quantity and informational quantity of similar items.

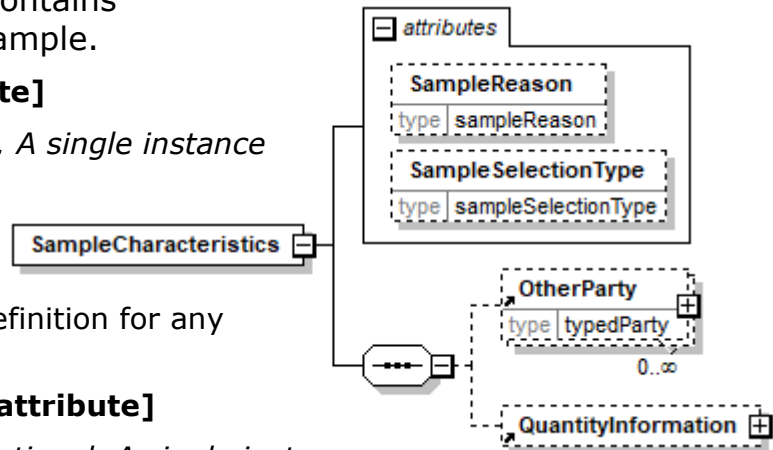

SampleReason [attribute]

Specifies the reason for selecting a sample.

This item is restricted to the following list.

ExternalAudit

The measurements of the selected sample to be audited by an external party for control of measurement accuracy.

PopulationUpdate

The selected sample to be measured in detail for update of population statistics.

SelfAudit

The measurements of the selected sample to be audited by the original measurer for control of measurement accuracy.



SampleSelectionType [attribute]

Specifies the method for how the sample is selected.

This item is restricted to the following list.

Automatic

The sample is selected automatically according to rules stored in the measuring system.

Manual

The sample is selected manually.

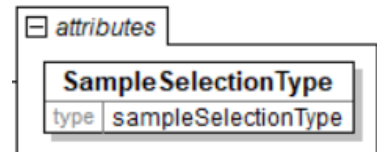

SampleSize

The number of samples used to determine the product characteristic in question.

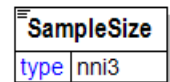

SampleType [attribute]

Communicates how sampling was done to measure the product characteristics.

This item is restricted to the following list.

Average

The measurement represents an average for the associated property.

Bottom

The measurement was obtained from the bottom of the paper sample.

CDAverage

The measurement represents the average of values in the cross-machine direction.

CDBottom

The measurement represents the average of tests taken in the cross-machine direction on the bottom of the paper sample.

CDTop

The measurement represents the average of tests taken in the cross-machine direction on the top of the paper sample.

MDAverage

The measurement represents the average of values in the machine direction.

MDBottom

The measurement represents the average of tests taken in the machine direction on the bottom of the paper sample.

MDTop

The measurement represents the average of tests taken in the machine

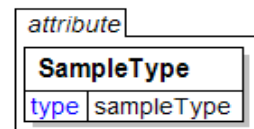

direction on the top of the paper sample.

Target

When communicating specifications a target value is communicated.

Top

The measurement was obtained from the top of the paper sample

Saturation

Measure of colour Saturation in the HSB method of communicating colour.

(sequence)

The sequence of items below is mandatory. A single instance is required.

DetailValue

DetailValue is mandatory. A single instance is required.

A numeric value expressed in the unit of measure (UOM).

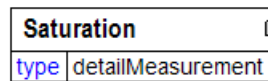

DetailRangeMin

DetailRangeMin is optional. A single instance might exist.

The minimum value (lower boundary) allowed for the DetailValue that is the parent of this element.

DetailRangeMax

DetailRangeMax is optional. A single instance might exist.

The maximum value (upper boundary) allowed for the DetailValue that is the parent of this element.

StandardDeviation

StandardDeviation is optional. A single instance might exist.

A statistic used as a measure of dispersion in a distribution.

SampleSize

SampleSize is optional. A single instance might exist.

The number of samples used to determine the product characteristic in question.

TwoSigmaLower

TwoSigmaLower is optional. A single instance might exist.

Two sigma (a measure of dispersion associated with standard deviation) on the lower side of the standard deviation.

TwoSigmaUpper

TwoSigmaUpper is optional. A single instance might exist.

Two sigma (a measure of dispersion associated with standard deviation) on the upper side of the standard deviation.

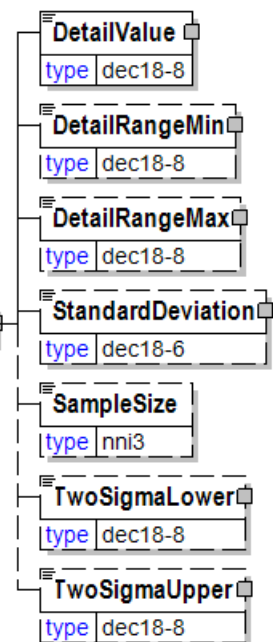

Sawdust

Used to report sawdust content in chips as a detail measurement.

TestMethod [attribute]

TestMethod is optional. A single instance might exist.

The method used to determine the results of the test under consideration.

TestAgency [attribute]

TestAgency is optional. A single instance might exist.

The agency that has set the parameters for the testing

Refer to TestAgency definition for any enumerations.

SampleType [attribute]

SampleType is optional. A single instance might exist.

Communicates how sampling was done to measure the product characteristics.

Refer to SampleType definition for any enumerations.

ResultSource [attribute]

ResultSource is optional. A single instance might exist.

Used to define the data source of the specified test

Refer to ResultSource definition for any enumerations.

(sequence)

The sequence of items below is mandatory. A single instance is required.

DetailValue

DetailValue is mandatory. A single instance is required.

A numeric value expressed in the unit of measure (UOM).

DetailRangeMin

DetailRangeMin is optional. A single instance might exist.

The minimum value (lower boundary) allowed for the DetailValue that is the parent of this element.

DetailRangeMax

DetailRangeMax is optional. A single instance might exist.

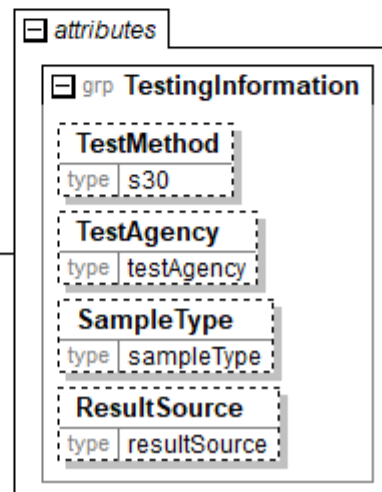
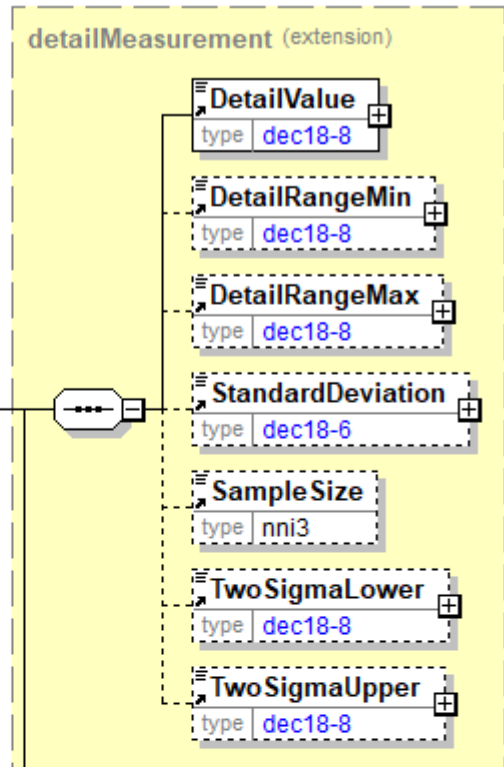

papiNet V2R31

The maximum value (upper boundary) allowed for the DetailValue that is the parent of this element.

StandardDeviation

StandardDeviation is optional. A single instance might exist.

A statistic used as a measure of dispersion in a distribution.

SampleSize

SampleSize is optional. A single instance might exist.

The number of samples used to determine the product characteristic in question.

TwoSigmaLower

TwoSigmaLower is optional. A single instance might exist.

Two sigma (a measure of dispersion associated with standard deviation) on the lower side of the standard deviation.

TwoSigmaUpper

TwoSigmaUpper is optional. A single instance might exist.

Two sigma (a measure of dispersion associated with standard deviation) on the upper side of the standard deviation.

ScaleHouseID

Unique identifier for the specific scale house.

ScaleHouseID
type s60

ScaleHouseIn

Used to identify scale weight received into a yard, the scale house id, name, and scaler name.

(sequence)

The sequence of items below is mandatory. A single instance is required.

ScaleHouseID

ScaleHouseID is optional. A single instance might exist.

Unique identifier for the specific scale house.

ScaleHouseName

ScaleHouseName is optional. A single instance might exist.

Name assigned to the scale house.

ScalerID

ScalerID is optional. A single instance might exist.

Unique identifier for the person staffing the scale house. Might be an employee number.

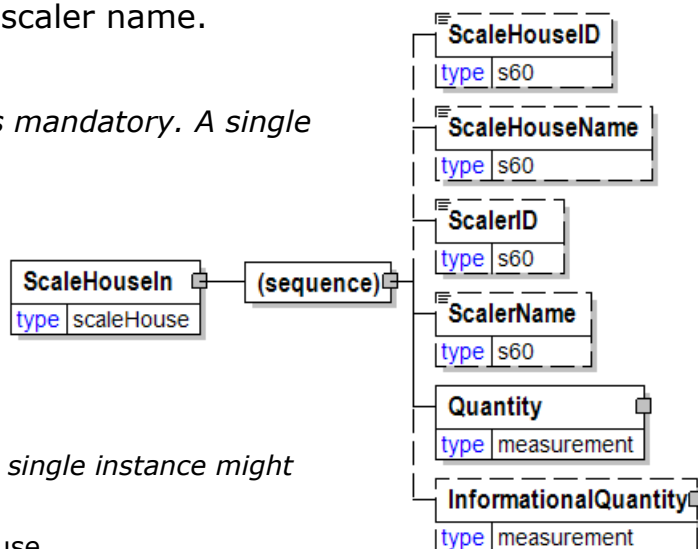

ScalerName

ScalerName is optional. A single instance might exist.

Name of the person staffing the scale house.

Quantity

Quantity is mandatory. A single instance is required.

The Quantity element contains attributes that provide information about the type of quantity that is being communicated, the context in which the particular quantity is to be viewed, and (if the quantity represents an adjustment) an adjustment type.

The Quantity element contains three child elements that enable you to communicate a range of values for the quantity and a target or actual value. It is at this level (Value, RangeMin, and RangeMax) that the unit of measure is specified. This permits the range to be specified in a different unit of measure than the target.

InformationalQuantity

InformationalQuantity is optional. A single instance might exist.

A quantity given in a valid UOM used for information purposes only (not for calculation). For example, an ordered quantity was 100 reels as opposed to the invoice quantity of 20,000 pounds.

ScaleHouseInfo

Scale house information.

(sequence)

The sequence of items below is mandatory. A single instance is required.

ScaleHouseIn

ScaleHouseIn is optional. A single instance might exist.

Used to identify scale weight received into a yard, the scale house id, name, and scaler name.

ScaleHouseOut

ScaleHouseOut is optional. A single instance might exist.

Used to identify scale weight departing a yard, the scale house id, name, and scaler name.

ScaleHouseTicketNumber

ScaleHouseTicketNumber is optional. A single instance might exist.

The ticket number issued by the scale house. Does not have to be unique.

ArrivalDate

ArrivalDate is optional. A single instance might exist.

The date of arrival.

DepartureDate

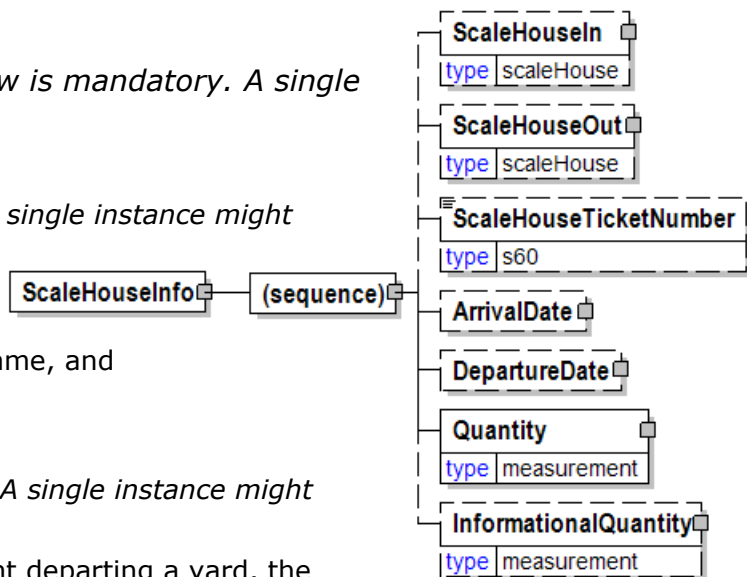

papiNet V2R31

DepartureDate is optional. A single instance might exist.

The required or actual date of departure.

Quantity

Quantity is mandatory. A single instance is required.

The Quantity element contains attributes that provide information about the type of quantity that is being communicated, the context in which the particular quantity is to be viewed, and (if the quantity represents an adjustment) an adjustment type.

The Quantity element contains three child elements that enable you to communicate a range of values for the quantity and a target or actual value. It is at this level (Value, RangeMin, and RangeMax) that the unit of measure is specified. This permits the range to be specified in a different unit of measure than the target.

InformationalQuantity

InformationalQuantity is optional. A single instance might exist.

A quantity given in a valid UOM used for information purposes only (not for calculation). For example, an ordered quantity was 100 reels as opposed to the invoice quantity of 20,000 pounds.

ScaleHouseName

Name assigned to the scale house.

ScaleHouseName
type s60

ScaleHouseOut

Used to identify scale weight departing a yard, the scale house id, name, and scaler name.

(sequence)

The sequence of items below is mandatory. A single instance is required.

ScaleHouseID

ScaleHouseID is optional. A single instance might exist.

Unique identifier for the specific scale house.

ScaleHouseName

ScaleHouseName is optional. A single instance might exist.

Name assigned to the scale house.

ScalerID

ScalerID is optional. A single instance might exist.

Unique identifier for the person staffing the scale house. Might be an employee number.

ScalerName

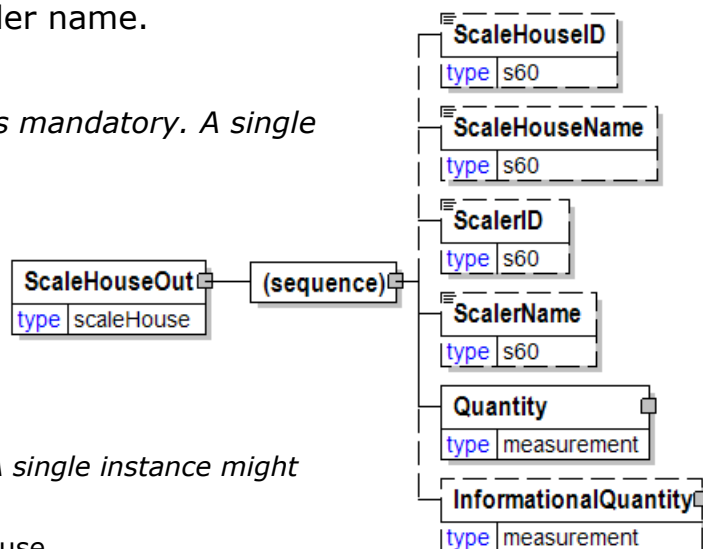

papiNet V2R31

ScalerName is optional. A single instance might exist.

Name of the person staffing the scale house.

Quantity

Quantity is mandatory. A single instance is required.

The Quantity element contains attributes that provide information about the type of quantity that is being communicated, the context in which the particular quantity is to be viewed, and (if the quantity represents an adjustment) an adjustment type.

The Quantity element contains three child elements that enable you to communicate a range of values for the quantity and a target or actual value. It is at this level (Value, RangeMin, and RangeMax) that the unit of measure is specified. This permits the range to be specified in a different unit of measure than the target.

InformationalQuantity

InformationalQuantity is optional. A single instance might exist.

A quantity given in a valid UOM used for information purposes only (not for calculation). For example, an ordered quantity was 100 reels as opposed to the invoice quantity of 20,000 pounds.

ScaleHouseTicketNumber

The ticket number issued by the scale house. Does not have to be unique.

ScaleHouseTicketNumber	
type	s60

ScalerID

Unique identifier for the person staffing the scale house. Might be an employee number.

ScalerID	
type	s60

ScalerName

Name of the person staffing the scale house.

ScalerName	
type	s60

ScaleTicket

The ScaleTicket element is the root element for the ScaleTicket e-Document.

The ScaleTicket e-Document provides wood or fibre suppliers with a means to electronically incorporate scale system receiving data into their accounting systems from buying entities' back office systems.

ScaleTicketStatusType [attribute]

ScaleTicketStatusType is mandatory. A single instance is required.

ScaleTicket Status Type

Refer to ScaleTicketStatusType definition for any enumerations.

ScaleTicketAcceptance [attribute]

ScaleTicketAcceptance is mandatory. A single instance is required.

Defines the state of the goods received as compared to the DeliveryMessage specifications. The enumeration list is the list of choices that apply to the GoodsReceipt header and line item.

Refer to ScaleTicketAcceptance definition for any enumerations.

ScaleTicketRejectedType [attribute]

ScaleTicketRejectedType is optional. A single instance might exist.

ScaleTicketRejectedType

Refer to ScaleTicketRejectedType definition for any enumerations.

Reissued [attribute]

Reissued is optional. A single instance might exist.

Either "Yes" or "No".

Refer to Reissued definition for any enumerations.

Language [attribute]

Language is optional. A single instance might exist.

The valid Alpha 2- and Alpha 3-character list of language codes in the ISO 639-1 and 639-2 international standards.

Information on the content of this attribute is available at:
https://www.loc.gov/standards/iso639-2/php/code_list.php

(sequence)

The sequence of items below is mandatory. A single instance is required.

ScaleTicketHeader

ScaleTicketHeader is mandatory. A single instance is required.

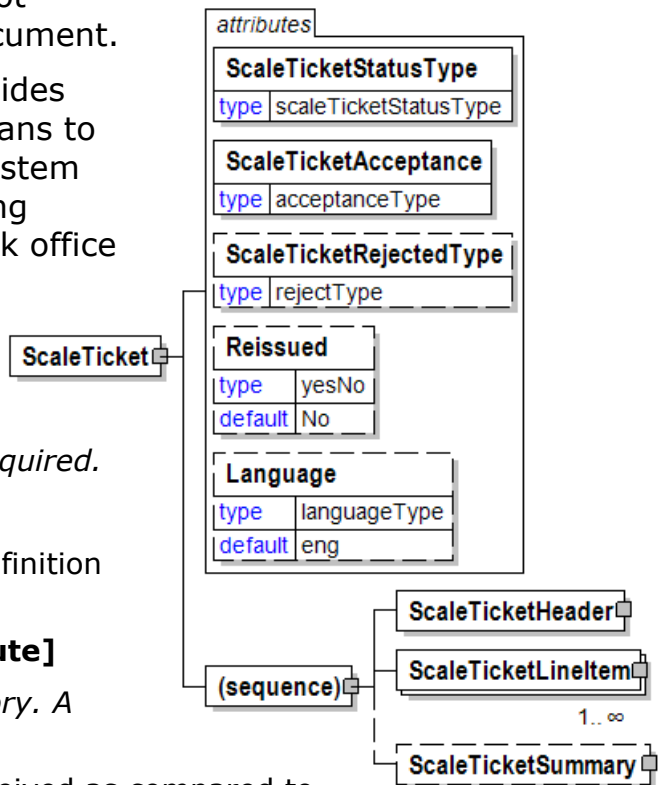

papiNet V2R31

Information that is common for the ScaleTicket e-Document.

ScaleTicketLineItem

ScaleTicketLineItem is mandatory. One instance is required, multiple instances might exist.

The details for each item reported on a ScaleTicket e-Document.

ScaleTicketSummary

ScaleTicketSummary is optional. A single instance might exist.

Summary information for the ScaleTicket e-Document.

ScaleTicketAcceptance [attribute]

Defines the state of the goods received as compared to the DeliveryMessage specifications. The enumeration list is the list of choices that apply to the GoodsReceipt header and line item.

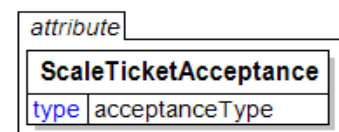

This item is restricted to the following list.

GoodsReceivedAsIs

The delivered goods were received without inspection, or checking of the goods for damage, or accuracy against the DeliveryMessage.

GoodsReceivedAsSpecified

Received goods agree completely with all DeliveryMessage specifications for all lines including item identifiers and item weights. There is no transit damage.

GoodsReceivedCancelled

Received goods notification is being cancelled. This value is only used when the GoodsReceiptStatusType is "Cancelled".

GoodsReceivedRejected

Received goods agree completely with all DeliveryMessage specifications for all lines including item identifiers and item weights; but there has been transit damage resulting in rejection of all goods.

GoodsReceivedWithDamage

Received goods agree completely with all DeliveryMessage specifications for all lines including item identifiers and item weights; but there has been transit damage of some items. All transit damages must be specified.

GoodsReceivedWithVariance

Received goods do not agree completely with the DeliveryMessage specifications. For those items at variance, actual received item identifiers and item weights must be specified.

Additionally, used with the VarianceType of "NotReceived" to indicate items that was on the DeliveryMessage but not in the Delivery as received.

GoodsReceivedWithVarianceAndDamage

Received goods do not agree completely with all DeliveryMessage specifications for all lines including item identifiers and item weights and there has been transit damage of some items. For those items at variance or with

transit damage, actual received item identifiers, item weights, and transit damages must be specified.

ScaleTicketHeader

Information that is common for the ScaleTicket e-Document.

(sequence)

The sequence of items below is mandatory. A single instance is required.

ScaleTicketNumber

ScaleTicketNumber is mandatory. A single instance is required.

Unique identifier for the ScaleTicket e-Document.

TransactionHistoryNumber

TransactionHistoryNumber is mandatory. A single instance is required.

A sequential number that keeps track of the version of a document.

However when the document is a confirmation document, in which case the



TransactionHistoryNumber refers to the trigger transaction for the confirmation.

ScaleTicketIssueDate

ScaleTicketIssueDate is mandatory. A single instance is required.

The date and time when the ScaleTicket was issued.

ScaleTicketReference

ScaleTicketReference is optional. Multiple instances might exist.

An element that details the relevant references pertaining to the ScaleTicket.

Identifies the previous unique document ID that this document replaces, if applicable.

Mandatory if Purpose = Replace.

ScaleHouseInfo

ScaleHouseInfo is mandatory. A single instance is required.

Scale house information.

BuyerParty

BuyerParty is mandatory. A single instance is required.

The legal entity to which the product is sold. Also commonly referred to as the sold-

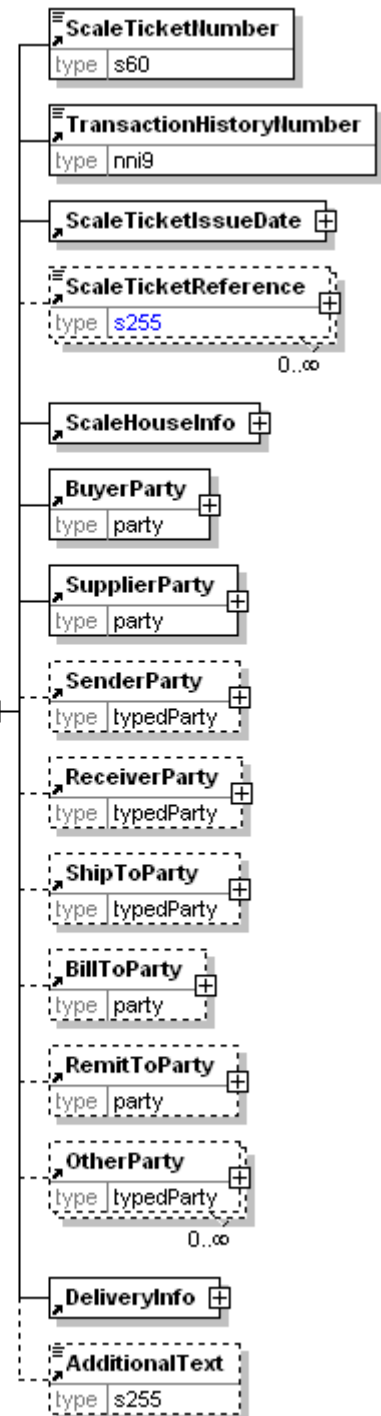

to party or customer. If no OtherParty is defined as the Payer, the Buyer is the Payer.

SupplierParty

SupplierParty is mandatory. A single instance is required.

The organisation or business entity responsible for providing the product. SupplierParty is also the seller of the product, if Seller is not specified as OtherParty = Seller.

SenderParty

SenderParty is optional. A single instance might exist.

The business entity issuing the e-Document, the source of the document.

The entity responsible for the content. If the sender party has out sourced the message service to a third party the SenderParty is the issuer of the e-Document and not the party performing the transmission service of the electronic message.

ReceiverParty

ReceiverParty is optional. A single instance might exist.

The business entity for whom the e-Document is intended, the destination of the document.

The entity interested in the content. If the receiver party has outsourced the message service to a third party the ReceiverParty is the intended party for the e-Document and not the party performing the receiving service of the electronic message.

ShipToParty

ShipToParty is optional. A single instance might exist.

The name and/or address to which the goods should be delivered with the party type indicated by the PartyType attribute.

BillToParty

BillToParty is optional. A single instance might exist.

The address where the invoice is to be sent.

RemitToParty

RemitToParty is optional. A single instance might exist.

A group item containing details of the party to whom payment will be made. The RemitToParty contains all information related to remittance.

OtherParty

OtherParty is optional. Multiple instances might exist.

An organisation or business entity other than those specifically detailed within an e-Document.

DeliveryInfo

DeliveryInfo is mandatory. A single instance is required.

Information about the delivery.

AdditionalText

AdditionalText is optional. A single instance might exist.

A text field that is used to communicate information not previously defined or for special instructions. To be used only for circumstances not covered by specific

elements.

ScaleTicketIssueDate

The date and time when the ScaleTicket was issued.

(sequence)

The sequence of items below is mandatory. A single instance is required.

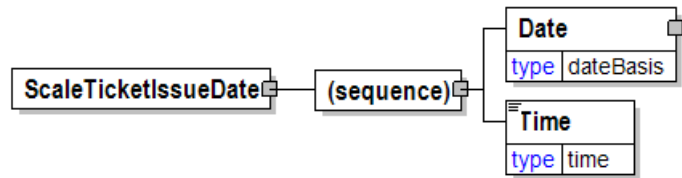

Date

Date is mandatory. A single instance is required.

A group element that contains the specification of Year, Month, and Day.

Time

Time is mandatory. A single instance is required.

Times are treated in a standard XML fashion with a special case used to indicate a generalized "local" time. The standard XML approach to time is hh:mm:ss, hh:mm:ssZ, or hh:mm:ss±hh:mm.

hh:mm:ss±hh:mm is used to represent a time with a time zone. The time zone is communicated as the number of hours offset from the Universal Time Coordinate (UTC), a.k.a. Greenwich Mean Time.

hh:mm:ssZ indicates the time at Zulu (another name for UTC).

hh:mm:ss or hh:mm indicates within papiNet the applicable local time where the associated event is taking place. Caution should be used when processing times of this nature as the papiNet approach may be in discord with other users of XML.

ScaleTicketLineItem

The details for each item reported on a ScaleTicket e-Document.

ScaleTicketAcceptance [attribute]

ScaleTicketAcceptance is mandatory. A single instance is required.

Defines the state of the goods received as compared to the DeliveryMessage specifications. The enumeration list is the list of choices that apply to the GoodsReceipt header and line item.

Refer to ScaleTicketAcceptance definition for any enumerations.

ScaleTicketRejectedType [attribute]

ScaleTicketRejectedType is optional. A single instance might exist.

ScaleTicketRejectedType

Refer to ScaleTicketRejectedType definition for any enumerations.

(sequence)

The sequence of items below is mandatory. A single instance is required.

ScaleTicketLineNumber

ScaleTicketLineNumber is mandatory. A single instance is required.

ScaleTicket Line Number

Product

Product is mandatory. A single instance is required.

Product is a group item defining the article and its characteristics. Product is used to specify product characteristics organized by ProductIdentifier, ProductDescription, and Classification. Book Manufacturing, Label Stock, Paper, Pulp, Recovered Paper, Wood Products, and Virgin Fibre market segments have defined their product characteristics and conversion features for implementation in papiNet.

Quantity

Quantity is mandatory. A single instance is required.

The Quantity element contains attributes that provide information about the type of quantity that is being communicated, the context in which the particular quantity is to be viewed, and (if the quantity represents an adjustment) an adjustment type.

The Quantity element contains three child elements that enable you to communicate a range of values for the quantity and a target or actual value. It is at this level (Value, RangeMin, and RangeMax) that the unit of measure is specified. This permits the range to be specified in a different unit of measure than the target.

InformationalQuantity

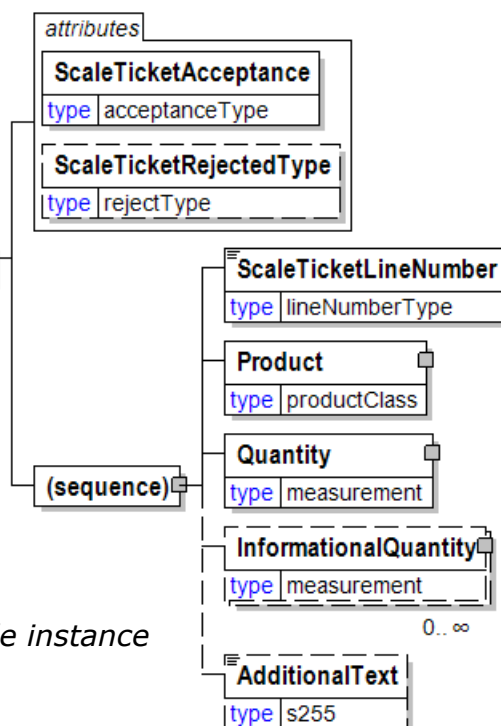

papiNet V2R31

InformationalQuantity is optional. Multiple instances might exist.

A quantity given in a valid UOM used for information purposes only (not for calculation). For example, an ordered quantity was 100 reels as opposed to the invoice quantity of 20,000 pounds.

AdditionalText

AdditionalText is optional. A single instance might exist.

A text field that is used to communicate information not previously defined or for special instructions. To be used only for circumstances not covered by specific elements.

ScaleTicketLineNumber

ScaleTicket Line Number

ScaleTicketLineNumber
type lineNumberType

ScaleTicketNumber

Unique identifier for the ScaleTicket e-Document.

ScaleTicketNumber
type s60

ScaleTicketReference

An element that details the relevant references pertaining to the ScaleTicket.

Identifies the previous unique document ID that this document replaces, if applicable.

ScaleTicketReference
type s255

attributes
ScaleTicketReferenceType
type referenceType
AssignedBy
type assignedBy

Mandatory if Purpose = Replace.

ScaleTicketReferenceType [attribute]

ScaleTicketReferenceType is mandatory. A single instance is required.

ScaleTicketReferenceType indicates what type of reference is being communicated.

ScaleTicketReferenceType indicates what type of reference is being communicated. Many items are currently prefixed by "Buyer", "Customer", "Seller", and/or "Supplier". Check for an existing non-prefixed version and use the non-prefixed version instead. In the (yet to be announced release date) version 3.0 the prefixed versions will be removed. Instead the attribute @AssignedBy will communicate the information previously communicated in the prefix.

Refer to ScaleTicketReferenceType definition for any enumerations.

AssignedBy [attribute]

AssignedBy is optional. A single instance might exist.

papiNet V2R31

Identifies the type of party or the agency that has assigned the associated item, e.g. a reference of type OrderNumber.

Refer to AssignedBy definition for any enumerations.

ScaleTicketReferenceType [attribute]

ScaleTicketReferenceType indicates what type of reference is being communicated.

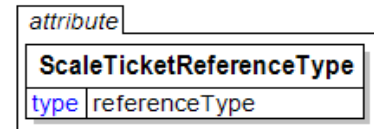

ScaleTicketReferenceType indicates what type of reference is being communicated. Many items are currently prefixed by "Buyer", "Customer", "Seller", and/or "Supplier". Check for an existing non-prefixed version and use the non-prefixed version instead. In the (yet to be announced release date) version 3.0 the prefixed versions will be removed. Instead the attribute @AssignedBy will communicate the information previously communicated in the prefix.

Refer to the [referenceType](#) entry for the list of enumerations and their definitions.

ScaleTicketRejectedType [attribute]

ScaleTicketRejectedType

This item is restricted to the following list.

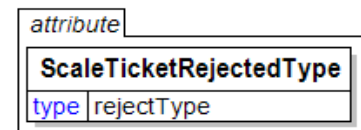

ExcessiveTransitDamage

The item(s) is/are damaged beyond acceptable use during transit.

ProductQuality

The delivery did not match the quality of the product ordered or requested.

TooEarly

The delivery has occurred prior to the agreed delivery date/time. For example, there is insufficient storage at the delivered time.

TooLate

The delivery has occurred after the agreed delivery date/time. For example, delivered after press date.

UnableToUnload

The delivered items cannot be unloaded. For example, damaged vehicle doors, load has shifted during transportation, or ShipTo requires reels to be palletised but they are delivered on the vehicle floor.

WrongBarCode

The barcode used to identify the product is incorrect.

WrongBasisWeight

The basis weight of the product is not what was ordered.

WrongDeliveryLocation

The product was delivered to the wrong location.

WrongDiameter

The diameter delivered is unusable. For example, a physical limitation on a reel stand is exceeded.

WrongLabel

The delivered item has incorrect or missing information, or incorrect label stock that would prevent its use. For example, insufficient peel-off barcode labels.

WrongProduct

The delivered item was not the product ordered or requested.

WrongReelWidth

The width of the reel is incorrect.

WrongVehicleType

The items have been delivered in a vehicle that cannot be unloaded at the ShipTo facility. For example, the ShipTo requires side unloading vehicles, but the delivery vehicle can only be unloaded from the rear.

WrongWrap

The delivered item is wrapped in material that will prevent its use. For example, a hole is not present in the end cap for vacuum lifting.

ScaleTicketStatusType [attribute]

ScaleTicket Status Type

This item is restricted to the following list.

Amended

The supplied information is changed.

Cancelled

The supplied information has been cancelled. Items that have been cancelled are not included in totals on the summary levels of the e-Document.

Original

The supplied information is the first version of that information.

Replaced

The supplied information is replacing earlier supplied information. The receiver should revalidate the information in their system based upon the entire information received.

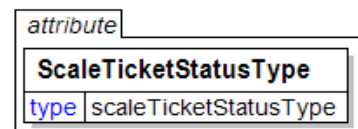

ScaleTicketSummary

Summary information for the ScaleTicket e-Document.

(sequence)

The sequence of items below is mandatory. A single instance is

required.

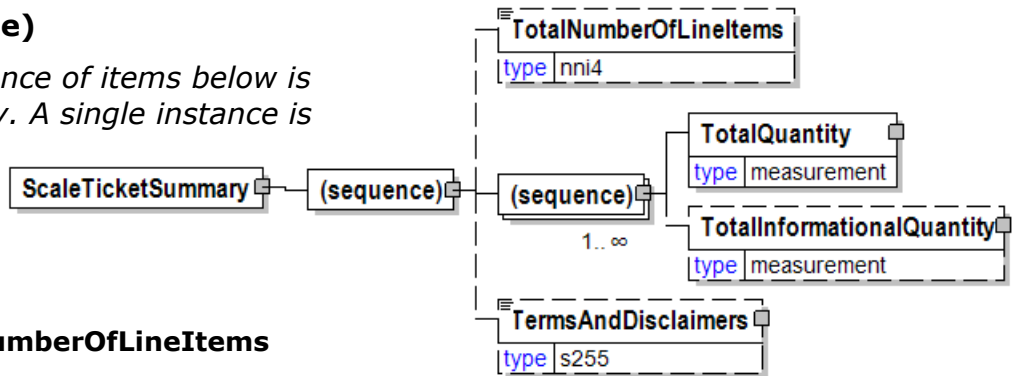

TotalNumberOfLineItems

TotalNumberOfLineItems is optional. A single instance might exist.

The total number of individual line items in the document, regardless of the status or type.

(sequence)

The sequence of items below is mandatory. One instance is required, multiple instances might exist.

TotalQuantity

TotalQuantity is mandatory. A single instance is required.

The total quantity of similar items in the e-Document. TotalQuantity is primarily used in the summary section of documents where it is repeatable to permit totaling for different units of measure.

TotalInformationalQuantity

TotalInformationalQuantity is optional. A single instance might exist.

A quantity that is used to communicate related information about the parent element. This element represents a total that is derived from individual line items.

TermsAndDisclaimers

TermsAndDisclaimers is optional. A single instance might exist.

An element that contains legal information with an indication of what the Language is.

Scored [attribute]

Is this item scored?

This item is restricted to the following list.

Yes

No

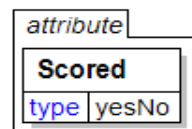

Screened [attribute]

Either "Yes" or "No".

This item is restricted to the following list.

Yes

No

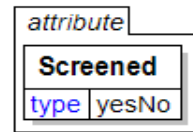

Seasoning

Describes drying/ moisture control method.

SeasoningType [attribute]

SeasoningType is optional. A single instance might exist.

Seasoning type, the classification and methodology of seasoning applied to the product.

Refer to SeasoningType definition for any enumerations.

(sequence)

The sequence of items below is mandatory. A single instance is required.

AdditionalText

AdditionalText is optional. A single instance might exist.

A text field that is used to communicate information not previously defined or for special instructions. To be used only for circumstances not covered by specific elements.

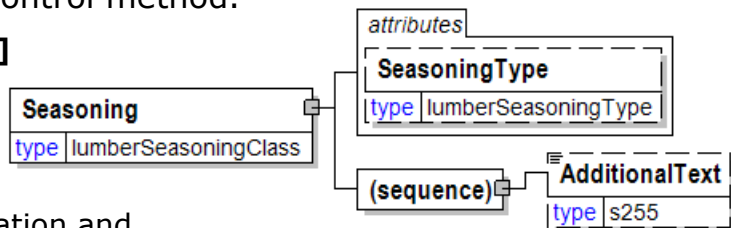

SeasoningType [attribute]

Seasoning type, the classification and methodology of seasoning applied to the product.

This item is restricted to the following list.

Dry

Air dried lumber that is not surfaced, i.e. rough lumber.

Green

Not dried by any method.

KD

Kiln dried.

KDAT

Kiln dried after treatment, i.e. chemically treated, then redried.

PAD

Partially air dried. In practice, doesn't mean much, since you don't know how dry. Most commonly used on boards

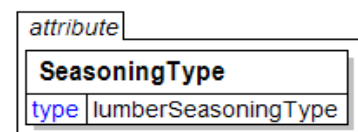

ShippingDry

Dried sufficiently to enable shipment without any deterioration in condition.

SurfacedDry

Surfaced-dry, meaning the product was dried (manner unspecified) and then surfaced (i.e. planed). Level of dryness is understood to be as required by the grading standard for the species in question. Generally it means the product was air dried to the standard, but it could have been kiln dried.

SurfacedGreen

Surfaced while still green.

Secure [attribute]

This attribute indicates that the product requires a secure manufacturing plant. For example when manufacturing ACT booklets and other testing products.

This item is restricted to the following list.

Yes

No

attribute	
Secure	
type	yesNo
default	No

SenderParty

The business entity issuing the e-Document, the source of the document.

The entity responsible for the content. If the sender party has out sourced the message service to a third party the SenderParty is the issuer of the e-Document and not the party performing the transmission service of the electronic message.

SenderParty	
type	typedParty

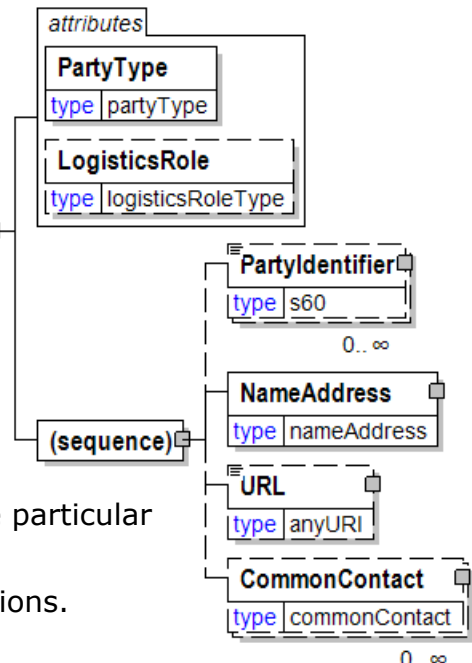

PartyType [attribute]

PartyType is mandatory. A single instance is required.

Identifies the business role associated with the particular party

Refer to PartyType definition for any enumerations.

LogisticsRole [attribute]

LogisticsRole is optional. A single instance might exist.

Communicates the nature of the logistics role, if any, the party plays in the transaction.

Refer to LogisticsRole definition for any enumerations.

(sequence)

papiNet V2R31

The sequence of items below is mandatory. A single instance is required.

PartyIdentifier

PartyIdentifier is optional. Multiple instances might exist.

A unique identifier of a specific party. This element contains an attribute PartyIdentifierType that indicates the type of the identifier.

NameAddress

NameAddress is mandatory. A single instance is required.

A group item containing name and address of an organisation or business entity.

URL

URL is optional. A single instance might exist.

Universal Resource Locator. While typically a web address you could use this field to hold an email address.

CommonContact

CommonContact is optional. Multiple instances might exist.

Identifies a specific individual associated with the party.

SenderProductAttributesDescription

An element containing free text used to describe the set of products sent in the ProductAttributes.

Language [attribute]

Language is optional. A single instance might exist.

SenderProductAttributesDescription	
type	s72

attributes	
Language	
type	languageType
default	eng

The valid Alpha 2- and Alpha 3-character list of language codes in the ISO 639-1 and 639-2 international standards.

Information on the content of this attribute is available at:
https://www.loc.gov/standards/iso639-2/php/code_list.php

SenderProductAttributesIdentifier

A unique identifier assigned to the combination of products, properties, and ReceivingParty that makes this list of ProductAttributes unique from the SendingParty's point of view. Subsequent ProductAttributes with updates will use this same identifier.

SenderProductAttributesIdentifier	
type	s30

SenderProductAttributesName

The name given to the set of products sent in the ProductAttributes e-Document.

SenderProductAttributesName	
type	s45

SequenceNumber

A sequential number that uniquely identifies a sequence.

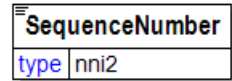

ServiceCharacteristics

A grouping element that contains information related to the service.

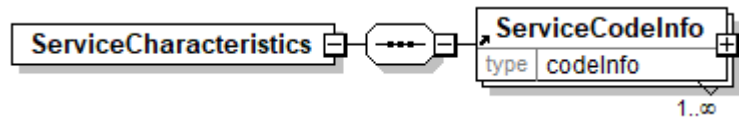

(sequence)

The sequence of items below is mandatory. A single instance is required.

ServiceCodeInfo

ServiceCodeInfo is mandatory. One instance is required, multiple instances might exist.

A grouping element that contains information about service codes defining the characteristics of the service.

ServiceCodeInfo

A grouping element that contains information about service codes defining the characteristics of the service.

Agency [attribute]

Agency is mandatory. A single instance is required.

Describes the agency maintaining the list of codes. To be included in this list the agency must be a recognized standards body or industry organisation.

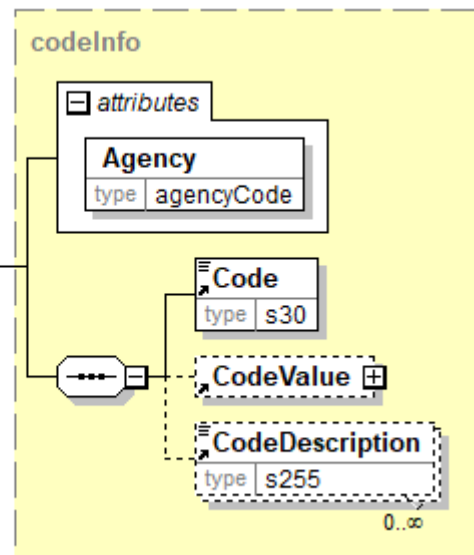
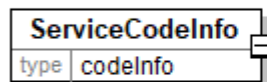

- For the element that owns this attribute.
- For another attribute in the list of attributes associated with the parent element.

Refer to Agency definition for any enumerations.

(sequence)

The sequence of items below is mandatory. A single instance is required.

Code

Code is mandatory. A single instance is required.

Specifies a code that is defined by an agency. The agency is given for the whole construct containing the code.

CodeValue

CodeValue is optional. A single instance might exist.

A grouping element specifying a value belonging to a code that is defined by an agency.

CodeDescription

CodeDescription is optional. Multiple instances might exist.

A textual description for the meaning of a code that is defined by an agency. When the Code is associated with a CodeValue of type TextValue, then the CodeDescription is a textual description of both the Code and the TextValue.

ServiceInstruction

The ServiceInstruction element is the root element for the ServiceInstruction e-Document.

The ServiceInstruction e-Document can be used to instruct a party to carry out a service. Characteristics for the service can be specified.

Instructions for deliveries and measuring of products have dedicated e-Documents DeliveryInstruction and MeasuringInstruction.

The ServiceInstructionType controls the usage of the ServiceInstruction e-Document. For example, it can be used to instruct what products to produce in a forest logging operation or how to carry out destining of products to end users.

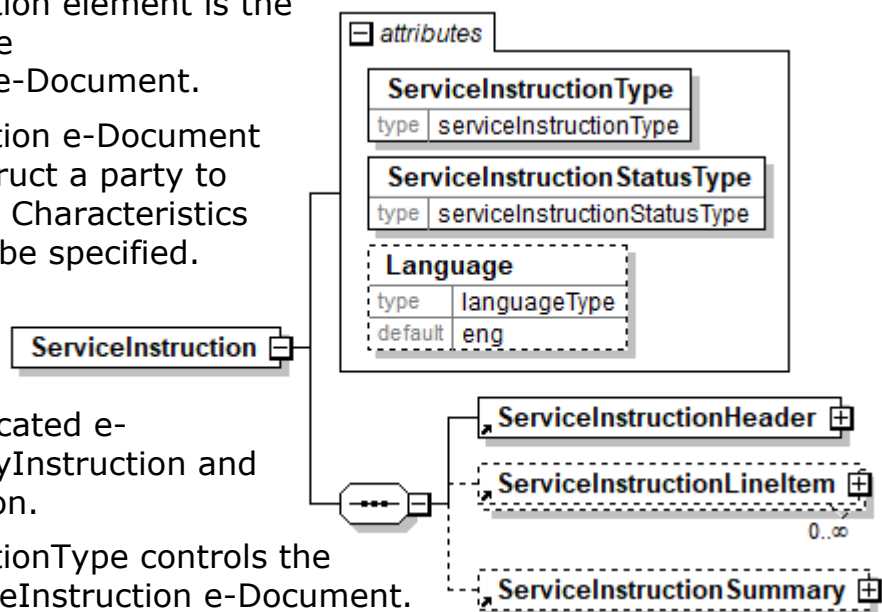

ServiceInstructionType [attribute]

ServiceInstructionType is mandatory. A single instance is required.

ServiceInstructionType defines the type of ServiceInstruction e-Document. Refer to ServiceInstructionType definition for any enumerations.

ServiceInstructionStatusType [attribute]

ServiceInstructionStatusType is mandatory. A single instance is required.

Identifies the status of the entire ServiceInstruction e-Document.

Refer to ServiceInstructionStatusType definition for any enumerations.

Language [attribute]

Language is optional. A single instance might exist.

The valid Alpha 2- and Alpha 3-character list of language codes in the ISO 639-1 and 639-2 international standards.

Information on the content of this attribute is available at:
https://www.loc.gov/standards/iso639-2/php/code_list.php

(sequence)

The sequence of items below is mandatory. A single instance is required.

ServiceInstructionHeader

ServiceInstructionHeader is mandatory. A single instance is required.

The MeasuringTicketHeader contains information common to the entire MeasuringTicket e-Document.

ServiceInstructionLineItem

ServiceInstructionLineItem is optional. Multiple instances might exist.

A grouping element that contains information for a line item of the ServiceInstruction. The line item specifies detail information associated with a product.

ServiceInstructionSummary

ServiceInstructionSummary is optional. A single instance might exist.

A grouping element that contains summary information that applies to the entire ServiceInstruction e-Document.

ServiceInstructionHeader

The ServiceInstructionHeader contains information common to the entire ServiceInstruction e-Document.

ServiceInstructionNumber

ServiceInstructionNumber mandatory. A single instance is required.

The unique identifier of a ServiceInstruction e-Document.

DocumentIssueDate

DocumentIssueDate is mandatory. A single instance is required.

The date and time when the e-Document was issued.

TransactionHistoryNumber

TransactionHistoryNumber is optional. A single instance might exist.

A

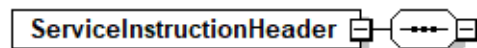

sequential number that keeps track of the version of a document.

However when the document is a confirmation document, in which case the TransactionHistoryNumber refers to the trigger transaction for the confirmation.

SenderParty

SenderParty is optional. A single instance might exist.

The business entity issuing the e-Document, the source of the document.

The entity responsible for the content. If the sender party has out sourced the message service to a third party the SenderParty is the issuer of the e-Document and not the party performing the transmission service of the electronic message.

ReceiverParty

ReceiverParty is optional. Multiple instances might exist.

The business entity for whom the e-Document is intended, the destination of the document.

The entity interested in the content. If the receiver party has outsourced the message service to a third party the ReceiverParty is the intended party for the e-Document and not the party performing the receiving service of the electronic message.

ServiceInstructionTitle

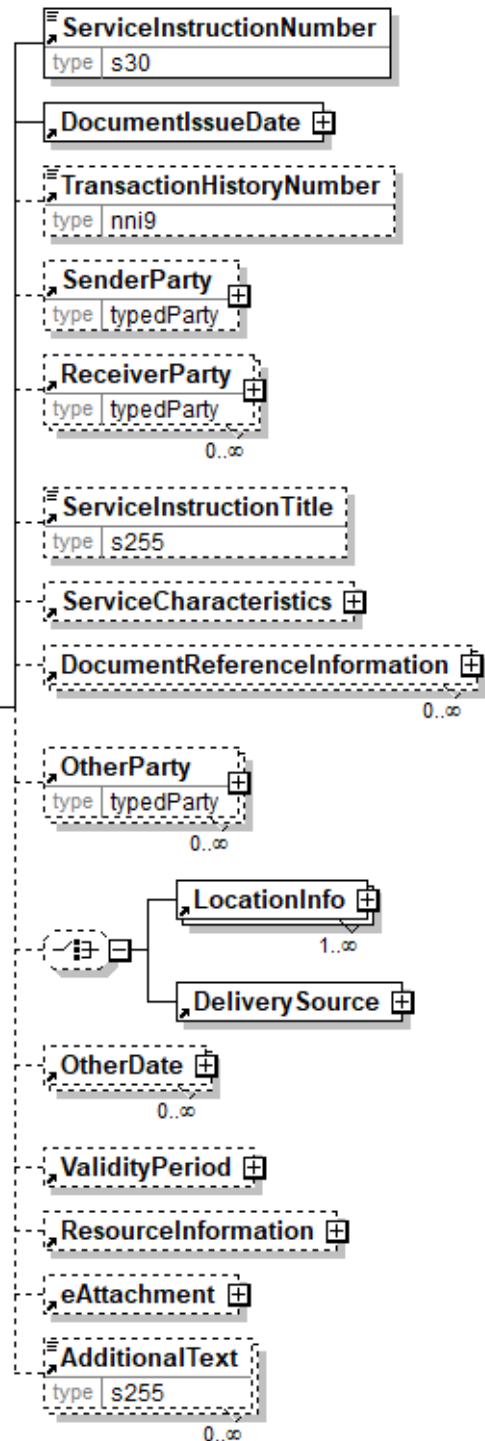

ServiceInstructionTitle is optional. A single instance might exist.

A text describing the context of the ServiceInstruction.

ServiceCharacteristics

ServiceCharacteristics is optional. A single instance might exist.

A grouping element that contains information related to the service.

DocumentReferenceInformation

DocumentReferenceInformation is optional. Multiple instances might exist.

A group item containing reference information applicable to a document.

OtherParty

OtherParty is optional. Multiple instances might exist.

An organisation or business entity other than those specifically detailed within an e-Document.

(choice)

[choice] is optional. A single instance might exist.

LocationInfo

LocationInfo is mandatory. One instance is required, multiple instances might exist.

A grouping element that contains information about a geographical location.

DeliverySource

DeliverySource is mandatory. One instance is required.

A grouping element with information that identifies and specifies the source of a delivery, e.g. a logging area.

OtherDate

OtherDate is optional. Multiple instances might exist.

A date that may not be specifically detailed within a document (example: print date at the PurchaseOrderLineItem).

ValidityPeriod

ValidityPeriod is optional. A single instance might exist.

The validity period for a specific item, e.g. the validity period for an e-Document.

ResourceInformation

ResourceInformation is optional. A single instance might exist.

A group item that contains information for specification of resources.

eAttachment

eAttachment is optional. A single instance might exist.

eAttachment enables the sender to provide information about attachments to the document.

- Note: An element "e-Attachment" also exists. papiNet will no longer use hyphens in our element and attribute names as this causes issues with BizTalk.

AdditionalText

AdditionalText is optional. Multiple instances might exist.

A text field that is used to communicate information not previously defined or for

special instructions. To be used only for circumstances not covered by specific elements.

ServiceInstructionLineItem

A grouping element that contains information for a line item of the ServiceInstruction. The line item specifies detail information associated with a product.

ValidityStatus [attribute]

ValidityStatus is optional. A single instance might exist.

The

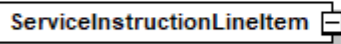

validity status for a specific item.

Refer to ValidityStatus definition for any enumerations.

(sequence)

The sequence of items below is mandatory. A single instance is required.

LineItemNumber

LineItemNumber is mandatory. A single instance is required.

A sequential number that uniquely identifies the line item of an e-Document.

Product

Product is mandatory. A single instance is required.

Product is a group item defining the article and its characteristics. Product is used to specify product characteristics organized by ProductIdentifier, ProductDescription, and Classification. Book Manufacturing, Forest Wood, Label Stock, Paper, Pulp, Recovered Paper, Wood Products, and Virgin Fibre market segments have defined their product characteristics and conversion features for implementation in papiNet.

QuantityInformation

QuantityInformation is optional. A single instance might exist.

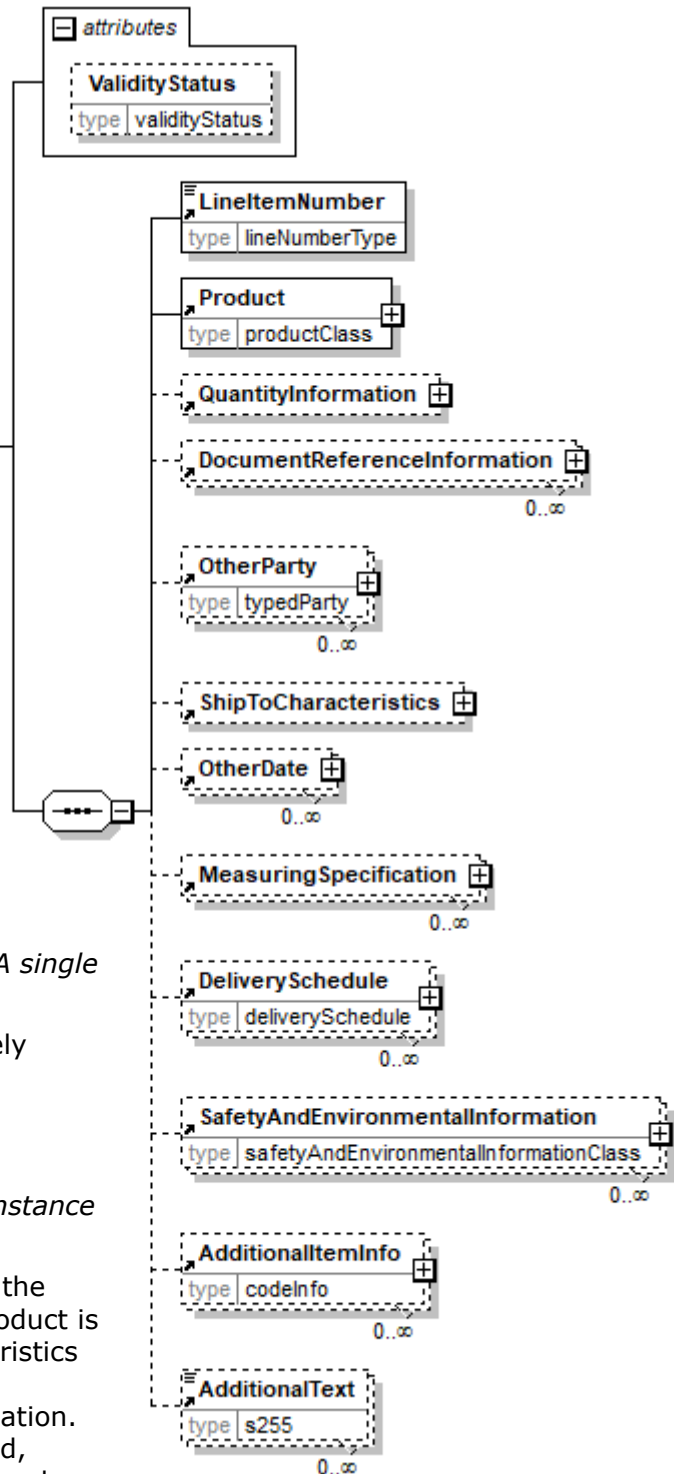

A group item containing information about quantity and informational quantity of similar items.

DocumentReferenceInformation

DocumentReferenceInformation is optional. Multiple instances might exist.

A group item containing reference information applicable to a document.

OtherParty

OtherParty is optional. Multiple instances might exist.

An organisation or business entity other than those specifically detailed within an e-Document.

ShipToCharacteristics

ShipToCharacteristics is optional. A single instance might exist.

A group item that provides information important for the Ship-To Party.

OtherDate

OtherDate is optional. Multiple instances might exist.

A date that may not be specifically detailed within a document (example: print date at the PurchaseOrderLineItem).

MeasuringSpecification

MeasuringSpecification is optional. Multiple instances might exist.

A grouping element that contains a specification for measurement procedures for a measuring party at a measuring location.

DeliverySchedule

DeliverySchedule is optional. Multiple instances might exist.

A group item defining a series of DeliveryDateWindow(s) in which specified quantities must be delivered.

SafetyAndEnvironmentalInformation

SafetyAndEnvironmentalInformation is optional. Multiple instances might exist.

Name of certification type, if any, on the goods (For example, FSC, PEFC). SafetyAndEnvironmental needs a value or measurement to communicate the percentage of the product is certified (for example, 75% is certified by the indicated agency).

AdditionalItemInfo

AdditionalItemInfo is optional. Multiple instances might exist.

A grouping element that contains information about additional items specified by an agency. Restricted use of this element is recommended.

AdditionalText

AdditionalText is optional. Multiple instances might exist.

A text field that is used to communicate information not previously defined or for special instructions. To be used only for circumstances not covered by specific elements.

ServiceInstructionNumber

The unique identifier of a ServiceInstruction e-Document.

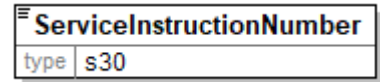

ServiceInstructionStatusType [attribute]

Identifies the status of the entire ServiceInstruction e-Document.

This item is restricted to the following list.

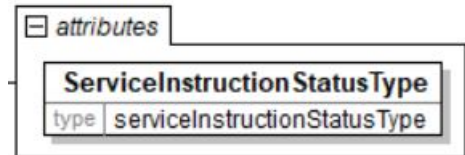

Cancelled

The supplied information has been cancelled. Items that have been cancelled are not included in totals on the summary levels of the e-document.

Original

The supplied information is the first version of that information.

Replaced

The supplied information is replacing earlier supplied information. The receiver should revalidate the information in their system based upon the entire information received.

ServiceInstructionSummary

A grouping element that contains summary information that applies to the entire ServiceInstruction e-Document.

sequence)

The sequence of items below is mandatory. A single instance is required.

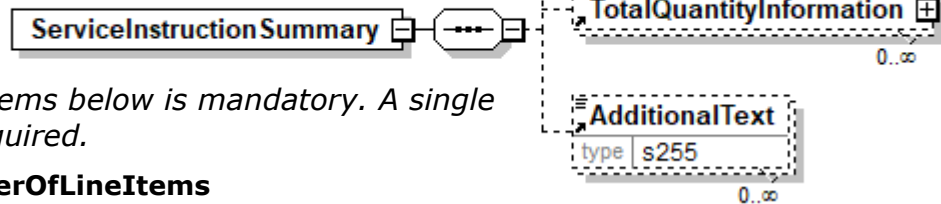

TotalNumberOfLineItems

TotalNumberOfLineItems is optional. A single instance might exist.

The total number of individual line items in the document, regardless of the status or type.

TotalQuantityInformation

TotalQuantityInformation is optional. Multiple instances might exist.

A group item containing information about the total quantity and total informational quantity of similar items in the document.

AdditionalText

AdditionalText is optional. Multiple instances might exist.

A text field that is used to communicate information not previously defined or for special instructions. To be used only for circumstances not covered by specific elements.

ServiceInstructionTitle

A text describing the context of the ServiceInstruction.

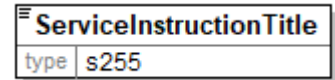

ServiceInstructionType [attribute]

ServiceInstructionType defines the type of ServiceInstruction e-Document.

This item is restricted to the following list.

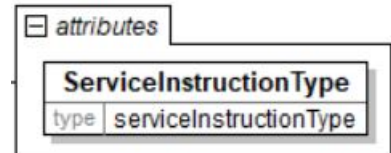

ForestLoggingInstruction

An instruction specifying what products to produce in a forest logging and forwarding operation.

ProductDestiningInstruction

An instruction requesting the receiver to destine product(s) to end users.

ServiceLevel

A grouping element containing information about a service level. The service level can be specified in a Service Level Agreement (SLA) detailing requirements such as delivery, performance, pricing, quality, etc.

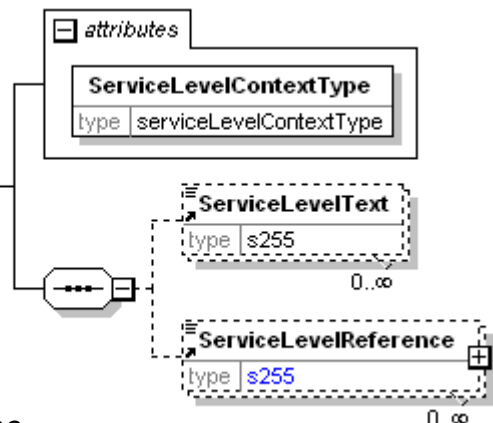

ServiceLevelContextType [attribute]

ServiceLevelContextType is mandatory. A single instance is required.

Indicates the nature of what is included in the service level.

Refer to ServiceLevelContextType definition for any enumerations.

(sequence)

The sequence of items below is mandatory. A single instance is required.

ServiceLevelText

ServiceLevelText is optional. Multiple instances might exist.

Text that is describing the service level.

ServiceLevelReference

ServiceLevelReference is optional. Multiple instances might exist.

An element detailing relevant references pertaining to the ServiceLevel. The type of reference is identified by the attributes ServiceLevelReferenceType and AssignedBy.

ServiceLevelContextType [attribute]

Indicates the nature of what is included in the service level.

This item is restricted to the following list.

Delivery

The service level is given for deliveries.

Production

The service level is given for production.



ServiceLevelReference

An element detailing relevant references pertaining to the ServiceLevel. The type of reference is identified by the attributes

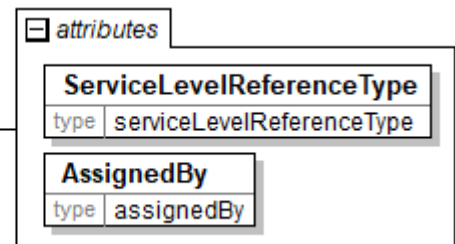
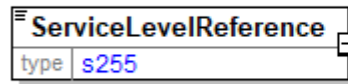

ServiceLevelReferenceType and AssignedBy.

ServiceLevelReferenceType [attribute]

ServiceLevelReferenceType is mandatory. A single instance is required.

Provides a contextual explanation of the specific reference identifier.

Refer to ServiceLevelReferenceType definition for any enumerations.

AssignedBy [attribute]

AssignedBy is mandatory. A single instance is required.

Identifies the type of party or the agency that has assigned the associated item, e.g. a reference of type OrderNumber.

Refer to AssignedBy for any enumerations.

ServiceLevelReferenceType [attribute]

Provides a contextual explanation of the specific reference identifier.

This item is restricted to the following list.

DeliveryChargeAccountNumber

Account Number to which the delivery charges are billed.

ServiceLevelAgreementNumber

The unique identifier given to a service level agreement.



ServiceLevelText

Text that is describing the service level.

ServiceLevelText	
type	s255

ShapeOfHole [attribute]

The shape of the hole

This item is restricted to the following list.

Elongated

The shape of the hole is elongated.

Oval

The shape of the hole is ovular.

Round

The shape of the hole is round.

Square

The shape of the hole is square.

Other

The shape of the hole is other.

attribute	
ShapeOfHole	
type	holeShapeType

SetNumber

The part of the radius of the Tambour that constitutes the reel.

SetNumber	
type	nni2

SetPosition

The position of the reel in relation to the reels cut across the Tambour.

SetPosition	
type	nni2

ShapeOfHole [attribute]

The shape of the hole

This item is restricted to the following list.

Elongated

The shape of the hole is elongated.

Oval

The shape of the hole is ovular.

Round

attribute	
ShapeOfHole	
type	holeShapeType

The shape of the hole is round.

Square

The shape of the hole is square.

Other

The shape of the hole is other.

Sheet

A group item that contains the conversion and packaging characteristics for sheets.

(sequence)

The sequence of items below is mandatory. A single instance is required.

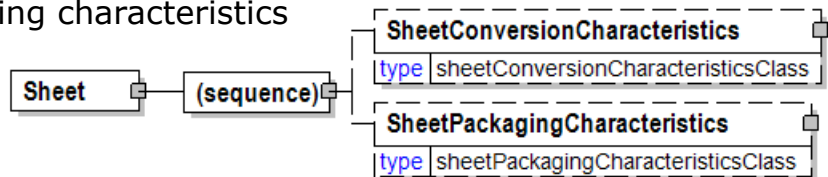

SheetConversionCharacteristics

SheetConversionCharacteristics is optional. A single instance might exist.

A group item that lists the conversion elements describing how a sheets are converted from a tambour.

SheetPackagingCharacteristics

SheetPackagingCharacteristics is optional. A single instance might exist.

A group item that contains elements relative to the sheet packaging.

SheetConcern

If the ConcernIndicatorType is "Y" then a defect cause must be given.

SheetConcernType [attribute]

SheetConcernType is optional. A single instance might exist.

Sheet Concern Type

Refer to SheetConcernType definition for any enumerations.

(sequence)

The sequence of items below is mandatory. A single instance is required.

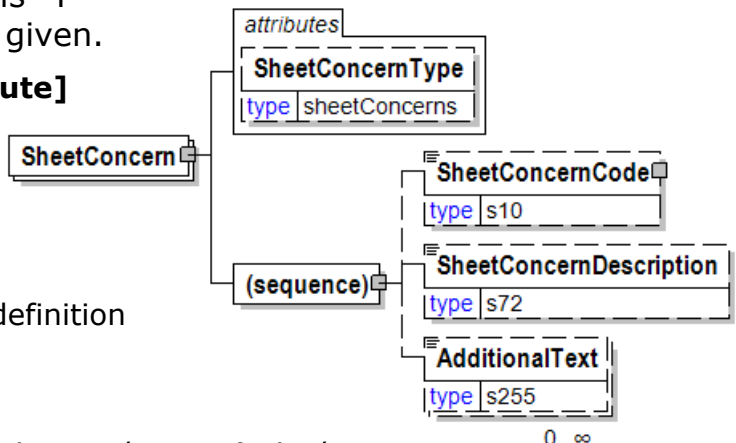

SheetConcernCode

SheetConcernCode is optional. A single instance might exist.

Code used to identify problem with the sheet.

SheetConcernDescription

SheetConcernDescription is optional. A single instance might exist.

papiNet V2R31

Description used to narrate the problem with the sheet.

AdditionalText

AdditionalText is optional. Multiple instances might exist.

A text field that is used to communicate information not previously defined or for special instructions. To be used only for circumstances not covered by specific elements.

SheetConcernCode

Code used to identify problem with the sheet.

Agency [attribute]

Agency is mandatory. A single instance is required.

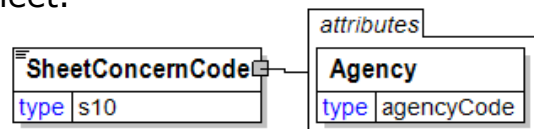

Describes the agency maintaining the list of codes. To be included in this list the agency must be a recognized standards body or industry organisation.

- For the element that owns this attribute.
- For another attribute in the list of attributes associated with the parent element.

Refer to Agency definition for any enumerations.

SheetConcernDescription

Description used to narrate the problem with the sheet.

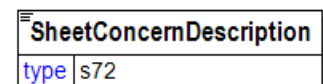

SheetConcernType [attribute]

Sheet Concern Type

This item is restricted to the following list.

BladeOrApplicatorRollStreaks

BowedEdges

CaliperVariation

CoatedBladeScratch

CoatingStreaks

ColouredFibres

Curling

CutterWrinkles

Dirt

DyeStreaks

FeltMarks

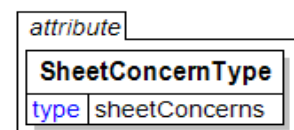

- Mottle**
- Other**
- OutOfSquareOrSize**
- ShadeVariation**
- SheetRelatedProblems**
- SlimeHole**
- SlimeSpot**
- StaticElectricity**
- Stretching**
- SurfaceDefectsOther**
- TightEdges**
- WavyEdges**
- WireHole**
- WrinklesOther**

SheetConversionCharacteristics

A group item that lists the conversion elements describing how a sheets are converted from a tambour.

(sequence)

The sequence of items below is mandatory. A single instance is required.

ConversionCode

ConversionCode is optional. A single instance might exist.

A code, as assigned by an Agency, used to identify a group of conversion characteristics.

GrainDirection

GrainDirection is optional. A single instance might exist.

Defines the primary orientation/alignment (Long or Short) of the cellulose fibres in a sheet or web of paper, which results from the flow of fibres in a water suspension during the papermaking process.

Refer to GrainDirection definition for any enumerations.

WindingDirection

WindingDirection is optional. A single instance might exist.

An element that indicates how the material is wound on

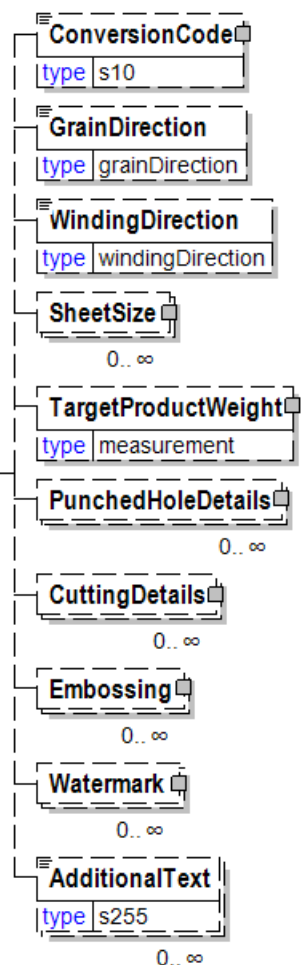
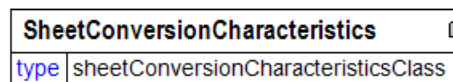

the reel.

Refer to WindingDirection definition for any enumerations.

SheetSize

SheetSize is optional. Multiple instances might exist.

A group item that contains elements relative to the sheet size.

TargetProductWeight

TargetProductWeight is optional. A single instance might exist.

The desired weight of the finished product.

PunchedHoleDetails

PunchedHoleDetails is optional. Multiple instances might exist.

A grouping element that will contain the configuration information for punched holes.

CuttingDetails

CuttingDetails is optional. Multiple instances might exist.

Cutting Details provides information on how to cut the sheet.

Embossing

Embossing is optional. Multiple instances might exist.

Embossing requirements for sheets and reels. Embossing involves a physical deformation of the paper surface as part of the conversion process. Embossing is applied either in-line (directly after the paper machine) or off-line. Refer to the attribute FinishType for additional information.

Watermark

Watermark is optional. Multiple instances might exist.

Watermark information

AdditionalText

AdditionalText is optional. Multiple instances might exist.

A text field that is used to communicate information not previously defined or for special instructions. To be used only for circumstances not covered by specific elements.

SheetCount

A group item that contains information relative to the number of sheets per packaging type.

SheetCountMethodType [attribute]

SheetCountMethodType is optional. A single instance might exist.

Defines the method used to count the sheets.

Refer to SheetCountMethodType definition for any enumerations.

(sequence)

The sequence of items below is mandatory. A single instance is required.

PerCarton

PerCarton is optional. A single instance might exist.

A field indicating the number of sheets per carton.

PerReam

PerReam is optional. A single instance might exist.

A field indicating the number of sheets per ream.

PerPallet

PerPallet is optional. A single instance might exist.

A field indicating the number of sheets on the pallet.

PerTab

PerTab is optional. A single instance might exist.

A field indicating the number of sheets per tab marking.

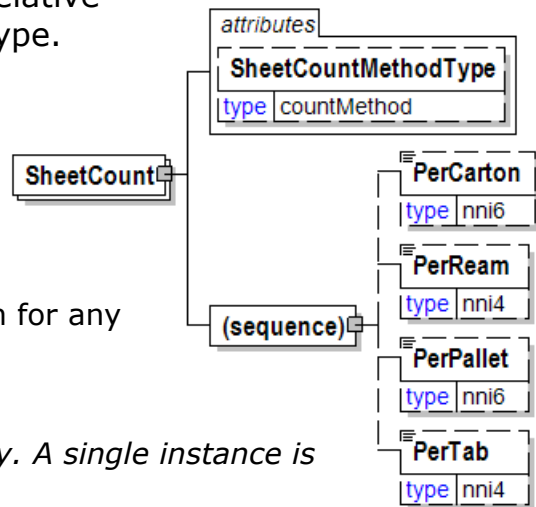

SheetCountMethodType [attribute]

Defines the method used to count the sheets.

This item is restricted to the following list.

Counter

Sheets will be counted using a counter at the cutter.

Laser

Sheets will be counted using a laser scanner.

NominalGrammage

The number of sheets will be calculated using the nominal grammage and the actual weight of the sheets.

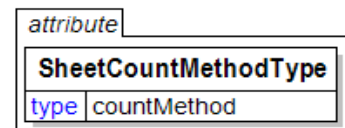

SheeterConcerns

SheeterConcerns is a group element that provides information about an event on a sheeter.

MachineStoppage [attribute]

MachineStoppage is optional. A single instance might exist.

An indicator on whether the production had to be periodically stopped.

Refer to MachineStoppage definition for any enumerations.

(sequence)

The sequence of items below is mandatory. A single instance is required.

SheetConcern

SheetConcern is mandatory. One instance is required, multiple instances might exist.

If the ConcernIndicatorType is "Y" then a defect cause must be given.

EventDate

EventDate is optional. A single instance might exist.

The date the incident or delay on press was recorded.

PositionInSheet

PositionInSheet is optional. A single instance might exist.

Location in the sheet where the defect was identified.

MachineLocation

MachineLocation is optional. A single instance might exist.

A unique and defined area in the operating machine. On a printing press it would include areas such as: "Splicer", "Infeed", "Print Unit", "folder", "Silcone coater". Also see PressBreakLocation.

WasteImpressions

WasteImpressions is optional. A single instance might exist.

The number of bad revolutions produced on a printing unit.

MachineDownTime

MachineDownTime is optional. A single instance might exist.

The length of loss production time that a machine experienced due to malfunction regardless of cause.

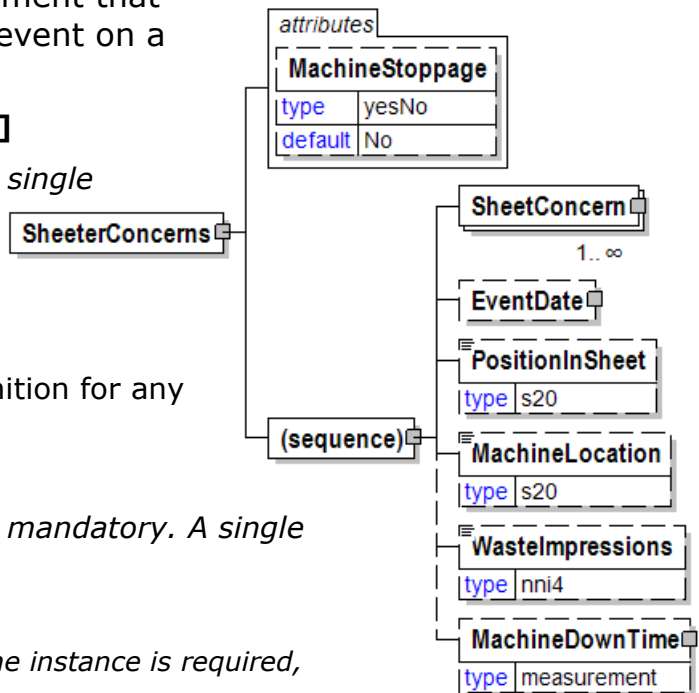

SheeterConditions

Identifies the environmental conditions when the sheet was printed on.

(sequence)

The sequence of items below is mandatory. A single instance is required.

Humidity

Humidity is optional. Multiple instances might exist.

Humidity

AmbientTemperature

AmbientTemperature is optional. Multiple instances might exist.

The temperature of the surrounding environment.

MachineSpeed

MachineSpeed is optional. Multiple instances might exist.

The rate at which the machine is, was, or should be running.

Tension

Tension is optional. Multiple instances might exist.

Tension of the web on the printing press.

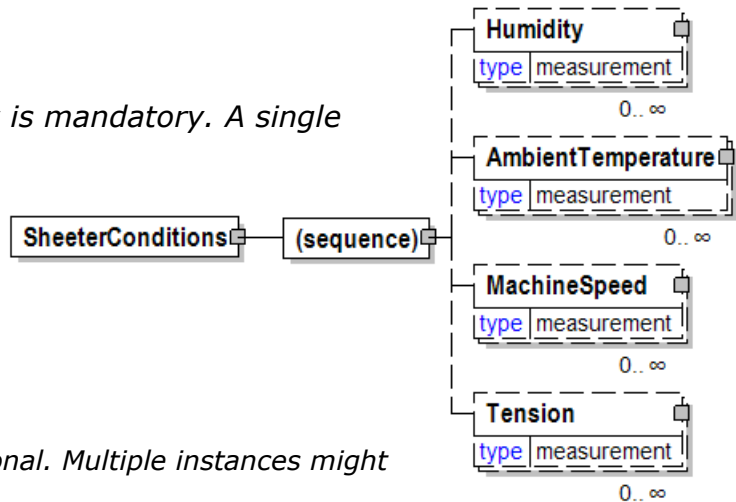

SheetItem

A group item consisting potentially of the date the sheets were converted into sheets and/or packaged or finished.

(sequence)

The sequence of items below is mandatory. A single instance is required.

DateSheeted

DateSheeted is optional. A single instance might exist.

The Date and optionally the Time that the paper was sheeted.

DateFinished

DateFinished is optional. A single instance might exist.

The Date and optionally the Time that an item was finished. For example, this could be the wrapping date for a reel or ream or the date the sheet(s) were packaged in preparation for shipment

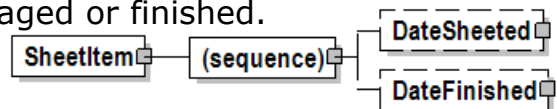

SheetPackagingCharacteristics

A group item that contains elements relative to the sheet packaging.

ActionType [attribute]

ActionType is optional. A single instance might exist.

Used to trigger an action concerning the element to which it refers.

Refer to ActionType definition for any enumerations.

(sequence)

The sequence of items below is mandatory. A single instance is required.

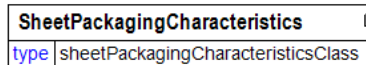

PackagingCode

PackagingCode is optional. Multiple instances might exist.

PackagingCode is a code describing the packaging of the product.

PackagingDescription

PackagingDescription is optional. Multiple instances might exist.

A text field element describing the packaging of a product.

ReamType

ReamType is optional. Multiple instances might exist.

The textual description of the method used to make up the reams.

Refer to ReamType definition for any enumerations.

ReamWeight

ReamWeight is optional. Multiple instances might exist.

The target weight of a ream of paper.

MWeight

MWeight is optional. Multiple instances might exist.

The weight of 1000 sheets.

SheetCount

SheetCount is optional. Multiple instances might exist.

A group item that contains information relative to the number of sheets per packaging type.

UnitsPerCarton

UnitsPerCarton is optional. Multiple instances might exist.

The number of units per box.

Wrap

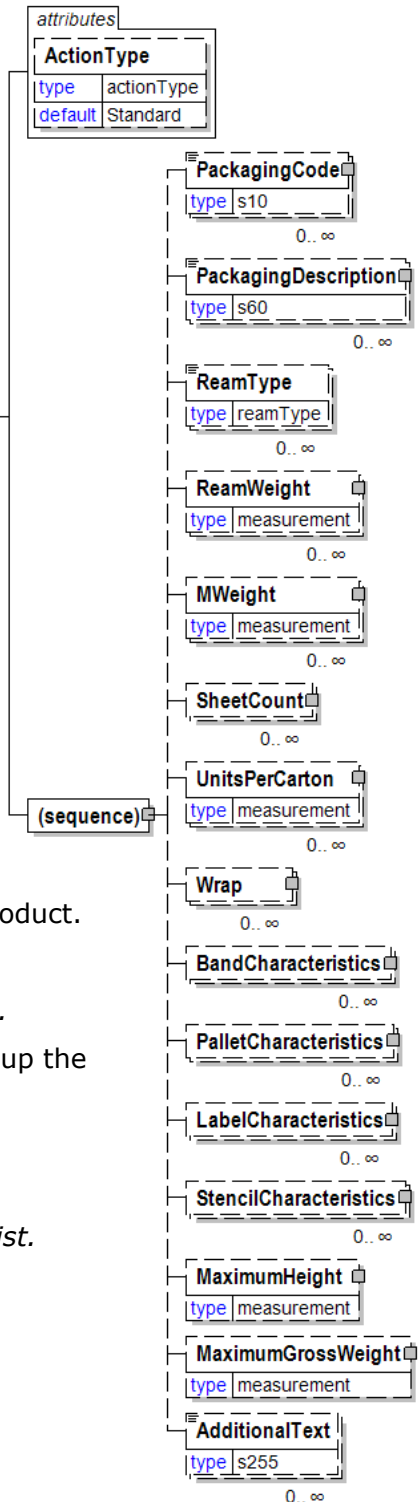

Wrap is optional. Multiple instances might exist.

A group item that organises wrapping detail information.

BandCharacteristics

BandCharacteristics is optional. Multiple instances might exist.

A group item that organises the packaging band detail information.

PalletCharacteristics

PalletCharacteristics is optional. Multiple instances might exist.

A group item that provides pallet detail information.

LabelCharacteristics

LabelCharacteristics is optional. Multiple instances might exist.

A group item that organises the labeling information.

StencilCharacteristics

StencilCharacteristics is optional. Multiple instances might exist.

A group element specifying attributes of a stencil to be applied to an item, and optional text.

MaximumHeight

MaximumHeight is optional. A single instance might exist.

The maximum height allowed including the pallet.

MaximumGrossWeight

MaximumGrossWeight is optional. A single instance might exist.

The maximum weight allowed including the pallet.

AdditionalText

AdditionalText is optional. Multiple instances might exist.

A text field that is used to communicate information not previously defined or for special instructions. To be used only for circumstances not covered by specific elements.

SheetSize

A group item that contains elements relative to the sheet size.

(choice)

[choice] is mandatory. A single instance is required.

(sequence)

The sequence of items below is mandatory. A single instance is required.

Length

Length is mandatory. A single instance is required.

The length of the object.

Width

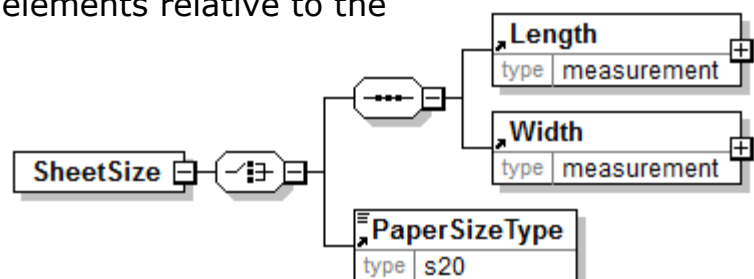

papiNet V2R31

Width is mandatory. A single instance is required.

The width of the object.

PaperSizeType

PaperSizeType is mandatory. A single instance is required.

A field that defines the sheet size using the DIN standard (DINA4, DINA3, and so on).

ShellColour

Shell colour

ShellColour
type string

ShellType [attribute]

The type of shell

This item is restricted to the following list.

SonicWeld

FiveScrew

attribute
ShellType
type shellType

ShipFromCharacteristics

A group item that provides information pertaining to the Ship-From Party.

(sequence)

The sequence of items below is mandatory. A single instance is required.

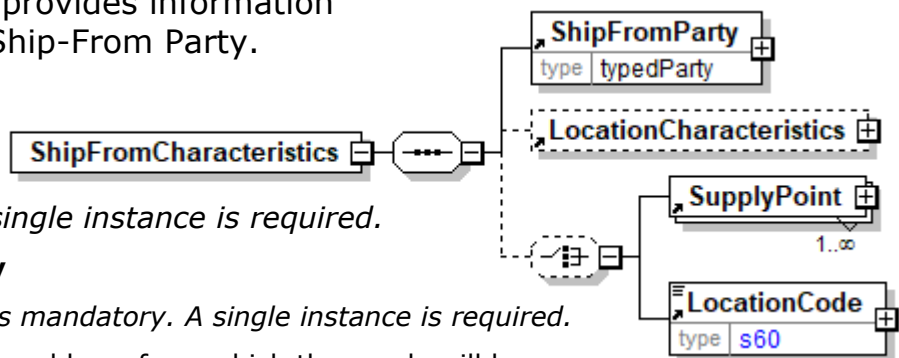

ShipFromParty

ShipFromParty is mandatory. A single instance is required.

The name and/or address from which the goods will be delivered with the party type indicated by the PartyType attribute.

LocationCharacteristics

LocationCharacteristics is optional. A single instance might exist.

A grouping element that contains information related to a geographical location.

(choice)

[choice] is optional. A single instance might exist.

SupplyPoint

SupplyPoint is mandatory. One instance is required, multiple instances might exist.

Grouping element that contains items describing a supply point. A SupplyPoint belongs to a LocationParty, e.g. in a DeliveryOrigin or DeliveryDestination, and describes where goods are stored and can be loaded or unloaded. A SupplyPoint

can for example be a loading or unloading gate at a warehouse or a road side landing at a logging area in the forest.

LocationCode

LocationCode is mandatory. A single instance is required.

A code used to identify a specific physical location within a site identified by a party, e.g. a loading station in a warehouse or an unloading station at a printer site.

LocationCode will be deprecated in a future version V3R00. Use SupplyPoint instead of LocationCode.

ShipFromParty

The name and/or address from which the goods will be delivered with the party type indicated by the PartyType attribute.

PartyType [attribute]

PartyType is mandatory. A single instance is required.

Identifies the business role associated with the particular party

Refer to PartyType definition for any enumerations.

LogisticsRole [attribute]

LogisticsRole is optional. A single instance might exist.

Communicates the nature of the logistics role, if any, the party plays in the transaction.

Refer to LogisticsRole definition for any enumerations.

(sequence)

The sequence of items below is mandatory. A single instance is required.

PartyIdentifier

PartyIdentifier is optional. Multiple instances might exist.

A unique identifier of a specific party. This element contains an attribute PartyIdentifierType that indicates the type of the identifier.

NameAddress

NameAddress is mandatory. A single instance is required.

A group item containing name and address of an organisation or business entity.

URL

URL is optional. A single instance might exist.

Universal Resource Locator. While typically a web address you could use this field to hold an email address.

CommonContact

CommonContact is optional. Multiple instances might exist.

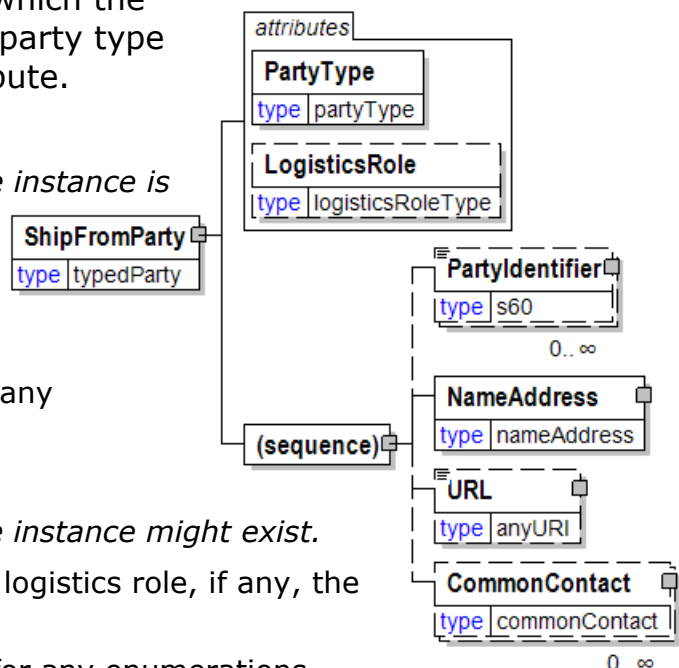

Identifies a specific individual associated with the party.

ShipmentComplete [attribute]

Indicates that all shipments for the particular delivery item are complete.

This item is restricted to the following list.

Yes

No

attributes	
ShipmentComplete	
type	yesNo
default	No

ShipmentDetails

A group element containing information that relates to the shipment details for the line item.

ShipmentDetailsType [attribute]

ShipmentDetailsType is mandatory. A single instance is required.

Provides information about the shipment's status

Refer to ShipmentDetailsType definition for any enumerations.

(sequence)

The sequence of items below is mandatory. A single instance is required.

ShipToParty

ShipToParty is mandatory. A single instance is required.

The name and/or address to which the goods should be delivered with the party type indicated by the PartyType attribute.

Quantity

Quantity is mandatory. A single instance is required.

The Quantity element contains attributes that provide information about the type of quantity that is being communicated, the context in which the particular quantity is to be viewed, and (if the quantity represents an adjustment) an adjustment type.

The Quantity element contains three child elements that enable you to communicate a range of values for the quantity and a target or actual value. It is at this level (Value, RangeMin, and RangeMax) that the unit of measure is specified. This permits the range to be specified in a different unit of measure than the target.

InformationalQuantity

InformationalQuantity is optional. Multiple instances might exist.

A quantity given in a valid UOM used for information purposes only (not for

ShipmentDetails

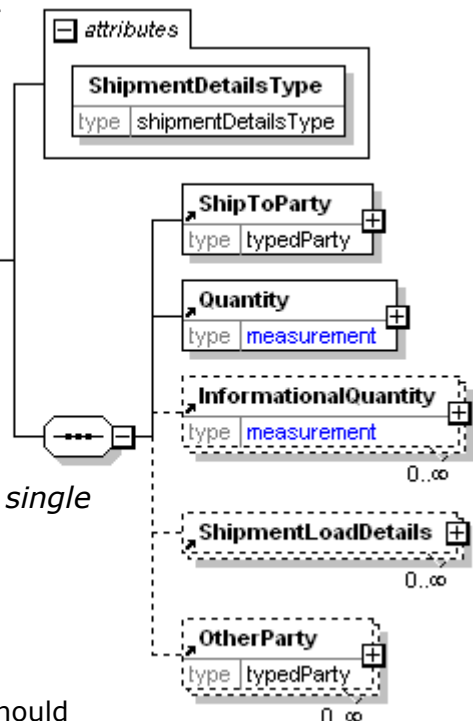

papiNet V2R31

calculation). For example, an ordered quantity was 100 reels as opposed to the invoice quantity of 20,000 pounds.

ShipmentLoadDetails

ShipmentLoadDetails is optional. Multiple instances might exist.

A group element that containing information that relates to the shipment load details for the line item. Carrier and transport information may be detailed.

OtherParty

OtherParty is optional. Multiple instances might exist.

An organisation or business entity other than those specifically detailed within an e-Document.

ShipmentDetailsType [attribute]

Provides information about the shipment's status

This item is restricted to the following list.

Forecast

The shipment has not yet taken place

Shipment

The shipment has taken place.



ShipmentEventDate

The date and time when the shipment event specified by ShipmentEventType and ShipmentEventQualifierType has occurred.

N.B. For this shipment event the ShipmentStatusDate is the same as ShipmentEventDate. A later shipment event having the same ShipmentEventType, ShipmentEventQualifierType and ShipmentEventDate but a later ShipmentStatusDate will report new transport status information for the shipment.

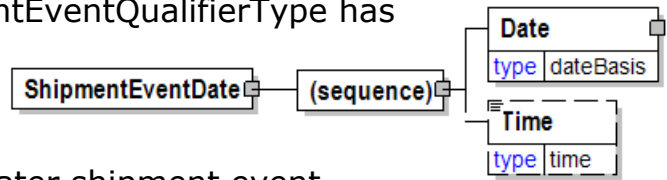

(sequence)

The sequence of items below is mandatory. A single instance is required.

Date

Date is mandatory. A single instance is required.

A group element that contains the specification of Year, Month, and Day.

Time

Time is optional. A single instance might exist.

Times are treated in a standard XML fashion with a special case used to indicate a generalized "local" time. The standard XML approach to time is hh:mm:ss, hh:mm:ssZ, or hh:mm:ss±hh:mm.

hh:mm:ss±hh:mm is used to represent a time with a time zone. The time zone

papiNet V2R31

is communicated as the number of hours offset from the Universal Time Coordinate (UTC), a.k.a. Greenwich Mean Time.

hh:mm:ssZ indicates the time at Zulu (another name for UTC).

hh:mm:ss or hh:mm indicates within papiNet the applicable local time where the associated event is taking place. Caution should be used when processing times of this nature as the papiNet approach may be in discord with other users of XML.

ShipmentEventDuration

The length of time for the shipment event being described.

ShipmentEventDuration
type duration

The lexical representation for duration is the [ISO 8601] extended format PnYnMnDTnH nMnS, where nY represents the number of years, nM the number of months, nD the number of days, 'T' is the date/time separator, nH the number of hours, nM the number of minutes and nS the number of seconds. The number of seconds can include decimal digits to arbitrary precision. E.g. 25 hours = PT25H, 1 day and 34 minutes = P1DT34M.

ShipmentEventIdentifier

A unique identifier of a Shipment Event for the party identified by the attribute AssignedBy.

ShipmentEventIdentifier
type s30

attributes
ShipmentEventType type shipmentEventType
AssignedBy type assignedBy
ShipmentEventQualifierType type shipmentEventQualifierType

ShipmentEventType [attribute]

ShipmentEventType is mandatory. A single instance is required.

Indicates the type of event.

Refer to ShipmentEventType definition for any enumerations.

AssignedBy [attribute]

AssignedBy is mandatory. A single instance is required.

Identifies the type of party or the agency that has assigned the associated item, e.g. a reference of type OrderNumber.

Refer to AssignedBy definition for any enumerations.

ShipmentEventQualifierType [attribute]

ShipmentEventQualifierType is optional. A single instance might exist.

Provides additional details related to the general shipment event.

Refer to ShipmentEventQualifierType definition for any enumerations.

ShipmentEventInformation

A grouping element that contains the items that describe the shipment event and status situation

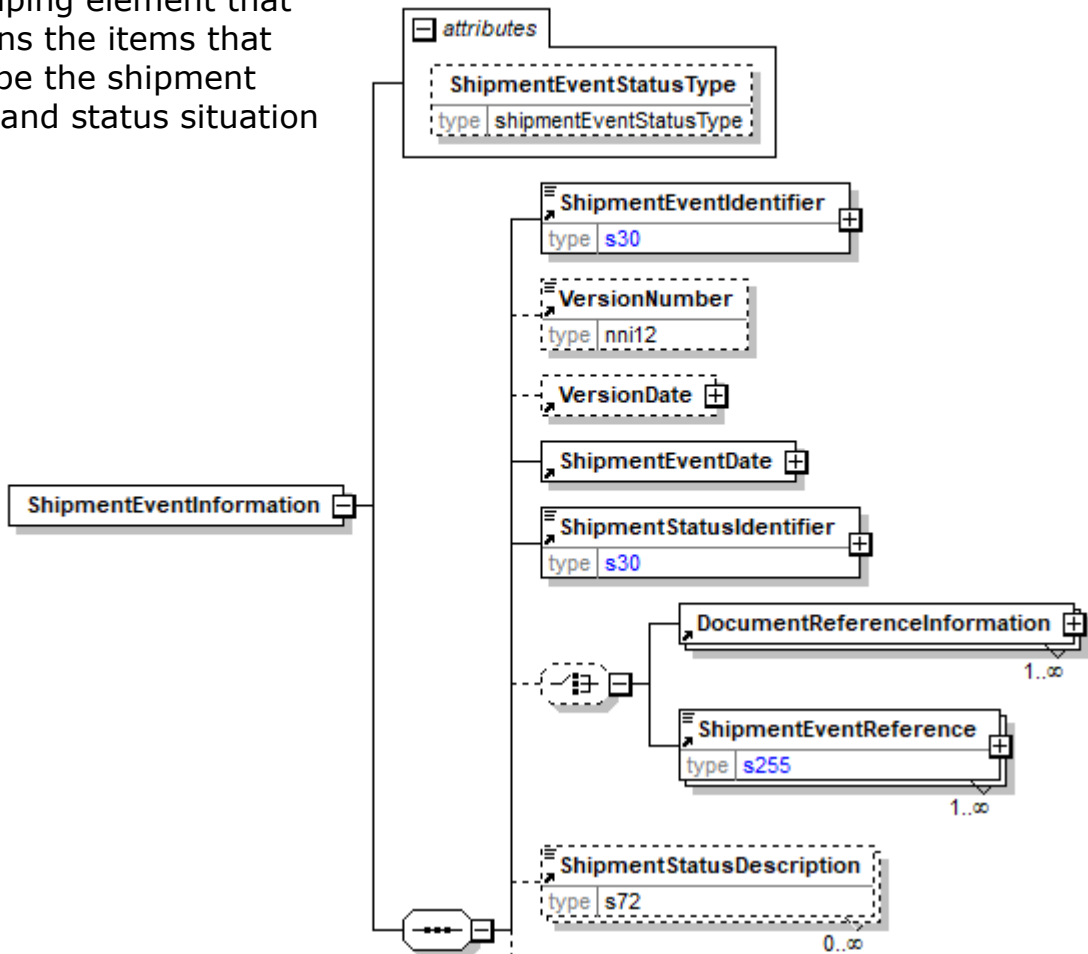

ShipmentEventStatusType [attribute]

ShipmentEventStatusType is optional. A single instance might exist.

Identifies the status of the information for the shipment event.

Refer to *ShipmentEventStatusType* definition for any enumerations.

(sequence)

The sequence of items below is mandatory. A single instance is required.

ShipmentEventIdentifier

ShipmentEventIdentifier is mandatory. A single instance is required.

A unique identifier of a Shipment Event for the party identified by the attribute AssignedBy.

VersionNumber

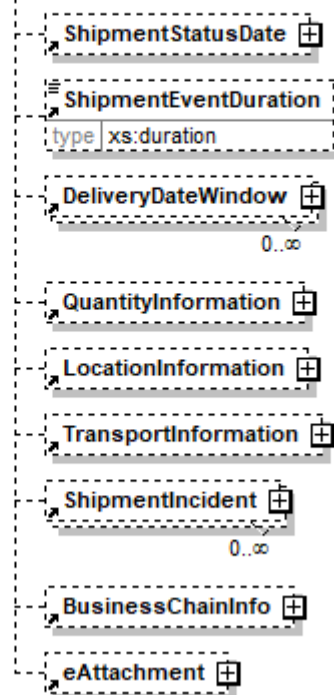

VersionNumber is optional. A single instance might exist.

A unique number identifying the version of an item.

VersionDate

VersionDate is optional. A single instance might exist.

The Date and Time when the version of an item was issued.

ShipmentEventDate

ShipmentEventDate is mandatory. A single instance is required.

The date and time when the shipment event specified by ShipmentEventType and ShipmentEventQualifierType has occurred.

N.B. For this shipment event the ShipmentStatusDate is the same as ShipmentEventDate. A later shipment event having the same ShipmentEventType, ShipmentEventQualifierType and ShipmentEventDate but a later ShipmentStatusDate will report new transport status information for the shipment.

ShipmentStatusIdentifier

ShipmentStatusIdentifier is mandatory. A single instance is required.

Text to identify the status of the event.

(choice)

[choice] is optional. A single instance might exist.

DocumentReferenceInformation

DocumentReferenceInformation is mandatory. One instance is required, multiple instances might exist.

A group item containing reference information applicable to a document.

ShipmentEventReference

ShipmentEventReference is mandatory. One instance is required, multiple instances might exist.

An item detailing relevant references pertaining to the shipment event information. The type of reference is identified by the ShipmentEventReferenceType attribute.

ShipmentEventReference will be deprecated in a future version V3R00 and should not be used in new integrations. Use instead DocumentReferenceInformation.

ShipmentStatusDescription

ShipmentStatusDescription is optional. Multiple instances might exist.

Text field that may further describe the event's status in detail.

ShipmentStatusDate

ShipmentStatusDate is optional. A single instance might exist.

The Date and time for the transport status information in the shipment event.

ShipmentEventDuration

ShipmentEventDuration is optional. A single instance might exist.

The length of time for the shipment event being described.

The lexical representation for duration is the [ISO 8601] extended format PnYn MnDTnHnMnS, where nY represents the number of years, nM the number of months, nD the number of days, 'T' is the date/time separator, nH the number of

papiNet V2R31

hours, nM the number of minutes and nS the number of seconds. The number of seconds can include decimal digits to arbitrary precision. E.g. 25 hours = PT25H, 1 day and 34 minutes = P1DT34M.

DeliveryDateWindow

DeliveryDateWindow is optional. Multiple instances might exist.

A group item defining the date/time interval for delivery to take place. An element which may contain the estimated date for which delivery is expected. This date is not absolute.

QuantityInformation

QuantityInformation is optional. A single instance might exist.

A group item containing information about quantity and informational quantity of similar items.

LocationInformation

LocationInformation is optional. A single instance might exist.

A grouping element describing the location of the shipment.

TransportInformation

TransportInformation is optional. A single instance might exist.

A grouping element for transport information.

ShipmentIncident

ShipmentIncident is optional. Multiple instances might exist.

A grouping element that contains information about the shipment incident.

BusinessChainInfo

BusinessChainInfo is optional. A single instance might exist.

A grouping element that contains information about parties in the business chain when products or services are traded in many levels.

The business chain starts at the sourcing end where products are provided when BusinessChainContextType = Product.

The business chain starts at the purchasing of a service from the OriginalLogisticsSupplier when BusinessChainContextType = LogisticsService.

eAttachment

eAttachment is optional. A single instance might exist.

eAttachment enables the sender to provide information about attachments to the document.

Note: An element "e-Attachment" also exists. papiNet will no longer use hyphens in our element and attribute names as this causes issues with BizTalk.

ShipmentEventQualifierType [attribute]

Provides additional details related to the general shipment event.

This item is restricted to the following list.

Arrived

The vehicle has arrived.

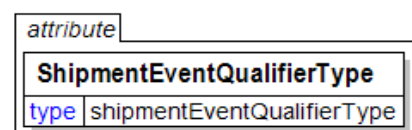

Completed

The event has ended.

CostBasisCompleted

Transport properties needed in calculation of transport costs are recorded and reported as complete.

Departed

The vehicle has departed.

DocumentationCompleted

Documentation has been completed.

Measured

The load has been measured.

Scheduled

The event has been scheduled.

Started

The event has started.

ShipmentEventReference

An item detailing relevant references pertaining to the shipment event information. The type of reference is identified by the

ShipmentEventReferenceType attribute.

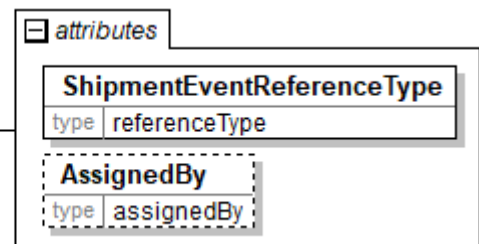

ShipmentEventReference will be deprecated in a future version V3R00 and should not be used in new integrations. Use instead DocumentReferenceInformation.

ShipmentEventReferenceType [attribute]

ShipmentEventReferenceType is mandatory. A single instance is required.

ShipmentEventReferenceType provides a contextual explanation of the specific reference identifier. Many items are currently prefixed by "Buyer", "Customer", "Seller", and/or "Supplier". Check for an existing non-prefixed version and use the non-prefixed version instead. In the (yet to be announced release date) version 3.0 the prefixed versions will be removed. Instead the attribute @AssignedBy will communicate the information previously communicated in the prefix.

Refer to ShipmentEventReferenceType definition for any enumerations.

AssignedBy [attribute]

AssignedBy is optional. A single instance might exist.

Identifies the type of party or the agency that has assigned the associated item, e.g. a reference of type OrderNumber.

Refer to AssignedBy for any enumerations.

ShipmentEventReferenceType [attribute]

ShipmentEventReferenceType provides a contextual explanation of the specific reference identifier. Many items are currently prefixed by "Buyer", "Customer", "Seller", and/or "Supplier". Check for an existing non-prefixed version and use the non-prefixed version instead. In the (yet to be announced release date) version 3.0 the prefixed versions will be removed. Instead the attribute @AssignedBy will communicate the information previously communicated in the prefix.

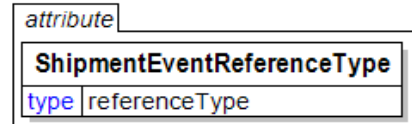

Refer to the [referenceType](#) entry for the list of enumerations and their definitions.

ShipmentEventStatusType [attribute]

Identifies the status of the information for the shipment event.

This item is restricted to the following list.

Amended

The supplied information is changed.

Cancelled

The supplied information has been cancelled. Items that have been cancelled are not included in totals on the summary levels of the e-Document.

NoAction

The supplied information has not been amended and thereby requires no action.

Original

The supplied information is the first version of that information.



ShipmentEventType [attribute]

Indicates the type of event.

This item is restricted to the following list.

Loading

Unloading



ShipmentID

The ShipmentID may be a Bill of Lading Marking, which is customer's reference mark on each package used for logistic purposes. Should not be mixed up with Bill of Lading number. Another example of ShipmentID is grouping by a ContainerID.

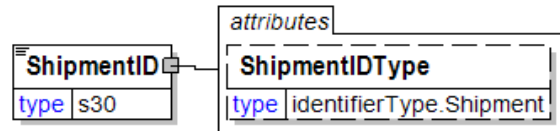

ShipmentIDType [attribute]

ShipmentIDType is optional. A single instance might exist.

Shipment ID Type

Refer to ShipmentIDType definition for any enumerations.

ShipmentIDType [attribute]

Shipment ID Type

This item is restricted to the following list.

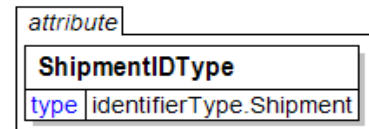

BillOfLadingMark

Assigning party's reference mark on each package used for logistic purposes (a mark which is painted to packages just to make handling easier). Not to be confused with Bill of Lading Number.

ContainerID

Container ID.

LotIdentifier

A unique code used to identify a grouping of product with one set of quality statistics common to all members of that group. Synonym: Lot Number

ShipmentIncident

A grouping element that contains information about the shipment incident.

(sequence)

The sequence of items below is mandatory. A

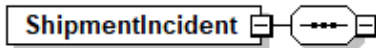

single instance is required.

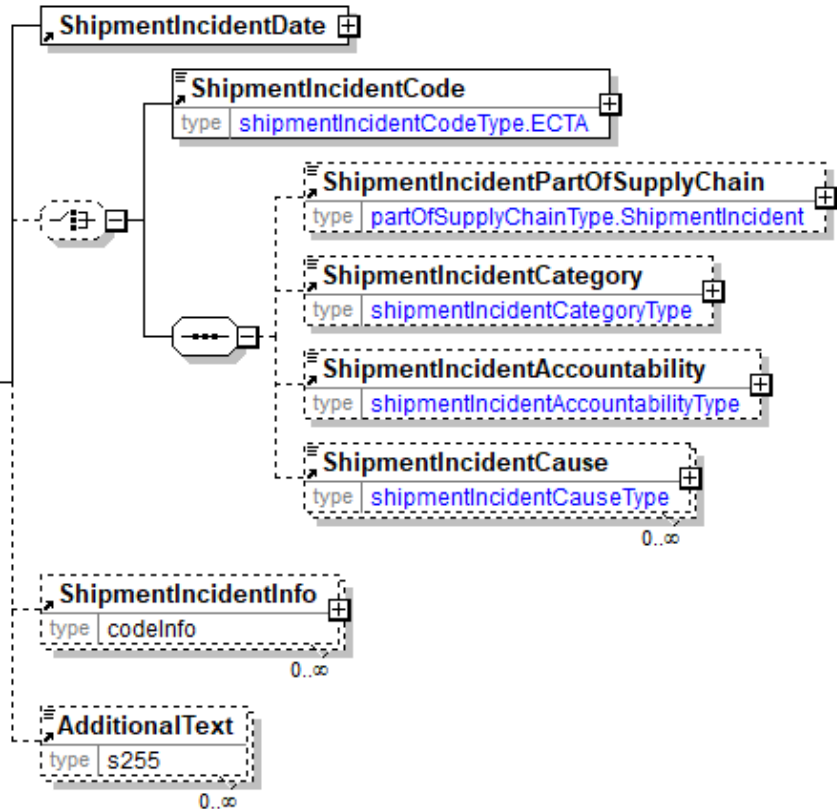

ShipmentIncidentDate

ShipmentIncidentDate is mandatory. A single instance is required.

The date of the shipment incident being reported.

(choice)

[choice] is optional. A single instance might exist.

ShipmentIncidentCode

ShipmentIncidentCode is mandatory. A single instance is required.

The ECTA-EPCA-CEFIC codes for shipment incidents. This element is validated (via patterns) to ensure that only valid codes are entered. Refer to www.ecta.be for more information.

(sequence)

The sequence of items below is mandatory. A single instance is required.

ShipmentIncidentPartOfSupplyChain

ShipmentIncidentPartOfSupplyChain is optional. A single instance might exist.

The ECTA-EPCA-CEFIC codes for the part of the supply chain within which the shipment incident occurred. Refer to www.ecta.be for more information.

Refer to *ShipmentIncidentPartOfSupplyChain* definition for any enumerations.

ShipmentIncidentCategory

ShipmentIncidentCategory is optional. A single instance might exist.

The ECTA-EPCA-CEFIC codes for shipment incident categorization. Refer to www.ecta.be for more information.

Refer to *ShipmentIncidentCategory* definition for any enumerations.

ShipmentIncidentAccountability

ShipmentIncidentAccountability is optional. A single instance might exist.

The ECTA-EPCA-CEFIC codes for shipment incident accountability. Refer to www.ecta.be for more information.

Refer to ShipmentIncidentAccountability definition for any enumerations.

ShipmentIncidentCause

ShipmentIncidentCause is optional. Multiple instances might exist.

The ECTA-EPCA-CEFIC codes for shipment incident cause. Refer to www.ecta.be for more information.

Refer to ShipmentIncidentCause definition for any enumerations.

ShipmentIncidentInfo

ShipmentIncidentInfo is optional. Multiple instances might exist.

A grouping element that specifies information about a shipment incident.

AdditionalText

AdditionalText is optional. Multiple instances might exist.

A text field that is used to communicate information not previously defined or for special instructions. To be used only for circumstances not covered by specific elements.

ShipmentIncidentAccountability

The ECTA-EPCA-CEFIC codes for shipment incident accountability. Refer to www.ecta.be for more information.

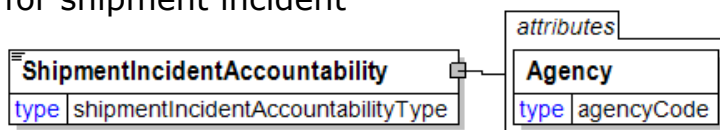

This item is restricted to the following list.

Haulier

Final Customer

(There is a space between these words.)

Supplier

Force Majeure

Events beyond the control of anyone. (There is a space between these words.)

Agency [attribute]

Agency is mandatory. A single instance is required.

Describes the agency maintaining the list of codes. To be included in this list the agency must be a recognized standards body or industry organisation.

- For the element that owns this attribute.
- For another attribute in the list of attributes associated with the parent element.

Refer to Agency definition for any enumerations.

ShipmentIncidentCategory

The ECTA-EPCA-CEFIC codes for shipment incident categorization. Refer to www.ecta.be for more information.

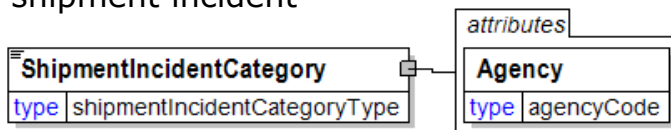

This item is restricted to the following list.

DateAndTime

Corresponds to the "Date & Time" ECTA-EPCA-CEFIC option.

Equipment

Product

Packaging

Documentation

Safety

Behaviour

Agency [attribute]

Agency is mandatory. A single instance is required.

Describes the agency maintaining the list of codes. To be included in this list the agency must be a recognized standards body or industry organisation.

- For the element that owns this attribute.
- For another attribute in the list of attributes associated with the parent element.

Refer to Agency definition for any enumerations.

ShipmentIncidentCause

The ECTA-EPCA-CEFIC codes for shipment incident cause. Refer to www.ecta.be for more information.

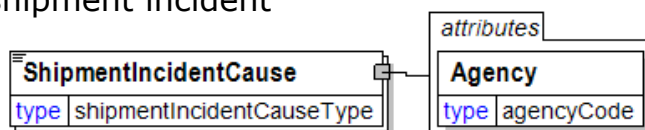

This item is restricted to the following list.

Human Error

(There is a space between words.)

Communication/Information/Instructions/Instructions/Failure

Documents Failure

(There is a space between words.)

Breakdown of equipment

(There is a space between words.)

Product or packaging damage

(There is a space between words.)

Wrong equipment

(There is a space between words.)

Non-availability

Rush order

(There is a space between words.)

Accident

Theft and Vandalism

(There is a space between words.)

Unsafe conditions

(There is a space between words.)

Upon request

(There is a space between words.)

Third party

(There is a space between words.)

Excessive customs clearance

(There is a space between words.)

Traffic

Strike

Weather

Agency [attribute]

Agency is mandatory. A single instance is required.

Describes the agency maintaining the list of codes. To be included in this list the agency must be a recognized standards body or industry organisation.

- For the element that owns this attribute.
- For another attribute in the list of attributes associated with the parent element.

Refer to Agency definition for any enumerations.

ShipmentIncidentCode

The ECTA-EPCA-CEFIC codes for shipment incidents.

This element is validated (via patterns) to ensure that only valid codes are entered. Refer to www.ecta.be for more information.

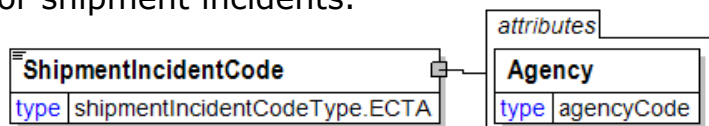

Agency [attribute]

Agency is mandatory. A single instance is required.

Describes the agency maintaining the list of codes. To be included in this list the agency must be a recognized standards body or industry organisation.

For the element that owns this attribute.

For another attribute in the list of attributes associated with the parent element.

Refer to Agency definition for any enumerations.

ShipmentIncidentDate

The date of the shipment incident being reported.

(sequence)

The sequence of items below is mandatory. A single instance is required.

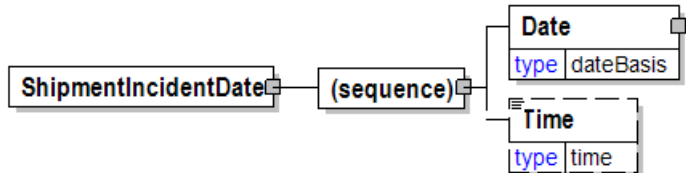

Date

Date is mandatory. A single instance is required.

A group element that contains the specification of Year, Month, and Day.

Time

Time is optional. A single instance might exist.

Times are treated in a standard XML fashion with a special case used to indicate a generalized "local" time. The standard XML approach to time is hh:mm:ss, hh:mm:ssZ, or hh:mm:ss±hh:mm.

hh:mm:ss±hh:mm is used to represent a time with a time zone. The time zone is communicated as the number of hours offset from the Universal Time Coordinate (UTC), a.k.a. Greenwich Mean Time.

hh:mm:ssZ indicates the time at Zulu (another name for UTC).

hh:mm:ss or hh:mm indicates within papiNet the applicable local time where the associated event is taking place. Caution should be used when processing times of this nature as the papiNet approach may be in discord with other users of XML.

ShipmentIncidentInfo

A grouping element that specifies information about a shipment incident.

Agency [attribute]

Agency is mandatory. A single instance is required.

Describes the agency maintaining the list of codes. To be included in this list the agency must be a recognized standards body or industry organisation.

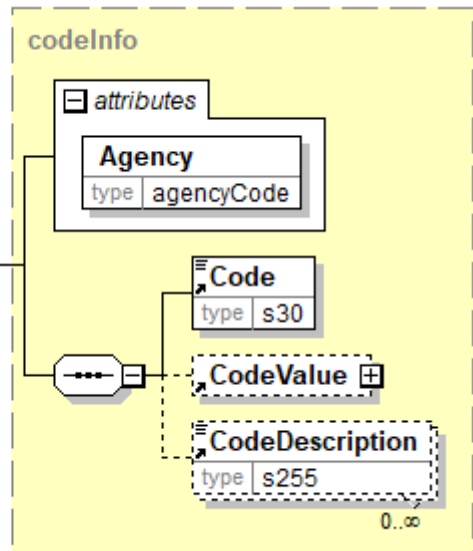
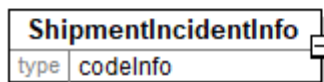

- For the element that owns this attribute.
- For another attribute in the list of

attributes associated with the parent element.

Refer to Agency definition for any enumerations.

(sequence)

The sequence of items below is mandatory. A single instance is required.

Code

Code is mandatory. A single instance is required.

Specifies a code that is defined by an agency. The agency is given for the whole construct containing the code.

CodeValue

CodeValue is optional. A single instance might exist.

A grouping element specifying a value belonging to a code that is defined by an agency.

CodeDescription

CodeDescription is optional. Multiple instances might exist.

A textual description for the meaning of a code that is defined by an agency. When the Code is associated with a CodeValue of type TextValue, then the CodeDescription is a textual description of both the Code and the TextValue.

ShipmentIncidentPartOfSupplyChain

The ECTA-EPCA-CEFIC codes for the part of the supply chain within which the shipment incident occurred. Refer to www.ecta.be for more information.



This item is restricted to the following list.

Delivery

Loading

Agency [attribute]

Agency is mandatory. A single instance is required.

Describes the agency maintaining the list of codes. To be included in this list the agency must be a recognized standards body or industry organisation.

- For the element that owns this attribute.
- For another attribute in the list of attributes associated with the parent element.

Refer to Agency definition for any enumerations.

ShipmentLoadDetails

A group element that containing information that relates to the shipment load details for the line item. Carrier and transport information may be detailed.

(sequence)

The sequence of items below is mandatory. A single instance is required.

DeliveryMessageNumber

DeliveryMessageNumber is optional. A single instance might exist.

A unique delivery identifier assigned to each DeliveryMessage as agreed between the trading partners.

DeliveryMessageReference

DeliveryMessageReference is optional. Multiple



instances might exist.

An element that identifies the relevant references pertaining to the DeliveryMessage, identified by DeliveryMessageReferenceType.

CarrierParty

CarrierParty is optional. A single instance might exist.

The party performing the transport of the product from the pickup location to the ship-to location; could be a hauler.

(sequence)

The sequence of items below is optional. A single instance might exist.

SupplierOrderNumber

SupplierOrderNumber is mandatory. A single instance is required.

The number of the supplier order.

SupplierOrderLineNumber

SupplierOrderLineNumber is optional. A single instance might exist.

The number of the line item on the supplier order.

LocationParty

LocationParty is optional. Two instances might exist.

The organization or business entity where the business event took place or will take

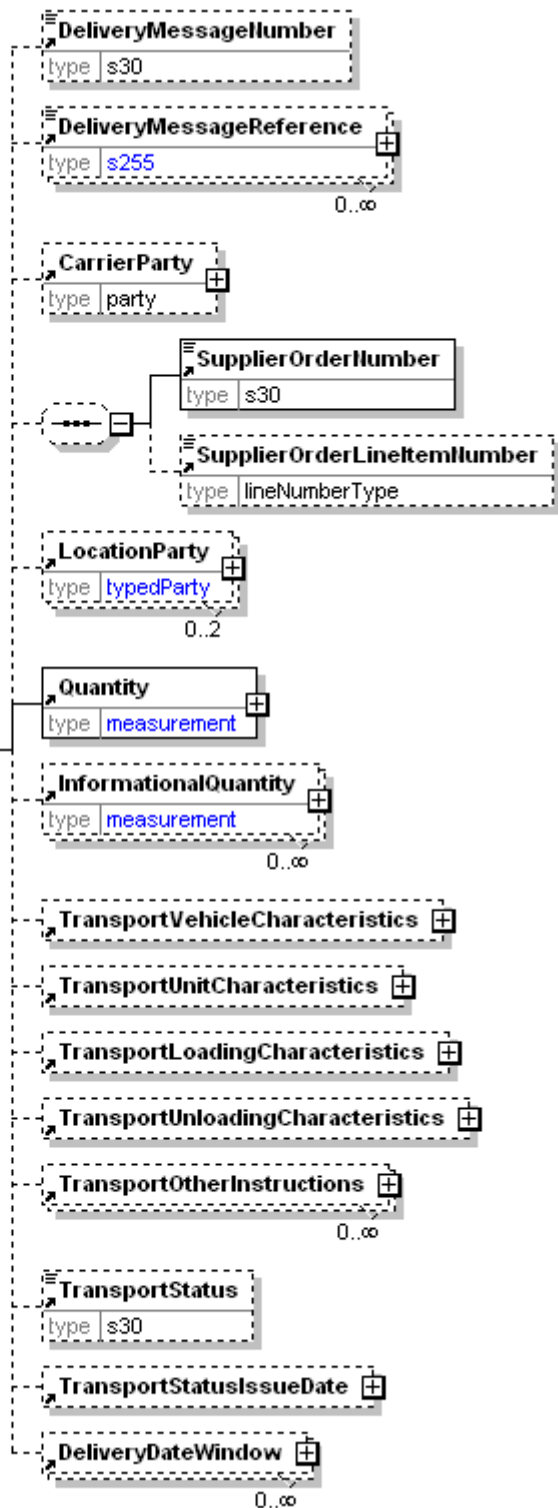

place.

Quantity

Quantity is mandatory. A single instance is required.

The Quantity element contains attributes that provide information about the type of quantity that is being communicated, the context in which the particular quantity is to be viewed, and (if the quantity represents an adjustment) an adjustment type.

The Quantity element contains three child elements that enable you to communicate a range of values for the quantity and a target or actual value. It is at this level (Value, RangeMin, and RangeMax) that the unit of measure is specified. This permits the range to be specified in a different unit of measure than the target.

InformationalQuantity

InformationalQuantity is optional. Multiple instances might exist.

A quantity given in a valid UOM used for information purposes only (not for calculation). For example, an ordered quantity was 100 reels as opposed to the invoice quantity of 20,000 pounds.

TransportVehicleCharacteristics

TransportVehicleCharacteristics is optional. A single instance might exist.

A group item containing information about a transport vehicle, e.g. a truck. A transport vehicle has its own power and can be used to pull, push, carry, or tow a transport unit loaded with goods.

TransportUnitCharacteristics

TransportUnitCharacteristics is optional. A single instance might exist.

A group item containing information about a transport unit, e.g. a trailer. Transport units contain goods and move using power from another source, the transport vehicle.

TransportLoadingCharacteristics

TransportLoadingCharacteristics is optional. A single instance might exist.

A group item defining how the transported items are to be loaded.

TransportUnloadingCharacteristics

TransportUnloadingCharacteristics is optional. A single instance might exist.

A group item defining how the transported items are to be unloaded.

TransportOtherInstructions

TransportOtherInstructions is optional. Multiple instances might exist.

A group item defining any other instructions for the transport not covered in the description of transport mode, vehicle, unit, and loading characteristics or defining an alternative description for the categories mentioned above.

TransportStatus

TransportStatus is optional. A single instance might exist.

Text element used to communicate the current status of the shipment actually being transported to the recipient. This element could indicate the tracking status that the transport company issues. Alternatively, it could be the vendor's internal tracking status of the shipment.

TransportStatusIssueDate

TransportStatusIssueDate is optional. A single instance might exist.

The Date and Time the transport status is issued.

DeliveryDateWindow

DeliveryDateWindow is optional. Multiple instances might exist.

A group item defining the date/time interval for delivery to take place. An element which may contain the estimated date for which delivery is expected. This date is not absolute.

ShipmentMethodOfPayment

An element communicating responsibility of freight payment and when transfer of ownership will occur.

LocationQualifier [attribute]

*LocationQualifier is optional.
A single instance might exist.*

An attribute of the shipment method of payment describing the location to which the delivery terms refer. This location determines where and when the goods ownership is transferred from the seller to the buyer.

Refer to LocationQualifier definition for any enumerations.

Method [attribute]

Method is optional. A single instance might exist.

An attribute of the shipment method of payment, which defines the responsibilities of buyers and sellers for delivery under a sales contract.

It especially determines the obligations of the seller and the buyer regarding the payment of the freight costs.

Refer to Method definition for any enumerations.

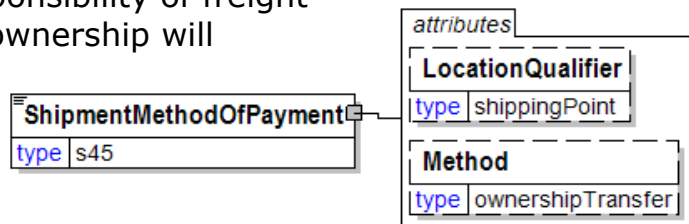

ShipmentStatus

The ShipmentStatus element is the root element for the ShipmentStatus e-Document.

The ShipmentStatus e-Document is sent to communicate the status of a shipment or consignment with references to other documents. Typically, a ShipmentStatus e-Document is sent from the forwarder or carrier to the consignor / forwarder.

Language [attribute]

Language is optional. A single instance might exist.

The valid Alpha 2- and Alpha 3-character list of language codes in the ISO 639-1 and 639-2 international standards.

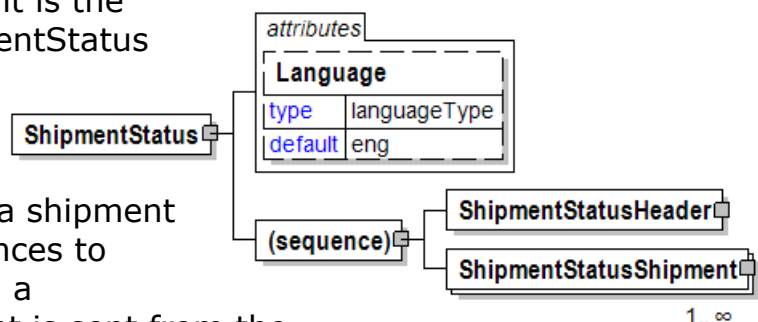

papiNet V2R31

Information on the content of this attribute is available at:
https://www.loc.gov/standards/iso639-2/php/code_list.php

(sequence)

The sequence of items below is mandatory. A single instance is required.

ShipmentStatusHeader

ShipmentStatusHeader is mandatory. A single instance is required.

The ShipmentStatusHeader contains information common to the entire ShipmentStatus e-Document.

ShipmentStatusShipment

ShipmentStatusShipment is mandatory. One instance is required, multiple instances might exist.

The shipment or consignment details that are being communicated.

ShipmentStatusDate

The Date and time for the transport status information in the shipment event.

(sequence)

The sequence of items below is mandatory. A single instance is required.

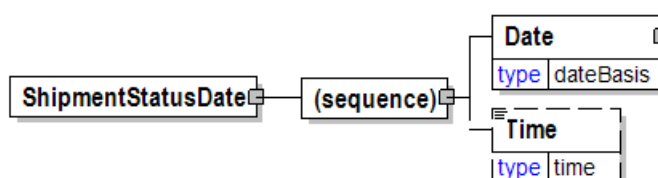

Date

Date is mandatory. A single instance is required.

A group element that contains the specification of Year, Month, and Day.

Time

Time is optional. A single instance might exist.

Times are treated in a standard XML fashion with a special case used to indicate a generalized "local" time. The standard XML approach to time is hh:mm:ss, hh:mm:ssZ, or hh:mm:ss±hh:mm.

hh:mm:ss±hh:mm is used to represent a time with a time zone. The time zone is communicated as the number of hours offset from the Universal Time Coordinate (UTC), a.k.a. Greenwich Mean Time.

hh:mm:ssZ indicates the time at Zulu (another name for UTC).

hh:mm:ss or hh:mm indicates within papiNet the applicable local time where the associated event is taking place. Caution should be used when processing times of this nature as the papiNet approach may be in discord with other users of XML.

ShipmentStatusDescription

Text field that may further describe the event's status in detail.

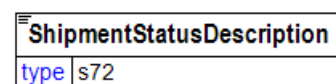

ShipmentStatusHeader

The ShipmentStatusHeader contains information common to the entire ShipmentStatus e-Document.

(sequence)

The sequence of items below is mandatory. A single instance is required.

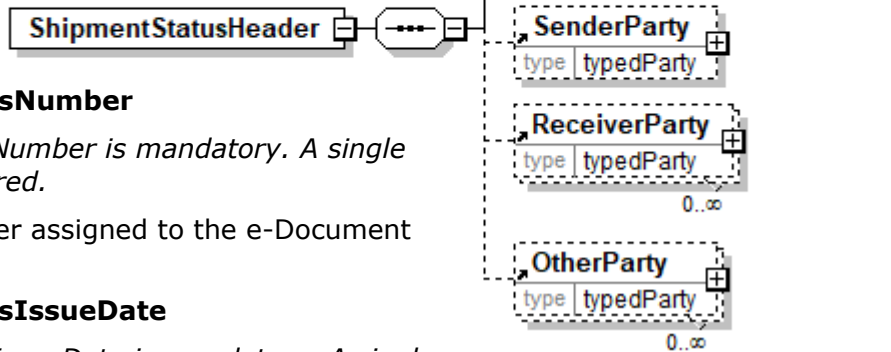

ShipmentStatusNumber

ShipmentStatusNumber is mandatory. A single instance is required.

Reference number assigned to the e-Document by the issuer.

ShipmentStatusIssueDate

ShipmentStatusIssueDate is mandatory. A single instance is required.

The date and optional time when the ShipmentStatus e-Document was issued.

RequestNumber

RequestNumber is optional. A single instance might exist.

A unique tracking number specifically identifying the InfoRequest e-Document to the originator. The tracking number is returned with the "information", the answer, to help match the answer to the request.

SenderParty

SenderParty is optional. A single instance might exist.

The business entity issuing the e-Document, the source of the document.

The entity responsible for the content. If the sender party has outsourced the message service to a third party the SenderParty is the issuer of the e-Document and not the party performing the transmission service of the electronic message.

ReceiverParty

ReceiverParty is optional. Multiple instances might exist.

The business entity for whom the e-Document is intended, the destination of the document.

The entity interested in the content. If the receiver party has outsourced the message service to a third party the ReceiverParty is the intended party for the e-Document and not the party performing the receiving service of the electronic message.

OtherParty

OtherParty is optional. Multiple instances might exist.

An organisation or business entity other than those specifically detailed within an e-Document.

ShipmentStatusIdentifier

Text to identify the status of the event.

ShipmentStatusType [attribute]

ShipmentStatusType is mandatory. A single instance is required.

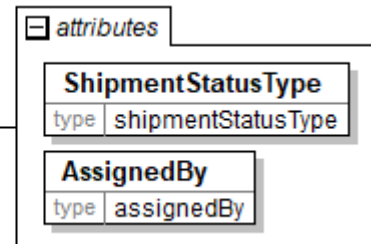
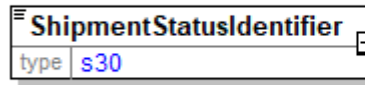

Identifies the status of the shipment being reported.

Refer to ShipmentStatusType definition for any enumerations.

AssignedBy [attribute]

AssignedBy is mandatory. A single instance is required.

Identifies the type of party or the agency that has assigned the associated item, e.g. a reference of type OrderNumber.

Refer to AssignedBy definition for any enumerations.

ShipmentStatusIssueDate

The date and optional time when the ShipmentStatus e-Document was issued.

(sequence)

The sequence of items below is mandatory. A single instance is required.

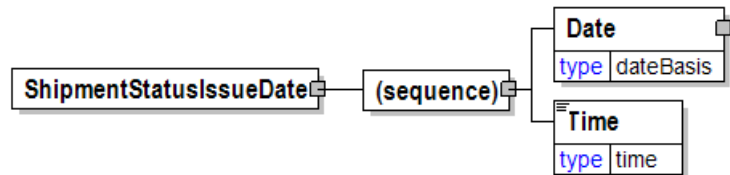

Date

Date is mandatory. A single instance is required.

A group element that contains the specification of Year, Month, and Day.

Time

Time is mandatory. A single instance is required.

Times are treated in a standard XML fashion with a special case used to indicate a generalized "local" time. The standard XML approach to time is hh:mm:ss, hh:mm:ssZ, or hh:mm:ss±hh:mm.

hh:mm:ss±hh:mm is used to represent a time with a time zone. The time zone is communicated as the number of hours offset from the Universal Time Coordinate (UTC), a.k.a. Greenwich Mean Time.

hh:mm:ssZ indicates the time at Zulu (another name for UTC).

hh:mm:ss or hh:mm indicates within papiNet the applicable local time where the associated event is taking place. Caution should be used when processing times of this nature as the papiNet approach may be in discord with other users of XML.

ShipmentStatusNumber

The unique identifier for the ShipmentStatus e-Document.

ShipmentStatusNumber	
type	s30

ShipmentStatusReference

An item detailing relevant references pertaining to the ShipmentStatus information. The type of reference is identified by the ShipmentStatusReferenceType attribute.

ShipmentStatusReference	
type	s255

attributes	
ShipmentStatusReferenceType	
type	referenceType
AssignedBy	
type	assignedBy

ShipmentStatusReferenceType [attribute]

ShipmentStatusReferenceType is mandatory. A single instance is required.

Provides a contextual explanation of the specific reference identifier. Many items are currently prefixed by "Buyer", "Forwarder", "Manufacturer", "Mill", "Seller", "Supplier", "Warehouse", or "Vendor". Check for an existing non-prefixed version and use the non-prefixed version instead. In the (yet to be announced release date) version 3.0 the prefixed versions will be removed. Instead the attribute @AssignedBy will communicate the information previously communicated in the prefix.

Refer to ShipmentStatusReferenceType definition for any enumerations.

AssignedBy [attribute]

AssignedBy is optional. A single instance might exist.

Identifies the type of party or the agency that has assigned the associated item, e.g. a reference of type OrderNumber.

Refer to AssignedBy for any enumerations.

ShipmentStatusReferenceType [attribute]

Provides a contextual explanation of the specific reference identifier. Many items are currently prefixed by "Buyer", "Forwarder", "Manufacturer", "Mill", "Seller", "Supplier", "Warehouse", or "Vendor". Check for an existing non-prefixed version and use the non-prefixed version instead. In the (yet to be announced release date) version 3.0 the prefixed versions will be removed. Instead the attribute @AssignedBy will communicate the information previously communicated in the prefix.

attribute	
ShipmentStatusReferenceType	
type	referenceType

Refer to the [referenceType](#) entry for the list of enumerations and their definitions.

ShipmentStatusRequestDetail

A grouping element that provides the parameters to be used when responding with a ShipmentStatus e-Document.

(sequence)

The sequence of items below is mandatory. A single instance is required.

SupplierParty

SupplierParty is optional. Multiple instances might exist.

The organisation or business entity responsible for providing the product. SupplierParty is also the seller of the

product, if Seller is not specified as OtherParty = Seller.

BuyerParty

BuyerParty is optional. Multiple instances might exist.

The legal entity to which the product is sold. Also commonly referred to as the sold-to party or customer. If no OtherParty is defined as the Payer, the Buyer is the Payer.

ShipToParty

ShipToParty is optional. Multiple instances might exist.

The name and/or address to which the goods should be delivered with the party type indicated by the PartyType attribute.

ForwarderParty

ForwarderParty is optional. Multiple instances might exist.

The trading partner involved in the forwarding of the shipment.

CarrierParty

CarrierParty is optional. Multiple instances might exist.

The party performing the transport of the product from the pickup location to the ship-to location; could be a hauler.

OtherParty

OtherParty is optional. Multiple instances might exist.

An organisation or business entity other than those specifically detailed within an e-Document.

ShipmentStatusSearchReference

ShipmentStatusSearchReference is mandatory. One instance is required, multiple instances might exist.

Used to specify a transport-related item that is used, as a parameter, when providing shipment status information.

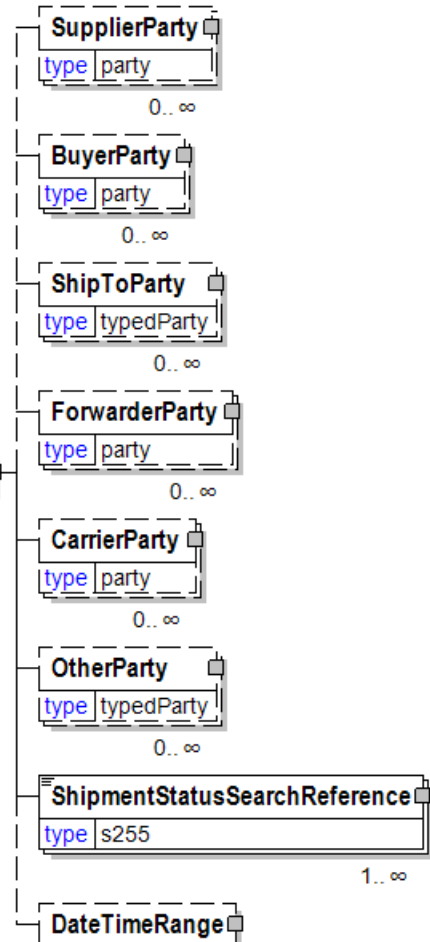

DateTimeRange

DateTimeRange is optional. A single instance might exist.

Specifies a date and/or time range.

ShipmentStatusSearchReference

Used to specify a transport-related item that is used, as a parameter, when

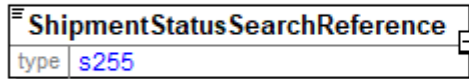

providing shipment status information.

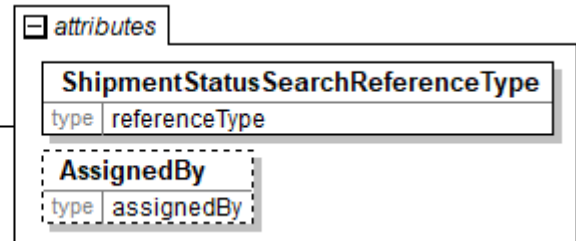

ShipmentStatusSearchReferenceType [attribute]

ShipmentStatusSearchReferenceType is mandatory. A single instance is required.

Provides a contextual explanation of the specific reference identifier. Many items are currently prefixed by "Buyer", "Forwarder", "Manufacturer", "Mill", "Seller", "Supplier", "Warehouse", or "Vendor". Check for an existing non-prefixed version and use the non-prefixed version instead. In the (yet to be announced release date) version 3.0 the prefixed versions will be removed. Instead the attribute @AssignedBy will communicate the information previously communicated in the prefix.

Refer to ShipmentStatusSearchReferenceType definition for any enumerations.

AssignedBy [attribute]

AssignedBy is optional. A single instance might exist.

Identifies the type of party or the agency that has assigned the associated item, e.g. a reference of type OrderNumber.

Refer to AssignedBy for any enumerations.

ShipmentStatusSearchReferenceType [attribute]

Provides a contextual explanation of the specific reference identifier. Many items are currently prefixed by "Buyer", "Forwarder", "Manufacturer", "Mill", "Seller", "Supplier", "Warehouse", or "Vendor". Check for an existing non-prefixed version and use the non-prefixed version instead. In the (yet to be announced release date)

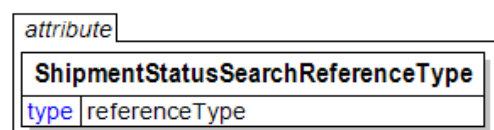

version 3.0 the prefixed versions will be removed. Instead the attribute @AssignedBy will communicate the information previously communicated in the prefix.

Refer to the [referenceType](#) entry for the list of enumerations and their definitions.

ShipmentStatusShipment

The shipment or consignment details that are being communicated.

LegStageType [attribute]

LegStageType is optional. A single instance might exist.

Refer to LegStageType definition for any enumerations.

ShipmentComplete [attribute]

ShipmentComplete is optional. A single instance might exist.

Indicates that all shipments for the particular delivery item are complete.

Refer to ShipmentComplete definition for any enumerations.

(sequence)

The sequence of items below is mandatory. A single instance is required.

ShipmentStatusReference

ShipmentStatusReference is mandatory. One instance is required, multiple instances might exist.

An item detailing relevant references pertaining to the ShipmentStatus information. The type of reference is identified by the ShipmentStatusReferenceType attribute.

TimePeriod

TimePeriod is optional. A single instance might exist.

The TimePeriod element is used to communicate a duration period of time as indicated in PeriodType.

ShipmentEventInformation

ShipmentEventInformation is mandatory. One instance is required, multiple

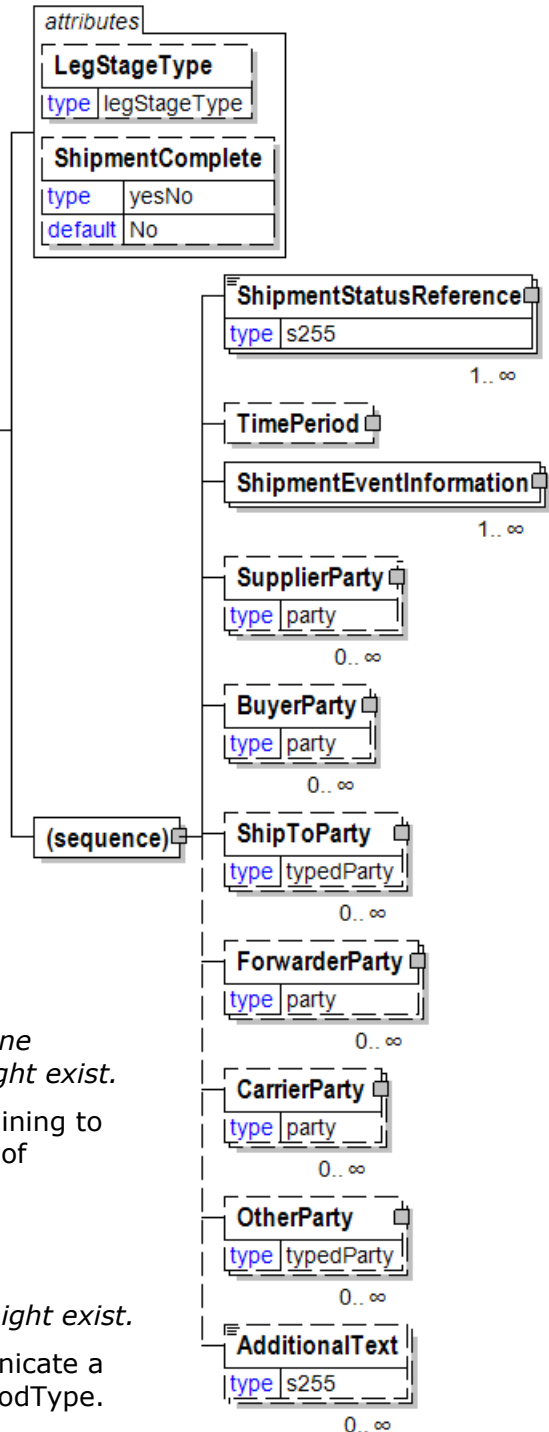

papiNet V2R31

instances might exist.

A grouping element that contains the items that describe the shipment event and status situation

SupplierParty

SupplierParty is optional. Multiple instances might exist.

The organisation or business entity responsible for providing the product. SupplierParty is also the seller of the product, if Seller is not specified as OtherParty = Seller.

BuyerParty

BuyerParty is optional. Multiple instances might exist.

The legal entity to which the product is sold. Also commonly referred to as the sold-to party or customer. If no OtherParty is defined as the Payer, the Buyer is the Payer.

ShipToParty

ShipToParty is optional. Multiple instances might exist.

The name and/or address to which the goods should be delivered with the party type indicated by the PartyType attribute.

ForwarderParty

ForwarderParty is optional. Multiple instances might exist.

The trading partner involved in the forwarding of the shipment.

CarrierParty

CarrierParty is optional. Multiple instances might exist.

The party performing the transport of the product from the pickup location to the ship-to location; could be a hauler.

OtherParty

OtherParty is optional. Multiple instances might exist.

An organisation or business entity other than those specifically detailed within an e-Document.

AdditionalText

AdditionalText is optional. Multiple instances might exist.

A text field that is used to communicate information not previously defined or for special instructions. To be used only for circumstances not covered by specific elements.

ShipmentStatusType [attribute]

Identifies the status of the shipment being reported.

This item is restricted to the following list.

OnTime

The shipment is on-time.

Early

The shipment is before planned schedule.

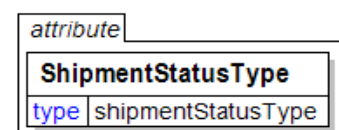

Delayed

The shipment has been delayed.

Cancelled

The shipment was cancelled. Do not deliver this product.

Rejected

The shipment has been rejected.

Unspecified

When a status is required to be communicated but none is available.

ShipmentSummary

Summary information for an entire shipment

(sequence)

The sequence of items below is mandatory. A single instance is required.

TotalQuantity

TotalQuantity is optional. A single instance might exist.

The total quantity of similar items in the e-Document. TotalQuantity is primarily used in the summary section of documents where it is repeatable to permit totaling for different units of measure.

TotalInformationalQuantity

TotalInformationalQuantity is optional. Multiple instances might exist.

A quantity that is used to communicate related information about the parent element. This element represents a total that is derived from individual line items.

ProductSummary

ProductSummary is optional. A single instance might exist.

Group of elements to provide summary information on product level.

LengthSpecification

LengthSpecification is optional. Multiple instances might exist.

Length specification of the wood product.

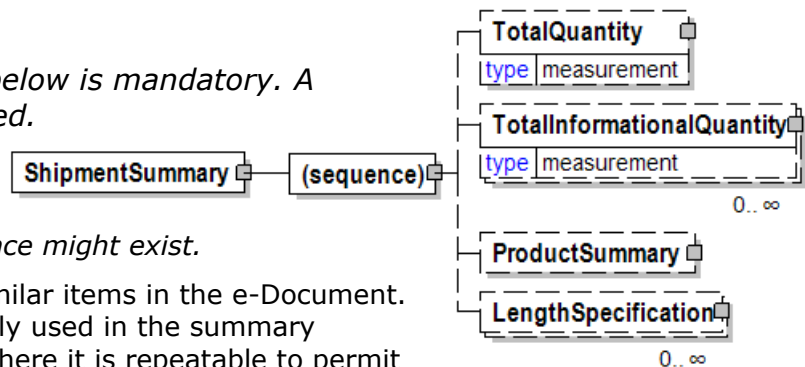

ShippingInstructions

The ShippingInstructions element is the root element for the ShippingInstructions e-Document.

The ShippingInstructions e-Document communicates delivery information for product(s) supported by a PurchaseOrder.

ShippingInstructionsType [attribute]

ShippingInstructionsType is mandatory. A single instance is required.

ShippingInstructionType defines the type of shipping instruction

Refer to ShippingInstructionsType definition for any enumerations.

ShippingInstructionsStatusType [attribute]

ShippingInstructionsStatusType is mandatory. A single instance is required.

ShippingInstructions Status Type

Refer to ShippingInstructionsStatusType definition for any enumerations.

IsThirdPartyAdvice [attribute]

IsThirdPartyAdvice is optional. A single instance might exist.

An advice to a third party of a ShippingInstructions.

Refer to IsThirdPartyAdvice definition for any enumerations.

IsThirdPartyShipment [attribute]

IsThirdPartyAdvice is optional. A single instance might exist.

Shipment request to a party other than the party that ordered the product from the supplier.

Either "Yes" or "No".

Reissued [attribute]

Reissued is optional. A single instance might exist.

Either "Yes" or "No".

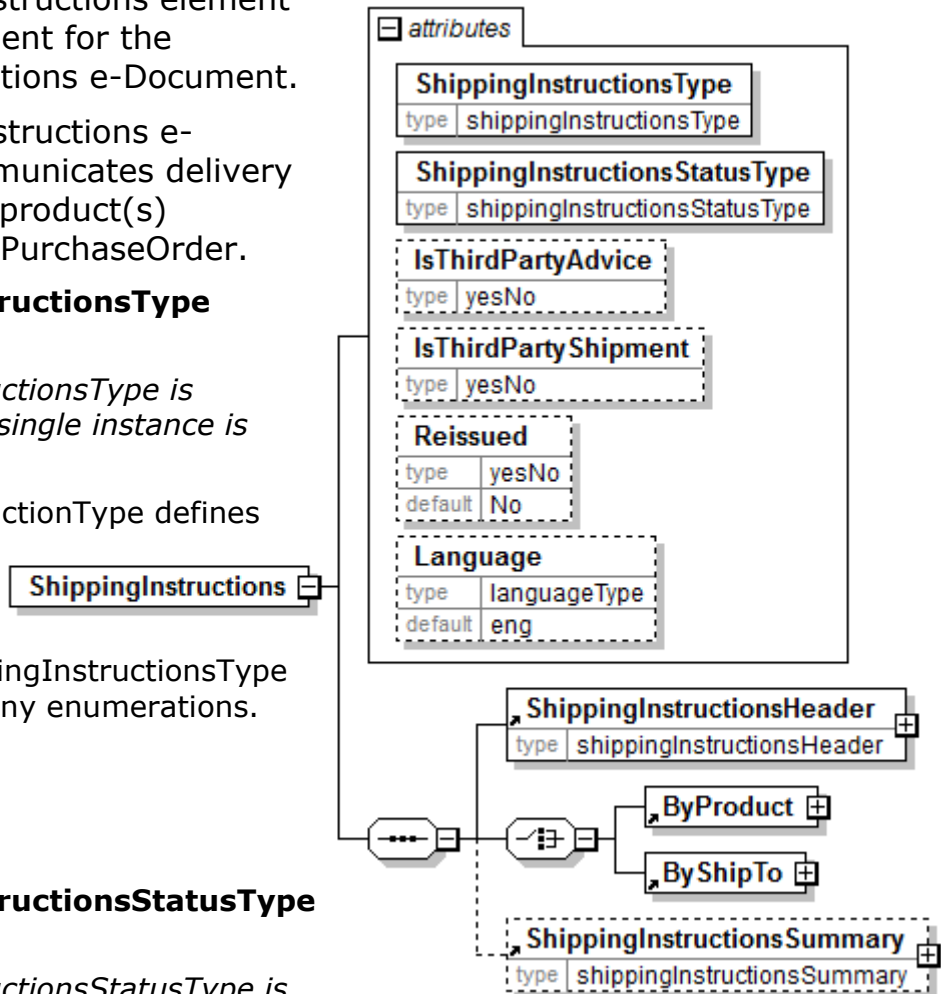

papiNet V2R31

Refer to Reissued definition for any enumerations.

Language [attribute]

Language is optional. A single instance might exist.

The valid Alpha 2- and Alpha 3-character list of language codes in the ISO 639-1 and 639-2 international standards.

Information on the content of this attribute is available at:
https://www.loc.gov/standards/iso639-2/php/code_list.php

(sequence)

The sequence of items below is mandatory. A single instance is required.

ShippingInstructionsHeader

ShippingInstructionsHeader is mandatory. A single instance is required.

Information common to all items in a ShippingInstructions e-Document.

(choice)

[choice] is mandatory. A single instance is required.

ByProduct

ByProduct is mandatory. A single instance is required.

Identification takes place by product.

ByShipTo

ByShipTo is mandatory. A single instance is required.

ByShipTo

ShippingInstructionsSummary

ShippingInstructionsSummary is optional. A single instance might exist.

Summary information for the ShippingInstructions e-Document.

ShippingInstructionsConfirmationIssuedDate

The date on which the shipping instruction confirmation was issued.

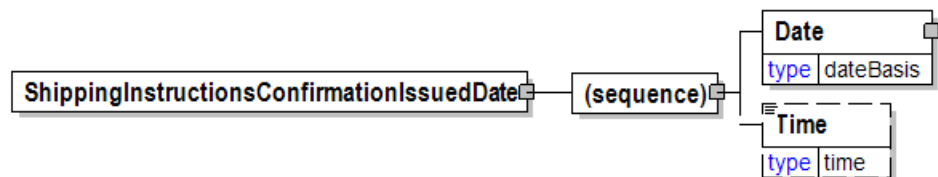

(sequence)

The sequence of items below is mandatory. A single instance is required.

Date

Date is mandatory. A single instance is required.

A group element that contains the specification of Year, Month, and Day.

Time

Time is optional. A single instance might exist.

Times are treated in a standard XML fashion with a special case used to indicate a generalized "local" time. The standard XML approach to time is hh:mm:ss,

hh:mm:ssZ, or hh:mm:ss±hh:mm.

hh:mm:ss±hh:mm is used to represent a time with a time zone. The time zone is communicated as the number of hours offset from the Universal Time Coordinate (UTC), a.k.a. Greenwich Mean Time.

hh:mm:ssZ indicates the time at Zulu (another name for UTC).

hh:mm:ss or hh:mm indicates within papiNet the applicable local time where the associated event is taking place. Caution should be used when processing times of this nature as the papiNet approach may be in discord with other users of XML.

ShippingInstructionsHeader

Information common to all items in a ShippingInstructions e-Document.

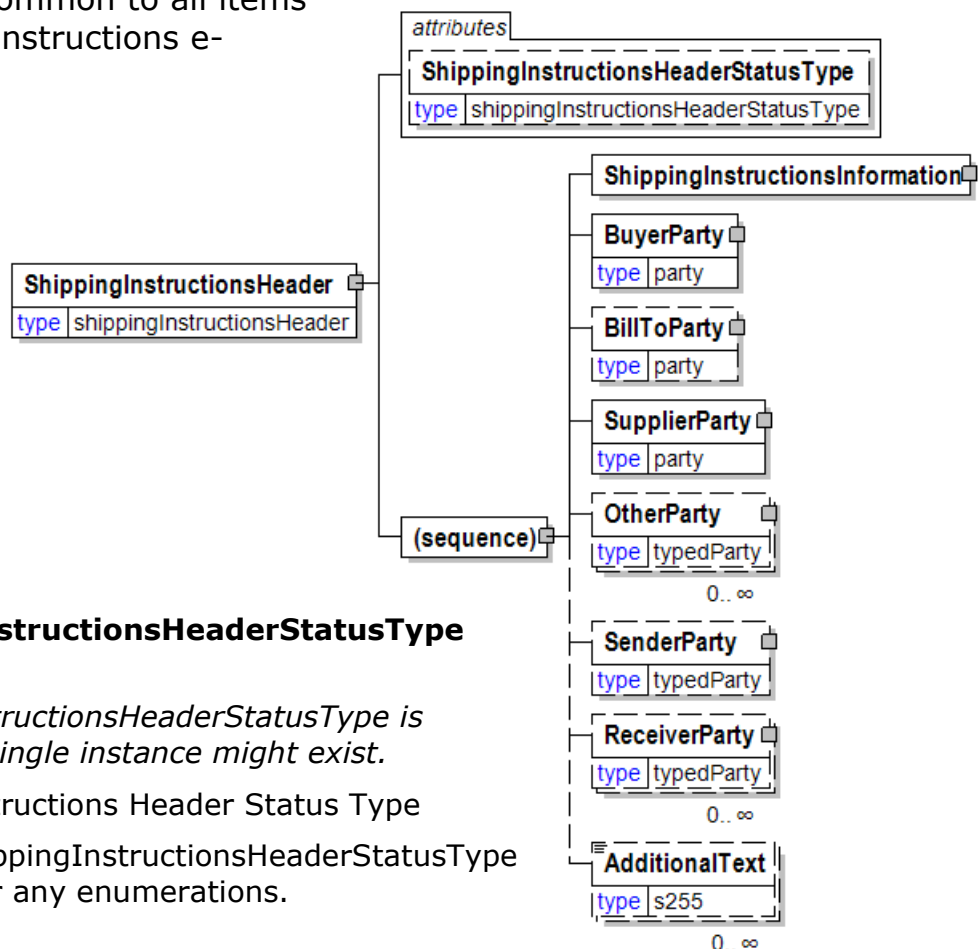

ShippingInstructionsHeaderStatusType [attribute]

ShippingInstructionsHeaderStatusType is optional. A single instance might exist.

ShippingInstructions Header Status Type

Refer to ShippingInstructionsHeaderStatusType definition for any enumerations.

(sequence)

The sequence of items below is mandatory. A single instance is required.

ShippingInstructionsInformation

ShippingInstructionsInformation is mandatory. A single instance is required.

A group item containing information unique to this ShippingInstructions and reference information used to identify the product to be shipped

BuyerParty

BuyerParty is mandatory. A single instance is required.

The legal entity to which the product is sold. Also commonly referred to as the sold-to party or customer. If no OtherParty is defined as the Payer, the Buyer is the

Payer.

BillToParty

BillToParty is optional. A single instance might exist.

The address where the invoice is to be sent.

SupplierParty

SupplierParty is mandatory. A single instance is required.

The organisation or business entity responsible for providing the product.

SupplierParty is also the seller of the product, if Seller is not specified as OtherParty = Seller.

OtherParty

OtherParty is optional. Multiple instances might exist.

An organisation or business entity other than those specifically detailed within an e-Document.

SenderParty

SenderParty is optional. A single instance might exist.

The business entity issuing the e-Document, the source of the document.

The entity responsible for the content. If the sender party has out sourced the message service to a third party the SenderParty is the issuer of the e-Document and not the party performing the transmission service of the electronic message.

ReceiverParty

ReceiverParty is optional. Multiple instances might exist.

The business entity for whom the e-Document is intended, the destination of the document.

The entity interested in the content. If the receiver party has outsourced the message service to a third party the ReceiverParty is the intended party for the e-Document and not the party performing the receiving service of the electronic message.

AdditionalText

AdditionalText is optional. Multiple instances might exist.

A text field that is used to communicate information not previously defined or for special instructions. To be used only for circumstances not covered by specific elements.

ShippingInstructionsHeaderStatusType [attribute]

ShippingInstructions Header Status Type

This item is restricted to the following list.

attribute
ShippingInstructionsHeaderStatusType
type shippingInstructionsHeaderStatusType

Accepted

The supplied information is accepted.

Amended

The supplied information is changed.

NoAction

The supplied information has not been amended and thereby requires no action.

Original

The supplied information is the first version of that information.

Rejected

The supplied information is rejected.

ShippingInstructionsInformation

A group item containing information unique to this ShippingInstructions and reference information used to identify the product to be shipped

(sequence)

The sequence of items below is

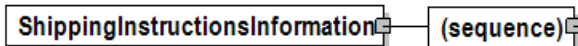

mandatory. A single instance is required.

ShippingInstructionsNumber

ShippingInstructionsNumber is mandatory. A single instance is required.

The unique shipping instruction.

ShippingInstructionsIssuedDate

ShippingInstructionsIssuedDate is mandatory. A single instance is required.

The date on which the shipping instruction was issued.

ShippingInstructionsConfirmationIssuedDate

ShippingInstructionsConfirmationIssuedDate is optional. A single instance might exist.

The date on which the shipping instruction confirmation was issued.

TransactionHistoryNumber

TransactionHistoryNumber is optional. A single instance might exist.

A sequential number that keeps track of the version of a document.

However when the document is a confirmation document, in which case the TransactionHistoryNumber refers to the trigger transaction for the confirmation.

TransactionHistoryConfirmationNumber

TransactionHistoryConfirmationNumber is optional. A single instance might exist.

A sequential number that keeps track the version of a confirmation document.

When the document is a confirmation document, then the TransactionHistoryNumber refers to the trigger transaction for the confirmation.

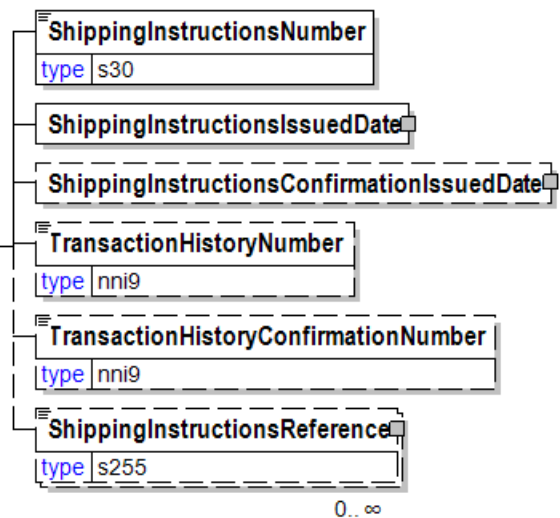

ShippingInstructionsReference

ShippingInstructionsReference is optional. Multiple instances might exist.

A group item detailing relevant references (such as ISBN) pertaining to the ShippingInstructions and/or product being shipped.

ShippingInstructionsIssuedDate

The date on which the shipping instruction was issued.

(sequence)

The sequence of items below is mandatory. A single instance is required.

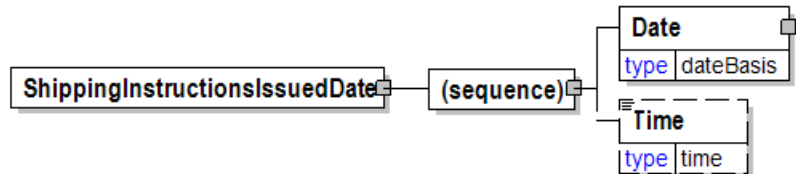

Date

Date is mandatory. A single instance is required.

A group element that contains the specification of Year, Month, and Day.

Time

Time is optional. A single instance might exist.

Times are treated in a standard XML fashion with a special case used to indicate a generalized "local" time. The standard XML approach to time is hh:mm:ss, hh:mm:ssZ, or hh:mm:ss±hh:mm.

hh:mm:ss±hh:mm is used to represent a time with a time zone. The time zone is communicated as the number of hours offset from the Universal Time Coordinate (UTC), a.k.a. Greenwich Mean Time.

hh:mm:ssZ indicates the time at Zulu (another name for UTC).

hh:mm:ss or hh:mm indicates within papiNet the applicable local time where the associated event is taking place. Caution should be used when processing times of this nature as the papiNet approach may be in discord with other users of XML.

ShippingInstructionsLineItemByProduct

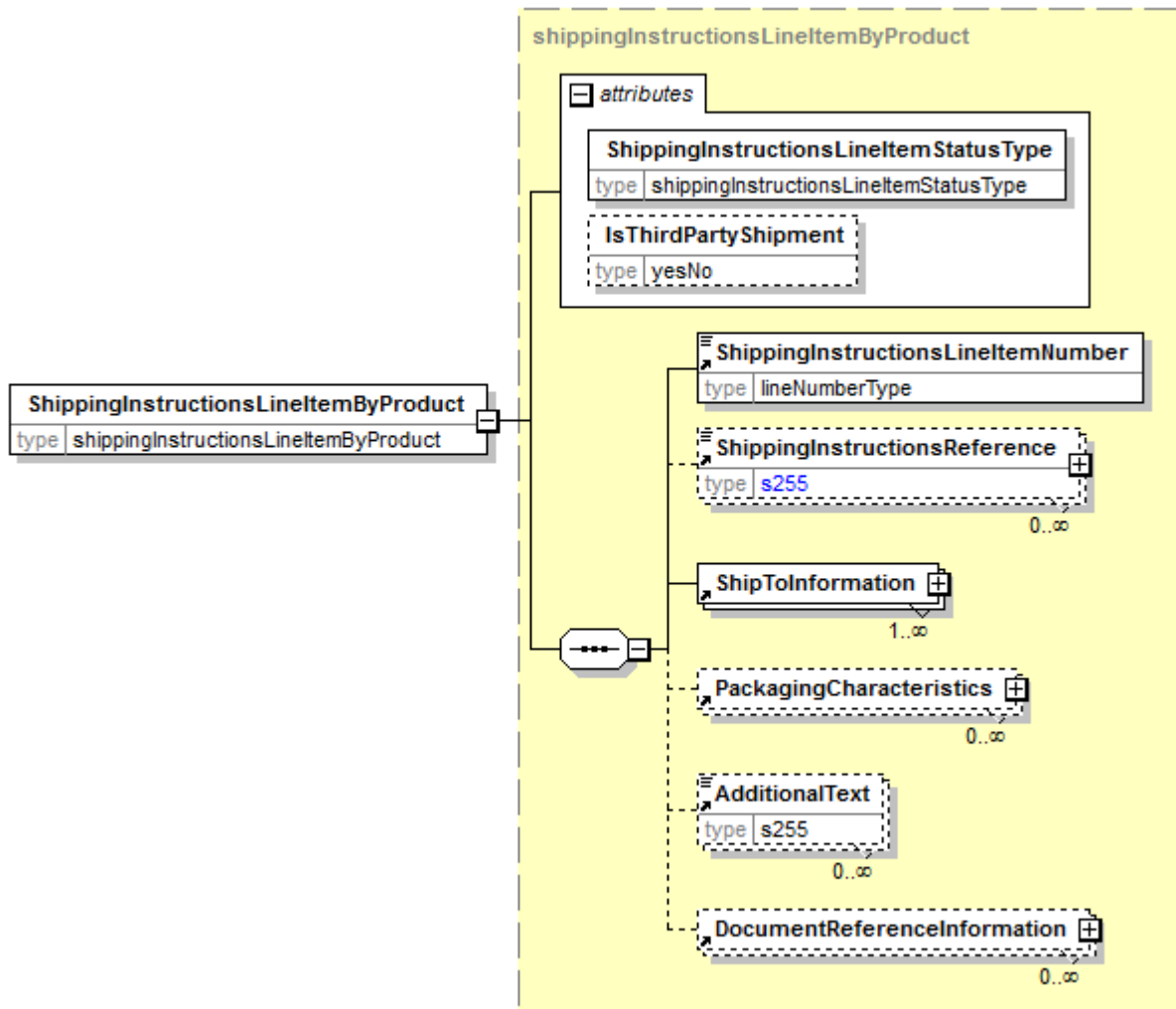

ShippingInstructionsLineItemByProduct

ShippingInstructionsLineItemStatusType [attribute]

ShippingInstructionsLineItemStatusType is mandatory. A single instance is required.

ShippingInstructions Line Item Status Type

Refer to ShippingInstructionsLineItemStatusType definition for any enumerations.

IsThirdPartyShipment [attribute]

IsThirdPartyAdvice is optional. A single instance might exist.

Shipment request to a party other than the party that ordered the product from the supplier.

Either "Yes" or "No".

(sequence)

The sequence of items below is mandatory. A single instance is required.

ShippingInstructionsLineItemNumber

ShippingInstructionsLineItemNumber is mandatory. A single instance is required.

The sequential number that uniquely identifies the ShippingInstructions line item.

ShippingInstructionsReference

ShippingInstructionsReference is optional. Multiple instances might exist.

A group item detailing relevant references (such as ISBN) pertaining to the ShippingInstructions and/or product being shipped.

ShipToInformation

ShipToInformation is mandatory. One instance is required, multiple instances might exist.

Group element containing information about the ship to and delivery of a product.

PackagingCharacteristics

PackagingCharacteristics is optional. Multiple instances might exist.

An element containing carton or pallet packing information. PackagingCharacteristics can either have the BoxCharacteristics or PalletPackagingCharacteristics element not both.

AdditionalText

AdditionalText is optional. Multiple instances might exist.

A text field that is used to communicate information not previously defined or for special instructions. To be used only for circumstances not covered by specific elements.

DocumentReferenceInformation

DocumentReferenceInformation is optional. Multiple instances might exist.

A group item containing reference information applicable to a document.

ShippingInstructionsLineItemByShipTo

ShippingInstructions
Line Item By Ship To

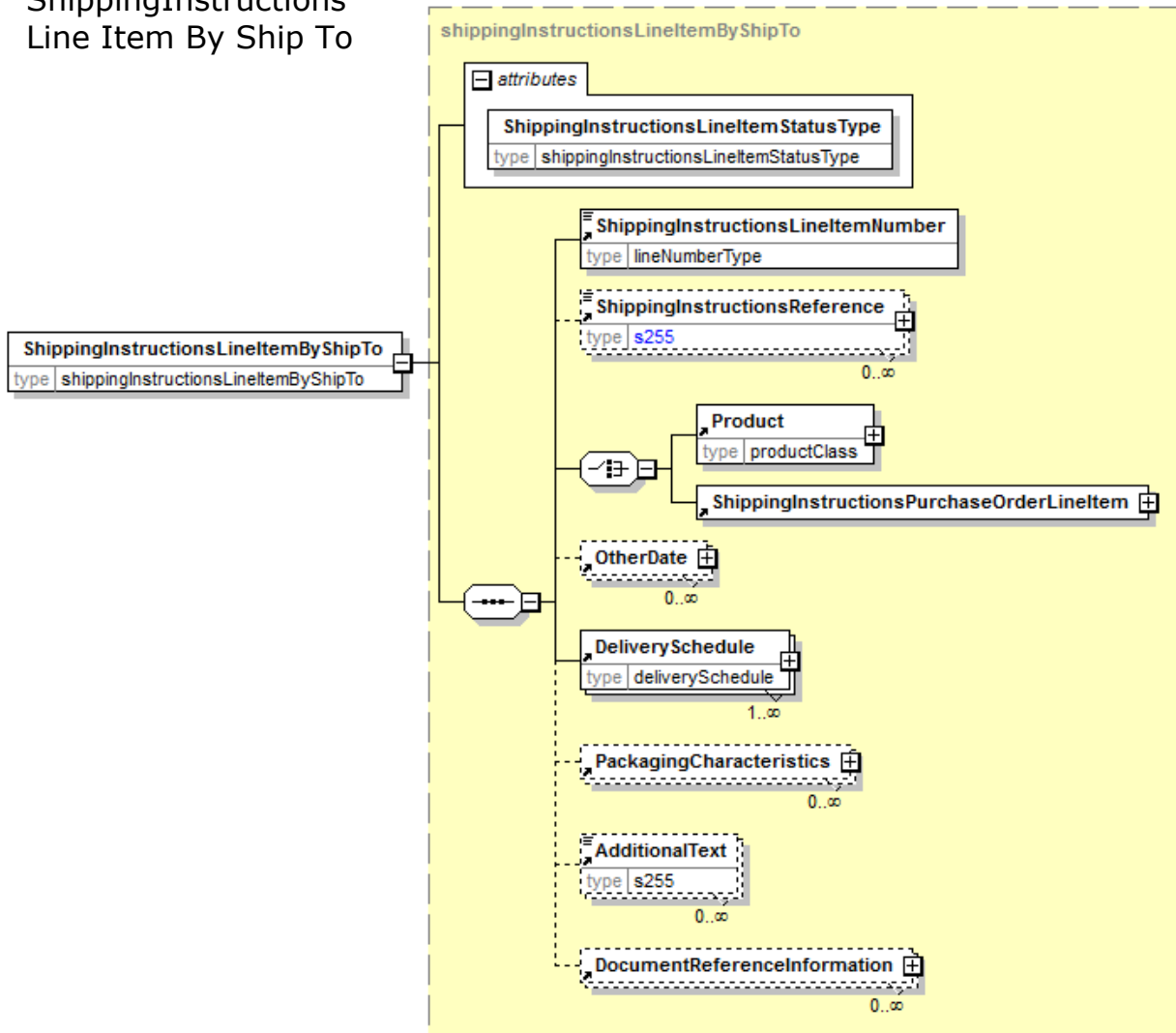

ShippingInstructionsLineItemStatusType [attribute]

ShippingInstructionsLineItemStatusType is mandatory. A single instance is required.

ShippingInstructions Line Item Status Type

Refer to ShippingInstructionsLineItemStatusType definition for any enumerations.

(sequence)

The sequence of items below is mandatory. A single instance is required.

ShippingInstructionsLineItemNumber

ShippingInstructionsLineItemNumber is mandatory. A single instance is required.

The sequential number that uniquely identifies the ShippingInstructions line item.

ShippingInstructionsReference

ShippingInstructionsReference is optional. Multiple instances might exist.

A group item detailing relevant references (such as ISBN) pertaining to the ShippingInstructions and/or product being shipped.

papiNet V2R31

(choice)

[choice] is mandatory. A single instance is required.

Product

Product is mandatory. A single instance is required.

Product is a group item defining the article and its characteristics. Product is used to specify product characteristics organized by ProductIdentifier, ProductDescription, and Classification. Book Manufacturing, Label Stock, Paper, Pulp, Recovered Paper, Wood Products, and Virgin Fibre market segments have defined their product characteristics and conversion features for implementation in papiNet.

ShippingInstructionsPurchaseOrderLineItem

ShippingInstructionsPurchaseOrderLineItem is mandatory. A single instance is required.

PurchaseOrder line item information for PurchaseOrder being referenced in ShippingInstructions.

OtherDate

OtherDate is optional. Multiple instances might exist

A date that may not be specifically detailed within a document (example: print date at the PurchaseOrderLineItem).

DeliverySchedule

DeliverySchedule is mandatory. One instance is required, Multiple instances might exist.

A group item defining a series of DeliveryDateWindow(s) in which specified quantities must be delivered.

PackagingCharacteristics

PackagingCharacteristics is optional. Multiple instances might exist.

An element containing carton or pallet packing information. PackagingCharacteristics can either have the BoxCharacteristics or PalletPackagingCharacteristics element not both.

AdditionalText

AdditionalText is optional. Multiple instances might exist.

A text field that is used to communicate information not previously defined or for special instructions. To be used only for circumstances not covered by specific elements.

DocumentReferenceInformation

DocumentReferenceInformation is optional. Multiple instances might exist.

A group item containing reference information applicable to a document.

ShippingInstructionsLineItemNumber

The sequential number that uniquely identifies the ShippingInstructions line item.

ShippingInstructionsLineItemNumber	
type	lineNumberType

ShippingInstructionsLineItemType [attribute]

ShippingInstructions Line Item Status Type

This item is restricted to the following list.



Accepted

The supplied information is accepted.

Amended

The supplied information is changed.

Cancelled

The supplied information has been cancelled. Items that have been cancelled are not included in totals on the summary levels of the e-Document.

NoAction

The supplied information has not been amended and thereby requires no action.

Original

The supplied information is the first version of that information.

Pending

The supplied information is not complete and will be updated later.

Rejected

The supplied information is rejected.

ShippingInstructionsNumber

The unique shipping instruction.

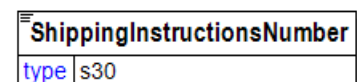

ShippingInstructionsPurchaseOrderLineItem

PurchaseOrder line item information for PurchaseOrder being referenced in ShippingInstructions.

(sequence)

The sequence of items below is mandatory. A

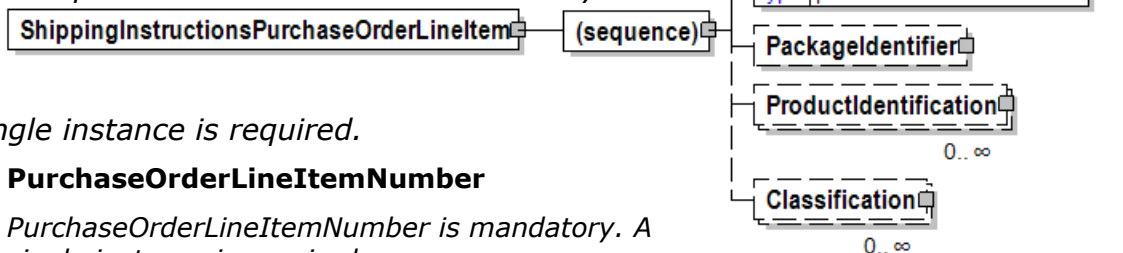

single instance is required.

PurchaseOrderLineItemNumber

PurchaseOrderLineItemNumber is mandatory. A single instance is required.

papiNet V2R31

The sequential number that uniquely identifies the PurchaseOrder line item.

PurchaseOrderInformation

PurchaseOrderInformation is mandatory. A single instance is required.

A group item containing information unique to this PurchaseOrder, which is provided by the buyer. PurchaseOrderInformation can be optional in the supply chain. Invoices are created without having a PurchaseOrder in Vendor Managed Inventory. Freight invoices also will not have a PurchaseOrder number.

PackageIdentifier

PackageIdentifier is optional. A single instance might exist.

The identifier of the productpackage (such as reel ID or pallet ID) that is used along with the PurchaseOrderLineNumber to call off the product.

ProductIdentification

ProductIdentification is optional. Multiple instances might exist.

A grouping element designed to communicate product identification related to the parent element that contains this item.

Classification

Classification is optional. Multiple instances might exist.

A group item that details the product classification according to a particular organization's scheme. An item across multiple classifications would still be recognized as the same item. Examples of some product classifications are: Containerboard, Pulp-Dissolving, or Newsprint.

ShippingInstructionsReference

A group item detailing relevant references (such as ISBN) pertaining to the

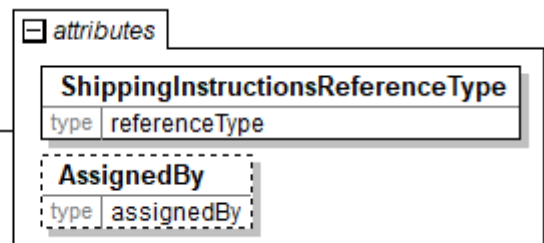
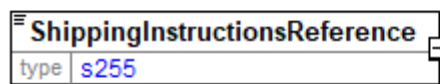

ShippingInstructions and/or product being shipped.

ShippingInstructionsReferenceType [attribute]

ShippingInstructionsReferenceType is mandatory. A single instance is required.

Provides a contextual explanation of the specific reference identifier. Many items are currently prefixed by "Buyer", "Forwarder", "Manufacturer", "Mill", "Seller", "Supplier", "Warehouse", or "Vendor". Check for an existing non-prefixed version and use the non-prefixed version instead. In the (yet to be announced release date) version 3.0 the prefixed versions will be removed. Instead the attribute @AssignedBy will communicate the information previously communicated in the prefix.

Refer to ShippingInstructionsReferenceType definition for any enumerations.

AssignedBy [attribute]

AssignedBy is optional. A single instance might exist.

papiNet V2R31

Identifies the type of party or the agency that has assigned the associated item, e.g. a reference of type OrderNumber.

Refer to AssignedBy for any enumerations.

ShippingInstructionsReferenceType [attribute]

Provides a contextual explanation of the specific reference identifier. Many items are currently prefixed by "Buyer", "Forwarder", "Manufacturer", "Mill", "Seller", "Supplier", "Warehouse", or "Vendor". Check for an existing non-prefixed version and use the non-prefixed version instead. In the (yet to be announced release date) version 3.0 the prefixed versions will be removed. Instead the attribute @AssignedBy will communicate the information previously communicated in the prefix.

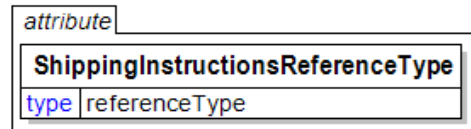

Refer to the [referenceType](#) entry for the list of enumerations and their definitions.

ShippingInstructionsRequestDetail

A grouping element that provides the parameters to be used when responding with a ShippingInstructions e-Document.

(sequence)

The sequence of items below is mandatory. A single instance is required.

SupplierParty

SupplierParty is optional. Multiple instances might exist.

The organisation or business entity responsible for providing the product. SupplierParty is also the seller of the product, if Seller is not specified as OtherParty = Seller.

BuyerParty

BuyerParty is optional. Multiple instances might exist.

The legal entity to which the product is sold. Also commonly referred to as the sold-to party or customer. If no OtherParty is defined as the Payer, the Buyer is the Payer.

ShipToParty

ShipToParty is optional. Multiple instances might exist.

The name and/or address to which the goods should be delivered with the party type indicated by the PartyType attribute.

ForwarderParty

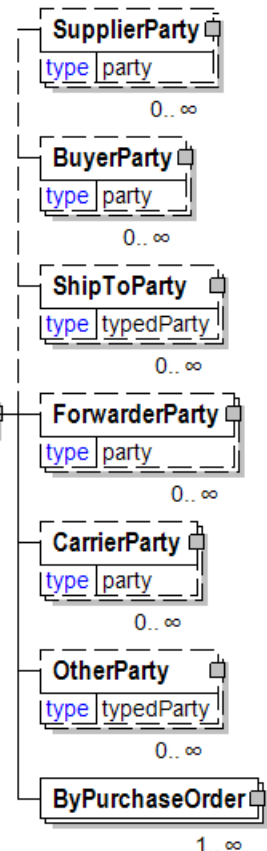

ForwarderParty is optional. Multiple instances might exist.

The trading partner involved in the forwarding of the shipment.

CarrierParty

CarrierParty is optional. Multiple instances might exist.

The party performing the transport of the product from the pickup location to the ship-to location; could be a hauler.

OtherParty

OtherParty is optional. Multiple instances might exist.

An organisation or business entity other than those specifically detailed within an e-Document.

ByPurchaseOrder

ByPurchaseOrder is mandatory. One instance is required, multiple instances might exist.

Selection criteria for communicating purchase order information.

ShippingInstructionsStatusType [attribute]

ShippingInstructions Status Type

This item is restricted to the following list.

Accepted

The supplied information is accepted.

Amended

The supplied information is changed

Cancelled

The supplied information has been cancelled. Items that have been cancelled are not included in totals on the summary levels of the e-Document.

Original

The supplied information is the first version of that information.

Rejected

The supplied information is rejected.

attribute

ShippingInstructionsStatusType

type shippingInstructionsStatusType

ShippingInstructionsSummary

Summary information for the ShippingInstructions e-Document.

(sequence)

The sequence of items below is mandatory. A single instance is required.

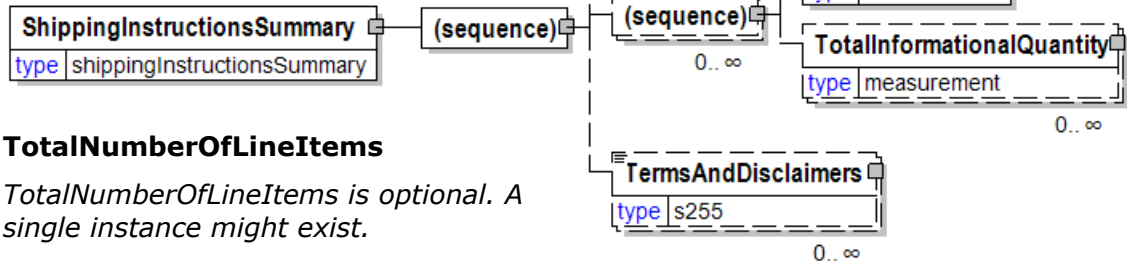

TotalNumberOfLineItems

TotalNumberOfLineItems is optional. A single instance might exist.

The total number of individual line items in the document, regardless of the status or type.

(sequence)

The sequence of items below is optional. Multiple instances might exist.

TotalQuantity

TotalQuantity is mandatory. A single instance is required.

The total quantity of similar items in the e-Document. TotalQuantity is primarily used in the summary section of documents where it is repeatable to permit totaling for different units of measure.

TotalInformationalQuantity

TotalInformationalQuantity is optional. Multiple instances might exist.

A quantity that is used to communicate related information about the parent element. This element represents a total that is derived from individual line items.

TermsAndDisclaimers

TermsAndDisclaimers is optional. Multiple instances might exist.

An element that contains legal information with an indication of what the Language is.

ShippingInstructionsType [attribute]

ShippingInstructionType defines the type of shipping instruction.

This item is restricted to the following list.



ShippingInstructionsConfirmation

Confirmation of the Shipping Instruction.

ShippingInstructionsDistribution

Shipping Instruction serves as a billable order for shipping product that was produced under a previous manufacturing order.

ShippingInstructionsPackaging

papiNet V2R31

To be deprecated in a future version V3R00. Guidance will be given to trading partners not to use this enumeration.

ShippingInstructionsRouting

Shipping instructions issued in conjunction with a PurchaseOrder for shipping the product.

ShippingMark

A shipping mark identifies the producer and quality on the end side of the product. Not to be mixed with company code/logo or other product marking.

ShippingMark
type s20

ShipToCharacteristics

A group item that provides information important for the Ship-To Party.

(sequence)

The sequence of items below is mandatory. A single instance is required.

ShipToParty

ShipToParty is mandatory. A single instance is required.

The name and/or address to which the goods should be delivered with the party type indicated by the PartyType attribute.

(choice)

[choice] is optional. A single instance might exist.

SupplyPoint

SupplyPoint is mandatory. One instance is required, multiple instances might exist.

Grouping element that contains items describing a supply point. A SupplyPoint belongs to a LocationParty, e.g. in a DeliveryOrigin or DeliveryDestination, and describes where goods are stored and can be loaded or unloaded. A SupplyPoint can for example be a loading or unloading gate at a warehouse or a road side landing at a logging area in the forest.

LocationCode

LocationCode is mandatory. A single instance is required.

A code used to identify a specific physical location within a site identified by a party, e.g. a loading station in a warehouse or an unloading station at a printer site.

LocationCode will be deprecated in a future version V3R00. Use SupplyPoint instead of LocationCode.

TermsOfDelivery

TermsOfDelivery is optional. A single instance might exist.

A group item defining the terms under which the delivery of goods will take place. These terms determine when and under what conditions the transfer of ownership

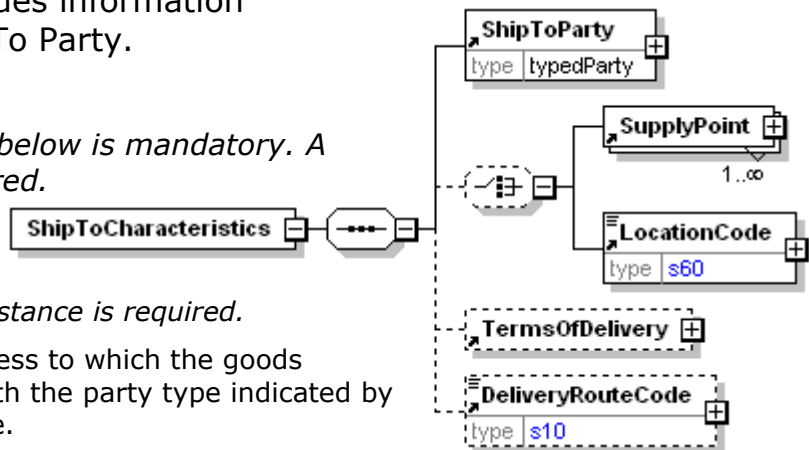

will occur. Generally speaking, the Incoterms are primarily used in Europe, whereas the ShipmentMethodOfPayment is primarily used in North America.

DeliveryRouteCode

DeliveryRouteCode is optional. A single instance might exist.

A code representing the delivery route as indicated by the Agency.

ShipToInformation

Group element containing information about the ship to and delivery of a product.

(sequence)

The sequence of items

below is mandatory. A single instance is required.

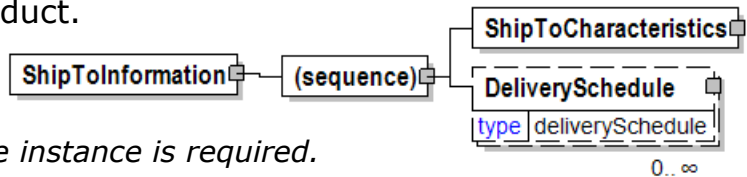

ShipToCharacteristics

ShipToCharacteristics is mandatory. A single instance is required.

A group item that provides information important for the Ship-To Party.

DeliverySchedule

DeliverySchedule is optional. Multiple instances might exist.

A group item defining a series of DeliveryDateWindow(s) in which specified quantities must be delivered.

ShipToParty

The name and/or address to which the goods should be delivered with the party type indicated by the PartyType attribute.

PartyType [attribute]

PartyType is mandatory. A single instance is required.

Identifies the business role associated with the particular party

Refer to PartyType definition for any enumerations.

LogisticsRole [attribute]

LogisticsRole is optional. A single instance might exist.

Communicates the nature of the logistics role, if any, the party plays in the transaction.

Refer to LogisticsRole definition for any enumerations.

(sequence)

The sequence of items below is mandatory. A single instance is required.

PartyIdentifier

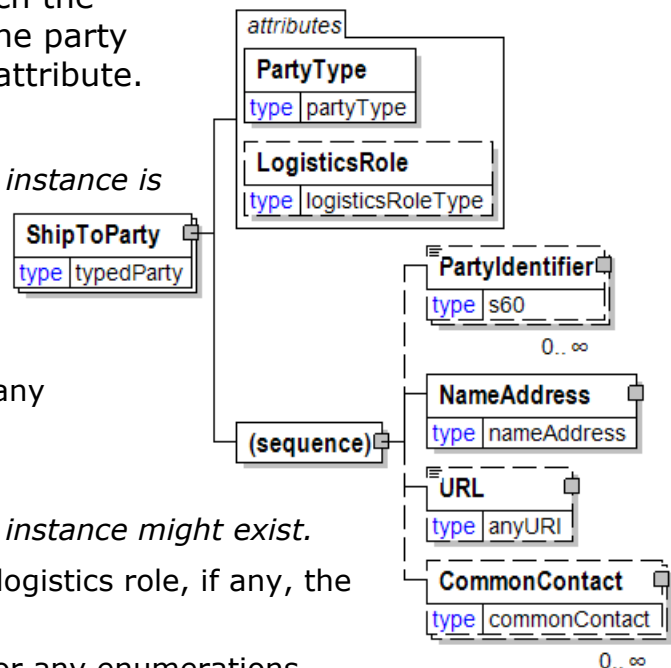

PartyIdentifier is optional. Multiple instances might exist.

A unique identifier of a specific party. This element contains an attribute PartyIdentifierType that indicates the type of the identifier.

NameAddress

NameAddress is mandatory. A single instance is required.

A group item containing name and address of an organisation or business entity.

URL

URL is optional. A single instance might exist.

Universal Resource Locator. While typically a web address you could use this field to hold an email address.

CommonContact

CommonContact is optional. Multiple instances might exist.

Identifies a specific individual associated with the party.

ShowThrough

Show through

TestMethod [attribute]

TestMethod is optional. A single instance might exist.

The method used to determine the results of the test under consideration.

TestAgency [attribute]

TestAgency is optional. A single instance might exist.

The agency that has set the parameters for the testing

Refer to TestAgency definition for any enumerations.

SampleType [attribute]

SampleType is optional. A single instance might exist.

Communicates how sampling was done to measure the product characteristics.

Refer to SampleType definition for any enumerations.

ResultSource [attribute]

ResultSource is optional. A single instance might exist.

Used to define the data source of the specified test

Refer to ResultSource definition for any enumerations.

(sequence)

The sequence of items below is mandatory. A single instance is required.

DetailValue

DetailValue is mandatory. A single instance is required.

A numeric value expressed in the unit of measure (UOM).

DetailRangeMin

DetailRangeMin is optional. A single instance might exist.

The minimum value (lower boundary) allowed for the DetailValue that is the parent of this element.

DetailRangeMax

DetailRangeMax is optional. A single instance might exist.

The maximum value (upper boundary) allowed for the DetailValue that is the

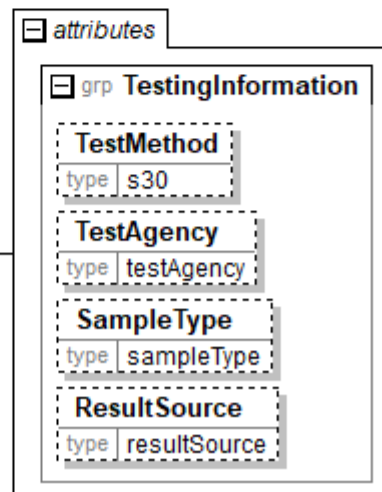
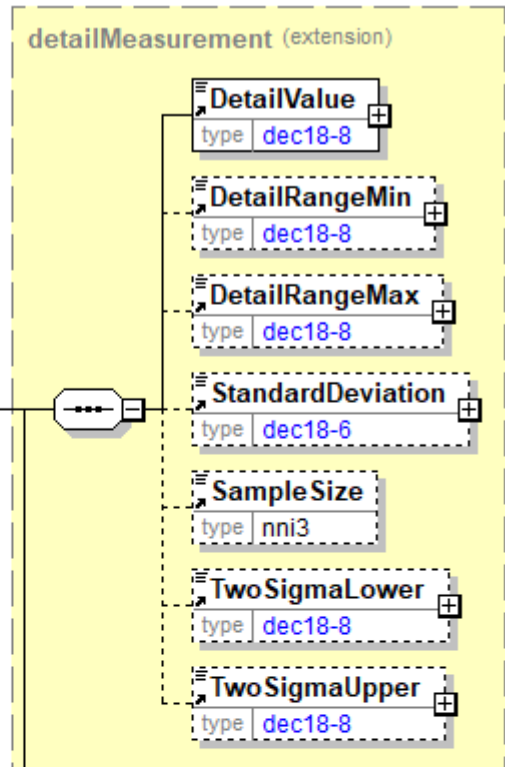
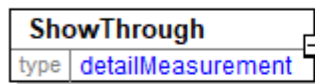

parent of this element.

StandardDeviation

StandardDeviation is optional. A single instance might exist.

A statistic used as a measure of dispersion in a distribution.

SampleSize

SampleSize is optional. A single instance might exist.

The number of samples used to determine the product characteristic in question.

TwoSigmaLower

TwoSigmaLower is optional. A single instance might exist.

Two sigma (a measure of dispersion associated with standard deviation) on the lower side of the standard deviation.

TwoSigmaUpper

TwoSigmaUpper is optional. A single instance might exist.

Two sigma (a measure of dispersion associated with standard deviation) on the upper side of the standard deviation.

Side

The structure defines the features of a panel's side. An attribute of side element indicates which side (either top or bottom) the child elements refer to.

TopSide [attribute]

TopSide is optional. A single instance might exist.

Either "Yes" or "No".

Refer to TopSide definition for any enumerations.

(sequence)

The sequence of items below is mandatory. A single instance is required.

Surface

Surface is optional. A single instance might exist.

PlywoodPlyGrade

PlywoodPlyGrade is optional. A single instance might exist.

Defines the grade of one ply, used with Agency to specify the grading agency.

Embossing

Embossing is optional. A single instance might exist.

Embossing requirements for sheets and reels. Embossing involves a physical deformation of the paper surface as part of the conversion process. Embossing is

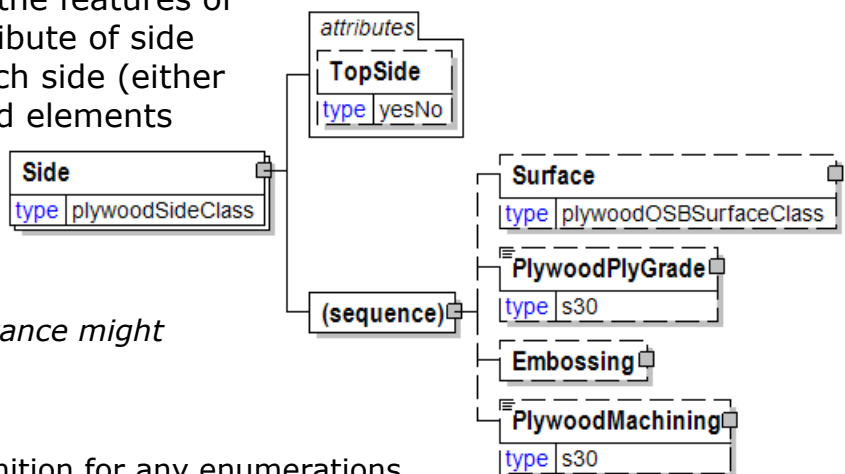

papiNet V2R31

applied either in-line (directly after the paper machine) or off-line. Refer to the attribute FinishType for additional information.

PlywoodMachining

PlywoodMachining is optional. A single instance might exist.

PlywoodMachining defines the machining made to the panel (for example, grooving).

SideOneTime

The time for side one.

SideOneTime
type duration

SideTwoTime

The time for side two.

SideTwoTime
type duration

SignatureID

Signature ID

SignatureID
type s30

Signatures

Signatures.

(sequence)

The sequence of items below is mandatory. A single instance is required.

PagesPerSignature

PagesPerSignature is mandatory. A single instance is required.

Pages per signature

NumberOfSignatures

NumberOfSignatures is mandatory. A single instance is required.

The number of signatures.

SignatureID

SignatureID is optional. A single instance might exist.

Signature ID

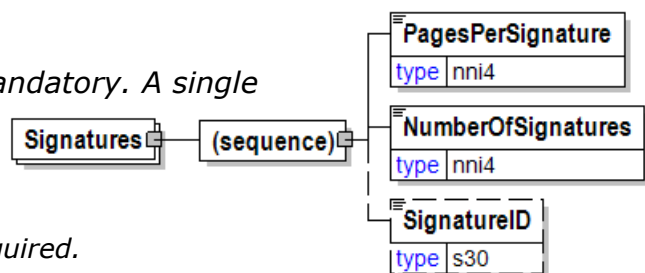

SingleWidthReel

Single width reel information.

(sequence)

The sequence of items below is mandatory. A single instance is required.

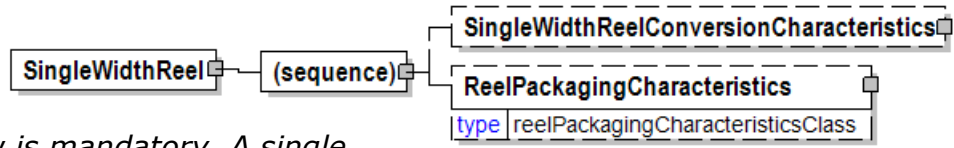

SingleWidthReelConversionCharacteristics

SingleWidthReelConversionCharacteristics is optional. A single instance might exist.
 The conversion characteristics associated with a single width reel.

ReelPackagingCharacteristics

ReelPackagingCharacteristics is optional. A single instance might exist.

A group item that lists the packaging elements describing how a reel should be packed.

SingleWidthReelConversionCharacteristics

The conversion characteristics associated with a single width reel.

(sequence)

The sequence of items below is mandatory. A single instance is required.

WindingDirection

WindingDirection is optional. A single instance might exist.

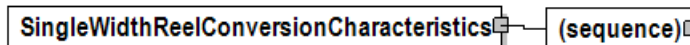

An element that indicates how the material is wound on the reel.

Refer to WindingDirection definition for any enumerations.

TrimmedOrderType

TrimmedOrderType is optional. A single instance might exist.

Trimmed Order Type

Refer to TrimmedOrderType definition for any enumerations.

ReelWidth

ReelWidth is optional. A single instance might exist.

The width of reel from edge to edge excluding packaging.

ReelDiameter

ReelDiameter is optional. A single instance might exist.

The diameter measurement of reel excluding packaging.

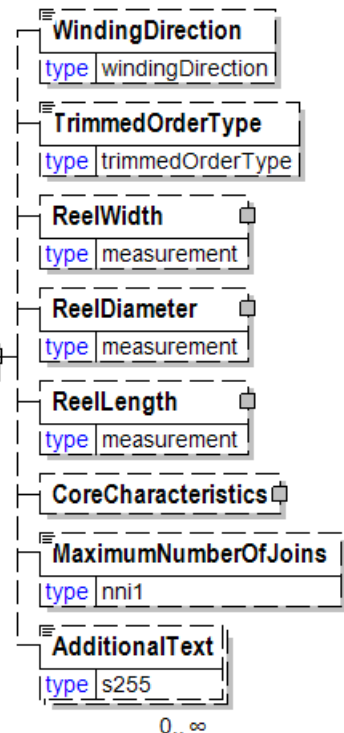

ReelLength

ReelLength is optional. A single instance might exist.

The total length of the paper on the reel.

CoreCharacteristics

CoreCharacteristics is optional. A single instance might exist.

A group item that details information used to fully define a core.

MaximumNumberOfJoins

MaximumNumberOfJoins is optional. A single instance might exist.

The maximum number of joins requested (permitted). Permits customers to indicate join-free reels.

AdditionalText

AdditionalText is optional. Multiple instances might exist.

A text field that is used to communicate information not previously defined or for special instructions. To be used only for circumstances not covered by specific elements.

SizeOfHolePunch

A definition of the size and shape of the punched holes.

ShapeOfHole [attribute]

ShapeOfHole is optional. A single instance might exist.

The shape of the hole

Refer to ShapeOfHole definition for any enumerations.

(sequence)

The sequence of items below is mandatory. A single instance is required.

Value

Value is mandatory. A single instance is required.

A numeric value expressed in the unit of measure (UOM).

RangeMin

RangeMin is optional. A single instance might exist.

The minimum value (lower boundary) allowed for the Measurement that is the parent of this element.

RangeMax

RangeMax is optional. A single instance might exist.

The maximum value (upper boundary) allowed for the Measurement that is the parent of this element. Some elements use the RangeMax element with an extended list of unit of measures. (Note: the red colour in the picture is an artifact of how the graphic was captured and should be disregarded.)

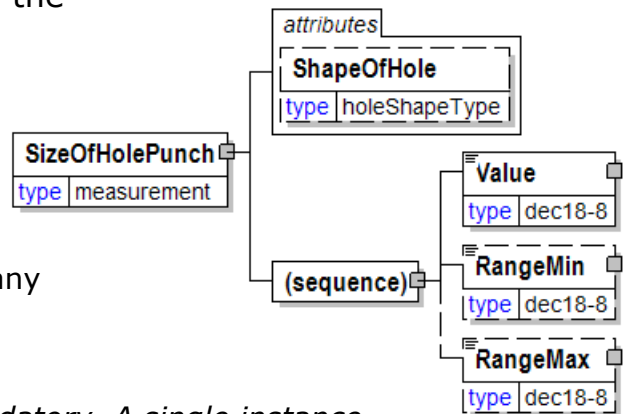

Sizing

A group item used to communicate size test of paper by ink resistance target or test value.

TestMethod [attribute]

TestMethod is optional. A single instance might exist.

The method used to determine the results of the test under consideration.

TestAgency [attribute]

TestAgency is optional. A single instance might exist.

The agency that has set the parameters for the testing

Refer to TestAgency definition for any enumerations.

SampleType [attribute]

SampleType is optional. A single instance might exist.

Communicates how sampling was done to measure the product characteristics.

Refer to SampleType definition for any enumerations.

ResultSource [attribute]

ResultSource is optional. A single instance might exist.

Used to define the data source of the specified test

Refer to ResultSource definition for any enumerations.

(sequence)

The sequence of items below is mandatory. A single instance is required.

DetailValue

DetailValue is mandatory. A single instance is required.

A numeric value expressed in the unit of measure (UOM).

DetailRangeMin

DetailRangeMin is optional. A single instance might exist.

The minimum value (lower boundary) allowed for the DetailValue that is the parent of this element.

DetailRangeMax

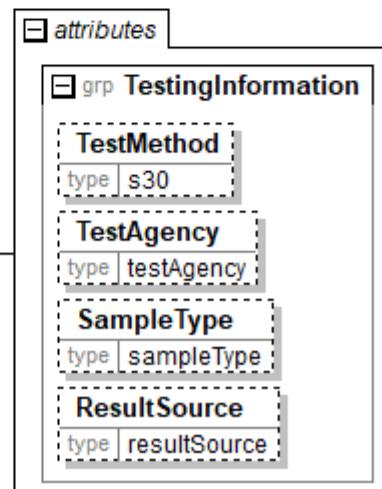
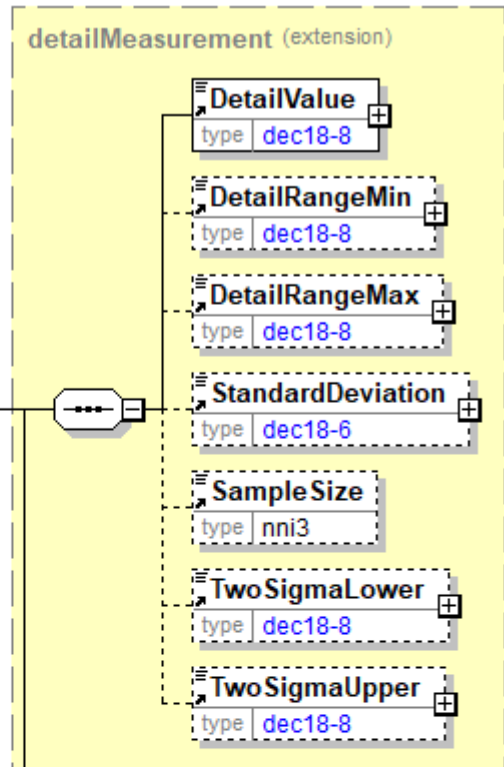

papiNet V2R31

DetailRangeMax is optional. A single instance might exist.

The maximum value (upper boundary) allowed for the DetailValue that is the parent of this element.

StandardDeviation

StandardDeviation is optional. A single instance might exist.

A statistic used as a measure of dispersion in a distribution.

SampleSize

SampleSize is optional. A single instance might exist.

The number of samples used to determine the product characteristic in question.

TwoSigmaLower

TwoSigmaLower is optional. A single instance might exist.

Two sigma (a measure of dispersion associated with standard deviation) on the lower side of the standard deviation.

TwoSigmaUpper

TwoSigmaUpper is optional. A single instance might exist.

Two sigma (a measure of dispersion associated with standard deviation) on the upper side of the standard deviation.

Sleeve

Sleeve.

SpineLabel [attribute]

SpineLabel is mandatory. A single instance is required.

The sleeve spine label.

(sequence)

The sequence of items below is mandatory. A single instance is required.

SleeveInsertType

SleeveInsertType is optional. A single instance might exist.

Sleeve insert type, examples are:

Sleeve insert type, examples are: bind-in sleeves that are actually bound-in with the pages of the booksleeves that adhere to the inside of the cover or a pagesleeves that are packaged/shrinkwrapped on the outside of the book This enumeration is currently a free-form string of characters.

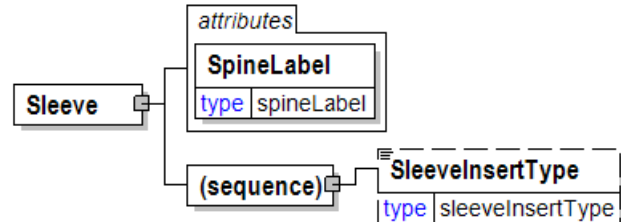

SleeveInsertType

Sleeve insert type, examples are:

Sleeve insert type, examples are: bind-in sleeves that are actually bound-in with the pages of the booksleeves that adhere to the inside of the cover or a pagesleeves that are packaged/shrinkwrapped on the outside of the book This enumeration is currently a free-form string of characters.

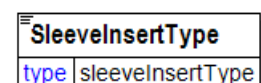

Slide

Slide

SlideMountNumbering [attribute]

SlideMountNumbering is optional. A single instance might exist.

Is the slide mount numbered.

Refer to SlideMountNumbering definition for any enumerations.

SlideMountCaptions [attribute]

SlideMountCaptions is optional. A single instance might exist.

Is the slide mount captioned?

Refer to SlideMountCaptions definition for any enumerations.

(sequence)

The sequence of items below is mandatory. A single instance is required.

SequenceNumber

SequenceNumber is optional. A single instance might exist.

A sequential number that uniquely identifies a sequence.

Width

Width is optional. A single instance might exist.

The width of the object.

Length

Length is optional. A single instance might exist.

The length of the object.

NumberOfColours

NumberOfColours is optional. A single instance might exist.

The number of colours

ColourSpecs

ColourSpecs is optional. A single instance might exist.

Colour specs

SlideMountDescription

SlideMountDescription is optional. A single instance might exist.

Slide mount description

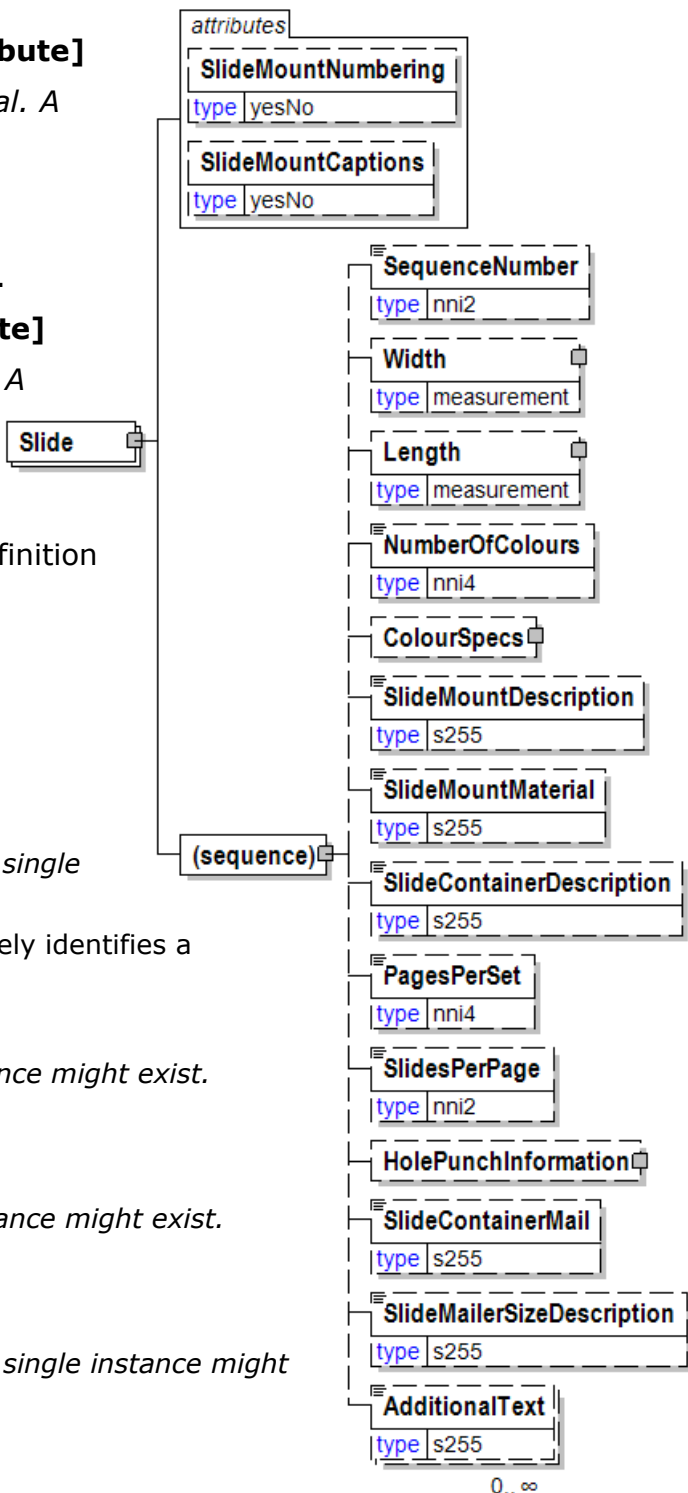

papiNet V2R31

SlideMountMaterial

SlideMountMaterial is optional. A single instance might exist.

Slide mount material

SlideContainerDescription

SlideContainerDescription is optional. A single instance might exist.

Slide container description

PagesPerSet

PagesPerSet is optional. A single instance might exist.

Pages per Set

SlidesPerPage

SlidesPerPage is optional. A single instance might exist.

Slides per page

HolePunchInformation

HolePunchInformation is optional. A single instance might exist.

Hole Punch Information.

SlideContainerMail

SlideContainerMail is optional. A single instance might exist.

Slide container for mail.

SlideMailerSizeDescription

SlideMailerSizeDescription is optional. A single instance might exist.

Slide mailer size description

AdditionalText

AdditionalText is optional. Multiple instances might exist.

A text field that is used to communicate information not previously defined or for special instructions. To be used only for circumstances not covered by specific elements.

SlideContainerDescription

Slide container description

SlideContainerDescription	
type	s255

SlideContainerMail

Slide container for mail.

SlideContainerMail	
type	s255

papiNet V2R31

SlideMailerSizeDescription

Slide mailer size description

SlideMailerSizeDescription	
type	s255

SlideMountCaptions [attribute]

Is the slide mount captioned?

This item is restricted to the following list.

Yes

No

attribute	
SlideMountCaptions	
type	yesNo

SlideMountDescription

Slide mount description

SlideMountDescription	
type	s255

SlideMountMaterial

Slide mount material

SlideMountMaterial	
type	s255

SlideMountNumbering [attribute]

Is the slide mount numbered.

This item is restricted to the following list.

Yes

No

attribute	
SlideMountNumbering	
type	yesNo

SlidesPerPage

Slides per page

SlidesPerPage	
type	nni2

SlitReel

The SlitReel element represents the elements associated with reel that has been slit into multiple reels.

(sequence)

The sequence of items below is mandatory. A single instance is required.

DeliveryIndicator

DeliveryIndicator is optional. A single instance might exist.

Indicates if delivery should take place or not.

Refer to DeliveryIndicator definition for any enumerations.

SlitReelLineNumber

SlitReelLineNumber is mandatory. A single instance is required.

The slit reel line number

SlitReelWidth

SlitReelWidth is mandatory. A single instance is required.

Slit Reel Width

(choice)

[choice] is mandatory. A single instance is required.

SlitReelOrderQuantity

SlitReelOrderQuantity is mandatory. A single instance is required.

Slit reel order quantity

SlitReelsInSet

SlitReelsInSet is mandatory. A single instance is required.

The number of slit reels in the set.

SlitReelReference

SlitReelReference is optional. Multiple instances might exist.

Communicates miscellaneous information about the slit reel.

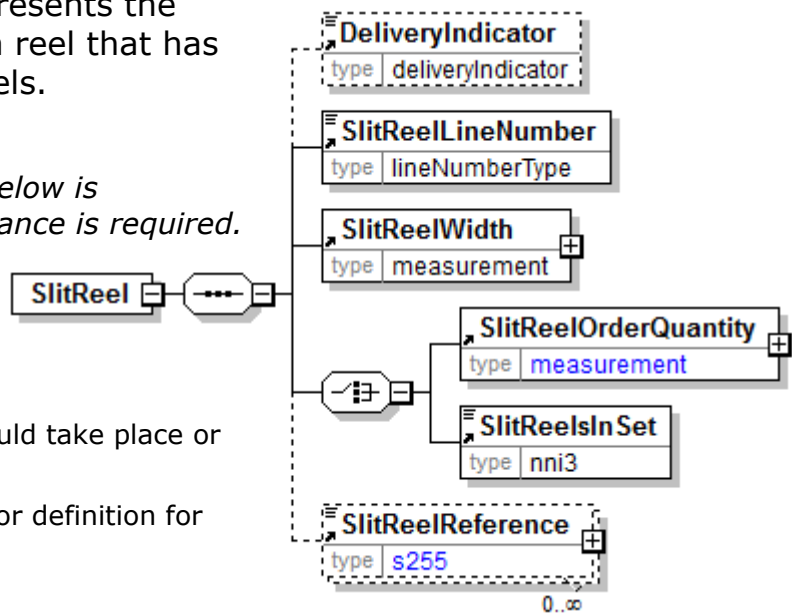

SlitReelLineNumber

The slit reel line number

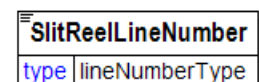

SlitReelOrderQuantity

Slit reel order quantity

QuantityType [attribute]

QuantityType is mandatory. A single instance is required.

QuantityType communicates information about the type of quantity being communicated and how the receiver might use the information.

Refer to QuantityType definition for any enumerations.

QuantityTypeContext [attribute]

QuantityTypeContext is optional. A single instance might exist.

Provides the location in the value chain where the quantity is being reported.

Refer to QuantityTypeContext definition for any enumerations.

AdjustmentType [attribute]

AdjustmentType is optional. A single instance might exist.

Describes the type of adjustment associated with a quantity.

Refer to AdjustmentType definition for any enumerations.

(sequence)

The sequence of items below is mandatory. A single instance is required.

Value

Value is mandatory. A single instance is required.

A numeric value expressed in the unit of measure (UOM).

RangeMin

RangeMin is optional. A single instance might exist.

The minimum value (lower boundary) allowed for the Measurement that is the parent of this element.

RangeMax

RangeMax is optional. A single instance might exist.

The maximum value (upper boundary) allowed for the Measurement that is the parent of this element. Some elements use the RangeMax element with an extended list of unit of measures. (Note: the red colour in the picture is an artifact of how the graphic was captured and should be disregarded.)

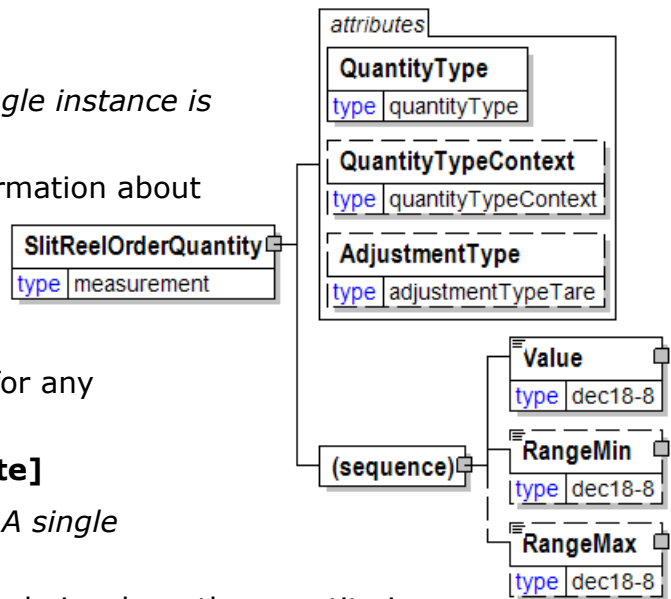

SlitReelReference

Communicates miscellaneous information about the slit reel.

SlitReelReferenceType [attribute]

SlitReelReferenceType is mandatory. A single instance is required.

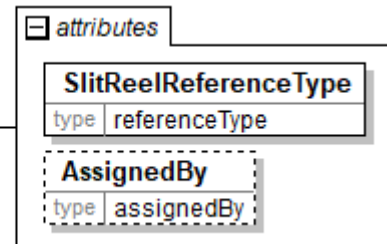
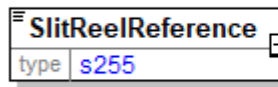

Provides a contextual explanation of the specific reference identifier. Many items are currently prefixed by "Buyer", "Forwarder", "Manufacturer", "Mill", "Seller", "Supplier", "Warehouse", or "Vendor". Check for an existing non-prefixed version and use the non-prefixed version instead. In the (yet to be announced release date) version 3.0 the prefixed versions will be removed. Instead the attribute @AssignedBy will communicate the information previously communicated in the prefix.

Refer to SlitReelReferenceType definition for any enumerations.

AssignedBy [attribute]

AssignedBy is optional. A single instance might exist.

Identifies the type of party or the agency that has assigned the associated item, e.g. a reference of type OrderNumber.

Refer to AssignedBy for any enumerations.

SlitReelReferenceType [attribute]

Provides a contextual explanation of the specific reference identifier. Many items are currently prefixed by "Buyer", "Forwarder", "Manufacturer", "Mill", "Seller", "Supplier", "Warehouse", or "Vendor". Check for an existing non-prefixed version and use the non-prefixed version instead. In the (yet to be announced release date) version 3.0 the prefixed versions will be removed. Instead the attribute @AssignedBy will communicate the information previously communicated in the prefix.

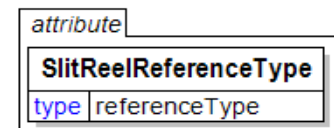

Refer to the [referenceType](#) entry for the list of enumerations and their definitions.

SlitReelsInSet

The number of slit reels in the set.



SlitReelWidth

Slit Reel Width

(sequence)

The sequence of items below is mandatory. A single instance is required.

Value

Value is mandatory. A single instance is required.

A numeric value expressed in the unit of measure (UOM).

RangeMin

RangeMin is optional. A single instance might exist.

The minimum value (lower boundary) allowed for the Measurement that is the parent of this element.

RangeMax

RangeMax is optional. A single instance might exist.

The maximum value (upper boundary) allowed for the Measurement that is the parent of this element. Some elements use the RangeMax element with an extended list of unit of measures. (Note: the red colour in the picture is an artifact of how the graphic was captured and should be disregarded.)

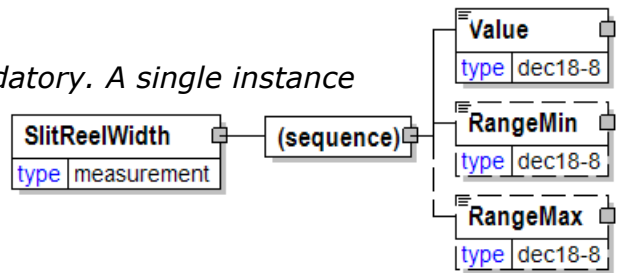

Slurry

Product that has moisture content high enough to prevent formation of a sheet, and which can be delivered in liquid form.

Examples:

Product that has moisture content high enough to prevent formation of a sheet, and which can be delivered in liquid form. Examples: Noodle pulp, is pumped into trucks as thick slurry, and then pumped directly into the hydropulper. It has the higher strength properties of never dried pulp.

Product that has moisture content high enough to prevent formation of a sheet, and which can be delivered in liquid form. Examples: Noodle pulp, is pumped into trucks as thick slurry, and then pumped directly into the hydropulper. It has the higher strength properties of never dried pulp. Liquid pulp, never dried pulp, often pumped directly, using a flow meter to measure the moisture and fibre content. Sold by weight of the fibre.

(sequence)

The sequence of items below is mandatory. A single instance is required.

TargetSolidsContent

TargetSolidsContent is mandatory. A single instance is required.

The target amount of solids for the slurry being produced.

AdditionalText

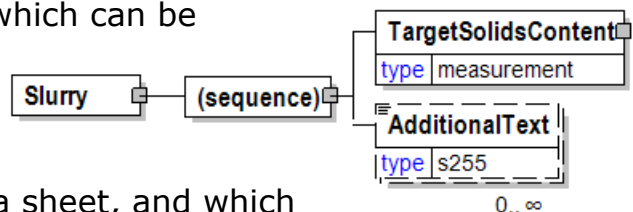

AdditionalText is optional. Multiple instances might exist.

A text field that is used to communicate information not previously defined or for special instructions. To be used only for circumstances not covered by specific elements.

SmallEndDiameter

Reports the log crown end diameter as a measurement.

(sequence)

The sequence of items below is mandatory. A single instance is required.

Value

Value is mandatory. A single instance is required.

A numeric value expressed in the unit of measure (UOM).

RangeMin

RangeMin is optional. A single instance might exist.

The minimum value (lower boundary) allowed for the Measurement that is the parent of this element.

RangeMax

RangeMax is optional. A single instance might exist.

The maximum value (upper boundary) allowed for the Measurement that is the parent of this element. Some elements use the RangeMax element with an extended list of unit of measures. (Note: the red colour in the picture is an artifact of how the graphic was captured and should be disregarded.)

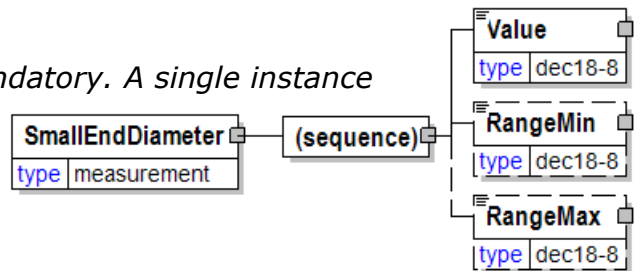

Smoothness

A group item used to communicate surface smoothness target or test value according to a particular TestMethod.

TestMethod [attribute]

TestMethod is optional. A single instance might exist.

The method used to determine the results of the test under consideration.

TestAgency [attribute]

TestAgency is optional. A single instance might exist.

The agency that has set the parameters for the testing

Refer to TestAgency definition for any enumerations.

SampleType [attribute]

SampleType is optional. A single instance might exist.

Communicates how sampling was done to measure the product characteristics.

Refer to SampleType definition for any enumerations.

ResultSource [attribute]

ResultSource is optional. A single instance might exist.

Used to define the data source of the specified test

Refer to ResultSource definition for any enumerations.

(sequence)

The sequence of items below is mandatory. A single instance is required.

DetailValue

DetailValue is mandatory. A single instance is required.

A numeric value expressed in the unit of measure (UOM).

DetailRangeMin

DetailRangeMin is optional. A single instance might exist.

The minimum value (lower boundary) allowed for the DetailValue that is the parent of this element.

DetailRangeMax

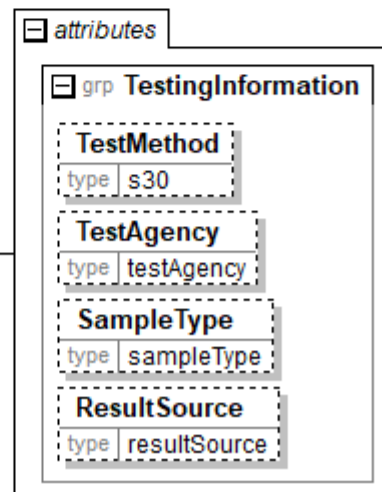
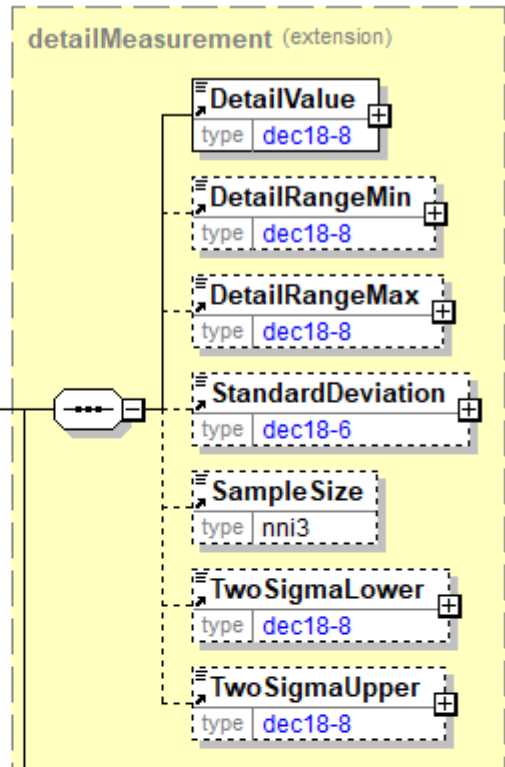

papiNet V2R31

DetailRangeMax is optional. A single instance might exist.

The maximum value (upper boundary) allowed for the DetailValue that is the parent of this element.

StandardDeviation

StandardDeviation is optional. A single instance might exist.

A statistic used as a measure of dispersion in a distribution.

SampleSize

SampleSize is optional. A single instance might exist.

The number of samples used to determine the product characteristic in question.

TwoSigmaLower

TwoSigmaLower is optional. A single instance might exist.

Two sigma (a measure of dispersion associated with standard deviation) on the lower side of the standard deviation.

TwoSigmaUpper

TwoSigmaUpper is optional. A single instance might exist.

Two sigma (a measure of dispersion associated with standard deviation) on the upper side of the standard deviation.

SoftwoodLumber

Product structure for solid wood products made of softwood

(sequence)

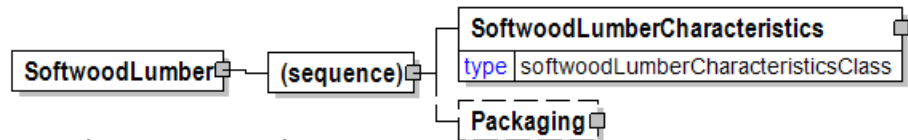

The sequence of items below is mandatory. A single instance is required.

SoftwoodLumberCharacteristics

SoftwoodLumberCharacteristics is mandatory. A single instance is required.

A group item that organises the softwood lumber –product information.

Packaging

Packaging is optional. A single instance might exist.

Type of a package that includes individual products.

SoftwoodLumberCharacteristics

A group item that organises the softwood lumber – product information.

(sequence)

The sequence of items below is mandatory. A single instance is required.

LumberSpecies

LumberSpecies is mandatory. One instance is required, multiple instances might exist.

Specifies the raw material species.

LumberGrade

LumberGrade is mandatory. A single instance is required.

Defines quality characteristics achieved by selecting pieces based on a grading rule.

Length

Length is optional.

The length of the object.

Width

Width is optional.

The width of the object.

Thickness

Thickness is optional.

Physical dimension of a product. The approach for thickness used in the timber/lumber related constructs.

Seasoning

Seasoning is optional. A single instance might exist.

Describes drying/ moisture control method.

MoistureContent

MoistureContent is optional. A single instance might exist.

Defines the moisture content percentage of the product.

HeatTreatment

HeatTreatment is optional. A single instance might exist.

Defines the heat treatment method.

ManufacturingProcess

ManufacturingProcess is optional. Multiple instances might exist.

Defines the different machining and processes made for the product.

PatternProfile

PatternProfile is optional. A single instance might exist.

Defines the pattern used in machining the product.

Trim



Trim is optional. A single instance might exist.

Trim

Joining

Joining is optional. A single instance might exist.

Defines the method used to join pieces of wood.

PressureTreatment

PressureTreatment is optional. A single instance might exist.

Method and parameter values of pressure treatment.

FireTreatment

FireTreatment is optional. A single instance might exist.

Fire treatment

OtherTreatment

OtherTreatment is optional. A single instance might exist.

Other treatment

GradeStamp

GradeStamp is optional. A single instance might exist.

Grade stamp information

ExLog

ExLog is optional. A single instance might exist.

Describes the cutting pattern of the log.

ClassIdentifier

ClassIdentifier is optional. Multiple instances might exist.

Standard used for product identification.

Weight

Weight is optional. A single instance might exist.

The weight of the item.

LabelCharacteristics

LabelCharacteristics is optional. A single instance might exist.

A group item that organises the labeling information.

StencilCharacteristics

StencilCharacteristics is optional. A single instance might exist.

A group element specifying attributes of a stencil to be applied to an item, and optional text.

Wrap

Wrap is optional. A single instance might exist.

A group item that organises wrapping detail information.

SafetyAndEnvironmentalInformation

SafetyAndEnvironmentalInformation is optional. Multiple instances might exist.

Name of certification type, if any, on the goods (For example, FSC, PEFC).
SafetyAndEnvironmental needs a value or measurement to communicate the

papiNet V2R31

percentage of the product is certified (for example, 75% is certified by the indicated agency).

AdditionalText

AdditionalText is optional. Multiple instances might exist.

A text field that is used to communicate information not previously defined or for special instructions. To be used only for circumstances not covered by specific elements.

LengthCutDescription

LengthCutDescription is optional. A single instance might exist.

Length Cut Description

ShippingMark

ShippingMark is optional. A single instance might exist.

A shipping mark identifies the producer and quality on the end side of the product. Not to be mixed with company code/logo or other product marking.

Edge

Edge is optional. A single instance might exist.

Describes the finishing of the edge of the board.

PressureTreatment

PressureTreatment is optional. A single instance might exist.

Method and parameter values of pressure treatment.

FireTreatment

FireTreatment is optional. A single instance might exist.

Fire treatment

Supplemental

Supplemental is optional. Multiple instances might exist.

Supplemental

Brand

Brand is optional. A single instance might exist.

Specifies a trade name for an item. E.g. the brand name of a transport vehicle, the brand name of a material etc.

GradeAgency

GradeAgency is optional. A single instance might exist.

North American structural panel grading agencies. Defines the governing organisation of the grading scheme employed.

Note: There is a GradeAgency attribute, as well.

Refer to GradeAgency definition for any enumerations.

GradeStamp

GradeStamp is optional. A single instance might exist.

Grade stamp information

ClassIdentifier

ClassIdentifier is optional. A single instance might exist.

Standard used for product identification.

LabelCharacteristics

LabelCharacteristics is optional. Multiple instances might exist.

A group item that organises the labeling information.

StencilCharacteristics

StencilCharacteristics is optional. Multiple instances might exist.

A group element specifying attributes of a stencil to be applied to an item, and optional text.

SafetyAndEnvironmentalInformation

SafetyAndEnvironmentalInformation is optional. Multiple instances might exist.

Name of certification type, if any, on the goods (For example, FSC, PEFC). SafetyAndEnvironmental needs a value or measurement to communicate the percentage of the product is certified (for example, 75% is certified by the indicated agency).

SourceProduct

SourceProduct is a group element defining the product that is available for measuring.

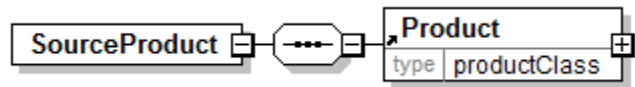

The measuring of this product is done according to the measuring rules for the contracted product, which usually is the same product. But in some cases the product available for measuring is different from the contracted product. In these cases, the product available for measuring shall be measured according to the measuring rules for the MeasuringProduct specified in MeasuringSpecification.

For example, Pulpwood is produced but it is of very bad quality because of long time storage in the forest. This pulpwood will be sold as fire wood and shall when delivered be measured according to the measuring rules for firewood.

(sequence)

The sequence of items below is mandatory. A single instance is required.

Product

Product is mandatory. A single instance is required.

Product is a group item defining the article and its characteristics. Product is used to specify product characteristics organized by ProductIdentifier, ProductDescription, and Classification. Book Manufacturing, Forest Wood, Label Stock, Paper, Pulp, Recovered Paper, Wood Products, and Virgin Fibre market segments have defined their product characteristics and conversion features for implementation in papiNet.

SpanRating

Span Rating according to NIST standards and indicated on grade stamp.

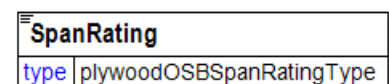

This item is restricted to the following list.

- 16oc**
- 20oc**
- 24oc**
- 32oc**
- 48oc**
- 20/0**
- 24/0**
- 24/16**
- 32/16**
- 40/20**
- 48/24**

54/32

60/32

60/48

SpecAssembly

SpecAssembly contains assemblies that are used in the manufacturing of books.

SpecAssemblyType [attribute]

SpecAssemblyType is optional. A single instance might exist.

Indicator that identifies the part of the book product for which the assembly information is being specified.

Refer to SpecAssemblyType definition for any enumerations

(sequence)

The sequence of items below is mandatory. A single instance is required.

ProductIdentifier

ProductIdentifier is mandatory. A single instance is required.

Used to communicate the code of the article, in a variety of formats designated by the type.

ProductDescription

ProductDescription is optional. Multiple instances might exist.

An element used to communicate a human readable description of the product in the language specified by the Language attribute.

BillOfMaterials

BillOfMaterials is optional. A single instance might exist.

A specification of the components and other items that are used to produced the item in question.

Height

Height is optional. A single instance might exist.

The height of the object.

Length

Length is optional. A single instance might exist.

The length of the object.

Width

Width is optional. A single instance might exist.

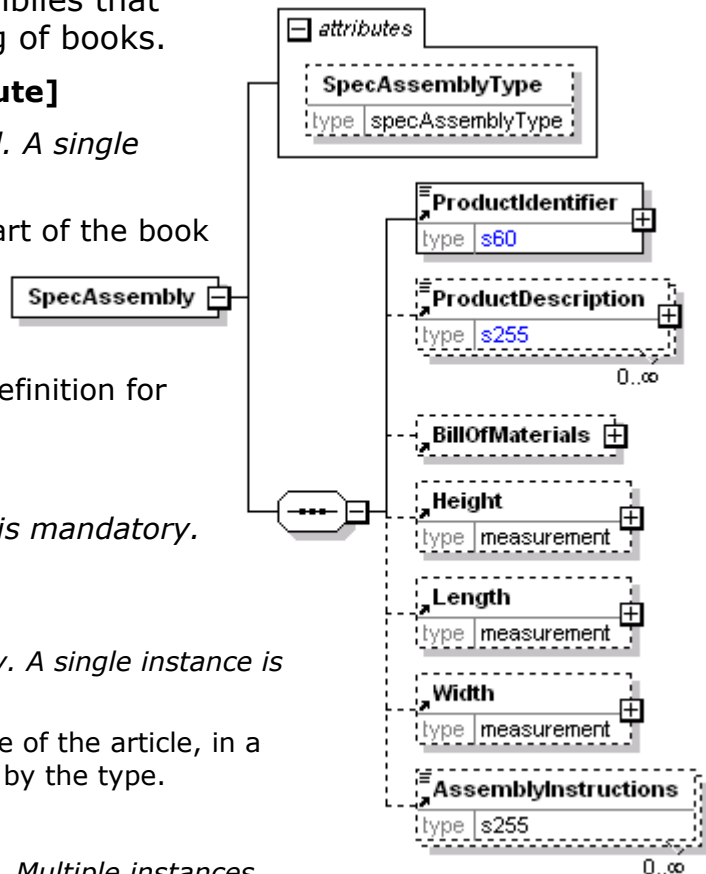

The width of the object.

AssemblyInstructions

AssemblyInstructions is optional. Multiple instances might exist.

Instructions for assembly.

SpecAssemblyType [attribute]

Indicator that identifies the part of the book product for which the assembly information is being specified.

This item is restricted to the following list.

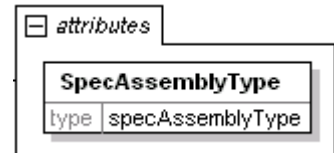

Component

Part or section of the book product.

FinishedGoods

Goods that have completed the manufacturing process but have not yet been sold or distributed to the end user.

SpecBinding

SpecBinding describes the binding process.

BindingType [attribute]

BindingType is optional. A single instance might exist.

Identifies the primary binding category of the book.

Refer to BindingType definition for any enumerations.

BindingStyleType [attribute]

BindingStyleType is optional. A single instance might exist.

Indicates the style of binding used.

Refer to BindingStyleType definition for any enumerations.

BindingCoverScoring [attribute]

BindingCoverScoring is optional. A single instance might exist.

Indicates if scoring of the front cover close to the spine allowing the cover to easily stay open is required.

Refer to BindingCoverScoring definition for any enumerations.

BindingReinforcement [attribute]

BindingReinforcement is optional. A single instance might exist.

Specifies if spine reinforcement materials are included in the binding operation.

Refer to BindingReinforcement definition for any enumerations.

BindingBackStyleType [attribute]

BindingBackStyleType is optional. A single instance might exist.

Specifies that the book cover is either attached or detached from the spine.

Refer to BindingBackStyleType definition for any enumerations.

BindingRibbon [attribute]

BindingRibbon is optional. A single instance might exist.

Specifies if a ribbon (bookmark) is to be included in the binding.

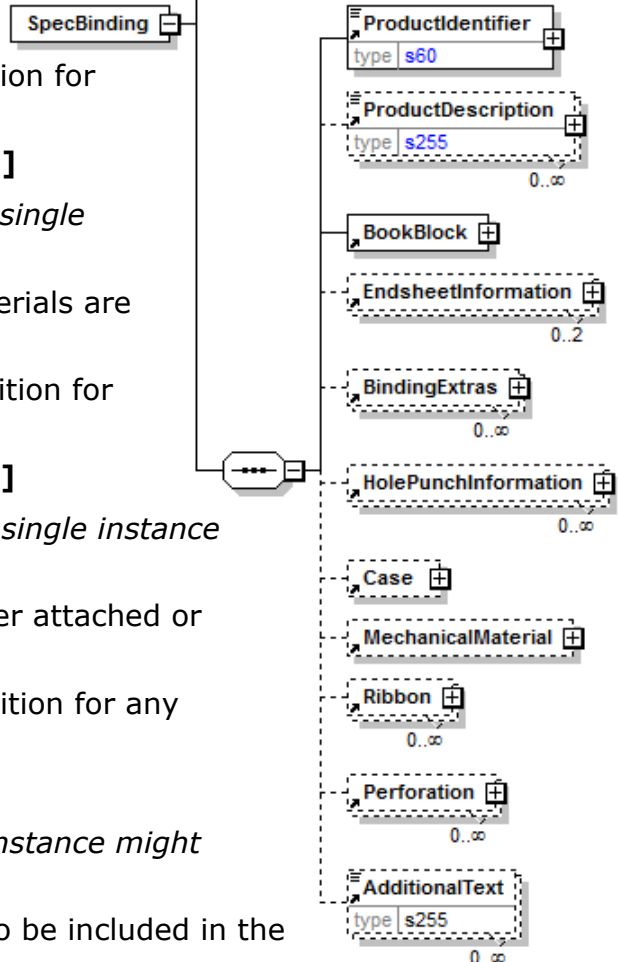
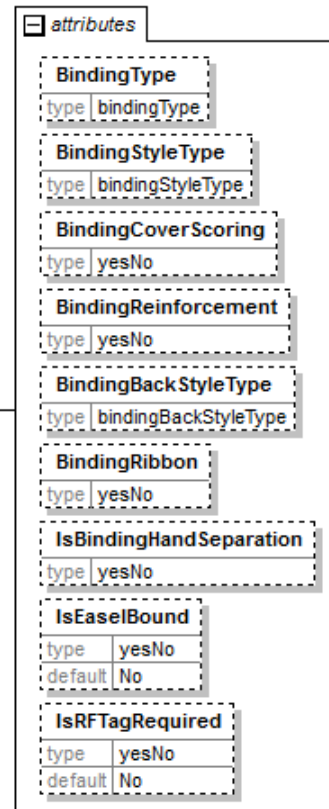

Refer to BindingRibbon definition for any enumerations.

IsBindingHandSeparation [attribute]

IsBindingHandSeparation is optional. A single instance might exist.

Indicates if there is hand separation required or not for books with odd page counts.

Refer to IsBindingHandSeparation definition for any enumerations.

IsEaselBound [attribute]

IsEaselBound is optional. A single instance might exist.

Specifies if the binding is at the top of the pages or not rather than on the side which changes the pagination of the pages.

Refer to IsEaselBound definition for any enumerations.

IsRFTagRequired [attribute]

IsRFTagRequired is optional. A single instance might exist.

Indicates that RFTag application is required in the manufacturing and carton packaging processes.

Refer to IsRFTagRequired definition for any enumerations.

(sequence)

The sequence of items below is mandatory. A single instance is required.

ProductIdentifier

ProductIdentifier is mandatory. A single instance is required.

Used to communicate the code of the article, in a variety of formats designated by the type.

ProductDescription

ProductDescription is optional. Multiple instances might exist.

An element used to communicate a human readable description of the product in the language specified by the Language attribute.

BookBlock

BookBlock is mandatory. A single instance is required.

The text block plus the endpapers and other materials added by the binder before cover is applied.

EndsheetInformation

EndsheetInformation is optional.

End sheet information.

BindingExtras

BindingExtras is optional. Multiple instances might exist.

Binding extras

HolePunchInformation

HolePunchInformation is optional and repeatable. Multiple instances might exist.

Hole Punch Information.

Case

papiNet V2R31

Case is optional. A single instance might exist.

Case information

MechanicalMaterial

MechanicalMaterial is optional. A single instance might exist.

Mechanical material information

Ribbon

Ribbon is optional. Multiple instances might exist.

Ribbon information.

Perforation

Perforation is optional and repeatable. Multiple instances might exist.

Perforation information.

AdditionalText

AdditionalText is optional. Multiple instances might exist.

A text field that is used to communicate information not previously defined or for special instructions. To be used only for circumstances not covered by specific elements.

SpecComponent

Group element used to identify all the necessary component information for this BookSpecification.

Each occurrence of this construct identifies a single component.

(sequence)

The sequence of items below is mandatory. A single instance is required.

ProductIdentifier

ProductIdentifier is mandatory. A single instance is required.

Used to communicate the code of the article, in a variety of formats designated by the type.

ProductDescription

ProductDescription is optional. Multiple instances might exist.

An element used to communicate a human readable description of the product in the language specified by the Language attribute.

(sequence)

The sequence of items below is mandatory. One instance is required, multiple instances might exist.

Classification

Classification is mandatory. A single instance is required.

A group item that details the product classification according to a particular organization's scheme. An item across multiple classifications would still be recognized as the same item. Examples of some product classifications are: Containerboard, Pulp-Dissolving, or Newsprint.

SubClassification

SubClassification is optional. Multiple instances might exist.

SubClassification provides additional classification information.

BookClassification

BookClassification is optional. Multiple instances might exist.

Category under which the product or a component within the product is classified.

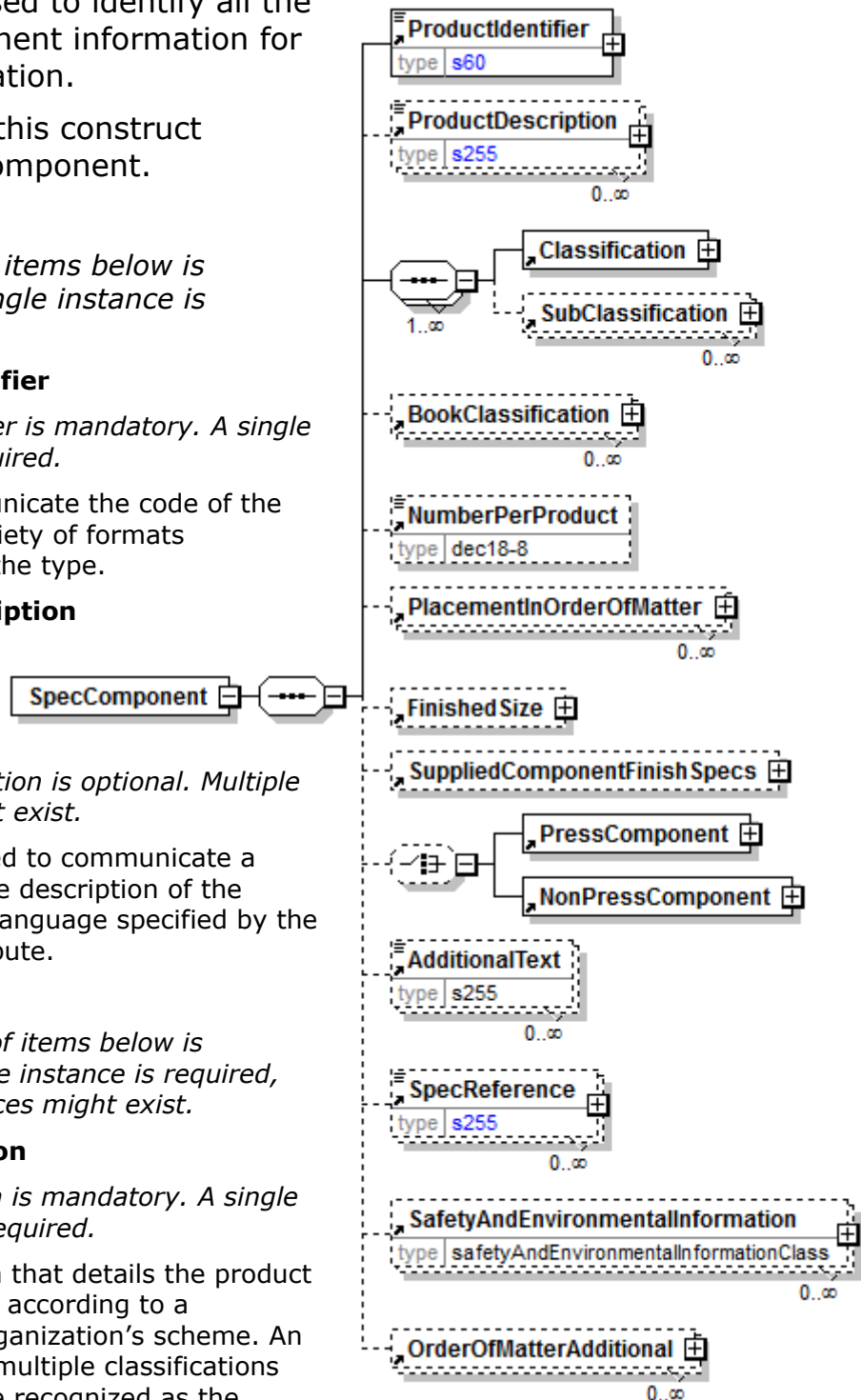

NumberPerProduct

NumberPerProduct is optional. A single instance might exist.

The number of components or items per assembly or constructed product

PlacementInOrderOfMatter

PlacementInOrderOfMatter is optional. Multiple instances might exist.

Element used to identify where the component is to be placed amongst other components when assembling a book.

FinishedSize

FinishedSize is optional. A single instance might exist.

Finished size

SuppliedComponentFinishSpecs

SuppliedComponentFinishSpecs is optional. A single instance might exist.

Supplied Component Finish Specs

(choice)

[choice] is optional. A single instance might exist.

PressComponent

PressComponent is mandatory. A single instance is required.

Press Component.

NonPressComponent

NonPressComponent is mandatory. A single instance is required.

Non-press component.

AdditionalText

AdditionalText is optional. Multiple instances might exist.

A text field that is used to communicate information not previously defined or for special instructions. To be used only for circumstances not covered by specific elements.

SpecReference

SpecReference is optional. Multiple instances might exist.

Used to identify any external or associated documents, identifiers, etc.

SafetyAndEnvironmentalInformation

SafetyAndEnvironmentalInformation is optional. Multiple instances might exist.

Name of certification type, if any, on the goods (For example, FSC, PEFC). SafetyAndEnvironmental needs a value or measurement to communicate the percentage of the product is certified (for example, 75% is certified by the indicated agency).

OrderOfMatterAdditional

OrderOfMatterAdditional is optional. Multiple instances might exist.

Group element used to identify all the information for the additional manufacturing requirements.

SpecGeneral

Spec General

(sequence)

The sequence of items below is mandatory. A single instance is required.

SpecInformation

SpecInformation is mandatory. A single instance is required.

Construct is used to uniquely identify this BookSpecification.

Note: ProductIdentifier, ProductDescription, and Classification removed in Version V2R30 and replaced with SpecificationNumber to more accurately reflect the business process.

TransactionHistoryNumber

TransactionHistoryNumber is optional. A single instance might exist.

A sequential number that keeps track of the version of a document.

However when the document is a confirmation document, in which case the TransactionHistoryNumber refers to the trigger transaction for the confirmation.

SenderParty

SenderParty is optional. A single instance might exist.

The business entity issuing the e-Document, the source of the document.

The entity responsible for the content. If the sender party has outsourced the message service to a third party the SenderParty is the issuer of the e-Document and not the party performing the transmission service of the electronic message.

ReceiverParty

ReceiverParty is optional. Multiple instances might exist.

The business entity for whom the e-Document is intended, the destination of the document.

The entity interested in the content. If the receiver party has outsourced the message service to a third party the ReceiverParty is the intended party for the e-Document and not the party performing the receiving service of the electronic message.

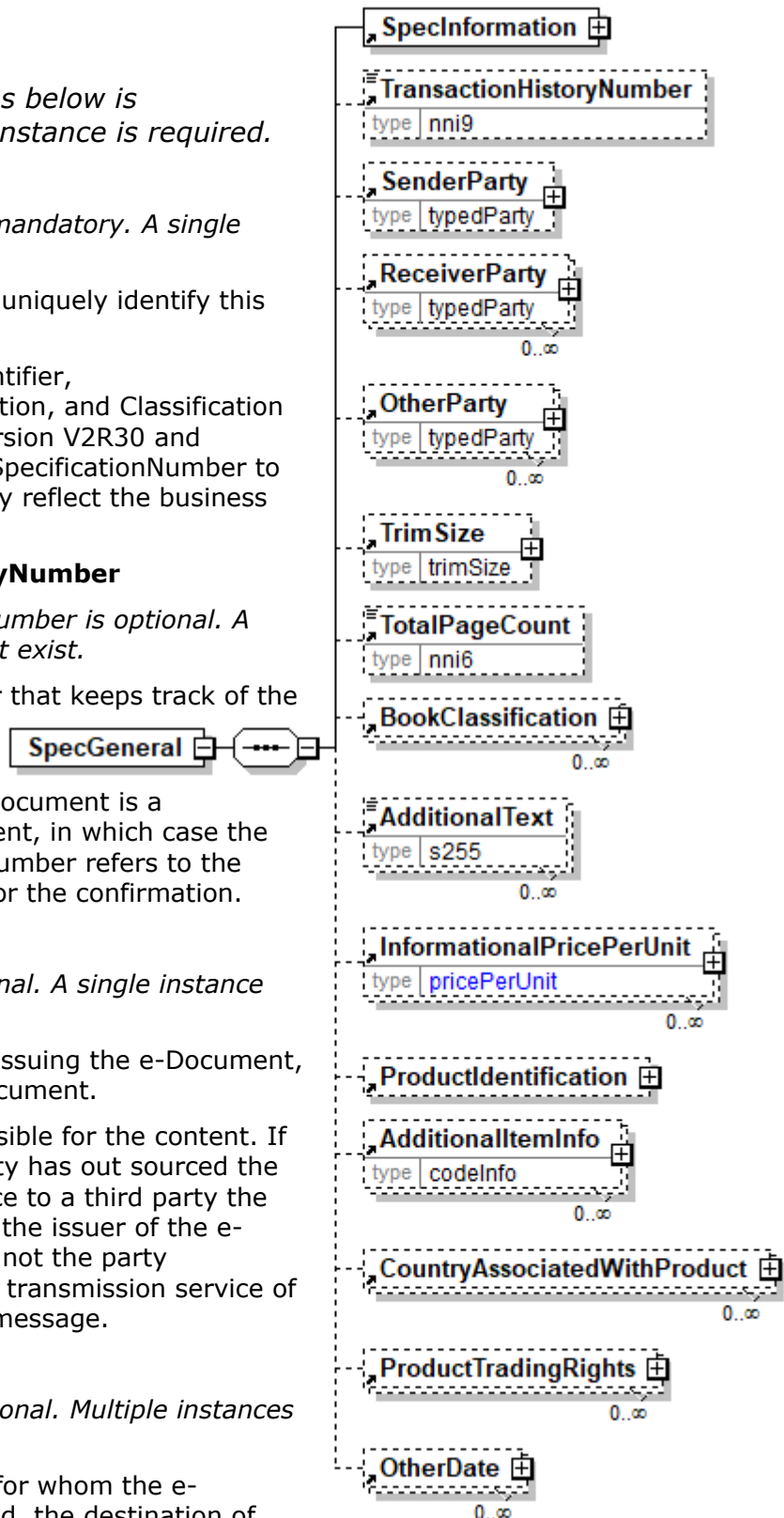

OtherParty

OtherParty is optional. Multiple instances might exist.

An organisation or business entity other than those specifically detailed within an e-Document.

TrimSize

TrimSize is optional. A single instance might exist.

Trim size.

TotalPageCount

TotalPageCount is optional. A single instance might exist.

Element used to communicate the book's approximate total number of pages within each unit of the book. Total page count is more or less a reference to the "size" of the book that the customer designates. For instance, they will refer to a book as 800 pages when in fact it is 792 actual text pages with 8 pages of various inserts. This value should not be used to drive any of the other values for the component parts, but may in fact be exactly equal to the number of pages in one of the components designated as "Text".

BookClassification

BookClassification is optional. Multiple instances might exist.

Category under which the product or a component within the product is classified.

AdditionalText

AdditionalText is optional. Multiple instances might exist.

A text field that is used to communicate information not previously defined or for special instructions. To be used only for circumstances not covered by specific elements.

InformationalPricePerUnit

InformationalPricePerUnit is optional. Multiple instances might exist.

A group item containing a currency value and a measurement value used convey a secondary PricePerUnit. For example, where PricePerUnit is dollars per ton. InformationalPricePerUnit could be dollars per kilogram.

ProductIdentification

ProductIdentification is optional. A single instance might exist.

A grouping element designed to communicate product identification related to the parent element that contains this item.

AdditionalItemInfo

AdditionalItemInfo is optional. Multiple instances might exist.

A grouping element that contains information about additional items specified by an agency. Restricted use of this element is recommended.

CountryAssociatedWithProduct

CountryAssociatedWithProduct is optional. Multiple instances might exist.

Specifies the country associated with the product.

ProductTradingRights

ProductTradingRights is optional. Multiple instances might exist.

Identifies a country to which products can or cannot be sold or distributed.

OtherDate

OtherDate is optional. Multiple instances might exist.

A date that may not be specifically detailed within a document (example: print date at the PurchaseOrderLineItem).

SpecGroupingID

A value that will relate/link specifications together. For example, items that are usually manufactured with common components.

SpecGroupingID	
type	s60

SpeciesAgency [attribute]

Defines the governing organisation of the scheme employed in determining the species of the product.

This item is restricted to the following list.

ISO

International Organisation for Standardization.

prEN TC(1113-1)

Supplier

Supplier determined scheme.

attribute	SpeciesAgency	
type	lumberSpeciesAgencyType	

SpeciesCode

Species Code

SpeciesCode	
type	s30

SpeciesOrigin [attribute]

The country of origin of the species employed in manufacture of the product.

This item is restricted to the following list.

Africa

America

Austria

Bavaria

Brasil

Canada

Estonia

European

attribute	SpeciesOrigin	
type	lumberSpeciesOriginType	

Finland
French
Germany
Indian
Latvia
Lithuania
Norway
Russia
Sweden
North
South
Eastern
Western
Coast
Inland
Other

SpeciesType [attribute]

Defines the species or mix of species comprising the product.

This item is restricted to the following list.

Afrormosia
Afzelia
Agba
AlaskanCedar
Alder
AlpineFir
AmabilisFir
Amapa
Andoung
Anegre
Antiaris
Ash
Aspen
AspenPolar
AustrianSpruce
Avodire

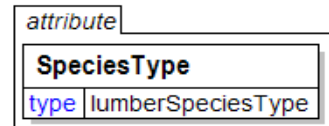

Ayan

Ayous/Ako

BalsamFir

BalsamPolar

Bamboo

Basswood

Beech

Birch

BirdseyeMaple

BlackCherry

BlackCottonwood

BlackGuarea

BlackSpruce

Bubinga

CaliforniaRedFir

CaribbeanPine

Yes, it is Caribbean Pine.

CarolinaPine

Cedar

Ceiba

CembraPine

Cherry

Chestnut

CoastSpecies

Cypress

Danta

DouglasFir

Douka

EasternCottonwood

EasternHemlock

EasternSoftwoods

EasternSpruce

EasternWhiteCedar

EasternWhitePine

Elliotti

EngelmanSpruce

Eucalyptus

EuropeanLarch
Exotic
FigureSycamore
Fir
Frake
Framire
Gaboon
GrandFir
GreyElm
HardMaple
Hemlock
Hornbeam
IdahoWhitePine
Ilomba
Imbira
IncCedar
InlRedCedar
Ipe
Iroko
JackPine
Kaya
Koto
Larch
LarricioPine
Lauan
Limba
Locust
LodgepolePine
Mahogany
Macoré
Mansonia
Maple
MaritimePine
Meranti
Merbeau
MexicanPine
MixedSoftwood

MixedSYP

MixedTropicalHardwood

MntnHemlock

Niangon

NobelFir

NorwaySpruce

NorthernAspen

NorthernPine

NorthernSpecies

Oak

Okume

OliverAsh

Olon

Omu

OregonPine

Ozigo

PacificCoastHemlock

PacificSilverFir

Padauk

PaoAmarello

Pear

Pearwood

Pine

Plane

PlywoodComposite

Indicates that the product is made up of a group of species. It is a composite product (usually plywood).

PonderosaPine

PrtOrfCed

Poucouli

Purpleheart

Radiata

RadiataPine

RedCedar

RedElm

RedOak

RedPine

RedSpruce
RedWhitewood
Redwood
RioRosewood
Rosewood
SandPine
SantosRosewood
Sapelle
Satinwood
ScotsPine
SilkyOak
SitkaSpruce
SouthernPine
SouthernPondPine
SouthernSprucePine
SPF
Spruce
SugarPine
SwissPear
SwissStonePine
Sycamore
SYP
Taeda
Tamarack
Tauari
Teak
Tiama
Tineo
TropicalOliver
Utile
VirginiaPine
Walnut
Wenge
Wey
WesternCedars
WesternHemlock
WesternRedCedar

- WesternWhitePine**
- WesternWhiteSpruce**
- WesternWoods**
- WhitebarkPine**
- WhiteFir**
- WhiteOak**
- WhiteSpruce**
- WhiteWood**
- YellowCedar**
- YellowCypress**
- YellowPoplar**
- Zebrano**
- Other**

SpecificationNumber

The unique identifier for the BookSpecification e-Document.

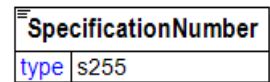

SpecInformation

Construct is used to uniquely identify this BookSpecification.

Note: ProductIdentifier, ProductDescription, and Classification removed in Version V2R30 and replaced with SpecificationNumber to more accurately reflect the business process.

(sequence)

The sequence of items below is mandatory. A single instance is required.

SpecificationNumber

SpecificationNumber is mandatory. A single instance is required.

The unique identifier for the BookSpecification e-Document.

SpecVersion

SpecVersion is mandatory. A single instance is required.

A value that keeps track of the version of the BookSpecification e-Document.

SpecIssueDate

SpecIssueDate is mandatory. A single instance is required.

The date and time when the BookSpecification e-Document was issued.

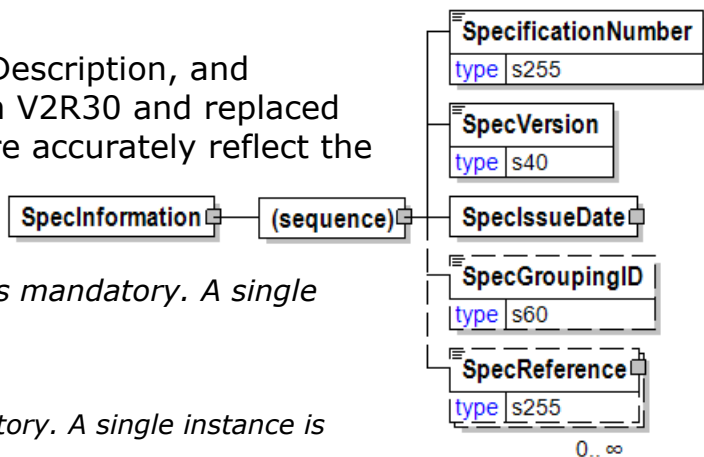

papiNet V2R31

SpecGroupingID

SpecGroupingID is optional. A single instance might exist.

A value that will relate/link specifications together. For example, items that are usually manufactured with common components.

SpecReference

SpecReference is optional. Multiple instances might exist.

Used to identify any external or associated documents, identifiers, etc.

SpecIssueDate

The date and time when the BookSpecification e-Document was issued.

(sequence)

The sequence of items below is mandatory. A single instance is required.

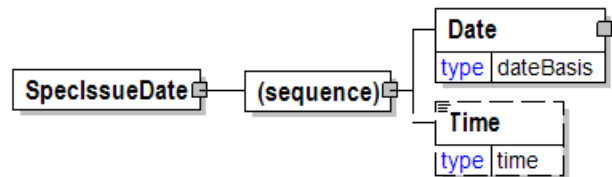

Date

Date is mandatory. A single instance is required.

A group element that contains the specification of Year, Month, and Day.

Time

Time is optional. A single instance might exist.

Times are treated in a standard XML fashion with a special case used to indicate a generalized "local" time. The standard XML approach to time is hh:mm:ss, hh:mm:ssZ, or hh:mm:ss±hh:mm.

hh:mm:ss±hh:mm is used to represent a time with a time zone. The time zone is communicated as the number of hours offset from the Universal Time Coordinate (UTC), a.k.a. Greenwich Mean Time.

hh:mm:ssZ indicates the time at Zulu (another name for UTC).

hh:mm:ss or hh:mm indicates within papiNet the applicable local time where the associated event is taking place. Caution should be used when processing times of this nature as the papiNet approach may be in discord with other users of XML.

SpecPacking

SpecPacking defines the book packaging parameters.

IsBoxed [attribute]

IsBoxed is optional. A single instance might exist.

Refer to IsBoxed definition for any enumerations.

IsPalletized [attribute]

IsPalletized is optional. A single instance might exist.

The buyer's directions for how the item is to be palletized.

Refer to IsPalletized definition for any enumerations.

(sequence)

The sequence of items below is mandatory. A single instance is required.

ProductIdentifier

ProductIdentifier is mandatory. A single instance is required.

Used to communicate the code of the article, in a variety of formats designated by the type.

ProductDescription

ProductDescription is optional. Multiple instances might exist.

An element used to communicate a human readable description of the product in the language specified by the Language attribute.

BookUnitPacking

BookUnitPacking is optional. Multiple instances might exist.

Book unit packing information

BoxCharacteristics

BoxCharacteristics is optional. A single instance might exist.

BoxCharacteristics is a group element that contains information about the box (or carton)

PalletPackagingCharacteristics

PalletPackagingCharacteristics is optional. A single instance might exist.

PalletPackagingCharacteristics details the characteristics of the packaging for a pallet.

AdditionalText

AdditionalText is optional. Multiple instances might exist.

A text field that is used to communicate information not previously defined or for

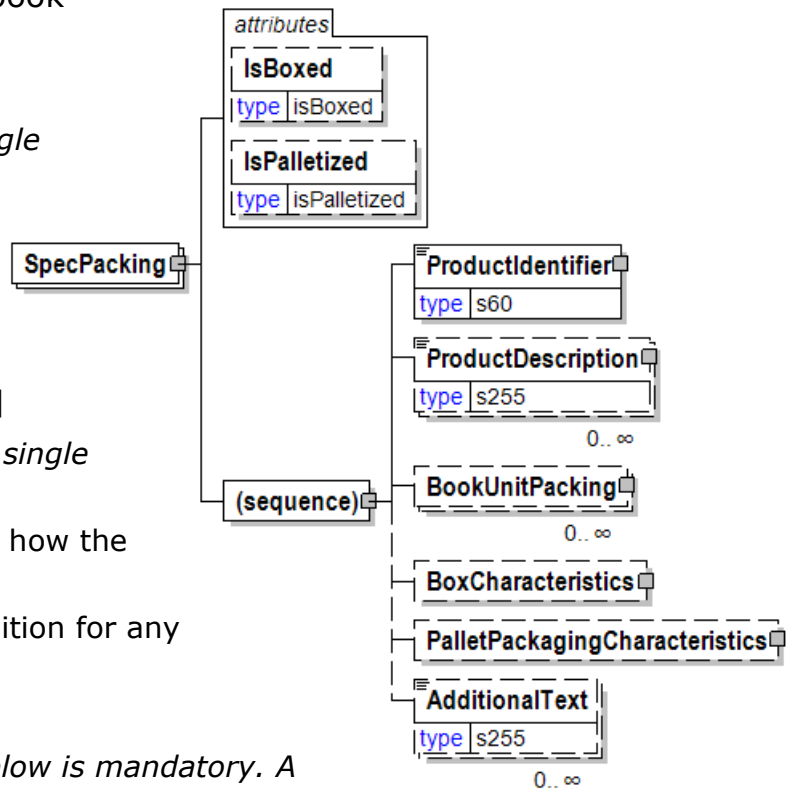

special instructions. To be used only for circumstances not covered by specific elements.

SpecReference

Used to identify any external or associated documents, identifiers, etc.

SpecReferenceType [attribute]

SpecReferenceType is mandatory. A single instance is required.

Provides a contextual explanation of the specific reference identifier. Many items are currently prefixed by "Buyer", "Forwarder", "Manufacturer", "Mill", "Seller", "Supplier", "Warehouse", or "Vendor". Check for an existing non-prefixed version and use the non-prefixed version instead. In the (yet to be announced release date) version 3.0 the prefixed versions will be removed. Instead the attribute @AssignedBy will communicate the information previously communicated in the prefix.

Refer to SpecReferenceType definition for any enumerations.

AssignedBy [attribute]

AssignedBy is optional. A single instance might exist.

Identifies the type of party or the agency that has assigned the associated item, e.g. a reference of type OrderNumber.

Refer to AssignedBy for any enumerations.

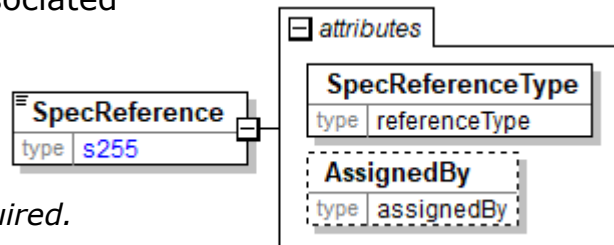

SpecReferenceType [attribute]

Provides a contextual explanation of the specific reference identifier. Many items are currently prefixed by "Buyer", "Forwarder", "Manufacturer", "Mill", "Seller", "Supplier", "Warehouse", or "Vendor". Check for an existing non-prefixed version and use the non-prefixed version instead. In the (yet to be announced release date) version 3.0 the prefixed versions will be removed. Instead the attribute @AssignedBy will communicate the information previously communicated in the prefix.

Refer to the [referenceType](#) entry for the list of enumerations and their definitions.

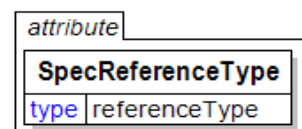

SpecStatusType [attribute]

Identifies the status of the entire BookSpecification e-Document (in other words, at the root level).

This item is restricted to the following list.

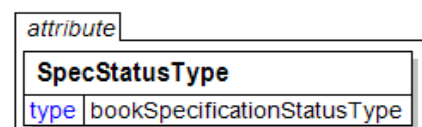

Amended

The supplied information is changed.

Cancelled

The supplied information has been cancelled. Items that have been cancelled are not included in totals on the summary levels of the e-Document.

Original

The supplied information is the first version of that information.

Replaced

The supplied information is replacing earlier supplied information. The receiver should revalidate the information in their system based upon the entire information received.

SpecType [attribute]

DefinitionUsed to identify what type of BookSpecification e-Document this transaction is.

This item is restricted to the following list.

attribute
SpecType
type bookSpecificationType

SpecContent

Indicates that BookSpecification should only be used in the content file verification process.

SpecOrder

Used when the BookSpecification e-Document is intended for use with the PurchaseOrder transaction.

SpecRFQ

Used when the BookSpecification e-Document is intended for use with the Request for Quote (Estimate) transaction.

SupplierSpec

Will be removed in a future version. Recommended not to be used.
(Old definition: Used when the BookSpecification e-Document is intended for use by the Supplier only and is not generated by, or transmitted to the Buyer).

SpecVersion

A value that keeps track of the version of the BookSpecification e-Document.

SpecVersion
type s40

SpeedType [attribute]

Speed Type

This item is restricted to the following list.

RampUp

RunSpeed

SlowDown

attribute	
SpeedType	
type	machineSpeedType
default	RunSpeed

SpineLabel [attribute]

The sleeve spine label.

attribute	
SpineLabel	
type	spineLabel

SpineLabel [attribute]

Is there a spine label?

This item is restricted to the following list.

Yes

No

attribute	
SpineLabel	
type	yesNo

SpineSize

The height of the spine.

(sequence)

The sequence of items below is mandatory. A single instance is required.

Value

Value is mandatory. A single instance is required.

A numeric value expressed in the unit of measure (UOM).

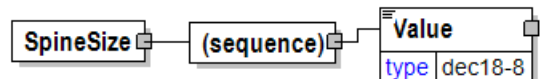

StackingMethod

A text field describing the pattern used when stacking of pallets.

StackingMethod	
type	s20

StacksPerPallet

The number of stacks on a pallet, where a stack is a vertical arrangement of items (looking down from above).

StacksPerPallet	
type	nni2

StandardDeviation

A statistic used as a measure of dispersion in a distribution.

UOM [attribute]

UOM is mandatory. A single instance is required.

Defines the unit of measure for the value.

Refer to UOM definition for any enumerations.

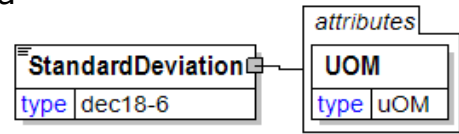

StandardSpacing

Is the spacing standard?

This item is restricted to the following list.

Yes

No

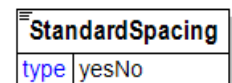

StartIdentifierRange

An element that identifies the starting item identifier in the range of items that contributed to the aggregated measurements for the range.

(sequence)

The sequence of items below is mandatory. A single instance is required.

Identifier

Identifier is mandatory. A single instance is required.

An Identifier is required for packages and items (pallets, reel packages, boxes, ream items, reel items, etc). The Identifier element contains the actual item identifier code. Identifier is repeatable so more than one identifier can be communicated. For example, the printed identifier on a label may be different from the barcode printed on the label.

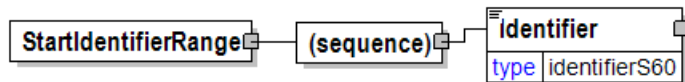

Statement

The Statement element is the root element for the Statement e-Document.

The Statement e-Document permits the manufacturer or supplier to report the current status of an invoice, or a list of invoices based upon specified criteria. The e-Document enables the sender to indicate payment status for the invoice.

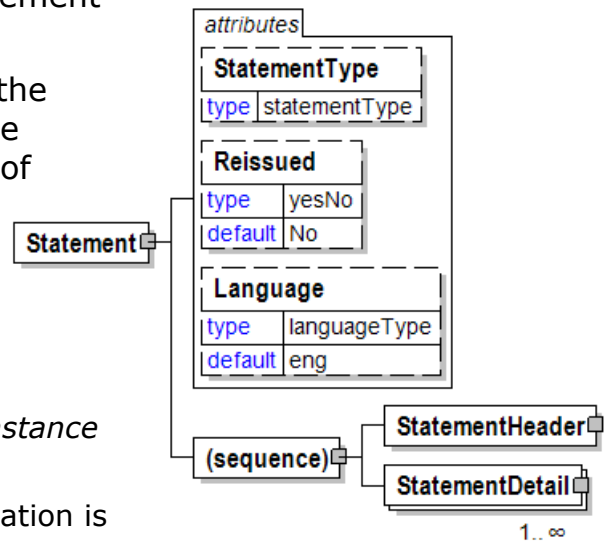

StatementType [attribute]

StatementType is optional. A single instance might exist.

Communicates how Statement information is filtered.

Refer to StatementType definition for any enumerations.

Reissued [attribute]

Reissued is optional. A single instance might exist.

Either "Yes" or "No".

Refer to Reissued definition for any enumerations.

Language [attribute]

Language is optional. A single instance might exist.

The valid Alpha 2- and Alpha 3-character list of language codes in the ISO 639-1 and 639-2 international standards.

Information on the content of this attribute is available at:
https://www.loc.gov/standards/iso639-2/php/code_list.php

(sequence)

The sequence of items below is mandatory. A single instance is required.

StatementHeader

StatementHeader is mandatory. A single instance is required.

Information that applies to the entire Statement e-Document.

StatementDetail

StatementDetail is mandatory. One instance is required, multiple instances might exist.

The specifics of information being communicated in the Statement e-Document.

StatementDetail

The specifics of information being communicated in the Statement e-Document.

(sequence)

The sequence of items below is mandatory. A single instance is required.

InvoiceNumber

InvoiceNumber is mandatory. A single instance is required.

The identification number of the papiNet e-Document Invoice. This number uniquely identifies documents for all InvoiceType such as Invoice, DebitNote, CreditNote, Approximate, SelfBillingStatement etc.

InvoiceDate

InvoiceDate is mandatory. A single instance is required.

A date that is qualifying the invoicing period. This date often drives payment terms. Note that this date is not necessarily the same as the issue date of the invoice.

InvoiceReference

InvoiceReference is optional. Multiple instances might exist.

A group item detailing relevant references pertaining to the invoice e-Document. InvoiceReferenceType describes the content.

BillToParty

BillToParty is mandatory. A single instance is required.

The address where the invoice is to be sent.

SupplierParty

SupplierParty is mandatory. A single instance is required.

The organisation or business entity responsible for providing the product. SupplierParty is also the seller of the product, if Seller is not specified as OtherParty = Seller.

BuyerParty

BuyerParty is mandatory. A single instance is required.

The legal entity to which the product is sold. Also commonly referred to as the sold-to party or customer. If no OtherParty is defined as the Payer, the Buyer is the Payer.

RemitToParty

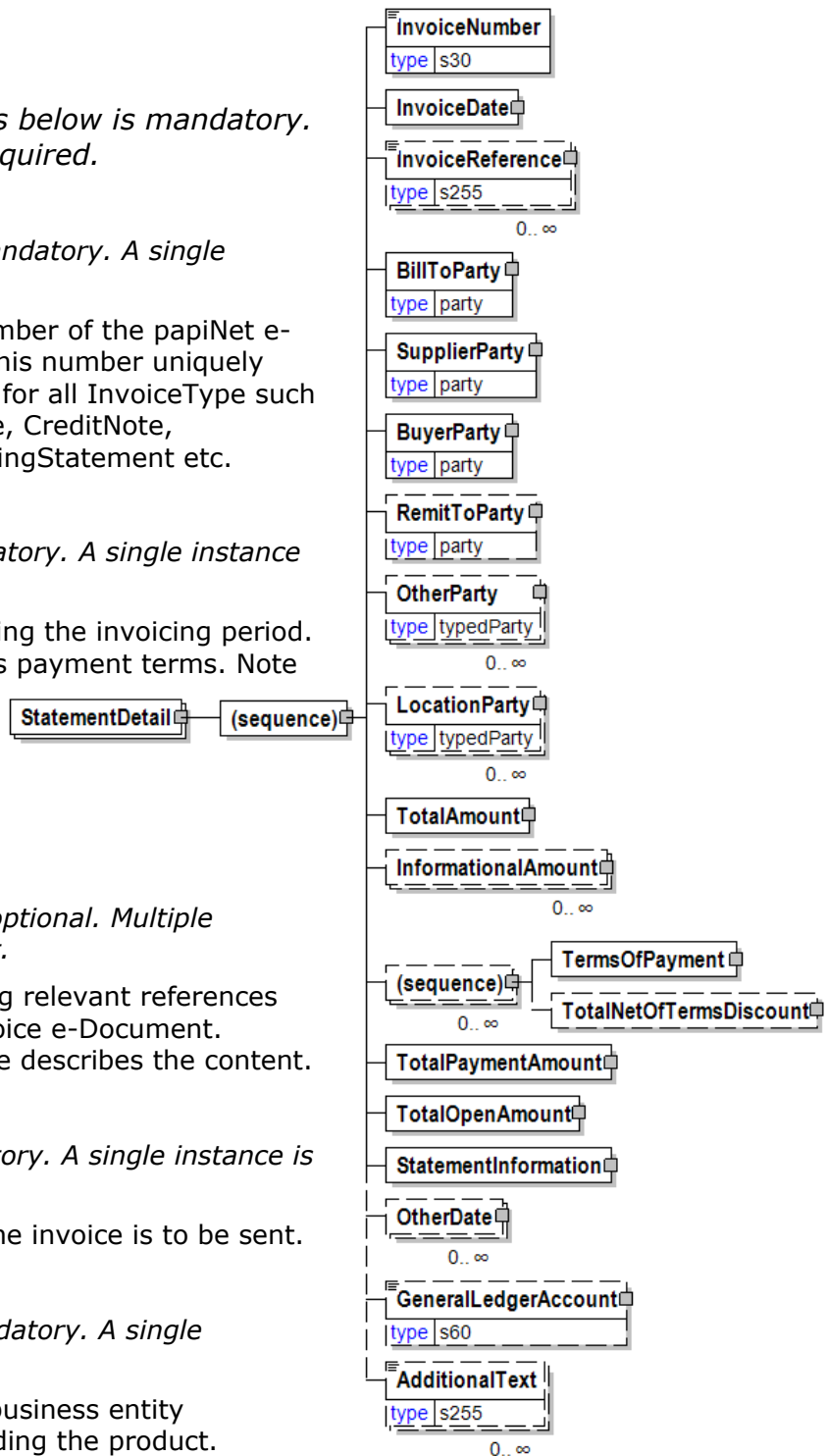

papiNet V2R31

RemitToParty is optional. A single instance might exist.

A group item containing details of the party to whom payment will be made. The RemitToParty contains all information related to remittance.

OtherParty

OtherParty is optional. Multiple instances might exist.

An organisation or business entity other than those specifically detailed within an e-Document.

LocationParty

LocationParty is optional. Multiple instances might exist.

The organization or business entity where the business event took place or will take place.

TotalAmount

TotalAmount is mandatory. A single instance is required.

The total amount including tax (when tax is specified in the e-Document).

In e-Documents claiming payment this is the amount due for payment based on the terms of payment. Decimal rounding might be applied to this amount.

InformationalAmount

InformationalAmount is optional. Multiple instances might exist.

A monetary amount used for information purposes only (not for calculation). For example, the invoice price adjustment subtotal is expressed in sterling pounds, and the buyer wants this information expressed in U.S. dollars.

CreditDebitNote and Invoice - The TaxAmount is displayed in the currency that is applicable throughout the e-Document. When a TaxAmount needs to be displayed in a different national currency, this field is used.

(sequence)

The sequence of items below is optional. Multiple instances might exist.

TermsOfPayment

TermsOfPayment is mandatory. A single instance is required.

A group item that contains agreed-to terms defining when, how, and under what conditions the payment is to be made.

When TermsOfPayment is optional; if omitted, TermsOfPayment is controlled through previous negotiation.

TotalNetOfTermsDiscount

TotalNetOfTermsDiscount is optional. A single instance might exist.

The components of the amount to be paid if prompt payment discount terms are met, including the amount that is subject to the payment terms discount, the discount amount, and the amount due after prompt payment discount.

TotalPaymentAmount

TotalPaymentAmount is mandatory. A single instance is required.

The amounts which were paid and booked against the original invoice.

TotalOpenAmount

TotalOpenAmount is mandatory. A single instance is required.

InvoiceAmount less the sum of all payment amounts, translated into one common

currency.

StatementInformation

StatementInformation is mandatory. A single instance is required.

Invoice information for the statement.

OtherDate

OtherDate is optional. Multiple instances might exist.

A date that may not be specifically detailed within a document (example: print date at the PurchaseOrderLineItem).

GeneralLedgerAccount

GeneralLedgerAccount is optional. A single instance might exist.

The general ledger account to be referenced for the item.

AdditionalText

AdditionalText is optional. Multiple instances might exist.

A text field that is used to communicate information not previously defined or for special instructions. To be used only for circumstances not covered by specific elements.

StatementHeader

Information that applies to the entire Statement e-Document.

(sequence)

The sequence of items below is mandatory. A single instance is required.

StatementNumber

StatementNumber is mandatory. A single instance is required.

A number used to identify the Statement.



StatementResponseDate

StatementResponseDate is mandatory. A single instance is required.

The date and time when the Statement e-Document was issued

RequestNumber

RequestNumber is optional. A single instance might exist.

A unique tracking number specifically identifying the InfoRequest e-Document to the originator. The tracking number is returned with the "information", the answer, to help match the answer to the request.

RequestingParty

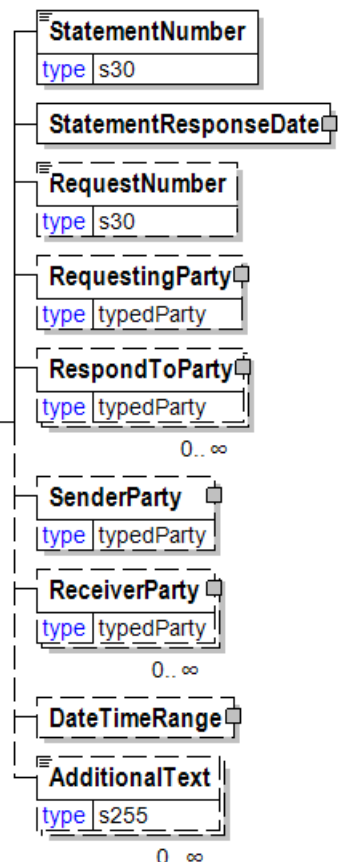

papiNet V2R31

RequestingParty is optional. A single instance might exist.

The party requesting the information.

RespondToParty

RespondToParty is optional. Multiple instances might exist.

The party the document should be responded to.

SenderParty

SenderParty is optional. A single instance might exist.

The business entity issuing the e-Document, the source of the document.

The entity responsible for the content. If the sender party has out sourced the message service to a third party the SenderParty is the issuer of the e-Document and not the party performing the transmission service of the electronic message.

ReceiverParty

ReceiverParty is optional. Multiple instances might exist.

The business entity for whom the e-Document is intended, the destination of the document.

The entity interested in the content. If the receiver party has outsourced the message service to a third party the ReceiverParty is the intended party for the e-Document and not the party performing the receiving service of the electronic message.

DateTimeRange

DateTimeRange is optional. A single instance might exist.

Specifies a date and/or time range.

AdditionalText

AdditionalText is optional. Multiple instances might exist.

A text field that is used to communicate information not previously defined or for special instructions. To be used only for circumstances not covered by specific elements.

StatementInformation

Invoice information for the Statement.

(sequence)

The sequence of items below is mandatory. A single instance is required.

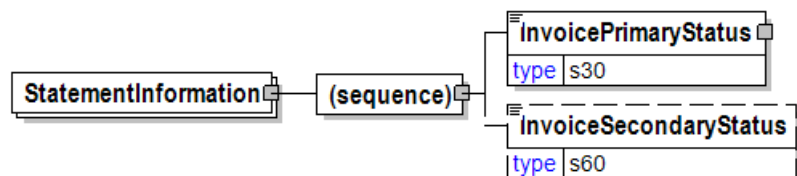

InvoicePrimaryStatus

InvoicePrimaryStatus is mandatory. A single instance is required.

The primary status of the invoice.

InvoiceSecondaryStatus

InvoiceSecondaryStatus is optional. A single instance might exist.

The secondary status of the invoice.

StatementNumber

A number used to identify the Statement.

StatementNumber	
type	s30

StatementRequestDetail

A grouping element that provides the parameters to be used when responding with a Statement e-Document.

StatementRequestType [attribute]

StatementRequestType is mandatory. A single instance is required.

Communicates how statement information is filtered.

Refer to StatementRequestType definition for any enumerations.

(sequence)

The sequence of items below is mandatory. A single instance is required.

SupplierParty

SupplierParty is optional. Multiple instances might exist.

The organisation or business entity responsible for providing the product. SupplierParty is also the seller of the product, if Seller is not specified as OtherParty = Seller.

BuyerParty

BuyerParty is optional. Multiple instances might exist.

The legal entity to which the product is sold. Also commonly referred to as the sold-to party or customer. If no OtherParty is defined as the Payer, the Buyer is the Payer.

ShipToParty

ShipToParty is optional. Multiple instances might exist.

The name and/or address to which the goods should be delivered with the party type indicated by the PartyType attribute.

ForwarderParty

ForwarderParty is optional. Multiple instances might exist.

The trading partner involved in the forwarding of the shipment.

StatementInformation

StatementInformation is optional. Multiple instances might exist.

Invoice information for the Statement.

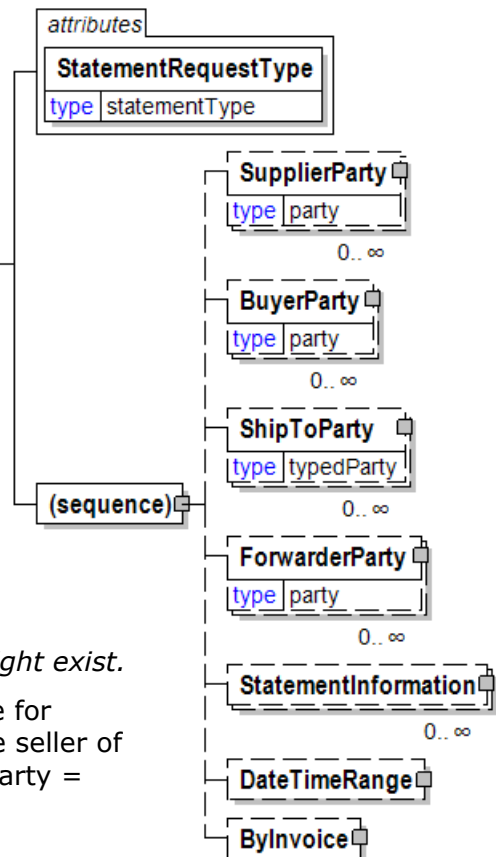

papiNet V2R31

DateTimeRange

DateTimeRange is optional. A single instance might exist.

Specifies a date and/or time range.

ByInvoice

ByInvoice is optional. A single instance might exist.

Selection criteria for invoice information.

StatementRequestType [attribute]

Communicates how statement information is filtered.

This item is restricted to the following list.

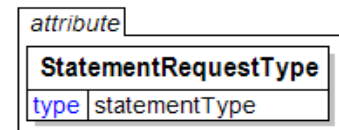

AllCreditsDebitsInvoices

ByCreditDebit

ByCreditDebit will be deprecated in a future version V3R00. Use AllCreditsDebitsInvoices instead.

ByInvoiceNumber

ByDebit

StatementResponseDate

The date and time when the Statement e-Document was issued.

(sequence)

The sequence of items below is mandatory. A single instance is required.

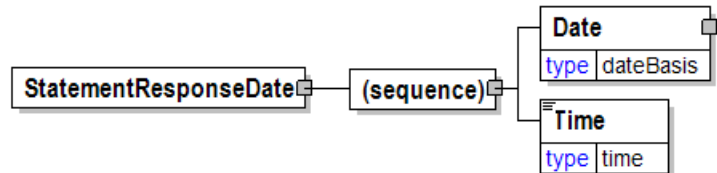

Date

Date is mandatory. A single instance is required.

A group element that contains the specification of Year, Month, and Day.

Time

Time is mandatory. A single instance is required.

Times are treated in a standard XML fashion with a special case used to indicate a generalized "local" time. The standard XML approach to time is hh:mm:ss, hh:mm:ssZ, or hh:mm:ss±hh:mm.

hh:mm:ss±hh:mm is used to represent a time with a time zone. The time zone is communicated as the number of hours offset from the Universal Time Coordinate (UTC), a.k.a. Greenwich Mean Time.

hh:mm:ssZ indicates the time at Zulu (another name for UTC).

hh:mm:ss or hh:mm indicates within papiNet the applicable local time where the associated event is taking place. Caution should be used when processing times of this nature as the papiNet approach may be in discord with other users of XML.

StatementType [attribute]

Communicates how statement information is filtered.

This item is restricted to the following list.

AllCreditsDebitsInvoices

ByCreditDebit

ByCreditDebit will be deprecated in a future version V3R00. Use **AllCreditsDebitsInvoices** instead.

ByInvoiceNumber

ByDebit

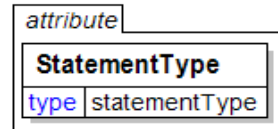

StateOrProvince

The political designation or boundary of a specific area of land.

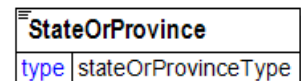

StateOrProvince [attribute]

The political designation or boundary of a specific area of land.



StatisticalGoodsInformation

A group item containing statistical information about handled or traded goods.

(sequence)

The sequence of items below is mandatory. A single instance is required.

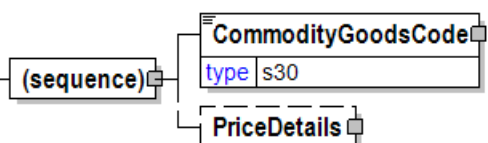
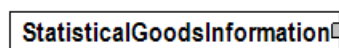

CommodityGoodsCode

CommodityGoodsCode is mandatory. A single instance is required.

A code defining the type of goods handled or traded. The Harmonized Commodity Description and Coding System (HS) of the Customs Cooperation Council (CCC) is used worldwide as a reference for classifications of external trade statistics and for customs tariffs.

PriceDetails

PriceDetails is optional. A single instance might exist.

An element that groups together price information.

Status [attribute]

Defines if the document content has been successfully validated or not when presented to the receiver's ERP system. The validation can be carried out against the agreed specification of the document content, the papiNet Business Rules and agreed specific Business Rules applicable to the receiver's ERP system.

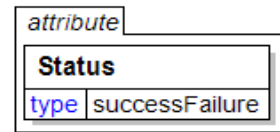

N.B. Validation of the document content can be successful even though processing of the document in the receiver's ERP system would fail because of deficiencies or insufficient data in the ERP system.

This item is restricted to the following list.

Success

Indicates that the validation of the document content has been successful when presented to the receiver's ERP system.

Failure

Indicates that the validation of the document content has failed when presented to the receiver's ERP system.

StatusAsOfDate

The specific Date and Time for which status is requested. This implies that all open transactions have closed for the date before the status is reported.

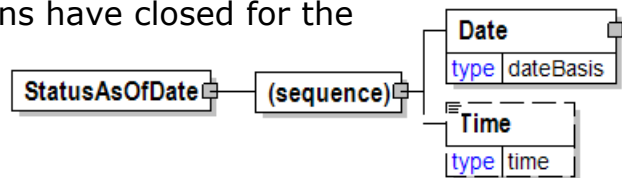

(sequence)

The sequence of items below is mandatory. A single instance is required.

Date

Date is mandatory. A single instance is required.

A group element that contains the specification of Year, Month, and Day.

Time

Time is optional. A single instance might exist.

Times are treated in a standard XML fashion with a special case used to indicate a generalized "local" time. The standard XML approach to time is hh:mm:ss, hh:mm:ssZ, or hh:mm:ss±hh:mm.

hh:mm:ss±hh:mm is used to represent a time with a time zone. The time zone is communicated as the number of hours offset from the Universal Time Coordinate (UTC), a.k.a. Greenwich Mean Time.

hh:mm:ssZ indicates the time at Zulu (another name for UTC).

hh:mm:ss or hh:mm indicates within papiNet the applicable local time where the associated event is taking place. Caution should be used when processing times of this nature as the papiNet approach may be in discord with other users of XML.

StencilCharacteristics

A group element specifying attributes of a stencil to be applied to an item, and optional text.

StencilType [attribute]

StencilType is optional. A single instance might exist.

The type of stencil

Refer to StencilType definition for any enumerations.

StencilInkType [attribute]

StencilInkType is optional. A single instance might exist.

Specifies the characteristics of the ink to be used for the stencil

Refer to StencilInkType definition for any enumerations.

StencilLocation [attribute]

StencilLocation is optional. A single instance might exist.

Specifies the location of the stencil on the product

Refer to StencilLocation definition for any enumerations.

StencilFormat [attribute]

StencilFormat is optional. A single instance might exist.

Specifies how the information is to be presented in the stencil

Refer to StencilFormat definition for any enumerations.

StencilContent [attribute]

StencilContent is optional. A single instance might exist.

Specifies the information contained in the stencil.

Refer to StencilContent definition for any enumerations.

AssignedBy [attribute]

AssignedBy is optional. A single instance might exist.

Identifies the type of party or the agency that has assigned the associated item, e.g. a reference of type OrderNumber.

Refer to AssignedBy definition for any enumerations.

(sequence)

The sequence of items below is mandatory. A single instance is required.

StencilText

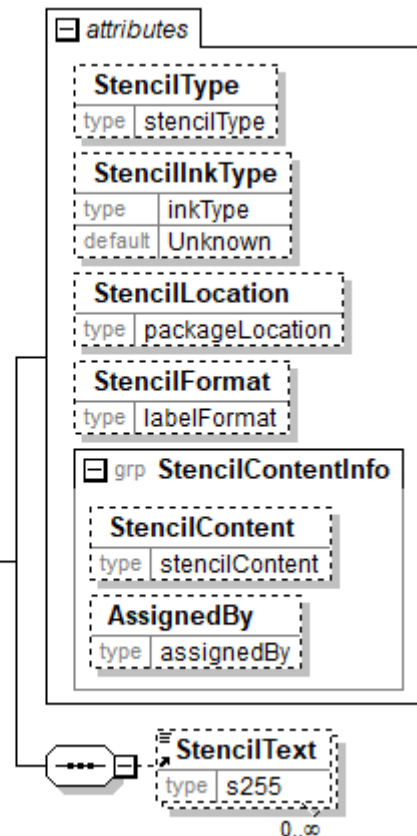

StencilText is optional. Multiple instances might exist.

Plain text that is to be stenciled on the product. Used in conjunction with StencilContent = "PlainText".

StencilContent [attribute]

Specifies the information contained in the stencil.

This item is restricted to the following list.

attribute
StencilContent
type stencilContent

Author

Name of the author of the product or book

BasisWeight

The weight of the paper expressed as a mass for a given surface area.

BoxWeight

Weight of the filled box.

BookVolumeNumber

A number assigned to a book that denotes the sequential order when several books are either bound in an identical format or are part of a series or set.

BrandName

A specific product brand name for which the owner or source is specified in the "@AssignedBy" attribute.

Copyright

The year of publication copyright.

Edition

Identifies the version of the product for which copies were printed and published at one time; For example in book manufacturing values might be 1st, 2nd, etc.

ExportShipMark

An export shipment mark for identification.

GradeCode

A specific product code for which the owner or source is specified in the "@AssignedBy" attribute.

GradeName

A specific product name for which the owner or source is specified in the "@AssignedBy" attribute (for example, ImprovedNewsprint-45-1479).

Identifier

Identifier of the individual item.

ISBN10

10 digit ISBN code without dashes.

ISBN10Dash

10 digit ISBN code with dashes.

ISBN13

13 digit ISBN code.

ISBN13Dash

A 13 character ISBN with dashes.

LotIdentifier

A unique code used to identify a grouping of product with one set of quality statistics common to all members of that group. Synonym: Lot Number.

PartNumber

An equivalent to the Stock Keeping Unit (SKU) for which the owner or source is specified in the "@AssignedBy" attribute. In other words, this code fully defines the product.

PlainText

To be deprecated in a future version V3R00. Use instead "ReferenceNumber".

PrintingNumber

A reference to the sequential print run number.

ProductIdentifier

To be deprecated in a future version V3R00. Use instead specific product identifier types such as BrandName, GradeCode, GradeName and PartNumber.

ProfitCenter

Profit Center identifier.

PublisherName

Name of the publisher of a document

PubName

The publication name.

PurchaseOrderNumber

The unique order identifier as designated by the customer.

PurchaseOrderReference

To be deprecated in a future version V3R00. Use instead "ReferenceNumber".

ReferenceNumber

An informational reference (either textual or numeric) for which the owner or source is specified in the "@AssignedBy" attribute

RetailPrice

Cover price of the finished product.

TambourID

The unique identifier of the jumbo reel (also called mother reel or Tambour).

Title

Proper title of a book product.

papiNet V2R31

TitleAlias

Alternate title description for book products, usually for security purposes.

UnitsPerCarton

Number of units per box.

UniversalProductIdentifier

Unique identifier for the book, component of a book product, and many other products.

VendorBrandName

To be deprecated in a future version V3R00. Use instead "BrandName" and specify owner or source is in the "@AssignedBy" attribute with enumeration "Seller".

VendorGradeCode

To be deprecated in a future version V3R00. Use instead "GradeCode" and specify owner or source is in the "@AssignedBy" attribute with enumeration "Seller".

VendorGradeName

To be deprecated in a future version V3R00. Use instead "GradeName" and specify owner or source is in the "@AssignedBy" attribute with enumeration "Seller".

StencilFormat [attribute]

Specifies how the information is to be presented in the stencil

This item is restricted to the following list.

Barcode

The information requested is to be stenciled as a barcode

Text

The information requested is to be stenciled in plain text.

attribute	
StencilFormat	
type	labelFormat

StencilInkType [attribute]

Specifies the characteristics of the ink to be used for the stencil

This item is restricted to the following list.

EdibleNotWaterSoluble

The ink used is suitable for human consumption but will not dissolve in water.

EdibleWaterSoluble

The ink used is suitable for human consumption and is soluble in water.

InedibleNotWaterSoluble

attribute	
StencilInkType	
type	inkType
default	Unknown

papiNet V2R31

The ink used is not suitable for human consumption and will not dissolve in water.

InedibleWaterSoluble

The ink used is not suitable for human consumption and is soluble in water.

Unknown

The characteristics of the ink used for the stencil are unknown.

StencilLocation [attribute]

Specifies the location of the stencil on the product

This item is restricted to the following list.

attribute	
StencilLocation	
type	packageLocation

End

The stencil is to be placed on the end of the product.
E.g. on the end of a pallet, box, bale or reel.

Top

The stencil is to be placed on the top of the product. E.g. on the top of a pallet, box, bale or reel.

Side

The stencil is to be placed on the side of the product. E.g. on the side of a pallet, box or bale.

UnwrappedReelBilge

The stencil is to be placed on the unwrapped (bare) reel bilge (side).

UnwrappedReelEnd

The stencil is to be placed on the unwrapped (bare) end of a reel.

WrappedReelBilge

The stencil is to be placed on the outside of the wrapper on a reel.

StencilText

Plain text that is to be stenciled on the product. Used in conjunction with StencilContent = "PlainText".

StencilText	
type	s255

StencilType [attribute]

The type of stencil

This item is restricted to the following list.

attribute	
StencilType	
type	stencilType

CutOut

The stencil is a cut out.

InkJet

The stencil is ink jetted.

Rubber

The stencil is made of rubber.

Stiffness

A group item used to communicate stiffness target or test value.

TestMethod [attribute]

TestMethod is optional. A single instance might exist.

The method used to determine the results of the test under consideration.

TestAgency [attribute]

TestAgency is optional. A single instance might exist.

The agency that has set the parameters for the testing

Refer to TestAgency definition for any enumerations.

SampleType [attribute]

SampleType is optional. A single instance might exist.

Communicates how sampling was done to measure the product characteristics.

Refer to SampleType definition for any enumerations.

ResultSource [attribute]

ResultSource is optional. A single instance might exist.

Used to define the data source of the specified test

Refer to ResultSource definition for any enumerations.

(sequence)

The sequence of items below is mandatory. A single instance is required.

DetailValue

DetailValue is mandatory. A single instance is required.

A numeric value expressed in the unit of measure (UOM).

DetailRangeMin

DetailRangeMin is optional. A single instance might exist.

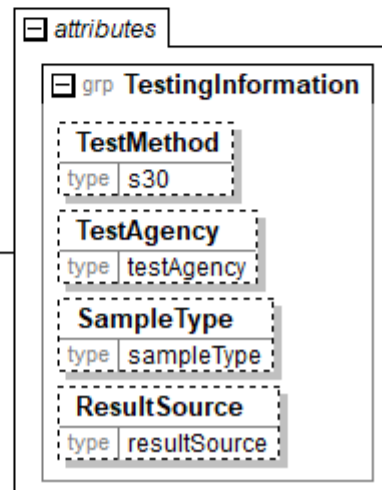
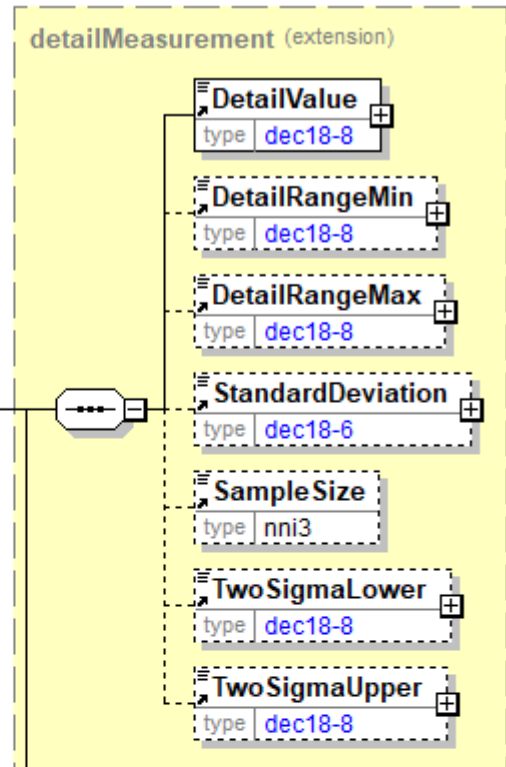
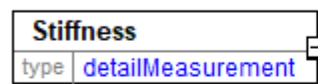

papiNet V2R31

The minimum value (lower boundary) allowed for the DetailValue that is the parent of this element.

DetailRangeMax

DetailRangeMax is optional. A single instance might exist.

The maximum value (upper boundary) allowed for the DetailValue that is the parent of this element.

StandardDeviation

StandardDeviation is optional. A single instance might exist.

A statistic used as a measure of dispersion in a distribution.

SampleSize

SampleSize is optional. A single instance might exist.

The number of samples used to determine the product characteristic in question.

TwoSigmaLower

TwoSigmaLower is optional. A single instance might exist.

Two sigma (a measure of dispersion associated with standard deviation) on the lower side of the standard deviation.

TwoSigmaUpper

TwoSigmaUpper is optional. A single instance might exist.

Two sigma (a measure of dispersion associated with standard deviation) on the upper side of the standard deviation.

StopOffInformation

Where is the shipment and how far to the next stop.

(sequence)

The sequence of items below is mandatory. A single instance is required.

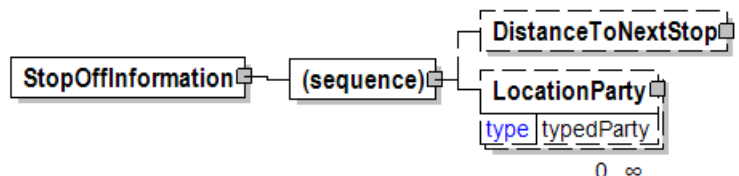

DistanceToNextStop

DistanceToNextStop is optional. A single instance might exist.

The distance to the next transportation node.

LocationParty

LocationParty is optional. Multiple instances might exist.

The organization or business entity where the business event took place or will take place.

StrengthGroup

As defined in the NIST standard, an additional classification of panel strength.

This item is restricted to the following list.

Class-I

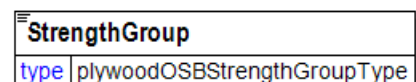

Class-II

Group1

Group2

Group3

Group4

Struc-I

Decorative

Stretch

A group item used to communicate stretch target or test value.

TestMethod [attribute]

TestMethod is optional. A single instance might exist.

The method used to determine the results of the test under consideration.

TestAgency [attribute]

TestAgency is optional. A single instance might exist.

The agency that has set the parameters for the testing

Refer to TestAgency definition for any enumerations.

SampleType [attribute]

SampleType is optional. A single instance might exist.

Communicates how sampling was done to measure the product characteristics.

Refer to SampleType definition for any enumerations.

ResultSource [attribute]

ResultSource is optional. A single instance might exist.

Used to define the data source of the specified test

Refer to ResultSource definition for any enumerations.

(sequence)

The sequence of items below is mandatory. A single instance is required.

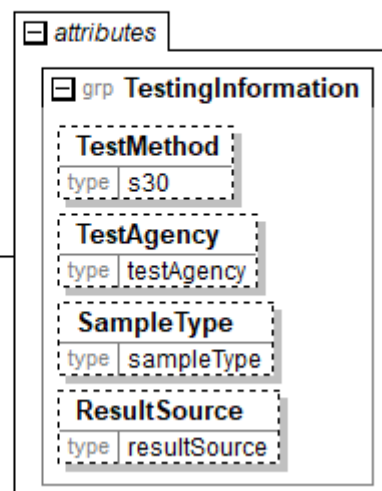
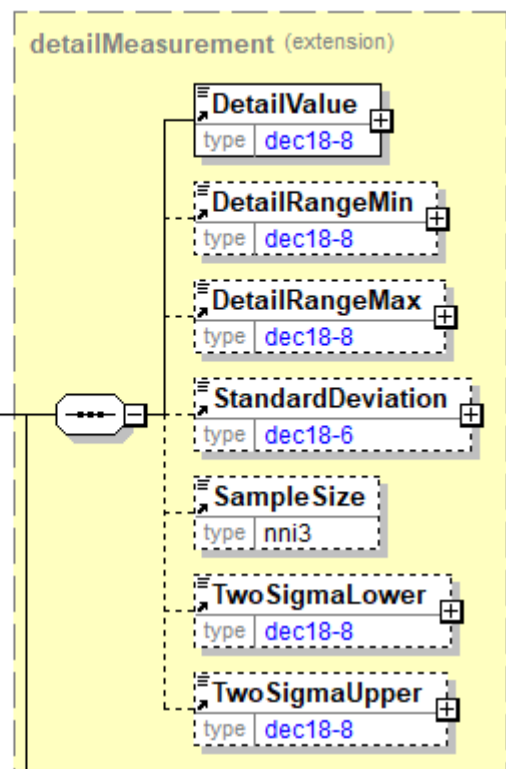

DetailValue

DetailValue is mandatory. A single instance is required.

A numeric value expressed in the unit of measure (UOM).

DetailRangeMin

DetailRangeMin is optional. A single instance might exist.

The minimum value (lower boundary) allowed for the DetailValue that is the parent of this element.

DetailRangeMax

DetailRangeMax is optional. A single instance might exist.

The maximum value (upper boundary) allowed for the DetailValue that is the parent of this element.

StandardDeviation

StandardDeviation is optional. A single instance might exist.

A statistic used as a measure of dispersion in a distribution.

SampleSize

SampleSize is optional. A single instance might exist.

The number of samples used to determine the product characteristic in question.

TwoSigmaLower

TwoSigmaLower is optional. A single instance might exist.

Two sigma (a measure of dispersion associated with standard deviation) on the lower side of the standard deviation.

TwoSigmaUpper

TwoSigmaUpper is optional. A single instance might exist.

Two sigma (a measure of dispersion associated with standard deviation) on the upper side of the standard deviation.

SubClassification

SubClassification provides additional classification information.

(sequence)

The sequence of items below is mandatory. A single instance is required.

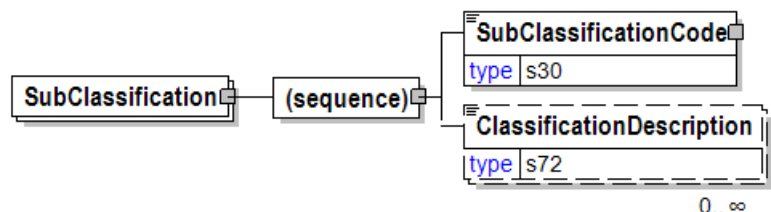

SubClassificationCode

SubClassificationCode is mandatory. A single instance is required.

Sub Classification Code

ClassificationDescription

ClassificationDescription is optional. Multiple instances might exist.

A free form description of the classification.

SubClassificationCode

Sub Classification Code

Agency [attribute]

Agency is mandatory. A single instance is required.

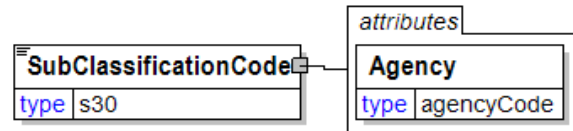

Describes the agency maintaining the list of codes. To be included in this list the agency must be a recognized standards body or industry organisation.

- For the element that owns this attribute.
- For another attribute in the list of attributes associated with the parent element.

Refer to Agency definition for any enumerations.

SupersType [attribute]

Supers Type

This item is restricted to the following list.

- Ribbed**
- Regular**

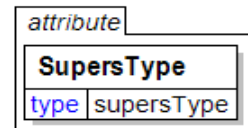

Supplemental

Supplemental

SupplementalSpecification [attribute]

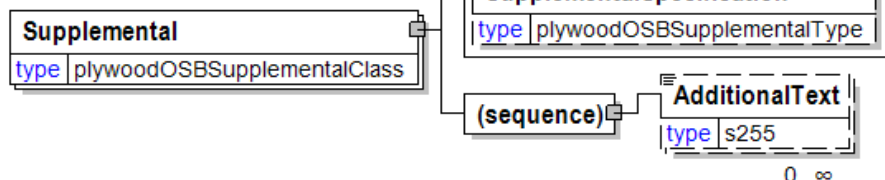

SupplementalSpecification is optional. A single instance might exist.

Supplemental specification

Refer to SupplementalSpecification definition for any enumerations.

(sequence)

The sequence of items below is mandatory. A single instance is required.

AdditionalText

AdditionalText is optional. Multiple instances might exist.

A text field that is used to communicate information not previously defined or for special instructions. To be used only for circumstances not covered by specific elements.

SupplementalSpecification [attribute]

Supplemental specification

This item is restricted to the following list.

EdgeSealed

Overlay-1Side

Overlay-2Side

B-X-band

Plugged-X-Band

PluggedInnerPlies

Solid inner plies.

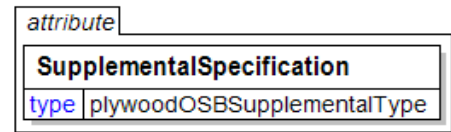

SuppliedComponentFinishSpecs

Supplied Component Finish Specs

(sequence)

The sequence of items below is mandatory. A single instance is required.

FinishSpecs

FinishSpecs is optional. A single instance might exist.

Finish specifications

FinishPrep

FinishPrep is optional. Multiple instances might exist.

Finish prep

AdditionalText

AdditionalText is optional. Multiple instances might exist.

A text field that is used to communicate information not previously defined or for special instructions. To be used only for circumstances not covered by specific elements.

Length

Length is optional. A single instance might exist.

The length of the object.

Width

Width is optional. A single instance might exist.

The width of the object.

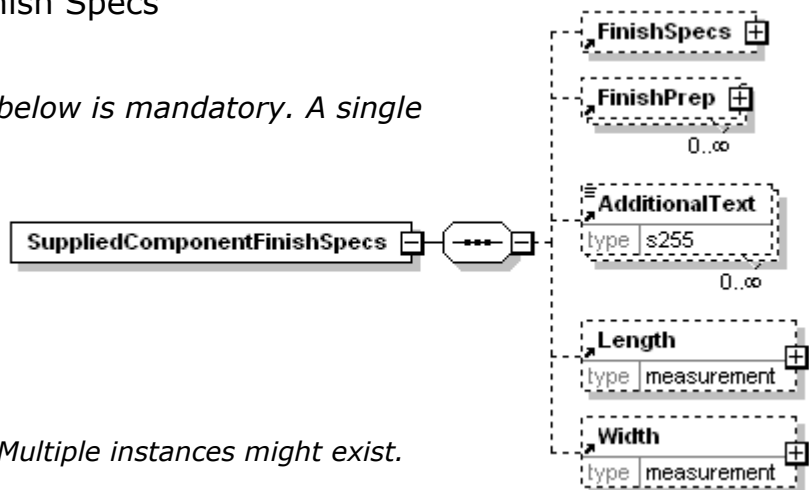

SuppliedComponentInformation

Information about components supplied by the publisher to the vendor i.e. paper supplied to the print vendor or jackets supplied to the bind vendor.

SuppliedComponentType [attribute]

SuppliedComponentType is

SuppliedComponentInformation

optional. A single instance might exist.

Supplied Component Type

Refer to SuppliedComponentType definition for any enumerations.

(sequence)

The sequence of items below is mandatory. A single instance is required.

SupplierParty

SupplierParty is mandatory. A single instance is required.

The organisation or business entity responsible for providing the product. SupplierParty is also the seller of the product, if Seller is not specified as OtherParty = Seller.

(sequence)

The sequence of items below is mandatory. One instance is required, multiple instances might exist.

ProductIdentifier

ProductIdentifier is mandatory. A single instance is required.

Used to communicate the code of the article, in a variety of formats designated by the type.

ProductDescription

ProductDescription is optional. Multiple instances might exist.

An element used to communicate a human readable description of the product in the language specified by the Language attribute.

Classification

Classification is optional. Multiple instances might exist.

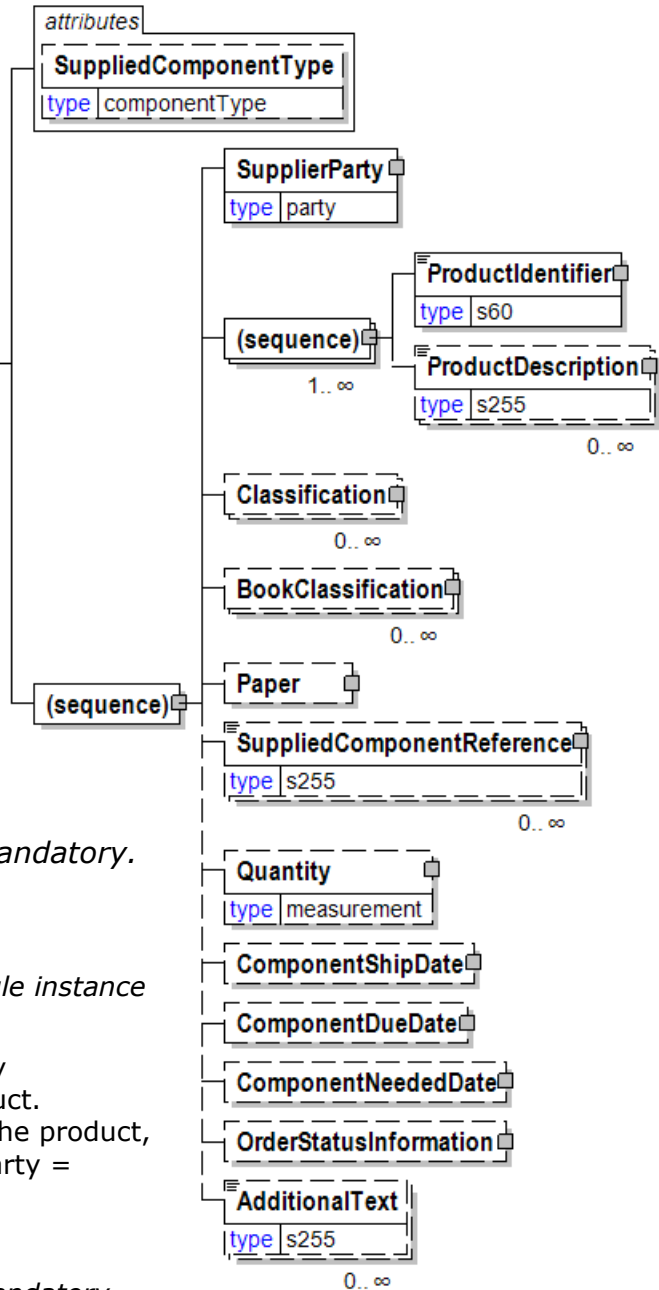

A group item that details the product classification according to a particular organization's scheme. An item across multiple classifications would still be recognized as the same item. Examples of some product classifications are: Containerboard, Pulp-Dissolving, or Newsprint.

BookClassification

BookClassification is optional. Multiple instances might exist.

Category under which the product or a component within the product is classified.

Paper

Paper is optional. A single instance might exist.

A group item defining the characteristics of the paper product.

SuppliedComponentReference

SuppliedComponentReference is optional. Multiple instances might exist.

Used to send component PurchaseOrder number for supplied components if they need to be returned on a invoice

Quantity

Quantity is optional. A single instance might exist.

The Quantity element contains attributes that provide information about the type of quantity that is being communicated, the context in which the particular quantity is to be viewed, and (if the quantity represents an adjustment) an adjustment type.

The Quantity element contains three child elements that enable you to communicate a range of values for the quantity and a target or actual value. It is at this level (Value, RangeMin, and RangeMax) that the unit of measure is specified. This permits the range to be specified in a different unit of measure than the target.

ComponentShipDate

ComponentShipDate is optional. A single instance might exist.

Date supplied component is expected to ship

ComponentDueDate

ComponentDueDate is optional. A single instance might exist.

Date supplied component is expected to arrive

ComponentNeededDate

ComponentNeededDate is optional. A single instance might exist.

Date the supplied component is needed by the vendor in order to make the due date of the ordered product.

OrderStatusInformation

OrderStatusInformation is optional. A single instance might exist.

A group element that stores two levels of order status codes.

AdditionalText

AdditionalText is optional. Multiple instances might exist.

A text field that is used to communicate information not previously defined or for special instructions. To be used only for circumstances not covered by specific elements.

SuppliedComponentReference

Used to send component
PurchaseOrder number for supplied

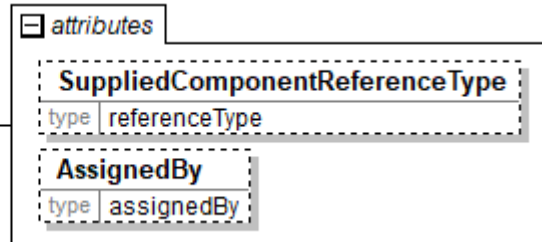

components if they need to be
returned on a invoice

SuppliedComponentReferenceType [attribute]

SuppliedComponentReferenceType is optional. A single instance might exist.

SuppliedComponentReferenceType provides a contextual explanation of the specific reference identifier. Many items are currently prefixed by "Buyer", "Customer", "Seller", and/or "Supplier". Check for an existing non-prefixed version and use the non-prefixed version instead. In the (yet to be announced release date) version 3.0 the prefixed versions will be removed. Instead the attribute @AssignedBy will communicate the information previously communicated in the prefix.

Refer to SuppliedComponentReferenceType definition for any enumerations.

AssignedBy [attribute]

AssignedBy is optional. A single instance might exist.

Identifies the type of party or the agency that has assigned the associated item, e.g. a reference of type OrderNumber.

Refer to AssignedBy for any enumerations.

SuppliedComponentReferenceType [attribute]

SuppliedComponentReferenceType provides a contextual explanation of the specific reference identifier. Many items are currently prefixed by "Buyer", "Customer", "Seller", and/or "Supplier". Check for an existing non-prefixed version and use the non-prefixed version instead. In the (yet to be announced release date) version 3.0 the prefixed versions will be removed. Instead the attribute @AssignedBy will communicate the information previously communicated in the prefix.

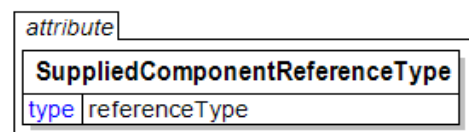

Refer to the [referenceType](#) entry for the list of enumerations and their definitions.

SuppliedComponentType [attribute]

Supplied Component Type

This item is restricted to the following list.

Component

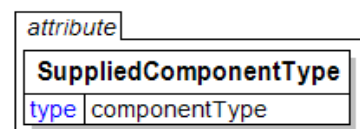

RawMaterial

SupplierCustomsReference

Supplier Customs Reference

SupplierCustomsReferenceType [attribute]

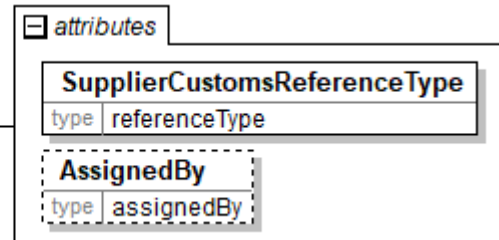
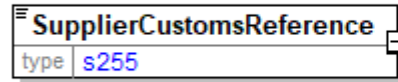

SupplierCustomsReferenceType is mandatory. A single instance is required.

Provides a contextual explanation of the specific reference identifier. Many items are currently prefixed by "Buyer", "Forwarder", "Manufacturer", "Mill", "Seller", "Supplier", "Warehouse", or "Vendor". Check for an existing non-prefixed version and use the non-prefixed version instead. In the (yet to be announced release date) version 3.0 the prefixed versions will be removed. Instead the attribute @AssignedBy will communicate the information previously communicated in the prefix.

Refer to SupplierCustomsReferenceType definition for any enumerations.

AssignedBy [attribute]

AssignedBy is optional. A single instance might exist.

Identifies the type of party or the agency that has assigned the associated item, e.g. a reference of type OrderNumber.

Refer to AssignedBy for any enumerations.

SupplierCustomsReferenceType [attribute]

Provides a contextual explanation of the specific reference identifier. Many items are currently prefixed by "Buyer", "Forwarder", "Manufacturer", "Mill", "Seller", "Supplier", "Warehouse", or "Vendor". Check for an existing non-prefixed version and use the non-prefixed version instead. In the (yet to be announced release date) version 3.0 the prefixed versions will be removed. Instead the attribute @AssignedBy will communicate the information previously communicated in the prefix.

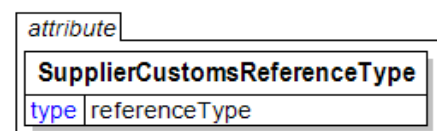

Refer to the [referenceType](#) entry for the list of enumerations and their definitions.

SupplierMarks

Supplier provided markings.

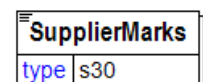

SupplierOrderLineItemNumber

The number of the line item on the supplier order.

SupplierOrderLineItemNumber	
type	lineNumberType

SupplierOrderNumber

The number of the supplier order.

SupplierOrderNumber	
type	s30

SupplierParty

The organisation or business entity responsible for providing the product. SupplierParty is also the seller of the product, if Seller is not specified as OtherParty = Seller.

LogisticsRole [attribute]

LogisticsRole is optional. A single instance might exist.

Communicates the nature of the logistics role, if any, the party plays in the transaction.

Refer to LogisticsRole definition for any enumerations.

(sequence)

The sequence of items below is mandatory. A single instance is required.

PartyIdentifier

PartyIdentifier is optional. Multiple instances might exist.

A unique identifier of a specific party. This element contains an attribute PartyIdentifierType that indicates the type of the identifier.

NameAddress

NameAddress is mandatory. A single instance is required.

A group item containing name and address of an organisation or business entity.

URL

URL is optional. A single instance might exist.

Universal Resource Locator. While typically a web address you could use this field to hold an email address.

CommonContact

CommonContact is optional. Multiple instances might exist.

Identifies a specific individual associated with the party.

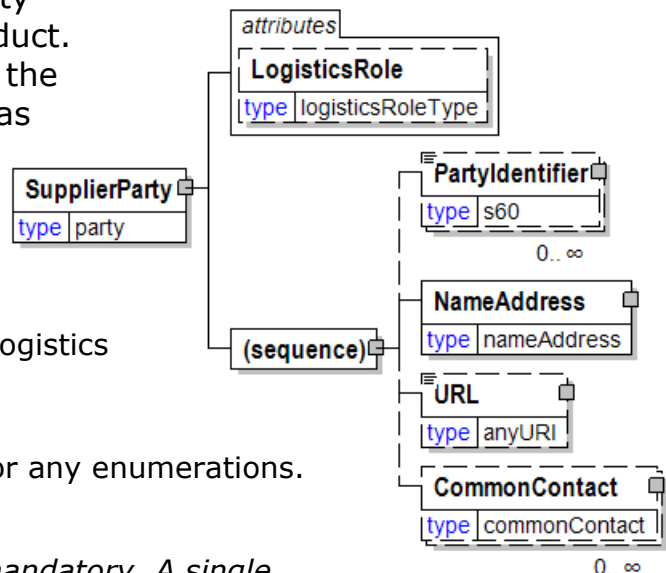

SupplyPoint

Grouping element that contains items describing a supply point. A SupplyPoint belongs to a LocationParty, e.g. in a DeliveryOrigin or DeliveryDestination, and describes where goods are stored and can be loaded or unloaded. A SupplyPoint can for example be a loading or unloading gate at a warehouse or a road side landing at a logging area in the forest.

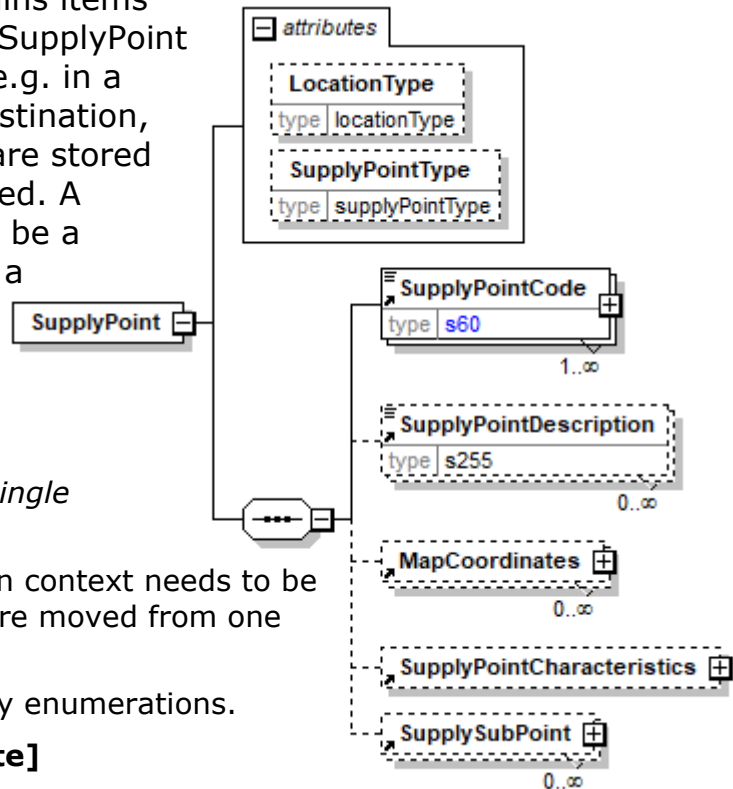

LocationType [attribute]

LocationType is optional. A single instance might exist.

Defines type of location when context needs to be specified, e.g. when goods are moved from one location to a new location.

Refer to LocationType for any enumerations.

SupplyPointType [attribute]

SupplyPointType is optional. A single instance might exist.

Defines type of location when context needs to be specified, e.g. when goods are moved from one location to a new location.

Refer to SupplyPointType for any enumerations.

(sequence)

The sequence of items below is mandatory. A single instance is required.

SupplyPointCode

SupplyPointCode is mandatory. One instance is required, multiple instances might exist.

Identification of the supply point. A code used to identify a SupplyPoint belonging to a LocationParty.

SupplyPointDescription

SupplyPointDescription is optional. Multiple instances might exist.

A free form description of a SupplyPoint.

MapCoordinates

MapCoordinates is optional. Multiple instances might exist.

A group item defining and containing position coordinates of a location.

SupplyPointCharacteristics

SupplyPointCharacteristics is optional. A single instance might exist.

A grouping element that provides information for a supply point.

SupplySubPoint

SupplySubPoint is optional. A single instance might exist.

A child element of SupplyPoint. A grouping element that contains items describing a supply point that is related to another SupplyPoint. It describes where goods are stored and can be loaded or unloaded.

Supply points can exist in a hierarchy and its level in the hierarchy is specified by the attribute SupplySubPointLevel.

SupplyPointCharacteristics

A grouping element that provides information for a supply point.

(sequence)

The sequence of items below is mandatory. A single instance is required.

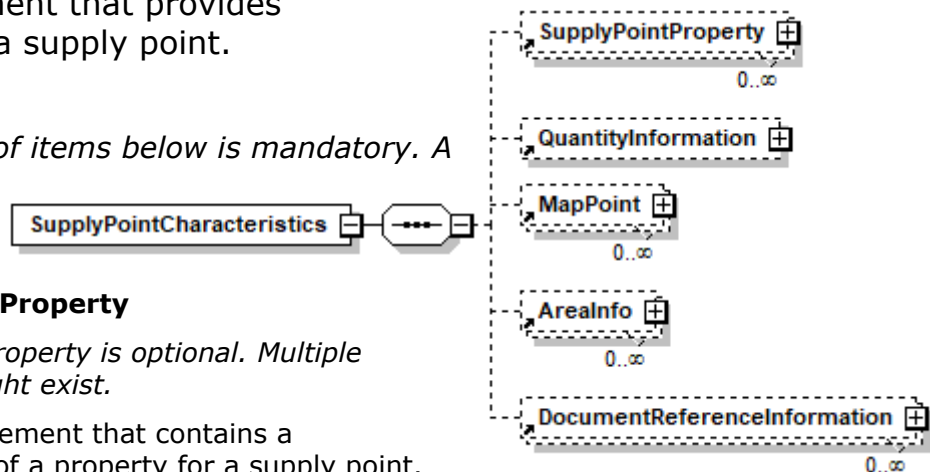

SupplyPointProperty

SupplyPointProperty is optional. Multiple instances might exist.

A grouping element that contains a specification of a property for a supply point.

QuantityInformation

QuantityInformation is optional. A single instance might exist.

A group item containing information about quantity and informational quantity of similar items.

MapPoint

MapPoint is optional. Multiple instances might exist.

A grouping element for items describing a point on a map. A mappoint is normally named waypoint in a GPS.

AreaInfo

AreaInfo is optional. Multiple instances might exist.

A grouping element that contains information about an area, e.g. an area belonging to a location.

DocumentReferenceInformation

DocumentReferenceInformation is optional. Multiple instances might exist.

A group item containing reference information applicable to a document.

SupplyPointCode

Identification of the supply point. A code used to identify a SupplyPoint belonging to a LocationParty.

Agency [attribute]

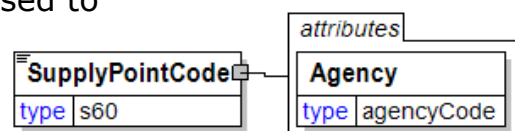

Agency is mandatory. A single instance is required.

Describes the agency maintaining the list of codes. To be included in this list the agency must be a recognized standards body or industry organisation.

- For the element that owns this attribute.
- For another attribute in the list of attributes associated with the parent element.

Refer to Agency definition for any enumerations.

SupplyPointDescription

A free form description of a SupplyPoint.

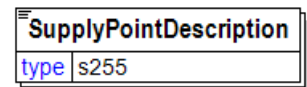

SupplyPointProperty

A grouping element that contains a specification of a property for a supply point.

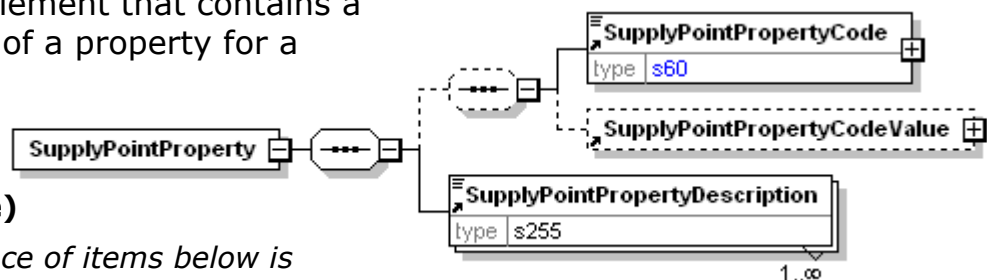

(sequence)

The sequence of items below is mandatory. A single instance is required.

(sequence)

The sequence of items below is optional. A single instance might exist.

SupplyPointPropertyCode

SupplyPointPropertyCode is mandatory. A single instance is required.

A code defining a property for a supply point.

SupplyPointPropertyCodeValue

SupplyPointPropertyCodeValue is optional. A single instance might exist.

A grouping element specifying a value belonging to a supply property code.

SupplyPointPropertyDescription

SupplyPointPropertyDescription is mandatory. One instance is required, multiple instances might exist.

A text description of a property for a supply point. When a SupplyPointPropertyCode is associated with a SupplyPointPropertyCodeValue of type TextValue, then the SupplyPointPropertyDescription is a textual description of both the SupplyPointPropertyCode and the TextValue.

SupplyPointPropertyCode

A code defining a property for a supply point.

Agency [attribute]

Agency is mandatory. A single instance is required.

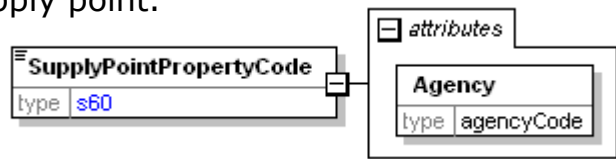

Describes the agency maintaining the list of codes. To be included in this list the agency must be a recognized standards body or industry organisation.

- For the element that owns this attribute.
- For another attribute in the list of attributes associated with the parent element.

Refer to Agency definition for any enumerations.

SupplyPointPropertyCodeValue

A grouping element specifying a value belonging to a supply property code.

(choice)

[choice] is mandatory.

A single instance is required.

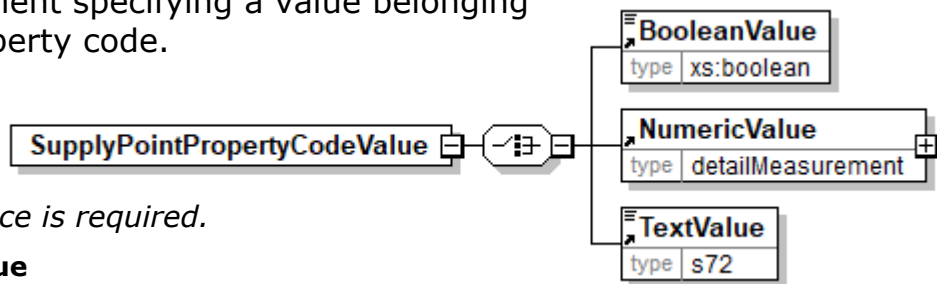

BooleanValue

BooleanValue is mandatory. A single instance is required.

A value in boolean format.

NumericValue

NumericValue is mandatory. A single instance is required.

A grouping element for a numeric value and its statistical measures.

TextValue

TextValue is mandatory. A single instance is required.

A value in text format.

SupplyPointPropertyDescription

A text description of a property for a supply point. When a SupplyPointPropertyCode is associated with a

SupplyPointPropertyCodeValue of type

TextValue, then the SupplyPointPropertyDescription is a textual description of both the SupplyPointPropertyCode and the TextValue.

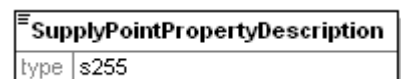

SupplyPointType [attribute]

Specifies the type of place associated with a SupplyPoint.

This item is restricted to the following list.

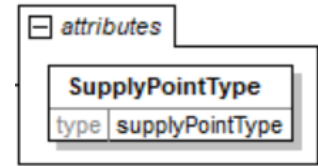

Gate

The place of the SupplyPoint is accessed through a gate. For example, a gate to a mill area.

RoadSideLanding

The place of the SupplyPoint is related to a logging area to which cut trees are brought to be loaded on transports.

StorageBlock

The place of the SupplyPoint is a storage area. For example, a storage block in a storage yard, roadside landing or a warehouse.

StorageSubBlock

The place of the SupplyPoint is a storage area within a storage block.

StorageYard

The place of the SupplyPoint is an open storage area.

Warehouse

The place of the SupplyPoint is a warehouse.

SupplySubPoint

A child element of SupplyPoint. A grouping element that contains items describing a supply point that is related to another SupplyPoint. It describes where goods are stored and can be loaded or unloaded.

Supply points can exist in a hierarchy and its level in the hierarchy is specified by the attribute SupplySubPointLevel.

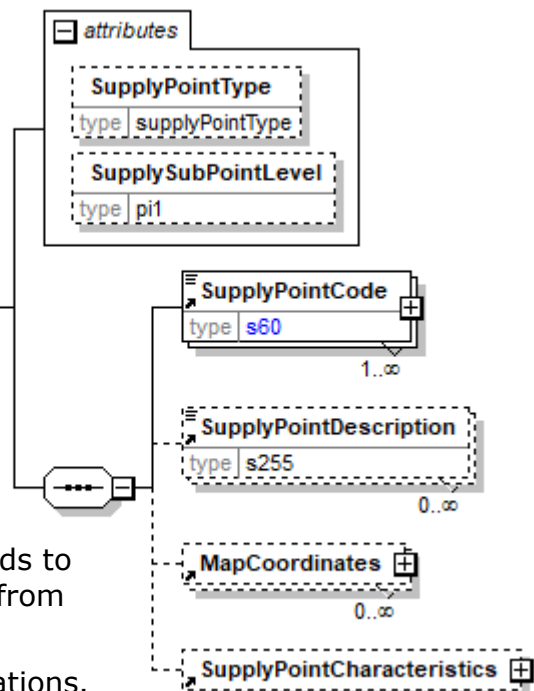
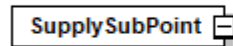

SupplyPointType [attribute]

SupplyPointType is optional. A single instance might exist.

Defines type of location when context needs to be specified, e.g. when goods are moved from one location to a new location.

Refer to SupplyPointType for any enumerations.

SupplySubPointLevel [attribute]

SupplySubPointLevel is optional. A single instance might exist.

papiNet V2R31

The positive sequential number that uniquely identifies the level of supply subpoints specified in a hierarchy. The highest level in the hierarchy is assigned number 1.

(sequence)

The sequence of items below is mandatory. A single instance is required.

SupplyPointCode

SupplyPointCode is mandatory. One instance is required, multiple instances might exist.

Identification of the supply point. A code used to identify a SupplyPoint belonging to a LocationParty.

SupplyPointDescription

SupplyPointDescription is optional. Multiple instances might exist.

A free form description of a SupplyPoint.

MapCoordinates

MapCoordinates is optional. Multiple instances might exist.

A group item defining and containing position coordinates of a location.

SupplyPointCharacteristics

SupplyPointCharacteristics is optional. A single instance might exist.

A grouping element that provides information for a supply point.

SupplySubPoint

SupplySubPoint is optional. A single instance might exist.

A child element of SupplyPoint. A grouping element that contains items describing a supply point that is related to another SupplyPoint. It describes where goods are stored and can be loaded or unloaded.

Supply points can exist in a hierarchy and its level in the hierarchy is specified by the attribute SupplySubPointLevel.

SupplySubPointLevel [attribute]

The positive sequential number that uniquely identifies the level of supply subpoints specified in a hierarchy. The highest level in the hierarchy is assigned number 1.

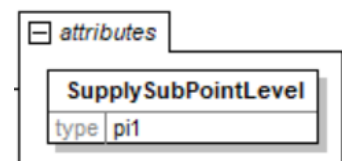

Surface

SurfaceType [attribute]

SurfaceType is optional. A single instance might exist.

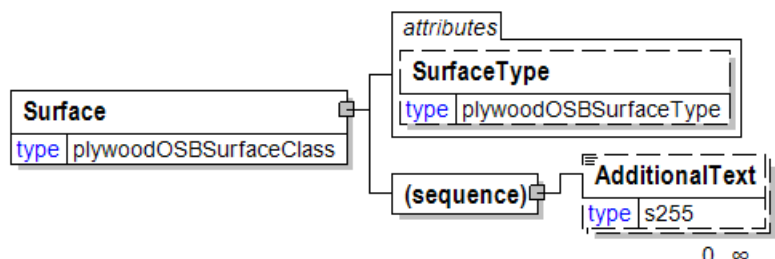

Refer to SurfaceType definition for any enumerations.

(sequence)

The sequence of items below is mandatory. A single instance is required.

AdditionalText

AdditionalText is optional. Multiple instances might exist.

A text field that is used to communicate information not previously defined or for special instructions. To be used only for circumstances not covered by specific elements.

SurfaceStrength

Surface Strength

TestMethod [attribute]

TestMethod is optional. A single instance might exist.

The method used to determine the results of the test under consideration.

TestAgency [attribute]

TestAgency is optional. A single instance might exist.

The agency that has set the parameters for the testing

Refer to TestAgency definition for any enumerations.

SampleType [attribute]

SampleType is optional. A single instance might exist.

Communicates how sampling was done to measure the product characteristics.

Refer to SampleType definition for any enumerations.

ResultSource [attribute]

ResultSource is optional. A single instance might exist.

Used to define the data source of the specified test

Refer to ResultSource definition for any enumerations.

(sequence)

The sequence of items below is mandatory. A single instance is required.

DetailValue

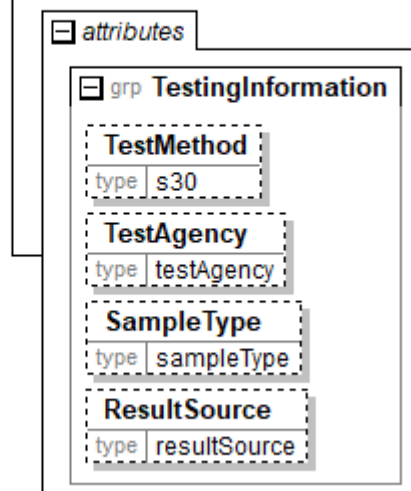
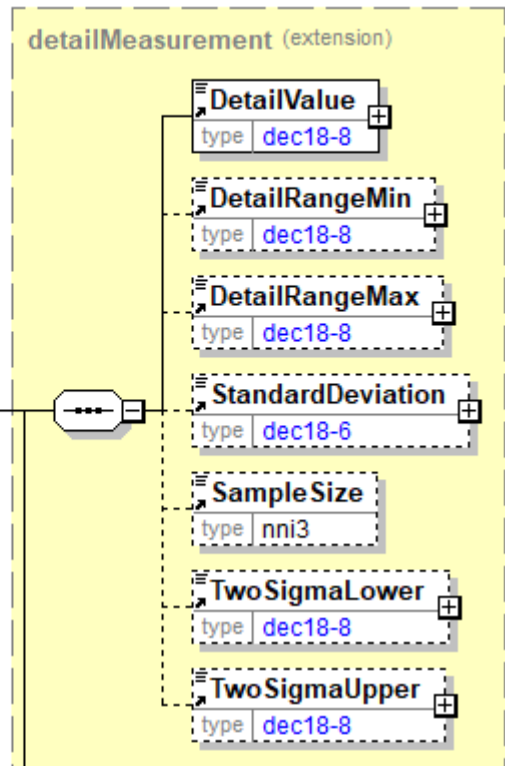
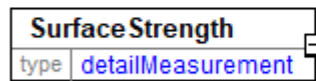

papiNet V2R31

DetailValue is mandatory. A single instance is required.

A numeric value expressed in the unit of measure (UOM).

DetailRangeMin

DetailRangeMin is optional. A single instance might exist.

The minimum value (lower boundary) allowed for the DetailValue that is the parent of this element.

DetailRangeMax

DetailRangeMax is optional. A single instance might exist.

The maximum value (upper boundary) allowed for the DetailValue that is the parent of this element.

StandardDeviation

StandardDeviation is optional. A single instance might exist.

A statistic used as a measure of dispersion in a distribution.

SampleSize

SampleSize is optional. A single instance might exist.

The number of samples used to determine the product characteristic in question.

TwoSigmaLower

TwoSigmaLower is optional. A single instance might exist.

Two sigma (a measure of dispersion associated with standard deviation) on the lower side of the standard deviation.

TwoSigmaUpper

TwoSigmaUpper is optional. A single instance might exist.

Two sigma (a measure of dispersion associated with standard deviation) on the upper side of the standard deviation.

SurfaceType [attribute]

This item is restricted to the following list.

Oiled

PluggedAndTouchSanded

Rough

RoughSawn

S1S

Side one sanded.

S2S

Side two sanded.

Sanded

ScratchSanded

Smooth

<i>attribute</i>
SurfaceType
<i>type</i> plywoodOSBSurfaceType

TouchSanded

Unsanded

Tabs [attribute]

The type of tabs

This item is restricted to the following list.

In

Out

None

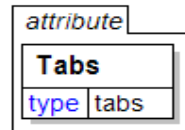

TambourID

The unique identifier of the jumbo reel (also called mother reel or Tambour).

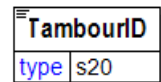

TapeDescription

Tape description

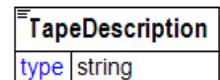

TargetMoisture

The moisture target for the product being specified.

(sequence)

The sequence of items below is mandatory. A single instance is required.

Value

Value is mandatory. A single instance is required.

A numeric value expressed in the unit of measure (UOM).

RangeMin

RangeMin is optional. A single instance might exist.

The minimum value (lower boundary) allowed for the Measurement that is the parent of this element.

RangeMax

RangeMax is optional. A single instance might exist.

The maximum value (upper boundary) allowed for the Measurement that is the parent of this element. Some elements use the RangeMax element with an extended list of unit of measures. (Note: the red colour in the picture is an artifact of how the graphic was captured and should be disregarded.)

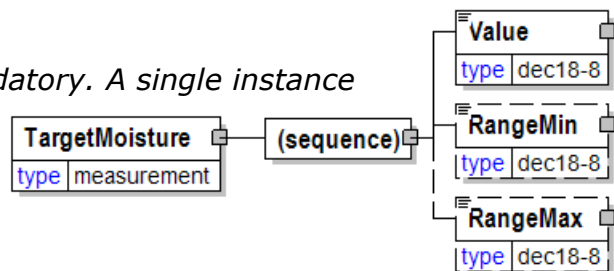

TargetProductWeight

The desired weight of the finished product.

(sequence)

The sequence of items below is mandatory. A single instance is required.

Value

Value is mandatory. A single instance is required.

A numeric value expressed in the unit of measure (UOM).

RangeMin

RangeMin is optional. A single instance might exist.

The minimum value (lower boundary) allowed for the Measurement that is the parent of this element.

RangeMax

RangeMax is optional. A single instance might exist.

The maximum value (upper boundary) allowed for the Measurement that is the parent of this element. Some elements use the RangeMax element with an extended list of unit of measures. (Note: the red colour in the picture is an artifact of how the graphic was captured and should be disregarded.)

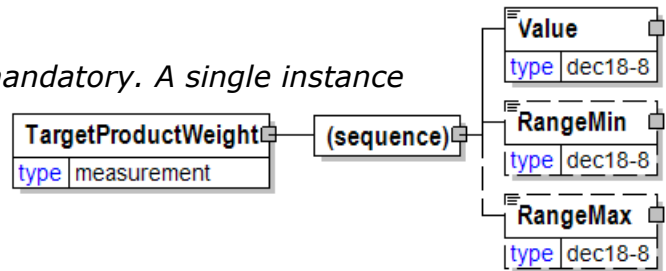

TargetSolidsContent

The target amount of solids for the slurry being produced.

(sequence)

The sequence of items below is mandatory. A single instance is required.

Value

Value is mandatory. A single instance is required.

A numeric value expressed in the unit of measure (UOM).

RangeMin

RangeMin is optional. A single instance might exist.

The minimum value (lower boundary) allowed for the Measurement that is the parent of this element.

RangeMax

RangeMax is optional. A single instance might exist.

The maximum value (upper boundary) allowed for the Measurement that is the parent of this element. Some elements use the RangeMax element with an extended list of unit of measures. (Note: the red colour in the picture is an artifact of how the graphic was captured and should be disregarded.)

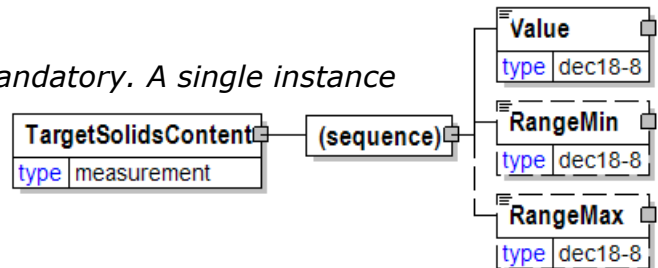

TaxAdjustment

This content element contains the necessary information to describe, calculate, and handle a tax adjustment.

TaxCategoryType [attribute]

TaxCategoryType is optional. A single instance might exist.

Used to indicate if the tax is applicable

Refer to TaxCategoryType definition for any enumerations.

TaxType [attribute]

TaxType is mandatory. A single instance is required.

Refer to TaxType definition for any enumerations.

(sequence)

The sequence of items below is mandatory. A single instance is required.

TaxPercent

TaxPercent is optional. A single instance might exist.

The fixed tax percentage to be applied according to specific tax regulations.

The fixed tax percentage to be applied according to specific tax regulations. If the TaxCategoryType is "Zero" and there is a non-zero value in this element, the e-Document can be rejected by the receiver.

TaxAmount

TaxAmount is optional. A single instance might exist.

The monetary amount expressed in the currency of the tax applied. For the MonetaryAdjustmentLine the TaxAmount is equal to the TaxPercent multiplied by the MonetaryAdjustmentStartAmount.

TaxLocation

TaxLocation is mandatory. A single instance is required.

The location used to determine the tax. Can be a country, state, province, or city. Depends on the tax type and on buyer or ship-to location.

InformationalAmount

InformationalAmount is optional. Multiple instances might exist.

A monetary amount used for information purposes only (not for calculation). For example, the invoice price adjustment subtotal is expressed in sterling pounds, and the buyer wants this information expressed in U.S. dollars.

CreditDebitNote and Invoice - The TaxAmount is displayed in the currency that is applicable throughout the e-Document. When a TaxAmount needs to be displayed in a different national currency, this field is used.

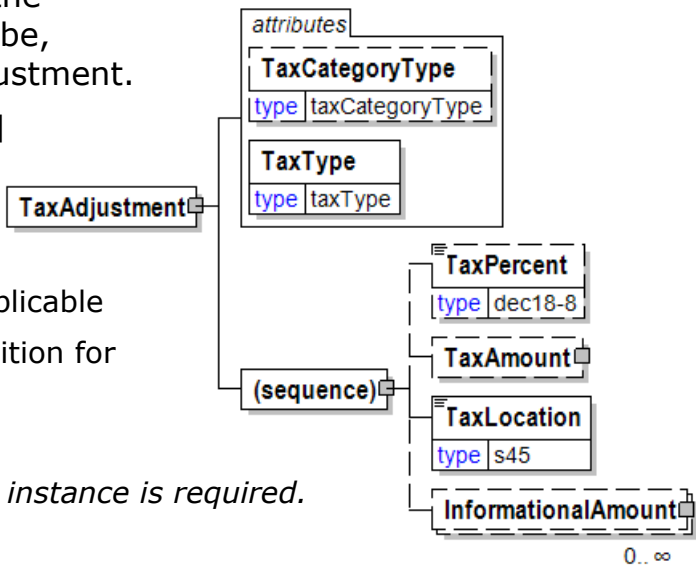

TaxAmount

The monetary amount expressed in the currency of the tax applied. For the MonetaryAdjustmentLine the TaxAmount is equal to the TaxPercent multiplied by the MonetaryAdjustmentStartAmount.

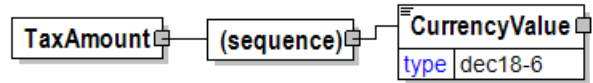

(sequence)

The sequence of items below is mandatory. A single instance is required.

CurrencyValue

CurrencyValue is mandatory. A single instance is required.

The amount in the referenced currency as defined by the CurrencyType attribute.

TaxCategoryType [attribute]

Used to indicate if the tax is applicable

This item is restricted to the following list.



Exempt

Used when the party or product in question is tax exempt. For example, an item would not be taxed on the invoice because the buyer is tax exempt. Note: In this case, the TaxIdentifier of that party must be given in the PartyIdentifierType.

Standard

The tax is applicable in a standard manner.

Zero

The tax related to a specific product is zero. This tax exemption is country specific. For example, newspapers are tax free in Belgium.

Other

Used for any other tax category that is not covered by this list.

TaxLocation

The location used to determine the tax. Can be a country, state, province, or city. Depends on the tax type and on buyer or ship-to location.

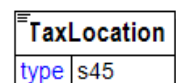

TaxPercent

The fixed tax percentage to be applied according to specific tax regulations.

The fixed tax percentage to be applied according to specific tax regulations. If the TaxCategoryType is "Zero" and there is a non-zero value in this element, the e-Document can be rejected by the

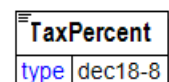

receiver.

TaxStatement

A group element for declaration of exception from normal charges of tax and the reason for tax exemption.

(sequence)

The sequence of items

below is mandatory. A single instance is required.

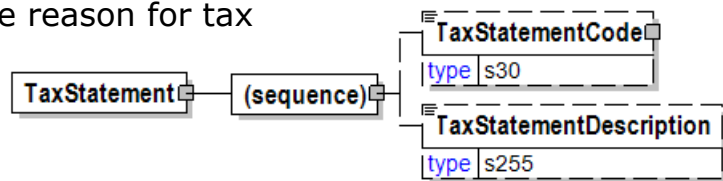

TaxStatementCode

TaxStatementCode is optional. A single instance might exist.

A code defining exception from normal charges of tax and the reason for tax exemption.

TaxStatementDescription

TaxStatementDescription is optional. A single instance might exist.

Free-form text used to define the reason for tax exemption.

TaxStatementCode

A code defining exception from normal charges of tax and the reason for tax exemption.

Agency [attribute]

Agency is mandatory. A single instance is required.

Describes the agency maintaining the list of codes. To be included in this list the agency must be a recognized standards body or industry organisation.

- For the element that owns this attribute.
- For another attribute in the list of attributes associated with the parent element.

Refer to Agency definition for any enumerations.

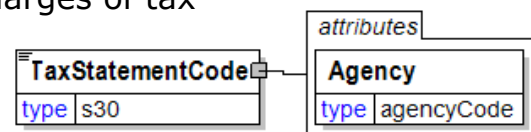

TaxStatementDescription

Free-form text used to define the reason for tax exemption.

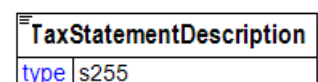

TaxType [attribute]

This item is restricted to the following list.

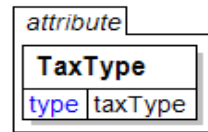

Federal

The federal government tax.

GST

The goods and services tax.

Harmonised

A group of taxes have been put together to form one tax rate. For example, Harmonised = provincial/state + federal.

Local

A local tax, such as a country-specific tax.

StateOrProvincial

The local government tax.

VAT

The value-added tax.

TEA

Tensile Energy Absorption.

TestMethod [attribute]

TestMethod is optional. A single instance might exist.

The method used to determine the results of the test under consideration.

TestAgency [attribute]

TestAgency is optional. A single instance might exist.

The agency that has set the parameters for the testing

Refer to TestAgency definition for any enumerations.

SampleType [attribute]

SampleType is optional. A single instance might exist.

Communicates how sampling was done to measure the product characteristics.

Refer to SampleType definition for any enumerations.

ResultSource [attribute]

ResultSource is optional. A single instance might exist.

Used to define the data source of the specified test

Refer to ResultSource definition for any enumerations.

(sequence)

The sequence of items below is mandatory. A single instance is required.

DetailValue

DetailValue is mandatory. A single instance is required.

A numeric value expressed in the unit of measure (UOM).

DetailRangeMin

DetailRangeMin is optional. A single instance might exist.

The minimum value (lower boundary) allowed for the DetailValue that is the parent of this element.

DetailRangeMax

DetailRangeMax is optional. A single instance might exist.

The maximum value (upper boundary) allowed for the DetailValue that is the

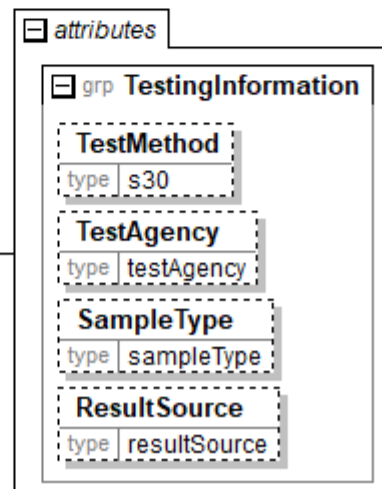
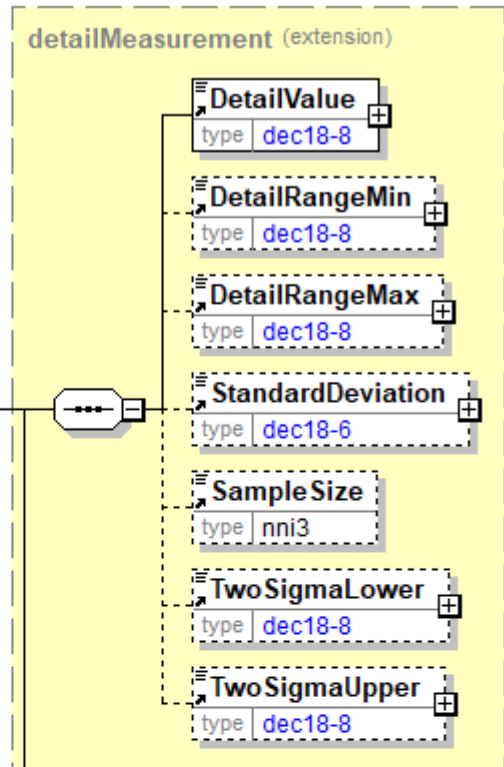

parent of this element.

StandardDeviation

StandardDeviation is optional. A single instance might exist.

A statistic used as a measure of dispersion in a distribution.

SampleSize

SampleSize is optional. A single instance might exist.

The number of samples used to determine the product characteristic in question.

TwoSigmaLower

TwoSigmaLower is optional. A single instance might exist.

Two sigma (a measure of dispersion associated with standard deviation) on the lower side of the standard deviation.

TwoSigmaUpper

TwoSigmaUpper is optional. A single instance might exist.

Two sigma (a measure of dispersion associated with standard deviation) on the upper side of the standard deviation.

Tear

A group item used to communicate tearing resistance target or test value according to a particular TestMethod.

TestMethod [attribute]

TestMethod is optional. A single instance might exist.

The method used to determine the results of the test under consideration.

TestAgency [attribute]

TestAgency is optional. A single instance might exist.

The agency that has set the parameters for the testing

Refer to TestAgency definition for any enumerations.

SampleType [attribute]

SampleType is optional. A single instance might exist.

Communicates how sampling was done to measure the product characteristics.

Refer to SampleType definition for any enumerations.

ResultSource [attribute]

ResultSource is optional. A single instance might exist.

Used to define the data source of the specified test

Refer to ResultSource definition for any enumerations.

(sequence)

The sequence of items below is mandatory. A single instance is required.

DetailValue

DetailValue is mandatory. A single instance is required.

A numeric value expressed in the unit of measure (UOM).

DetailRangeMin

DetailRangeMin is optional. A single instance might exist.

The minimum value (lower boundary) allowed for the DetailValue that is the parent of this element.

DetailRangeMax

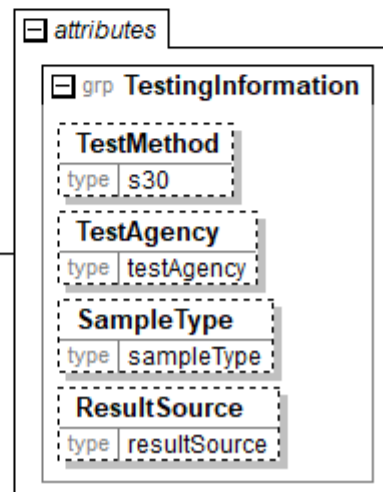
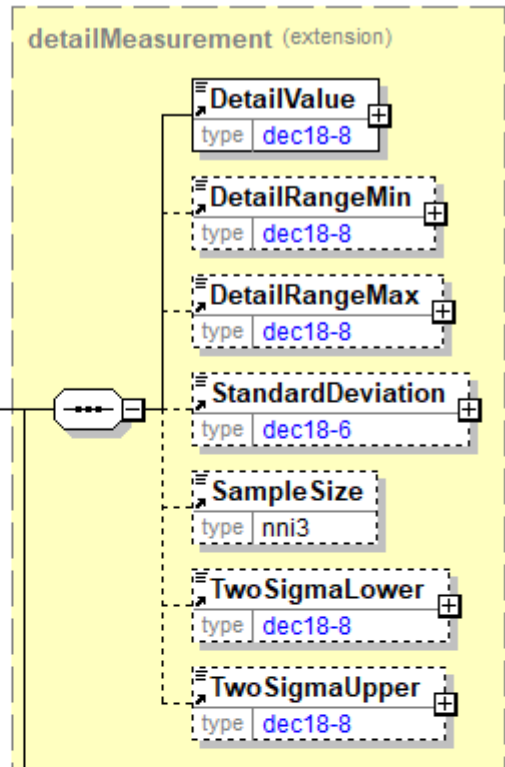

DetailRangeMax is optional. A single instance might exist.

The maximum value (upper boundary) allowed for the DetailValue that is the parent of this element.

StandardDeviation

StandardDeviation is optional. A single instance might exist.

A statistic used as a measure of dispersion in a distribution.

SampleSize

SampleSize is optional. A single instance might exist.

The number of samples used to determine the product characteristic in question.

TwoSigmaLower

TwoSigmaLower is optional. A single instance might exist.

Two sigma (a measure of dispersion associated with standard deviation) on the lower side of the standard deviation.

TwoSigmaUpper

TwoSigmaUpper is optional. A single instance might exist.

Two sigma (a measure of dispersion associated with standard deviation) on the upper side of the standard deviation.

TearIndex

TearIndex

TestMethod [attribute]

TestMethod is optional. A single instance might exist.

The method used to determine the results of the test under consideration.

TestAgency [attribute]

TestAgency is optional. A single instance might exist.

The agency that has set the parameters for the testing

Refer to TestAgency definition for any enumerations.

SampleType [attribute]

SampleType is optional. A single instance might exist.

Communicates how sampling was done to measure the product characteristics.

Refer to SampleType definition for any enumerations.

ResultSource [attribute]

ResultSource is optional. A single instance might exist.

Used to define the data source of the specified test

Refer to ResultSource definition for any enumerations.

(sequence)

The sequence of items below is mandatory. A single instance is required.

DetailValue

DetailValue is mandatory. A single instance is required.

A numeric value expressed in the unit of measure (UOM).

DetailRangeMin

DetailRangeMin is optional. A single instance might exist.

The minimum value (lower boundary) allowed for the DetailValue that is the parent of this element.

DetailRangeMax

DetailRangeMax is optional. A single instance might exist.

The maximum value (upper boundary) allowed for the DetailValue that is the

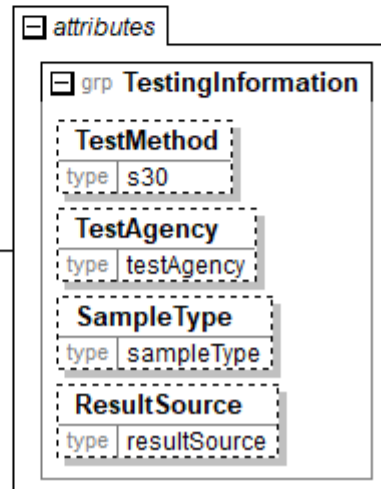
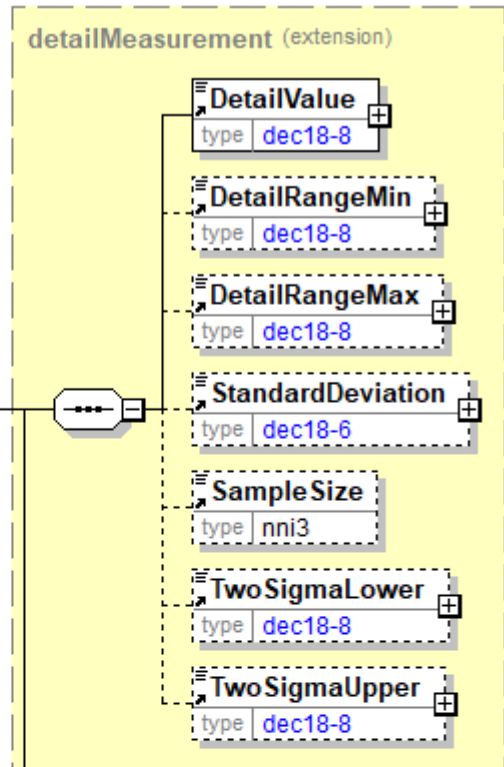
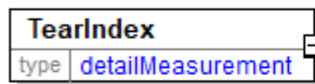

parent of this element.

StandardDeviation

StandardDeviation is optional. A single instance might exist.

A statistic used as a measure of dispersion in a distribution.

SampleSize

SampleSize is optional. A single instance might exist.

The number of samples used to determine the product characteristic in question.

TwoSigmaLower

TwoSigmaLower is optional. A single instance might exist.

Two sigma (a measure of dispersion associated with standard deviation) on the lower side of the standard deviation.

TwoSigmaUpper

TwoSigmaUpper is optional. A single instance might exist.

Two sigma (a measure of dispersion associated with standard deviation) on the upper side of the standard deviation.

TearStripType [attribute]

Tear Strip Type

This item is restricted to the following list.

Clear

The tear strip is clear.

Gold

The tear strip is gold coloured.

Red

The tear strip is red coloured.

Other

Another colour is used.

attribute
TearStripType
type tearStripType

Telephone

The business phone number of the individual associated with the ContactName.

Telephone
type phoneNumber

Tensile

A group item used to communicate zero-span tensile strength target or test value according to a particular TestMethod.

TestMethod [attribute]

TestMethod is optional. A single instance might exist.

The method used to determine the results of the test under consideration.

TestAgency [attribute]

TestAgency is optional. A single instance might exist.

The agency that has set the parameters for the testing

Refer to TestAgency definition for any enumerations.

SampleType [attribute]

SampleType is optional. A single instance might exist.

Communicates how sampling was done to measure the product characteristics.

Refer to SampleType definition for any enumerations.

ResultSource [attribute]

ResultSource is optional. A single instance might exist.

Used to define the data source of the specified test

Refer to ResultSource definition for any enumerations.

(sequence)

The sequence of items below is mandatory. A single instance is required.

DetailValue

DetailValue is mandatory. A single instance is required.

A numeric value expressed in the unit of measure (UOM).

DetailRangeMin

DetailRangeMin is optional. A single instance might exist.

The minimum value (lower boundary) allowed for the DetailValue that is the parent of this element.

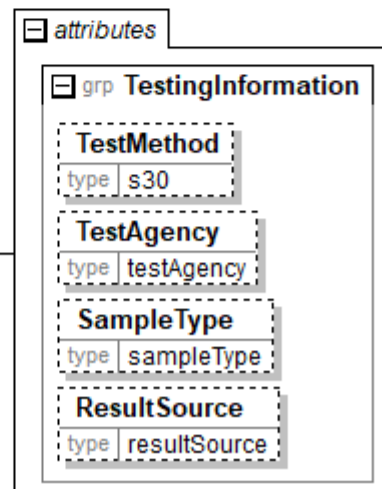
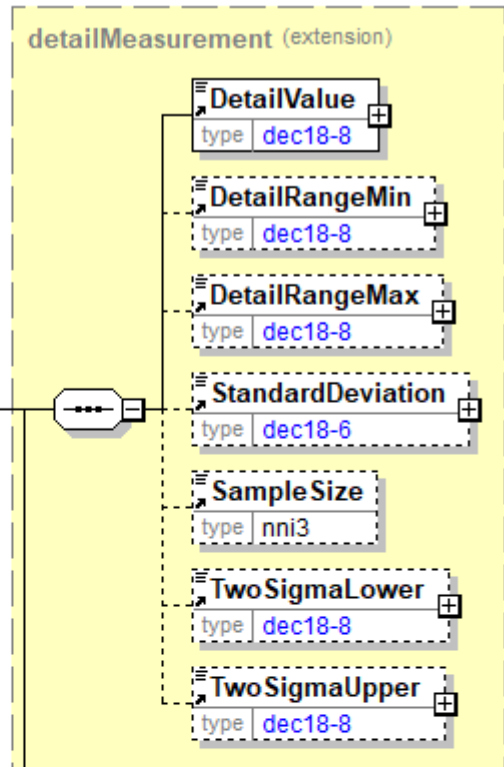

DetailRangeMax

DetailRangeMax is optional. A single instance might exist.

The maximum value (upper boundary) allowed for the DetailValue that is the parent of this element.

StandardDeviation

StandardDeviation is optional. A single instance might exist.

A statistic used as a measure of dispersion in a distribution.

SampleSize

SampleSize is optional. A single instance might exist.

The number of samples used to determine the product characteristic in question.

TwoSigmaLower

TwoSigmaLower is optional. A single instance might exist.

Two sigma (a measure of dispersion associated with standard deviation) on the lower side of the standard deviation.

TwoSigmaUpper

TwoSigmaUpper is optional. A single instance might exist.

Two sigma (a measure of dispersion associated with standard deviation) on the upper side of the standard deviation.

TensileIndex

Tensile Index

TestMethod [attribute]

TestMethod is optional. A single instance might exist.

The method used to determine the results of the test under consideration.

TestAgency [attribute]

TestAgency is optional. A single instance might exist.

The agency that has set the parameters for the testing

Refer to TestAgency definition for any enumerations.

SampleType [attribute]

SampleType is optional. A single instance might exist.

Communicates how sampling was done to measure the product characteristics.

Refer to SampleType definition for any enumerations.

ResultSource [attribute]

ResultSource is optional. A single instance might exist.

Used to define the data source of the specified test

Refer to ResultSource definition for any enumerations.

(sequence)

The sequence of items below is mandatory. A single instance is required.

DetailValue

DetailValue is mandatory. A single instance is required.

A numeric value expressed in the unit of measure (UOM).

DetailRangeMin

DetailRangeMin is optional. A single instance might exist.

The minimum value (lower boundary) allowed for the DetailValue that is the parent of this element.

DetailRangeMax

DetailRangeMax is optional. A single instance might exist.

The maximum value (upper boundary) allowed for the DetailValue that is the

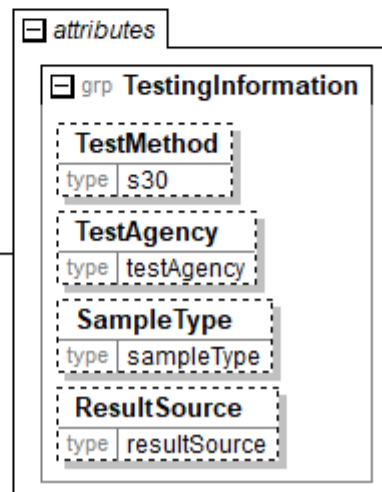
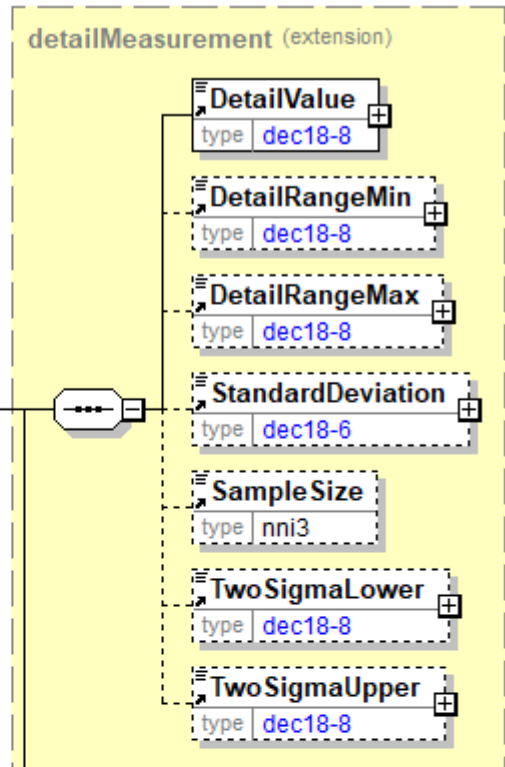

papiNet V2R31

parent of this element.

StandardDeviation

StandardDeviation is optional. A single instance might exist.

A statistic used as a measure of dispersion in a distribution.

SampleSize

SampleSize is optional. A single instance might exist.

The number of samples used to determine the product characteristic in question.

TwoSigmaLower

TwoSigmaLower is optional. A single instance might exist.

Two sigma (a measure of dispersion associated with standard deviation) on the lower side of the standard deviation.

TwoSigmaUpper

TwoSigmaUpper is optional. A single instance might exist.

Two sigma (a measure of dispersion associated with standard deviation) on the upper side of the standard deviation.

Tension

Tension of the web on the printing press.

(sequence)

The sequence of items below is mandatory. A single instance is required.

Value

Value is mandatory. A single instance is required.

A numeric value expressed in the unit of measure (UOM).

RangeMin

RangeMin is optional. A single instance might exist.

The minimum value (lower boundary) allowed for the Measurement that is the parent of this element.

RangeMax

RangeMax is optional. A single instance might exist.

The maximum value (upper boundary) allowed for the Measurement that is the parent of this element. Some elements use the RangeMax element with an extended list of unit of measures. (Note: the red colour in the picture is an artifact of how the graphic was captured and should be disregarded.)

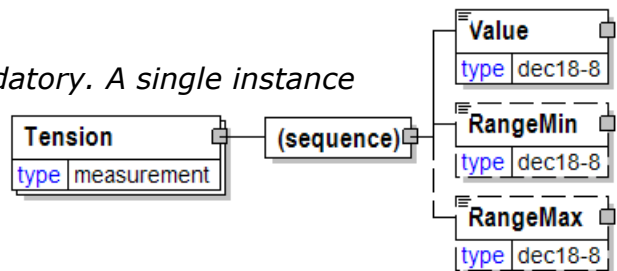

TermsAndDisclaimers

An element that contains legal information with an indication of what the Language is.

Language [attribute]

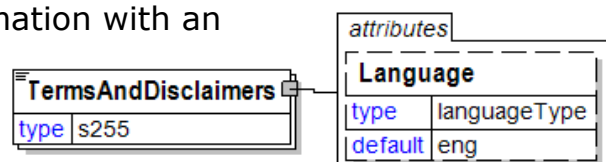

papiNet V2R31

Language is optional. A single instance might exist.

The valid Alpha 2- and Alpha 3-character list of language codes in the ISO 639-1 and 639-2 international standards.

Information on the content of this attribute is available at:
https://www.loc.gov/standards/iso639-2/php/code_list.php

TermsBasisDate

The Date and Time on which the terms-of-payment calculations are based.

(sequence)

The sequence of items below is mandatory. A single instance is required.

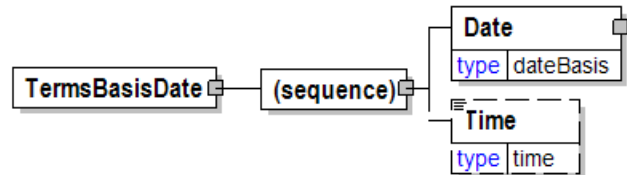

Date

Date is mandatory. A single instance is required.

A group element that contains the specification of Year, Month, and Day.

Time

Time is optional. A single instance might exist.

Times are treated in a standard XML fashion with a special case used to indicate a generalized "local" time. The standard XML approach to time is hh:mm:ss, hh:mm:ssZ, or hh:mm:ss±hh:mm.

hh:mm:ss±hh:mm is used to represent a time with a time zone. The time zone is communicated as the number of hours offset from the Universal Time Coordinate (UTC), a.k.a. Greenwich Mean Time.

hh:mm:ssZ indicates the time at Zulu (another name for UTC).

hh:mm:ss or hh:mm indicates within papiNet the applicable local time where the associated event is taking place. Caution should be used when processing times of this nature as the papiNet approach may be in discord with other users of XML.

TermsBasisDateType [attribute]

Indicates what date is being used as the terms basis.

This item is restricted to the following list.

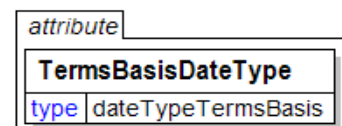

BillOfLadingDate

The date of the Bill of Lading.

DefferedOrInstallmentDate

The date of the installment.

DeliveryDate

The date the delivery was made or received.

DespatchDate

papiNet V2R31

The date the delivery was initiated.

EndOfDeliveryMonth

The end of the month during which delivery took place.

EndOfDespatchMonth

The end of the month during which despatch took place.

EndOfInvoiceMonth

The end of the month during which invoicing took place.

EndOfMonth

The end of the month.

EstimatedTimeOfArrival

Terms are based on the estimated time of arrival that exists when the terms are defined.

EstimatedTimeOfDeparture

Terms are based on the estimated time of departure.

ExtendedDate

FixedDate

The terms specify a fixed date.

FollowingMonthDate

InstantDate

InvoiceDate

A date that is qualifying the invoicing period. This date often drives payment terms. Note that this date is not necessarily the same as the issue date of the invoice.

InvoiceReceiptDate

The date the invoice was received.

InvoiceTransmissionDate

The date the invoice was transmitted.

LetterOfCreditExpirationDate

The date the letter of credit expires.

NnDaysAfterEndOfMonthDate

The date a fixed number of days after the end of the month.

OrderConfirmationDate

The date the PurchaseOrder was confirmed with a status of "Accepted".

ProxDate

Proximo Date

PurchaseOrderDate

The date of the PurchaseOrder.

ReceivedDate

The date product was received.

ShipDate

The date product was shipped.

TermsDescription

A textual description of the terms of payment.

TermsDescription	
type	s255

TermsDiscountDaysDue

The number of days during which the customer is allowed to deduct cash discounts from the date of TermsBasisDate.

TermsDiscountDaysDue	
type	nni3

TermsDiscountDueDate

The latest Date and Time on which the terms discount is still applicable.

(sequence)

The sequence of items below is mandatory. A single instance is required.

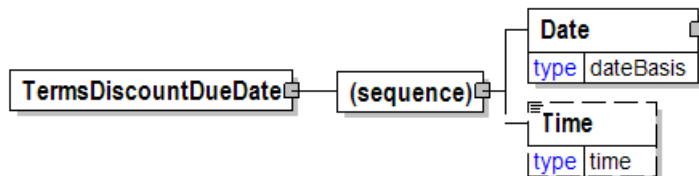

Date

Date is mandatory. A single instance is required.

A group element that contains the specification of Year, Month, and Day.

Time

Time is optional. A single instance might exist.

Times are treated in a standard XML fashion with a special case used to indicate a generalized "local" time. The standard XML approach to time is hh:mm:ss, hh:mm:ssZ, or hh:mm:ss±hh:mm.

hh:mm:ss±hh:mm is used to represent a time with a time zone. The time zone is communicated as the number of hours offset from the Universal Time Coordinate (UTC), a.k.a. Greenwich Mean Time.

hh:mm:ssZ indicates the time at Zulu (another name for UTC).

hh:mm:ss or hh:mm indicates within papiNet the applicable local time where the associated event is taking place. Caution should be used when processing times of this nature as the papiNet approach may be in discord with other users of XML.

TermsDiscountPercent

The percentage taken away from the invoice line items; a result of the terms of payment.

(sequence)

The sequence of items below is mandatory. A single instance is required.

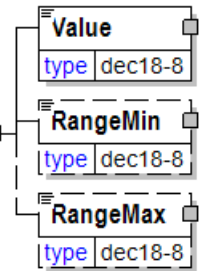
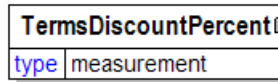

Value

Value is mandatory. A single instance is required.

A numeric value expressed in the unit of measure (UOM).

RangeMin

RangeMin is optional. A single instance might exist.

The minimum value (lower boundary) allowed for the Measurement that is the parent of this element.

RangeMax

RangeMax is optional. A single instance might exist.

The maximum value (upper boundary) allowed for the Measurement that is the parent of this element. Some elements use the RangeMax element with an extended list of unit of measures. (Note: the red colour in the picture is an artifact of how the graphic was captured and should be disregarded.)

TermsInformation

An element that contains the term related information.

(sequence)

The sequence of items below is mandatory. A single instance is required.

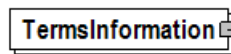

(sequence)

TermsOfPayment

TotalNetOfTermsDiscount

TermsOfPayment

TermsOfPayment is mandatory. A single instance is required.

A group item that contains agreed-to terms defining when, how, and under what conditions the payment is to be made.

When TermsOfPayment is optional; if omitted, TermsOfPayment is controlled through previous negotiation.

TotalNetOfTermsDiscount

TotalNetOfTermsDiscount is optional. A single instance might exist.

The components of the amount to be paid if prompt payment discount terms are met, including the amount that is subject to the payment terms discount, the discount amount, and the amount due after prompt payment discount.

TermsInterestPenaltyPercent

The penalty associated with not meeting the terms discount parameters.

TermsInterestPenaltyPercent	
type	dec18-6

TermsNetDaysDue

The number of days until the full invoice amount is due on the seller's account without a discount applied.

TermsNetDaysDue	
type	nni3

TermsNetDueDate

The latest Date and Time on which the full invoice amount is due on the seller's account without a discount applied.

(sequence)

The sequence of items below is mandatory. A single instance is required.

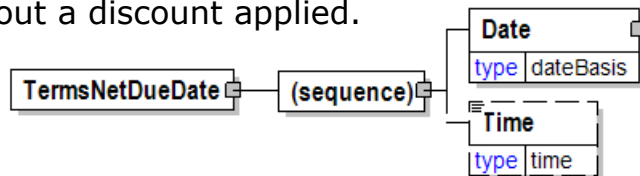

Date

Date is mandatory. A single instance is required.

A group element that contains the specification of Year, Month, and Day.

Time

Time is optional. A single instance might exist.

Times are treated in a standard XML fashion with a special case used to indicate a generalized "local" time. The standard XML approach to time is hh:mm:ss, hh:mm:ssZ, or hh:mm:ss±hh:mm.

hh:mm:ss±hh:mm is used to represent a time with a time zone. The time zone is communicated as the number of hours offset from the Universal Time Coordinate (UTC), a.k.a. Greenwich Mean Time.

hh:mm:ssZ indicates the time at Zulu (another name for UTC).

hh:mm:ss or hh:mm indicates within papiNet the applicable local time where the associated event is taking place. Caution should be used when processing times of this nature as the papiNet approach may be in discord with other users of XML.

TermsOfChartering

The terms of the vessel chartering. There are multiple types of TermsOfChartering that need to be specified. E.g.: Loading Terms and Unloading Terms

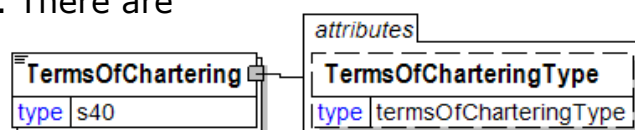

TermsOfCharteringType [attribute]

TermsOfCharteringType is optional. A single instance might exist.

Terms of chartering type.

Refer to TermsOfCharteringType definition for any enumerations.

TermsOfCharteringType [attribute]

Terms of chartering type.

This item is restricted to the following list.

Loading

The charter terms apply to loading.

Unloading

The charter terms apply to unloading.

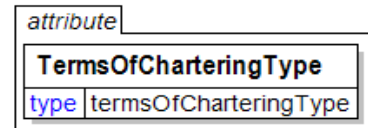

TermsOfDelivery

A group item defining the terms under which the delivery of goods will take place.

These terms determine when and under what conditions the transfer of ownership will occur. Generally speaking, the Incoterms are primarily

used in

Europe,

whereas the

ShipmentMethodOfPayment is

primarily used in North America.

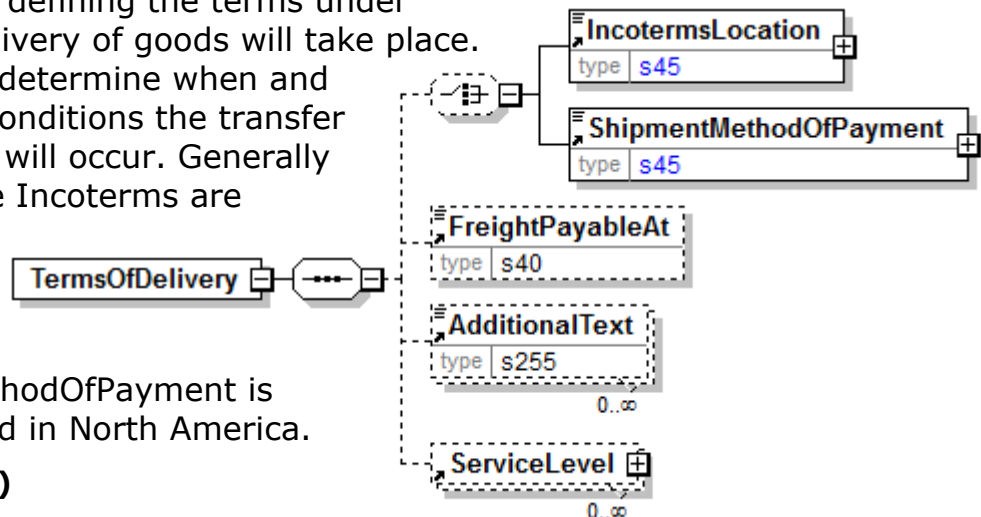

(sequence)

The sequence of items below is mandatory. A single instance is required.

(choice)

[choice] is optional. A single instance might exist.

IncotermsLocation

IncotermsLocation is mandatory. A single instance is required.

Named place linked to terms of delivery showing the place where goods are to be delivered.

ShipmentMethodOfPayment

ShipmentMethodOfPayment is mandatory. A single instance is required.

An element communicating responsibility of freight payment and when transfer of ownership will occur.

FreightPayableAt

FreightPayableAt is optional. A single instance might exist.

The location at which freight charges are calculated.

AdditionalText

AdditionalText is optional. Multiple instances might exist.

A text field that is used to communicate information not previously defined or for special instructions. To be used only for circumstances not covered by specific elements.

ServiceLevel

ServiceLevel is optional. Multiple instances might exist.

A grouping element containing information about a service level. The service level can be specified in a Service Level Agreement (SLA) detailing requirements such as delivery, performance, pricing, quality, etc.

TermsOfPayment

A group item that contains agreed-to terms defining when, how, and under what conditions the payment is to be made.

When TermsOfPayment is optional; if omitted, TermsOfPayment is controlled through previous negotiation.

TermsOfPayment

TermsBasisDateType [attribute]

TermsBasisDateType is optional. A single instance might exist.

Indicates what date is being used as the terms basis.

Refer to TermsBasisDateType definition for any enumerations.

(sequence)

The sequence of items below is mandatory. A single instance is required.

TermsOfPaymentCode

TermsOfPaymentCode is optional. A single instance might exist.

A code used as a shorthand representation for the TermsOfPayment. The Agency attribute is used to indicate the source of the code.

TermsDescription

TermsDescription is optional. A single instance might exist.

A textual description of the terms of payment.

TermsBasisDate

TermsBasisDate is optional. A single instance might exist.

The Date and Time on which the terms-of-payment calculations are based.

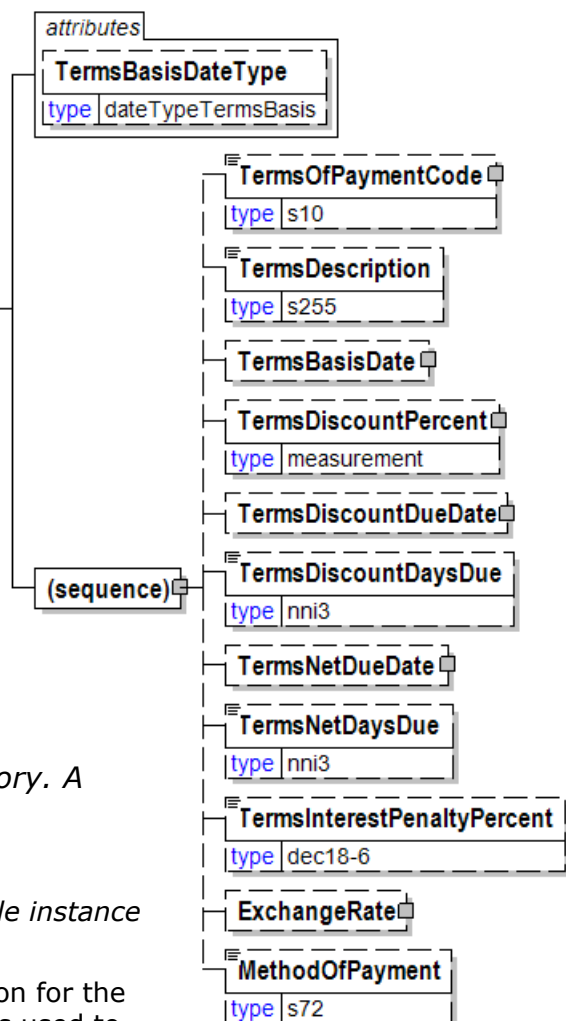

TermsDiscountPercent

TermsDiscountPercent is optional. A single instance might exist.

The percentage taken away from the invoice line items; a result of the terms of payment.

TermsDiscountDueDate

TermsDiscountDueDate is optional. A single instance might exist.

The latest Date and Time on which the terms discount is still applicable.

TermsDiscountDaysDue

TermsDiscountDaysDue is optional. A single instance might exist.

The number of days during which the customer is allowed to deduct cash discounts from the date of TermsBasisDate.

TermsNetDueDate

TermsNetDueDate is optional. A single instance might exist.

The latest Date and Time on which the full invoice amount is due on the seller's account without a discount applied.

TermsNetDaysDue

TermsNetDaysDue is optional. A single instance might exist.

The number of days until the full invoice amount is due on the seller's account without a discount applied.

TermsInterestPenaltyPercent

TermsInterestPenaltyPercent is optional. A single instance might exist.

The penalty associated with not meeting the terms discount parameters.

ExchangeRate

ExchangeRate is optional. A single instance might exist.

The exchange rate as of the date included in the element.

MethodOfPayment

MethodOfPayment is optional. A single instance might exist.

The manner in which payment is to be transmitted to the seller.

TermsOfPaymentCode

A code used as a shorthand representation for the TermsOfPayment. The Agency attribute is used to indicate the source of the code.

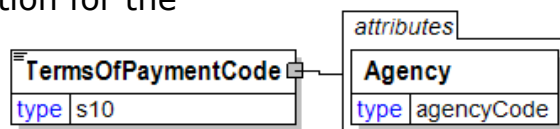

Agency [attribute]

Agency is mandatory. A single instance is required.

Describes the agency maintaining the list of codes. To be included in this list the agency must be a recognized standards body or industry organisation.

- For the element that owns this attribute.
- For another attribute in the list of attributes associated with the parent element.

Refer to Agency definition for any enumerations.

TestAgency [attribute]

The agency that has set the parameters for the testing

This item is restricted to the following list.

attribute
TestAgency
type testAgency

ASTM

ASTM International, known until 2001 as the American Society for Testing and Materials (ASTM), is an international standards organization that develops and publishes voluntary consensus technical standards for a wide range of materials, products, systems, and services. For example Winter Class diesel has to fulfil ASTM standards. (<http://www.astm.org>).

BS

British Standards.

To be deprecated in a future version V3R00, use instead BSI.

BSI

British Standards Institute (refer to bsi-global.com for more information).

Buyer

The buyer has defined the codes used in the particular element of the transaction. Care must be used when using this agency to assure that the recipient of the e-Document understands what is being communicated.

CEN

European Committee for Standardisation (<http://www.cen.eu>).

CIE

Vienna-based Commission Internationale de l'Eclairage.

DuPont

DuPont.

EN

European standards organisation.

To be deprecated in a future version V3R00, use instead CEN.

ForestForwarder

The party that transports forest wood products from logging areas to roadside landings.

ForestHarvester

The party that harvests forest wood products at logging areas.

ForestHub

An agency for Forest Wood Supply & Bioproducts industries.

GE

General Electric.

ImageXpert

ImageXpert.

ISO

International Organisation for Standardization.

KpDC

Agency maintaining codes for the Latvia wood supply segment.
(www.KpDC.lv).

NS-EN

Norwegian Standards, European Standards.

To be deprecated in a future version V3R00, use instead SN.

PAPTAC

Pulp and Paper Technical Association of Canada.

PWO

Agency for Pulpwood Online.

RVR

Agency maintaining codes for the German wood supply segment.

RVR is the abbreviation for "Rahmenvereinbarung für den Rohholzhandel in Deutschland".

(www.rvr-deutschland.de).

SCAN-test

SD

Agency maintaining codes for the Norwegian wood supply segment
(www.skogdata.no).

SDC

Agency maintaining codes for the Swedish wood supply segment
(www.biometria.se).

SFS

Finnish Standards Association.

SFS-EN

To be deprecated in a future version V3R00, use instead SFS.

Refer to www.sfs.fi/en for more information.

SIS

Swedish Standards Institute.

Refer to www.sis.se/en for more information.

SN

Standards Norway

Refer to www.standard.no/en for more information.

SS-EN

To be deprecated in a future version V3R00, use instead SIS.

Supplier

The supplier has defined the codes used in the particular element of the transaction. Care must be used when using this agency to assure that the recipient of the e-Document understands what is being communicated.

TAPPI

Technical Association for the Pulp and Paper Industry.

TestMethod [attribute]

The method used to determine the results of the test under consideration.

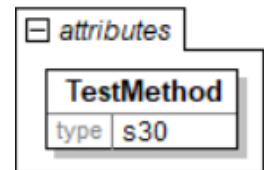

TextValue

A value in text format.

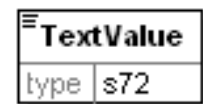

Thickness

Physical dimension of a product. The approach for thickness used in the timber/lumber related constructs.

ActualNominal [attribute]

ActualNominal is optional. A single instance might exist.

Indicates the

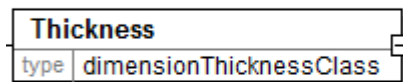

measurement approach used to communicate the dimensions of the individual pieces.

Refer to ActualNominal definition for any enumerations.

(choice)

[choice] is optional. A single instance might exist.

Value

Value is mandatory. A single instance is required.

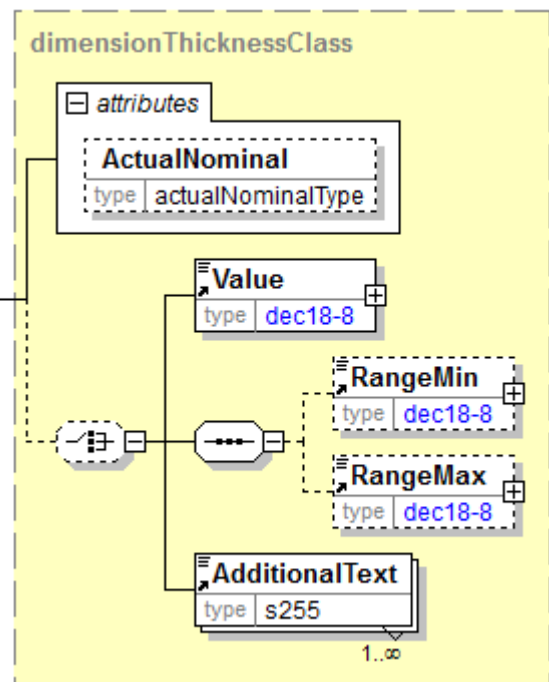

papiNet V2R31

A numeric value expressed in the unit of measure (UOM).

(sequence)

The sequence of items below is mandatory. A single instance is required.

RangeMin

RangeMin is optional. A single instance might exist.

The minimum value (lower boundary) allowed for the Measurement that is the parent of this element.

RangeMax

RangeMax is optional. A single instance might exist.

The maximum value (upper boundary) allowed for the Measurement that is the parent of this element. Some elements use the RangeMax element with an extended list of unit of measures. (Note: the red colour in the picture is an artifact of how the graphic was captured and should be disregarded.)

AdditionalText

AdditionalText is mandatory. One instance is required, multiple instances might exist.

A text field that is used to communicate information not previously defined or for special instructions. To be used only for circumstances not covered by specific elements.

Thickness

Physical dimension of a product.

(sequence)

The sequence of items below is mandatory. A single instance is required.

Value

Value is mandatory. A single instance is required.

A numeric value expressed in the unit of measure (UOM).

RangeMin

RangeMin is optional. A single instance might exist.

The minimum value (lower boundary) allowed for the Measurement that is the parent of this element.

RangeMax

RangeMax is optional. A single instance might exist.

The maximum value (upper boundary) allowed for the Measurement that is the parent of this element. Some elements use the RangeMax element with an extended list of unit of measures. (Note: the red colour in the picture is an artifact of how the graphic was captured and should be disregarded.)

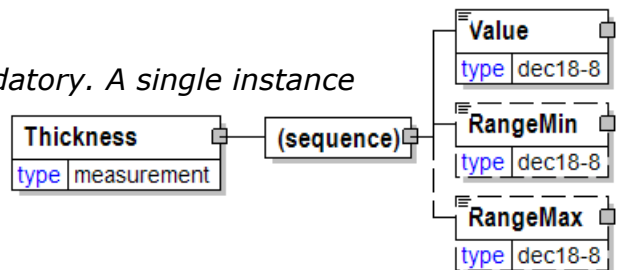

Thumb

Thumb.

Bleed [attribute]

Bleed is optional. A single instance might exist.

Specifies if the printing of an illustration, design, or text to the edge of the page.

Refer to Bleed definition for any enumerations.

(sequence)

The sequence of items below is mandatory. A single instance is required.

Value

Value is mandatory. A single instance is required.

A numeric value expressed in the unit of measure (UOM).

RangeMin

RangeMin is optional. A single instance might exist.

The minimum value (lower boundary) allowed for the Measurement that is the parent of this element.

RangeMax

RangeMax is optional. A single instance might exist.

The maximum value (upper boundary) allowed for the Measurement that is the parent of this element. Some elements use the RangeMax element with an extended list of unit of measures. (Note: the red colour in the picture is an artifact of how the graphic was captured and should be disregarded.)

AdditionalText

AdditionalText is optional. A single instance might exist.

A text field that is used to communicate information not previously defined or for special instructions. To be used only for circumstances not covered by specific elements.

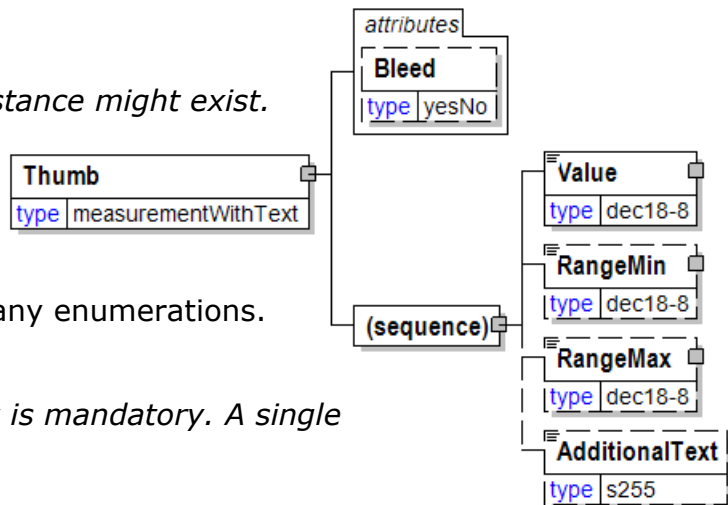

TiersPerPallet

The number of tiers on the pallet, where a tier is a layer of items.

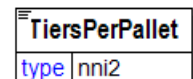

TimberCharacteristics

Timber characteristics

(sequence)

The sequence of items below is mandatory. A single instance is required.

LumberSpecies

LumberSpecies is mandatory. One instance is required, multiple instances might exist.

Specifies the raw material species.

Age

Age is optional. A single instance might exist.

Used to report the age of the wood.

Grade

Grade is optional. A single instance might exist.

Grade

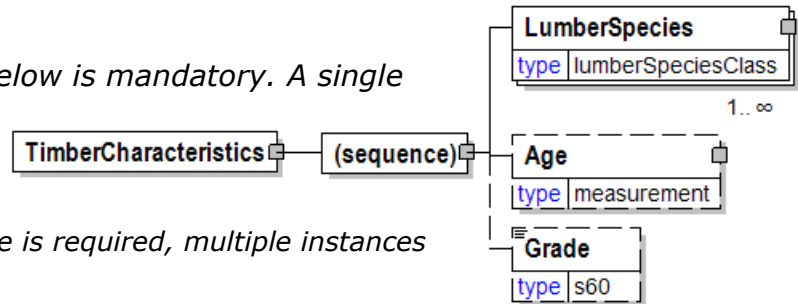

Time

Times are treated in a standard XML fashion with a special case used to indicate a generalized "local" time. The standard XML approach to time is hh:mm:ss, hh:mm:ssZ, or hh:mm:ss±hh:mm.

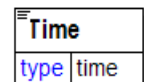

hh:mm:ss±hh:mm is used to represent a time with a time zone. The time zone is communicated as the number of hours offset from the Universal Time Coordinate (UTC), a.k.a. Greenwich Mean Time.

hh:mm:ssZ indicates the time at Zulu (another name for UTC).

hh:mm:ss or hh:mm indicates within papiNet the applicable local time where the associated event is taking place. Caution should be used when processing times of this nature as the papiNet approach may be in discord with other users of XML.

TimePeriod

The TimePeriod element is used to communicate a duration period of time as indicated in PeriodType.

PeriodType [attribute]

PeriodType is optional. A single instance might exist.

Duration of time

Refer to PeriodType definition for any enumerations.

(choice)

[choice] is mandatory. A single instance is required.

(sequence)

The sequence of items below is mandatory. A single instance is required.

Date

Date is mandatory. A single instance is required.

A group element that contains the specification of Year, Month, and Day.

Time

Time is optional. A single instance might exist.

Times are treated in a standard XML fashion with a special case used to indicate a generalized "local" time. The standard XML approach to time is hh:mm:ss, hh:mm:ssZ, or hh:mm:ss±hh:mm.

hh:mm:ss±hh:mm is used to represent a time with a time zone. The time zone is communicated as the number of hours offset from the Universal Time Coordinate (UTC), a.k.a. Greenwich Mean Time.

hh:mm:ssZ indicates the time at Zulu (another name for UTC).

hh:mm:ss or hh:mm indicates within papiNet the applicable local time where the associated event is taking place. Caution should be used when processing times of this nature as the papiNet approach may be in discord with other users of XML.

DateTimeRange

DateTimeRange is mandatory. A single instance is required.

Specifies a date and/or time range.

Week

Week is mandatory. A single instance is required.

A field defining the week number of the calendar year. ISO 8601 is used as the basis for this element, "Week 01 of a year is the first week that has the Thursday in this year, which is equivalent to the week that contains the fourth day of January." The ISO week starts on Monday. The ISO 8601 extended format of the week number is yyyy-Www, for example 2016-W51.

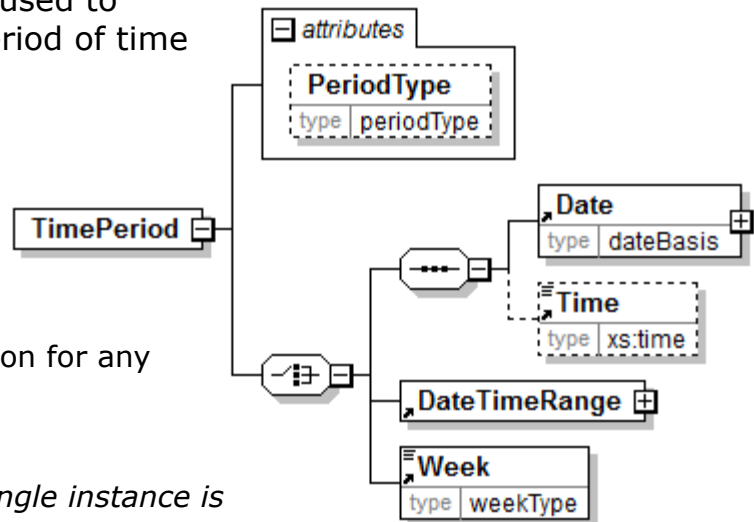

TimeSlot

A period of time during which an activity can be scheduled.

(sequence)

The sequence of items below is mandatory. A single instance is required.

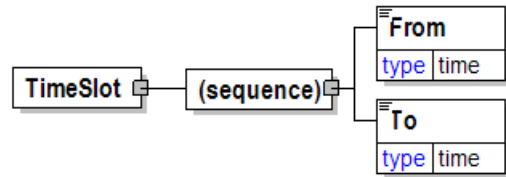

From

From is mandatory. A single instance is required.

The beginning point of a timeperiod.

To

To is mandatory. A single instance is required.

The ending point of a timeperiod.

TimeSlotAvailability [attribute]

Either "Yes" or "No".

This item is restricted to the following list.

Yes

No

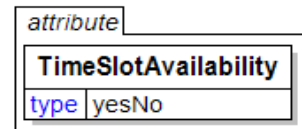

TimeSlotCharacteristics

A grouping element that provides information about a time slot.

(sequence)

The sequence of items below is mandatory. A single instance is required.

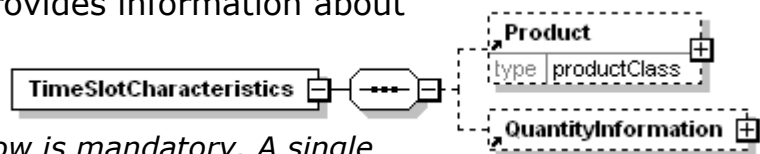

Product

Product is optional. A single instance might exist.

Product is a group item defining the article and its characteristics. Product is used to specify product characteristics organized by ProductIdentifier, ProductDescription, and Classification. Book Manufacturing, Label Stock, Paper, Pulp, Recovered Paper, Wood Products, and Virgin Fibre market segments have defined their product characteristics and conversion features for implementation in papiNet.

QuantityInformation

QuantityInformation is optional. A single instance might exist.

A group item containing information about quantity and informational quantity of similar items.

TimeSlotInformation

Description of the beginning and end of a time slot and the contingencies it contains.

TimeSlotAvailability [attribute]

TimeSlotAvailability is mandatory. A single instance is required.

Either "Yes" or "No".

Refer to TimeSlotAvailability definition for any enumerations.

(sequence)

The sequence of items below is mandatory. A single instance is required.

TimeSlot

TimeSlot is mandatory. A single instance is required.

A period of time during which an activity can be scheduled.

(choice)

The choice is optional. A single instance might exist.

TimeSlotCharacteristics

TimeSlotCharacteristics is mandatory. One instance is required, multiple instances might exist.

A grouping element that provides information about a time slot.

QuantityInformation

QuantityInformation is mandatory. One instance is required, multiple instances might exist.

A group item containing information about quantity and informational quantity of similar items.

AdditionalText

AdditionalText is optional. Multiple instances might exist.

A text field that is used to communicate information not previously defined or for special instructions. To be used only for circumstances not covered by specific elements.

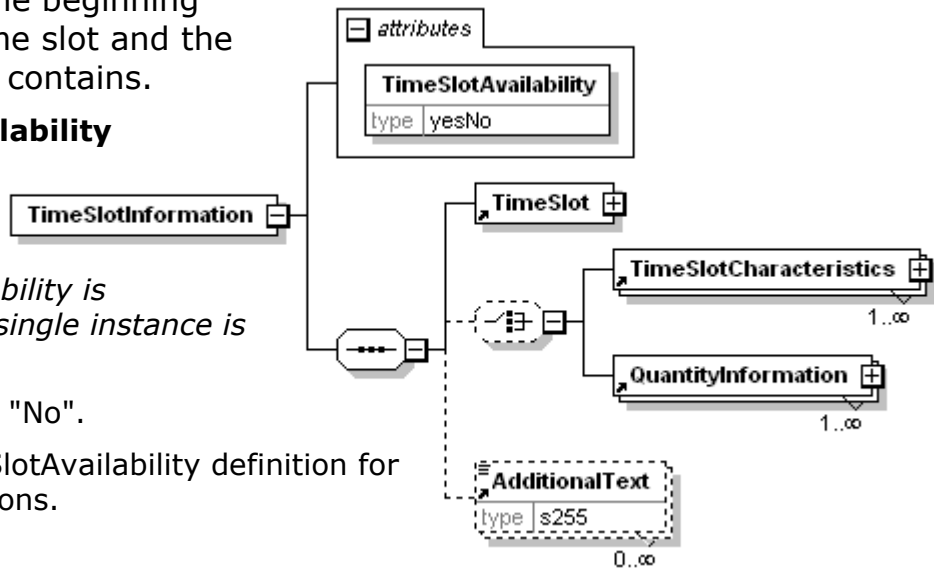

To

The ending point of a timeperiod.

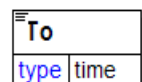

ToProduct

Defines to which product the item is downgraded.

(sequence)

The sequence of items below is mandatory. A single instance is required.

(sequence)

The sequence of items below is mandatory. One instance is required, multiple instances might exist.

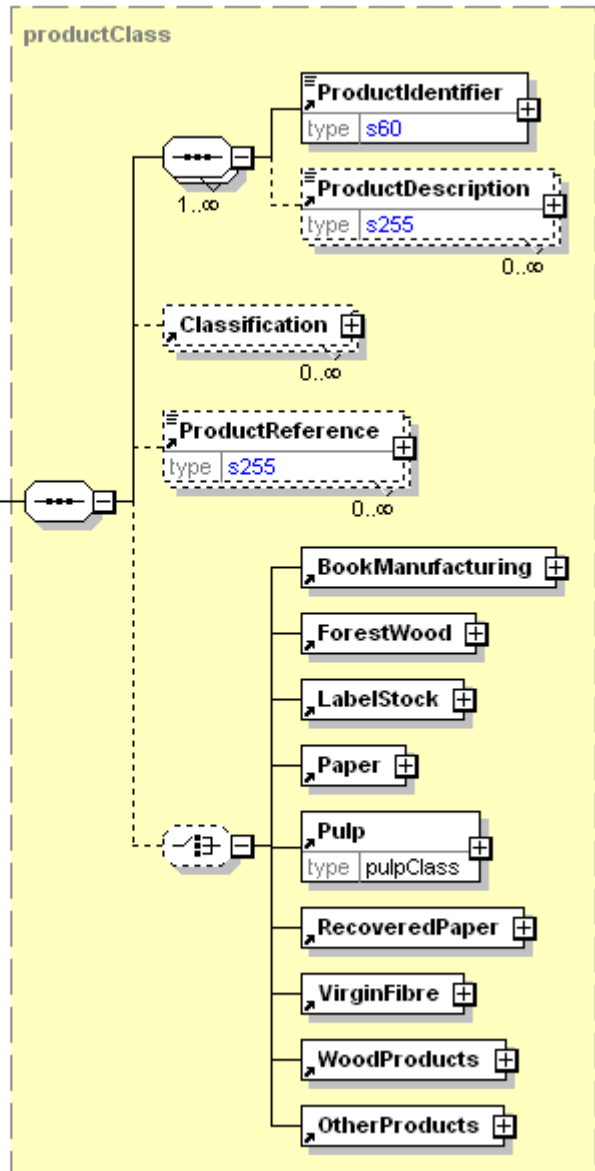
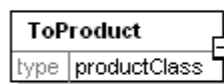

ProductIdentifier

ProductIdentifier is mandatory. A single instance is required.

Used to communicate the code of the article, in a variety of formats designated by the type.

ProductDescription

ProductDescription is optional. Multiple instances might exist.

An element used to communicate a human readable description of the product in the language specified by the Language attribute.

Classification

Classification is optional. A single instance might exist.

A group item that details the product classification according to a particular organization's scheme. An item across multiple classifications would still be recognized as the same item. Examples of some product classifications are: Containerboard, Pulp-Dissolving, or Newsprint.

(choice)

[choice] is optional because of choice construct.

BookManufacturing

BookManufacturing is mandatory. A single instance is required.

BookManufacturing is a group element that contains the elements that describe the book manufacturing process.

ForestWood

ForestWood is mandatory. A single instance is required.

A grouping element with information about characteristics for Forest Wood products.

papiNet V2R31

LabelStock

LabelStock is mandatory. A single instance is required.

LabelStock contains the attributes and characteristics that define the label stock product.

Paper

Paper is mandatory. A single instance is required.

A group item defining the characteristics of the paper product.

Pulp

Pulp is mandatory. A single instance is required.

A group item defining the characteristics of pulp that are not dependent on a particular conversion process.

RecoveredPaper

RecoveredPaper is mandatory. A single instance is required.

A group item defining the characteristics of recycled fibre that are not dependent on a particular conversion process.

VirginFibre

VirginFibre is mandatory. A single instance is required.

Virgin Fibre

WoodProducts

WoodProducts is mandatory. A single instance is required.

A grouping element for all wood products.

OtherProducts

OtherProducts is mandatory. A single instance is required.

A group item defining the characteristics of other products.

TopSide [attribute]

Either "Yes" or "No".

This item is restricted to the following list.

Yes

No

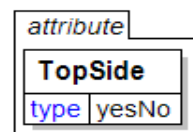

TotalAdjustments

The CurrencyValue of TotalAdjustments contains the total of all adjustments and charges excluding tax. For example, in the Invoice TotalAdjustments

is equal to the sum of the signed values of the MonetaryAdjustmentAmount for all instances of MonetaryAdjustment with PriceAdjustment and FlatAmountAdjustment and plus the sum of the signed values of the ChargeNetAmount for all instances of

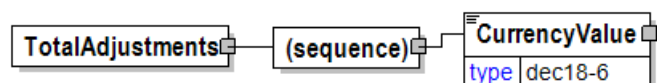

ChargeInformation.

(sequence)

The sequence of items below is mandatory. A single instance is required.

CurrencyValue

CurrencyValue is mandatory. A single instance is required.

The amount in the referenced currency as defined by the CurrencyType attribute.

TotalAmount

The total amount including tax (when tax is specified in the e-Document).

In e-Documents claiming payment this is the amount due for payment based on the terms of payment. Decimal rounding might be applied to this amount.

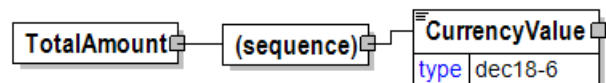

(sequence)

The sequence of items below is mandatory. A single instance is required.

CurrencyValue

CurrencyValue is mandatory. A single instance is required.

The amount in the referenced currency as defined by the CurrencyType attribute.

TotalBlanketOrderValue

The authorized amount of the blanket PurchaseOrder.

(sequence)

The sequence of items below is mandatory. A single instance is required.

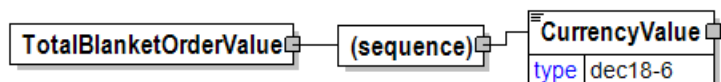

CurrencyValue

CurrencyValue is mandatory. A single instance is required.

The amount in the referenced currency as defined by the CurrencyType attribute.

TotalFASAmount

TotalFASAmount is the total Free Alongside Ship value.

(sequence)

The sequence of items below is mandatory. A single instance is required.

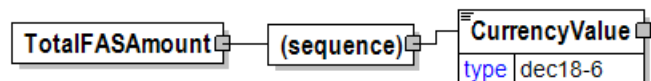

CurrencyValue

CurrencyValue is mandatory. A single instance is required.

The amount in the referenced currency as defined by the CurrencyType attribute.

TotalInformationalAmount

A monetary amount used for information purposes only (not for calculation). For example, the invoice price adjustment subtotal is expressed in sterling pounds, and the buyer wants this information expressed in U.S. dollars.

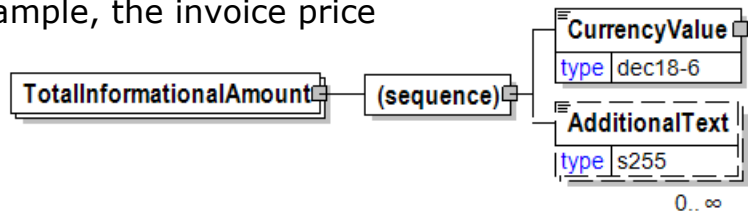

(sequence)

The sequence of items below is mandatory. A single instance is required.

CurrencyValue

CurrencyValue is mandatory. A single instance is required.

The amount in the referenced currency as defined by the CurrencyType attribute.

AdditionalText

AdditionalText is optional. Multiple instances might exist.

A text field that is used to communicate information not previously defined or for special instructions. To be used only for circumstances not covered by specific elements.

TotalInformationalQuantity

A quantity that is used to communicate related information about the parent element. This element represents a total that is derived from individual line items.

QuantityType [attribute]

QuantityType is mandatory. A single instance is required.

QuantityType communicates information about the type of quantity being communicated and how the receiver might use the information.

Refer to QuantityType definition for any enumerations.

QuantityTypeContext [attribute]

QuantityTypeContext is optional. A single instance might exist.

Provides the location in the value chain where the quantity is being reported.

Refer to QuantityTypeContext definition for any enumerations.

AdjustmentType [attribute]

AdjustmentType is optional. A single instance might exist.

Describes the type of adjustment associated with a quantity.

Refer to AdjustmentType definition for any enumerations.

MeasuringMethodType [attribute]

MeasuringMethodType is optional. A single instance might exist.

Specifies how a measurement value is created.

Refer to MeasuringMethodType definition for any enumerations.

MeasuringAgency [attribute]

MeasuringAgency is optional. A single instance might exist.

The agency defining measuring methods.

Refer to MeasuringAgency definition for any enumerations.

MeasuringMethod [attribute]

MeasuringMethod is optional. A single instance might exist.

The method used to determine how the item under consideration is measured. Measuring methods are defined by the measuring agency.

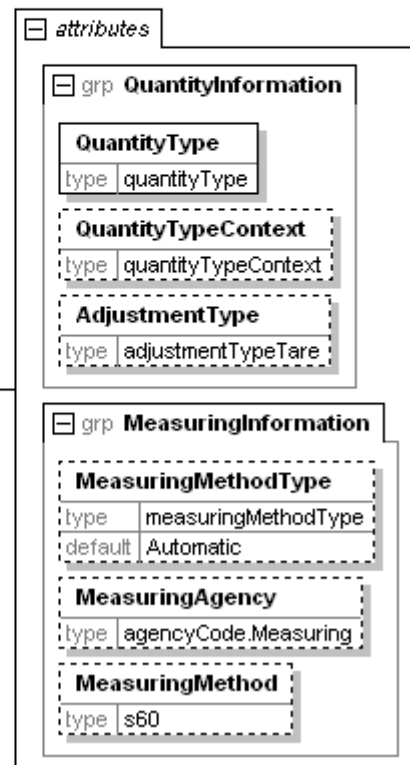
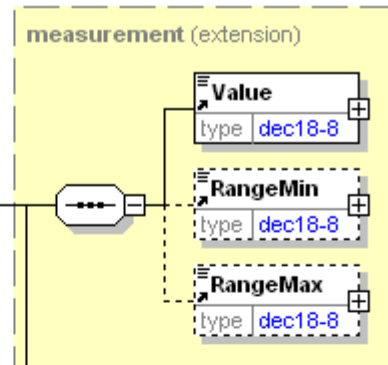

(sequence)

The sequence of items below is mandatory. A single instance is required.

Value

Value is mandatory. A single instance is required.

A numeric value expressed in the unit of measure (UOM).

RangeMin

RangeMin is optional. A single instance might exist.

The minimum value (lower boundary) allowed for the Measurement that is the parent of this element.

RangeMax

RangeMax is optional. A single instance might exist.

The maximum value (upper boundary) allowed for the Measurement that is the parent of this element. Some elements use the RangeMax element with an extended list of unit of measures. (Note: the red colour in the picture is an artifact of how the graphic was captured and should be disregarded.)

TotalNetAmount

A field containing total amount excluding tax. For example, in the Invoice TotalNetAmount is equal to the sum of LineItemSubTotal plus TotalAdjustments. TotalNetAmount encapsulates CurrencyValue.

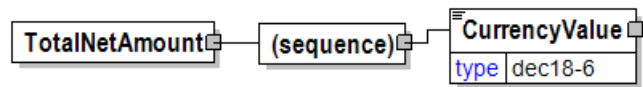

(sequence)

The sequence of items below is mandatory. A single instance is required.

CurrencyValue

CurrencyValue is mandatory. A single instance is required.

The amount in the referenced currency as defined by the CurrencyType attribute.

TotalNetOfTermsDiscount

The components of the amount to be paid if prompt payment discount terms are met, including the amount that is subject to the payment terms discount, the discount amount, and the amount due after prompt payment discount.

(sequence)

The sequence of items below is mandatory. A single instance is required.

AmountSubjectToTermsDiscount

AmountSubjectToTermsDiscount is mandatory. A single instance is required.

The amount against which prompt payment terms can be applied.

TotalTermsDiscountNetAmount

TotalTermsDiscountNetAmount is optional. A single instance might exist.

The total prompt payment discount amount excluding taxes.

TotalTermsDiscountNetAmountTax

TotalTermsDiscountNetAmountTax is optional. A single instance might exist.

Tax amount calculated for prompt payment discount amount

TotalTermsDiscountAmount

TotalTermsDiscountNetAmount is optional. A single instance might exist.

The total prompt payment discount amount including taxes.

TotalTermsDiscountNetAmountDue

TotalTermsDiscountNetAmountDue is optional. A single instance might exist.

The total amount due after prompt payment discount excluding taxes. Encapsulates CurrencyValue.

TotalTermsDiscountTaxAmount

TotalTermsDiscountTaxAmount is optional. A single instance might exist.

The total tax amount calculated after prompt payment discount.

TotalTermsDiscountAmountDue

TotalTermsDiscountAmountDue is mandatory. A single instance is required.

The total amount after prompt payment discount, includes the related taxes.

In e-Documents claiming payment this is the amount due for payment when prompt payment discount is used according to the terms of payment. Decimal rounding might be applied to this amount.

InformationalAmount

InformationalAmount is optional. Multiple instances might exist.

A monetary amount used for information purposes only (not for calculation). For example, the invoice price adjustment subtotal is expressed in sterling pounds, and the buyer wants this information expressed in U.S. dollars.

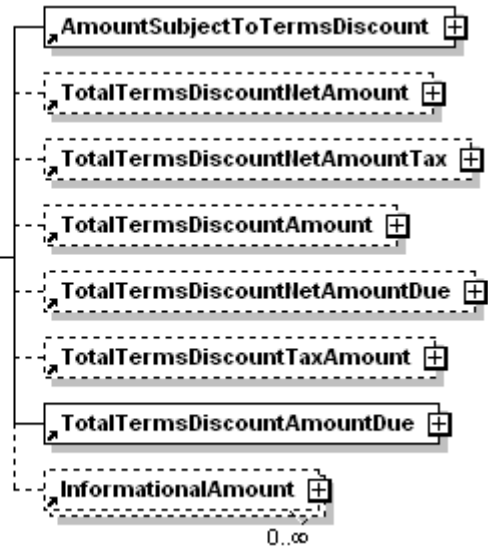

papiNet V2R31

CreditDebitNote and Invoice - The TaxAmount is displayed in the currency that is applicable throughout the e-Document. When a TaxAmount needs to be displayed in a different national currency, this field is used.

TotalNumberOfLineItems

The total number of individual line items in the document, regardless of the status or type.

TotalNumberOfLineItems	
type	nni4

TotalNumberOfPackingListItems

Total Number Of PackingList Items

TotalNumberOfPackingListItems	
type	nni3

TotalNumberOfPackingListPackingUnits

TotalNumberOfPackingListPackingUnits

TotalNumberOfPackingListPackingUnits	
type	nni3

TotalNumberOfSequences

The total number of sequences in the document.

TotalNumberOfSequences	
type	nni4

TotalNumberOfShipments

Total number of shipments referred to in a DeliveryMessage.

TotalNumberOfShipments	
type	nni4

TotalNumberOfUnits

The total number of units.

(sequence)

The sequence of items below is mandatory. A single instance is required.

Value

Value is mandatory. A single instance is required.

A numeric value expressed in the unit of measure (UOM).

RangeMin

RangeMin is optional. A single instance might exist.

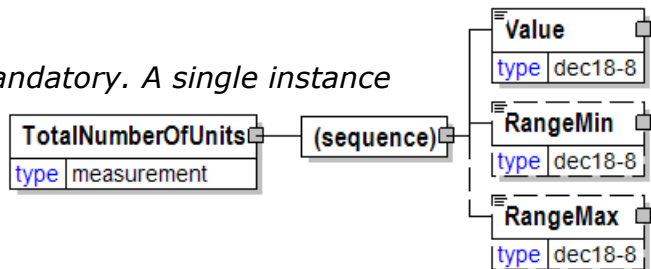

The minimum value (lower boundary) allowed for the Measurement that is the parent of this element.

RangeMax

RangeMax is optional. A single instance might exist.

The maximum value (upper boundary) allowed for the Measurement that is the parent of this element. Some elements use the RangeMax element with an extended list of unit of measures. (Note: the red colour in the picture is an artifact of how the graphic was captured and should be disregarded.)

TotalOldInformationalQuantity

A summary of the OldInformationQuantity in the document.

TotalOldInformationalQuantity uses the QuantityInformation attribute group and the Measurement group (element grouping).

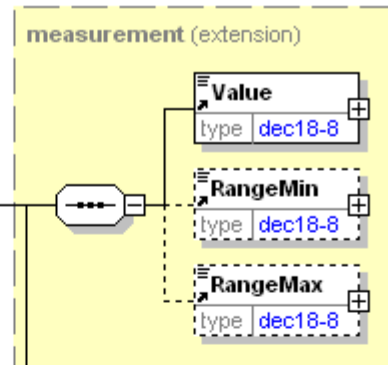

QuantityType [attribute]

QuantityType is mandatory. A single instance is required.

QuantityType communicates information about the type of quantity being communicated and how the receiver might use the information.

Refer to QuantityType definition for any enumerations.

QuantityTypeContext [attribute]

QuantityTypeContext is optional. A single instance might exist.

Provides the location in the value chain where the quantity is being reported.

Refer to QuantityTypeContext definition for any enumerations.

AdjustmentType [attribute]

AdjustmentType is optional. A single instance might exist.

Describes the type of adjustment associated with a quantity.

Refer to AdjustmentType definition for any enumerations.

MeasuringMethodType [attribute]

MeasuringMethodType is optional. A single instance might exist.

Specifies how a measurement value is created.

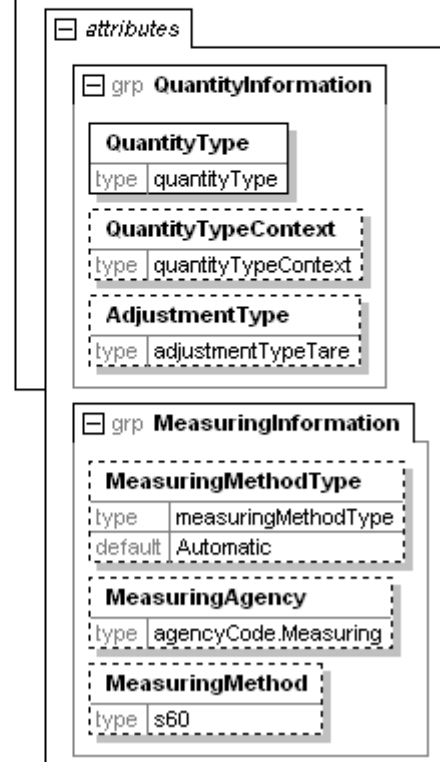

Refer to MeasuringMethodType definition for any enumerations.

MeasuringAgency [attribute]

MeasuringAgency is optional. A single instance might exist.

The agency defining measuring methods.

Refer to MeasuringAgency definition for any enumerations.

MeasuringMethod [attribute]

MeasuringMethod is optional. A single instance might exist.

The method used to determine how the item under consideration is measured. Measuring methods are defined by the measuring agency.

(sequence)

The sequence of items below is mandatory. A single instance is required.

Value

Value is mandatory. A single instance is required.

A numeric value expressed in the unit of measure (UOM).

RangeMin

RangeMin is optional. A single instance might exist.

The minimum value (lower boundary) allowed for the Measurement that is the parent of this element.

RangeMax

RangeMax is optional. A single instance might exist.

The maximum value (upper boundary) allowed for the Measurement that is the parent of this element. Some elements use the RangeMax element with an extended list of unit of measures. (Note: the red colour in the picture is an artifact of how the graphic was captured and should be disregarded.)

TotalOldQuantity

A summary of the OldQuantity in the document. TotalOldQuantity uses the QuantityInformation attribute group and the Measurement group (element grouping).

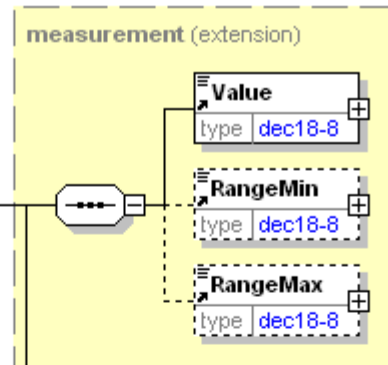
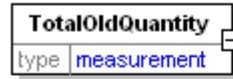

QuantityType [attribute]

QuantityType is mandatory. A single instance is required.

QuantityType communicates information about the type of quantity being communicated and how the receiver might use the information.

Refer to QuantityType definition for any enumerations.

QuantityTypeContext [attribute]

QuantityTypeContext is optional. A single instance might exist.

Provides the location in the value chain where the quantity is being reported.

Refer to QuantityTypeContext definition for any enumerations.

AdjustmentType [attribute]

AdjustmentType is optional. A single instance might exist.

Describes the type of adjustment associated with a quantity.

Refer to AdjustmentType definition for any enumerations.

MeasuringMethodType [attribute]

MeasuringMethodType is optional. A single instance might exist.

Specifies how a measurement value is created.

Refer to MeasuringMethodType definition for any enumerations.

MeasuringAgency [attribute]

MeasuringAgency is optional. A single instance might exist.

The agency defining measuring methods.

Refer to MeasuringAgency definition for any enumerations.

MeasuringMethod [attribute]

MeasuringMethod is optional. A single instance might exist.

The method used to determine how the item under consideration is measured. Measuring methods are defined by the measuring agency.

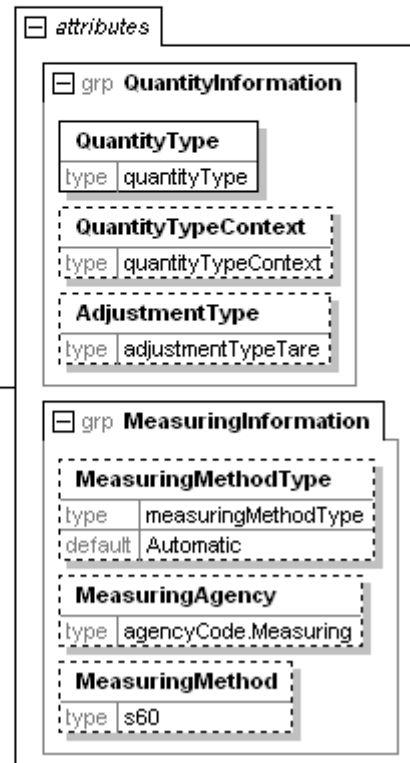

(sequence)

The sequence of items below is mandatory. A single instance is required.

Value

Value is mandatory. A single instance is required.

A numeric value expressed in the unit of measure (UOM).

RangeMin

RangeMin is optional. A single instance might exist.

The minimum value (lower boundary) allowed for the Measurement that is the parent of this element.

RangeMax

RangeMax is optional. A single instance might exist.

The maximum value (upper boundary) allowed for the Measurement that is the parent of this element. Some elements use the RangeMax element with an extended list of unit of measures. (Note: the red colour in the picture is an artifact of how the graphic was captured and should be disregarded.)

TotalOpenAmount

InvoiceAmount less the sum of all payment amounts, translated into one common currency.

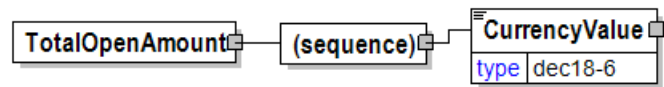

(sequence)

The sequence of items below is mandatory. A single instance is required.

CurrencyValue

CurrencyValue is mandatory. A single instance is required.

The amount in the referenced currency as defined by the CurrencyType attribute.

TotalPageCount

Element used to communicate the book's approximate total number of pages within each unit of the book. Total page count is more or less a reference to the "size" of the book that the customer designates. For instance, they will refer to a book as 800 pages when in fact it is 792 actual text pages with 8 pages of various inserts. This value should not be used to drive any of the other values for the component parts, but may in fact be exactly equal to the number of pages in one of the components designated as "Text".

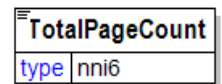

TotalPaymentAmount

The amounts which were paid and booked against the original invoice.

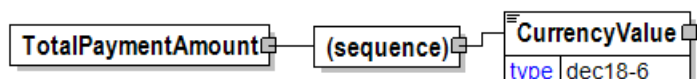

(sequence)

The sequence of items below is mandatory. A single

instance is required.

CurrencyValue

CurrencyValue is mandatory. A single instance is required.

The amount in the referenced currency as defined by the CurrencyType attribute.

TotalQuantity

The total quantity of similar items in the e-Document. TotalQuantity is primarily used in the summary section of documents where it is repeatable to permit totaling for different units of measure.

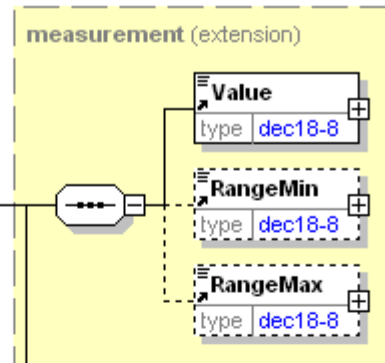
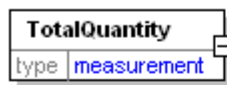

QuantityType [attribute]

QuantityType is mandatory. A single instance is required.

QuantityType communicates information about the type of quantity being communicated and how the receiver might use the information.

Refer to QuantityType definition for any enumerations.

QuantityTypeContext [attribute]

QuantityTypeContext is optional. A single instance might exist.

Provides the location in the value chain where the quantity is being reported.

Refer to QuantityTypeContext definition for any enumerations.

AdjustmentType [attribute]

AdjustmentType is optional. A single instance might exist.

Describes the type of adjustment associated with a quantity.

Refer to AdjustmentType definition for any enumerations.

MeasuringMethodType [attribute]

MeasuringMethodType is optional. A single instance might exist.

Specifies how a measurement value is created.

Refer to MeasuringMethodType definition for any enumerations.

MeasuringAgency [attribute]

MeasuringAgency is optional. A single instance might exist.

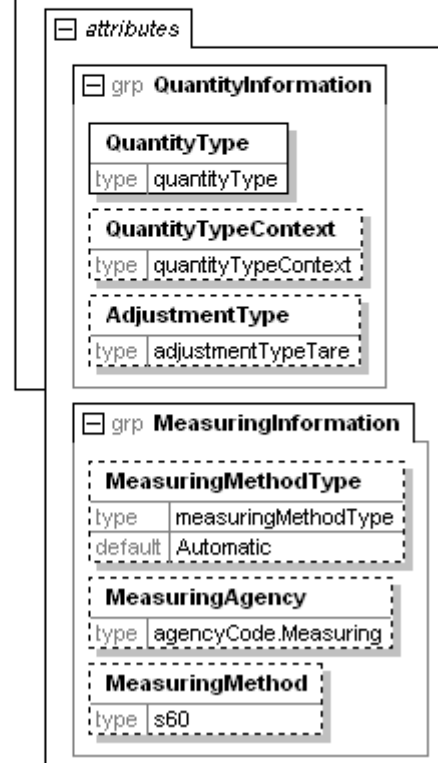

The agency defining measuring methods.

Refer to MeasuringAgency definition for any enumerations.

MeasuringMethod [attribute]

MeasuringMethod is optional. A single instance might exist.

The method used to determine how the item under consideration is measured. Measuring methods are defined by the measuring agency.

(sequence)

The sequence of items below is mandatory. A single instance is required.

Value

Value is mandatory. A single instance is required.

A numeric value expressed in the unit of measure (UOM).

RangeMin

RangeMin is optional. A single instance might exist.

The minimum value (lower boundary) allowed for the Measurement that is the parent of this element.

RangeMax

RangeMax is optional. A single instance might exist.

The maximum value (upper boundary) allowed for the Measurement that is the parent of this element. Some elements use the RangeMax element with an extended list of unit of measures. (Note: the red colour in the picture is an artifact of how the graphic was captured and should be disregarded.)

TotalQuantityInformation

A group item containing information about the total quantity and total informational quantity of similar items in the document.

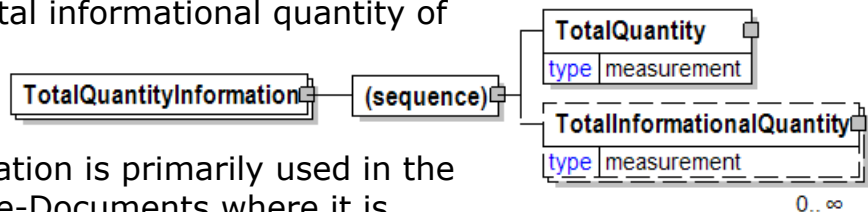

TotalQuantityInformation is primarily used in the summary section of e-Documents where it is repeatable to permit totalling for different units of measure.

(sequence)

The sequence of items below is mandatory. A single instance is required.

TotalQuantity

TotalQuantity is mandatory. A single instance is required.

The total quantity of similar items in the e-Documents. TotalQuantity is primarily used in the summary section of documents where it is repeatable to permit totalling for different units of measure.

TotalInformationalQuantity

TotalInformationalQuantity is optional. Multiple instances might exist.

A quantity that is used to communicate related information about the parent

element. This element represents a total that is derived from individual line items.

TotalRunningLength

Summary value of amount measured in running meters, etc.

QuantityType [attribute]

QuantityType is mandatory. A single instance is required.

QuantityType communicates information about the type of quantity being communicated and how the receiver might use the information.

Refer to QuantityType definition for any enumerations.

QuantityTypeContext [attribute]

QuantityTypeContext is optional. A single instance might exist.

Provides the location in the value chain where the quantity is being reported.

Refer to QuantityTypeContext definition for any enumerations.

AdjustmentType [attribute]

AdjustmentType is optional. A single instance might exist.

Describes the type of adjustment associated with a quantity.

Refer to AdjustmentType definition for any enumerations.

(sequence)

The sequence of items below is mandatory. A single instance is required.

Value

Value is mandatory. A single instance is required.

A numeric value expressed in the unit of measure (UOM).

RangeMin

RangeMin is optional. A single instance might exist.

The minimum value (lower boundary) allowed for the Measurement that is the parent of this element.

RangeMax

RangeMax is optional. A single instance might exist.

The maximum value (upper boundary) allowed for the Measurement that is the parent of this element. Some elements use the RangeMax element with an extended list of unit of measures. (Note: the red colour in the picture is an artifact of how the graphic was captured and should be disregarded.)

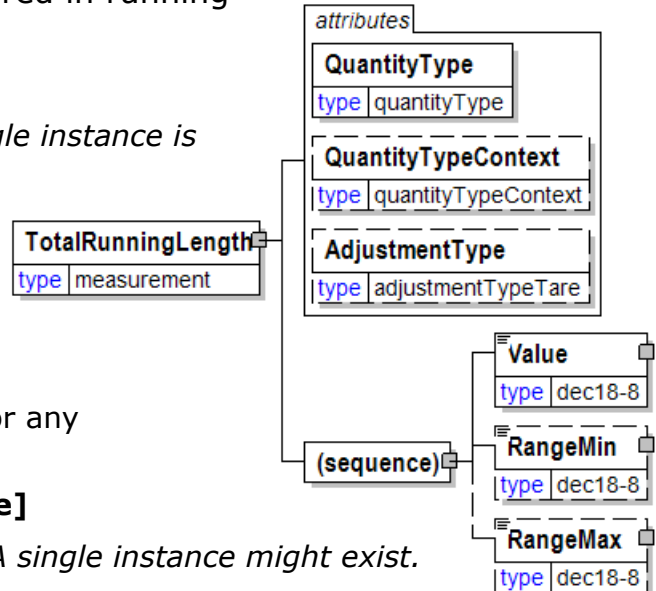

TotalSetNumbers

The total number of sets wound from the Tambour (in the radial direction). Tambour is also called jumbo reel or mother reel.

TotalSetNumbers	
type	nni4

TotalSetPositions

The total number of reels cut across the Tambour (in the width direction). Tambour is also called jumbo reel or mother reel.

TotalSetPositions	
type	nni4

TotalTaxAmount

The CurrencyValue of TotalTaxAmount contains the sum of all instances of TaxAdjustment in the document. TotalTaxAmount contains the sum of all instances of the MonetaryAdjustmentAmount for tax adjustments.

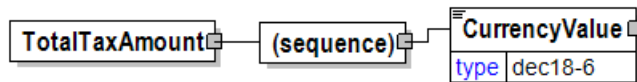

(sequence)

The sequence of items below is mandatory. A single instance is required.

CurrencyValue

CurrencyValue is mandatory. A single instance is required.

The amount in the referenced currency as defined by the CurrencyType attribute.

TotalTermsDiscountAmount

The total prompt payment discount amount including taxes.

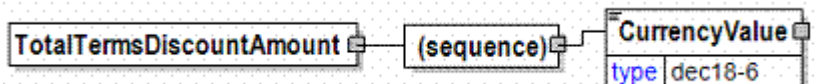

(sequence)

The sequence of items below is mandatory. A single instance is required.

CurrencyValue

CurrencyValue is mandatory. A single instance is required.

The amount in the referenced currency as defined by the CurrencyType attribute.

TotalTermsDiscountAmountDue

The total amount after prompt payment discount, includes the related taxes.

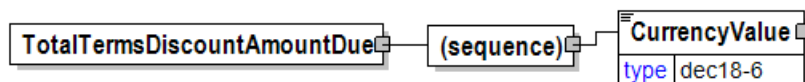

In e-Documents

claiming payment this is the amount due for payment when prompt payment discount is used according to the terms of payment. Decimal

rounding might be applied to this amount.

(sequence)

The sequence of items below is mandatory. A single instance is required.

CurrencyValue

CurrencyValue is mandatory. A single instance is required.

The amount in the referenced currency as defined by the CurrencyType attribute.

TotalTermsDiscountNetAmount

The total prompt payment discount amount excluding taxes.

(sequence)

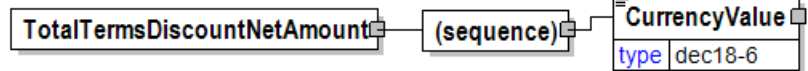

The sequence of items below is mandatory. A single instance is required.

CurrencyValue

CurrencyValue is mandatory. A single instance is required.

The amount in the referenced currency as defined by the CurrencyType attribute.

TotalTermsDiscountNetAmountDue

The total amount due after prompt payment discount excluding taxes.

Encapsulates CurrencyValue.

(sequence)

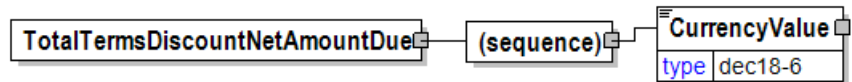

The sequence of items below is mandatory. A single instance is required.

CurrencyValue

CurrencyValue is mandatory. A single instance is required.

The amount in the referenced currency as defined by the CurrencyType attribute.

TotalTermsDiscountNetAmountTax

Tax amount calculated for prompt payment discount amount.

(sequence)

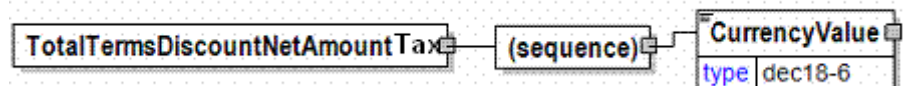

The sequence of items below is mandatory. A single instance is required.

CurrencyValue

CurrencyValue is mandatory. A single instance is required.

The amount in the referenced currency as defined by the CurrencyType attribute.

TotalTermsDiscountTaxAmount

The total tax amount calculated after prompt payment discount.

(sequence)

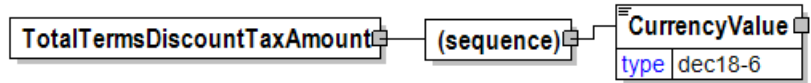

The sequence of items below is mandatory. A single instance is required.

CurrencyValue

CurrencyValue is mandatory. A single instance is required.

The amount in the referenced currency as defined by the CurrencyType attribute.

TotalTime

The total time.

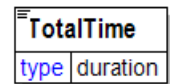

TrackingReferenceID

A grouping element that defines tracking references between items processed in the supply chain.

TrackingReferenceIDType [attribute]

TrackingReferenceIDType is mandatory. A single instance is required.

Defines the type of relationship the actual item has to other the tracked items.

Refer to TrackingReferenceIDType definition for any enumerations.

ItemType [attribute]

ItemType is mandatory. A single instance is required.

Indicates the form of the item being reported as being used. Many of the ItemType(s) indicated here have a corresponding named element equivalent, which is referenced here for definition purposes.

Refer to ItemType definition for any enumerations.

(sequence)

The sequence of items below is mandatory. A single instance is required.

Identifier

Identifier is mandatory. Multiple instances might exist.

An Identifier is required for packages and items (pallets, reel packages, boxes, ream items, reel items, etc). The Identifier element contains the actual item identifier code. Identifier is repeatable so more than one identifier can be communicated. For example, the printed identifier on a label may be different from the barcode printed on the label.

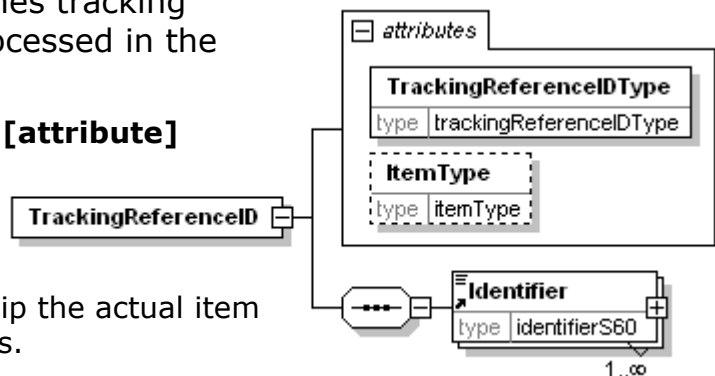

TrackingReferenceIDType [attribute]

Defines the type of relationship the actual item has to other the tracked items.

TrackingReferenceIDType	
type	trackingReferenceIDType

This item is restricted to the following list.

Child

This item is derived from the actual item. E.g. a board from a saw log.

Origin

The origin of the actual item. E.g. a logging area where a saw log was cut.

Parent

The actual item is derived from this item. E.g. a sawlog is cut from a stem.

TrackType [attribute]

The type of track

This item is restricted to the following list.

attribute	
TrackType	
type	trackType

Mono

Track type is monaural.

Stereo

Track type is stereophonic.

TradeRegion

A geographic area for product availability communication.

IsTradeRegionAvailable [attribute]

*IsTradeRegionAvailable is mandatory.
A single instance is required.*

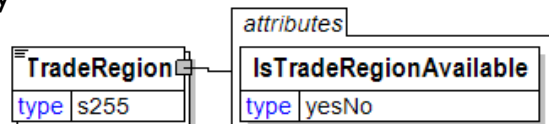

Is the geographic area available or not.

Refer to IsTradeRegionAvailable definition for any enumerations.

TradingCompensationChain

A group element that contains information about a business chain that defines how to calculate compensations when trading in many levels of business.

The

Business Chain contains references to the trading contract for each level of business. A Business Chain is valid to use for calculation of compensations as specified either by a ValidityPeriod or by a ValidityFlag.

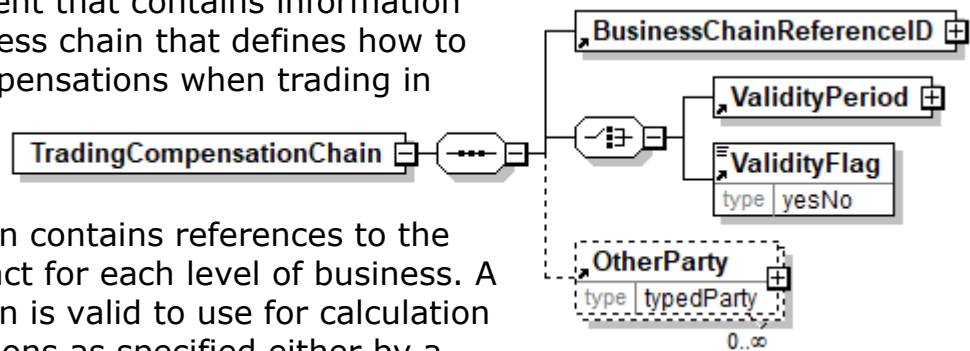

(sequence)

The sequence of items below is mandatory. A single instance is required.

BusinessChainReferenceID

BusinessChainReferenceID is mandatory. A single instance is required.

Specifies a reference to a Business Chain.

(choice)

[choice] is mandatory. A single instance is required.

ValidityPeriod

ValidityPeriod is mandatory. A single instance is required.

The validity period for a specific item, e.g. the validity period for an e-Document.

ValidityFlag

ValidityFlag is mandatory. A single instance is required.

Specifies if the item is valid or not.

OtherParty

OtherParty is optional. Multiple instances might exist.

An organisation or business entity other than those specifically detailed within an e-Document.

TradingCompensationChainValidityType [attribute]

Specifies how validity of trading compensation chains shall be determined.

This item is restricted to the following list.

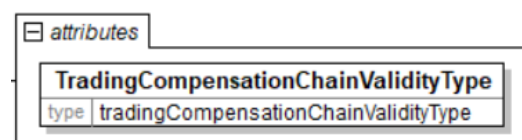

ByValidityFlag

Validity is determined by a validity flag

ByValidityPeriod

Validity is determined by a validity period

TransactionHistoryConfirmationNumber

A sequential number that keeps track the version of a confirmation document.

When the document is a confirmation document, then the

TransactionHistoryNumber refers to the trigger transaction for the confirmation.

TransactionHistoryConfirmationNumber	
type	nni9

TransactionHistoryNumber

A sequential number that keeps track of the version of a document.

However when the document is a confirmation document, in which case the

TransactionHistoryNumber refers to the trigger transaction for the confirmation.

TransactionHistoryNumber	
type	nni9

TransportationComment

Textual Commentary on Transportation for an entire GoodsReceipt.

(sequence)

The sequence of items

below is mandatory. A single instance is required.

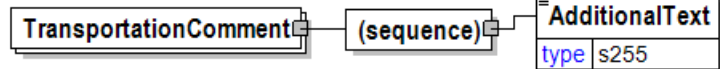

AdditionalText

AdditionalText is mandatory. A single instance is required.

A text field that is used to communicate information not previously defined or for special instructions. To be used only for circumstances not covered by specific elements.

TransportContextType [attribute]

Provides information about the reason for the transport.

This item is restricted to the following list.

Normal (default)

The transport is a normal freight.

NormalWithReturn

The transport is a normal freight with an allocated return freight

Return

The transport is a return freight.

attributes	
TransportContextType	
type	transportContextType
default	Normal

TransportDeckOption [attribute]

Allotment of a shipping lot that can be placed on the deck of a ship.

This item is restricted to the following list.

attribute
TransportDeckOption
type deckType

FullDeck

The full load can be placed on the deck of the transport vehicle (ship).

HalfDeck

Only half the load can be placed on the deck of the transport vehicle (ship).

OneThirdDeck

Only one-third of the load can be placed on the deck of the transport vehicle (ship).

UnderDeck

The entire load must be placed under the deck of the transport vehicle (ship).

TransportInformation

A grouping element for transport information.

TransportContextType [attribute]

TransportContextType is optional. A single instance might exist.

Provides information about the reason for the transport.

Refer to TransportContextType definition for any enumerations.

IsVehicleTourComplete [attribute]

IsVehicleTourComplete is optional. A single instance might exist.

Indicates whether all legs for the particular vehicle tour referenced by VehicleTourNumber are carried out or not.

Refer to IsVehicleTourComplete definition for any enumerations.

(sequence)

The sequence of items below is mandatory. A single instance is required.

TransportModeCharacteristics

TransportModeCharacteristics is optional. A single instance might exist.

A group item defining the primary mode of transport.

TransportVehicleCharacteristics

TransportVehicleCharacteristics is optional. A single instance might exist.

A group item containing information about a transport vehicle, e.g. a truck. A transport vehicle has its own power and can be used to pull, push, carry, or tow a transport unit loaded with goods.

TransportUnitCharacteristics

TransportUnitCharacteristics is optional. Multiple instances might exist.

A group item containing information about a transport unit, e.g. a trailer. Transport units contain goods and move using power from another source, the transport vehicle.

TransportLoadingCharacteristics

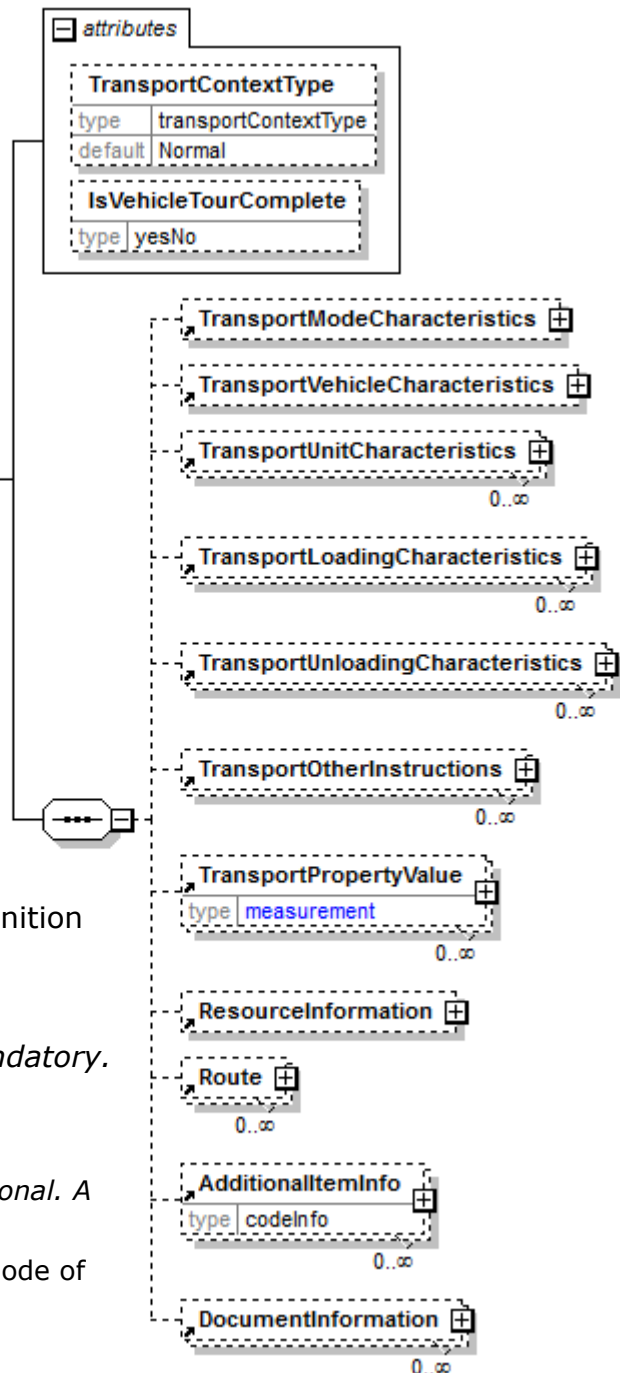

TransportLoadingCharacteristics is optional. Multiple instances might exist.

A group item defining how the transported items are to be loaded.

TransportUnloadingCharacteristics

TransportUnloadingCharacteristics is optional. Multiple instances might exist.

A group item defining how the transported items are to be unloaded.

TransportOtherInstructions

TransportOtherInstructions is optional. Multiple instances might exist.

A group item defining any other instructions for the transport not covered in the description of transport mode, vehicle, unit, and loading characteristics or defining an alternative description for the categories mentioned above.

TransportPropertyValue

TransportPropertyValue is optional. Multiple instances might exist.

Specifies values for various properties for a transport.

ResourceInformation

ResourceInformation is optional. A single instance might exist.

A group item that contains information for specification of resources.

Route

Route is optional. Multiple instances might exist.

Route defines directions and characteristics for how to transport goods between two locations. A route starts at delivery origin or at the supplypoint belonging to the delivery origin.

AdditionalItemInfo

AdditionalItemInfo is optional. Multiple instances might exist.

A grouping element that contains information about additional items specified by an agency. Restricted use of this element is recommended.

DocumentInformation

DocumentInformation is optional. Multiple instances might exist.

A group element containing a specification of required documents in the business process. Additional free text to be printed on documents can also be specified.

TransportInstructionCode

A code used to define any other transport instructions that are not covered in the description of transport mode, vehicle, unit, and loading characteristics or used alternatively to summarise in one unique code the above-mentioned categories.

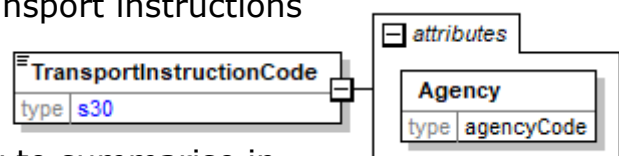

Agency [attribute]

Agency is mandatory. A single instance is required.

Describes the agency maintaining the list of codes. To be included in this list the agency must be a recognized standards body or industry organisation.

- For the element that owns this attribute.

papiNet V2R31

- For another attribute in the list of attributes associated with the parent element.

Refer to Agency definition for any enumerations.

TransportInstructionText

A text field further describing the transport instructions.

TransportInstructionText	
type	s255

TransportInstructionType [attribute]

Indicates the type of instruction.

This item is restricted to the following list.

LegSpecific

The text is related to the delivery leg or entire delivery.

ProductSpecific

The text is related to the product being transported.

attribute	TransportInstructionType	
type	transportInstructionType	

TransportLoadingCharacteristics

A group item defining how the transported items are to be loaded.

MixProductIndicator [attribute]

MixProductIndicator is optional. A single instance may occur.

Specifies whether a product can be mixed with other products on the same shipment.

Refer to MixProductIndicator definition for any enumerations.

TransportLoadingType [attribute]

TransportLoadingType is optional. A single instance might exist.

Defines the primary loading modes for the transport of the

goods

Refer to TransportLoadingType definition for any enumerations.

TransportDeckOption [attribute]

TransportDeckOption is optional. A single instance might exist.

Allotment of a shipping lot that can be placed on the deck of a ship.

Refer to TransportDeckOption definition for any enumerations.

LoadingTolerance [attribute]

LoadingTolerance is optional. A single instance might exist.

Specifies tolerance type for load quantity. Tolerance values are given by RangeMin and RangeMax in Quantity.

Refer to LoadingTolerance definition for any enumerations.

DirectLoading [attribute]

DirectLoading is optional. A single instance might exist.

Specifies if the transport unit should be loaded directly with goods received on another transport unit.

Refer to DirectLoading definition for any enumerations.

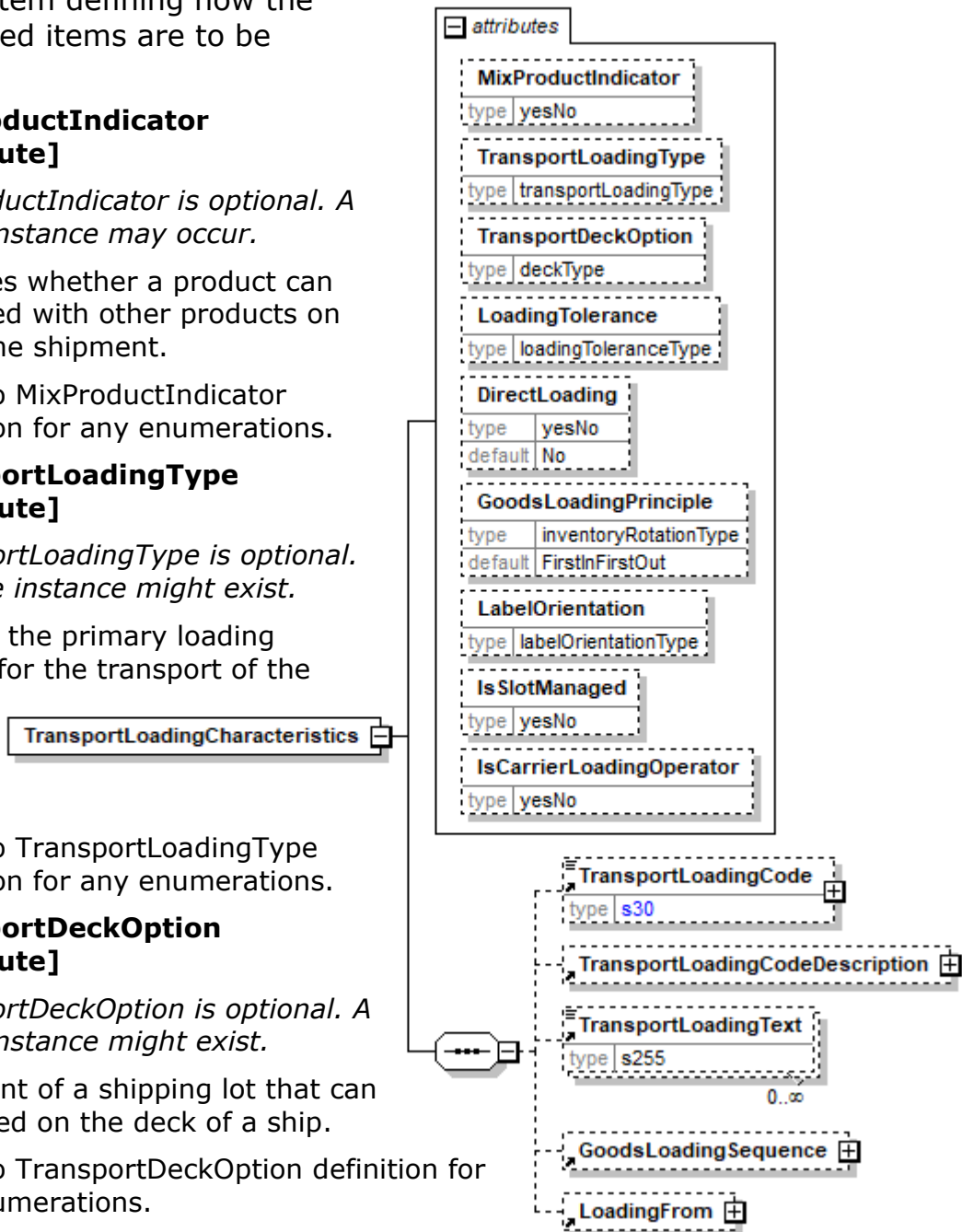

GoodsLoadingPrinciple [attribute]

GoodsLoadingPrinciple is optional. A single instance might exist.

Defines principles for how goods are picked from warehouse and loaded

Refer to GoodsLoadingPrinciple definition for any enumerations.

LabelOrientation [attribute]

LabelOrientation is optional. A single instance might exist.

Specifies label orientation for loaded goods seen in the transport direction of the goods carrier. It makes the label visible during unloading from a predetermined side.

Refer to LabelOrientation definition for any enumerations.

IsSlotManaged [attribute]

IsSlotManaged is optional. A single instance might exist.

Specifies if the activity is managed by given slot times for execution of the activity. For example, given slot times for unloading of a transport unit.

Refer to IsSlotManaged definition for any enumerations.

IsCarrierLoadingOperator [attribute]

IsCarrierLoadingOperator is optional. A single instance might exist.

Specifies if the carrier is the loading operator or not.

Refer to IsCarrierLoadingOperator definition for any enumerations.

(sequence)

The sequence of items below is mandatory. A single instance is required.

TransportLoadingCode

TransportLoadingCode is optional. A single instance might exist.

A code defining how the transported items are to be loaded.

TransportLoadingCodeDescription

TransportLoadingCodeDescription is optional. A single instance might exist.

A group item describing the TransportLoadingCode. The document specifying how to load goods based on the TransportLoadingCode can be supplied in e-Attachment. TransportLoadingCode can be used as a Load Pattern identifier.

TransportLoadingText

TransportLoadingText is optional. Multiple instances might exist.

A text field further describing the transport loading instructions.

GoodsLoadingSequence

GoodsLoadingSequence is optional. A single instance might exist.

A group item that contains information regarding the order goods should be loaded onto a transport unit.

LoadingFrom

LoadingFrom is optional. A single instance might exist.

Specifies a transport unit from which the goods are loaded.

TransportLoadingCode

A code defining how the transported items are to be loaded.

Agency [attribute]

Agency is mandatory. A single instance is required.

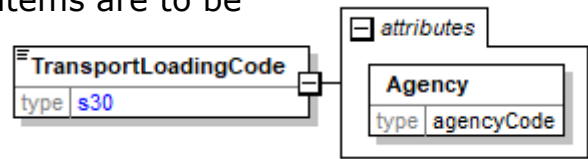

Describes the agency maintaining the list of codes. To be included in this list the agency must be a recognized standards body or industry organisation.

- For the element that owns this attribute.
- For another attribute in the list of attributes associated with the parent element.

Refer to Agency definition for any enumerations.

TransportLoadingCodeDescription

A group item describing the TransportLoadingCode. The document specifying how to load goods based on the

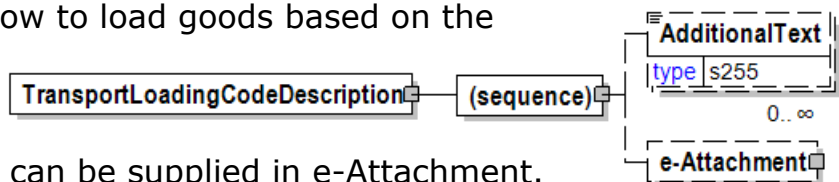

TransportLoadingCode can be supplied in e-Attachment. TransportLoadingCode can be used as a Load Pattern identifier.

(sequence)

The sequence of items below is mandatory. A single instance is required.

AdditionalText

AdditionalText is optional. Multiple instances might exist.

A text field that is used to communicate information not previously defined or for special instructions. To be used only for circumstances not covered by specific elements.

e-Attachment

e-Attachment is optional. A single instance might exist.

e-Attachment enables the sender to provide information about attachments to the document.

Note: BizTalk users may have problems in processing this element. See the papiNet FAQs (papiNet.org) for more information.

TransportLoadingText

A text field further describing the transport loading instructions.

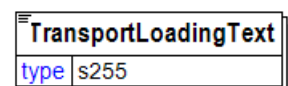

TransportLoadingType [attribute]

Defines the primary loading modes for the transport of the goods

This item is restricted to the following list.

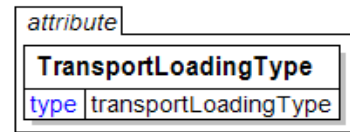

ByLoadingCode

How to load the goods is specified via the element TransportLoadingCode. TransportLoadingCode can be used as a Load Pattern identifier. A separate document, that can be specified by element TransportLoadingCodeDescription, specifies the Load Pattern in all details.

Lying

The goods, such as reels on the belly, have to be in a lying position during transport.

Standing

The goods, such as reels standing on end, have to be in a standing position during transport

StandingUpsideDown

The goods, such as reels standing on end but turned upside-down, have to be in a standing position during transport. Reels are turned upside-down to get the right unwinding direction at end user.

Other

Used for any other loading modes not covered by this list.

TransportModeCharacteristics

A group item defining the primary mode of transport.

TransportModeType [attribute]

TransportModeType is optional. A single instance might exist.

Defines the primary mode of transport for the goods

Refer to TransportModeType definition for any enumerations.

(sequence)

The sequence of items below is mandatory. A single instance is required.

TransportModeCode

TransportModeCode is optional. A single instance might exist.

A code defining the primary mode of transport.

TransportModeText

TransportModeText is optional. A single instance might exist.

A text field further describing the transport mode.

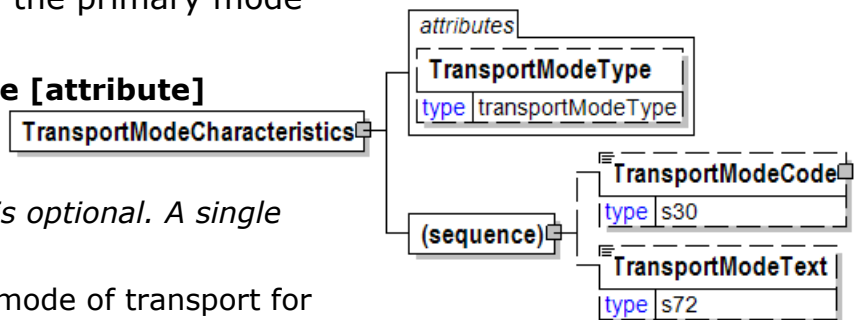

TransportModeCode

A code defining the primary mode of transport.

Agency [attribute]

Agency is mandatory. A single instance is required.

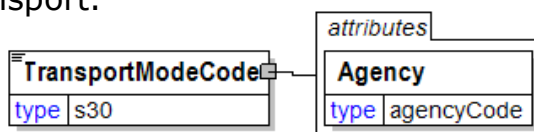

Describes the agency maintaining the list of codes. To be included in this list the agency must be a recognized standards body or industry organisation.

- For the element that owns this attribute.
- For another attribute in the list of attributes associated with the parent element.

Refer to Agency definition for any enumerations.

TransportModeText

A text field further describing the transport mode.

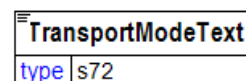

TransportModeType [attribute]

Defines the primary mode of transport for the goods

This item is restricted to the following list.

Air

The goods will be transported by air.

Floating

The product will be transported by floating along waterway. E.g. Wood is normally floated in tied log piles which are connected to each other. No specific transport units are used.

InlandWaterway

The goods will be transported by inland waterway.

Intermodal

The movement of goods in one and the same transport unit, which uses successively two or more modes of transport without handling the goods themselves in changing modes. (Definition courtesy of the UN/ECE, the European Conference of Ministers of Transport [ECMT] and the European Commission [EC])

Mail

The goods will be sent by post.

Multimodal

The goods will be transported by two or more modes of transport. Handling of goods can occur in changing transport modes.

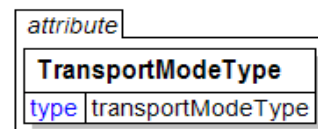

OffRoad

The goods will be transported on the ground, but not on roads surfaced with gravel, asphalt or concrete. It is typically used for a transport from logging areas in the forest to roadside landings.

Rail

The goods will be transported by rail.

Road

The goods will be transported by road.

Sea

The goods will be transported by sea.

Other

Used for any other transport modes not covered by this list.

TransportOtherInstructions

A group item defining any other instructions for the transport not covered in the description of transport mode, vehicle, unit, and loading characteristics or defining an alternative description for the categories mentioned above.

TransportInstructionType [attribute]

TransportInstructionType is optional. A single instance might exist.

Indicates the type of instruction.

Refer to TransportInstructionType definition for any enumerations.

(sequence)

The sequence of items below is mandatory. A single instance is required.

TransportInstructionCode

TransportInstructionCode is optional. A single instance might exist.

A code used to define any other transport instructions that are not covered in the description of transport mode, vehicle, unit, and loading characteristics or used alternatively to summarise in one unique code the above-mentioned categories.

TransportInstructionText

TransportInstructionText is optional. Multiple instances might exist.

A text field further describing the transport instructions.

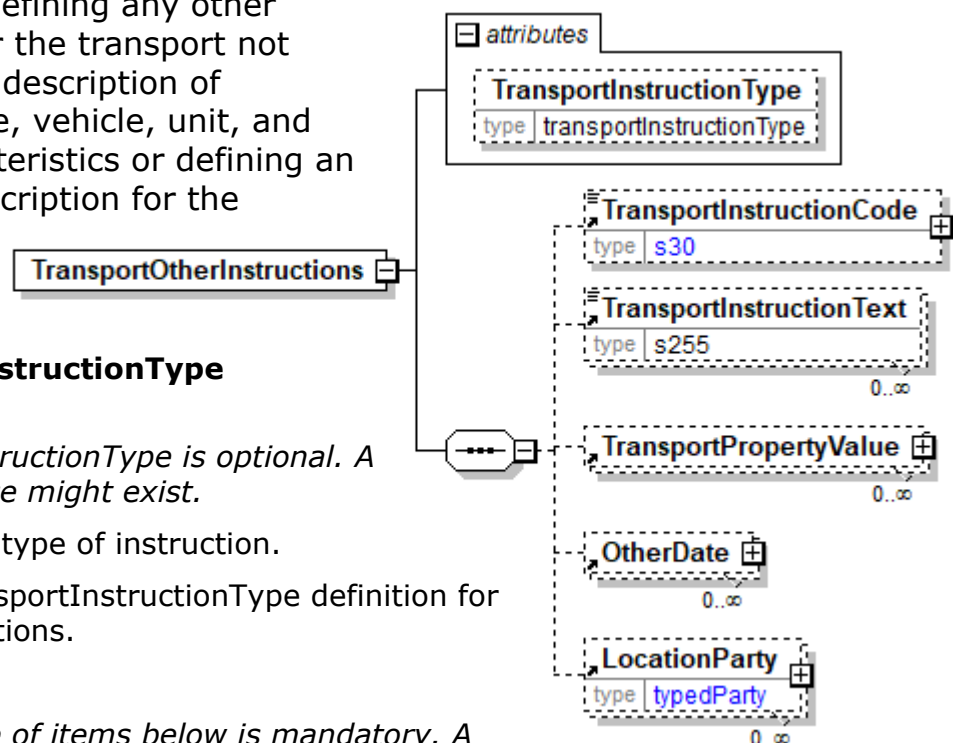

TransportPropertyValue

TransportPropertyValue is optional. Multiple instances might exist.

Specifies values for various properties for a transport.

OtherDate

OtherDate is optional. Multiple instances might exist.

A date that may not be specifically detailed within a document (example: print date at the PurchaseOrderLineItem).

LocationParty

LocationParty is optional. Multiple instances might exist.

The organization or business entity where the business event took place or will take place.

TransportPackageInformation

Information of a package used in transportation, can include several normal packages.

PackageType [attribute]

PackageType is mandatory. A single instance is required.

Communicates the configuration of the item being reported.

Refer to PackageType definition for any enumerations.

MixedProductPalletIndicator [attribute]

MixedProductPalletIndicator is optional. A single instance might exist.

Specifies whether a product can be mixed with other products on the same pallet

Refer to MixedProductPalletIndicator definition for any enumerations.

PackageLevel [attribute]

PackageLevel is optional. A single instance might exist.

An hierarchical numbering approach that communicates containerization and identity.

(sequence)

The sequence of items below is mandatory. A single instance is required.

Identifier

Identifier is mandatory. One instance is required, multiple instances might exist.

An Identifier is required for packages and items (pallets, reel packages, boxes, ream items, reel items, etc). The Identifier element contains the actual item identifier code. Identifier is repeatable so more than one identifier can be communicated. For example, the printed identifier on a label may be different from the barcode printed on the label.

RawMaterialSet

RawMaterialSet is optional. Multiple instances might exist.

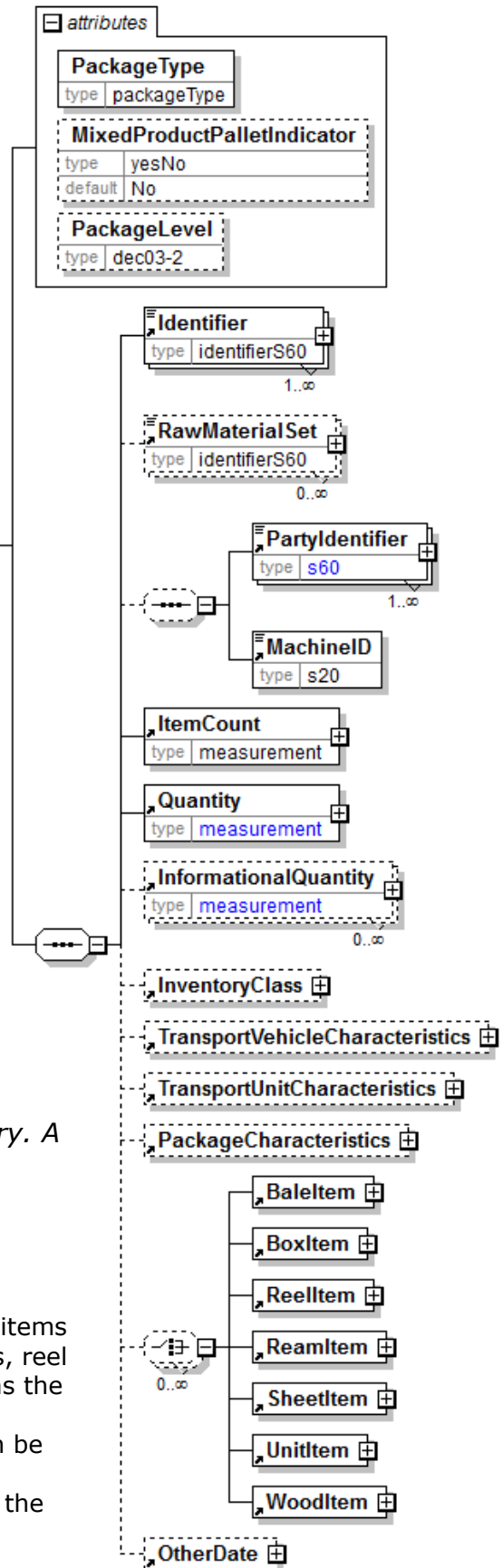

This identifier derived element indicates a grouping of raw materials that were used to manufacture the product.

(sequence)

The sequence of items below is optional. A single instance might exist.

PartyIdentifier

PartyIdentifier is mandatory. One instance is required, multiple instances might exist.

A unique identifier of a specific party. This element contains an attribute PartyIdentifierType that indicates the type of the identifier.

MachineID

MachineID is mandatory. A single instance is required.

An identifier assigned to the particular machine being referenced. For example, a machine could be a paper machine, an off-line coater, a sheeter, or a printing press. The particular machine being referenced will be determined by the business event being supported.

ItemCount

ItemCount is mandatory. A single instance is required.

A count of the number of items (examples: a count of the number of boxes on a pallet or of reams in a box).

Quantity

Quantity is mandatory. A single instance is required.

The Quantity element contains attributes that provide information about the type of quantity that is being communicated, the context in which the particular quantity is to be viewed, and (if the quantity represents an adjustment) an adjustment type.

The Quantity element contains three child elements that enable you to communicate a range of values for the quantity and a target or actual value. It is at this level (Value, RangeMin, and RangeMax) that the unit of measure is specified. This permits the range to be specified in a different unit of measure than the target.

InformationalQuantity

InformationalQuantity is optional. Multiple instances might exist.

A quantity given in a valid UOM used for information purposes only (not for calculation). For example, an ordered quantity was 100 reels as opposed to the invoice quantity of 20,000 pounds.

InventoryClass

InventoryClass is optional. A single instance might exist.

A group item containing information about status of inventory and goods items.

TransportVehicleCharacteristics

TransportVehicleCharacteristics is optional. A single instance might exist.

A group item containing information about a transport vehicle, e.g. a truck. A transport vehicle has its own power and can be used to pull, push, carry, or tow a transport unit loaded with goods.

TransportUnitCharacteristics

TransportUnitCharacteristics is optional. A single instance might exist.

A group item containing information about a transport unit, e.g. a trailer. Transport

units contain goods and move using power from another source, the transport vehicle.

PackageCharacteristics

PackageCharacteristics is optional. A single instance might exist.

The package characteristics.

(choice)

[choice] is optional. Multiple instances might exist.

BaleItem

BaleItem is mandatory. A single instance is required.

An individual bale included as part of a delivery.

BoxItem

BoxItem is mandatory. A single instance is required.

A four-sided container for reams or sheet items. A pallet can contain zero or more boxes. The term Carton is a synonym for BoxItem. The term "Box" is used as constraint within the ItemType attribute of the UsageLineItemDetail to refer to a box that contains other boxes.

ReelItem

ReelItem is mandatory. A single instance is required.

A group item representing details of an actual (as opposed to specified) reel. One or several reels can be contained in a package.

ReamItem

ReamItem is mandatory. A single instance is required.

A wrapped quantity of SheetItem(s).

SheetItem

SheetItem is mandatory. A single instance is required.

A group item consisting potentially of the date the sheets were converted into sheets and/or packaged or finished.

UnitItem

UnitItem is mandatory. A single instance is required.

Unit Item.

WoodItem

WoodItem is mandatory. A single instance is required.

Group element containing elements describing a wood industry product.

OtherDate

OtherDate is optional. A single instance might exist.

A date that may not be specifically detailed within a document (example: print date at the PurchaseOrderLineItem).

TransportPropertyType [attribute]

Defines the property specified for a transport.

This item is restricted to the following list.



ContractedDistanceWithLoad

The predetermined transport distance for a payload, that has been agreed in a contract. This distance is independent of the actual route that the payload will be transported.

DistanceWithLoad

Transported distance with a payload.

DistanceWithLoadOnPrivateRoads

Transported distance with a payload on private roads. A Numeric value.

DistanceWithLoadOnPublicRoads

Transported distance with a payload on public roads. A Numeric value

DistanceWithoutLoad

Transported distance without a payload.

LoadingPrice

Unit price for loading.

LoadingTime

Time elapsed during loading.

LoadingWaitingTime

Time elapsed waiting for loading.

NumberOfPackageReloads

Number of packages that are shifted from a transport unit to another transport unit.

RestrictionOnNumberOfLoads

Restriction on number of loads that can be handled, e.g. per day.

RestrictionOnNumberOfVehicles

Restriction on number of vehicles that can be handled, e.g. per day.

TransportPrice

Unit price for transport.

UnloadingPrice

Unit price for unloading.

UnloadingTime

Time elapsed during unloading.

UnloadingWaitingTime

Time elapsed waiting for unloading.

TransportPropertyValue

Specifies values for various properties for a transport.

TransportPropertyType [attribute]

TransportPropertyType is mandatory. A single instance is required.

Defines the property specified for a transport.

Refer to TransportPropertyType definition for any enumerations.

(choice)

The choice is mandatory. One instance is required.

(sequence)

The sequence of items below is mandatory. A single instance is required.

Value

Value is mandatory. A single instance is required.

A numeric value expressed in the unit of measure (UOM).

RangeMin

RangeMin is optional. A single instance might exist.

The minimum value (lower boundary) allowed for the Measurement that is the parent of this element.

RangeMax

RangeMax is optional. A single instance might exist.

The maximum value (upper boundary) allowed for the Measurement that is the parent of this element. Some elements use the RangeMax element with an extended list of unit of measures. (Note: the red colour in the picture is an artifact of how the graphic was captured and should be disregarded.)

PriceDetails

PriceDetails is mandatory. A single instance is required.

An element that groups together price information.

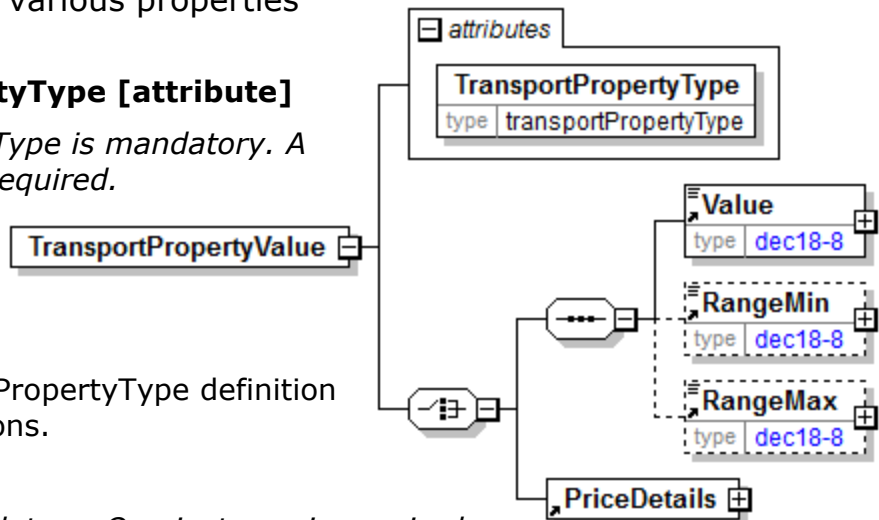

TransportStatus

Text element used to communicate the current status of the shipment actually being transported to the recipient. This element could indicate the tracking status that the transport company issues. Alternatively, it could be the vendor's internal tracking status of the shipment.

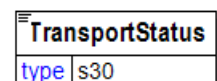

TransportStatusIssueDate

The Date and Time the transport status is issued.

(sequence)

The sequence of items below is mandatory. A single instance is required.

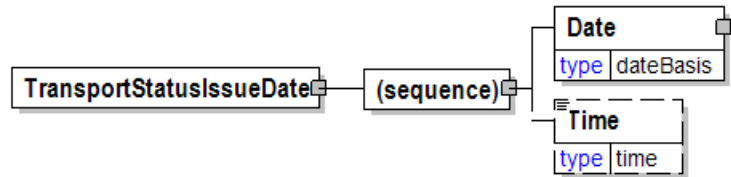

Date

Date is mandatory. A single instance is required.

A group element that contains the specification of Year, Month, and Day.

Time

Time is optional. A single instance might exist.

Times are treated in a standard XML fashion with a special case used to indicate a generalized "local" time. The standard XML approach to time is hh:mm:ss, hh:mm:ssZ, or hh:mm:ss±hh:mm.

hh:mm:ss±hh:mm is used to represent a time with a time zone. The time zone is communicated as the number of hours offset from the Universal Time Coordinate (UTC), a.k.a. Greenwich Mean Time.

hh:mm:ssZ indicates the time at Zulu (another name for UTC).

hh:mm:ss or hh:mm indicates within papiNet the applicable local time where the associated event is taking place. Caution should be used when processing times of this nature as the papiNet approach may be in discord with other users of XML.

TransportUnitCapacity

Specifies the capacity of a transport unit, e.g. available volume.

(sequence)

The sequence of items below is mandatory. A single instance is required.

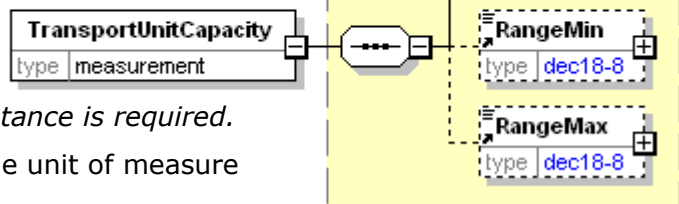

Value

Value is mandatory. A single instance is required.

A numeric value expressed in the unit of measure (UOM).

RangeMin

RangeMin is optional. A single instance might exist.

The minimum value (lower boundary) allowed for the Measurement that is the parent of this element.

RangeMax

RangeMax is optional. A single instance might exist.

The maximum value (upper boundary) allowed for the Measurement that is the parent of this element. Some elements use the RangeMax element with an extended list of unit of measures. (Note: the red colour in the picture is an artifact of how the graphic was captured and should be disregarded.)

TransportUnitCharacteristics

A group item containing information about a transport unit, e.g. a trailer. Transport units contain goods and move using power from another source, the transport vehicle.

TransportUnitType [attribute]

TransportUnitType is mandatory. A single instance is required.

Provides general information about the transport unit, which is the unit containing the goods. Transport units only move using power from another source, the transport vehicle. Additional detail can be specified through a detail type.

Refer to TransportUnitType definition for any enumerations.

TransportUnitVariable [attribute]

TransportUnitCharacteristics

TransportUnitVariable is optional. A single instance might exist.

Indicates if there is an attribute of the transport unit that can change (is variable).

Refer to TransportUnitVariable definition for any enumerations.

TransportUnitLevel [attribute]

TransportUnitLevel is optional. A single instance might exist.

The non-zero sequential number that uniquely identifies the level of stacked transport units. The lowest level is assigned number 1.

For example,

A railcar loaded with a container, then the transport unit levels would be railcar level 1 and container level 2.

A railcar loaded with a trailer and a container loaded on the trailer, then the transport unit levels would be railcar level 1, trailer level 2 and container level 3.

TransportUnitHorizontalOrder [attribute]

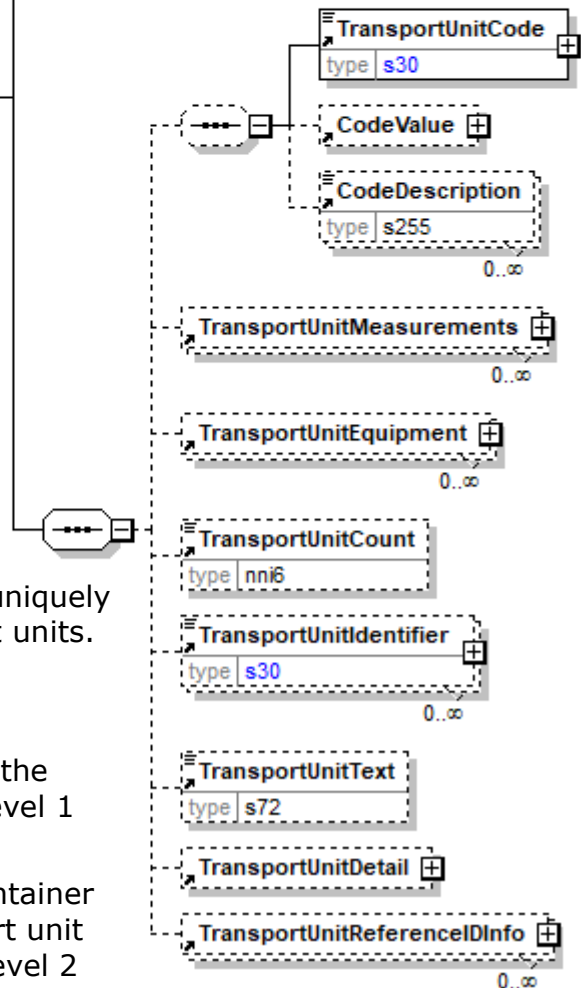
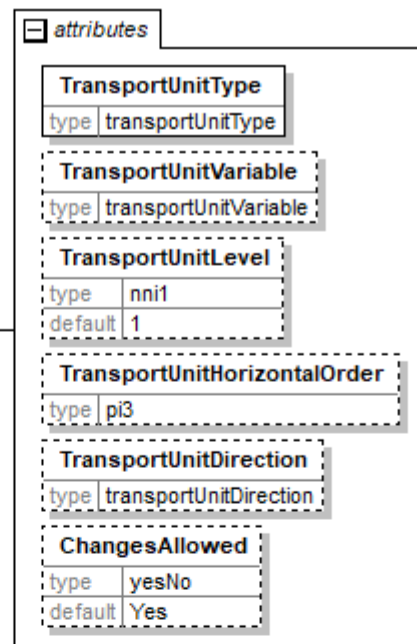

TransportUnitHorizontalOrder is optional. A single instance might exist.

A positive sequential number starting with 1 that specifies the horizontal order of the transport unit on a transport.

TransportUnitHorizontalOrder is applicable to rail, road and offroad transports. It is neither applicable to air, sea nor waterway transports.

Refer to TransportUnitHorizontalOrder definition for details about how to use this attribute.

TransportUnitDirection [attribute]

TransportUnitDirection is optional. A single instance might exist.

Specifies which end of a transport unit that is facing the driving direction of a transport, when the transport unit can be moved in two directions.

For example, a railcar can be moved in two directions on a railway.

Refer to TransportUnitDirection definition for any enumerations.

ChangesAllowed [attribute]

ChangesAllowed is optional. A single instance might exist.

Indicates if the given information is allowed to be changed or not, i.e. if a logistics partner is bound to execute as instructed or can change instructed requirements.

Refer to ChangesAllowed definition for any enumerations.

(sequence)

The sequence of items below is mandatory. A single instance is required.

(sequence)

The sequence of items below is optional. A single instance might exist.

TransportUnitCode

TransportUnitCode is mandatory. A single instance is required.

A code defining the primary means of containing the goods.

CodeValue

CodeValue is optional. A single instance might exist.

A grouping element specifying a value belonging to a code that is defined by an agency.

CodeDescription

CodeDescription is optional. Multiple instances might exist.

A textual description for the meaning of a code that is defined by an agency. When the Code is associated with a CodeValue of type TextValue, then the CodeDescription is a textual description of both the Code and the TextValue.

TransportUnitMeasurements

TransportUnitMeasurements is optional. Multiple instances might exist.

A group item containing the measurements (length, height, weight, and width) of the transport unit.

TransportUnitEquipment

TransportUnitEquipment is optional. Multiple instances might exist.

A group item defining extra equipment of the transport unit.

TransportUnitCount

TransportUnitCount is optional. A single instance might exist.

An item defining the number of units used to transport the goods.

TransportUnitIdentifier

TransportUnitIdentifier is optional. Multiple instances might exist.

The identifier of the transport unit, for example a license plate number, a container ID etc. The identifier of the transport unit is the same as the identifier of the vehicle when the transport unit is directly mounted on the vehicle and does not have a separate identifier. The type of identifier is indicated by the TransportUnitIdentifierType.

TransportUnitText

TransportUnitText is optional. A single instance might exist.

A text field further describing the transport unit.

TransportUnitDetail

TransportUnitDetail is optional. A single instance might exist.

A group item describing details for a transport unit.

TransportUnitReferenceIDInfo

TransportUnitReferenceIDInfo is optional. Multiple instances might exist.

A group item that defines the relationship between a referenced transport unit and another transport unit.

TransportUnitCode

A code defining the primary means of containing the goods.

Agency [attribute]

Agency is mandatory. A single instance is required.

Describes the agency maintaining the list of codes. To be included in this list the agency must be a recognized standards body or industry organisation.

- For the element that owns this attribute.
- For another attribute in the list of attributes associated with the parent element.

Refer to Agency definition for any enumerations.

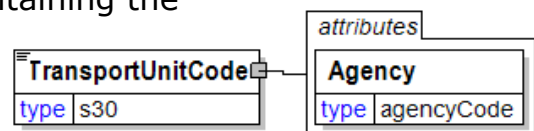

TransportUnitCount

An item defining the number of units used to transport the goods.

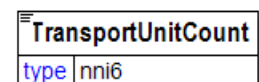

TransportUnitDetail

A group item describing details for a transport unit.

TransportUnitDetailType [attribute]

TransportUnitDetailType is optional. A single instance might exist.

Specifies detail type of a transport unit. If needed variants of a transport unit detail type can be specified by TransportUnitDetailCode in a Trading Partner Agreement as well as clarified in AdditionalText.

Refer to TransportUnitDetailType definition for any enumerations.

LoadOpeningSide [attribute]

LoadOpeningSide is optional. A single instance might exist.

Specifies opening sides on a transport unit for loading and unloading seen in the transport direction of the goods carrier

Refer to LoadOpeningSide definition for any enumerations.

FrontCouplingType [attribute]

FrontCouplingType is optional. A single instance might exist.

Specifies the front coupling device that attaches the transport unit to a vehicle or another transport unit. For example attaches a trailer to a truck or another trailer.

Refer to FrontCouplingType definition for any enumerations.

RearCouplingType [attribute]

RearCouplingType is optional. A single instance might exist.

Specifies the rear coupling device that attaches a vehicle or a transport unit to the transport unit. For example attaches a truck to a trailer or a trailer to another trailer.

Refer to RearCouplingType definition for any enumerations.

(sequence)

The sequence of items below is mandatory. A single instance is required.

(sequence)

The sequence of items below is optional. A single instance might exist.

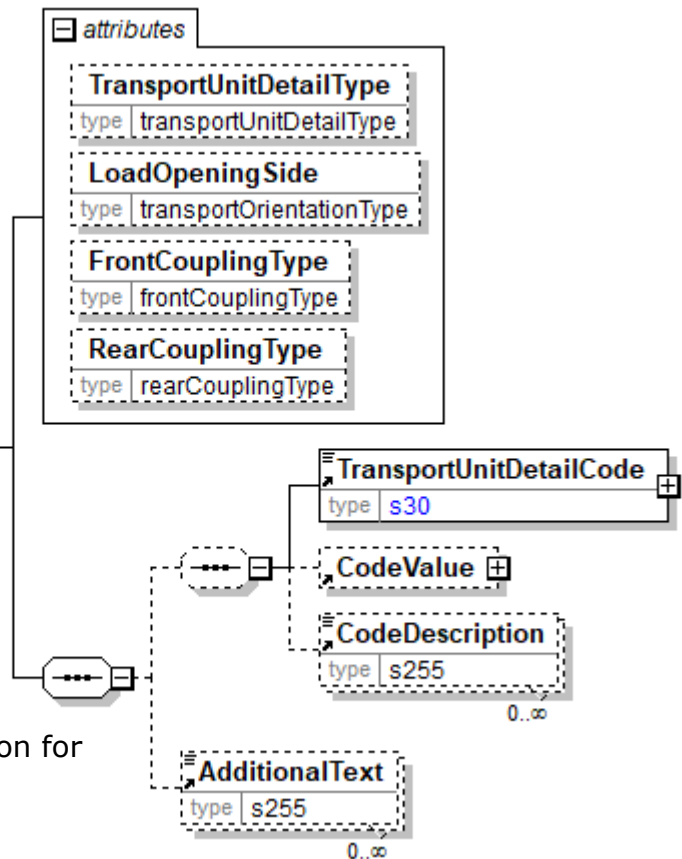

TransportUnitDetailCode

TransportUnitDetailCode is mandatory. A single instance is required.

A code defining details of a transport unit.

CodeValue

CodeValue is optional. A single instance might exist.

A grouping element specifying a value belonging to a code that is defined by an agency.

CodeDescription

CodeDescription is optional. Multiple instances might exist.

A textual description for the meaning of a code that is defined by an agency. When the Code is associated with a CodeValue of type TextValue, then the CodeDescription is a textual description of both the Code and the TextValue.

AdditionalText

AdditionalText is optional. Multiple instances might exist.

A text field that is used to communicate information not previously defined or for special instructions. To be used only for circumstances not covered by specific elements.

TransportUnitDetailCode

A code defining details of a transport unit.

Agency [attribute]

Agency is mandatory. A single instance is required.

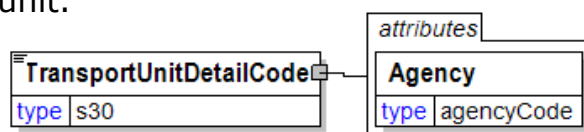

Describes the agency maintaining the list of codes. To be included in this list the agency must be a recognized standards body or industry organisation.

- For the element that owns this attribute.
- For another attribute in the list of attributes associated with the parent element.

Refer to Agency definition for any enumerations.

TransportUnitDetailType [attribute]

Specifies detail type of a transport unit. If needed variants of a transport unit detail type can be specified by TransportUnitDetailCode in a Trading Partner Agreement as well as clarified in AdditionalText.

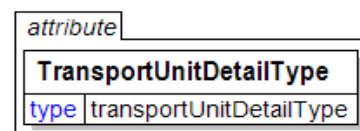

This item is restricted to the following list.

DryFreightContainer

The most widely used container for general cargo. It is available in 20 and 40 feet lengths. For high volume, low weight cargo, 9.5 foot high, 40 foot and 45 foot units are available giving an additional internal cubic capacity.

PlatformContainer

Container Platform Flats and Flatracks are primarily used for the containerisation of oversize, awkward and project cargoes that would otherwise be carried break bulk. These units are increasingly being used as temporary 'tweendecks' for the carriage of large, indivisible loads which are loaded separately on to a bed of flat-racks or platforms spread on top of a ship's hatch cover.

OpenSidesContainer

A container with loading and unloading via side and rear doors. It can also have a curtain side.

OpenTopContainer

A container with an open top that can be loaded via top side and rear doors. Covered by means of removable tilt. Open top containers are designed for the carriage of awkward, indivisible or oversize cargoes. The units offer increased versatility over standard boxes as they are designed for loading through both the top of the container and the rear doors. All units are equipped with a swinging cross-door beam header, which opens outwards to give unrestricted access through the door opening. The simplicity of loading and discharge and the full protection offered by a TIR approved tarpaulin provide a container that will ensure the safe passage of a broad range of cargoes.

OverheadContainer

A container with oversize measurements. Common types are "Open Top High Cube" and "Pallet Wide High Cube".

SwapBodyContainer

A container with foldable legs and transported on chassis. A SwapBody can easily be stored and swapped between different transport modes, usually road/rail. No handling equipment is needed. Swapbodies are designed for two-palletwide operations. The increased internal width of a swapbody unit allows two pallets (up to a maximum of 1200mm wide) to be loaded side by side.

BoxTrailer

Semi-trailer completely closed only accessible with doors at rear end. The box is often made of plywood.

CentreAxleTrailer

A rigid drawbar trailer that can carry goods and where the wheel axle(s) is (are) positioned close to the centre of gravity of the transport unit (when uniformly loaded) so that only a small static vertical load is transmitted to the towing vehicle.

CurtainsiderTrailer

Semi-Trailer with automatic or semi-automatic curtain that opens on the side. An other common used name is Tautliner.

DollyTrailer

A drawbar trailer with a fifth-wheel coupling that can be coupled to a semi-trailer. The wheel axle(s) is (are) positioned close to the centre of gravity of the transport unit so that only a small static vertical load is transmitted to the towing vehicle. It cannot contain goods itself and is typically used as the

steering axle(s) of a coupled semi-trailer.

DrawBarTrailer

A trailer with both front and rear axles usually towed by a lorry. It can be either covered or uncovered. A drawbar trailer carries the full load on its axles compared to a semi-trailer that only carries the half load on its rear axles. A semi-trailer can't move by itself because it only has wheels at the rear end.

GooseneckTrailer

Semi-Trailer with a stepdeck at the front end, i.e. not a flat platform. It can be both covered or uncovered.

HuckepackTrailer

Platform or Semi-Trailer with reinforcements and specially designed to be lifted on and off rail wagons. It makes it easy to mix transport modes for the transport unit from road to rail and vice versa. Synonym: StackTrain, Piggyback.

FlatbedTrailer

Semi-Trailer with an open flat platform.

SemiTrailer

A semi-trailer is a trailer without a front axle. It can be either covered or uncovered. A large proportion of a semi-trailer's weight is supported by the towing vehicle, or a dolly trailer, or the tail of another trailer. A semi-trailer is normally equipped with landing gear (legs which can be lowered) to support it when it is uncoupled.

SkeletalTrailer

A universal extensible skeletal chassis.

SkeletalContainerTrailer

A chassis designed to carry containers.

SkeletalDrawbarTrailer

A chassis with a drawbar.

SpecialTrailer

Semi-Trailer equipped with special features to load and unload goods. This type can have special designed floor to move goods without any external handling tools. Typical used names are CoilTrailer, Joloda, LoadMate, Rolamat, Selfloader and Walking floor. Dimensions on loading/unloading facilities, e.g. skates, may vary between makes. A CurtainSider with sliding roof is also typed as Special.

TerminalTrailer

Equipment which is not allowed on public roads and used for moving goods in terminals and warehouses. Normally these trailer types have no transport unit identifiers. Typical used names are Mafi, Platform and Roltrailer.

TiltTrailer

Semi-Trailer which can be closed by means of removable tilts.

BasketRailCar

A railcar with a demountable sub frame, fitted with devices for vertical handling, to allow the loading and unloading of semi-trailers or road vehicles.

ContainerRailCar

Open railcar designed to carry Containers, SwapBodies etc.

FlatRailCar

A railcar without roof or sides, or railcar without roof but with sides not higher than 60 cm, or swing-bolster railcar, of ordinary or special type. Railcars designed exclusively to carry containers, swap-bodies or goods vehicles are excluded.

HighSidedRailCar

A railcar with no roof and with rigid sides higher than 60 cm.

PocketRailCar

A railcar with a recessed pocket to accept the axle/wheel assembly of a semitrailer.

SpineRailCar

A rail railcar with a central chassis designed to carry a semi-trailer.

ContainerVesselUnit

Carry containers on vessels.

ConventionalVesselUnit

Carry goods loaded/unloaded by LOLO (lift-on/lift-off method) on vessels.

RollOnOffVesselUnit

Carry goods loaded/unloaded by RORO (roll-on/roll-off method) on vessel.

SidePortVesselUnit

Carry goods loaded/unloaded through side ports in the vessel side.

TankVesselUnit

Carry goods stored in tanks on vessels, e.g. bulk transport of liquids and other commodities.

TransportUnitDirection [attribute]

Specifies which end of a transport unit that is facing the driving direction of a transport, when the transport unit can be moved in two directions.

For example, a railcar can be moved in two directions on a railway.

This item is restricted to the following list.

End1

The End 1 of a railcar according to the application standard "GS1 EPCIS for Rail Vehicle Visibility".



<https://www.gs1.org/sites/gs1/files/2023-04/application-standard-gs1-epcis-for-rail-vehicle-visibility.pdf>

End2

The End 2 of a railcar according to the application standard "GS1 EPCIS for Rail Vehicle Visibility".

<https://www.gs1.org/sites/gs1/files/2023-04/application-standard-gs1-epcis-for-rail-vehicle-visibility.pdf>

TransportUnitEquipment

A group item defining extra equipment of the transport unit.

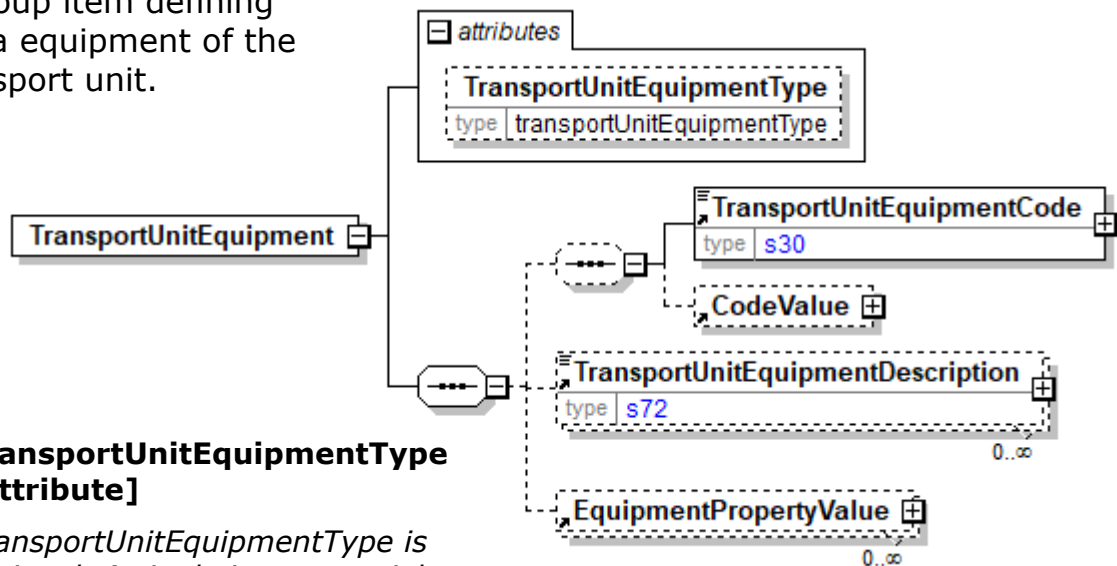

TransportUnitEquipmentType [attribute]

TransportUnitEquipmentType is optional. A single instance might exist.

Specifies the type of equipment.

Refer to TransportUnitEquipmentType definition for any enumerations.

(sequence)

The sequence of items below is mandatory. A single instance is required.

(sequence)

The sequence of items below is optional. A single instance might exist.

TransportUnitEquipmentCode

TransportUnitEquipmentCode is mandatory. A single instance is required.

TransportUnitEquipmentCode is a code describing extra equipment of the transport unit.

CodeValue

CodeValue is optional. A single instance might exist.

A grouping element specifying a value belonging to a code that is defined by an agency.

TransportUnitEquipmentDescription

TransportUnitEquipmentDescription is optional. Multiple instances might exist.

A text field element describing the extra equipment of the transport unit. When a

papiNet V2R31

TransportUnitEquipmentCode is associated with a CodeValue of type TextValue, then the TransportUnitEquipmentDescription is a textual description of both the TransportUnitEquipmentCode and the TextValue.

EquipmentPropertyValue

EquipmentPropertyValue is optional. Multiple instances might exist.

Specifies a value for a property of equipment. The property is defined by the attribute EquipmentPropertyType.

TransportUnitEquipmentCode

TransportUnitEquipmentCode is a code describing extra equipment of the transport unit.

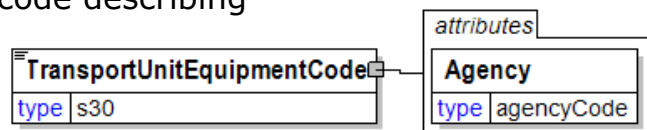

Agency [attribute]

Agency is mandatory. A single instance is required.

Describes the agency maintaining the list of codes. To be included in this list the agency must be a recognized standards body or industry organisation.

- For the element that owns this attribute.
- For another attribute in the list of attributes associated with the parent element.

Refer to Agency definition for any enumerations.

TransportUnitEquipmentDescription

A text field element describing the extra equipment of the transport unit.

When a

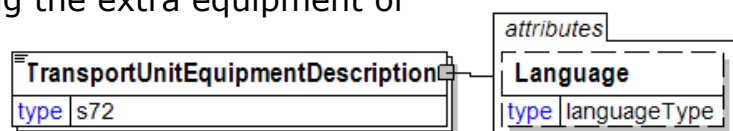

TransportUnitEquipmentCode is associated with a CodeValue of type TextValue, then the TransportUnitEquipmentDescription is a textual description of both the TransportUnitEquipmentCode and the TextValue.

Language [attribute]

Language is optional. A single instance might exist.

The valid Alpha 2- and Alpha 3-character list of language codes in the ISO 639-1 and 639-2 international standards.

Information on the content of this attribute is available at:
https://www.loc.gov/standards/iso639-2/php/code_list.php

TransportUnitEquipmentType [attribute]

Specifies the type of equipment.

This item is restricted to the following list.



ContainerTransport

Equipment for storage, securing and transport of containers.

DividedTank

A tank divided into smaller tank compartments by walls for bulk transport of liquids and other commodities. This type of tank can transport many different products or use a bigger volume for one or just a few products.

RigidOpenTopContainer

An open top container rigidly mounted on the transport unit.

RoundTripTank

A tank with double container walls for bulk transport of liquids and other commodities. This type of tank can take e.g. raw material to a mill and then as return load take a totally different product that cannot be mixed with inbound product, i.e. without any need for tank washing before loading.

RoundwoodTransport

Banks for storage and transport of roundwood.

Tank

A normal solid tank for bulk transport of liquids and other commodities.

TransportUnitHeight

The height of the transport unit in a UOM (usually meters or feet).

(sequence)

The sequence of items below is mandatory. A single instance is required.

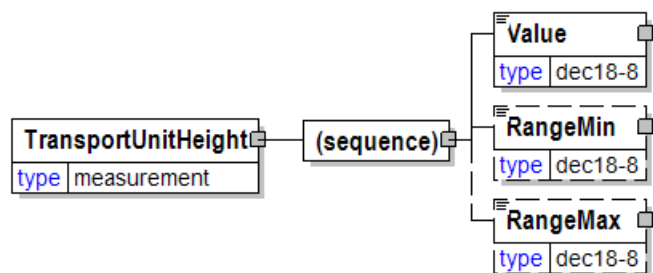

Value

Value is mandatory. A single instance is required.

A numeric value expressed in the unit of measure (UOM).

RangeMin

RangeMin is optional. A single instance might exist.

The minimum value (lower boundary) allowed for the Measurement that is the parent of this element.

RangeMax

RangeMax is optional. A single instance might exist.

The maximum value (upper boundary) allowed for the Measurement that is the parent of this element. Some elements use the RangeMax element with an extended list of unit of measures. (Note: the red colour in the picture is an artifact)

of how the graphic was captured and should be disregarded.)

TransportUnitHorizontalOrder [attribute]

A positive sequential number starting with 1 that specifies the horizontal order of the transport unit on a transport.

TransportUnitHorizontalOrder is applicable to rail, road and offroad transports. It is neither applicable to air, sea nor waterway transports.

When TransportUnitLevel = 1 then the TransportUnitHorizontalOrder specifies the order of the transport unit on the transport counted from the frontend of the transport in the driving direction.

When TransportUnitLevel = 2 then the TransportUnitHorizontalOrder specifies the order of the transport unit loaded on another transport unit referenced by TransportUnitReferenceIDInfo.

- For road transports the order is counted from the frontend of the referenced transport unit at TransportUnitLevel = 1 in the driving direction used on roads.
- For rail transports the order is counted from the "End 1" of the referenced railcar at TransportUnitLevel = 1. "End 1" of the railcar is described in the application standard "GS1 EPCIS for Rail Vehicle Visibility". <https://www.gs1.org/sites/gs1/files/2023-04/application-standard-gs1-epcis-for-rail-vehicle-visibility.pdf>. "End 1" of the railcar is also the non-handbrake end, if the railcar has a handbrake.

When TransportUnitLevel > 2 then the TransportUnitHorizontalOrder specifies the order of the transport unit loaded on another transport unit referenced by TransportUnitReferenceIDInfo.

- When loaded on a transport unit with a specific frontend in the driving direction on roads, then the order is counted from the frontend of the referenced transport unit.
For example, RailCar level 1, Trailer level 2 and Container level 3, then the position is counted from the frontend of the referenced Trailer.
- When loaded on a transport unit with no specific frontend in the driving direction (for example a container), then the order is counted from the end facing the end of the first transport unit with a lower TransportUnitLevel that has a specific end defined for referencing order of loaded transport units.
For example, RailCar level 1, Container level 2 and Container level 3, then position of Container level 3 is counted from the end of the referenced Container level 2 facing the "End 1" of the RailCar.

Examples



papiNet V2R31

Road Transport
Combined transport, a lorry and 2 trailers

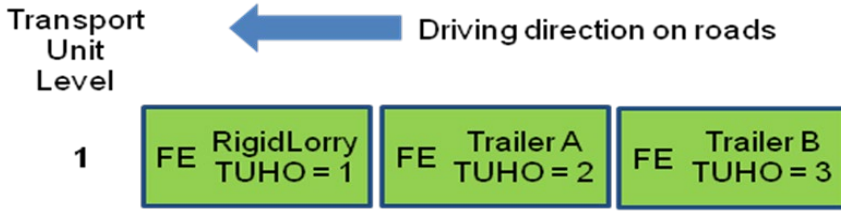

TUHO = TransportUnitHorizontalOrder
FE = Front End of trailer

Road Transport
A semi-trailer with 2 containers

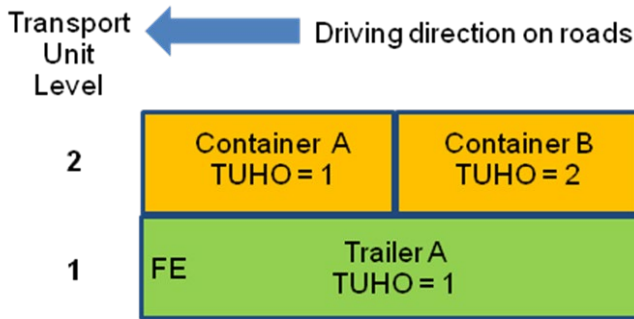

TUHO = TransportUnitHorizontalOrder
FE = Front End of trailer

Rail Transport, example with 2 railcars, the train has 18 railcars

Transport Unit Level

Railcar loaded with 2 trailers with containers Railcar loaded with 2 containers

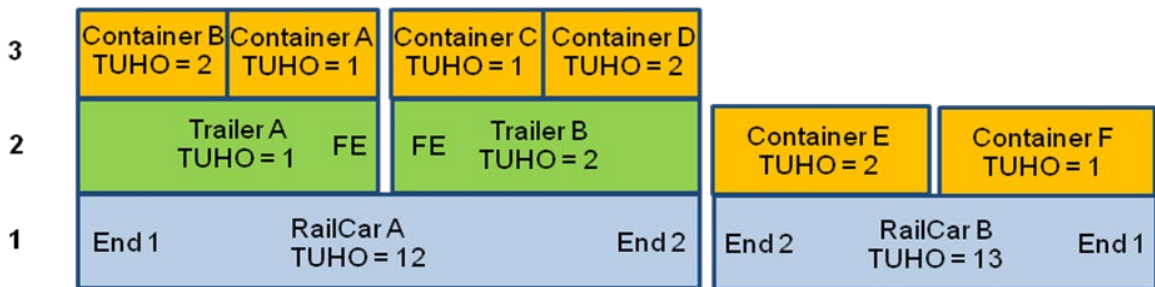

TUHO = TransportUnitHorizontalOrder
FE = Front End of trailer

papiNet V2R31

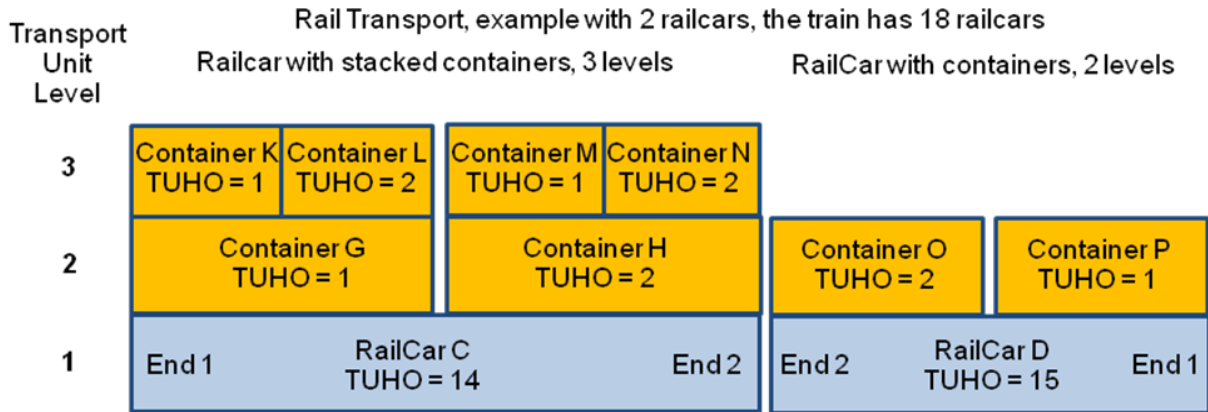

TUHO = TransportUnitHorizontalOrder

TransportUnitIdentifier

The identifier of the transport unit, for example a license plate number, a container ID etc. The identifier of the transport unit is the same as the identifier of the vehicle when the transport unit is directly mounted on the vehicle and does not have a separate identifier. The type of identifier is indicated by the

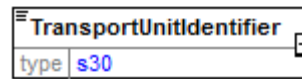

TransportUnitIdentifierType.

TransportUnitIdentifierType [attribute]

TransportUnitIdentifierType is mandatory. A single instance is required.

Provides a contextual definition for the value used to identify the transport unit.

Refer to TransportUnitIdentifierType definition for any enumerations.

StateOrProvince [attribute]

StateOrProvince is optional. A single instance might exist.

The political designation or boundary of a specific area of land.

ISOCountryCode [attribute]

ISOCountryCode is optional. A single instance might exist.

The valid Alpha 2-character list of officially assigned country codes in the ISO 3166-1 international standard.

Information on the content of this attribute is available at:

<https://www.iso.org/obp/ui/#search>

ISOCountryCodeAlpha3 [attribute]

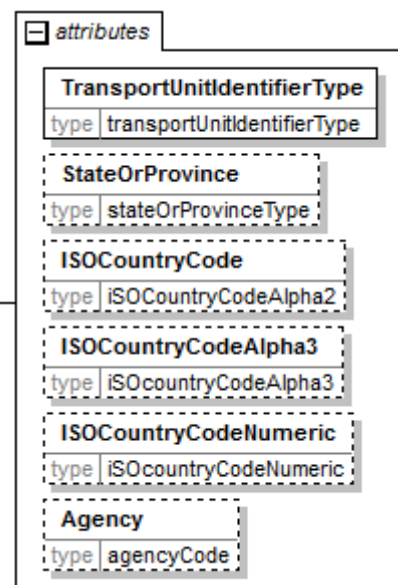

papiNet V2R31

ISOCountryCodeAlpha3 is optional. A single instance might exist.

The valid Alpha 3-character list of officially assigned country codes in the ISO 3166-1 international standard.

Information on the content of this attribute is available at:

<https://www.iso.org/obp/ui/#search>

ISOCountryCodeNumeric [attribute]

ISOCountryCodeNumeric is optional. A single instance might exist.

The valid Numeric 3-digit list of officially assigned country codes in the ISO 3166-1 international standard.

Information on the content of this attribute is available at:

<https://www.iso.org/obp/ui/#search>

Agency [attribute]

Agency is optional. A single instance might exist.

Describes the agency maintaining the list of codes. To be included in this list the agency must be a recognized standards body or industry organisation.

- For the element that owns this attribute.
- For another attribute in the list of attributes associated with the parent element.

Refer to Agency definition for any enumerations.

TransportUnitIdentifierType [attribute]

Provides a contextual definition for the value used to identify the transport unit.

This item is restricted to the following list.

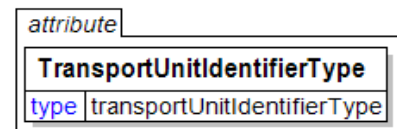

AssignedByAgencyID

A unique identifier that has been assigned by the agency given in the attribute Agency. Attribute Agency is mandatory when AssignedByAgencyID is used.

AssignedByMachineOwnerID

A unique identifier that has been assigned by the owner of the machine.

ContainerID

Defines a container identifier.

CassetteID

Defines a cassette identifier.

GlobalIndividualAssetIdentifier

The Global Individual Asset Identifier (GIAI) is a GS1 Key for asset identification. Companies can apply a GIAI on any asset to uniquely identify and manage that asset. <http://www.gs1.org/>

GlobalReturnableAssetIdentifier

A returnable asset is a reusable package or transport equipment of a certain value. The Global Returnable Asset Identifier (GRAI) provides for the unique

identification of an asset; it utilizes a GS1 assigned Company Prefix enabling a user to develop, assign and maintain a unique asset number for equipment, resources, supplies, etc. in order to track its location and/or user. The GS1 identification number of a returnable asset (GRAI) is defined as a physical item with no reference to the contents. The GS1 identification of a returnable asset (GRAI) enables tracking as well as recording of all relevant data.

<http://www.gs1.org/>

LicencePlateNumber

A licence plate number issued by an official authority.

MachineID

A globally unique identifier for the machine. It is an identifier belonging to the machine independent of the owner of the machine, e.g. a GUID number.

RailCarID

A rail car identifier.

RFTag

To be deprecated in a future version V3R00. Please use `RFTagSerialNumber` instead.

RFTagSerialNumber

The fixed built-in identifier of a RFID unit.

SealNumber

Identifies the seal that closes the transport unit.

SerialShippingContainerCode

The unique identification of logistics units is achieved in the GS1 System by the use of the SSCC (Serial Shipping Container Code). The SSCC is an 18-digit numeric data structure. The uniqueness of the data structure is ensured through the use of the GS1 Company Prefix. This Company Prefix, when combined with the serial number that is assigned by the member company, acts as an identifier or "license plate" and provides access to information stored in computer files, which are transferred through electronic business transactions.

The SSCC should not be confused with the Global Returnable Asset Identifier (GRAI) or Global Individual Asset Identifier (GIAI) of the (serialized) objects within the SSCC object: the SSCC is created in general during packing at a certain party (shipping party) and loses its value after receipt by or after unpacking by another party (the receiving party). The serialized objects within the SSCC container can always be identified by their GRAI or GIAI identifier.

<http://www.gs1.org/>

TrailerID

An identifier that may be used for a DrawBarCombination, a RigidLorry and a Trailer.

Note: papiNet recommends to use `LicencePlateNumber` instead of `TrailerID` in new implementations, if the identifier of the `TransportUnit` indeed is a licence plate number.

VesselUnitID

papiNet V2R31

A vessel unit identifier.

WagonID

Will be deprecated in a future version V3R00. Use instead RailCarID.

Other

Used for any other transport unit identifiers not covered by this list.

TransportUnitLength

The length of the transport unit in a valid UOM (usually meters or feet).

(sequence)

The sequence of items below is mandatory. A single instance is required.

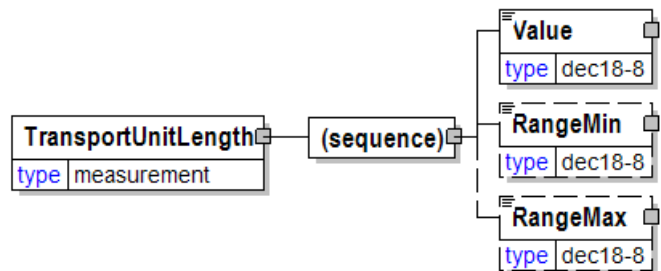

Value

Value is mandatory. A single instance is required.

A numeric value expressed in the unit of measure (UOM).

RangeMin

RangeMin is optional. A single instance might exist.

The minimum value (lower boundary) allowed for the Measurement that is the parent of this element.

RangeMax

RangeMax is optional. A single instance might exist.

The maximum value (upper boundary) allowed for the Measurement that is the parent of this element. Some elements use the RangeMax element with an extended list of unit of measures. (Note: the red colour in the picture is an artifact of how the graphic was captured and should be disregarded.)

TransportUnitLevel [attribute]

The non-zero sequential number that uniquely identifies the level of stacked transport units. The lowest level is assigned number 1.

For example,

A railcar loaded with a container, then the transport unit levels would be railcar level 1 and container level 2.

A railcar loaded with a trailer and a container loaded on the trailer, then the transport unit levels would be railcar level 1, trailer level 2 and container level 3.

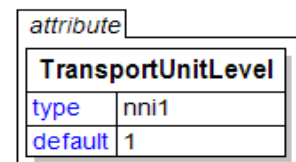

TransportUnitMeasurements

A group item containing the measurements (length, height, weight, and width) of the transport unit.

AppliesTo [attribute]

AppliesTo is optional. A single instance might exist.

Specifies the type of item to which

TransportUnitMeasurements

measurements apply to.

Refer to AppliesTo definition for any enumerations.

IsLoaded [attribute]

IsLoaded is optional. A single instance might exist.

Specifies if the item is loaded or not.

Refer to IsLoaded definition for any enumerations.

(sequence)

The sequence of items below is mandatory. A single instance is required.

TransportUnitLength

TransportUnitLength is optional. A single instance might exist.

The length of the transport unit in a valid UOM (usually meters or feet).

TransportUnitWidth

TransportUnitWidth is optional. A single instance might exist.

The width of the transport unit in a valid UOM (usually meters or feet).

TransportUnitHeight

TransportUnitHeight is optional. A single instance might exist.

The height of the transport unit in a UOM (usually meters or feet).

TransportUnitWeight

TransportUnitWeight is optional. A single instance might exist.

The weight of the transport unit in a valid UOM (usually tons, pounds, or kilograms).

TransportUnitCapacity

TransportUnitCapacity is optional. Multiple instances might exist.

Specifies the capacity of a transport unit, e.g. available volume.

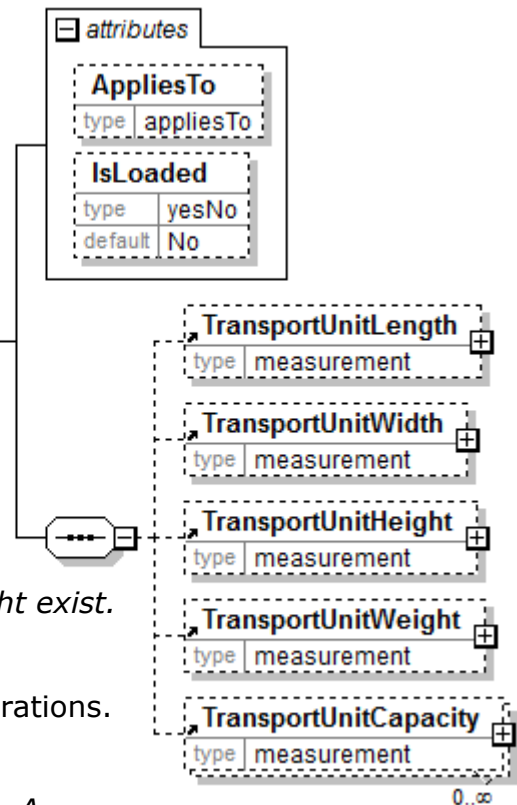

TransportUnitReferenceIDInfo

A group item that defines the relationship between a referenced transport unit and another transport unit.

TransportUnitType [attribute]

TransportUnitType is mandatory. A single instance is required.

Provides general information about the transport unit, which is the unit containing the goods. Transport units only move using power from another source, the transport vehicle. Additional detail can be specified through a detail type.

Refer to TransportUnitType definition for any enumerations.

TransportUnitLevel [attribute]

TransportUnitLevel is mandatory. A single instance is required.

The non-zero sequential number that uniquely identifies the level of stacked transport units. The lowest level is assigned number 1.

For example,

A railcar loaded with a container, then the transport unit levels would be railcar level 1 and container level 2.

A railcar loaded with a trailer and a container loaded on the trailer, then the transport unit levels would be railcar level 1, trailer level 2 and container level 3.

(sequence)

The sequence of items below is mandatory. A single instance is required.

TransportUnitIdentifier

TransportUnitIdentifier is mandatory. One instance is required, multiple instances might exist.

The identifier of the transport unit, for example a license plate number, a container ID etc. The identifier of the transport unit is the same as the identifier of the vehicle when the transport unit is directly mounted on the vehicle and does not have a separate identifier. The type of identifier is indicated by the TransportUnitIdentifierType.

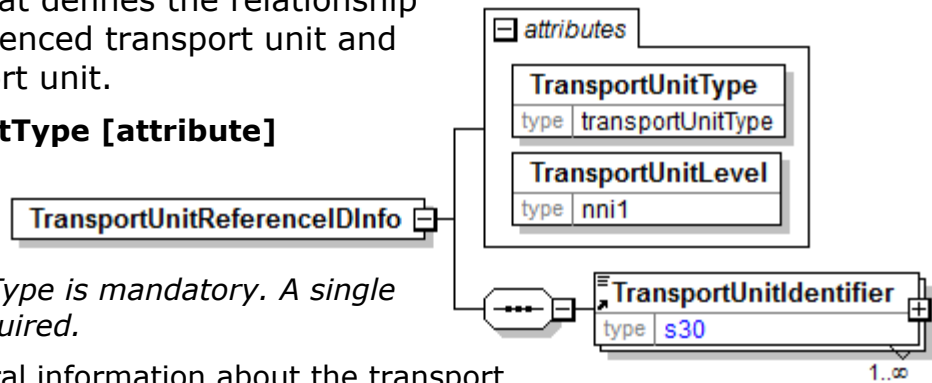

TransportUnitText

A text field further describing the transport unit.

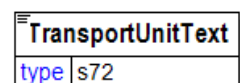

TransportUnitType [attribute]

Provides general information about the transport unit, which is the unit containing the goods. Transport units only move using power from another source, the transport vehicle. Additional detail can be specified through a detail type.

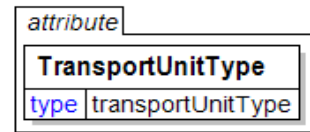

This item is restricted to the following list.

Barge

A flat, inland waterways transport unit, which is typically towed, one or many at the same time, by a towing vessel.

Cassette

A platform used for RORO vessels to roll-on and roll-off goods to be moved.

Container

A generic term for a box to carry goods, strong enough for repeated use, usually stackable and fitted with devices for transfer between modes. There are a number of different types of containers.

ConventionalVessel

To be deprecated in a future version V3R00. Select the best fit from the TransportUnitType list.

DrawBarCombination

A RigidLorry and a DrawBarTrailer combined together and handled as one transport unit. It is typically used in Scandinavian countries.

Flatbed

To be deprecated in a future version V3R00. See detail types.

FlatCar

To be deprecated in a future version V3R00. See detail types.

ForestryForwarderUnit

Carries wood in a body mounted to the chassis of a forestry forwarder.

RailCar

A rail-based transport unit. Synonym: Rail Wagon.

RigidLorry

Carries goods in a body mounted to the chassis of a truck. It can be covered or uncovered. Synonym: Straight Truck.

StackTrain

To be deprecated in a future version V3R00. See detail types.

SwapBodies

To be deprecated in a future version V3R00. See detail types.

Trailer

A road trailer usually pulled by a truck.

VesselUnit

A transport unit for vessels. It is normally a fixed integrated part of the vessel.

Wagon

To be deprecated in a future version V3R00. Use instead transport unit "RailCar" and detail types of railcars.

Other

Used for any other transport units not covered by this list. To be deprecated in a future version V3R00.

TransportUnitVariable [attribute]

Indicates if there is an attribute of the transport unit that can change (is variable).

This item is restricted to the following list.



CubicCapacity

DeckOption

Height

Length

RailcarDoorSize

WeightCarryingCapacity

TransportUnitWeight

The weight of the transport unit in a valid UOM (usually tons, pounds, or kilograms).

(sequence)

The sequence of items below is mandatory. A single instance is required.

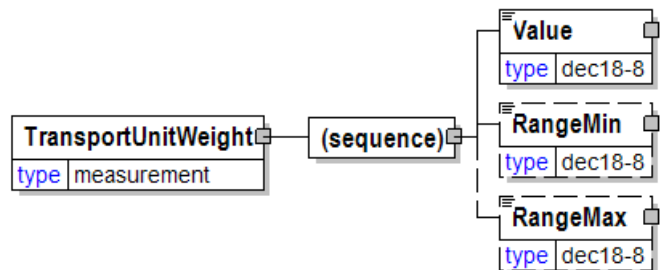

Value

Value is mandatory. A single instance is required.

A numeric value expressed in the unit of measure (UOM).

RangeMin

RangeMin is optional. A single instance might exist.

The minimum value (lower boundary) allowed for the Measurement that is the parent of this element.

RangeMax

RangeMax is optional. A single instance might exist.

The maximum value (upper boundary) allowed for the Measurement that is the parent of this element. Some elements use the RangeMax element with an extended list of unit of measures. (Note: the red colour in the picture is an artifact of how the graphic was captured and should be disregarded.)

TransportUnitWidth

The width of the transport unit in a valid UOM (usually meters or feet).

(sequence)

The sequence of items below is mandatory. A single instance is required.

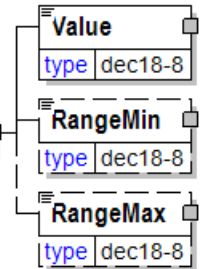
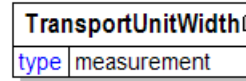

Value

Value is mandatory. A single instance is required.

A numeric value expressed in the unit of measure (UOM).

RangeMin

RangeMin is optional. A single instance might exist.

The minimum value (lower boundary) allowed for the Measurement that is the parent of this element.

RangeMax

RangeMax is optional. A single instance might exist.

The maximum value (upper boundary) allowed for the Measurement that is the parent of this element. Some elements use the RangeMax element with an extended list of unit of measures. (Note: the red colour in the picture is an artifact of how the graphic was captured and should be disregarded.)

TransportUnloadingCharacteristics

A group item defining how the transported items are to be unloaded.

TransportUnloadingType [attribute]

TransportUnloadingType is optional. A single instance might exist.

Defines the primary

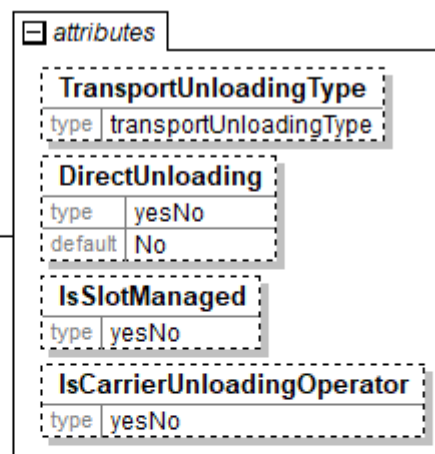
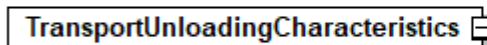

unloading modes for the transport of the goods

Refer to TransportUnloadingType definition for any enumerations.

DirectUnloading [attribute]

DirectUnloading is optional. A single instance might exist.

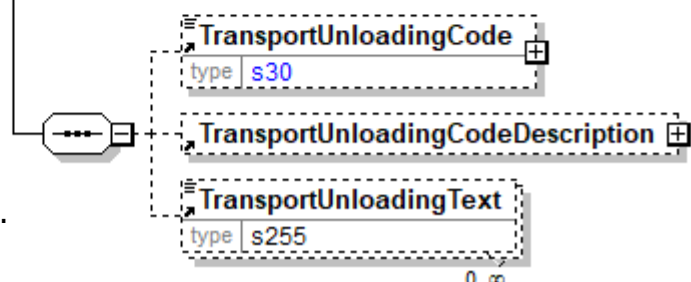

0..∞

Specifies if the transport unit should be unloaded directly on to a new transport unit. Certain transport units, e.g. cassettes, can be stored in warehouses a short period waiting for direct unloading.

Refer to DirectUnloading definition for any enumerations.

IsSlotManaged [attribute]

IsSlotManaged is optional. A single instance might exist.

Specifies if the activity is managed by given slot times for execution of the activity. For example given slot times for unloading of a transport unit.

Refer to IsSlotManaged definition for any enumerations.

IsCarrierUnloadingOperator [attribute]

IsCarrierUnloadingOperator is optional. A single instance might exist.

Specifies if the carrier is the unloading operator or not.

Refer to IsCarrierUnloadingOperator definition for any enumerations.

(sequence)

The sequence of items below is mandatory. A single instance is required.

TransportUnloadingCode

TransportUnloadingCode is optional. A single instance might exist.

A code defining how the transported items are to be unloaded.

TransportUnloadingCodeDescription

TransportUnloadingCodeDescription is optional. A single instance might exist.

A group item describing the TransportUnloadingCode. The document specifying how to unload goods based on the TransportUnloadingCode can be supplied in e-Attachment.

TransportUnloadingText

TransportUnloadingText is optional. Multiple instances might exist.

A text field further describing the transport unloading instructions.

TransportUnloadingCode

A code defining how the transported items are to be unloaded.

Agency [attribute]

Agency is mandatory. A single instance is required.

Describes the agency maintaining the list of codes. To be included in this list the agency must be a recognized standards body or industry organisation.

- For the element that owns this attribute.
- For another attribute in the list of attributes associated with the parent element.

Refer to Agency definition for any enumerations.

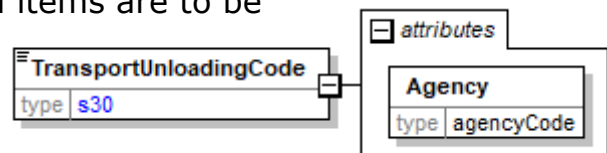

TransportUnloadingCodeDescription

A group item describing the TransportUnloadingCode. The document specifying how to unload goods based on the

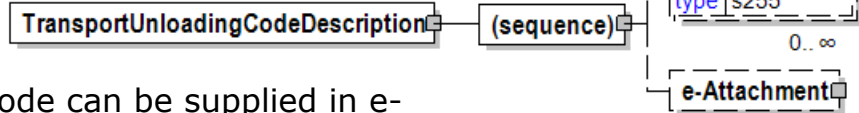

TransportUnloadingCode can be supplied in e-Attachment.

(sequence)

The sequence of items below is mandatory. A single instance is required.

AdditionalText

AdditionalText is optional. Multiple instances might exist.

A text field that is used to communicate information not previously defined or for special instructions. To be used only for circumstances not covered by specific elements.

e-Attachment

e-Attachment is optional. A single instance might exist.

e-Attachment enables the sender to provide information about attachments to the document.

Note: BizTalk users may have problems in processing this element. See the papiNet FAQs (papiNet.org) for more information.

TransportUnloadingText

A text field further describing the transport unloading instructions.

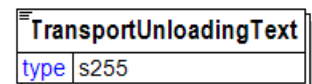

TransportUnloadingType [attribute]

Defines the primary unloading modes for the transport of the goods

This item is restricted to the following list.

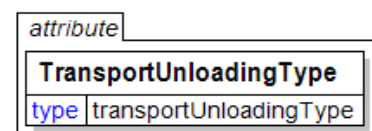

ByUnloadingCode

How to unload the goods is specified via the element TransportUnloadingCode. TransportUnloadingCode can be used as a Load Pattern identifier. A separate document, that can be specified by element TransportUnloadingCodeDescription, specifies the Load Pattern in all details

Lying

The goods, such as reels on the belly, have to be in a lying position after unloading.

Standing

The goods, such as reels standing on end, have to be in a standing position after unloading.

StandingUpsideDown

The goods, such as reels standing on end but turned upside-down in a standing position after unloading. Reels are turned upside-down to get the right unwinding direction at end user.

Other

Used for any other loading modes not covered by this list.

TransportVehicleCharacteristics

A group item containing information about a transport vehicle, e.g. a truck. A transport vehicle has its own power and can be used to pull, push, carry, or tow a transport unit loaded with goods.

TransportVehicleType [attribute]

TransportVehicleType is optional. A single instance might exist.



Provides details on the transport vehicle. A transport vehicle has its own power and can be used to pull, carry, or tow a transport unit loaded with goods.

Refer to TransportVehicleType definition for any enumerations.

ChangesAllowed [attribute]

ChangesAllowed is optional. A single instance might exist.

Indicates if the given information is allowed to be changed or not, i.e. if a logistics partner is bound to execute as instructed or can change instructed requirements.

Refer to ChangesAllowed definition for any enumerations.

(sequence)

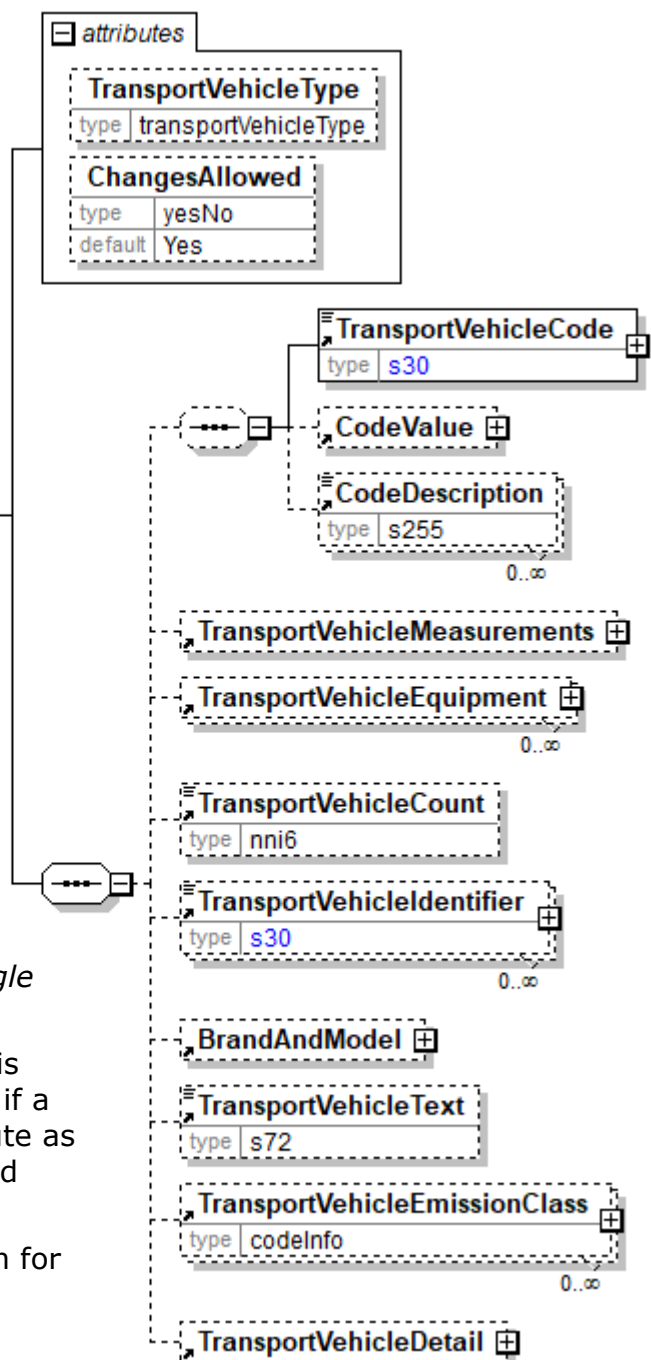

papiNet V2R31

The sequence of items below is mandatory. A single instance is required.

(sequence)

The sequence of items below is optional. A single instance might exist.

TransportVehicleCode

TransportVehicleCode is mandatory. A single instance is required.

A code defining the primary means of transporting the goods.

CodeValue

CodeValue is optional. A single instance might exist.

A grouping element specifying a value belonging to a code that is defined by an agency.

CodeDescription

CodeDescription is optional. Multiple instances might exist.

A textual description for the meaning of a code that is defined by an agency. When the Code is associated with a CodeValue of type TextValue, then the CodeDescription is a textual description of both the Code and the TextValue.

TransportVehicleMeasurements

TransportVehicleMeasurements is optional. A single instance might exist.

A group item containing the measurements (length, height, weight, and width) of the transport vehicle.

TransportVehicleEquipment

TransportVehicleEquipment is optional. Multiple instances might exist.

A group item defining extra equipment of the transport vehicle.

TransportVehicleCount

TransportVehicleCount is optional. A single instance might exist.

The number of vehicles used to transport the goods.

TransportVehicleIdentifier

TransportVehicleIdentifier is optional. Multiple instances might exist.

The identifier of the transport vehicle, for example a license plate number, a voyage number, a vessel name etc. The type of identifier is indicated by the TransportVehicleIdentifierType.

BrandAndModel

BrandAndModel is optional. A single instance might exist.

A grouping element containing information about brand and model for an item.

TransportVehicleText

TransportVehicleText is optional. A single instance might exist.

A text field further describing the transport vehicle.

TransportVehicleEmissionClass

TransportVehicleEmissionClass is optional. Multiple instances might exist.

A group item that contains the emission classification of the transport vehicle specified by an agency.

TransportVehicleDetail

papiNet V2R31

TransportVehicleDetail is optional. A single instance might exist.

A group item describing details for a transport vehicle.

TransportVehicleCode

A code defining the primary means of transporting the goods.

Agency [attribute]

Agency is mandatory. A single instance is required.

Describes the agency maintaining the list of codes. To be included in this list the agency must be a recognized standards body or industry organisation.

- For the element that owns this attribute.
- For another attribute in the list of attributes associated with the parent element.

Refer to Agency definition for any enumerations.

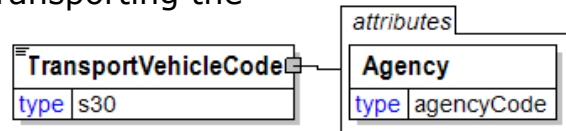

TransportVehicleCount

The number of vehicles used to transport the goods.

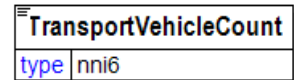

TransportVehicleDetail

A group item describing details for a transport vehicle.

RearCouplingType [attribute]

RearCouplingType is optional. A single instance might exist.

Specifies the rear coupling device that attaches a vehicle or a transport unit to the transport unit. For example attaches a truck to a trailer or a trailer to another trailer.

Refer to RearCouplingType definition for any enumerations.

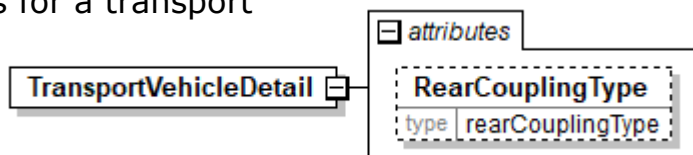

TransportVehicleEmissionClass

A group item that contains the emission classification of the transport vehicle specified by an agency.

Agency [attribute]

Agency is mandatory. A single instance is required.

Describes the agency maintaining the list of codes. To be included in this list the agency must be a recognized standards body or industry organisation.

- For the element that owns this attribute.
- For another attribute in the list of attributes associated with the parent element.

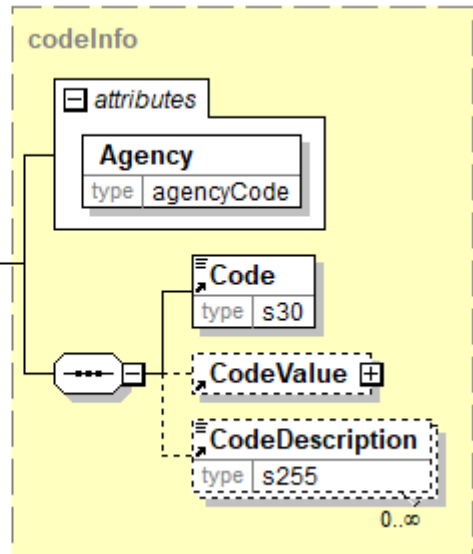

Refer to Agency definition for any enumerations.

(sequence)

The sequence of items below is mandatory. A single instance is required.

Code

Code is mandatory. A single instance is required.

Specifies a code that is defined by an agency. The agency is given for the whole construct containing the code.

CodeValue

CodeValue is optional. A single instance might exist.

A grouping element specifying a value belonging to a code that is defined by an agency.

CodeDescription

CodeDescription is optional. Multiple instances might exist.

A textual description for the meaning of a code that is defined by an agency. When the Code is associated with a CodeValue of type TextValue, then the CodeDescription is a textual description of both the Code and the TextValue.

TransportVehicleEquipment

A group item defining extra equipment of the transport vehicle.

(sequence)

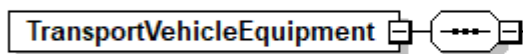

The sequence of items below is mandatory. A single instance is required.

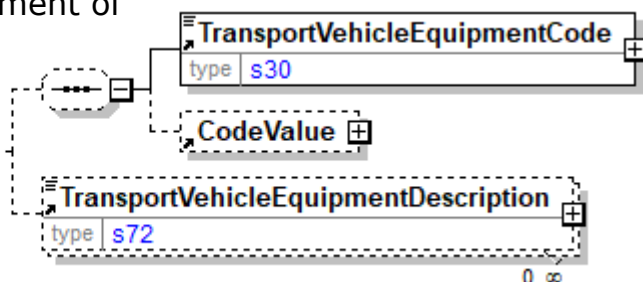

(sequence)

The sequence of items below is optional. A single instance might exist.

TransportVehicleEquipmentCode

TransportVehicleEquipmentCode is mandatory. A single instance is required.

TransportVehicleEquipmentCode is a code describing extra equipment of the transport vehicle.

CodeValue

CodeValue is optional. A single instance might exist.

A grouping element specifying a value belonging to a code that is defined by an agency.

TransportVehicleEquipmentDescription

TransportVehicleEquipmentDescription is optional. Multiple instances might exist.

A text field element describing the extra equipment of the transport vehicle. When a TransportVehicleEquipmentCode is associated with a CodeValue of type TextValue, then the TransportVehicleEquipmentDescription is a textual description of both the TransportVehicleEquipmentCode and the TextValue.

TransportVehicleEquipmentCode

TransportVehicleEquipmentCode is a code describing extra equipment of the transport vehicle.



Agency [attribute]

Agency is mandatory. A single instance is required.

Describes the agency maintaining the list of codes. To be included in this list the agency must be a recognized standards body or industry organisation.

- For the element that owns this attribute.
- For another attribute in the list of attributes associated with the parent element.

Refer to Agency definition for any enumerations.

TransportVehicleEquipmentDescription

A text field element describing the extra equipment of the transport vehicle.

When a

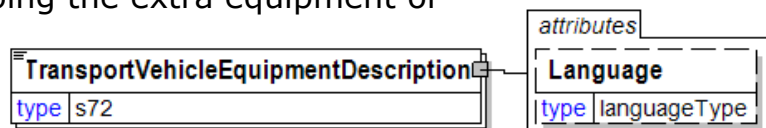

TransportVehicleEquipmentCode is associated with a CodeValue of type TextValue, then the TransportVehicleEquipmentDescription is a textual description of both the TransportVehicleEquipmentCode and the TextValue.

Language [attribute]

Language is optional. A single instance might exist.

papiNet V2R31

The valid Alpha 2- and Alpha 3-character list of language codes in the ISO 639-1 and 639-2 international standards.

Information on the content of this attribute is available at:
https://www.loc.gov/standards/iso639-2/php/code_list.php

TransportVehicleHeight

The number of vehicles used to transport the goods.

(sequence)

The sequence of items below is mandatory. A single instance is required.

Value

Value is mandatory. A single instance is required.

A numeric value expressed in the unit of measure (UOM).

RangeMin

RangeMin is optional. A single instance might exist.

The minimum value (lower boundary) allowed for the Measurement that is the parent of this element.

RangeMax

RangeMax is optional. A single instance might exist.

The maximum value (upper boundary) allowed for the Measurement that is the parent of this element. Some elements use the RangeMax element with an extended list of unit of measures. (Note: the red colour in the picture is an artifact of how the graphic was captured and should be disregarded.)

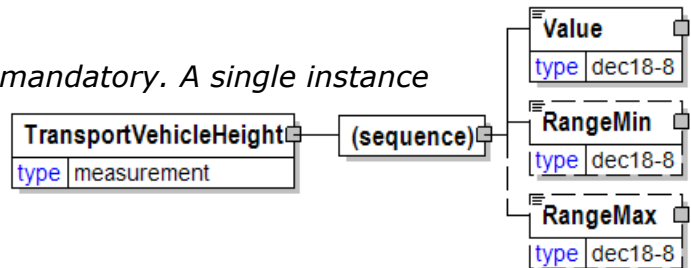

TransportVehicleIdentifier

The identifier of the transport vehicle, for example a license plate number, a voyage number, a vessel name etc. The type of identifier is indicated by the TransportVehicleIdentifierType.

TransportVehicleIdentifierType [attribute]

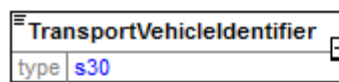

TransportVehicleIdentifierType is optional. A single instance might exist.

Provides a contextual definition for the value used to identify the transport vehicle.

Refer to TransportVehicleIdentifierType definition for any enumerations.

StateOrProvince [attribute]

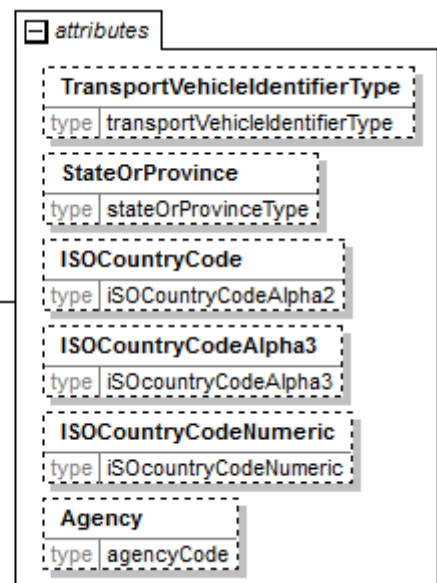

StateOrProvince is optional. A single instance might exist.

The political designation or boundary of a specific area of land.

ISOCountryCode [attribute]

ISOCountryCode is optional. A single instance might exist.

The valid Alpha 2-character list of officially assigned country codes in the ISO 3166-1 international standard.

Information on the content of this attribute is available at:

<https://www.iso.org/obp/ui/#search>

ISOCountryCodeAlpha3 [attribute]

ISOCountryCodeAlpha3 is optional. A single instance might exist.

The valid Alpha 3-character list of officially assigned country codes in the ISO 3166-1 international standard.

Information on the content of this attribute is available at:

<https://www.iso.org/obp/ui/#search>

ISOCountryCodeNumeric [attribute]

ISOCountryCodeNumeric is optional. A single instance might exist.

The valid Numeric 3-digit list of officially assigned country codes in the ISO 3166-1 international standard.

Information on the content of this attribute is available at:

<https://www.iso.org/obp/ui/#search>

Agency [attribute]

Agency is optional. A single instance might exist.

Describes the agency maintaining the list of codes. To be included in this list the agency must be a recognized standards body or industry organisation.

- For the element that owns this attribute.
- For another attribute in the list of attributes associated with the parent element.

Refer to Agency definition for any enumerations.

TransportVehicleIdentifierType [attribute]

Provides a contextual definition for the value used to identify the transport vehicle.

This item is restricted to the following list.

attribute
TransportVehicleIdentifierType
type transportVehicleIdentifierType

AssignedByAgencyID

A unique identifier that has been assigned by the agency given in the attribute Agency. Attribute Agency is mandatory when AssignedByAgencyID is used.

AssignedByMachineOwnerID

A unique identifier that has been assigned by the owner of the machine.

FlightNumber

A flight number.

GlobalIndividualAssetIdentifier

The Global Individual Asset Identifier (GIAI) is a GS1 Key for asset identification. Companies can apply a GIAI on any asset to uniquely identify and manage that asset. <http://www.gs1.org/>

GlobalReturnableAssetIdentifier

To be deprecated in a future version V3R00.

IMONumber

An identifier type for a Vessel.

LicencePlateNumber

A licence plate number issued by an official authority.

MachineID

A globally unique identifier for the machine. It is an identifier belonging to the machine independent of the owner of the machine, e.g. a GUID number.

RadioCallSign

An identifier type for a Vessel

RFTag

a in a future version V3R00. Please use RFTagSerialNumber instead.

RFTagSerialNumber

The fixed built-in identifier of a RFID unit.

SerialisedShippingContainerCode

To be deprecated in a future version V3R00.

StandardCarrierAlphaCode

The code used to identify the carrier by the applicable governing body.

TrainNumber

The official identifier assigned by the railways to this particular train movement.

VesselName

The registered name of the vessel.

VoyageNumber

The official identifier assigned for the voyage, usually by port authorities. Also known as Unique Voyage Identifier, UVI.

Other

Used for any other transport vehicle identifiers not covered by this list.

TransportVehicleLength

The length of the transport vehicle in a valid UOM (usually meters or feet).

(sequence)

The sequence of items below is mandatory. A single instance is required.

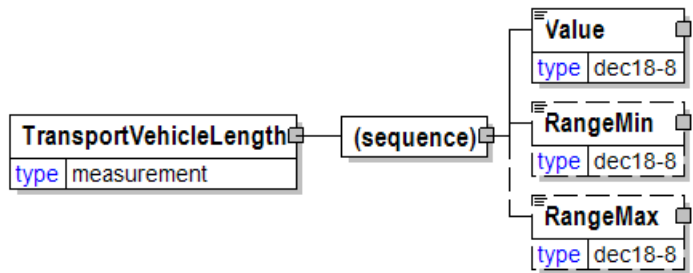

Value

Value is mandatory. A single instance is required.

A numeric value expressed in the unit of measure (UOM).

RangeMin

RangeMin is optional. A single instance might exist.

The minimum value (lower boundary) allowed for the Measurement that is the parent of this element.

RangeMax

RangeMax is optional. A single instance might exist.

The maximum value (upper boundary) allowed for the Measurement that is the parent of this element. Some elements use the RangeMax element with an extended list of unit of measures. (Note: the red colour in the picture is an artifact of how the graphic was captured and should be disregarded.)

TransportVehicleMeasurements

A group item containing the measurements (length, height, weight, and width) of the transport vehicle.

(sequence)

The sequence of items below is mandatory. A single instance is required.

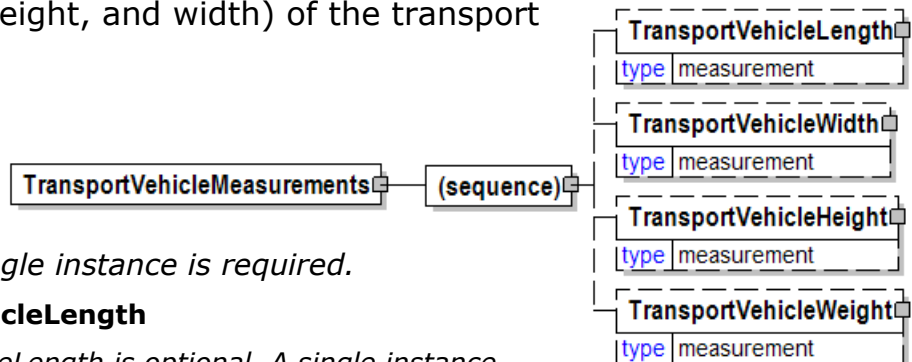

TransportVehicleLength

TransportVehicleLength is optional. A single instance might exist.

The length of the transport vehicle in a valid UOM (usually meters or feet).

TransportVehicleWidth

TransportVehicleWidth is optional. A single instance might exist.

The width of the transport vehicle in a valid UOM (usually meters or feet).

TransportVehicleHeight

TransportVehicleHeight is optional. A single instance might exist.

The number of vehicles used to transport the goods.

TransportVehicleWeight

TransportVehicleWeight is optional. A single instance might exist.

papiNet V2R31

The weight of the transport vehicle in a valid UOM (usually tons, pounds, or kilograms).

TransportVehicleText

A text field further describing the transport vehicle.

TransportVehicleText	
type	s72

TransportVehicleType [attribute]

Provides details on the transport vehicle. A transport vehicle has its own power and can be used to pull, carry, or tow a transport unit loaded with goods.

attribute	
TransportVehicleType	
type	transportVehicleType

This item is restricted to the following list.

Barge

A flat, inland waterways vessel.

ContainerVessel

A vessel for sea transports designed to carry containers. This type will be deprecated in a future version V3R00. Please use type Vessel instead and specify detail type if needed by using element TransportUnitDetail.

ConventionalVessel

A vessel for sea transports, loaded/unloaded by LOLO (lift-on/lift-off method). This type will be deprecated in a future version V3R00. Please use type Vessel instead and specify detail type if needed by using element TransportUnitDetail.

ForestryForwarder

A forestry vehicle that carries felled logs and other wood from the stump to a roadside landing. It carries wood clear of the ground and is typically employed in cut-to-length logging operations.

RollOnOffShip

A vessel for sea transport, loaded/unloaded by RORO (roll-on/roll-off method). This type will be deprecated in a future version V3R00. Please use type Vessel instead and specify detail type if needed by using element TransportUnitDetail.

SidePortVessel

A vessel for sea transport, loaded/unloaded through side ports in the vessel side. This type will be deprecated in a future version V3R00. Please use type Vessel instead and specify detail type if needed by using element TransportUnitDetail.

Train

A rail-based vehicle for towing of railcars.

Truck

A road vehicle for carrying, pulling or towing of transport units. Other used names are Tractor and Lorry.

TruckTrailer

To be deprecated in a future version V3R00. Use Truck instead.

Tug

A water vehicle used for pulling or pushing.

Vessel

A vehicle for sea transports.

Other

Used for any other transport vehicles not covered by this list.

TransportVehicleWeight

The weight of the transport vehicle in a valid UOM (usually tons, pounds, or kilograms).

(sequence)

The sequence of items below is mandatory. A single instance is required.

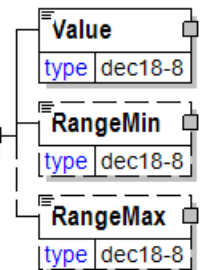
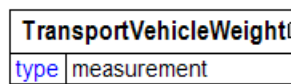

Value

Value is mandatory. A single instance is required.

A numeric value expressed in the unit of measure (UOM).

RangeMin

RangeMin is optional. A single instance might exist.

The minimum value (lower boundary) allowed for the Measurement that is the parent of this element.

RangeMax

RangeMax is optional. A single instance might exist.

The maximum value (upper boundary) allowed for the Measurement that is the parent of this element. Some elements use the RangeMax element with an extended list of unit of measures. (Note: the red colour in the picture is an artifact of how the graphic was captured and should be disregarded.)

TransportVehicleWidth

The width of the transport vehicle in a valid UOM (usually meters or feet).

(sequence)

The sequence of items below is mandatory. A single instance is required.

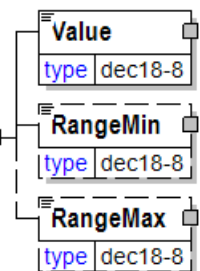
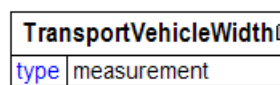

Value

Value is mandatory. A single instance is required.

A numeric value expressed in the unit of measure (UOM).

RangeMin

RangeMin is optional. A single instance might exist.

The minimum value (lower boundary) allowed for the Measurement that is the parent of this element.

RangeMax

RangeMax is optional. A single instance might exist.

The maximum value (upper boundary) allowed for the Measurement that is the parent of this element. Some elements use the RangeMax element with an extended list of unit of measures. (Note: the red colour in the picture is an artifact of how the graphic was captured and should be disregarded.)

TrayColourType [attribute]

The type of tray colour.

This item is restricted to the following list.

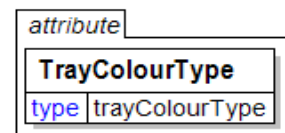

Clear

The tray colour is clear.

Coloured

Frosted

Graphite

StandardGray/Brown

The tray colour is standard gray or brown.

White

The tray colour is white.

Other

Another colour is used.

TreeSpeciesGroup

A grouping element that details information used for describing tree species.

(sequence)

The sequence of items below is mandatory. A single instance is required.

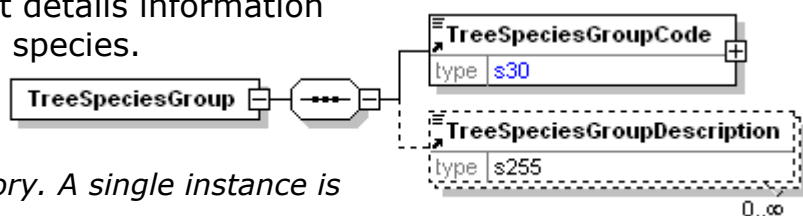

TreeSpeciesGroupCode

TreeSpeciesGroupCode is mandatory. A single instance is required.

A code defining tree species or groups of tree species.

TreeSpeciesGroupDescription

TreeSpeciesGroupDescription is optional. Multiple instances might exist.

A text description of the tree species group.

TreeSpeciesGroupCode

A code defining tree species or groups of tree species.

Agency [attribute]

Agency is mandatory. A single instance is required.

Describes the agency maintaining the list of codes. To be included in this list the agency must be a recognized standards body or industry organisation.

- For the element that owns this attribute.
- For another attribute in the list of attributes associated with the parent element.

Refer to Agency definition for any enumerations.

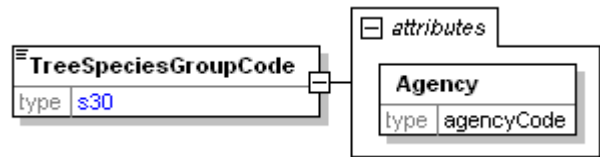

TreeSpeciesGroupDescription

A text description of the tree species group.

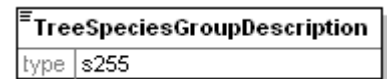

Trim

Trim

TrimType [attribute]

TrimType is optional. A single instance might exist.

Trim type

Refer to TrimType definition for any enumerations.

(sequence)

The sequence of items below is mandatory. A single instance is required.

AdditionalText

AdditionalText is optional. A single instance might exist.

A text field that is used to communicate information not previously defined or for special instructions. To be used only for circumstances not covered by specific elements.

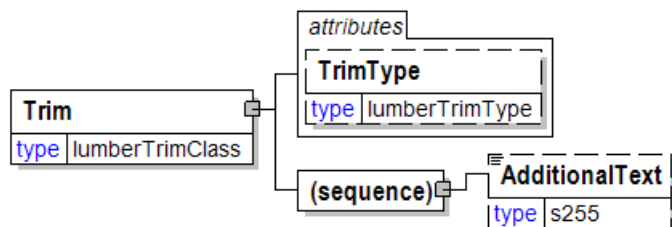

TrimmedOrderType

Trimmed Order Type

This item is restricted to the following list.

Explicit

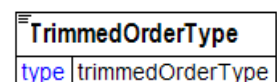

Implicit

TrimmedReel

Trimmed reel

(sequence)

The sequence of items below is mandatory. A single instance is required.

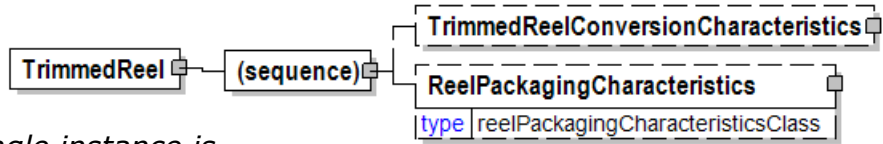

TrimmedReelConversionCharacteristics

TrimmedReelConversionCharacteristics is optional. A single instance might exist. Conversion characteristics associated with a trimmed reel.

ReelPackagingCharacteristics

ReelPackagingCharacteristics is optional. A single instance might exist.

A group item that lists the packaging elements describing how a reel should be packed.

TrimmedReelConversionCharacteristics

Conversion characteristics associated with a trimmed reel.

(sequence)

The sequence of items below is mandatory. A single instance is required.

WindingDirection

WindingDirection is optional. A single instance might exist.

An element that indicates how the material is wound on the reel.

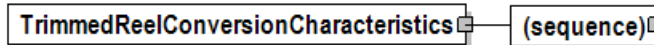

Refer to WindingDirection definition for any enumerations.

TrimmedOrderType

TrimmedOrderType is optional. A single instance might exist.

Trimmed Order Type

Refer to TrimmedOrderType definition for any enumerations.

MasterReelWidth

MasterReelWidth is optional. A single instance might exist.

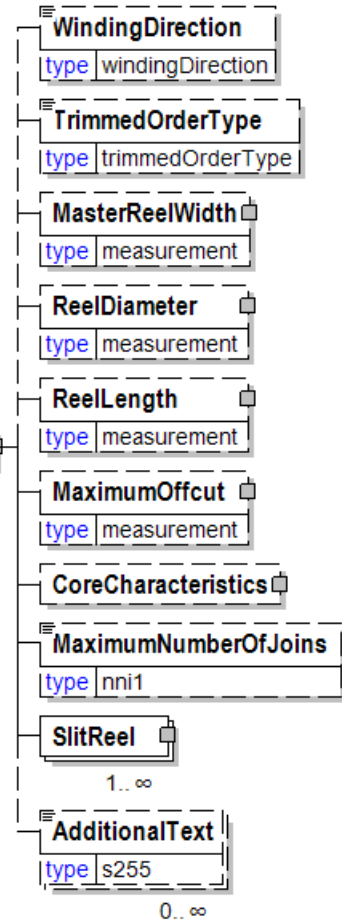

papiNet V2R31

exist.

The master reel width.

ReelDiameter

ReelDiameter is optional. A single instance might exist.

The diameter measurement of reel excluding packaging.

ReelLength

ReelLength is optional. A single instance might exist.

The total length of the paper on the reel.

MaximumOffcut

MaximumOffcut is optional. A single instance might exist.

Maximum off cut.

CoreCharacteristics

CoreCharacteristics is optional. A single instance might exist.

A group item that details information used to fully define a core.

MaximumNumberOfJoins

MaximumNumberOfJoins is optional. A single instance might exist.

The maximum number of joins requested (permitted). Permits customers to indicate join-free reels.

SlitReel

SlitReel is mandatory. One instance is required, multiple instances might exist.

The SlitReel element represents the elements associated with reel that has been slit into multiple reels.

AdditionalText

AdditionalText is optional. Multiple instances might exist.

A text field that is used to communicate information not previously defined or for special instructions. To be used only for circumstances not covered by specific elements.

TrimSize

Trim size.

(sequence)

The sequence of items below is mandatory. A single instance is required.

Length

Length is mandatory. A single instance is required.

The length of the object.

Width

Width is mandatory. A single instance is required.

The width of the object.

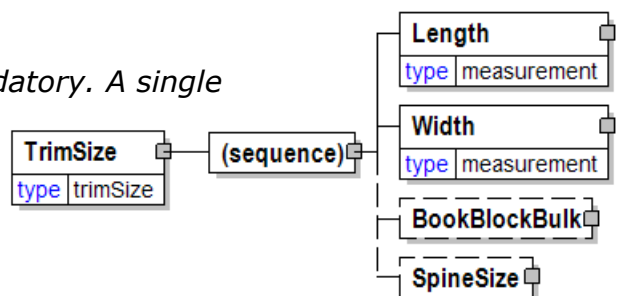

BookBlockBulk

BookBlockBulk is optional. A single instance might exist.

Measurement of the thickness of the book block.

SpineSize

SpineSize is optional. A single instance might exist.

The height of the spine.

TrimType [attribute]

Trim type

This item is restricted to the following list.

DET

PET

SquareEndTrim

Other

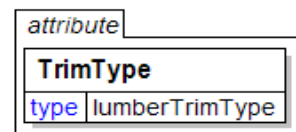

TwoSigmaLower

Two sigma (a measure of dispersion associated with standard deviation) on the lower side of the standard deviation.

UOM [attribute]

UOM is mandatory. A single instance is required.

Defines the unit of measure for the value.

Refer to UOM definition for any enumerations.

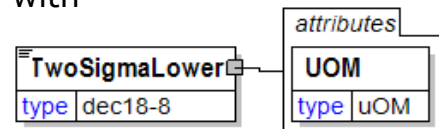

TwoSigmaUpper

Two sigma (a measure of dispersion associated with standard deviation) on the upper side of the standard deviation.

UOM [attribute]

UOM is mandatory. A single instance is required.

Defines the unit of measure for the value.

Refer to UOM definition for any enumerations.

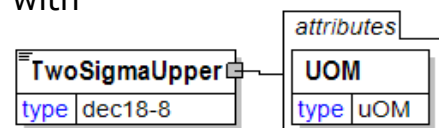

TypePageSize

The printed area of a page.

(sequence)

The sequence of items below is mandatory. A single instance is required.

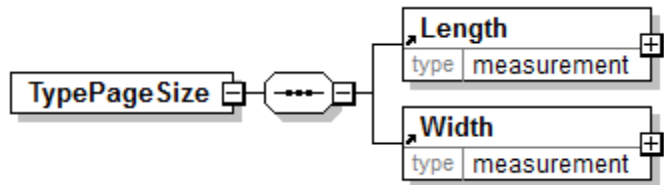

Length

Length is mandatory. A single instance is required.

The length of the object.

Width

Width is mandatory. A single instance is required.

The width of the object.

UnCompletedMeasurement [attribute]

Indicates if the measuring of an item is uncompleted, i.e. if some measurement values are missing.

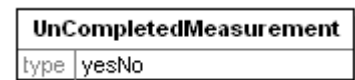

This item is restricted to the following list.

Yes

No

UnevenSpacing

Uneven Spacing

(sequence)

The sequence of items below is mandatory. A single instance is required.

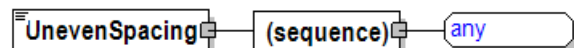

[Any Type]

Any type of content is permitted at this point.

UnitCharacteristics

Unit characteristics.

(sequence)

The sequence of items below is mandatory. A single instance is required.

Height

Height is optional. A single instance might exist.

The height of the object.

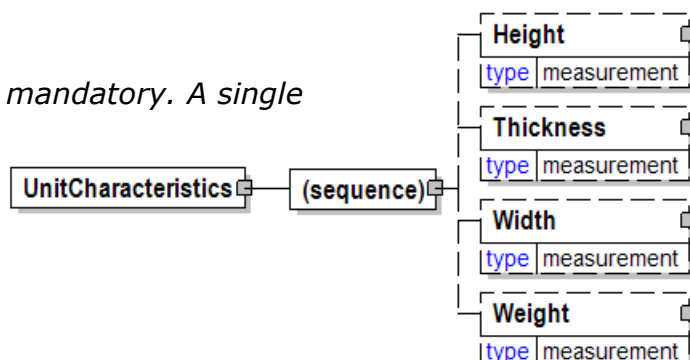

Thickness

Thickness is optional. A single instance might exist.

Physical dimension of a product.

Width

Width is optional. A single instance might exist.

The width of the object.

Weight

Weight is optional. A single instance might exist.

The weight of the item.

UnitDimension

Unit Dimension

(sequence)

The sequence of items below is mandatory. A single instance is required.

Length

Length is optional. A single instance might exist.

The following approach is used in the timber/lumber related constructs.

Width

Width is optional. A single instance might exist.

The approach for width used in the timber/lumber related constructs.

Height

Height is optional. A single instance might exist.

The height of the object. (Used in wood/timber items.)

PiecesPerRow

PiecesPerRow is optional. A single instance might exist.

This element details the number of pieces or individual items that are to be placed/packaged in a row within the unit. Usually used to identify the standard number of pieces in a standard packaging unit of the product.

RowsPerUnit

RowsPerUnit is optional. A single instance might exist.

The number of rows of items, are to be placed/packaged within the unit. Usually used to identify the standard number of rows in a standard packaging unit of the product.

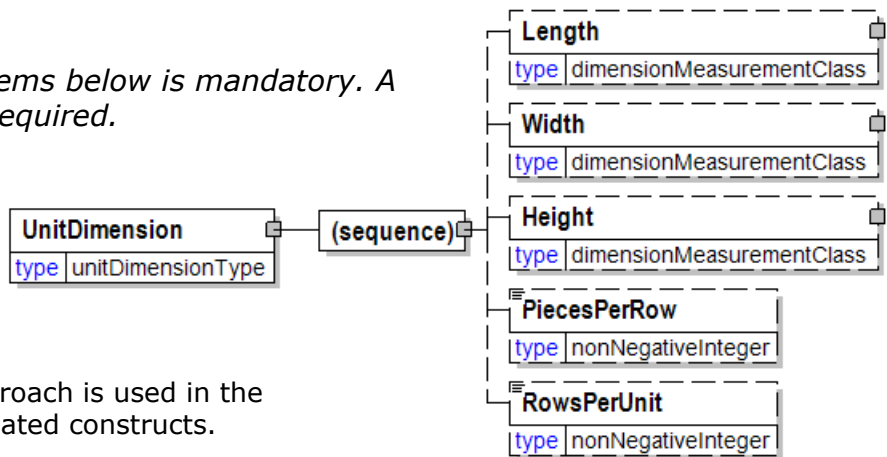

UnitItem

Unit Item.

(sequence)

The sequence of items below is mandatory. A single instance is required.

Identifier

Identifier is optional. Multiple instances might exist.

An Identifier is required for packages and items (pallets, reel packages, boxes, ream items, reel items, etc). The Identifier element contains the actual item identifier code. Identifier is repeatable so more than one identifier can be communicated. For example, the printed identifier on a label may be different from the barcode printed on the label.



Product

Product is optional. A single instance might exist.

Product is a group item defining the article and its characteristics. Product is used to specify product characteristics organized by ProductIdentifier, ProductDescription, and Classification. Book Manufacturing, Label Stock, Paper, Pulp, Recovered Paper, Wood Products, and Virgin Fibre market segments have defined their product characteristics and conversion features for implementation in papiNet.

UnitCharacteristics

UnitCharacteristics is optional. A single instance might exist.

Unit characteristics.

Quantity

Quantity is optional. A single instance might exist.

The Quantity element contains attributes that provide information about the type of quantity that is being communicated, the context in which the particular quantity is to be viewed, and (if the quantity represents an adjustment) an adjustment type.

The Quantity element contains three child elements that enable you to communicate a range of values for the quantity and a target or actual value. It is at this level (Value, RangeMin, and RangeMax) that the unit of measure is specified. This permits the range to be specified in a different unit of measure than the target.

InformationalQuantity

InformationalQuantity is optional. Multiple instances might exist.

A quantity given in a valid UOM used for information purposes only (not for calculation). For example, an ordered quantity was 100 reels as opposed to the invoice quantity of 20,000 pounds.

UnitReference

UnitReference is optional. Multiple instances might exist.

An element detailing relevant references pertaining to the Unit. The type of reference is identified by the attributes UnitReferenceType and AssignedBy.

OtherDate

OtherDate is optional. Multiple instances might exist.

A date that may not be specifically detailed within a document (example: print date at the PurchaseOrderLineItem).

SafetyAndEnvironmentalInformation

SafetyAndEnvironmentalInformation is optional. Multiple instances might exist.

Name of certification type, if any, on the goods (For example, FSC, PEFC). SafetyAndEnvironmental needs a value or measurement to communicate the percentage of the product is certified (for example, 75% is certified by the indicated agency).

UnitReference

An element detailing relevant references pertaining to the Unit. The type of reference is identified by the attributes UnitReferenceType and AssignedBy.

UnitReferenceType [attribute]

UnitReferenceType is mandatory. A single instance is required.

Provides a contextual explanation of the specific reference identifier. Many items are currently prefixed by "Buyer", "Forwarder", "Manufacturer", "Mill", "Seller", "Supplier", "Warehouse", or "Vendor". Check for an existing non-prefixed version and use the non-prefixed version instead. In the (yet to be announced release date) version 3.0 the prefixed versions will be removed. Instead the attribute @AssignedBy will communicate the information previously communicated in the prefix.

Refer to UnitReferenceType definition for any enumerations.

AssignedBy [attribute]

AssignedBy is optional. A single instance might exist.

Identifies the type of party or the agency that has assigned the associated item, e.g. a reference of type OrderNumber.

Refer to AssignedBy for any enumerations.

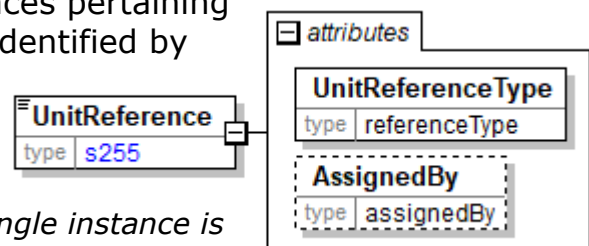

UnitReferenceType [attribute]

Provides a contextual explanation of the specific reference identifier. Many items are currently prefixed by "Buyer", "Forwarder", "Manufacturer", "Mill", "Seller", "Supplier", "Warehouse" or "Vendor". Check for an existing non-prefixed version and use the non-prefixed version instead. In the (yet to be

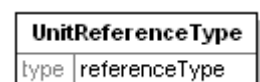

papiNet V2R31

announced release date) version 3.0 the prefixed versions will be removed. Instead the attribute AssignedBy will communicate the information previously communicated in the prefix.

Refer to the [referenceType](#) entry for the list of enumerations and their definitions.

UnitsPerCarton

The number of units per box.

(sequence)

The sequence of items below is mandatory. A single instance is required.

Value

Value is mandatory. A single instance is required.

A numeric value expressed in the unit of measure (UOM).

RangeMin

RangeMin is optional. A single instance might exist.

The minimum value (lower boundary) allowed for the Measurement that is the parent of this element.

RangeMax

RangeMax is optional. A single instance might exist.

The maximum value (upper boundary) allowed for the Measurement that is the parent of this element. Some elements use the RangeMax element with an extended list of unit of measures. (Note: the red colour in the picture is an artifact of how the graphic was captured and should be disregarded.)

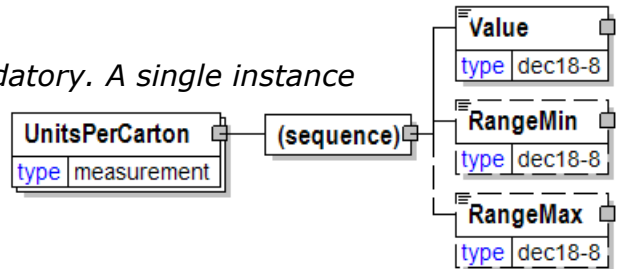

UOM [attribute]

Defines the unit of measure for the value.

This item is restricted to the following list.

AirDryMetricTonne

A unit of measure that identifies the product as 1000 kilograms of product that has been calculated based on an accepted standard representing the contents to be 90% fibre and 10% moisture and adjusted using a moisture percentage test. The AirDryMetricTonne is calculated as $GrossWeight \times (100 - moisture\% / 90)$

AirDryPercent

The percentage measured at the time of production using the air dry industry standard (90% fibre, 10% moisture) therefore, $102 \text{ AirDryPercent} = 102 \text{ AirDryPercent} / 100 * 90\% = 91.8\% \text{ fibres}$.

AirDryShortTon

A unit of measure that identifies the product as 2000 pounds of product that has been calculated based on an accepted standard representing the contents

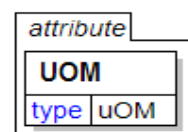

papiNet V2R31

to be 90% fibre and 10% moisture and further adjusted using a moisture percentage test. The AirDryShortTon is calculated as $\text{GrossWeight} \times (100 - \text{moisture}\% / 90)$

Bale

The value is a count of bales. A single or rectangular grouping of product

BoardFoot

The value is expressed in board feet.

BookUnit

A copy of a book.

Box

The value is a count of boxes.

Bundle

The value is a count of bundles.

C-Size

Celsius

The value is in Celsius temperature degrees.

Centimeter

The value is expressed in centimetres.

CentimeterPerSecond

Centimeter per second

Cord

One cord of wood equals 128 cubic feet, or a pile of wood 4 feet high, 4 feet thick and 8 feet long.

CubicCentimeterPerGram

Cubic centimeter per gram

CubicCentimeterPerSecond

Cubic centimeter per second

CubicFoot

The value is expressed in cubic feet.

CubicInchesPerSecond

Cubic inches per second

CubicMeter

The value is expressed in cubic meter.

CubicMeterKilometer

The value is expressed as a volume in CubicMeter times a distance in Kilometer, e.g. the unit price for transporting one cubicmeter of wood one kilometer.

CubicMeterPerKilogram

papiNet V2R31

Cubic meter per kilogram

Cubit

The English cubit is 18 inches long (46 cm).

Day

The duration of time equal to 24 hours.

Decilitre

The value is expressed in decilitres.

Decimeter

The value is expressed in decimeters.

Degree

Degree

DegreesSchopperRiegler

Degree Schopper Riegler

DotsPerInch

An indication of image resolution.

Envelope

An envelope.

Fahrenheit

Fahrenheit

Foot

The value is expressed in feet.

Gallon

The value is in gallons.

Gauge

A unit of measure for diameter and thickness, e.g. for a wire or flat pieces such as sheet metal, thin plastic and film stock.

Gram

The value is expressed in grams.

GramCentimeter

GramForce

GramPerCubicCentimeter

GramPerMeter

GramsPerSquareMeter

The value is expressed in grams per square meter (g/m²).

Hectare

The value is expressed in hectares (10000 square meters).

Hour

papiNet V2R31

The value is expressed in hours.

HundredBoardFeet

HundredLinealFeet

HundredPound

The value is expressed in hundreds of pounds or hundredweight.

HundredSquareFeet

ImpressionCount

The measurement is in number of printed impressions.

Inch

The value is expressed in inches.

JoulePerSquareMeter

Kilogram

The value is expressed in kilograms.

KilogramCO2e

The value is expressed in equivalent kilograms of carbon dioxide (CO₂). A common unit of measure for greenhouse gas (GHG) emissions.

KilogramCO2ePerMetricTon

The value is expressed in equivalent kilograms of carbon dioxide (CO₂) per metric ton. A common unit of measure for greenhouse gas (GHG) emissions.

KilogramForcePerSquareCentimeter

KilogramForcePerCentimeter

KilogramPerCubicMeter

KilogramPerSquareMeter

KilogramsPerDay

The value is expressed in kilograms per day.

KilogramsPerWeek

The value is expressed in kilograms per week.

Kilometer

The value is expressed in kilometres.

KiloNewton

KiloNewtonPerMeter

KiloPascal

KiloWattHour

The value is expressed in kilowatt hours (kWh).

KiloWattHourPerMetricTon

The value is expressed in kilowatt hours (kWh) per metric ton.

KnownBreaks

Known breaks

Layer

The value is a count of layers (for example, the number of boxes per layer on a pallet).

Leaves

Leaves

LinearFoot

The value is expressed in linear feet.

LinesPerInch

Lines Per Inch.

Litre

The value is expressed in litres.

Load

The value is a count of shipment loads.

Log

A cut portion of a stem.

LogPile

A pile of logs (a virtual type of package).

LooseVolumeItem

A unit containing loose volume products (during transports) (a type of virtual package).

MagazineUnit

A copy of a magazine.

Megabyte

A unit of information equal to 1,048,576 bytes or 1024 kilobytes.

MegaJoulePerKilogram

The value is expressed in MegaJoule per kilogram.

MegaWattHour

The value is expressed in megawatt hours (MWh).

MegaWattHourPerMetricTon

The value is expressed in megawatt hours (MWh) per metric ton.

Meter

The value is expressed in meters.

MeterPerSecond

The value is in meters per second.

MetricTon

The value is expressed in metric tons (in other words, in 1000-kilogram units).

MetricTonKilometer

The value is expressed as a weight in MetricTon times a distance in Kilometer, e.g. the unit price for transporting one metric ton of wood one kilometer.

MetricTonsPerDay

The value is expressed in metric tons per day.

MetricTonsPerHour

The value is expressed in metric tons per hour.

MetricTonsPerWeek

The value is expressed in metric tons per week.

MicroMeterPerPascalSecond

Micron

The value is expressed as the number of one-millionths of a meter.

MilligramKOHPerGram

The value is expressed in milligram of Potassium Hydroxide (KOH) per gram. E.g. a unit of measure for how much Potassium Hydroxide is required to neutralize 1 gram of Fatty Acid Methyl Esters (FAME).

MilligramPerKilogram

The value is a mass to mass ratio expressed in milligram per kilogram. E.g. a unit of measure for concentration of chemicals in soil.

MillilitrePerGram

The value is expressed in millilitre per gram. A common unit of measure for product viscosity using ISO-5351.

MilliLitersPerMinute

Millimeter

The value is expressed in millimetres.

MillimeterPerMeter

The value is expressed in millimeter per meter.

MilliNewton

One thousandth of a Newton.

MilliNewtonMeter

MilliNewtonSquareMeterPerGram

MilliPascalSecond

Usually abbreviated mPa·s, it is a unit for dynamic viscosity and one thousandth of a pascal-second.

N.B. 1 centipoise (cP) is exactly equivalent to 1 millipascal-second.

Minute

The value is expressed in minutes.

Month

The value is expressed in months.

NanoMeter**Newton**

The value is expressed in the unit of force needed to accelerate a mass of one kilogram one meter per second per second.

NewtonMeterPerGram**None**

There is no unit of measure. The value is scalar.

Package

The value is a count of packages (for example, the number of reel packages in a shipment). 32 double-wrapped reels would equal 16 packages.

Page

The value is expressed in number of pages.

PagesPerForm

The value is expressed in number of pages per form.

PagesPerImpression

The value is expressed in number of pages per printed impression.

PagesPerInch

The value is a count of the number of pages per inch.

PalletUnit

The value is a count of pallets.

PartsPerMillion

The value is expressed in parts per million.

PascalSecond

The SI unit for dynamic viscosity, usually abbreviated Pa·s. It is equivalently kilogram per meter per second.

Percentage

The measurement being communicated is a percentage.

PerThousand

The value is expressed in parts per thousand.

pH

A measurement of acidity.

Picas

The value is expressed in picas.

Piece

The value is number of pieces.

PiecesPerDay

The value is expressed in pieces per day.

PiecesPerHour

papiNet V2R31

The value is expressed in pieces per hour

PiecesPerMeter

The value is expressed in number of pieces per meter. For example used in Forest Wood Supply business as a unit of measurement for knots in a log.

PixelsPerInch

The value is expressed in pixels per inch.

Pound

The value is expressed in pounds.

PoundCO2e

The value is expressed in equivalent pounds of carbon dioxide (CO₂). A common unit of measure for greenhouse gas (GHG) emissions.

PoundCO2ePerShortTon

The value is expressed in equivalent pounds of carbon dioxide (CO₂) per short ton. A common unit of measure for greenhouse gas (GHG) emissions.

PoundForce

PoundPerCubicFoot

The value is expressed in pounds per cubic foot.

PoundPerSixInchDiameter

The value is expressed in pounds per six inch diameter.

PoundPerSquareInch

The value is expressed in pounds per square inch.

PoundsPerDay

The value is expressed in pounds per day.

PoundsPerHour

The value is expressed in pounds per hour.

PoundsPerWeek

The value is expressed in pounds per week.

PulpUnit

The measurement is related to the packaging characteristic or material handling equipment for the pulp.

Ream

The value is a count of reams.

Reel

The value is a count of reels.

Second

The value of time is expressed in seconds.

Set

The value is a count of sets.

Sheet

The value is a count of sheets.

ShortTon

The value is expressed in short tons.

ShortTonsPerDay

The value is expressed in short tons per day.

ShortTonsPerHour

The value is expressed in short tons per hour.

ShortTonsPerWeek

The value is expressed short tons per week.

Signature

The value is the number of print signatures.

Skid

The value is a count of skids.

SquareDecimeter

The value is expressed in square decimeters.

SquareFeet

The value is expressed in square feet.

SquareInch

The value is expressed in square inches.

SquareMeter

The value is expressed in square meters.

SquareMeterPerKilogram**SquareMillimeterPerKilogram**

The value is expressed in square millimeter per kilogram. A common unit of measure for product dirt using ISO-5350.

SquareMillimeterPerSecond

The value is expressed in square millimeter per second, also called centistok (cSt) after the English physicist George Stokes. E.g. the SI unit for kinematic viscosity.

TenKilometer

The value is expressed in units of 10 kilometers, a.k.a. Swedish mile or Norwegian mile.

ThousandBoardFeet

The value is expressed in thousand board feet.

ThousandLinealFeet

The value is expressed in thousand lineal feet.

ThousandPieces

papiNet V2R31

The value is expressed in thousand of pieces.

ThousandSheet

The value is expressed in thousand of sheets

ThousandSquareCentimeters

The value is expressed in thousand square centimeters.

ThousandSquareFeet

The value is expressed in thousand square feet.

ThousandSquareInch

The value is expressed in thousand square inches.

Ton

To be deprecated in a future version V3R00. Use instead MetricTon or ShortTon.

TonsPerHour

To be deprecated in a future version V3R00. Use instead MetricTonsPerHour or ShortTonsPerHour.

Unit

The value is expressed in individual units (pieces or eaches).

UnknownBreaks

The number of paper breaks, on a printing machine, that are due to unknown causes.

Week

The value is expressed in weeks.

Yard

The value is expressed in yards.

Year

The value is expressed in number of years.

URL

Universal Resource Locator. While typically a web address you could use this field to hold an email address.

URLContext [attribute]

URLContext is optional. A single instance might exist.

The purpose of the URL.

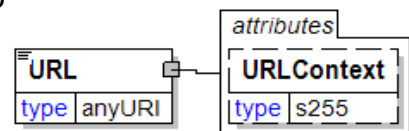

URLContext [attribute]

The purpose of the URL.

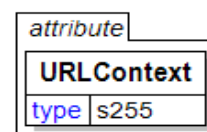

Usage

The Usage element is the root element for the Usage e-Document.

The Usage e-Document is used to notify a supplier or buyer that material has been consumed within the end user's manufacturing process.

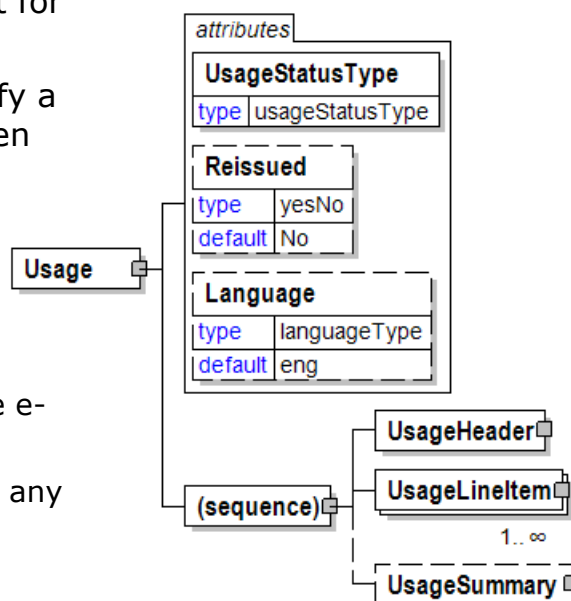

UsageStatusType [attribute]

UsageStatusType is mandatory. A single instance is required.

Identifies the status of the entire Usage e-Document

Refer to UsageStatusType definition for any enumerations.

Reissued [attribute]

Reissued is optional. A single instance might exist.

Either "Yes" or "No".

Refer to Reissued definition for any enumerations.

Language [attribute]

Language is optional. A single instance might exist.

The valid Alpha 2- and Alpha 3-character list of language codes in the ISO 639-1 and 639-2 international standards.

Information on the content of this attribute is available at:
https://www.loc.gov/standards/iso639-2/php/code_list.php

(sequence)

The sequence of items below is mandatory. A single instance is required.

UsageHeader

UsageHeader is mandatory. A single instance is required.

Information that is common to the entire Usage e-Document.

UsageLineItem

UsageLineItem is mandatory. One instance is required, multiple instances might exist.

The details of the Usage e-Document.

UsageSummary

UsageSummary is optional. A single instance might exist.

papiNet V2R31

The root element of the Usage e-Document.

UsageHeader

Information that is common to the entire Usage e-Document.

(sequence)

The sequence of items below is mandatory. A single instance is required.

UsageNumber

UsageNumber is mandatory. A single instance is required.

Unique identifier assigned to each Usage document as agreed by the trading partners.

UsageHeaderReference

UsageHeaderReference is optional. Multiple instances might exist.

An element that details relevant references to the Usage Header. The content of the UsageHeaderReference is identified by the UsageReferenceType attribute.

UsageIssuedDate

UsageIssuedDate is mandatory. A single instance is required.

Identifies the Date and Time when the Usage information has been reported.

TransactionHistoryNumber

TransactionHistoryNumber is optional. A single instance might exist.

A sequential number that keeps track of the version of a document.

However when the document is a confirmation document, in which case the TransactionHistoryNumber refers to the trigger transaction for the confirmation.

TimePeriod

TimePeriod is optional. A single instance might exist.

The TimePeriod element is used to communicate a duration period of time as indicated in PeriodType.

EndUserParty

EndUserParty is mandatory. A single instance is required.

The party using, consuming, or converting the product. For example, a printer using paper reels for a print job for a publisher. The final ShipTo destination for a product is normally to the end user's facilities.

SupplierParty

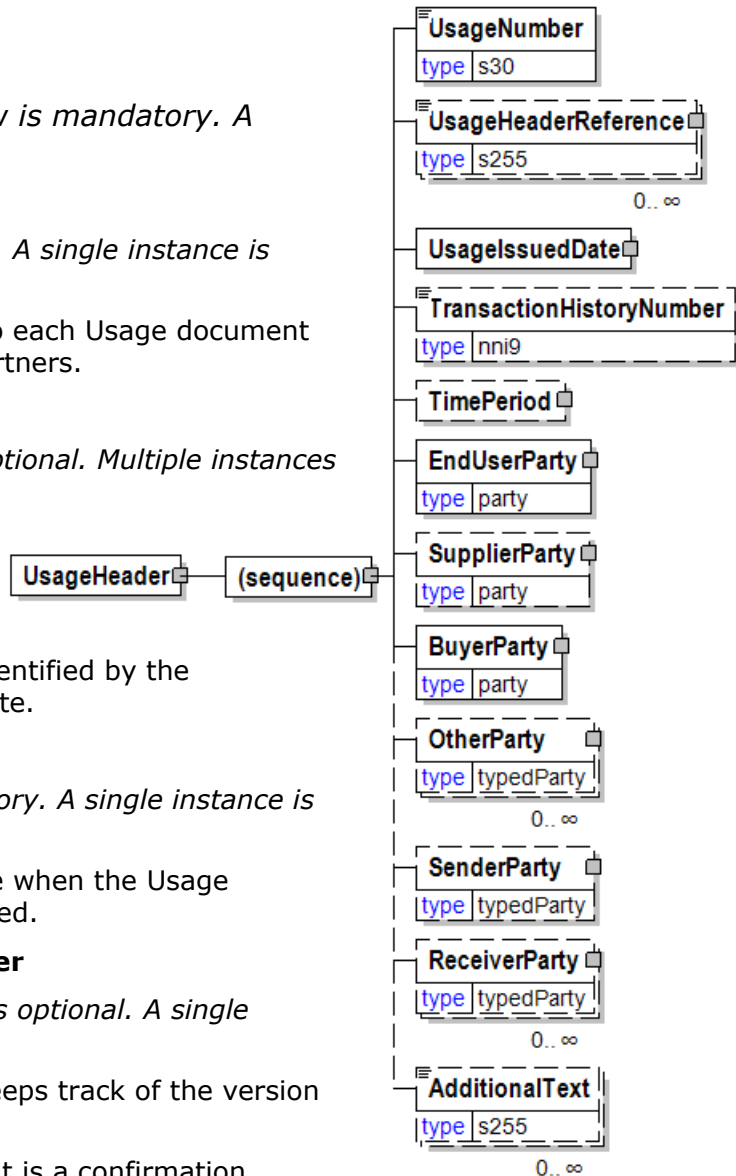

SupplierParty is optional. A single instance might exist.

The organisation or business entity responsible for providing the product. SupplierParty is also the seller of the product, if Seller is not specified as OtherParty = Seller.

BuyerParty

BuyerParty is mandatory. A single instance is required.

The legal entity to which the product is sold. Also commonly referred to as the sold-to party or customer. If no OtherParty is defined as the Payer, the Buyer is the Payer.

OtherParty

OtherParty is optional. Multiple instances might exist.

An organisation or business entity other than those specifically detailed within an e-Document.

SenderParty

SenderParty is optional. A single instance might exist.

The business entity issuing the e-Document, the source of the document.

The entity responsible for the content. If the sender party has out sourced the message service to a third party the SenderParty is the issuer of the e-Document and not the party performing the transmission service of the electronic message.

ReceiverParty

ReceiverParty is optional. Multiple instances might exist.

The business entity for whom the e-Document is intended, the destination of the document.

The entity interested in the content. If the receiver party has outsourced the message service to a third party the ReceiverParty is the intended party for the e-Document and not the party performing the receiving service of the electronic message.

AdditionalText

AdditionalText is optional. Multiple instances might exist.

A text field that is used to communicate information not previously defined or for special instructions. To be used only for circumstances not covered by specific elements.

UsageHeaderReference

An element that details relevant references to the Usage Header. The content of the UsageHeaderReference is identified by the UsageReferenceType attribute.

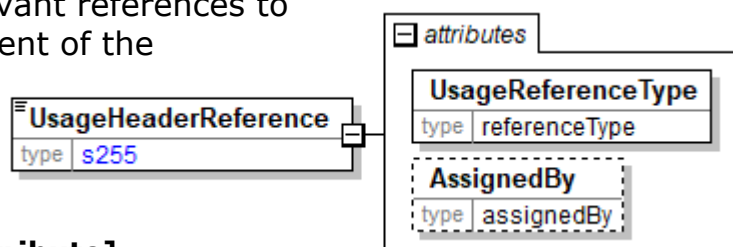

UsageReferenceType [attribute]

UsageReferenceType is mandatory. A single instance is required.

Provides a contextual explanation of the specific reference identifier. Many

papiNet V2R31

items are currently prefixed by "Buyer", "Forwarder", "Manufacturer", "Mill", "Seller", "Supplier", "Warehouse", or "Vendor". Check for an existing non-prefixed version and use the non-prefixed version instead. In the (yet to be announced release date) version 3.0 the prefixed versions will be removed. Instead the attribute @AssignedBy will communicate the information previously communicated in the prefix.

Refer to UsageReferenceType definition for any enumerations.

AssignedBy [attribute]

AssignedBy is optional. A single instance might exist.

Identifies the type of party or the agency that has assigned the associated item, e.g. a reference of type OrderNumber.

Refer to AssignedBy for any enumerations.

UsageIssuedDate

Identifies the Date and Time when the Usage information has been reported.

(sequence)

The sequence of items below is mandatory. A single instance is required.

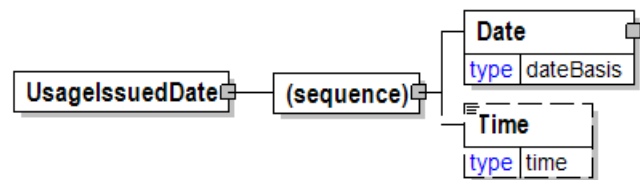

Date

Date is mandatory. A single instance is required.

A group element that contains the specification of Year, Month, and Day.

Time

Time is optional. A single instance might exist.

Times are treated in a standard XML fashion with a special case used to indicate a generalized "local" time. The standard XML approach to time is hh:mm:ss, hh:mm:ssZ, or hh:mm:ss±hh:mm.

hh:mm:ss±hh:mm is used to represent a time with a time zone. The time zone is communicated as the number of hours offset from the Universal Time Coordinate (UTC), a.k.a. Greenwich Mean Time.

hh:mm:ssZ indicates the time at Zulu (another name for UTC).

hh:mm:ss or hh:mm indicates within papiNet the applicable local time where the associated event is taking place. Caution should be used when processing times of this nature as the papiNet approach may be in discord with other users of XML.

UsageLineItem

The details of the Usage e-Document.

(sequence)

The sequence of items below is mandatory. A single instance is required.

UsageLineItemNumber

UsageLineItemNumber is mandatory. A single instance is required.

A sequential number that uniquely identifies the Usage line item.

UsageReference

UsageReference is optional. Multiple instances might exist.

A repeatable element that details relevant references pertaining to the Usage. The content of the UsageReference is identified by UsageReferenceType.

LocationParty

LocationParty is optional. A single instance might exist.

The organization or business entity where the business event took place or will take place.

WasteQuantity

WasteQuantity is optional. Multiple instances might exist.

The quantity of product wasted.

WebBreaks

WebBreaks is optional. Multiple instances might exist.

The number of web breaks.

(choice)

[choice] is mandatory. A single instance is required.

AggregatedUsageLineItem

AggregatedUsageLineItem is mandatory. A single instance is required.

A group item that summarises item usage at the Product level or at the Product plus PurchaseOrder level. Details concerning the individual items used are not included.

ItemisedUsageLineItem

ItemisedUsageLineItem is mandatory. A single instance is required.

A group item containing information that relates to an itemized amount of usage.

AdditionalText

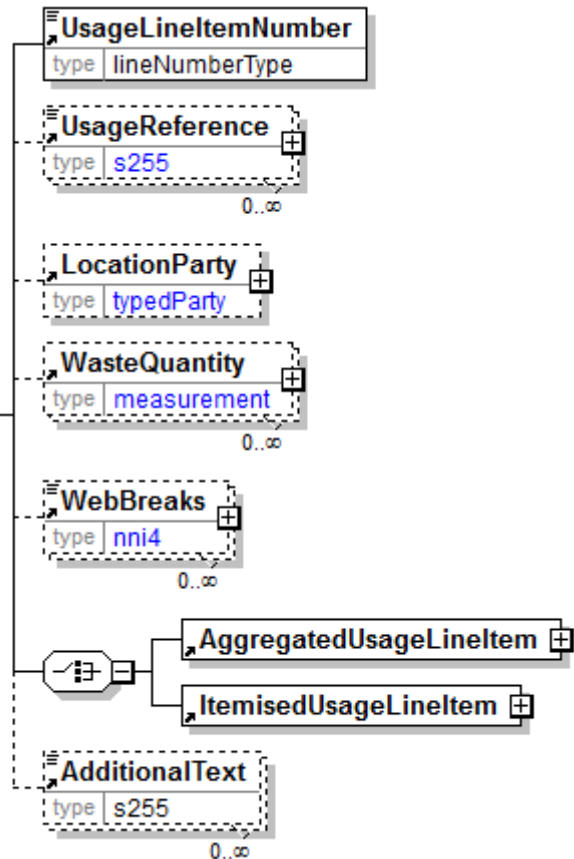

AdditionalText is optional. Multiple instances might exist.

A text field that is used to communicate information not previously defined or for special instructions. To be used only for circumstances not covered by specific elements.

UsageLineItemDetail

For each ItemisedUsageLineItem there must be one or more UsageLineItemDetail. This element lists the specific product that has been consumed.

UsageStatus [attribute]

UsageStatus is mandatory. A single instance is required.

The Usage Status element identifies the state of an individual item after consumption has been applied to it.

Refer to UsageStatus definition for any enumerations.

ItemType [attribute]

ItemType is mandatory. A single instance is required.

Indicates the form of the item being reported as being used. Many of the ItemType(s) indicated here have a corresponding named element equivalent, which is referenced here for definition purposes.

Refer to ItemType definition for any enumerations.

(sequence)

The sequence of items below is mandatory. A single instance is required.

Identifier

Identifier is mandatory. A single instance is required.

An Identifier is required for packages and items (pallets, reel packages, boxes, ream items, reel items, etc). The Identifier element contains the actual item identifier code. Identifier is repeatable so more than one identifier can be communicated. For example, the printed identifier on a label may be different from the barcode printed on the label.

RawMaterialSet

RawMaterialSet is optional. Multiple instances might exist.

This identifier derived element indicates a grouping of raw materials that were used to manufacture the product.

Quantity

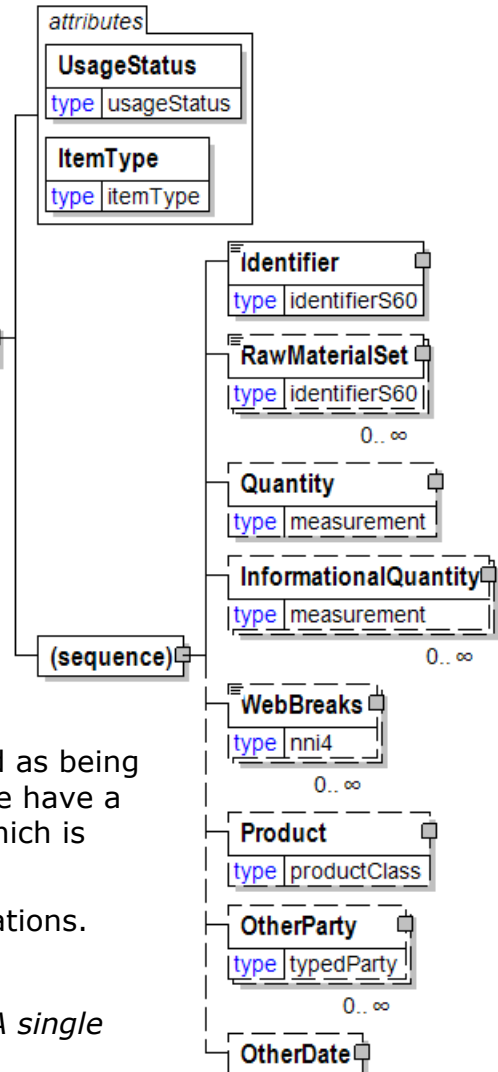

papiNet V2R31

Quantity is optional. A single instance might exist.

The Quantity element contains attributes that provide information about the type of quantity that is being communicated, the context in which the particular quantity is to be viewed, and (if the quantity represents an adjustment) an adjustment type.

The Quantity element contains three child elements that enable you to communicate a range of values for the quantity and a target or actual value. It is at this level (Value, RangeMin, and RangeMax) that the unit of measure is specified. This permits the range to be specified in a different unit of measure than the target.

InformationalQuantity

InformationalQuantity is optional. Multiple instances might exist.

A quantity given in a valid UOM used for information purposes only (not for calculation). For example, an ordered quantity was 100 reels as opposed to the invoice quantity of 20,000 pounds.

WebBreaks

WebBreaks is optional. Multiple instances might exist.

The number of web breaks.

Product

Product is optional. A single instance might exist.

Product is a group item defining the article and its characteristics. Product is used to specify product characteristics organized by ProductIdentifier, ProductDescription, and Classification. Book Manufacturing, Label Stock, Paper, Pulp, Recovered Paper, Wood Products, and Virgin Fibre market segments have defined their product characteristics and conversion features for implementation in papiNet.

OtherParty

OtherParty is optional. Multiple instances might exist.

An organisation or business entity other than those specifically detailed within an e-Document.

OtherDate

OtherDate is optional. A single instance might exist.

A date that may not be specifically detailed within a document (example: print date at the PurchaseOrderLineItem).

UsageLineItemNumber

A sequential number that uniquely identifies the Usage line item.

UsageLineItemNumber	
type	lineNumberType

UsageNumber

Unique identifier assigned to each Usage document as agreed by the trading partners.

UsageNumber	
type	s30

UsageReference

A repeatable element that details relevant references pertaining to the Usage. The content of the UsageReference is identified by UsageReferenceType.

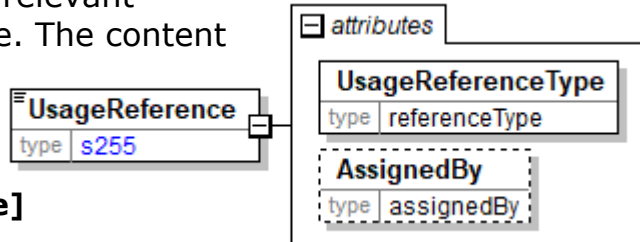

UsageReferenceType [attribute]

UsageReferenceType is mandatory. A single instance is required.

Provides a contextual explanation of the specific reference identifier. Many items are currently prefixed by "Buyer", "Forwarder", "Manufacturer", "Mill", "Seller", "Supplier", "Warehouse", or "Vendor". Check for an existing non-prefixed version and use the non-prefixed version instead. In the (yet to be announced release date) version 3.0 the prefixed versions will be removed. Instead the attribute @AssignedBy will communicate the information previously communicated in the prefix.

Refer to UsageReferenceType definition for any enumerations.

AssignedBy [attribute]

AssignedBy is optional. A single instance might exist.

Identifies the type of party or the agency that has assigned the associated item, e.g. a reference of type OrderNumber.

Refer to AssignedBy for any enumerations.

UsageReferenceType [attribute]

Provides a contextual explanation of the specific reference identifier. Many items are currently prefixed by "Buyer", "Forwarder", "Manufacturer", "Mill", "Seller", "Supplier", "Warehouse", or "Vendor". Check for an existing non-prefixed version and use the non-prefixed version instead. In the (yet to be announced release date) version 3.0 the prefixed versions will be removed. Instead the attribute @AssignedBy will communicate the information previously communicated in the prefix.

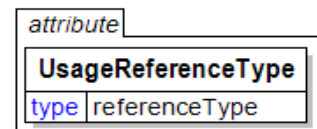

Refer to the [referenceType](#) entry for the list of enumerations and their definitions.

UsageStatus [attribute]

The Usage Status element identifies the state of an individual item after consumption has been applied to it.

This item is restricted to the following list.

Consumed

Indicates that the entire item has been consumed.

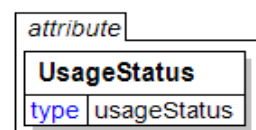

MachineReject

Indicates that the item has been rejected from the production machine

StrippedButt

Indicates that this item has been prepped for consumption but has not been used in the manufacturing process.

UsableButt

Indicates that a partial amount of a reel product has been consumed and the remainder is useable.

UsablePallet

Indicates that a partial amount of a pallet product has been consumed and the remainder us useable.

UnusableButt

Indicates that a partial amount of a reel product has been consumed and the remainder is not useable.

UnusablePallet

Indicates that a partial amount of a pallet product has been consumed and the remainder is not useable.

UsageStatusType [attribute]

Identifies the status of the entire Usage e-Document

This item is restricted to the following list.

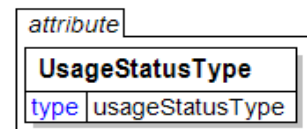

Cancelled

The supplied information has been cancelled. Items that have been cancelled are not included in totals on the summary levels of the e-Document.

Original

The supplied information is the first version of that information.

Replaced

The supplied information is replacing earlier supplied information. The receiver should revalidate the information in their system based upon the entire information received.

UsageSummary

The root element of the Usage e-Document.

(sequence)

The sequence of items below is mandatory. A single instance is required.

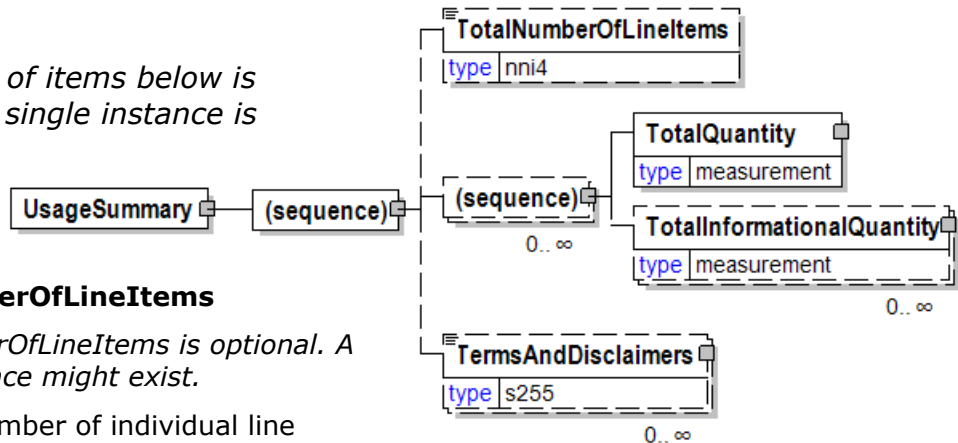

TotalNumberOfLineItems

TotalNumberOfLineItems is optional. A single instance might exist.

The total number of individual line items in the document, regardless of the status or type.

(sequence)

The sequence of items below is optional. Multiple instances might exist.

TotalQuantity

TotalQuantity is mandatory. A single instance is required.

The total quantity of similar items in the e-Document. TotalQuantity is primarily used in the summary section of documents where it is repeatable to permit totaling for different units of measure.

TotalInformationalQuantity

TotalInformationalQuantity is optional. Multiple instances might exist.

A quantity that is used to communicate related information about the parent element. This element represents a total that is derived from individual line items.

TermsAndDisclaimers

TermsAndDisclaimers is optional. Multiple instances might exist.

An element that contains legal information with an indication of what the Language is.

ValidityFlag

Specifies if the item is valid or not.

This item is restricted to the following list.

Yes

No

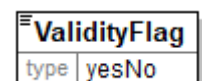

ValidityPeriod

The validity period for a specific item, e.g. the validity period for an e-Document.

(sequence)

The sequence of items below is mandatory. A single instance is required.

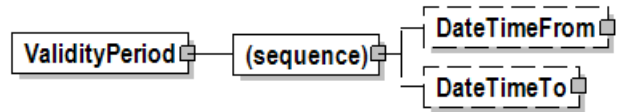

DateTimeFrom

DateTimeFrom is optional. A single instance might exist.

The start or beginning Date and Time of a date range.

DateTimeTo

DateTimeTo is optional. A single instance might exist.

The ending Date and Time of a date/time range.

ValidityStatus [attribute]

The validity status for a specific item.

This item is restricted to the following list.

Active

The item is active. Business transactions can be executed with reference to the item during the validity period.

Closed

The item is terminated or completed. Business transactions cannot be executed with reference to the item.

Pending

The item is preliminary or unfinished. Business transactions cannot be executed with reference to the item.

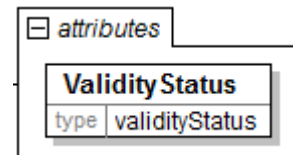

Value

A numeric value expressed in the unit of measure (UOM).

UOM [attribute]

UOM is mandatory. A single instance is required.

Defines the unit of measure for the value.

Refer to UOM definition for any enumerations.

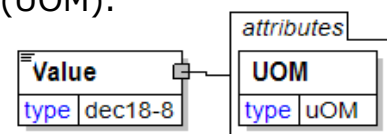

ValueType [attribute]

Specifies the type of the value requested or reported.

This item is restricted to the following list.

Binary

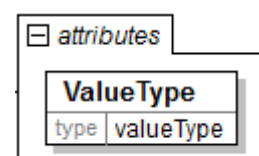

A value in base-64-encoded binary format.

Boolean

A value in boolean format.

DateTime

A Date and Time value in the standard W3C xs:dateTime format.

Numeric

A value in numeric format.

Text

A value in text format.

VarianceType [attribute]

Defines the type of difference that the GoodsReceiptPackage has from the information on the DeliveryMessage

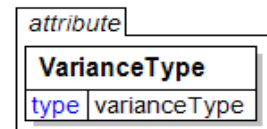

This item is restricted to the following list.

DifferingWeights

The physical item was weighed and the weight is different from the DeliveryMessage weight.

NotReceived

The physical item that was specified on the DeliveryMessage was not received.

ReceivedNotSpecified

The physical item was received but was not on the DeliveryMessage

VersionDate

The Date and Time when the version of an item was issued.

(sequence)

The sequence of items below is mandatory. A single instance is required.

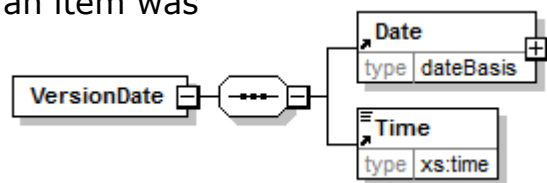

Date

Date is mandatory. A single instance is required.

A group element that contains the specification of Year, Month, and Day.

Time

Time is mandatory. A single instance is required.

Times are treated in a standard XML fashion with a special case used to indicate a generalized "local" time. The standard XML approach to time is hh:mm:ss, hh:mm:ssZ, or hh:mm:ss±hh:mm.

hh:mm:ss±hh:mm is used to represent a time with a time zone. The time zone is communicated as the number of hours offset from the Universal Time

papiNet V2R31

Coordinate (UTC), a.k.a. Greenwich Mean Time.

hh:mm:ssZ indicates the time at Zulu (another name for UTC).

hh:mm:ss or hh:mm indicates within papiNet the applicable local time where the associated event is taking place. Caution should be used when processing times of this nature as the papiNet approach may be in discord with other users of XML.

VersionNumber

A unique number identifying the version of an item.

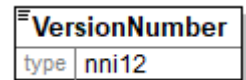

VersionReason

A grouping element that specifies the reason for a version of an item.

Agency [attribute]

Agency is mandatory. A single instance is required.

Describes the agency maintaining the list of codes. To be included in this list the agency must be a recognized standards body or industry organisation.

- For the element that owns this attribute.
- For another attribute in the list of attributes associated with the parent element.

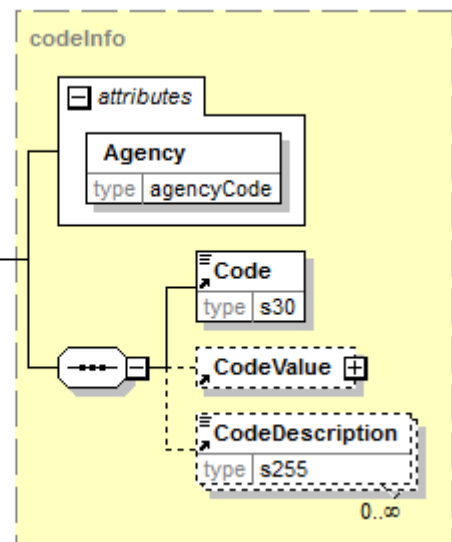
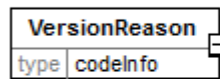

Refer to Agency definition for any enumerations.

(sequence)

The sequence of items below is mandatory. A single instance is required.

Code

Code is mandatory. A single instance is required.

Specifies a code that is defined by an agency. The agency is given for the whole construct containing the code.

CodeValue

CodeValue is optional. A single instance might exist.

A grouping element specifying a value belonging to a code that is defined by an agency.

CodeDescription

CodeDescription is optional. Multiple instances might exist.

A textual description for the meaning of a code that is defined by an agency. When the Code is associated with a CodeValue of type TextValue, then the

CodeDescription is a textual description of both the Code and the TextValue.

VideoCassette

Video cassette information.

VideoFormatType [attribute]

VideoFormatType is optional. A single instance might exist.

The type of video format.

Refer to VideoFormatType definition for any enumerations.

TrackType [attribute]

TrackType is optional. A single instance might exist.

The type of track

Refer to TrackType definition for any enumerations.

Tabs [attribute]

Tabs is optional. A single instance might exist.

The type of tabs

Refer to Tabs definition for any enumerations.

VideoCassetteCaseType [attribute]

VideoCassetteCaseType is optional. A single instance might exist.

The type of video cassette case.

Refer to VideoCassetteCaseType definition for any enumerations.

AssemblyType [attribute]

AssemblyType is optional. A single instance might exist.

Assembly type

Refer to AssemblyType definition for any enumerations.

WrapType [attribute]

WrapType is optional. A single instance might exist.

Communicates the type of material used to wrap the product.

Refer to WrapType definition for any enumerations.

(sequence)

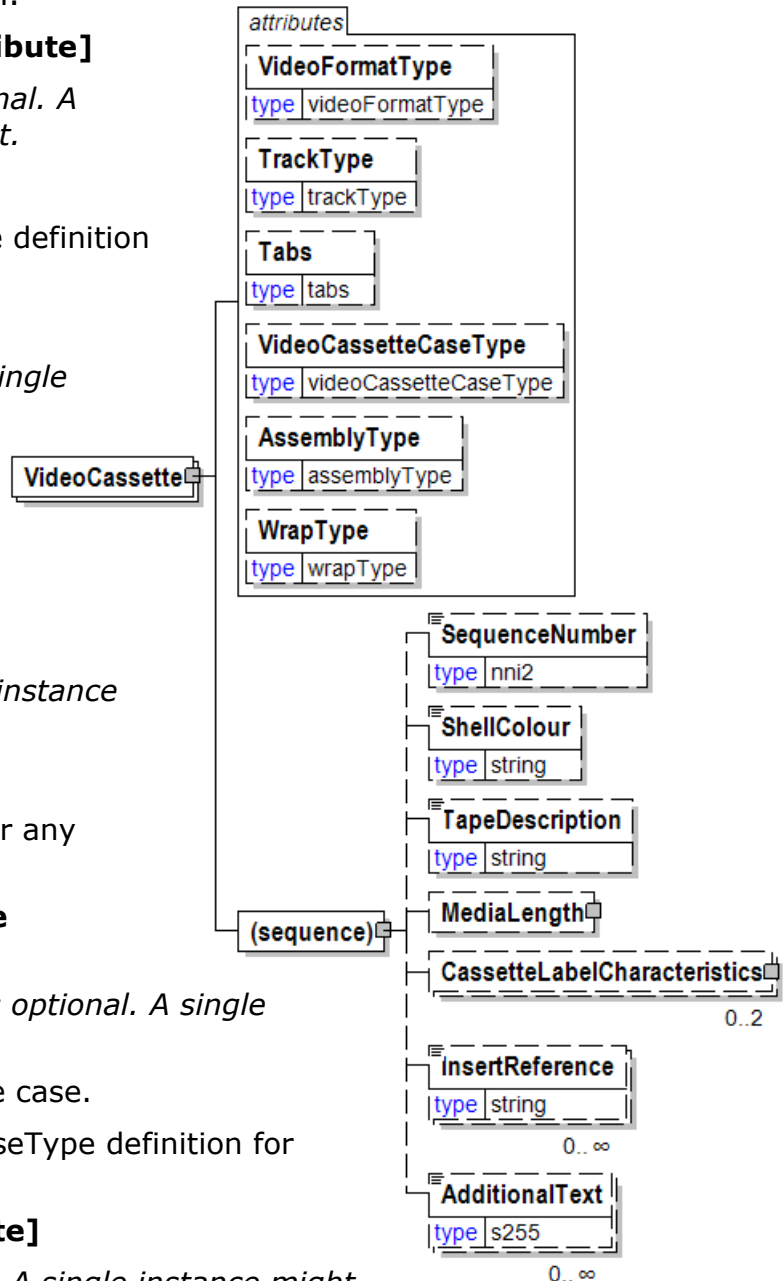

papiNet V2R31

The sequence of items below is mandatory. A single instance is required.

SequenceNumber

SequenceNumber is optional. A single instance might exist.

A sequential number that uniquely identifies a sequence.

ShellColour

ShellColour is optional. A single instance might exist.

Shell colour

TapeDescription

TapeDescription is optional. A single instance might exist.

Tape description

MediaLength

MediaLength is optional. A single instance might exist.

Media length

CassetteLabelCharacteristics

CassetteLabelCharacteristics is optional.

Cassette label characteristics

InsertReference

InsertReference is optional. Multiple instances might exist.

Insert reference

AdditionalText

AdditionalText is optional. Multiple instances might exist.

A text field that is used to communicate information not previously defined or for special instructions. To be used only for circumstances not covered by specific elements.

VideoCassetteCaseType [attribute]

The type of video cassette case.

This item is restricted to the following list.

HardPlastic

VacuumAlbum

SleeveBottomLoaded

SleeveSideLoaded



VideoFormatType [attribute]

The type of video format.

This item is restricted to the following list.

VHS

Video Home System



VirginFibre

Virgin Fibre

(sequence)

The sequence of items below is mandatory. A single instance is required.

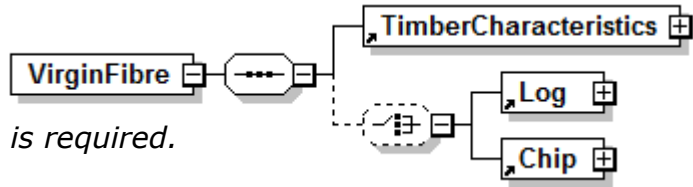

TimberCharacteristics

TimberCharacteristics is mandatory. A single instance is required.

Timber characteristics

(choice)

[choice] is optional. A single instance might exist.

Log

Log is mandatory. A single instance is required.

Log information

Chip

Chip is mandatory. A single instance is required.

Chip information.

Viscosity

Viscosity

TestMethod [attribute]

TestMethod is optional. A single instance might exist.

The method used to determine the results of the test under consideration.

TestAgency [attribute]

TestAgency is optional. A single instance might exist.

The agency that has set the parameters for the testing

Refer to TestAgency definition for any enumerations.

SampleType [attribute]

SampleType is optional. A single instance might exist.

Communicates how sampling was done to measure the product characteristics.

Refer to SampleType definition for any enumerations.

ResultSource [attribute]

ResultSource is optional. A single instance might exist.

Used to define the data source of the specified test

Refer to ResultSource definition for any enumerations.

(sequence)

The sequence of items below is mandatory. A single instance is required.

DetailValue

DetailValue is mandatory. A single instance is required.

A numeric value expressed in the unit of measure (UOM).

DetailRangeMin

DetailRangeMin is optional. A single instance might exist.

The minimum value (lower boundary) allowed for the DetailValue that is the parent of this element.

DetailRangeMax

DetailRangeMax is optional. A single instance might exist.

The maximum value (upper boundary) allowed for the DetailValue that is the

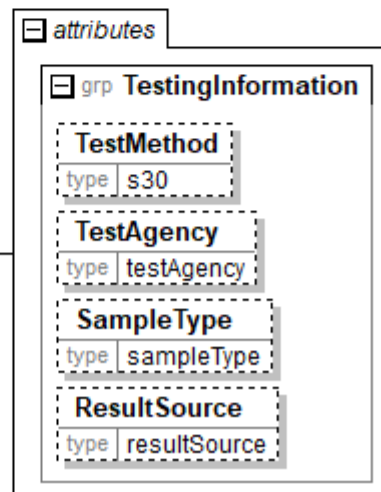
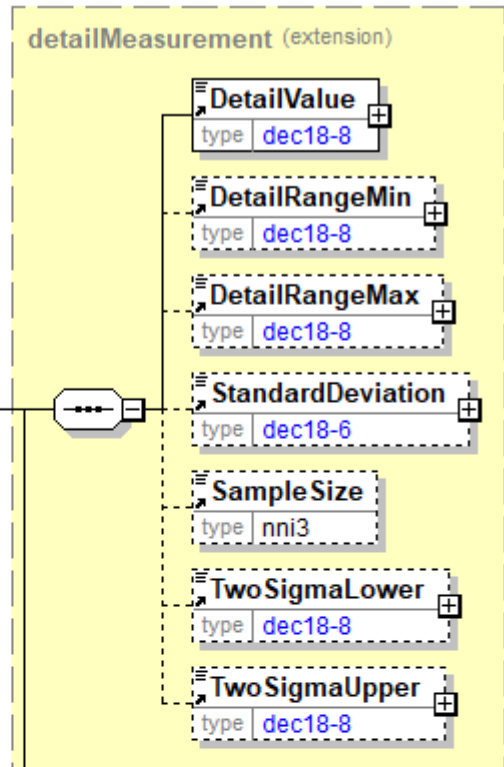

papiNet V2R31

parent of this element.

StandardDeviation

StandardDeviation is optional. A single instance might exist.

A statistic used as a measure of dispersion in a distribution.

SampleSize

SampleSize is optional. A single instance might exist.

The number of samples used to determine the product characteristic in question.

TwoSigmaLower

TwoSigmaLower is optional. A single instance might exist.

Two sigma (a measure of dispersion associated with standard deviation) on the lower side of the standard deviation.

TwoSigmaUpper

TwoSigmaUpper is optional. A single instance might exist.

Two sigma (a measure of dispersion associated with standard deviation) on the upper side of the standard deviation.

Wall

Defines parts and complete wall systems.

(sequence)

The sequence of items below is mandatory. A single instance is required.

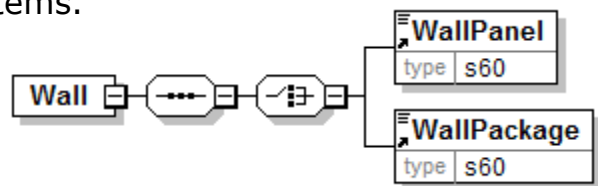

(choice)

[choice] is mandatory. A single instance is required.

WallPanel

WallPanel is mandatory. A single instance is required.

Material used for wall surface.

WallPackage

WallPackage is mandatory. A single instance is required.

Package including parts to build a wall.

WallPackage

Package including parts to build a wall.

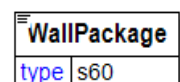

WallPanel

Material used for wall surface.

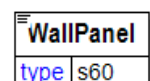

WasteImpressions

The number of bad revolutions produced on a printing unit.

WasteImpressions	
type	nni4

WasteQuantity

The quantity of product wasted.

WasteType [attribute]

WasteType is mandatory. A single instance is required.

An indication of where in the process the waste has taken place.

Refer to WasteType definition for any enumerations.

(sequence)

The sequence of items below is mandatory. A single instance is required.

Value

Value is mandatory. A single instance is required.

A numeric value expressed in the unit of measure (UOM).

RangeMin

RangeMin is optional. A single instance might exist.

The minimum value (lower boundary) allowed for the Measurement that is the parent of this element.

RangeMax

RangeMax is optional. A single instance might exist.

The maximum value (upper boundary) allowed for the Measurement that is the parent of this element. Some elements use the RangeMax element with an extended list of unit of measures. (Note: the red colour in the picture is an artifact of how the graphic was captured and should be disregarded.)

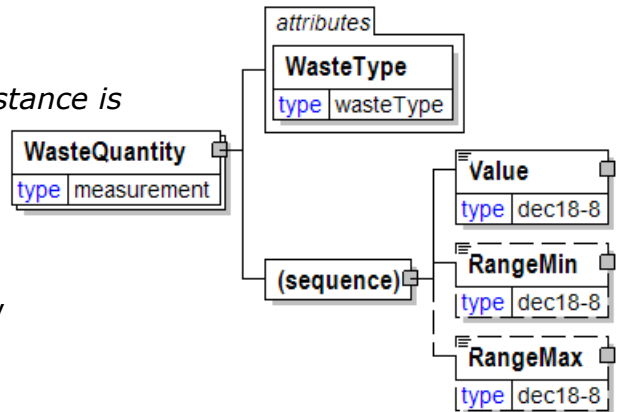

WasteType [attribute]

An indication of where in the process the waste has taken place.

This item is restricted to the following list.

Binding

Core

MakeReady

Running

attribute	
WasteType	
type	wasteType

Strip

WrapCore

Wrapper

Watermark

Watermark information

(sequence)

The sequence of items below is mandatory. A single instance is required.

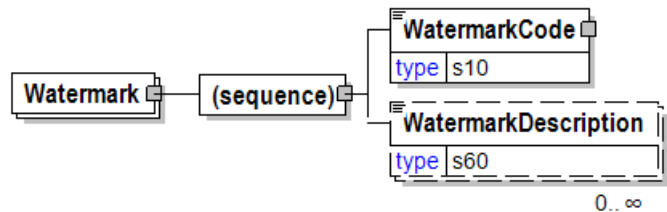

WatermarkCode

WatermarkCode is mandatory. A single instance is required.

The code representing the watermark on the paper.

WatermarkDescription

WatermarkDescription is optional. Multiple instances might exist.

Watermark Description

WatermarkCode

The code representing the watermark on the paper.

Agency [attribute]

Agency is mandatory. A single instance is required.

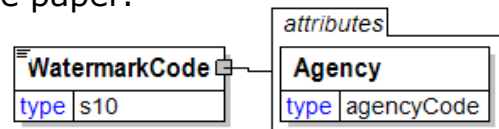

Describes the agency maintaining the list of codes. To be included in this list the agency must be a recognized standards body or industry organisation.

- For the element that owns this attribute.
- For another attribute in the list of attributes associated with the parent element.

Refer to Agency definition for any enumerations.

WatermarkDescription

Watermark Description

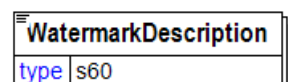

Webbing

The webbing that is used in the printing process.

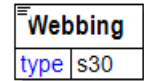

WebBreak

Separation of the paper web during the printing process causing the operator to stop and rethread the press.

If the ConcernIndicatorType is "Y" then a defect cause must be given.

(sequence)

The sequence of items below is mandatory. A single instance is required.

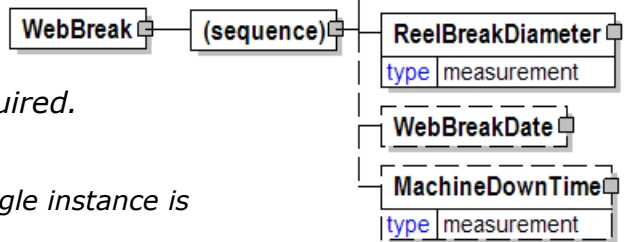

WebBreakCause

WebBreakCause is mandatory. A single instance is required.

A group element that contains information that describes the cause of a web break.

PressBreakLocation

PressBreakLocation is optional. Multiple instances might exist.

The specific location identified within a printing press.

ReelBreakDiameter

ReelBreakDiameter is mandatory. A single instance is required.

The diameter of a reel at which the web break occurred. This is measured from the core to outside diameter.

WebBreakDate

WebBreakDate is optional. A single instance might exist.

The date of the web break.

MachineDownTime

MachineDownTime is optional. A single instance might exist.

The length of loss production time that a machine experienced due to malfunction regardless of cause.

WebBreakCause

A group element that contains information that describes the cause of a web break.

WebBreakCauseType [attribute]

WebBreakCauseType is optional. A single instance might exist.

Web Break Cause Type

Refer to WebBreakCauseType definition for any enumerations.

(sequence)

The sequence of items below is mandatory. A single instance is required.

WebBreakCauseCode

WebBreakCauseCode is optional. A single instance might exist.

Codes pertaining to the break supplied by the User.

WebBreakDescription

WebBreakDescription is optional. Multiple instances might exist.

Description of the web break

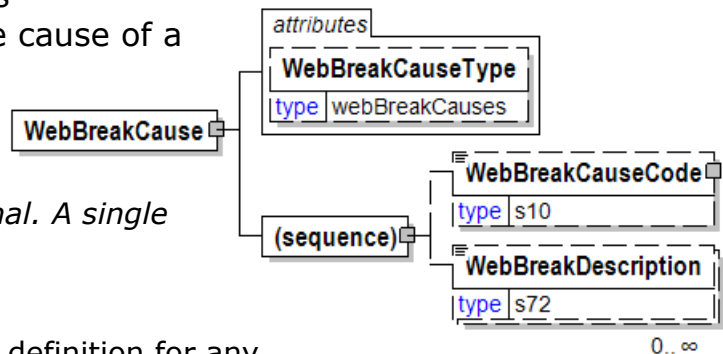

WebBreakCauseAgency [attribute]

WebBreakCauseAgency

This item is restricted to the following list.

AFPA

American Forest and Paper Association.

AFNOR

AFNOR is an association specialized in standardization and certification in France. <http://www.afnor.org/en>

AmericanChemicalSociety

The American Chemical Society is a scientific society based in the United States that supports scientific inquiry in the field of chemistry. (www.acs.org)

ANSI

American National Standards Institute.

APPITA

Technical Association of the Australian and NZ Pulp and Paper Industry.

ASTM

ASTM International, known until 2001 as the American Society for Testing and Materials (ASTM), is an international standards organization that develops and publishes voluntary consensus technical standards for a wide range of materials, products, systems, and services. For example Winter Class diesel

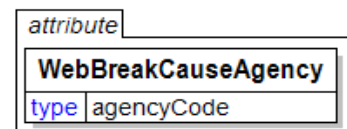

papiNet V2R31

has to fulfil ASTM standards. (<http://www.astm.org>)

ASTM (misspelt with an ending space)

The item is misspelt ending with a space. It will be deprecated in a future version V3R00. Use instead the correctly spelt enumeration ASTM.

ATA

ATA (American Truckers Association)

BISAC

Book Industry Study Group

Bowker

The agency that issues the StandardAddressNumber (www.bowker.com).

BSI

British Standards Institute (refer to bsi-global.com for more information).

Buyer

The buyer has defined the codes used in the particular element of the transaction. Care must be used when using this agency to assure that the recipient of the e-Document understands what is being communicated. (Not to be used for logistics buyer, see LogisticsBuyer.)

Carrier

The carrier has defined the codes used in the particular element of the transaction. Care must be used when using this agency to assure that the recipient of the e-Document understands what is being communicated.

CCTI

Composite Can and Tube Institute

CEN

European Committee for Standardisation (<http://www.cen.eu>)

CEPI

Confederation of European Paper Industries.

ContractParty

The organisation or business entity responsible for managing the contract between business partners.

CoSe

Agency for the the wood processing industry. (www.commonsense.at)

Customs

Any customs agency.

DUNS

Dun & Bradstreet.

EAN

To be deprecated in a future version V3R00. In 2005 the EAN organisation changed its name to GS1. Use GS1 instead. <http://www.gs1.org/>

ECTA-EPCA-CEFIC

European Chemical Transport Association, European Petrochemical Association, European Chemical Council. Information about the joint guidelines developed by these agencies can be found at www.ecta.be.

eMOBOIS

French Forest Wood Supply User Group managed by FCBA.

<http://www.fcba.fr/catalogue/1ere-transformation-approvisionnement/actions-collectives/emobois-un-projet-qui-relie-les-entreprises-de-la-mobilisation-et-de-lapprovisionnement-des>

EndUser

The end-user has defined the codes used in the particular element of the transaction. Care must be used when using this agency to assure that the recipient of the e-Document understands what is being communicated.

EU

European Union

FINFO

Article numbering agency and system in some Nordic countries for all building products. (www.finno.se)

ForestForwarder

The party that transports forest wood products from logging areas to roadside landings.

ForestForwardingRequestor

The party requesting forest forwarding services.

ForestHarvester

The party that harvests forest wood products at logging areas.

ForestHarvestingRequestor

The party requesting forest harvesting services.

ForestHub

An agency for Forest Wood Supply & Bioproducts industries.

Forwarder

The OtherParty indicated by party type "Forwarder" or when communicating OrderStatus the party indicated by ForwarderParty.

FSC

Forest Stewardship Council

GCA

Graphic Communications Association. (This agency now calls itself IDEAlliance.)

GCA-CCTI

The GCA and CCTI combined coding

GOST

Russian federal agency on technical regulating and metrology (<http://www.gost.ru>).

GS1

GS1 is an international not-for-profit association with Member Organisations in over 100 countries. GS1 is dedicated to the design and implementation of global standards and solutions to improve the efficiency and visibility of supply and demand chains globally and across sectors. <http://www.gs1.org/>

IFRA

INCA FIEJ Research Association (Technical Research and Consulting Association for the Newspaper Industry).

Intrastat

The agency responsible for collecting statistics on the physical trade of goods between the members of the EU.

ISO

International Organisation for Standardisation.

ISRI

Institute of Scrap Recycling Industries.

KpDC

Agency maintaining codes for the Latvia wood supply segment. (www.KpDC.lv).

Loading Operator

A party that is carrying out loading of transport units.

Logistics Buyer

The buyer of the logistics service has defined the codes used in the particular element of the transaction. Care must be used when using this agency to assure that the recipient of the e-Document understands what is being communicated.

Logistics Seller

The seller of the logistics service has defined the codes used in the particular element of the transaction. Care must be used when using this agency to assure that the recipient of the e-Document understands what is being communicated.

Logistics Supplier

The supplier of the logistics service has defined the codes used in the particular element of the transaction. Care must be used when using this agency to assure that the recipient of the e-Document understands what is being communicated.

Measuring Party

The party that is responsible for the measurements at the measuring location.

Mill

The OtherParty indicated by party type "Mill" or when available the party indicated by MillParty.

NMFTA

National Motor Freight Traffic Association (NMFTA)

NOBB

Norwegian Building Products database, (Norsk ByggvareBase)

NorwegianEnvironmentAgency

The Norwegian Environment Agency is a government agency under the Ministry of Climate and Environment.

<https://www.environmentagency.no>

NPTA

National Paper Trade Association.

Ondule

European Association of Corrugated Base Papers Manufacturers (actually Óndule).

PEFC

www.pefc.org

PMS

Pantone Matching System is a colour matching system that is widely used in the book industry. See www.pantone.com for more information.

PPPC

Pulp and Paper Products Council

Publisher

The person, company or organization responsible for placing a book, journal, or other publication on the market (as opposed to the printer or bookseller); also referred to as the "buyer".

PWO

Agency for Pulpwood Online.

RASI

Article numbering agency and system in Finland for building products. (www.rasi.fi)

RevenueCanada

Canadian Revenue Agency. See www.cra.gc.ca

RVR

Agency maintaining codes for the German wood supply segment. RVR is the abbreviation for "Rahmenvereinbarung für den Rohholzhandel in Deutschland". (www.rvr-deutschland.de).

SD

Agency maintaining codes for the Norwegian wood supply segment (www.skogdata.no).

SDC

Agency maintaining codes for the Swedish wood supply segment

(www.biometria.se).

Seller

The seller of the product has defined the codes used in the particular element of the transaction. Care must be used when using this agency to assure that the recipient of the e-Document understands what is being communicated. (Not to be used for logistics seller, see LogisticsSeller.)

Supplier

The supplier has defined the codes used in the particular element of the transaction. Care must be used when using this agency to assure that the recipient of the e-Document understands what is being communicated. (Not to be used for logistics supplier, see LogisticsSupplier).

SwedishEnvironmentalProtectionAgency

The public agency in Sweden that is responsible for environmental issues.
<https://www.naturvardsverket.se/en>

TAPPI

Technical Association for the Paper and Pulp Industry

UCC

To be deprecated in a future version V3R00. In 2005 the Uniform Code Council (UCC) changed its name to GS1 US as a member organisation of GS1 in United States of America. Use GS1 instead.

<http://www.gs1.org/>

<http://www.gs1us.org/>

UIC

International Union of Railways. (<http://www.uic.org>)
(Union Internationale des Chemins de fer)

UN/ECE

The United Nations – Economic Commission for Europe

WarehouseOperator

The party operating a warehouse.

WCO

World Customs Organization (refer to wcoomd.org for more information).

XBITS

XML Book Industry Transaction Standards

Other

Used when the agency responsible for a coding system is not defined in the attribute list, or there is no agency responsible for the codes used.

WebBreakCauseCode

Codes pertaining to the break supplied by the User.

WebBreakCauseAgency [attribute]

WebBreakCauseAgency is mandatory. A single instance is required.

WebBreakCauseAgency

Refer to WebBreakCauseAgency definition for any enumerations.

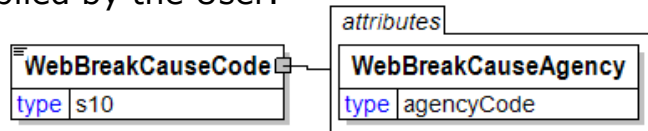

WebBreakCauseType [attribute]

Web Break Cause Type

This item is restricted to the following list.

BaggyRoll

CalendarCut

CoatingScuffBack

Detector

FlatSpots

GlueOnRoll

HairCut

InkFellOnWeb

KnifeCut

LooseCore

MillSplice

MissedPaste

PasterJamFolder

RibbonOutFolder

ScorchOut

ScrapInRoll

SlimeHole

SlitterFoldOver

SlitterNicks

StartOrStop

StuckWeb

Telescoped

TensionWrinklesPaste

Unknown

WaterFellOnWeb

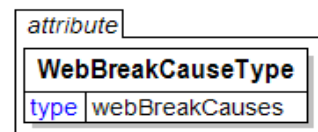

WinderBurst

WinderWrinkles

WebBreakDate

The date of the web break.

(sequence)

The sequence of items below is mandatory. A single instance is required.

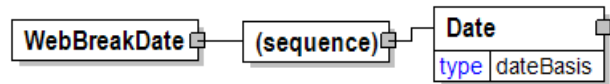

Date

Date is mandatory. A single instance is required.

A group element that contains the specification of Year, Month, and Day.

WebBreakDescription

Description of the web break

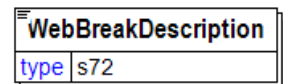

WebBreaks

The number of web breaks.

WebBreakType [attribute]

WebBreakType is mandatory. A single instance is required.

An indication of the cause of the paper break.

Refer to WebBreakType definition for any enumerations.

ReasonCode [attribute]

ReasonCode is optional. A single instance might exist.

Free-form text providing the Reason Code for the item. An Agency attribute may exist at the same level as this attribute to provide an indication of the nature of the text.

Agency [attribute]

Agency is optional. A single instance might exist.

Describes the agency maintaining the list of codes. To be included in this list the agency must be a recognized standards body or industry organisation.

- For the element that owns this attribute.
- For another attribute in the list of attributes associated with the parent element.

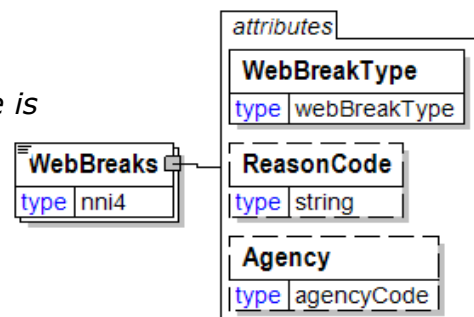

Refer to Agency definition for any enumerations.

WebBreakType [attribute]

An indication of the cause of the paper break.

This item is restricted to the following list.

- MachineCaused**
- PaperCaused**
- Unknown**

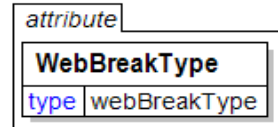

WebConcerns

A grouping element that contains the information about a web break.

(sequence)

The sequence of items below is mandatory. A single instance is required.

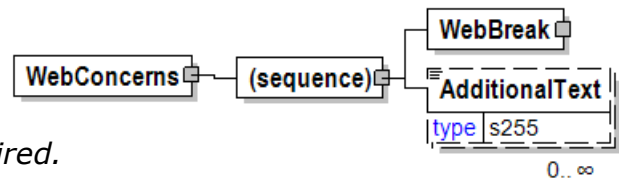

WebBreak

WebBreak is mandatory. A single instance is required.

Separation of the paper web during the printing process causing the operator to stop and rethread the press.

If the ConcernIndicatorType is "Y" then a defect cause must be given.

AdditionalText

AdditionalText is optional. Multiple instances might exist.

A text field that is used to communicate information not previously defined or for special instructions. To be used only for circumstances not covered by specific elements.

WebConfiguration

The way the web runs through the press.

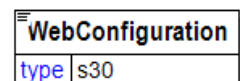

Week

A field defining the week number of the calendar year. ISO 8601 is used as the basis for this element, "Week 01 of a year is the first week that has the Thursday in this year, which is equivalent to the week that contains the fourth day of January." The ISO week starts on Monday. The ISO 8601 extended format of the week number is yyyy-Www, for example 2016-W51.

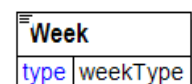

Weight

The weight of the item.

(sequence)

The sequence of items below is mandatory. A single instance is required.

Value

Value is mandatory. A single instance is required.

A numeric value expressed in the unit of measure (UOM).

RangeMin

RangeMin is optional. A single instance might exist.

The minimum value (lower boundary) allowed for the Measurement that is the parent of this element.

RangeMax

RangeMax is optional. A single instance might exist.

The maximum value (upper boundary) allowed for the Measurement that is the parent of this element. Some elements use the RangeMax element with an extended list of unit of measures. (Note: the red colour in the picture is an artifact of how the graphic was captured and should be disregarded.)

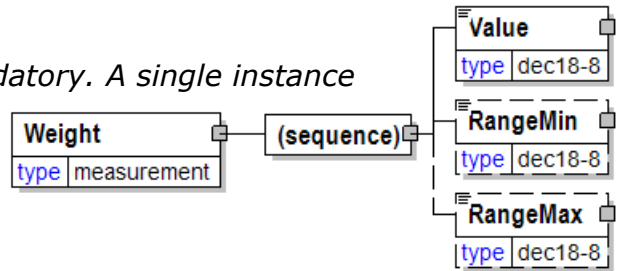

Whiteness

A group item used to communicate degree of whiteness target or test value according to a particular TestMethod.

TestMethod [attribute]

TestMethod is optional. A single instance might exist.

The method used to determine the results of the test under consideration.

TestAgency [attribute]

TestAgency is optional. A single instance might exist.

The agency that has set the parameters for the testing

Refer to TestAgency definition for any enumerations.

SampleType [attribute]

SampleType is optional. A single instance might exist.

Communicates how sampling was done to measure the product characteristics.

Refer to SampleType definition for any enumerations.

ResultSource [attribute]

ResultSource is optional. A single instance might exist.

Used to define the data source of the specified test

Refer to ResultSource definition for any enumerations.

(sequence)

The sequence of items below is mandatory. A single instance is required.

DetailValue

DetailValue is mandatory. A single instance is required.

A numeric value expressed in the unit of measure (UOM).

DetailRangeMin

DetailRangeMin is optional. A single instance might exist.

The minimum value (lower boundary) allowed for the DetailValue that is the parent of this element.

DetailRangeMax

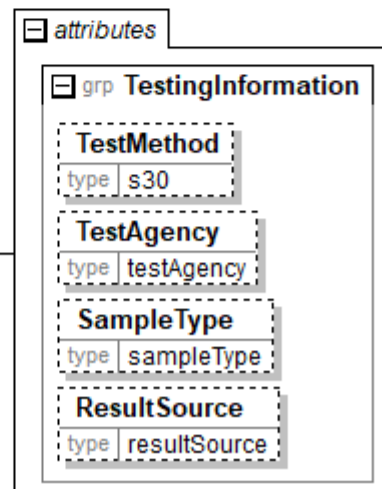
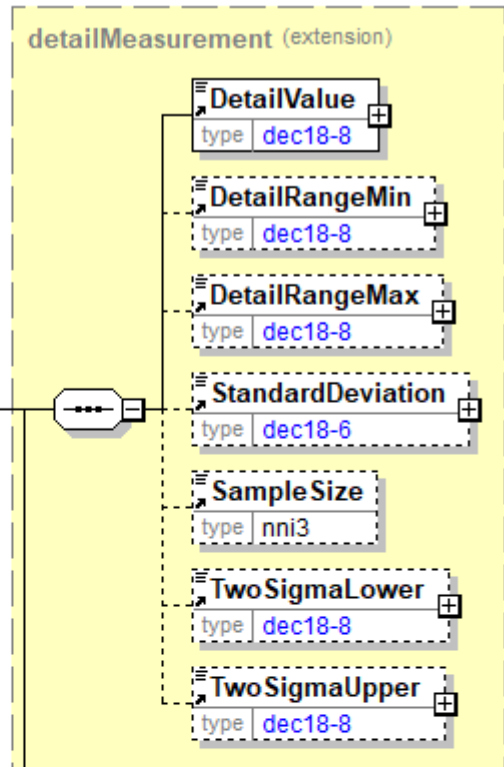

papiNet V2R31

DetailRangeMax is optional. A single instance might exist.

The maximum value (upper boundary) allowed for the DetailValue that is the parent of this element.

StandardDeviation

StandardDeviation is optional. A single instance might exist.

A statistic used as a measure of dispersion in a distribution.

SampleSize

SampleSize is optional. A single instance might exist.

The number of samples used to determine the product characteristic in question.

TwoSigmaLower

TwoSigmaLower is optional. A single instance might exist.

Two sigma (a measure of dispersion associated with standard deviation) on the lower side of the standard deviation.

TwoSigmaUpper

TwoSigmaUpper is optional. A single instance might exist.

Two sigma (a measure of dispersion associated with standard deviation) on the upper side of the standard deviation.

Width

The width of the object. (Used in wood/timber items).

ActualNominal [attribute]

ActualNominal is optional. A single instance might exist.

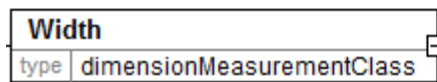

Indicates the measurement approach used to communicate the dimensions of the individual pieces.

Refer to ActualNominal definition for any enumerations.

(choice)

[choice] is mandatory. A single instance is required.

Value

Value is mandatory. A single instance is required.

A numeric value expressed in the unit of measure (UOM).

(sequence)

The sequence of items below is mandatory. A single instance is required.

RangeMin

RangeMin is optional. A single instance might exist.

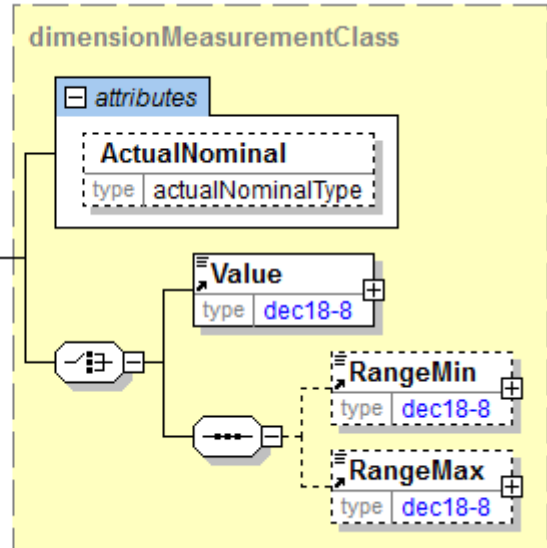

papiNet V2R31

The minimum value (lower boundary) allowed for the Measurement that is the parent of this element.

RangeMax

RangeMax is optional. A single instance might exist.

The maximum value (upper boundary) allowed for the Measurement that is the parent of this element. Some elements use the RangeMax element with an extended list of unit of measures. (Note: the red colour in the picture is an artifact of how the graphic was captured and should be disregarded.)

Width

The approach for width used in the timber/lumber related constructs.

ActualNominal [attribute]

ActualNominal is optional. A single instance might exist.

Indicates the measurement approach used to

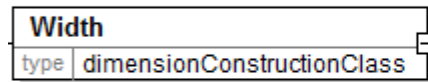

communicate the dimensions of the individual pieces.

Refer to ActualNominal definition for any enumerations.

WithGrain [attribute]

WithGrain is optional. A single instance might exist.

Refer to WithGrain definition for any enumerations.

(choice)

[choice] optional. A single instance might exist.

Value

Value is mandatory. A single instance is required.

A numeric value expressed in the unit of measure (UOM).

(sequence)

The sequence of items below is mandatory. A single instance is required.

RangeMin

RangeMin is optional. A single instance might exist.

The minimum value (lower boundary) allowed for the Measurement that is the parent of this element.

RangeMax

RangeMax is optional. A single instance might exist.

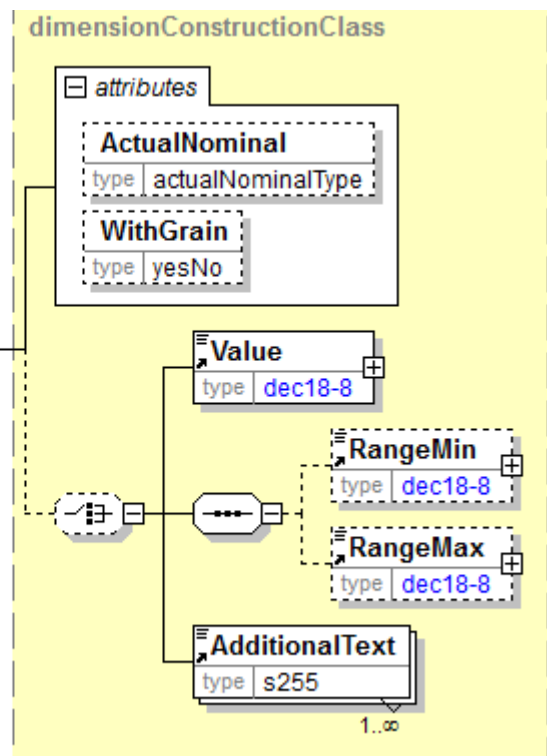

papiNet V2R31

The maximum value (upper boundary) allowed for the Measurement that is the parent of this element. Some elements use the RangeMax element with an extended list of unit of measures. (Note: the red colour in the picture is an artifact of how the graphic was captured and should be disregarded.)

AdditionalText

AdditionalText is mandatory. One instance is required, multiple instances might exist.

A text field that is used to communicate information not previously defined or for special instructions. To be used only for circumstances not covered by specific elements.

Width

The width of the object.

(sequence)

The sequence of items below is mandatory. A single instance is required.

Value

Value is mandatory. A single instance is required.

A numeric value expressed in the unit of measure (UOM).

RangeMin

RangeMin is optional. A single instance might exist.

The minimum value (lower boundary) allowed for the Measurement that is the parent of this element.

RangeMax

RangeMax is optional. A single instance might exist.

The maximum value (upper boundary) allowed for the Measurement that is the parent of this element. Some elements use the RangeMax element with an extended list of unit of measures. (Note: the red colour in the picture is an artifact of how the graphic was captured and should be disregarded.)

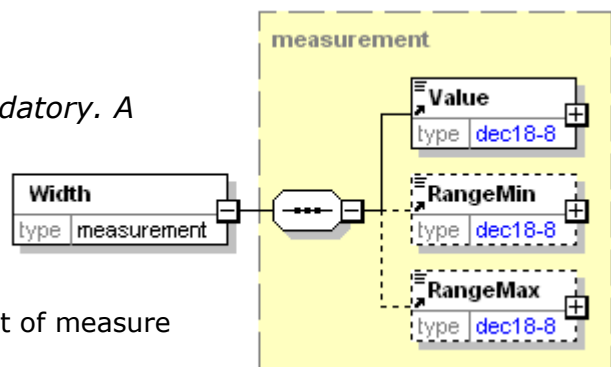

WindingDirection

An element that indicates how the material is wound on the reel.

This item is restricted to the following list.

FaceIn

The face of the label is wound on the inside of the reel.

FaceOut

The face of the label is wound on the outside of the reel.

WireSideIn

When someone looks at a finished reel, the wire side of the sheet is facing the

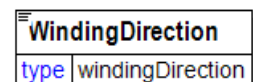

core.

WireSideOut

When someone looks at a finished reel, the wire side of the sheet is facing away from the core.

Any

Any approach to winding the reel is acceptable.

WireCoating [attribute]

Wire Coating

This item is restricted to the following list.

Yes

No

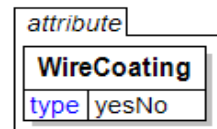

WireGauge

Wire Gauge

(sequence)

The sequence of items below is mandatory. A single instance is required.

Value

Value is mandatory. A single instance is required.

A numeric value expressed in the unit of measure (UOM).

RangeMin

RangeMin is optional. A single instance might exist.

The minimum value (lower boundary) allowed for the Measurement that is the parent of this element.

RangeMax

RangeMax is optional. A single instance might exist.

The maximum value (upper boundary) allowed for the Measurement that is the parent of this element. Some elements use the RangeMax element with an extended list of unit of measures. (Note: the red colour in the picture is an artifact of how the graphic was captured and should be disregarded.)

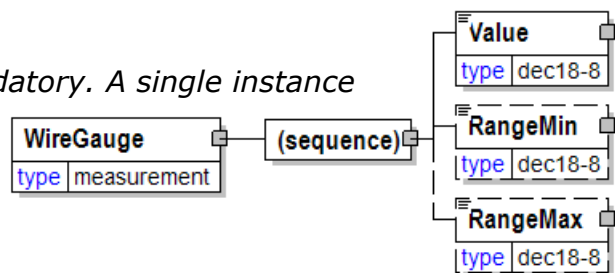

WireMaterial

Wire Material

WireCoating [attribute]

WireCoating is optional. A single instance might exist.

Wire Coating

Refer to WireCoating definition for any enumerations.

(sequence)

The sequence of items below is mandatory. A single instance is required.

WireGauge

WireGauge is mandatory. A single instance is required.

Wire Gauge

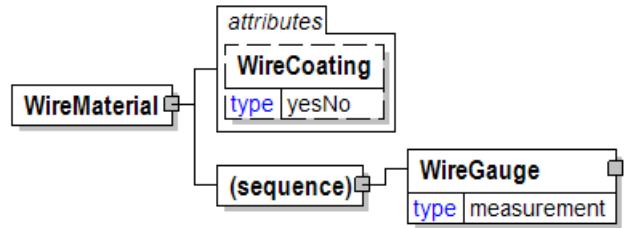

WithGrain [attribute]

Either "Yes" or "No".

This item is restricted to the following list.

Yes

No

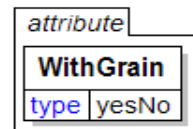

WoodBasedPanelGrade

Face [attribute]

Face is optional. A single instance might exist.

Used to describe which side (or face) of the product that the grade is applicable to.

Refer to Face definition for any enumerations.

(sequence)

The sequence of items below is mandatory. A single instance is required.

SpanRating

SpanRating is optional. A single instance might exist.

Span Rating according to NIST standards and indicated on grade stamp.

Refer to SpanRating definition for any enumerations.

StrengthGroup

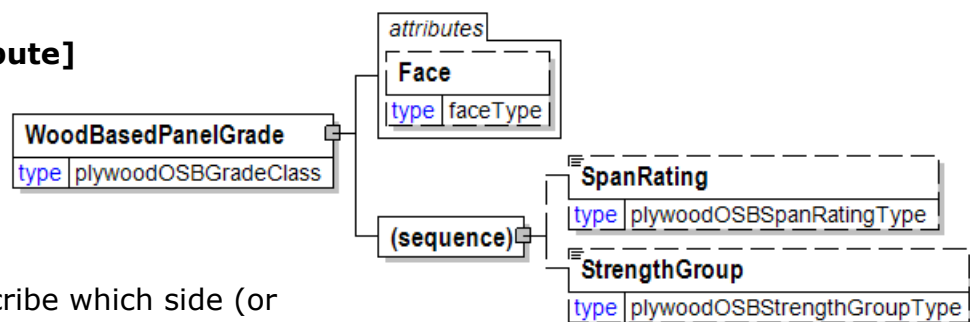

StrengthGroup is optional. A single instance might exist.

As defined in the NIST standard, an additional classification of panel strength.

Refer to StrengthGroup definition for any enumerations.

WoodItem

Group element containing elements describing a wood industry product.

(sequence)

The sequence of items below is mandatory. A single instance is required.

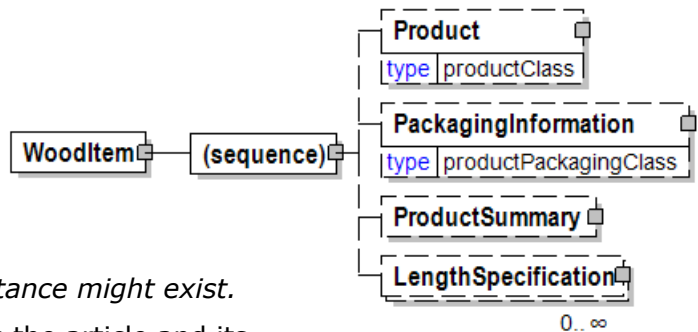

Product

Product is optional. A single instance might exist.

Product is a group item defining the article and its characteristics. Product is used to specify product characteristics organized by ProductIdentifier, ProductDescription, and Classification. Book Manufacturing, Label Stock, Paper, Pulp, Recovered Paper, Wood Products, and Virgin Fibre market segments have defined their product characteristics and conversion features for implementation in papiNet.

PackagingInformation

PackagingInformation is optional. A single instance might exist.

Group element construct used to all information associated with the packaging of a product. Measurements, package ID, label, stencil, band, pallet and wrap characteristics may all be detailed.

ProductSummary

ProductSummary is optional. A single instance might exist.

Group of elements to provide summary information on product level.

LengthSpecification

LengthSpecification is optional. Multiple instances might exist.

Length specification of the wood product.

WoodPanelCharacteristics

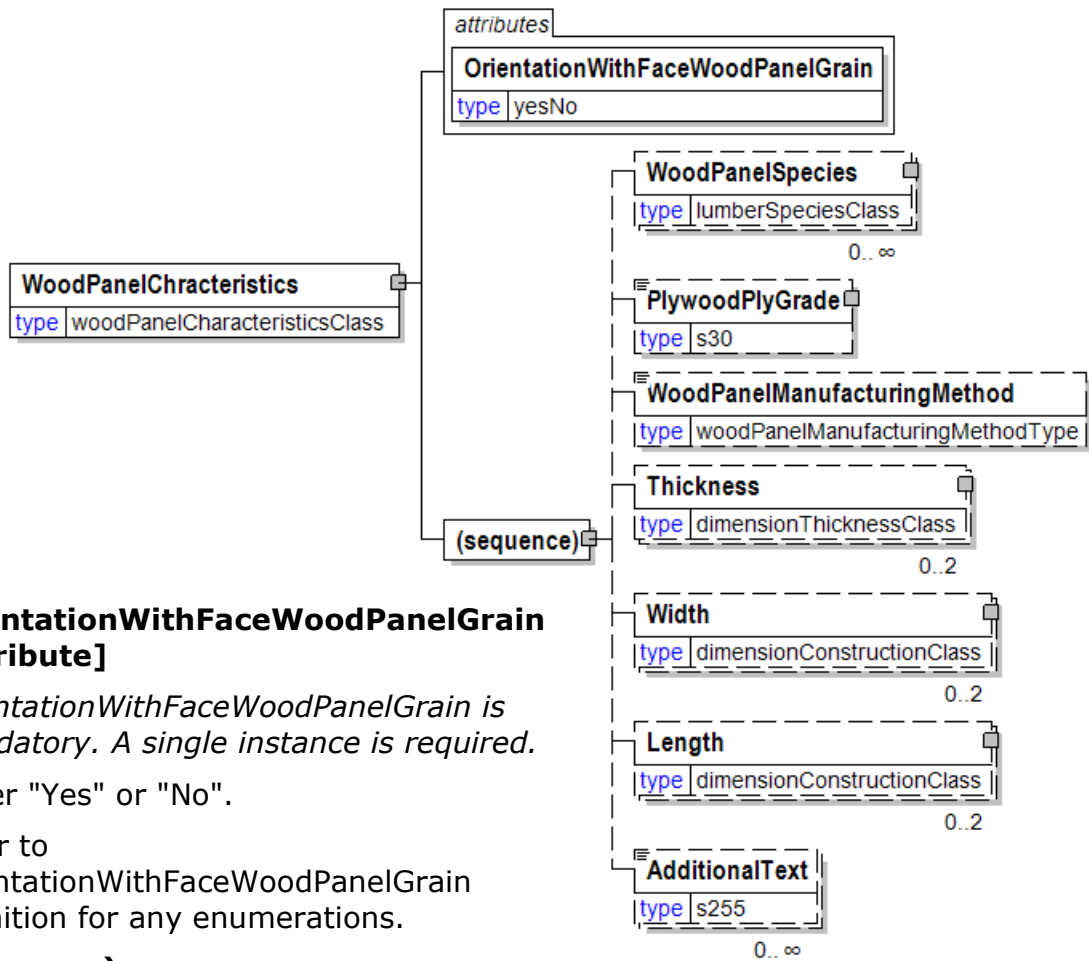

OrientationWithFaceWoodPanelGrain [attribute]

OrientationWithFaceWoodPanelGrain is mandatory. A single instance is required.

Either "Yes" or "No".

Refer to OrientationWithFaceWoodPanelGrain definition for any enumerations.

(sequence)

The sequence of items below is mandatory. A single instance is required.

WoodPanelSpecies

WoodPanelSpecies is optional. Multiple instances might exist.

Characteristics of the lumber used in the item.

PlywoodPlyGrade

PlywoodPlyGrade is optional. A single instance might exist.

Defines the grade of one ply, used with Agency to specify the grading agency.

WoodPanelManufacturingMethod

WoodPanelManufacturingMethod is optional. A single instance might exist.

The manufacturing method for the wood panels.

Refer to WoodPanelManufacturingMethod definition for any enumerations.

Thickness

Thickness is optional.

Physical dimension of a product.

Width

Width is optional.

The width of the object.

Length

Length is optional.

The length of the object.

AdditionalText

AdditionalText is optional. Multiple instances might exist.

A text field that is used to communicate information not previously defined or for special instructions. To be used only for circumstances not covered by specific elements.

WoodPanelManufacturingMethod

The manufacturing method for the wood panels.

WoodPanelManufacturingMethod
type woodPanelManufacturingMethodType

WoodPanelProducts

Characteristics of wood panelling products.

(sequence)

The sequence of items below is mandatory. A single instance is required.

WoodBasedPanelGrade

WoodBasedPanelGrade is optional. A single instance might exist.

WoodPanelSpecies

WoodPanelSpecies is optional. Multiple instances might exist.

Characteristics of the lumber used in the item.

Thickness

Thickness is optional.

Physical dimension of a product.

Width

Width is optional.

The width of the object.

Length

Length is optional.

The length of the object.

PlywoodLayupStructure

PlywoodLayupStructure is optional. A single instance might exist.

Edge

Edge is optional.

Describes the finishing of the edge of the board.

Side

Side is optional.

The structure defines the features of a panel's side. An attribute of side element indicates which side (either top or bottom the child elements refer to).

PressureTreatment

PressureTreatment is optional. A single instance might exist.

Method and parameter values of pressure treatment.

FireTreatment

FireTreatment is optional. A single instance might exist.

Fire treatment

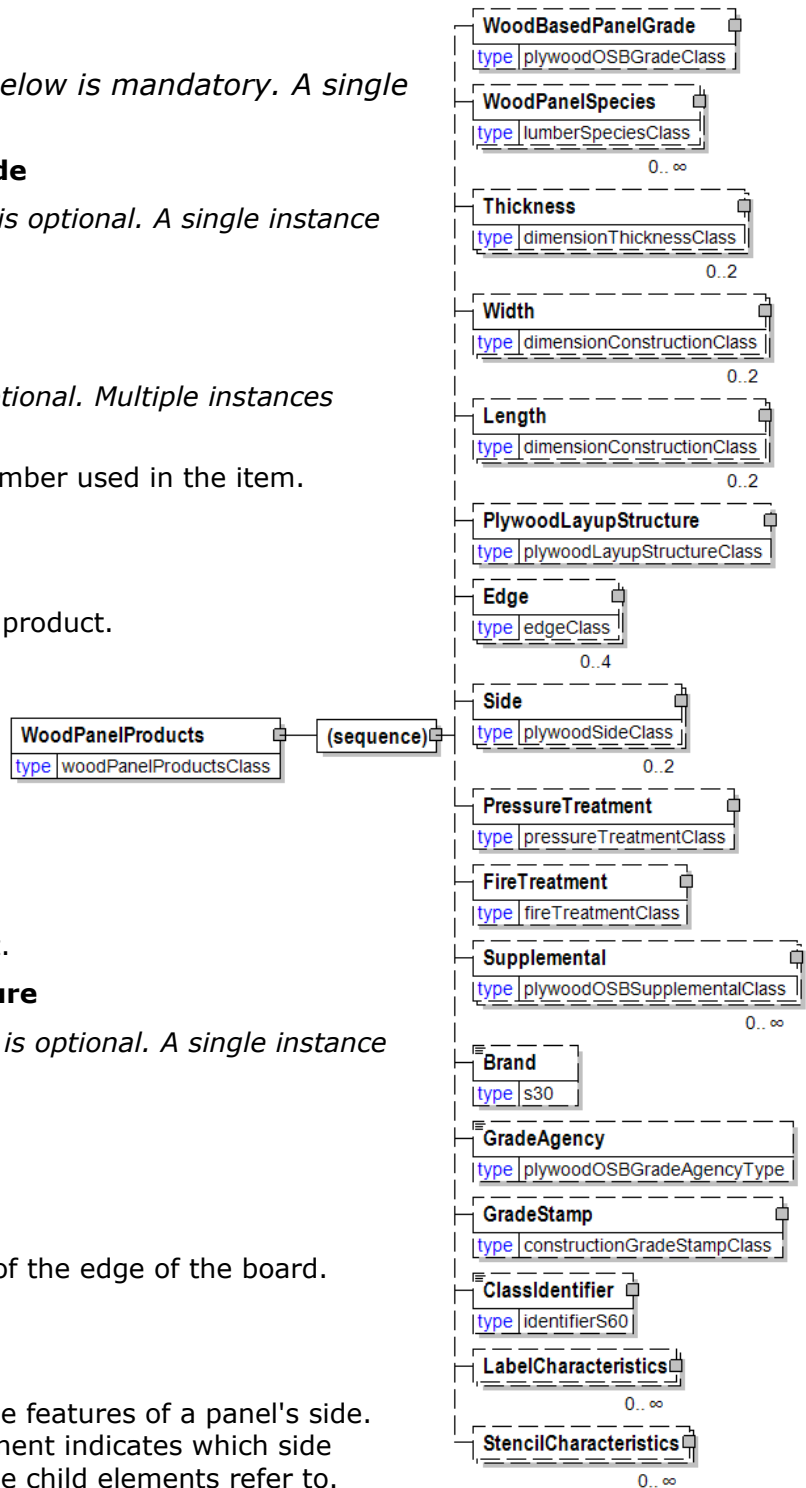

Supplemental

Supplemental is optional. Multiple instances might exist.

Supplemental

Brand

Brand is optional. A single instance might exist.

Specifies a trade name for an item. E.g. the brand name of a transport vehicle, the brand name of a material etc.

GradeAgency

GradeAgency is optional. A single instance might exist.

North American structural panel grading agencies. Defines the governing organisation of the grading scheme employed.

Note: There is a GradeAgency attribute, as well.

Refer to GradeAgency definition for any enumerations.

GradeStamp

GradeStamp is optional. A single instance might exist.

Grade stamp information

ClassIdentifier

ClassIdentifier is optional. A single instance might exist.

Standard used for product identification.

LabelCharacteristics

LabelCharacteristics is optional. Multiple instances might exist.

A group item that organises the labeling information.

StencilCharacteristics

StencilCharacteristics is optional. Multiple instances might exist.

A group element specifying attributes of a stencil to be applied to an item, and optional text.

WoodPanelSpecies

Characteristics of the lumber used in the item.

SpeciesType [attribute]

SpeciesType is optional. A single instance might exist.

Defines the species or mix of species comprising the product.

Refer to SpeciesType definition for any enumerations.

SpeciesOrigin [attribute]

SpeciesOrigin is optional. A single instance might exist.

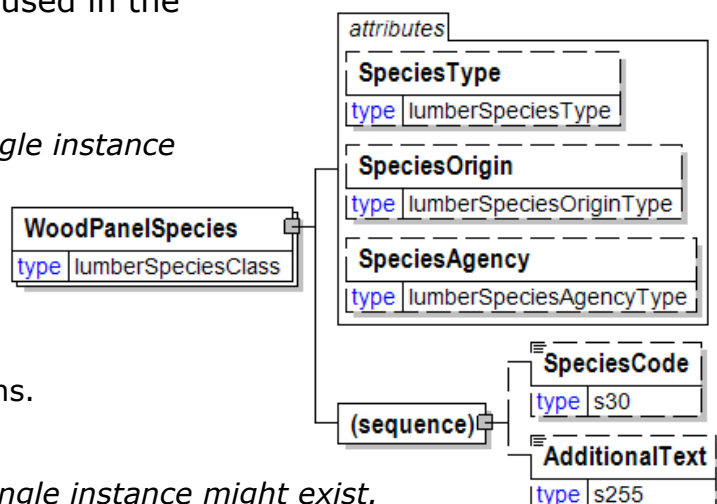

papiNet V2R31

The country of origin of the species employed in manufacture of the product.
Refer to SpeciesOrigin definition for any enumerations.

SpeciesAgency [attribute]

SpeciesAgency is optional. A single instance might exist.

Defines the governing organisation of the scheme employed in determining the species of the product.

Refer to SpeciesAgency definition for any enumerations.

(sequence)

The sequence of items below is mandatory. A single instance is required.

SpeciesCode

SpeciesCode is optional. A single instance might exist.

Species Code

AdditionalText

AdditionalText is optional. A single instance might exist.

A text field that is used to communicate information not previously defined or for special instructions. To be used only for circumstances not covered by specific elements.

WoodProducts

A grouping element for all wood products.

(sequence)

The sequence of items below is mandatory. A single instance is required.

(choice)

[choice] is mandatory. A single instance is required.

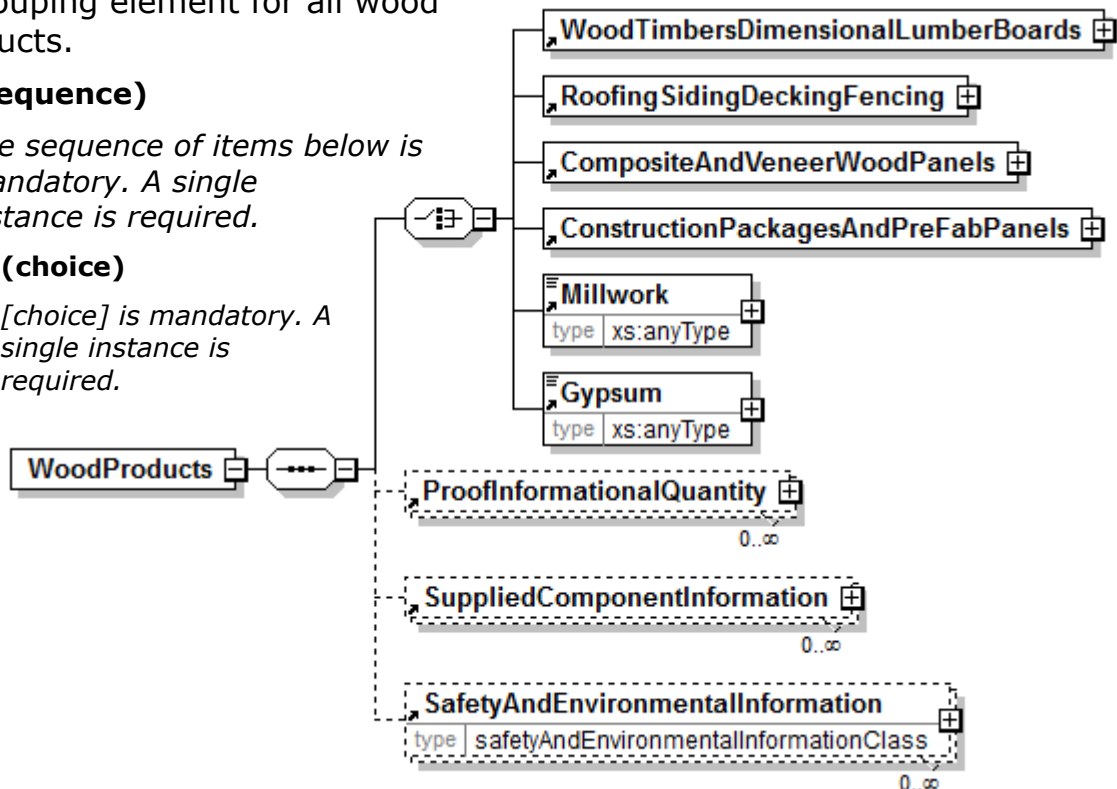

WoodTimbersDimensionalLumberBoards

WoodTimbersDimensionalLumberBoards is mandatory. A single instance is required.

papiNet V2R31

A grouping element that contains the various types of dimensional lumber.

RoofingSidingDeckingFencing

RoofingSidingDeckingFencing is mandatory. A single instance is required.

A grouping element that contains the timber/lumber products that are used in roofing, siding, decking, or fencing.

CompositeAndVeneerWoodPanels

CompositeAndVeneerWoodPanels is mandatory. A single instance is required.

A grouping element that contains the timber/lumber products that comprise composite and veneer wood panels.

ConstructionPackagesAndPreFabPanels

ConstructionPackagesAndPreFabPanels is mandatory. A single instance is required.

A grouping element that contains the timber/lumber products that comprise construction packages and pre-fabricated panels.

Millwork

Millwork is mandatory. A single instance is required.

A placeholder for the further definition of millwork items.

Gypsum

Gypsum is mandatory. A single instance is required.

A placeholder for further definition of gypsum items.

ProofInformationalQuantity

ProofInformationalQuantity is optional. Multiple instances might exist.

ProofInformationalQuantity

SuppliedComponentInformation

SuppliedComponentInformation is optional. Multiple instances might exist.

Information about components supplied by the publisher to the vendor i.e. paper supplied to the print vendor or jackets supplied to the bind vendor.

SafetyAndEnvironmentalInformation

SafetyAndEnvironmentalInformation is optional. Multiple instances might exist.

Name of certification type, if any, on the goods (For example, FSC, PEFC). SafetyAndEnvironmental needs a value or measurement to communicate the percentage of the product is certified (for example, 75% is certified by the indicated agency).

WoodTimbersDimensionalLumberBoards

A grouping element that contains the various types

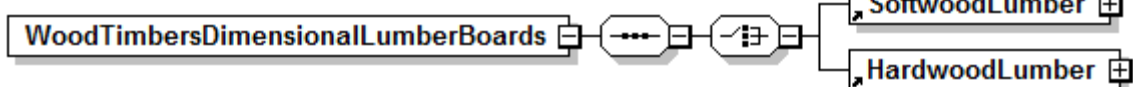

of dimensional lumber.

(sequence)

The sequence of items below is mandatory. A single instance is required.

(choice)

[choice] is mandatory. A single instance is required.

SoftwoodLumber

SoftwoodLumber is mandatory. A single instance is required.

Product structure for solid wood products made of softwood

HardwoodLumber

HardwoodLumber is mandatory. A single instance is required.

Product structure for solid wood products made of hardwood.

Wrap

A group item that organises wrapping detail information.

WrapType [attribute]

WrapType is optional. A single instance might exist.

Communicates the type of material used to wrap the product.

Refer to WrapType definition for any enumerations.

WrapProperties [attribute]

WrapProperties is optional. A single instance might exist.

Communicates the nature of the wrap that is used to package the product

Refer to WrapProperties definition for any enumerations.

WrapLocation [attribute]

WrapLocation is optional. A single instance might exist.

Wrap Location

Refer to WrapLocation definition for any enumerations.

(sequence)

The sequence of items below is mandatory. A single instance is required.

NumberOfWraps

NumberOfWraps is optional. A single instance might exist.

The number of turns of wrapping material to be applied to the package.

Brand

Brand is optional. A single instance might exist.

Specifies a trade name for an item. E.g. the brand name of a transport vehicle, the brand name of a material etc.

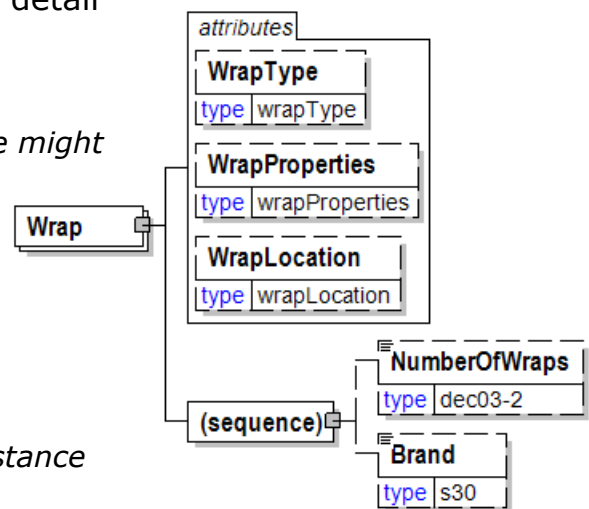

WrapCharacteristics

A group element that contains elements that describe the manner in which the item is wrapped.

(sequence)

The sequence of items

below is mandatory. A single instance is required.

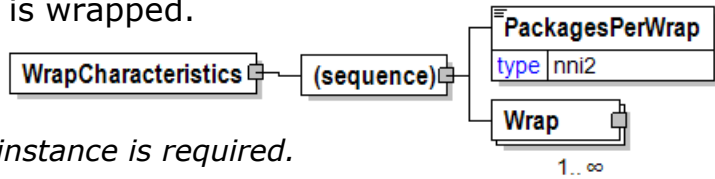

PackagesPerWrap

PackagesPerWrap is mandatory. A single instance is required.

The number of packages wrapped together.

Wrap

Wrap is mandatory. One instance is required, multiple instances might exist.

A group item that organises wrapping detail information.

WrapLocation [attribute]

Wrap Location

This item is restricted to the following list.

None

Entire

Indicates that the entire item (box, pallet, etc.) is wrapped.

Top

Bottom

FiveSides

TopAndEnds

Ends

LongSides

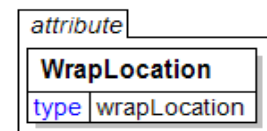

WrapProperties [attribute]

Communicates the nature of the wrap that is used to package the product

This item is restricted to the following list.

Bleached

the wrapping has been bleached using one of the methods described in the data type bleachingProcess.

Unbleached

the wrapping has not been bleached

MoistureBarrier

the wrapping provides a barrier to moisture.

Pulpable



the wrapping can be blended with pulp and reused.

WrapType [attribute]

Communicates the type of material used to wrap the product.

This item is restricted to the following list.

Cardboard

Chipboard

Fibreboard

KraftPaper

Kraft paper is used to wrap the product.

Laminatedboard

Metal

None

The product is not wrapped

Paper

Peelercores

Plastic

PlasticBag

The product is wrapped in a plastic bag.

Plywood

Self

The product is wrapped using the same material that is contained within.

ShrinkWrap

The product is wrapped using shrink wrap material.

StretchWrap

The product is wrapped using stretch wrap material.

Timber

attribute
WrapType
type wrapType

Year

Identifies the year number when communicating a calendar date.

Year
type gYear

YearMonth

Identifies the month of the calendar year according to format specified by ISO 8601, The ISO 8601 format for the month of the calendar year is YYYY-MM, for example 2016-10.



Yellow

The Yellow component of a colour.

(sequence)

The sequence of items below is mandatory. A single instance is required.

DetailValue

DetailValue is mandatory. A single instance is required.

A numeric value expressed in the unit of measure (UOM).

DetailRangeMin

DetailRangeMin is optional. A single instance might exist.

The minimum value (lower boundary) allowed for the DetailValue that is the parent of this element.

DetailRangeMax

DetailRangeMax is optional. A single instance might exist.

The maximum value (upper boundary) allowed for the DetailValue that is the parent of this element.

StandardDeviation

StandardDeviation is optional. A single instance might exist.

A statistic used as a measure of dispersion in a distribution.

SampleSize

SampleSize is optional. A single instance might exist.

The number of samples used to determine the product characteristic in question.

TwoSigmaLower

TwoSigmaLower is optional. A single instance might exist.

Two sigma (a measure of dispersion associated with standard deviation) on the lower side of the standard deviation.

TwoSigmaUpper

TwoSigmaUpper is optional. A single instance might exist.

Two sigma (a measure of dispersion associated with standard deviation) on the upper side of the standard deviation.

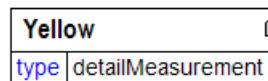

(sequence)

