



**papiNet**

**PurchaseOrder**

**papiNet Standard - Version 2.31**

**Documentation**

**Global Standard for the Paper and Forest  
Products Supply Chain**

**Build V2R31\_20170406**

**Date 2017-05-07**

**Production Release**

# PurchaseOrder

## papiNet Standard - Version 2.31

---

---

### Copyright

Copyright 2000 - 2017 papiNet G.I.E ("papiNet") and International Digital Enterprise Alliance, Inc. ("IDEAlliance") collectively "Copyright Owner". All rights reserved by the Copyright Owner under the laws of the United States, Belgium, the European Economic Community, and all states, domestic and foreign. This document may be downloaded and copied provided that all copies retain and display the copyright and any other proprietary notices contained in this document. This document may not be sold, modified, edited, or taken out of context such that it creates a false or misleading statement or impression as to the purpose or use of the papiNet specification, which is an open standard. Use of this Standard, in accord with the foregoing limited permission, shall not create for the user any rights in or to the copyright, which rights are exclusively reserved to the Copyright Owner.

papiNet, IDEAlliance, and the members of all papiNet Groups (collectively and individually, "Presenters") make no representations or warranties, express or implied, including, but not limited to, warranties of merchantability, fitness for a particular purpose, title, or non-infringement. The presenters do not make any representation or warranty that the contents of this document are free from error, suitable for any purpose of any user, or that implementation of such contents will not infringe any third party patents, copyrights, trademarks or other rights. By making use of this document, the user assumes all risks and waives all claims against Presenters.

In no event shall Presenters be liable to user (or other person) for direct, indirect, special or consequential damages arising from or related to any use of this document, including, without limitation, lost profits, business interruption, loss of programs, or other data on your information handling system even if Presenters are expressly advised of the possibility of such damages.

---

### Use of Documents in papiNet Implementations

Documents may be used as templates for a papiNet implementation. The Presenters grant the right to modify and edit them to fit an actual implementation project provided all copies display the copyright and any other proprietary notices contained in this document. Such modified documents must not be distributed beyond the trading partners implementing or maintaining a papiNet connection.

# PurchaseOrder

## papiNet Standard - Version 2.31

---

---

### Table of Contents

Copyright .....	2
Use of Documents in papiNet Implementations .....	2
Table of Contents .....	3
PurchaseOrder Documentation .....	4
PurchaseOrder e-Document Overview .....	4
The Scope of PurchaseOrder e-Document .....	4
PurchaseOrderType [attribute] .....	4
Business Rules for PurchaseOrder .....	5
Processing the PurchaseOrder e-Document .....	6
Understanding the Diagrams and Content .....	8
PurchaseOrder Root Element.....	10
PurchaseOrder.....	10
Primary Elements .....	13
PurchaseOrderHeader.....	13
PurchaseOrderLineItem .....	17
MonetaryAdjustment .....	22
PurchaseOrderSummary .....	28
PurchaseOrder Business Scenarios.....	29
PurchaseOrder Scenario Listing .....	29
Scenario A .....	29
Scenario B .....	30
Scenario C .....	30
Scenario D .....	31
Scenario F .....	32
Scenario G .....	33
Scenario H .....	33

# PurchaseOrder

## papiNet Standard - Version 2.31

---

---

### PurchaseOrder Documentation

---

#### PurchaseOrder e-Document Overview

A buyer sends a PurchaseOrder e-Document to a supplier to initiate a trade transaction. This e-Document, which is a request for product, usually represents a firm commitment to buy. (For one type of purchase order, called a reservation order, the purchase order is not a firm commitment to buy.)

A PurchaseOrder may be preceded by a quotation request. It may also refer to prior agreements between the parties such as:

- A contract, which is an agreement between a buyer and a supplier that can specify price, terms and conditions, products, and quantities to be provided over a given period of time.
- A specification, which is a definition of the manufacturing requirements for a specified product.
- A blanket order, which is an agreement between a buyer and a supplier for a given period of time. A blanket order, which typically specifies a particular product, may also specify the maximum volume or amount to be spent with a supplier.

There are seven types of purchase orders. They can be used to specify quantities of product(s) to be purchased, release product(s) to be manufactured, order product samples, book manufacturing capacity, and confirm an order placed by fax, phone, or email.

---

#### The Scope of PurchaseOrder e-Document

The PurchaseOrder e-Document must include:

- Products and quantities to be delivered
- The characteristics of the product(s) requested
- Ship-to party

The PurchaseOrder e-Document can include:

- Requested delivery date and time
- The price of the product
- Other special instructions

Using this information, the supplier can:

- Begin to plan for the manufacturing process

---

#### PurchaseOrderType [attribute]

Defines the type of PurchaseOrder issued.

*This item is restricted to the following list.*

##### **BlanketOrder**

An order that communicates the same information as a StandardOrder but also indicates that the order may be completed over a period of time or, until a certain volume is achieved or, until a certain currency amount is spent.

##### **ConfirmingOrder**

A confirming order is used to electronically confirm an order that has not been

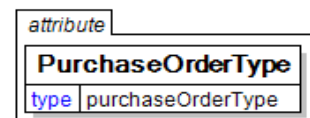

# PurchaseOrder

## papiNet Standard - Version 2.31

---

placed electronically by the customer that is, it was placed using another mean such as fax, phone or email.

### ConsumptionOrder

A PurchaseOrder that is based upon consumption for a particular period of time or instance.

### ReleaseOrder

A release order is used to release a product to be made. This type of order refers to a previous order or agreement, such as a reservation order, a contract, or a blanket order. A release number version which is an incremented number, is used in this type.

### ReservationOrder

A reservation order is used to book a paper supplier's capacity for specific quantities of specific products, but it is not yet a firm commitment to buy. Consequently, all line items of a reservation order have a ProductionStatusType of NotFree. To release one or more PurchaseOrder line items of a reservation order, a buyer can use a standard order or a release order.

### StandardOrder

A standard order is a regular one-time order. It defines quantities for one or more products to be purchased and may also define a delivery location and date. A standard order may reference a previous agreement (for example, a quotation, a contract, or a reservation order) for information.

### TrialOrder

A trial order is used whenever a seller has agreed to have a buyer sample a product. The seller needs to process this order differently from other orders, because a trial order may include a product sold at a discounted rate or even provided for free. A trial order typically is for small quantities.

---

## Business Rules for PurchaseOrder

### General Business Rules

The following table list the business rules that apply to purchase orders. There are no rules that apply only to a specific PurchaseOrder e-Document type.

Identifier	Business Rule
ORD001	There are five types of PurchaseOrder e-Documents: BlanketOrder, ConfirmingOrder, ConsumptionOrder, ReleaseOrder, ReservationOrder, StandardOrder, TrialOrder
ORD002	A PurchaseOrder contains one or more PurchaseOrderLineItem(s).
ORD003	A PurchaseOrderLineItem contains one product. This is specified in Product and identified in the ProductIdentifier.

## PurchaseOrder papiNet Standard - Version 2.31

Identifier	Business Rule
<b>ORD004</b>	A PurchaseOrderLineItem is uniquely identified by a PurchaseOrderLineItemNumber, which is never deleted even if the PurchaseOrderLineItem is cancelled.
<b>ORD005</b>	A PurchaseOrderHeader can specify only one ShipToParty. The buyer can, however, specify multiple ship-to parties at the PurchaseOrderLineItem level. A PurchaseOrderLineItem ShipToParty overrides a PurchaseOrderHeader ShipToParty.
<b>ORD006</b>	A PurchaseOrderLineItem can specify only one ShipToParty. When a supplier needs to deliver one product to two different ship-to parties, the buyer must include two PurchaseOrderLineItem(s). Note: Both the CallOff and ShippingInstructions e-Documents provide the capability to update ShipTo information.
<b>ORD007</b>	Transport information is optional. It may appear at either the PurchaseOrderHeader or the PurchaseOrderLineItem level, depending on transport requirements. The information in the PurchaseOrderLineItem overrides the information at the PurchaseOrderHeader.
<b>ORD008</b>	To place a release against a contract, a blanket order, or a ReservationOrder, a buyer uses a ReleaseOrder.
<b>ORD009</b>	A ReleaseOrder must contain a reference to a contract, blanket order, or ReservationOrder in the PurchaseOrderInformation.

### Paper Manufacturing Business Rules

Identifier	Business Rule
<b>ORD010</b>	An ActionType of "Special" for either ReelPackagingCharacteristics or SheetPackagingCharacteristics indicates that the information contained is unique to the PurchaseOrder and the PurchaseOrderLineItem.

### Processing the PurchaseOrder e-Document

e-Document processing depends on the type of PurchaseOrder and values

# PurchaseOrder

## papiNet Standard - Version 2.31

---

of the three status fields used within the document: e-Document, header, and line item. The status at the e-Document level dictates the statuses at the header and line items levels that can be used.

At the e-Document level, the values for the PurchaseOrderStatusType field are "Amended", "Cancelled", and "Original". The values that are available for the header and line item status fields are "Amended", "Cancelled", "New", and "NoAction".

Notes:

- The PurchaseOrderHeaderStatusType and PurchaseOrderLineItemStatusType always match the PurchaseOrderStatusType.
- The OrderConfirmation e-Document, sent from the supplier to the buyer in response to a PurchaseOrder, completes the PurchaseOrder exchange loop.

The buyer may resend the PurchaseOrder to the supplier with two other statuses: "Amended" or "Cancelled". An amended PurchaseOrder includes an amended header and/or line items that are amended, added, cancelled, or not changed from the previous PurchaseOrder.

### **Status Values Used When Processing the PurchaseOrder e-Document**

The status of the PurchaseOrder e-Document is communicated by the following attributes of PurchaseOrder, the PurchaseOrderStatusType.

- Original – Indicates that this is the first transmission of the e-Document.
- Amended – Indicates that the buyer wants to amend the e-Document by changing the header and/or adding, amending, or cancelling line items.
- Cancelled – Indicates that the buyer wants to cancel the e-Document (and therefore the commitment between the parties).

When a buyer sends a PurchaseOrder to a seller, the PurchaseOrderStatusType at the e-Document level has a status of "Original" and both the PurchaseOrderHeaderStatusType and PurchaseOrderLineItemStatusType are set to "New". When an item is added to an existing order the PurchaseOrderLineItemStatusType of "New" is used.

When a buyer decides to cancel an entire order the PurchaseOrderStatusType, PurchaseOrderHeaderStatusType, and PurchaseOrderLineItemStatusType will all be "Cancelled".

If a line item is cancelled the PurchaseOrderLineItemStatusType will be "Cancelled". If all line items are "Cancelled" then the order is cancelled and all statuses will indicate this. The PurchaseOrderHeaderStatusType will only be "Cancelled" when the e-Document is "Cancelled".

When a buyer communicates order changes an "Amended" status is set at the e-Document, the header, and the line item where the change(s) are taking place. If only one line item of a multi line order is changed the PurchaseOrderStatusType will be "Amended" and the line item's PurchaseOrderLineItemStatusType will be "Amended". If there are particular

# PurchaseOrder

## papiNet Standard - Version 2.31

---

line items of a document with an "Amended" status that have no changes the "NoAction" status will be used. If the header has no changes then the PurchaseOrderHeaderStatusType will be "NoAction".

If only one line item of a multi line order is "Cancelled" the PurchaseOrderStatusType will be "Amended" and the associated PurchaseOrderLineItemStatusType will be "Cancelled". All other line items will have a status of "NoAction".

### Geographic Practices

North American buyers typically include a delivery schedule in their purchase orders. In contrast, European buyers often provide delivery information in CallOff e-Documents rather than in purchase orders. When buyers expect to send CallOff e-Documents, they include start call off dates in their purchase orders. Suppliers are then expected to make the product(s) specified in the order available for call off on the start call off date.

Another difference between North American and European practices is the use of a reservation order to book mill capacity. In Europe, commercial printing or packaging buyers commonly book paper machine capacity in anticipation of, but prior to, a customer confirming the job. Once the job confirmation has been received, these buyers will authorize the paper mill to release production at the appropriate time.

---

## Understanding the Diagrams and Content

This section provides a graphical view of the schema structures, a discussion of the item's children. You can find additional information about papiNet and the standard at [www.papiNet.org](http://www.papiNet.org).

The graphics contain content model indicators, cardinality indicators, and data type information.

Associated with each graphic are the definitions for the parent item and any associated child items. All attributes are listed first, followed by the elements.

The following information should help you interpret and understand this standard. Please note the following:

- Content Model and Cardinality operate together to determine if the element or attribute are required in the instance document.
- The same attribute can never appear multiple times in the same element so, you will never see a multiple cardinality indicator.

### Content model indicators:

There are three possible types of content: "sequence", "choice", and "all". The papiNet standard currently does not use the "all" construct.

- (sequence)

The sequence of the items to the right of the graphic (or below the text) is required.

- (choice)

A choice of the items to the right of the graphic (or below the text) is permitted.

- (all)



# PurchaseOrder

## papiNet Standard - Version 2.31

---

---

All the items to the right of the graphic are required.

### Cardinality indicators:

- Dotted line around element or attribute.  
A single instance of the item can optionally exist.
- Dotted line around item with range indicated below.  
Multiple instances of the item can optionally exist.
- Solid line around item.  
A single instance of the item must exist.
- Solid line around item with range indicated below  
At least one instance must exist; multiple instances can optionally exist.

### Datatype indication:

When a data type is assigned to an element (either a simple type or complex type the name of the data type is presented beneath the item name in the graphic.

- In some cases additional information about the data type is presented (the default value).

Elements can either have content that is textual/numeric in nature or content that is made up of additional elements and/or attributes.

- When the content is textual/numeric in nature “three straight horizontal lines” will appear in the upper left-hand corner of the graphic. Pay attention to these elements because they are where you will be entering your information.
- When the content is made up of additional elements and/or attributes a “gray-box” will appear on the right-hand side of the graphic.
- If the graphic shows both the horizontal lines and the gray-box then, in the papiNet standard, the content below the element are attributes.

# PurchaseOrder

## papiNet Standard - Version 2.31

### PurchaseOrder Root Element

#### PurchaseOrder

The PurchaseOrder element is the root element for the PurchaseOrder e-Document.

A buyer sends a PurchaseOrder e-Document to a supplier to initiate a trade transaction. This e-Document, which is a request for product, usually represents a firm commitment to buy. (For one type of PurchaseOrder, called a reservation order, the PurchaseOrder is not a firm commitment to buy).

#### PurchaseOrderStatusType [attribute]

*PurchaseOrderStatusType* is mandatory. A single instance is required.

Defines the status of the entire PurchaseOrder e-Document, in other words, at the root level

*This item is restricted to the following list.*

##### Amended

The supplied information is changed.

##### Cancelled

The supplied information has been cancelled. Items that have been cancelled are not included in totals on the summary levels of the e-document.

##### Original

The supplied information is the first version of that information.

#### PurchaseOrderType [attribute]

*PurchaseOrderType* is mandatory. A single instance is required.

Defines the type of PurchaseOrder issued.

*This item is restricted to the following list.*

##### BlanketOrder

An order that communicates the same information as a StandardOrder but also indicates that the order may be completed over a period of time or, until a certain volume is achieved or, until a certain currency amount is spent.

##### ConfirmingOrder

A confirming order is used to electronically confirm an order that has not been placed electronically by the customer that is, it was placed using another means such as fax, phone or email.

##### ConsumptionOrder

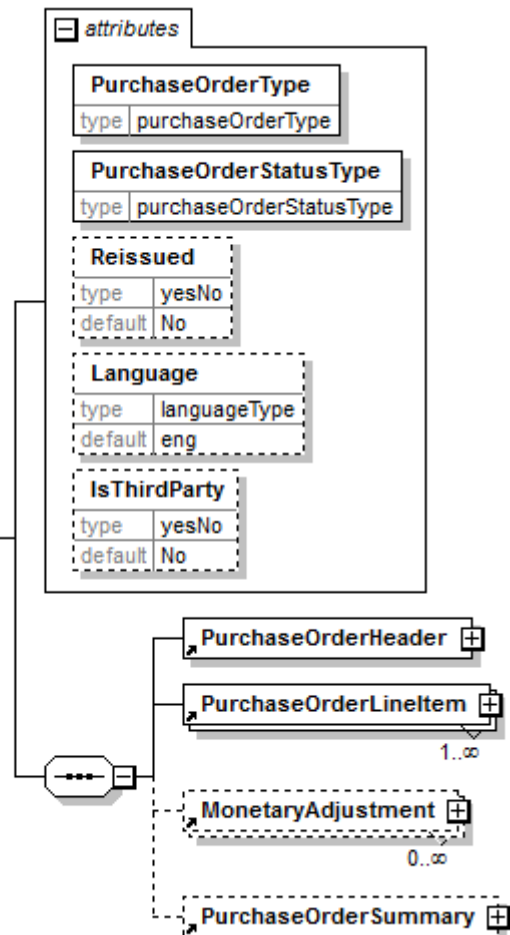

# PurchaseOrder

## papiNet Standard - Version 2.31

---

A PurchaseOrder that is based upon consumption for a particular period of time or instance.

### **ReleaseOrder**

A release order is used to release a product to be made. This type of order refers to a previous order or agreement, such as a reservation order, a contract, or a blanket order. A release number version which is an incremented number, is used in this type.

### **ReservationOrder**

A reservation order is used to book a paper supplier's capacity for specific quantities of specific products, but it is not yet a firm commitment to buy. Consequently, all line items of a reservation order have a ProductionStatusType of NotFree. To release one or more PurchaseOrder line items of a reservation order, a buyer can use a standard order or a release order.

### **StandardOrder**

A standard order is a regular one-time order. It defines quantities for one or more products to be purchased and may also define a delivery location and date. A standard order may reference a previous agreement (for example, a quotation, a contract, or a reservation order) for information.

### **TrialOrder**

A trial order is used whenever a seller has agreed to have a buyer sample a product. The seller needs to process this order differently from other orders, because a trial order may include a product sold at a discounted rate or even provided for free. A trial order typically is for small quantities.

### **Language [attribute]**

*Language is optional. A single instance might exist.*

XML has embraced 2 and 3 digit language codes through the application of an addendum to the standard.

Information on the content of this attribute is available at <http://www.loc.gov/standards/iso639-2/> this is the official site of the ISO 639-2 Registration Authority.

- <http://www.w3.org/International/O-HTML-tags.html> provides an explanation of the errata updating XML.
- <http://www.ietf.org/rfc/rfc3066.txt> is the key document that is referenced in the above errata.

### **Reissued [attribute]**

*Reissued is optional. A single instance might exist.*

Either "Yes" or "No".

*This item is restricted to the following list.*

**Yes**

**No**

### **IsThirdParty [attribute]**

*IsThirdParty is optional. A single instance might exist.*

Indication of an indirect business process.

*This item is restricted to the following list.*

# PurchaseOrder

## papiNet Standard - Version 2.31

---

---

Yes

No

**(sequence)**

*The sequence of items below is mandatory. A single instance is required.*

### **PurchaseOrderHeader**

*PurchaseOrderHeader is mandatory. A single instance is required.*

The header level of information for the PurchaseOrder containing information that relates to the entire PurchaseOrder.

### **PurchaseOrderLineItem**

*PurchaseOrderLineItem is mandatory. One instance is required, multiple instances might exist.*

A group item containing information that relates to a line on the purchase order.

### **MonetaryAdjustment**

*MonetaryAdjustment is optional. Multiple instances might exist.*

The element containing the information necessary for the understanding, calculation, and treatment of an adjustment to a currency amount. MonetaryAdjustment contains an attribute that indicates the type of adjustment being communicated.

### **PurchaseOrderSummary**

*PurchaseOrderSummary is optional. A single instance might exist.*

A group item containing summary information applicable to the entire purchase order.

# PurchaseOrder

## papiNet Standard - Version 2.31

### Primary Elements

#### PurchaseOrderHeader

The header level of information for the PurchaseOrder containing information that relates to the entire PurchaseOrder.

##### **PurchaseOrderHeaderStatusType** [attribute]

*PurchaseOrderHeaderStatusType is mandatory. A single instance is required.*

Defines the status of the PurchaseOrder header

*This item is restricted to the following list.*

##### **Amended**

The supplied information is changed.

##### **Cancelled**

The supplied information has been cancelled. Items that have been cancelled are not included in totals on the summary levels of the e-document.

##### **New**

The supplied information is new and supplied for the first time.

##### **NoAction**

The supplied information has not been amended and thereby requires no action.

##### **(sequence)**

*The sequence of items below is mandatory. A single instance is required.*

##### **PurchaseOrderInformation**

*PurchaseOrderInformation is mandatory. A single instance is required.*

A group item containing information unique to this PurchaseOrder, which is provided by the buyer. PurchaseOrderInformation can be optional in the supply chain. Invoices are created without having a PurchaseOrder in Vendor Managed Inventory. Freight invoices also will not have a PurchaseOrder number.

##### **TransactionHistoryNumber**

*TransactionHistoryNumber is optional. A single instance might exist.*

A sequential number that keeps track of the version of a document being sent by the document originator except

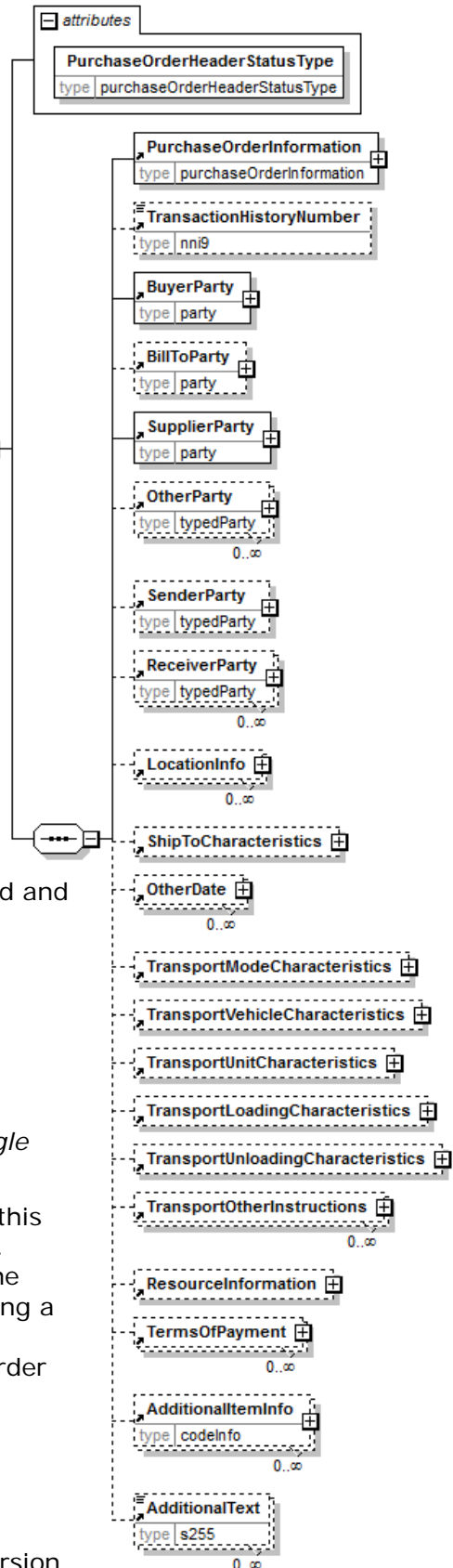

# PurchaseOrder

## papiNet Standard - Version 2.31

---

in the case where TransactionHistoryConfirmation is used, in which case the TransactionHistoryNumber refers to the trigger transaction for which the confirmation is being sent.

### **BuyerParty**

*BuyerParty is mandatory. A single instance is required.*

The legal entity to which the product is sold. Also commonly referred to as the sold-to party or customer. If no OtherParty is defined as the Payer, the Buyer is the Payer.

### **BillToParty**

*BillToParty is optional. A single instance might exist.*

The address where the invoice is to be sent.

### **SupplierParty**

*SupplierParty is mandatory. A single instance is required.*

The organisation or business entity responsible for providing the product. SupplierParty is also the seller of the product, if Seller is not specified as OtherParty = Seller.

### **OtherParty**

*OtherParty is optional. Multiple instances might exist.*

An organisation or business entity other than those specifically detailed within a e-Document.

### **SenderParty**

*SenderParty is optional. A single instance might exist.*

The business entity issuing the e-Document, the source of the document.

- The entity responsible for the content. If the sender party has out sourced the message service to a third party the SenderParty is the issuer of the e-Document and not the party performing the transmission service of the electronic message.

### **ReceiverParty**

*ReceiverParty is optional. Multiple instances might exist.*

The business entity for whom the e-Document is intended, the destination of the document.

- The entity interested in the content. If the receiver party has outsourced the message service to a third party the ReceiverParty is the intended party for the e-Document and not the party performing the receiving service of the electronic message.

### **LocationInfo**

*LocationInfo is optional. A single instance might exist.*

A grouping element that contains information about a geographical location.

### **ShipToCharacteristics**

*ShipToCharacteristics is mandatory. A single instance is required.*

A group item that provides information important for the Ship-To Party.

ShipToCharacteristics may be referenced at both the header and line item level. The reference at the header is required and acts as a default for the value at the line level, unless overridden at the line level.

### **OtherDate**

# PurchaseOrder

## papiNet Standard - Version 2.31

---

---

*OtherDate is optional. Multiple instances might exist.*

A date that may not be specifically detailed within a document (example: print date at the PurchaseOrderLineItem).

### **TransportModeCharacteristics**

*TransportModeCharacteristics is optional. A single instance might exist.*

A group item defining the primary mode of transport.

### **TransportVehicleCharacteristics**

*TransportVehicleCharacteristics is optional. A single instance might exist.*

A group item containing information about a transport vehicle, e.g. a truck. A transport vehicle has its own power and can be used to pull, push, carry, or tow a transport unit loaded with goods.

### **TransportUnitCharacteristics**

*TransportUnitCharacteristics is optional. A single instance might exist.*

A group item containing information about a transport unit, e.g. a trailer. Transport units contain goods and move using power from another source, the transport vehicle.

### **TransportLoadingCharacteristics**

*TransportLoadingCharacteristics is optional. A single instance might exist.*

A group item defining how the transported items are to be loaded.

### **TransportUnloadingCharacteristics**

*TransportUnloadingCharacteristics is optional. A single instance might exist.*

A group item defining how the transported items are to be unloaded.

### **TransportOtherInstructions**

*TransportOtherInstructions is optional. Multiple instances might exist.*

A group item defining any other instructions for the transport not covered in the description of transport mode, vehicle, unit, and loading characteristics or defining an alternative description for the categories mentioned above.

### **ResourceInformation**

*ResourceInformation is optional. A single instance might exist.*

A group item that contains information for specification of resources.

### **TermsOfPayment**

*TermsOfPayment is optional. Multiple instances might exist.*

A group item that contains agreed-to terms defining when, how, and under what conditions the payment is to be made.

When TermsOfPayment is optional; if omitted, TermsOfPayment is controlled through previous negotiation.

### **AdditionalItemInfo**

*AdditionalItemInfo is optional. Multiple instances might exist.*

A grouping element that contains information about additional items specified by an agency. Restricted use of this element is recommended.

### **AdditionalText**

*AdditionalText is optional. Multiple instances might exist.*

# PurchaseOrder

## papiNet Standard - Version 2.31

---

---

A text field that is used to communicate information not previously defined or for special instructions. To be used only for circumstances not covered by specific elements.



# PurchaseOrder

## papiNet Standard - Version 2.31

### PurchaseOrderLineItem

A group item containing information that relates to a line on the purchase order.

#### PurchaseOrderLineItemStatusType [attribute]

*PurchaseOrderLineItemStatusType is mandatory. A single instance is required.*

Defines the status of the PurchaseOrder line item

*This item is restricted to the following list.*

##### Amended

The supplied information is changed.

##### Cancelled

The supplied information has been cancelled. Items that have been cancelled are not included in totals on the summary levels of the e-document.

##### New

The supplied information is new and supplied for the first time.

##### NoAction

The supplied information has not been amended and thereby requires no action.

#### PurchaseOrderLineItemDocumentStatus [attribute]

*PurchaseOrderLineItemDocumentStatus is optional. A single instance might exist.*

Defines the actual document status for the PurchaseOrderLineItem.

*This item is restricted to the following list.*

##### Cancelled

The supplied information of the document item is cancelled. Items that have been cancelled are not included in totals on the summary level of e-documents.

##### Requested

The supplied information of the document item is ordered.

#### Billable [attribute]

*Billable is optional. A single instance might exist.*

Either "Yes" or "No".

*This item is restricted to the following list.*

Yes

No

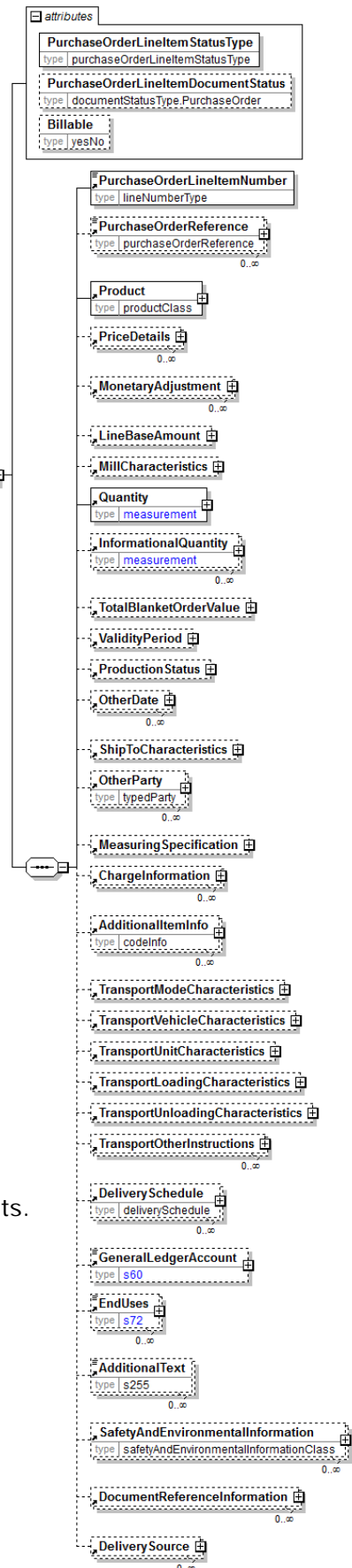

# PurchaseOrder

## papiNet Standard - Version 2.31

---

### (sequence)

*The sequence of items below is mandatory. A single instance is required.*

#### **PurchaseOrderLineItemNumber**

*PurchaseOrderLineItemNumber is mandatory. A single instance is required.*

The sequential number that uniquely identifies the PurchaseOrder line item.

#### **PurchaseOrderReference**

*PurchaseOrderReference is optional. Multiple instances might exist.*

An item detailing relevant references (such as contract number) pertaining to the PurchaseOrder. The type of reference is identified by the PurchaseOrderReferenceType attribute.

#### **Product**

*Product is mandatory. A single instance is required.*

Product is a group item defining the article and its characteristics. Product is used to specify product characteristics organized by ProductIdentifier, ProductDescription, and Classification. Book Manufacturing, Label Stock, Paper, Pulp, Recovered Paper, Wood Products, and Virgin Fibre market segments have defined their product characteristics and conversion features for implementation in papiNet.

#### **PriceDetails**

*PriceDetails is optional. Multiple instances might exist.*

An element that groups together price information.

#### **MonetaryAdjustment**

*MonetaryAdjustment is optional. Multiple instances might exist.*

The element containing the information necessary for the understanding, calculation, and treatment of an adjustment to a currency amount. MonetaryAdjustment contains an attribute that indicates the type of adjustment being communicated.

#### **LineBaseAmount**

*LineBaseAmount is optional. A single instance might exist.*

For the particular e-Document being communicated the LineBaseAmount represents the quantity times the base unit price.

#### **MillCharacteristics**

*MillCharacteristics is optional. A single instance might exist.*

A group item defining the mill party and machine identifier where a product is or was produced.

#### **Quantity**

*Quantity is mandatory. A single instance is required.*

The Quantity element contains attributes that provide information about the type of quantity that is being communicated, the context in which the particular quantity is to be viewed, and (if the quantity represents an adjustment) an adjustment type.

The Quantity element contains three child elements that enable you to communicate a range of values for the quantity and a target or actual value. It is at this level (Value, RangeMin, and RangeMax) that the unit of measure is specified. This permits the range to be specified in a different unit of measure than the

# PurchaseOrder

## papiNet Standard - Version 2.31

---

target.

### **InformationalQuantity**

*InformationalQuantity is optional. Multiple instances might exist.*

A quantity given in a valid UOM used for information purposes only (not for calculation). For example, an ordered quantity was 100 reels as opposed to the invoice quantity of 20,000 pounds.

### **TotalBlanketOrderValue**

*TotalBlanketOrderValue is optional. A single instance might exist.*

The authorized amount of the blanket PurchaseOrder.

### **ValidityPeriod**

*ValidityPeriod is optional. A single instance might exist.*

The validity period for a specific item, e.g. the validity period for an e-Document.

### **ProductionStatus**

*ProductionStatus is optional. A single instance might exist.*

A group item used to communicate the release of a delivery line number.

### **OtherDate**

*OtherDate is optional. Multiple instances might exist.*

A date that may not be specifically detailed within a document (example: print date at the PurchaseOrderLineItem).

### **ShipToCharacteristics**

*ShipToCharacteristics is optional. A single instance might exist.*

A group item that provides information important for the Ship-To Party.

ShipToCharacteristics may be referenced at both the header and line item level. The reference at the header is required and acts as a default for the value at the line level, unless overridden at the line level.

### **OtherParty**

*OtherParty is optional. Multiple instances might exist.*

An organisation or business entity other than those specifically detailed within a e-Document.

### **MeasuringSpecification**

*MeasuringSpecification is optional. A single instance might exist.*

A grouping element that contains a specification for measurement procedures

### **ChargeInformation**

*ChargeInformation is optional. Multiple instances might exist.*

A group element that contains elements that describe a charge. ChargeInformation is used when charge details need to be specified by using a code assigned by an agency. It is typically used for freight costs and other costs related to the supply chain.

### **AdditionalItemInfo**

*AdditionalItemInfo is optional. Multiple instances might exist.*

A grouping element that contains information about additional items specified by an agency. Restricted use of this element is recommended.

# PurchaseOrder

## papiNet Standard - Version 2.31

---

### **TransportModeCharacteristics**

*TransportModeCharacteristics is optional. A single instance might exist.*

A group item defining the primary mode of transport.

### **TransportVehicleCharacteristics**

*TransportVehicleCharacteristics is optional. A single instance might exist.*

A group item containing information about a transport vehicle, e.g. a truck. A transport vehicle has its own power and can be used to pull, push, carry, or tow a transport unit loaded with goods.

### **TransportUnitCharacteristics**

*TransportUnitCharacteristics is optional. A single instance might exist.*

A group item containing information about a transport unit, e.g. a trailer. Transport units contain goods and move using power from another source, the transport vehicle.

### **TransportLoadingCharacteristics**

*TransportLoadingCharacteristics is optional. A single instance might exist.*

A group item defining how the transported items are to be loaded.

### **TransportUnloadingCharacteristics**

*TransportUnloadingCharacteristics is optional. A single instance might exist.*

A group item defining how the transported items are to be unloaded.

### **TransportOtherInstructions**

*TransportOtherInstructions is optional. Multiple instances might exist.*

A group item defining any other instructions for the transport not covered in the description of transport mode, vehicle, unit, and loading characteristics or defining an alternative description for the categories mentioned above.

### **DeliverySchedule**

*DeliverySchedule is optional. Multiple instances might exist.*

A group item defining a series of DeliveryDateWindow(s) in which specified quantities must be delivered.

### **GeneralLedgerAccount**

*GeneralLedgerAccount is optional. A single instance might exist.*

The general ledger account to be referenced for the item.

### **EndUses**

*EndUses is optional. Multiple instances might exist.*

A text element used to express in human readable form a list of applicable end uses for a product. Examples of end uses are:

- Magazine
- Book
- Commercial print
- etc

### **AdditionalText**

*AdditionalText is optional. Multiple instances might exist.*

A text field that is used to communicate information not previously defined or for special instructions. To be used only for circumstances not covered by specific

# PurchaseOrder

## papiNet Standard - Version 2.31

---

---

elements.

### **SafetyAndEnvironmentalInformation**

*SafetyAndEnvironmentalInformation is optional. Multiple instances might exist.*

Name of certification type, if any, on the goods (For example, FSC, PEFC). SafetyAndEnvironmental needs a value or measurement to communicate the percentage of the product is certified (for example, 75% is certified by the indicated agency).

### **DocumentReferenceInformation**

*DocumentReferenceInformation is optional. Multiple instances might exist.*

A group item containing reference information applicable to a document.

### **DeliverySource**

DeliverySource is optional. Multiple instances might exist.

A grouping element with information that identifies and specifies the source of a delivery, e.g. a logging area.

## MonetaryAdjustment

The element containing the information necessary for the understanding, calculation, and treatment of an adjustment to a currency amount. MonetaryAdjustment contains an attribute that indicates they type of adjustment being communicated.

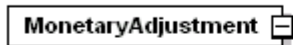

### AdjustmentType [attribute]

*AdjustmentType is mandatory. A single instance is required.*

Describes the type of adjustment applied to a monetary oriented element. Adjustment values should always be given as negative or positive adjustments even if AdjustmentType indicates the sign. For example, a rebate of 1% on an invoice should be given as an adjustment percentage of -1%.

*This item is restricted to the following list.*

#### BillOfLadingCharge

An extra charge for creating a Bill of Lading.

#### CancellationCharge

A charge applied because a cancellation was late (after the last date of change) and all or part of the ordered product has already been made.

#### CashDiscount

A reduction due to a discount applied.

#### CertificateCharge

An extra charge for creating a certificate. Some countries requires Certificates in which different characteristics of the delivery, transport unit, route, product, and others must be proved.

There are certificates for gasen pallets, for the place of production, for the age of the ship/vessel, for not departing from one country's harbour when delivering to another.

#### ChargesForward

A pending invoice amount brought forward from a previous Invoice.

#### ClaimAdjustment

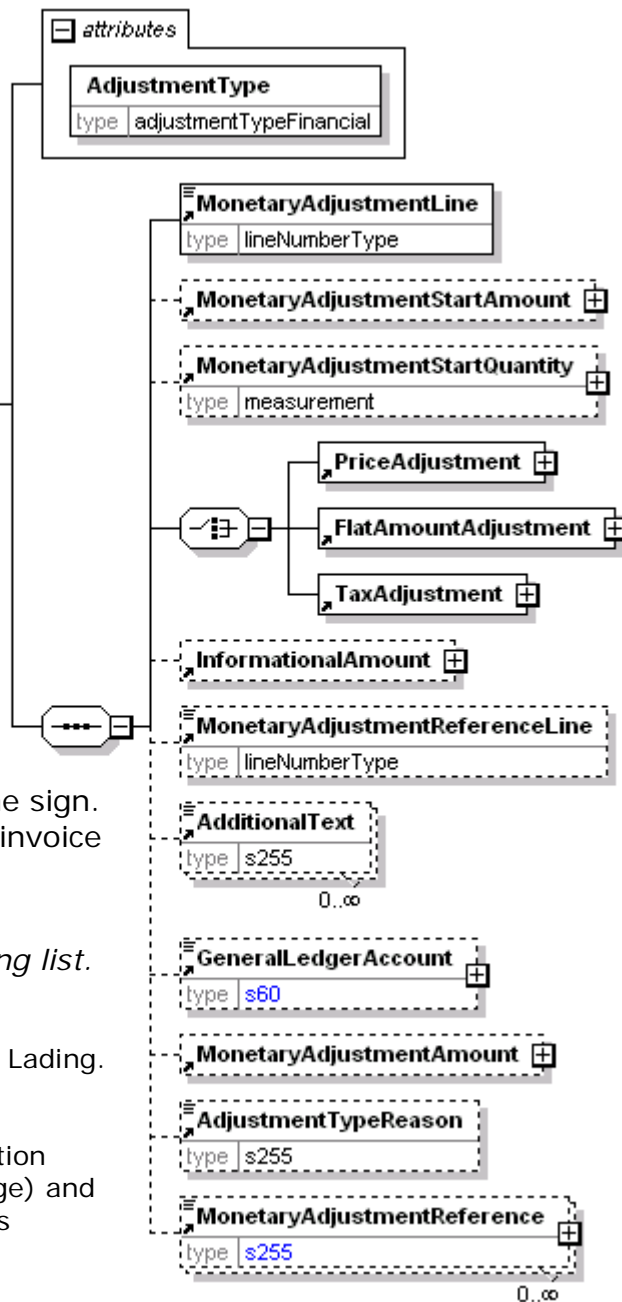

# PurchaseOrder

## papiNet Standard - Version 2.31

---

---

An adjustment related to a filed complaint.

### **Commission**

Commission costs paid to the trading agency or trader.

### **CompetitiveAllowance**

An allowance provided for competitive reasons.

### **CongestionCharge**

An extra fee from ports for waiting time of ships in ports, railcars on a siding, trucks at a dock. (Synonym: Demurrage.)

### **ConsigneeUnloadCharge**

An unloading charge that is the responsibility of the consignee.

### **ContractAllowance**

An allowance for a volume discount, usually because the agreed amount has been exceeded.

### **CurrencyAdjustmentCharge**

An extra fee to adjust for currency variations.

### **DecimalRounding**

Adjustments for rounding of amounts to fit the business agreement or national monetary legislation. This adjustment is typically used for decimal rounding of amounts not including tax.

N.B. Use InformationalAmount with AmountType "DecimalRounding" for specification of decimal rounding of amounts including tax.

### **DefectiveAllowance**

An allowance provided for defective material.

### **DeliveryCharge**

The charge for delivering the product.

### **DeliveryNonConformanceAllowance**

An allowance due to non-conformance with the purchase agreement regarding a delivery.

### **DeliveryTimeBonus**

A bonus given for deliveries of products within a certain time period.

### **EarlyShipAllowance**

An allowance due to a delivery that took place earlier than planned. The seller may be charged a penalty. If this is found before issuing the Invoice, it can be handled through this allowance. If found later, it will be handled through a credit note.

### **EnergySurcharge**

A charge related to increases in the cost of energy.

### **Environmental**

An allowance applied due to environmental regulations.

### **ExpeditedShipmentCharge**

An extra cost charged due to unexpected or emergency requirements (for example, breaking off a run in the mill to reach the production date for a rush order).

# PurchaseOrder

## papiNet Standard - Version 2.31

---

---

### **ExportClearanceCharge**

An extra fee for customs administration.

### **FlatRateCharge**

A general flat charge.

### **FreightAllowance**

The freight cost allowed by the mill. This amount is negative, and will be deducted from the Invoice (U.S. business practice, in the European Union (EU), use only Freight Charge).

### **FreightCharge**

The actual cost incurred to deliver the product. This amount is positive, and will be added to the Invoice.

### **FuelAdjustmentCharge**

An extra fee, usually from shipping companies, to adjust fuel prices.

### **HandlingCharge**

A charge related to the handling of the product.

### **Inspection**

The cost associated with performing an inspection of the product.

### **InterestCharge**

A charge applied for interest on overdue payments.

### **LabourAllowance**

An allowance due to additional labour required in the use or acceptance of the product.

### **LabourCharge**

A charge due to additional labour required in the use or acceptance of the product.

### **LoggingDamage**

An adjustment caused by logging damages on Forest Wood products. Logging damages normally cause a reduction of the product price.

### **LotCharge**

A charge applied to the lot of material.

### **MetalDetection**

A charge for additional metal detection applied to the goods.

### **ModelHomeDiscount**

A discount associated with the building of the model home.

### **NewStoreCouponDiscount**

A discount associated with entry into a new store.

### **OrderQuantity**

A charge or allowance for small/big ordered quantities.

### **PalletCharge**

A charge that represents the cost or rental of the pallet.

### **PickUpAllowance**



# PurchaseOrder

## papiNet Standard - Version 2.31

---

---

An allowance provided to compensate for the cost of picking up the product.

### **PromotionalAllowance**

An allowance provided for the promotion of the product.

### **PromotionalCharge**

A charge associated with the promotion of the product.

### **PriceCorrection**

An adjustment associated with a correction of the product's price.

### **ProductionSetUpCharge**

A special charge applied due to specific buyer requests.

### **Provision**

The act of making ready or equipping for use.

### **Rebate**

A rebate accepted by the buyer and seller based on the agreed price and volume.

### **ReelDiscount**

An allowance for purchasing reels instead of sheets.

### **ReturnedLoadAllowance**

An allowance applied due to the return of the load.

### **ReturnLoadCharge**

A charge applied due to the return of the load.

### **RoadFeeCharge**

A freight charge for a special tax applied to road transports in some countries, e.g. Germany

### **ScrapAndDunnageCharge**

A charge that represents the scrapping of the material and its removal.

### **ServiceCharge**

A charge associated with a miscellaneous service.

### **SpecialConversionCharge**

Additional charge for a special conversion of the product.

### **SpecialDeliveryCharge**

A special charge for delivering the product differently from the usual or agreed-to method.

### **SpecialHandlingCharge**

A special charge for handling the product differently from the usual or agreed-to method.

### **SpecialPackagingCharge**

A special charge for packaging the product differently from the usual or agreed-to method, or if packaging as requested is out of spec.

### **StopOffAllowance**

An allowance for a delivery stop-off.

### **StopOffCharge**

# PurchaseOrder

## papiNet Standard - Version 2.31

---

---

A charge for a delivery stop-off.

### **StorageAllowance**

An allowance for storing the product.

### **StorageCharge**

An extra cost charged for storing the product on location (in the plant).

### **Tax**

An adjustment that reflects a tax item.

### **TestingCharge**

A charge related to testing a paper grade.

### **TradeDiscount**

A discount based on the terms of the trade given on the agreed price. Usually a percentage.

### **TrialDiscount**

A discount applied for a trial run of a new or improved product.

### **TransferCharge**

A freight charge incurred by the goods transfer from one location to another location not previously agreed upon.

### **UnloadingAllowance**

An allowance to compensate for the unloading the product.

### **UnloadingCharge**

A charge for the unloading the product.

### **VolumeDiscount**

A rebate accepted by the buyer and the seller based on the agreed volume

### **WarRiskCharge**

An extra fee from transport companies for transport units that cross war zones.

### **Other**

Any other adjustment not covered by the attribute list.

### **(sequence)**

*The sequence of items below is mandatory. A single instance is required.*

### **MonetaryAdjustmentLine**

*MonetaryAdjustmentLine is mandatory. A single instance is required.*

A sequence number indicating the order of printing or the sequence in which a group of adjustments are to be considered.

### **MonetaryAdjustmentStartAmount**

*MonetaryAdjustmentStartAmount is optional. A single instance might exist.*

The beginning currency amount used in the calculation of a monetary adjustment.

### **MonetaryAdjustmentStartQuantity**

*MonetaryAdjustmentStartQuantity is optional. A single instance might exist.*

The beginning quantity used in the calculation of a monetary adjustment.

# PurchaseOrder

## papiNet Standard - Version 2.31

---

### (choice)

*[choice] is optional because of choice construct.*

#### **PriceAdjustment**

*PriceAdjustment is optional because of choice construct.*

A group item defining a deviation from the PricePerUnit.

#### **FlatAmountAdjustment**

*FlatAmountAdjustment is optional because of choice construct.*

A group item that contains flat adjustment amount information.

#### **TaxAdjustment**

*TaxAdjustment is optional because of choice construct.*

This content element contains the necessary information to describe, calculate, and handle a tax adjustment.

#### **InformationalAmount**

*InformationalAmount is optional. A single instance might exist.*

A monetary amount used for information purposes only (not for calculation). For example, the invoice price adjustment subtotal is expressed in sterling pounds, and the buyer wants this information expressed in U.S. dollars.

- CreditDebitNote and Invoice - The TaxAmount is displayed in the currency that is applicable throughout the e-Document. When a TaxAmount needs to be displayed in a different national currency, this field is used.

#### **MonetaryAdjustmentReferenceLine**

*MonetaryAdjustmentReferenceLine is optional. A single instance might exist.*

A link to a previously defined MonetaryAdjustmentLine upon which this adjustment is based.

#### **AdditionalText**

*AdditionalText is optional. Multiple instances might exist.*

A text field that is used to communicate information not previously defined or for special instructions. To be used only for circumstances not covered by specific elements.

#### **GeneralLedgerAccount**

*GeneralLedgerAccount is optional. A single instance might exist.*

The general ledger account to be referenced for the item.

#### **MonetaryAdjustmentAmount**

*MonetaryAdjustmentAmount is optional. A single instance might exist.*

The actual amount of the monetary adjustment.

#### **AdjustmentTypeReason**

*AdjustmentTypeReason is optional. A single instance might exist.*

Provides additional information about the type of adjustment. Can be viewed as a sub-classification of the adjustment type attribute or as a textual explanation.

#### **MonetaryAdjustmentReference**

*MonetaryAdjustmentReference is optional. Multiple instances might exist.*

An element detailing relevant references pertaining to the MonetaryAdjustment as

# PurchaseOrder

## papiNet Standard - Version 2.31

indicated by MonetaryAdjustmentReferenceType and AssignedBy.

### PurchaseOrderSummary

A group item containing summary information applicable to the entire purchase order.

#### (sequence)

The contents of (sequence) are

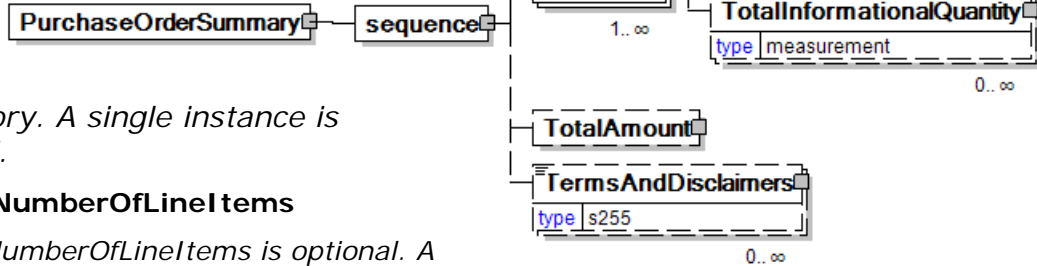

mandatory. A single instance is required.

#### TotalNumberOfLineItems

TotalNumberOfLineItems is optional. A single instance might exist.

The total number of individual line items in the document, regardless of the status or type.

#### (sequence)

The contents of (sequence) are mandatory. One instance is required, multiple instances might exist.

#### TotalQuantity

TotalQuantity is mandatory. A single instance is required.

The total quantity of similar items in the business document. TotalQuantity is primarily used in the summary section of documents where it is repeatable to permit totaling for different units of measure.

#### TotalInformationalQuantity

TotalInformationalQuantity is optional. Multiple instances might exist.

A quantity that is used to communicate related information about the parent element. This element represents a total that is derived from individual line items.

#### TotalAmount

TotalAmount is optional. A single instance might exist.

The total amount including tax (when tax is specified in the e-Document).

In e-Documents claiming payment this is the amount due for payment based on the terms of payment. Decimal rounding might be applied to this amount.

#### TermsAndDisclaimers

TermsAndDisclaimers is optional. Multiple instances might exist.

An element that contains legal information with an indication of what the Language is.

# PurchaseOrder papiNet Standard - Version 2.31

## PurchaseOrder Business Scenarios

### PurchaseOrder Scenario Listing

<b>Scenario A</b>	Buyer makes a request to order and issues an original single-line PurchaseOrder that is New to the Supplier.
<b>Scenario B</b>	Buyer withdraws order request and therefore Cancelled a single-line PurchaseOrder.
<b>Scenario C</b>	Buyer would like to make changes to an order and makes an amendment to an existing PurchaseOrder and only Amended header information on the PurchaseOrder.
<b>Scenario D</b>	Buyer would like to make changes to an order and makes an amendment to an existing PurchaseOrder and only Amended line item information on the PurchaseOrder.
<b>Scenario E</b>	Buyer would like to make changes to an order and makes an amendment to an existing PurchaseOrder. The Buyer would like to add a New line item.
<b>Scenario F</b>	Buyer would like to make multiple changes to an order and makes an amendment to an existing PurchaseOrder. The Buyer Amended line item one, Cancelled line item two, did NoAction to line item three, and added a New line item four.
<b>Scenario G</b>	Buyer places a ReservationOrder to gain a commitment to manufacture a product at a later date.
<b>Scenario H</b>	Buyer places a ReleaseOrder to authorize the manufacture of the product above, referenced in a Reservation Order.

### Scenario A

<b>e-Document</b>	PurchaseOrder
<b>Type</b>	StandardOrder
<b>Scenario</b>	Buyer issues a single-line PurchaseOrder that is accepted by the Supplier.
<b>Outcome</b>	An original PurchaseOrder is entered into the

## PurchaseOrder papiNet Standard - Version 2.31

	Buyer's system and received into the Supplier's system.
<b>Initiator</b>	Buyer
<b>Receiver</b>	Supplier
<b>Trigger</b>	None
<b>Step 1.</b>	<p>Buyer enters an original PurchaseOrder into their system then sends it to the Supplier. At a minimum, all required elements and corresponding attributes are entered.</p> <p>Statuses sent within the e-Document:</p> <ul style="list-style-type: none"> <li>• PurchaseOrderStatusType = "Original"</li> <li>• PurchaseOrderHeaderStatusType = "New"</li> <li>• PurchaseOrderLineItemStatusType = "New"</li> </ul>

### Scenario B

<b>e-Document</b>	PurchaseOrder
<b>Type</b>	Standard Order
<b>Scenario</b>	Buyer cancels an existing single-line PurchaseOrder.
<b>Outcome</b>	PurchaseOrder is cancelled in the Buyer's and Supplier's system.
<b>Initiator</b>	Buyer
<b>Receiver</b>	Supplier
<b>Preconditions</b>	An Original PurchaseOrder must have been sent by Buyer to Supplier.
<b>Trigger</b>	None
<b>Step 1.</b>	<p>Buyer resends the complete PurchaseOrder to the Supplier with all statuses as cancelled.</p> <p>Statuses sent within the e-Document:</p> <ul style="list-style-type: none"> <li>• PurchaseOrderStatusType = "Cancelled"</li> <li>• PurchaseOrderHeaderStatusType = "Cancelled"</li> <li>• PurchaseOrderLineItemStatusType = "Cancelled"</li> </ul>

### Scenario C

<b>e-Document</b>	PurchaseOrder
-------------------	---------------

**PurchaseOrder  
papiNet Standard - Version 2.31**

<b>Type</b>	StandardOrder
<b>Scenario</b>	Buyer issues an Amendment to a PurchaseOrder that contains a change to Header information only.
<b>Outcome</b>	The PurchaseOrder is changed in the Buyer's and Supplier's system.
<b>Initiator</b>	Buyer
<b>Receiver</b>	Supplier
<b>Preconditions</b>	An Original PurchaseOrder must have been sent by Buyer to Supplier.
<b>Trigger</b>	None
<b>Step 1.</b>	<p>Buyer enters all of the original PurchaseOrder information into their system along with the amended header information then sends it to the Supplier.</p> <p>Statuses sent within the e-Document:</p> <ul style="list-style-type: none"> <li>• PurchaseOrderStatusType = "Amendment"</li> <li>• PurchaseOrderHeaderStatusType = "Amended"</li> <li>• PurchaseOrderLineItemStatusType = "NoAction"</li> </ul>

**Scenario D**

<b>e-Document</b>	PurchaseOrder
<b>Type</b>	StandardOrder
<b>Scenario</b>	Buyer issues an Amendment to an existing PurchaseOrder that contains a change to line item information only.
<b>Outcome</b>	The PurchaseOrder is changed in the Buyer's and Supplier's system.
<b>Initiator</b>	Buyer
<b>Receiver</b>	Supplier
<b>Preconditions</b>	An Original PurchaseOrder must have been sent by Buyer to Supplier.
<b>Trigger</b>	None
<b>Step 1.</b>	Buyer enters existing PurchaseOrder information

## PurchaseOrder papiNet Standard - Version 2.31

	<p>into their system along with the changed information at the line item and then sends it to the Supplier.</p> <p>Statuses sent within the e-Document:</p> <ul style="list-style-type: none"> <li>• PurchaseOrderStatusType = "Amendment"</li> <li>• PurchaseOrderHeaderStatusType = "NoAction"</li> <li>• PurchaseOrderLineItemStatusType = "Amended"</li> </ul>
--	--

### Scenario F

<b>e-Document</b>	PurchaseOrder
<b>Type</b>	StandardOrder
<b>Scenario</b>	Buyer issues an Amendment to an existing PurchaseOrder. The Buyer Amended line item one, Cancelled line item two, did NoAction to line item three, and added a new line item.
<b>Outcome</b>	The PurchaseOrder is changed in the Buyer's and Supplier's system that includes a change on line item one, a cancelled line item two, and a new line item, four, on the order.
<b>Initiator</b>	Buyer
<b>Receiver</b>	Supplier
<b>Preconditions</b>	An Original PurchaseOrder must have been sent by Buyer to Supplier. Line items one, two, and three had to have been previously sent from the buyer to the Supplier.
<b>Trigger</b>	None
<b>Step 1.</b>	<p>Buyer enters existing PurchaseOrder information into their system along new information at the line item and then sends it to the Supplier.</p> <p>Statuses sent within the e-Document:</p> <ul style="list-style-type: none"> <li>• PurchaseOrderStatusType = "Amendment"</li> <li>• PurchaseOrderHeaderStatusType = "NoAction"</li> <li>• PurchaseOrderLineItemStatusType item1 = "Amended"</li> <li>• PurchaseOrderLineItemStatusType item2 = "Cancelled"</li> <li>• PurchaseOrderLineItemStatusType item3 =</li> </ul>



## PurchaseOrder papiNet Standard - Version 2.31

	<p>"NoAction"</p> <ul style="list-style-type: none"> <li>PurchaseOrderLineItemType item4 = "New"</li> </ul>
--	---

### Scenario G

<b>e-Document</b>	PurchaseOrder
<b>Type</b>	ReservationOrder
<b>Scenario</b>	Buyer issues a multiple-line Reservation PurchaseOrder that is accepted by the Supplier.
<b>Outcome</b>	An original Reservation Order is entered into the Buyer's system and received by the Supplier and may be entered into the Supplier's system.
<b>Initiator</b>	Buyer
<b>Receiver</b>	Supplier
<b>Trigger</b>	None
<b>Step 1.</b>	<p>Buyer enters an original Reservation PurchaseOrder into their system then sends it to the Supplier. At a minimum, all required elements and corresponding attributes are entered.</p> <p>Statuses sent within the e-Document:</p> <ul style="list-style-type: none"> <li>PurchaseOrderStatusType = "Original"</li> <li>PurchaseOrderHeaderStatusType = "New"</li> <li>PurchaseOrderLineItemType = "New"</li> <li>Note that the Reservation Order may or may not have a PurchaseOrder Number. If not required between trading partners, the value "Planning Order" may be entered in the PurchaseOrder Number field.</li> </ul>

### Scenario H

<b>e-Document</b>	PurchaseOrder
<b>Type</b>	ReleaseOrder
<b>Scenario</b>	Buyer issues a multiple-line Release PurchaseOrder that is accepted by the Supplier.
<b>Outcome</b>	An original Release PurchaseOrder is entered into the Buyer's system and received into the Supplier's system. It is matched against the corresponding

**PurchaseOrder**  
**papiNet Standard - Version 2.31**

	ReservationOrder in the supplier system
<b>Initiator</b>	Buyer
<b>Receiver</b>	Supplier
<b>Trigger</b>	None
<b>Step 1.</b>	<p>Buyer enters an original PurchaseOrder into their system then sends it to the Supplier. At a minimum, all required elements and corresponding attributes are entered.</p> <p>Statuses sent within the e-Document:</p> <ul style="list-style-type: none"><li>• PurchaseOrderStatusType = "Original"</li><li>• PurchaseOrderHeaderStatusType = "New"</li><li>• PurchaseOrderLineItemStatusType = "New"</li></ul>