



papiNet

BusinessAcceptance

papiNet Standard - Version 2.31

Documentation

**Global Standard for the Paper and Forest
Products Supply Chain**

Build V2R31_20210324

Date 2021-04-26

Production Release

BusinessAcceptance

papiNet Standard - Version 2.31

Copyright

Copyright 2000 - 2021 papiNet G.I.E ("papiNet") and International Digital Enterprise Alliance, Inc. ("IDEAlliance") collectively "Copyright Owner". All rights reserved by the Copyright Owner under the laws of the United States, Belgium, the European Economic Community, and all states, domestic and foreign. This document may be downloaded and copied provided that all copies retain and display the copyright and any other proprietary notices contained in this document. This document may not be sold, modified, edited, or taken out of context such that it creates a false or misleading statement or impression as to the purpose or use of the papiNet specification, which is an open standard. Use of this Standard, in accord with the foregoing limited permission, shall not create for the user any rights in or to the copyright, which rights are exclusively reserved to the Copyright Owner.

papiNet, IDEAlliance, and the members of all papiNet Groups (collectively and individually, "Presenters") make no representations or warranties, express or implied, including, but not limited to, warranties of merchantability, fitness for a particular purpose, title, or non-infringement. The presenters do not make any representation or warranty that the contents of this document are free from error, suitable for any purpose of any user, or that implementation of such contents will not infringe any third party patents, copyrights, trademarks or other rights. By making use of this document, the user assumes all risks and waives all claims against Presenters.

In no event shall Presenters be liable to user (or other person) for direct, indirect, special or consequential damages arising from or related to any use of this document, including, without limitation, lost profits, business interruption, loss of programs, or other data on your information handling system even if Presenters are expressly advised of the possibility of such damages.

Use of Documents in papiNet Implementations

Documents may be used as templates for a papiNet implementation. The Presenters grant the right to modify and edit them to fit an actual implementation project provided all copies display the copyright and any other proprietary notices contained in this document. Such modified documents must not be distributed beyond the trading partners implementing or maintaining a papiNet connection.

BusinessAcceptance papiNet Standard - Version 2.31

Table of Contents

| | |
|---|----|
| Copyright | 2 |
| Use of Documents in papiNet Implementations | 2 |
| Table of Contents | 3 |
| BusinessAcceptance Documentation..... | 4 |
| BusinessAcceptance e-Document Overview | 4 |
| BusinessAcceptance Scope..... | 4 |
| BusinessAcceptanceStatus [attribute]..... | 4 |
| BusinessAcceptance Business Rules | 5 |
| Processing the BusinessAcceptance | 5 |
| Understanding the Diagrams and Content | 5 |
| BusinessAcceptance Root Element | 8 |
| BusinessAcceptance | 8 |
| Primary Elements | 10 |
| BusinessAcceptanceNumber | 10 |
| BusinessAcceptanceDate..... | 10 |
| SenderParty | 11 |
| ReceiverParty | 12 |
| Document | 13 |
| DocumentRejectionReason | 26 |
| BusinessAcceptanceParty..... | 27 |
| AdditionalText | 27 |
| Supporting Items | 28 |
| PartyType [attribute]..... | 28 |
| BusinessAcceptance Business Scenarios | 36 |
| BusinessAcceptance Scenario Listing | 36 |
| Scenario A | 36 |
| Scenario B | 36 |

BusinessAcceptance papiNet Standard - Version 2.31

BusinessAcceptance Documentation

BusinessAcceptance e-Document Overview

The receiver of a document uses the BusinessAcceptance to confirm to the sender that the document is accepted or rejected after processing the document in the receiver's ERP system. Some business cases might require manual actions before the BusinessAcceptance can be issued. The BusinessAcceptance can be used as a confirmation of acceptance when there is not a papiNet confirmation e-Document available. Although the BusinessAcceptance is optional between two trading partners, its use is strongly recommended when it is important to get a business acceptance, e.g. if a received Delivery Instruction will be executed or not.

When the BusinessAcceptance is used, the sender of the original document should have in place a resolution process. This process should monitor confirmations received with the BusinessAcceptance; routing them to the correct organisation for resolution. The resolution process is typically based on a manual process when the referenced document is rejected. The monitoring process should also check for unconfirmed documents.

BusinessAcceptance Scope

The BusinessAcceptance includes:

- BusinessAcceptanceNumber
- BusinessAcceptanceDate
- Information on the confirmed document including DocumentName, DocumentNumber, DocumentDate and OtherDocumentName when the confirmed document is not a papiNet e-Document.
- The BusinessAcceptanceStatus with value Accepted or Rejected for the confirmed document.
- The DocumentRejectionReason specifying the rejection reason when the document is rejected
- BusinessAcceptanceParty including contact information.
- AdditionalText if any comments.

BusinessAcceptanceStatus [attribute]

Defines if the document content has been accepted or rejected after processing in the receiver's ERP system.

This item is restricted to the following list.

Accepted

Indicates that the document content has been accepted after processing in the receiver's ERP system.

Rejected

Indicates that the document content has been rejected after processing in the receiver's ERP system.

BusinessAcceptance papiNet Standard - Version 2.31

BusinessAcceptance Business Rules

General BusinessAcceptance Business Rules

| Identifier | Business Rule |
|------------|---|
| BACPT_001 | A BusinessAcceptance confirms the acceptance or the rejection of the document content. |
| BACPT_002 | DocumentName or OtherDocumentName andDocumentNumber define a unique document for the receiver of the BusinessAcceptance. |
| BACPT_003 | TransactionHistoryNumber defines the version of the document that is confirmed. DocumentDate defines the version of the document, if TransactionHistoryNumber is not used. |
| BACPT_004 | [obsolete] |
| BACPT_005 | A version of a document must only be confirmed once with a BusinessAcceptance. If a BusinessAcceptance would be received more than one time confirming the same version of the document, then any later received BusinessAcceptance shall be ignored. |

Processing the BusinessAcceptance

A version of a document must only be confirmed once by a BusinessAcceptance. If a BusinessAcceptance would be received more than one time confirming the same version of the document, then any later received BusinessAcceptance shall be rejected.

The processing of the BusinessAcceptance depends on the value of the BusinessAcceptanceStatus attribute, Accepted or Rejected.

A value Accepted marks the confirmed document as successfully processed in the receiver's ERP system and the document receiver takes responsibility for further handling of the document.

A value Rejected should trigger a resolution process, where the sender of the confirmed document is responsible for resolving the issues with the document content. The resolution process is typically based on manual actions when the document is rejected.

N.B. The sender should monitor unconfirmed documents and have a resolution process in place to resolve issues with missing confirmations.

Understanding the Diagrams and Content

This section provides a graphical view of the schema structures, a

BusinessAcceptance

papiNet Standard - Version 2.31

discussion of the item's children. You can find additional information about papiNet and the standard at www.papiNet.org.

The graphics contain content model indicators, cardinality indicators, and data type information.

Associated with each graphic are the definitions for the parent item and any associated child items. All attributes are listed first, followed by the elements.

The following information should help you interpret and understand this standard. Please note the following:

- Content Model and Cardinality operate together to determine if the element or attribute are required in the instance document.
- The same attribute can never appear multiple times in the same element so, you will never see a multiple cardinality indicator.

Content model indicators:

There are three possible types of content: "sequence", "choice", and "all". The papiNet standard currently does not use the "all" construct.

- (sequence)

The sequence of the items to the right of the graphic (or below the text) is required.

- (choice)

A choice of the items to the right of the graphic (or below the text) is permitted.

- (all)

All the items to the right of the graphic are required.

Cardinality indicators:

- Dotted line around element or attribute.

A single instance of the item can optionally exist.

- Dotted line around item with range indicated below.

Multiple instances of the item can optionally exist.

- Solid line around item.

A single instance of the item must exist.

- Solid line around item with range indicated below

At least one instance must exist; multiple instances can optionally exist.

Datatype indication:

When a data type is assigned to an element (either a simple type or complex type) the name of the data type is presented beneath the item name in the graphic.

- In some cases additional information about the data type is presented (the default value).

Elements can either have content that is textual/numeric in nature or content that is made up of additional elements and/or attributes.

- When the content is textual/numeric in nature "three straight horizontal lines" will appear in the upper left-hand corner of the graphic. Pay attention to these elements because they are where you will be entering your information.
- When the content is made up of additional elements and/or attributes a

BusinessAcceptance papiNet Standard - Version 2.31

"gray-box" will appear on the right-hand side of the graphic.

- If the graphic shows both the horizontal lines and the gray-box then, in the papiNet standard, the content below the element are attributes.

BusinessAcceptance

papiNet Standard - Version 2.31

BusinessAcceptance Root Element

BusinessAcceptance

The BusinessAcceptance element is the root element for the BusinessAcceptance e-Document.

The receiver of a document uses the BusinessAcceptance to confirm to the sender that the document is accepted or rejected after processing the document in the receiver's ERP system. Some business cases might require manual actions before the BusinessAcceptance can be issued.

The BusinessAcceptance can be used as a confirmation of acceptance when there is not a papiNet confirmation e-Document available. Although the BusinessAcceptance is optional between two trading partners, its use is strongly recommended when it is important to get a business acceptance, e.g. if a received DeliveryInstruction will be executed or not.

BusinessAcceptanceStatus [attribute]

BusinessAcceptanceStatus is mandatory. A single instance is required.

Defines if the document content has been accepted or rejected after processing in the receiver's ERP system.

This item is restricted to the following list.

Accepted

Indicates that the document content has been accepted after processing in the receiver's ERP system.

Rejected

Indicates that the document content has been rejected after processing in the receiver's ERP system.

Language [attribute]

Language is optional. A single instance might exist.

The valid Alpha 2- and Alpha 3-character list of language codes in the ISO 639-1 and 639-2 international standards.

Information on the content of this attribute is available at:

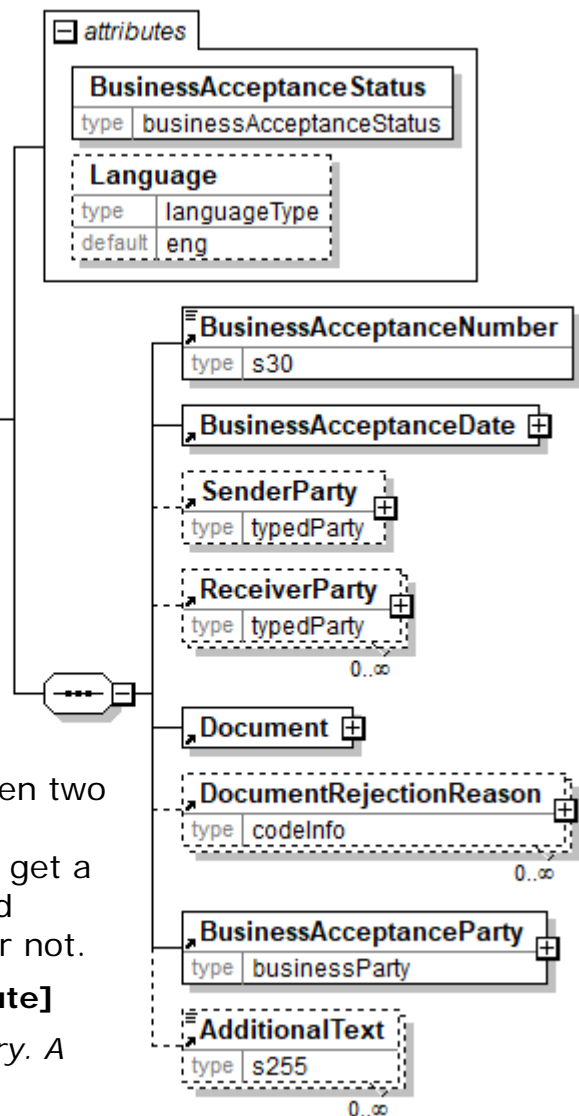

BusinessAcceptance

papiNet Standard - Version 2.31

https://www.loc.gov/standards/iso639-2/php/code_list.php

(sequence)

The contents of (sequence) are mandatory. A single instance is required.

BusinessAcceptanceNumber

BusinessAcceptanceNumber is mandatory. A single instance is required.

The unique identifier for the BusinessAcceptance.

BusinessAcceptanceDate

BusinessAcceptanceDate is mandatory. A single instance is required.

The Date and Time when the BusinessAcceptance was issued.

SenderParty

SenderParty is mandatory. A single instance is required.

The business entity issuing the business document, the source of the document.

- This is the same entity as the "From" party in the ebXML message service envelope. The entity responsible for the content. If the sender party has outsourced the transmission function to a third party the sender party is the original party not the party performing the transmission service.

ReceiverParty

ReceiverParty is mandatory. A single instance is required.

The business entity for whom the business document is intended, the destination of the document.

- This is the same entity as the "To" party in the ebXML message service envelop. The entity interested in the content. If the receiver party has outsourced the e-Document receipt function to a third party the receiver party is the intended party not the party performing the receiving process.

Document

Document is mandatory. A single instance is required.

A group item containing information applicable to the original document.

DocumentRejectionReason

DocumentRejectionReason is optional. Multiple instances might exist.

A grouping element that contains information about the rejection reason for the document that is rejected.

BusinessAcceptanceParty

BusinessAcceptanceParty is mandatory. A single instance is required.

The organisation or legal entity authorised to accept or reject business document.

AdditionalText

AdditionalText is optional. Multiple instances might exist.

A text field that is used to communicate information not previously defined or for special instructions. To be used only for circumstances not covered by specific elements.

BusinessAcceptance

papiNet Standard - Version 2.31

Primary Elements

BusinessAcceptanceNumber

The unique identifier for the BusinessAcceptance.

| |
|---------------------------------|
| BusinessAcceptanceNumber |
| type s30 |

BusinessAcceptanceDate

The Date and Time when the BusinessAcceptance was issued.

(sequence)

The sequence of items

below is mandatory. A single instance is required.

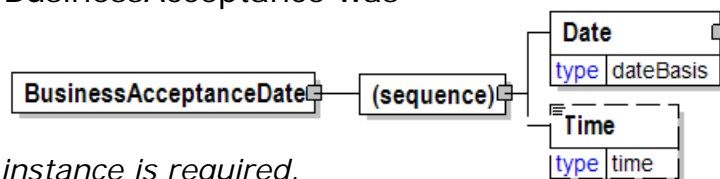

Date

Date is mandatory. A single instance is required.

A group element that contains the specification of Year, Month, and Day.

Time

Time is optional. A single instance might exist.

Times are treated in a standard XML fashion with a special case used to indicate a generalized "local" time. The standard XML approach to time is hh:mm:ss, hh:mm:ssZ, or hh:mm:ss±hh:mm.

- hh:mm:ss±hh:mm is used to represent a time with a time zone. The time zone is communicated as the number of hours offset from the Universal Time Coordinate (UTC), a.k.a. Greenwich Mean Time.
- hh:mm:ssZ indicates the time at Zulu (another name for UTC).
- hh:mm:ss or hh:mm indicates within papiNet the applicable local time where the associated event is taking place. Caution should be used when processing times of this nature as the papiNet approach may be in discord with other users of XML.

BusinessAcceptance papiNet Standard - Version 2.31

SenderParty

The business entity issuing the business document, the source of the document.

- This is the same entity as the "From" party in the ebXML message service envelope. The entity responsible for the content. If the sender party has outsourced the transmission function to a third party the sender party is the original party not the party performing the transmission service.

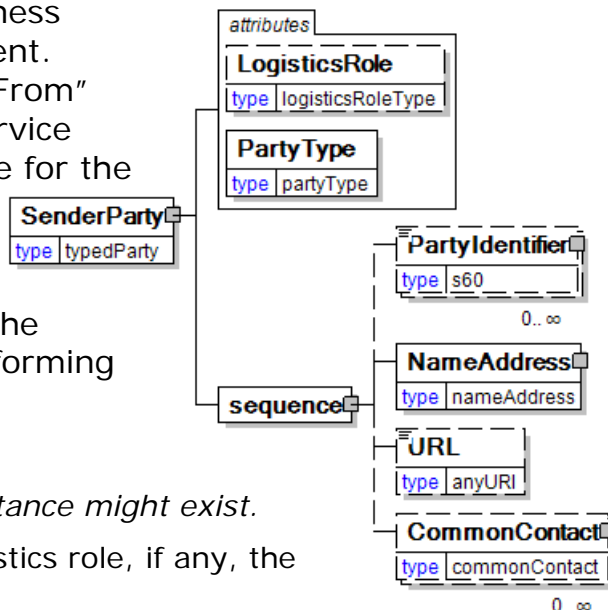

LogisticsRole [attribute]

LogisticsRole is optional. A single instance might exist.

Communicates the nature of the logistics role, if any, the party plays in the transaction.

This item is restricted to the following list.

Consignee

The party to whom the goods are turned over to.

Consignor

The party who is responsible for the goods prior to the shipping process.

LogisticsProvider

The party who, by contract with the consignor, takes care of the requested logistics service (transport or others).

PartyType [attribute]

PartyType is mandatory. A single instance is required.

Identifies the business role associated with the particular party.

Refer to PartyType definition for any enumerations.

(sequence)

The contents of (sequence) are mandatory. A single instance is required.

PartyIdentifier

PartyIdentifier is optional. Multiple instances might exist.

A unique identifier of a specific party. This element contains an attribute PartyIdentifierType that indicates the type of party.

NameAddress

NameAddress is mandatory. A single instance is required.

A group item containing name and address of an organisation or business entity.

URL

URL is optional. A single instance might exist.

Universal Resource Locator. While typically a web address you could use this field to hold an email address.

BusinessAcceptance

papiNet Standard - Version 2.31

CommonContact

CommonContact is optional. Multiple instances might exist.

Identifies a specific individual associated with the party.

ReceiverParty

The business entity for whom the business document is intended, the destination of the document.

- This is the same entity as the "To" party in the ebXML message service envelope. The entity interested in the content. If the receiver party has outsourced the message receipt function to a third party the receiver party is the intended party not the party performing the receiving process.

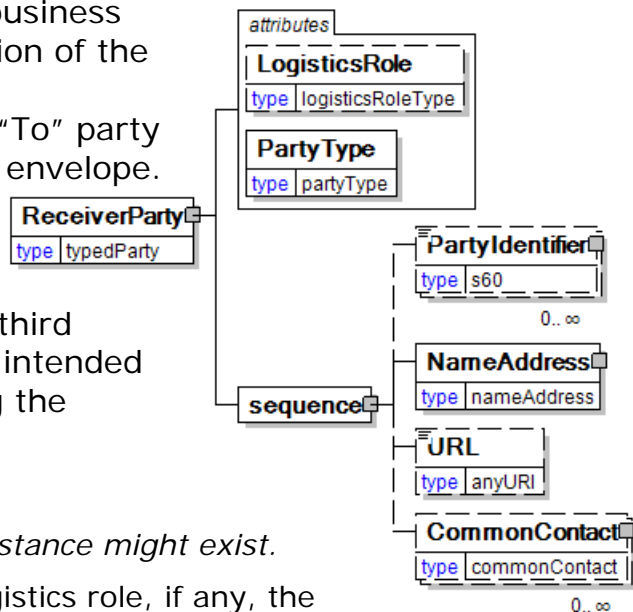

LogisticsRole [attribute]

LogisticsRole is optional. A single instance might exist.

Communicates the nature of the logistics role, if any, the party plays in the transaction.

This item is restricted to the following list.

Consignee

The party to whom the goods are turned over to.

Consignor

The party who is responsible for the goods prior to the shipping process.

LogisticsProvider

The party who, by contract with the consignor, takes care of the requested logistics service (transport or others).

PartyType [attribute]

PartyType is mandatory. A single instance is required.

Identifies the business role associated with the particular party.

Refer to PartyType definition for any enumerations.

(sequence)

The contents of (sequence) are mandatory. A single instance is required.

PartyIdentifier

PartyIdentifier is optional. Multiple instances might exist.

A unique identifier of a specific party. This element contains an attribute PartyIdentifierType that indicates the type of party.

NameAddress

BusinessAcceptance

papiNet Standard - Version 2.31

NameAddress is mandatory. A single instance is required.

A group item containing name and address of an organisation or business entity.

URL

URL is optional. A single instance might exist.

Universal Resource Locator. While typically a web address you could use this field to hold an email address.

CommonContact

CommonContact is optional. Multiple instances might exist.

Identifies a specific individual associated with the party.

Document

A group item containing information applicable to the original document.

DocumentName [attribute]

DocumentName is mandatory. A single instance is required.

Defines the name of e-Documents defined by papiNet.

This item is restricted to the following list.

Availability

The purpose of the Availability e-Document is to provide a means to ask about the availability of the specified product. The amount of the product immediately available (on-hand) is anticipated to be returned. Optionally, the anticipated availability of the product at a point in future can be communicated.

BookSpecification

The BookSpecification e-Document represents established product specifications that can be referenced by multiple transactions in the manufacturing life cycle of a product from RFQ through Invoice and subsequent reprints and/or reorders. It captures unique book manufacturing industry data elements as established by the buyer that are needed by the supplier for manufacturing.

BusinessAcceptance

The receiver of a document uses the BusinessAcceptance to confirm to the sender that the document is accepted or rejected. The BusinessAcceptance can be used as a confirmation of acceptance when there is not a papiNet-designed confirmation e-Document available. Although the BusinessAcceptance is optional between two trading partners, its use is strongly recommended when it is important to get a BusinessAcceptance.

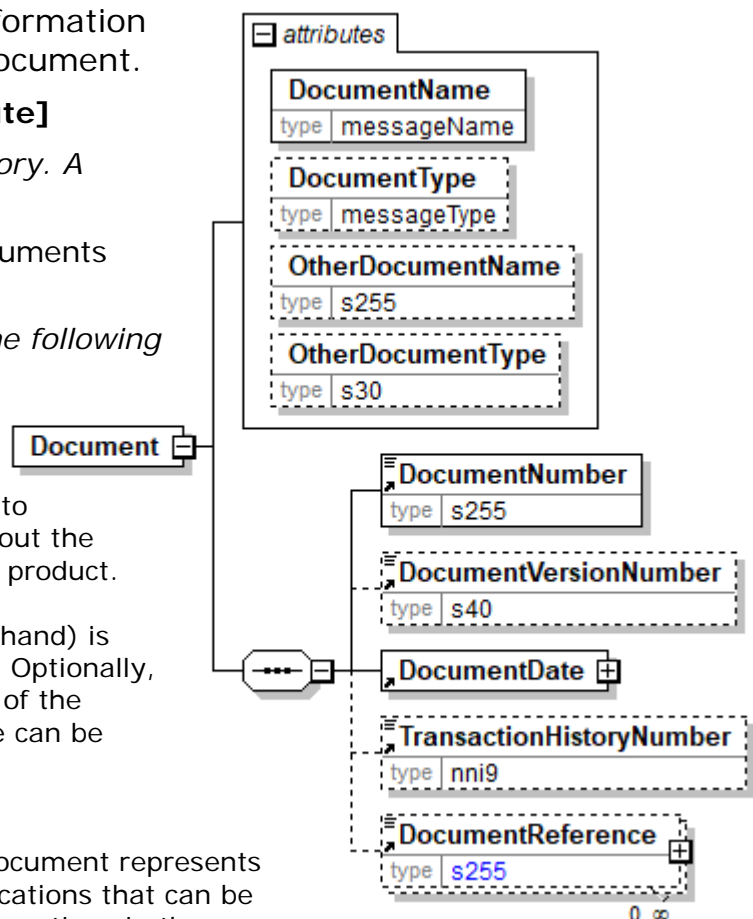

BusinessAcceptance

papiNet Standard - Version 2.31

BusinessAcknowledgement

An e-Document receiver uses the BusinessAcknowledgement to notify the sender that a document has been successfully presented to the receiver's ERP system. The BusinessAcknowledgement can be used to acknowledge any papiNet e-Document. Although the BusinessAcknowledgement is optional between two trading partners, its use is strongly recommended since it provides positive verification of the beginning of the transaction by the receiver.

Calendar

The Calendar e-Document is intended to communicate opening times or other details for a location or locations

CallOff

A CallOff is a delivery schedule for product(s). Products to be delivered can be specified by product specifications or by purchase orders. Any party as agreed in a Trading Partner Agreement can send a CallOff. Each line item in a CallOff refers either to a product included in a PurchaseOrder or to the product specifications contained in the line item. The CallOff specifies delivery schedule(s) and quantities for product(s) to be delivered. The schedule may define a specific date and/or time for delivery or include a time range. All products covered by a CallOff must be delivered to a single location.

CallOffWood

A CallOffWood is a business transaction instructing the consignor (normally the seller) to despatch goods belonging to one or several orders. A CallOffWood contains information about how the goods are to be loaded, quantities, marking instructions etc. It may also contain information about where borders are to be crossed and information concerning transport, such as name of ship and shipping agent. In cases where the CallOffWood is not used, delivery information is included in the order.

Complaint

Typically, a Complaint e-Document is sent from the customer or end user to the supplier to communicate information regarding products or services. A response from the supplier is desired and corrective actions, if required. This e-Document must specify the necessary details to enable the supplier to trigger an internal process to verify whether the complaint reason corresponds to the supplier-assessed reason.

ComplaintResponse

Typically, a ComplaintResponse e-Document is sent from the supplier or sender parties to the party who has originated the Complaint, or possibly to the RespondToParty. The e-Document is sent to communicate the acceptance, partial acceptance, or rejection, of the preceding complaint(s) with supporting information. Whatever the decision, this e-Document must specify how the complaint will be processed.

ContentOrderOfMatter

The ContentOrderOfMatter e-Document accompanies the prep content files for the sole purpose of specifying the page sequence in the book and the associated folio information.

Contract

The Contract e-Document can be used by business partners to communicate business agreements. Contracts are managed by a ContractParty that normally is the seller or the buyer. The Contract e-Document can also be sent to service providers that need the contract information for carrying out their services.

BusinessAcceptance

papiNet Standard - Version 2.31

CreditDebitNote

The CreditDebitNote e-Document is generally used by the SupplierParty to compensate or charge the trading parties (ShipToParty, BuyerParty, OtherParty, etc.) for matters outside the scope of the Invoice.

DeliveryInstruction

A DeliveryInstruction can be used to instruct movement of goods to warehouses and movement of goods to virtual locations within warehouses as well as deliveries to customers. The DeliveryInstruction e-Document is designed to fulfil supply chain requirements regarding instruction for goods deliveries to Mills, Suppliers, Forwarders, Warehouse Operators, Customers, and End-Users. The DeliveryInstruction is load oriented which is very efficient when mills and suppliers move goods in large quantities between warehouses.

DeliveryMessage

The DeliveryMessage e-Document enables the sender to describe the contents and configuration of a shipment at various levels of detail.

DeliveryMessageBook

The DeliveryMessageBook e-Document enables the sender to describe the contents and configuration of a shipment at various levels of detail.

DeliveryMessageWood

The DeliveryMessageWood e-Document enables the sender to describe the contents and configuration of a shipment at various levels of detail.

DeliveryPlanning

The DeliveryPlanning e-Document provides a tool for trading partners to exchange information about logistics planning for deliveries, transports and resources. Information can be specified for various levels such as a Budget, a Forecast, a Demand or a detail Plan for a certain period. Actual outcome to date related to a plan can also be reported.

Reason for deviation between a plan and the actual outcome can be reported. Opening times and/or contingencies can be specified for locations for a given day or period.

The DeliveryPlanning e-Document can supply a complete sourcing plan for a certain planning region containing for example many mills. Origin and destination for products can be specified as well as various transport modes and other transport details.

GoodsReceipt

The ShipTo party, or authorised agent, sends a GoodsReceipt e-Document to the Supplier and/or to the Buyer acknowledging that a specific delivery or a number of deliveries in a given time period have been received and their status.

InfoRequest

The purpose of InfoRequest e-Document is to allow the requesting party to request from the receiver party an update. The e-Documents that may be returned in response to an InfoRequest are the Availability, Calendar, InventoryStatus, OrderStatus, Planning, ProductQuality, ShipmenStatus, ShippingInstructions or Statement.

InventoryChange

The purpose of the InventoryChange e-Document is to inform involved parties about changes in the inventory at a specific location. The e-Document provides information allowing the receiving party to update their systems for cost tracking,

BusinessAcceptance

papiNet Standard - Version 2.31

performance, and financial reporting.

InventoryDispositionInstructions

The InventoryDispositionInstructions e-Document permits the owner of inventory stored at a third party location to request the inventory be destroyed, shipped to another location, held in inventory, or physically changed. The receiving party makes the requested changes to the inventory and sends an InventoryChange and ShippingInstructions, if required, to the requestor so their systems can be updated.

InventoryStatus

The InventoryStatus e-Document informs involved parties about physical inventory levels at specific stock locations (warehouse, terminal, printer etc.) at a certain time (snapshot).

Invoice

An Invoice e-Document can handle both debits and credits. Typically a seller sends an Invoice to a buyer after delivering the products or services specified in a PurchaseOrder or as part of an automatic replenishment agreement. Alternatively, an Invoice can be prepared by the buyer as part of a self-billing process. The Invoice is a list of the goods shipped and their quantities, or services rendered, indicating the price, terms of sale, supplemental charges, allowances, and communicates the payment required for the indicated items.

InvoiceWood

An InvoiceWood e-Document can handle both debits and credits. Typically a seller sends an InvoiceWood to a buyer after delivering the products or services specified in a PurchaseOrder or as part of an automatic replenishment agreement. Alternatively, an InvoiceWood can be prepared by the buyer as part of a self-billing process. The InvoiceWood is a list of the goods shipped and their quantities, or services rendered, indicating the price, terms of sale, supplemental charges, allowances, and communicates the payment required for the indicated items.

LoadAvailable

The Supplier party or authorized agent sends a LoadAvailable e-Document to the BuyerParty (consuming mill) indicating that load(s) for specific product is (are) ready on a specific date for acceptance and pickup. The LoadAvailable e-Document from the supplier may include a Shipper Load Number. This number may be used as the consuming mill's release number. The Shipper Load Number is used for authorization for pick-up of load at supplier point.

LoadTender

The LoadTender e-Document supports the transport booking process. Transport booking includes the following steps:

- LoadTender – more than one carrier has been informed about the upcoming transport.
- Booking – identifies a transport booking that is part of a detail transport plan, the load has been booked with a single carrier.

LoadTenderResponse

The LoadTenderResponse e-Document supports the transport booking process and is used as a response e-Document to LoadTender e-Document. Transport booking includes the following steps:

- LoadTenderResponse – more than one carrier has been informed about the upcoming transport.
- BookingConfirmation – identifies a transport booking that is part of a detail transport plan, the load has been booked with a single carrier.

BusinessAcceptance

papiNet Standard - Version 2.31

MeasuringInstruction

The MeasuringInstruction e-Document can be used to instruct a measuring party what to measure and how to measure it. Packages and loads as well as individual items can be measured.

MeasuringTicket

The MeasuringTicket e-Document specifies the details from measuring of items. Packages and loads can be measured as well as individual items in packages and loads. Products, Quantities and various measured properties can be reported. These measurements can be used as a base for calculation of billable products.

OrderConfirmation

A seller sends an OrderConfirmation e-Document to a buyer after receiving a PurchaseOrder from that buyer. The e-Document contains a response to the conditions specified in the PurchaseOrder. A supplier may also send an OrderConfirmation e-Document to convey changes that the supplier has made in the order or to convey new information such as a Supplier Reference Number or Job Number.

OrderConfirmationWood

A seller sends an OrderConfirmationWood e-Document to a buyer after receiving a PurchaseOrder from that buyer. The e-Document contains a response to the conditions specified in the PurchaseOrder. A supplier may also send an OrderConfirmationWood e-Document to convey changes that the supplier has made in the order or to convey new information such as a Supplier Reference Number or Job Number.

OrderStatus

The OrderStatus e-Document permits the sender to report the current status of an order, specific order line items, or to report status of multiple orders based upon some specified criteria. The e-Document enables the sender to indicate a primary status as well as an additional secondary status at the order level as well as for each line and component.

PackingList

The PackingList e-Document specifies the details of a shipment that is being despatched. The seller should send the PackingList e-Document in sufficient time so that the recipient can process the information before the goods arrive. The recipient can then prepare efficiently for the receipt of the goods.

Planning

The Planning e-Document provides a tool for trading partners to exchange forecasted or planned information for a specific product or event within a specified timeframe. The e-Document is designed to support a variety of business processes, which may include securing needed supplies or simply the exchange of information.

Preflight

The Preflight e-Document reports the status of prep content files separately, by product or by Purchase Order or to report status of multiple files based upon some specified criteria. The e-Document enables the sender to indicate a primary status as well as an additional secondary status as needed.

ProductAttributes

The ProductAttributes e-Document provides the means to communicate information about products between business partners.

ProductPerformance

BusinessAcceptance

papiNet Standard - Version 2.31

The ProductPerformance e-Document is created by the product consumer in order to communicate back to the manufacturer the performance of the product. This e-Document will enable the manufacturer to focus on improvements related to product defects that create inefficiency during performance. The aggregation of performance factors by product will provide the mechanism for achieving the value aspect of the e-Document. The goal is to keep the products of the Pulp & Paper Industry attractive versus competing alternatives.

ProductQuality

The ProductQuality e-Document supports the exchange of quality data for individual items. The agreed properties of the product that are exchanged can include statistical values such as minimum and maximum, standard deviation, sample size, two sigma (lower-limit, upper-limit).

PurchaseOrder

A buyer sends a PurchaseOrder e-Document to a supplier to initiate a trade transaction. This e-Document, which is a request for product, usually represents a firm commitment to buy. (For one type of PurchaseOrder, called a reservation order, the PurchaseOrder is not a firm commitment to buy).

PurchaseOrderWood

A PurchaseOrderWood e-Document is set up between a buyer and a seller. In some cases an agent acts on behalf of the seller or the buyer when setting up the contract. However, the contract is not valid until signed by the buyer and the seller. A PurchaseOrderWood may cover one delivery of merchandise on one occasion or cover a time period with several deliveries. This PurchaseOrderWood refers to a standardised contract form containing all legal details.

QR

QR (Quick Response) is a light weight papiNet e-Document that is designed to be carried by Quick Response Codes. Multiple document types can be defined in the QR e-Document supporting different contents of QR Codes.

RFQ

A buyer sends an RFQ e-Document to a supplier to initiate a request for quotation. This e-Document, which is a request for product information, represents a request for the supplier to provide a quotation for product availability, shipping, and price.

RFQResponse

A supplier sends an RFQResponse e-Document to a buyer as a response to an RFQ e-Document from the buyer. The e-Document specifies a quotation for product availability, shipping, and price.

ScaleTicket

The ScaleTicket e-Document provides wood or fibre suppliers with a means to electronically incorporate scale system receiving data into their accounting systems from buying entities' back office systems.

ServiceInstruction

The ServiceInstruction e-Document can be used to instruct a party to carry out a service. Characteristics for the service can be specified.

Instructions for deliveries and measuring of products have dedicated e-Documents DeliveryInstruction and MeasuringInstruction.

ShipmentStatus

The ShipmentStatus e-Document is sent to communicate the status of a shipment or consignment with references to other documents. Typically, a ShipmentStatus e-

BusinessAcceptance

papiNet Standard - Version 2.31

Document is sent from the forwarder or carrier to the consignor / forwarder.

ShippingInstructions

The ShippingInstructions e-Document communicates delivery information for product(s) supported by a PurchaseOrder.

Statement

The Statement e-Document permits the manufacturer or supplier to report the current status of an invoice, or a list of invoices based upon specified criteria. The e-Document enables the sender to indicate payment status for the invoice.

Usage

The Usage e-Document is used to notify a supplier or buyer that material has been consumed within the end user's manufacturing process.

Other

Other e-documents not specified by papiNet.

DocumentType [attribute]

DocumentType is optional. A single instance might exist.

The type of e-Document being communicated.

This item is restricted to the following list.

Agreement

A legally binding exchange of promises between parties that the law will enforce.

Approximate

An invoice that is created to record ownership transfer without the material physically being moved. Typically what occurs is that the buyer has agreed to take ownership of the item at a certain point in time but has not arranged for transportation. Approximate invoices are invoices that are claiming payment.

ArrivalTicket

A MeasuringTicketType that contains information about rough measurements done upon arrival of a transport vehicle to a measuring location. For example used for updating physical location of the load and calculating compensation to the carrier.

AvailabilityInstruction

An AvailabilityInstruction can specify many delivery events. Each event can contain quantity for one or many loads, but does not specify the load. A DeliveryInstruction type DeliveryInstruction specifies more details for the events in an AvailabilityInstruction. AvailabilityInstruction can also be handled by the company responsible for the delivery independently if so agreed.

BlanketOrder

An order that communicates the same information as a StandardOrder but also indicates that the order may be completed over a period of time or, until a certain volume is achieved or, until a certain currency amount is spent.

Booking

An indication that time for a service is required. For example a booking that is part of a detail transport plan.

BookingConfirmation

A communication affirming the placement of the booking with a particular party.

CalibrationCheckLog

BusinessAcceptance

papiNet Standard - Version 2.31

A MeasuringTicketType that contains a check log with information about calibration of measuring equipment.

CallOff

Defines a call-off sent by the buyer to the seller.

CallOffConfirmation

Defines a call-off confirmation sent in response to a call-off.

Claim

A "Claim" type is used when there is a customer reaction that includes a financial compensation.

ConfirmingOrder

A confirming order is used to electronically confirm an order that has not been placed electronically by the customer that is, it was placed using another mean such as fax, phone or email.

ConsumptionOrder

A purchase order that is based upon consumption for a particular period of time or instance.

CreditNote

Credits which are provided to the receiving party for amount reductions.

DebitNote

Debits which are charged to the receiving party for additional charges.

DeliveryInstruction

A Delivery Instruction can specify many delivery events. Each event can contain quantity for one or many loads. A sequence in a Delivery Instruction specifies all details for one event. The receiver of a Delivery Instruction can generate many Loading Instructions from one Delivery Instruction.

DeliveryMessage

A delivery message type that contains optional routing information, quantities at the DeliveryMessageLineItem level, and details at the DeliveryMessageLineItemDetail level. The seller uses a DeliveryMessage to provide delivery details to the ship-to party and tracking information.

DeliveryPlan

A DeliveryPlanningType used to inform about quantities and times for the planned deliveries to the delivery destinations.

Duplicate

To be removed in a future version. When an invoice is reissued as a duplicate the invoice type should be the same as on the original invoice. Use attribute Reissued = Yes to indicate a duplicate.

Feedback

A "Feedback" type is used when there is a customer reaction that doesn't include any financial compensation.

ForestLoggingInstruction

An instruction specifying what products to produce in a forest logging and forwarding operation.

InitialShipmentAdvice

BusinessAcceptance

papiNet Standard - Version 2.31

A delivery message type that contains detailed routing information, quantities at the DeliveryMessageLineItem level and optionally details at the DeliveryMessageLineItemDetail level. The seller uses the InitialShipmentAdvice to provide preliminary notification of shipment routing and quantities (can be used as an advanced notice of delivery). The quantities indicated may not necessarily be delivered—for example, if there is damage in transit or the delivery is rerouted to another destination.

Invoice

A regular invoice (referred to as an invoice) is a e-Document claiming payment for goods supplied under conditions agreed to between seller and buyer. The invoice communicates, among other things, payment terms, payment method, and the payment amount required for one or more deliveries.

InvoiceSpecification

A MeasuringTicketType that contains information about measured products including prices and amounts. This MeasuringTicketType is normally used as a detailed specification of billable or invoiced products.

LoadAvailable

LoadAvailable indicates the e-Document is from the company with the load.

LoadAvailableConfirmation

LoadAvailableConfirmation indicates the e-Document is from the company to whom the load was offered.

LoadedSpecification

A DeliveryMessageType that contains a specification of loaded goods on a transport unit (e.g. container, rail wagon). A loading specification (LoadedSpecification) can contain goods belonging to many suppliers and buyers and is normally referring to a Loading Instruction.

LoadingInstruction

A Loading Instruction specifies loading of transport units. A Forwarder receiving a Delivery Instruction from a supplier can convert it into many Loading Instructions, which are sent to a Warehouse Operator. A sequence in a Loading Instruction specifies all details how to load one transport unit. A Loading Instruction can include goods from many Delivery Instructions and also goods belonging to many suppliers.

LoadingOrder

Specifies delivery schedule, the transport booking requirements and shipping instructions, as well as the internal work order for the shipment

LoadingSchedule

The schedule for transport vehicle loading.

LoadTender

More than one carrier has been informed about the upcoming transport requirement (the load).

LoadTenderResponse

Indicates the ability of the respondent to fulfil the load tender request.

MeasuringInstruction

An instruction to measure products. Normally a measurement includes both quantity and quality.

BusinessAcceptance

papiNet Standard - Version 2.31

MeasuringTicket

A MeasuringTicketType that contains detailed information about measured products and items. This information can be used as a base for calculation of billable products.

OfficeSchedule

The schedule for office personnel.

OriginalContract

A contract between the first seller and the first buyer in a supply chain. For example a contract when a forest owner sells roundwood to a forest company.

PackingSpecification

A Packing Specification is a business transaction specifying the complete consignment being shipped from a consignor to a consignee. The specification describes in detail what is being shipped and how it is packed and marked.

PreBooking

A requirement for a transport vehicle or unit reservation that has risen from a rough transport plan.

PreBookingConfirmation

A communication of the requirement for a transport vehicle or unit reservation that has risen from a rough transport plan.

PrePayment

A prepayment invoice is used as a notification of amounts to be paid in advance. It is not a legal invoice claiming payment for provided products or services.

PriceList

Used when sending a pricelist

ProductCrossReference

Used in the exchange of ProductIdentifier cross-references for the product codes used by two trading partners.

ProductDestiningInstruction

An instruction requesting the receiver to destine product(s) to end users.

ProductionTicket

A MeasuringTicketType that contains information about produced products and items. A ProductionTicket can also contain measuring information for produced items.

PropertyTicket

A MeasuringTicketType that contains detailed information about calculated or measured properties of a SourceProduct not related to a specific delivery.

It typically consolidates property information over a time period, measuring location and other attributes defined in an InfoRequest or otherwise agreed between partners.

ProductProperties

Used when sending a list of ProductAttributes

ProForma

A pro-forma invoice is not a legal invoice claiming payment. A pro-forma invoice is

BusinessAcceptance

papiNet Standard - Version 2.31

an e-Document serving as a preliminary invoice, containing on the whole the same information as the final invoice, but not actually claiming payment. Pro-forma invoices are typically used in a cross-border shipment for customs purposes. Can travel with the product or be sent to a broker.

QR_DMM

DMM contains information needed by a measuring party to be able to start measurement of products for a delivery. It is condensed information from information normally found in a papiNet DeliveryMessage.

ReleaseOrder

A release order is used to release a product to be made. This type of order refers to a previous order or agreement, such as a reservation order, a contract, or a blanket order. A release number version which is an incremented number, is used in this type.

ReservationOrder

A reservation order is used to book a paper supplier's capacity for specific quantities of specific products, but it is not yet a firm commitment to buy. Consequently, all line items of a reservation order have a ProductionStatusType of NotFree. To release one or more purchase order line items of a reservation order, a buyer can use a standard order or a release order.

ResourcePlan

A DeliveryPlanning type that contains information about all the planned resources available for a certain period. The resources can be for example vehicles or personnel.

SalesCatalogue

A MeasuringTicketType that contains information about measurements of products for sale. For example used for sending information about logs at roadside or standing trees for sale.

SampleMeasuringInstruction

An instruction to measure samples to check the original measurements or to measure specific properties in for example a laboratory.

SampleMeasuringTicket

A MeasuringTicketType that contains detailed information about measured samples taken from e.g. a delivery.

SelfBillingStatement

A SelfBillingStatement is an invoice that is prepared by the buyer of the product (or the consumer of the service) for the provider of the product or service. The preparer will pay the invoice.

Typically logistics costs charges are the service that are communicated. They are incurred during a certain period of time between the party who provides the logistics services (typically the party with a LogisticsRole of "LogisticsProvider") and the requestor of such services (typically the party with a LogisticsRole of "Consignor").

Raw materials, maintenance, repair, and operating supplies are examples of products that can be entered on a self billing statement for products. This type of invoice is also referred to as an invoice for "evaluated receipts" because it developed from the receiving department's evaluation of their receipts and from that creating the invoice.

The SelfBillingStatement process exists when there is a great deal of trust between

BusinessAcceptance

papiNet Standard - Version 2.31

the trading partners that permits this cost savings business process.

ShipmentAdvice

A DeliveryMessageType that contains a specification of goods, that are dispatched and will be delivered to a warehouse. A ShipmentAdvice can refer to a Delivery Instruction Sequence or a CallOff, but is normally also used for notifying a receiving warehouse operator of shipments to the warehouse.

ShippingInstructionsConfirmation

Confirmation of the Shipping Instruction.

ShippingInstructionsDistribution

Shipping Instruction serves as a billable order for shipping product that was produced under a previous manufacturing order.

ShippingInstructionsPackaging

To be deprecated in a future version. Guidance will be given to trading partners not to use this enumeration.

ShippingInstructionsRouting

Shipping Instructions issued in conjunction with a Purchase Order for shipping the product.

SpecContent

Indicates that BookSpecification should only be used in the content file verification process.

SpecOrder

Used when the BookSpecification e-Document is intended for use with the Purchase Order transaction.

SpecRFQ

Used when the BookSpecification e-Document is intended for use with the Request for Quote (Estimate) transaction.

StandardOrder

A standard order is a regular one-time order. It defines quantities for one or more products to be purchased and may also define a delivery location and date. A standard order may reference a previous agreement (for example, a quotation, a contract, or a reservation order) for information.

StandardRFQ

SupplierSpec

Will be removed in a future version. Recommended not to be used.
(Used when the BookSpecification e-Document is intended for use by the Supplier only and is not generated by, or transmitted to the Buyer)

SupportSchedule

The support schedule for transport operations.

ThirdPartyShipmentAdvice

Notification of a shipment from a warehouse to a party other than the party that ordered the product from the supplier.

TradingContract

A contract between a seller and a buyer, when products (or services specified as products) bought by the seller are resold to a buyer in a supply chain. For example

BusinessAcceptance

papiNet Standard - Version 2.31

a contract when a forest company sells roundwood bought from a forest owner or another forest company to a buyer.

TransportPlan

A DeliveryPlanningType used to inform about quantities and times for the planned transports to the delivery destinations.

TrialOrder

A trial order is used whenever a seller has agreed to have a buyer sample a product. The seller needs to process this order differently from other orders, because a trial order may include a product sold at a discounted rate or even provided for free. A trial order typically is for small quantities.

UniqueProductIdentifier

The information contains unique product identifiers.

UnloadingSchedule

The schedule for transport vehicle unloading.

Waybill

The forwarding agreement or carrying agreement that is used as a receipt for cargo and as a contract of carriage.

OtherDocumentName [attribute]

OtherDocumentName is optional. A single instance might exist.

Defines the document name for documents that are not papiNet e-Documents. These documents are defined in element Document by OtherDocumentName when attribute DocumentName has the value "Other".

OtherDocumentType [attribute]

OtherDocumentType is optional. A single instance might exist.

Defines the document type for a document that is not a papiNet e-Document.

(sequence)

The contents of (sequence) are mandatory. A single instance is required.

DocumentNumber

DocumentNumber is mandatory. A single instance is required.

The unique identifier of a papiNet e-Document.

DocumentVersionNumber

DocumentVersionNumber is optional. A single instance might exist.

The assigned version number of a document. For example version 2.12 of a pricelist on paper or a version number of an e-Document.

DocumentDate

DocumentDate is mandatory. A single instance is required.

The Date and optionally Time when the document that is referred to was issued.

TransactionHistoryNumber

TransactionHistoryNumber is optional. A single instance might exist.

A sequential number that keeps track of the version of a document being sent by the document originator. However when the document is a confirmation document, in which case the TransactionHistoryNumber refers to the trigger transaction for

BusinessAcceptance papiNet Standard - Version 2.31

which the confirmation is being sent.

DocumentReference

DocumentReference is optional. Multiple instances might exist.

An element detailing relevant references pertaining to the paiNet business document, as indicated by the DocumentReferenceType and AssignedBy.

DocumentRejectionReason

A grouping element that contains information about the rejection reason for the document that is rejected.

Agency [attribute]

Agency is mandatory. A single instance is required.

Describes the agency maintaining the list of codes. To be included in this list the agency must be a recognized standards body or industry organisation.

- For the element that owns this attribute.
- For another attribute in the list of attributes associated with the parent element.

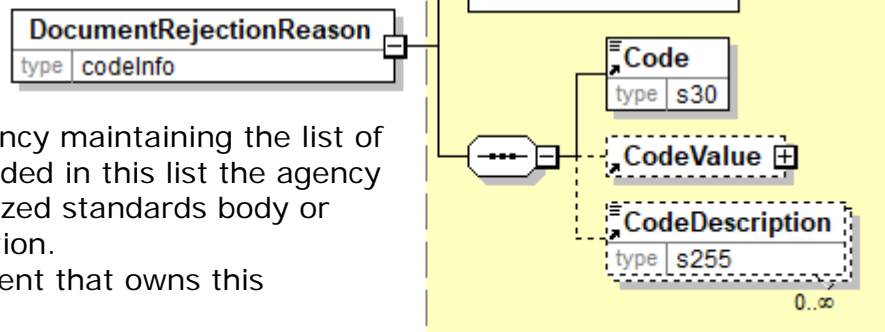

Refer to Agency definition for any enumerations.

(sequence)

The sequence of items below is mandatory. A single instance is required.

Code

Code is mandatory. A single instance is required.

Specifies a code that is defined by an agency. The agency is given for the whole construct containing the code.

CodeValue

CodeValue is optional. A single instance might exist.

A grouping element specifying a value belonging to a code that is defined by an agency.

CodeDescription

CodeDescription is optional. Multiple instances might exist.

A textual description for the meaning of a code that is defined by an agency. When the Code is associated with a CodeValue of type TextValue, then the CodeDescription is a textual description of both the Code and the TextValue.

BusinessAcceptance

papiNet Standard - Version 2.31

BusinessAcceptanceParty

The organisation or legal entity authorised to accept or reject business document.

PartyType [attribute]

PartyType is mandatory. A single instance is required.

Identifies the business role associated with the particular party.

Refer to PartyType definition for any enumerations.

(sequence)

The contents of (sequence) are mandatory. A single instance is required.

PartyIdentifier

PartyIdentifier is mandatory. One instance is required, multiple instances might exist.

A unique identifier of a specific party. This element contains an attribute PartyIdentifierType that indicates the type of party.

NameAddress

NameAddress is mandatory. A single instance is required.

A group item containing name and address of an organisation or business entity.

URL

URL is optional. A single instance might exist.

Universal Resource Locator. While typically a web address you could use this field to hold an email address.

CommonContact

CommonContact is mandatory. One instance is required, multiple instances might exist.

Identifies a specific individual associated with the party.

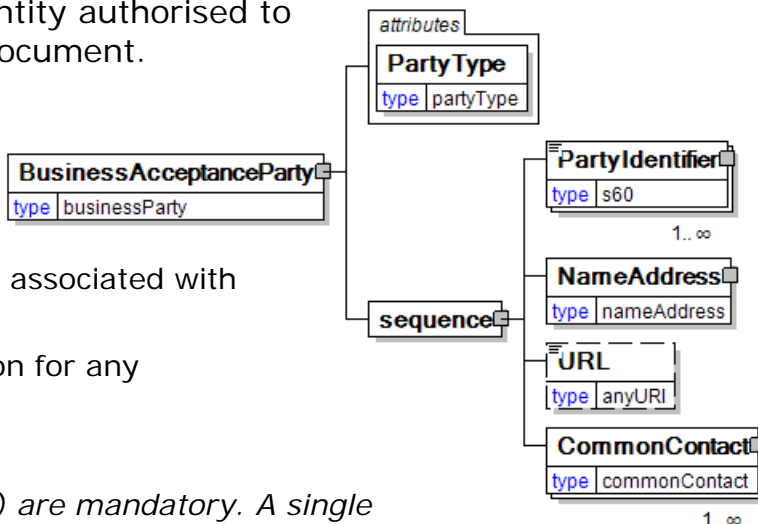

AdditionalText

A text field that is used to communicate information not previously defined or for special instructions. To be used only for circumstances not covered by specific elements.

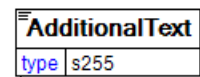

BusinessAcceptance

papiNet Standard - Version 2.31

Supporting Items

PartyType [attribute]

Identifies the business role associated with the particular party

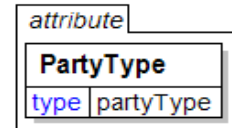

This item is restricted to the following list.

Auditor

A third party that is authorized for making audits and checkings.

Bank

The banking representative.

BillTo

The address where the invoice is to be sent. (Not to be used for logistics BillTo, see LogisticsBillTo.)

BorderCrossing

A geographic location separating two countries authorised to validate customs documentation.

Broker

The organisation acting as a broker for the buyer or supplier.

BusinessChainParty

The organisation or business entity responsible for managing the business chain between business partners when trading of products in many levels of trade.

Buyer

The legal entity to which the product is sold. Also commonly referred to as the sold-to party or customer. If no OtherParty is defined as the "Payer", the "Buyer" is the "Payer". (Not to be used for logistics buyer, see LogisticsBuyer.)

BuyerAgent

The entity acting for the buyer in the transaction. (Not to be used for logistics BuyerAgent, see LogisticsBuyerAgent.)

Carrier

The organisation or business entity that transports goods.

CarrierAssignmentResponsible

The organisation to which the carrier has assigned some task.

ComponentVendor

Vendor producing supplied components.

Compositor

Party that formats written material and illustrations for printing or electronic display.

Consignee

BusinessAcceptance

papiNet Standard - Version 2.31

To be deprecated in version 3.0 (no date determined). Use LogisticsRole attribute to communicate this information.

Consignor

To be deprecated in version 3.0 (no date determined). Use LogisticsRole attribute to communicate this information.

Consuming

The eventual consumer of the material

ContractParty

The organisation or business entity responsible for managing the contract between business partners.

Converter

The organisation responsible for changing one form of paper into another form, providing specialised functions not available to the supplier.

CreditDepartment

The party responsible for credit authorization.

CrossDock

A third party involved in the transport of goods.

CustomerFacility

The type of the origin or destination location of a transport leg in a route is a buyer facility, usually a print site, or a warehouse owned by the buyer.

CustomerStock

A "virtual" location that indicates that the material is owned by the customer.

Customs

Any customs agency.

CustomsForwarder

A forwarder responsible for managing the transfer of goods through customs.

DeliveryPlanningParty

The organisation responsible for planning of deliveries to delivery destinations.

DomesticForwarder

A forwarder responsible for managing the transfer of goods.

EndUser

EndUser is the party using, consuming, or converting the product. For example, a printer using paper reels to print a job for a publisher (printer is the end user). The final ShipTo destination for a product is normally to the EndUser facilities.

ExportForwarder

A forwarder responsible for managing the export process.

ForestForwarder

BusinessAcceptance

papiNet Standard - Version 2.31

The party that transports forest wood products from logging areas to roadside landings.

ForestForwardingRequestor

The party requesting forest forwarding services.

ForestHarvester

The party that harvests forest wood products at logging areas.

ForestHarvestingRequestor

The party requesting forest harvesting services.

Forwarder

The party responsible for shipping arrangements.

FreightPayer

The party responsible for paying freight.

Insurer

The party providing insurance coverage for the goods.

Laboratory

Laboratory is where analysis is done.

Landowner

The party who owns the land upon which the product was produced.

LoadingOperator

A party that is carrying out loading of transport units.

LoggingArea

A geographic location in the forest where logging takes place.

LogisticsBillTo

The address where the logistics invoice is to be sent.

LogisticsBuyer

The buyer of logistics services. The legal entity to which the service is sold. Also commonly referred to as the sold-to party or customer. If no OtherParty is defined as the "LogisticsPayer", the "LogisticsBuyer" is the payer.

LogisticsBuyerAgent

The entity acting for the logistics buyer in the transaction.

LogisticsPayee

The party handling and receiving logistics payments on behalf of another party.

LogisticsPayer

The party handling and sending logistics payments of behalf of another party.

LogisticsPlanningParty

The organisation responsible for planning of logistics services.

BusinessAcceptance

papiNet Standard - Version 2.31

LogisticsSeller

The seller of logistics services. LogisticsSupplier is the seller of the service, if logistics seller is not specified as OtherParty = LogisticsSeller.

LogisticsServiceProvider

A party that is responsible for a service in logistics business.

LogisticsServiceProvider (misspelt with an ending space)

The item is misspelt ending with a space. It will be deprecated in next version. Use instead the correctly spelt enumeration LogisticsServiceProvider.

LogisticsSupplier

The party responsible for providing the logistics services. LogisticsSupplier is also the seller of the service, if logistics seller is not specified as OtherParty = LogisticsSeller.

MainCarrier

The primary carrier involved in the movement of goods.

MainForestForwarder

The party responsible for transporting forest wood products from logging areas to roadside landings.

MainForestHarvester

The party responsible for harvesting of forest wood products at logging areas.

Measurer

The party that that is carrying out the measurement of the quantity and/or quality of the products. It can be a person, a piece of equipment or a device.

MeasuringParty

The party that is responsible for the measurements at the measuring location.

Merchant

A third party buying and reselling products.

Mill

A production facility.

NotifyParty

A party that needs to be notified of the status of the transaction.

OnBehalfOf

The activity in question is being made on behalf of this party.

OrderParty

The organisation or business entity placing the order if different from the buyer party.

OriginalBuyer

The first buyer in a supply chain. OriginalBuyer is only used when the first buyer in a supply chain needs to be specified in other e-documents than e-documents belonging to the first level of trade. (Not to be used for the first

BusinessAcceptance

papiNet Standard - Version 2.31

buyer in a supply chain of logistics, see OriginalLogisticsBuyer.)

OriginalBuyerAgent

The entity acting for the OriginalBuyer in the transaction. OriginalBuyerAgent is only used when the first buyer agent in a supply chain needs to be specified in other e-documents than e-documents belonging to the first level of trade. (Not to be used for the first buyer agent in a supply chain of logistics, see OriginalLogisticsBuyerAgent.)

OriginalLogisticsBuyer

The first logistics buyer in a supply chain of logistics. OriginalLogisticsBuyer is only used when the first logistics buyer in a supply chain of logistics needs to be specified in other e-documents than e-documents belonging to the first level of logistics trade.

OriginalLogisticsBuyerAgent

The entity acting for the OriginalLogisticsBuyer in the transaction. OriginalLogisticsBuyerAgent is only used when the first logistics buyer agent in a supply chain of logistics needs to be specified in other e-documents than e-documents belonging to the first level of logistics trade.

OriginalLogisticsSeller

The first logistics seller in a supply chain of logistics. OriginalLogisticsSupplier is the OriginalLogisticsSeller of the service, if OriginalLogisticsSeller is not specified as OtherParty = OriginalLogisticsSeller. OriginalLogisticsSeller is only used when the first logistics seller in a supply chain of logistics needs to be specified in other e-documents than e-documents belonging to the first level of logistics trade.

OriginalLogisticsSupplier

The first logistics supplier in a supply chain of logistics. OriginalLogisticsSupplier is also the OriginalLogisticsSeller of the service, if OriginalLogisticsSeller is not specified as OtherParty = OriginalLogisticsSeller. OriginalLogisticsSupplier is only used when the first logistics supplier in a supply chain of logistics needs to be specified in other e-documents than e-documents belonging to the first level of logistics trade.

OriginalOrderParty

Party which ordered the product from the Party sending the first level PurchaseOrder in an indirect purchase order process.

OriginalSeller

The first seller in a supply chain. OriginalSupplier is the OriginalSeller of the product, if OriginalSeller is not specified as OtherParty = OriginalSeller. OriginalSeller is only used when the first seller in a supply chain needs to be specified in other e-documents than e-documents belonging to the first level of trade. (Not to be used for the first seller in a supply chain of logistics, see OriginalLogisticsSeller.)

OriginalSupplier

The first supplier in a supply chain. OriginalSupplier is also the OriginalSeller of the product, if OriginalSeller is not specified as OtherParty = OriginalSeller. OriginalSupplier is only intended to identify the business party, not the origin

BusinessAcceptance

papiNet Standard - Version 2.31

of the product. OriginalSupplier is only used when the first supplier in a supply chain needs to be specified in other e-documents than e-documents belonging to the first level of trade. (Not to be used for the first supplier in a supply chain of logistics, see OriginalLogisticsSupplier.)

Payee

The party handling and receiving payments on behalf of another party. (Not to be used for logistics payee, see LogisticsPayee.)

Payer

The party handling and sending payments of behalf of another party. (Not to be used for logistics payer, see LogisticsPayer.)

PlaceFinalDestination

The final destination of the goods.

PlaceOfAccept

The location where acceptance of the goods is to take place.

PlaceOfDespatch

The location where despatch took place.

PlaceOfDischarge

The location where the goods were unloaded.

PlaceOfLoading

The location where loading is to or took place.

PlaceOfMeasuring

The location where the products are measured.

PlaceOfPassingThrough

A location to be passed by a vehicle, e.g. a main intersection on a Route.

PlaceOfReloading

A location where the goods were or will be transferred from one transport to another. It may but does not need to involve a change of transport mode.

Port

The type of the origin or destination location of a transport leg in a route. It is a maritime location.

PreCarrier

The party responsible for activities prior to carrier accepting the goods (but after shipping has taken place).

PriceListParty

The organization or business entity responsible managing for the price list between business partners.

PrinterFacility

The location of the printer who will be using the product.

Producer

BusinessAcceptance

papiNet Standard - Version 2.31

The manufacturer of the goods.

ProductAgency

Organization responsible for defining unique product identifiers.

ProFormalInvoice

The organisation or business entity to which the pro-forma invoice will be sent.

Publisher

Individual or corporation responsible for the printing and distribution of digital or printed publications.

RemitTo

The organisation or business entity to which payment will be made.

Requestor

The originator of the original PurchaseOrder requisition (for example, a printing plant ordering through a central purchasing organisation).

RoadKeeper

The party who is responsible for the maintenance of the road.

RoadOwner

The party who is the legal owner of the road.

SalesAgent

The organisation or person responsible for product sales acting on behalf of the seller.

SalesOffice

The functional unit in an organisation or business entity that is responsible for product sales.

Seller

The seller of the product. SupplierParty is the seller of the product, if Seller is not specified as OtherParty = Seller. (Not to be used for logistics seller, see LogisticsSeller.)

ServiceProvider

The party that is responsible for a service in product business.

ShipFromLocation

The location the goods were shipped from.

ShipOwner

The owner of the vessel used to ship the goods.

ShipTo

The address the material should be shipped to.

SubCarrier

A sub carrier of another the shipping company.

Supplier

BusinessAcceptance

papiNet Standard - Version 2.31

The organisation or business entity responsible for providing the product. SupplierParty is also the seller of the product, if Seller is not specified as OtherParty = Seller. (Not to be used for logistics supplier, see LogisticsSupplier.)

SupplyRequirementPlanningParty

The organisation responsible for planning of supply requirements for industries depending on their needs.

Terminal

The type of the origin or destination location of a transport leg in a route. It can be a sea, road or rail terminal.

TerminalOperator

The party providing facilities such as loading, unloading, or warehousing.

UnloadingOperator

A party that is carrying out unloading of transport units.

Warehouse

A storage location. It can be the origin or destination location of a transport leg in a route.

WarehouseOperator

The party operating a warehouse.

WillAdvise

Indicates that party will be identified at a later time

Other

Any other organisation or business entity that may get involved in the transaction and that is not covered by the list.

BusinessAcceptance papiNet Standard - Version 2.31

BusinessAcceptance Business Scenarios

BusinessAcceptance Scenario Listing

| | |
|-------------------|---|
| Scenario A | Warehouse Operator accepts a Delivery Instruction |
| Scenario B | Warehouse Operator rejects a Delivery Instruction |

Scenario A

| | |
|----------------------|--|
| e-Document | BusinessAcceptance |
| Scenario | Supplier sends a Delivery Instruction to the Warehouse Operator. The Warehouse Operator accepts the Delivery Instruction |
| Outcome | Supplier records in the ERP system that the Delivery Instruction has been accepted. |
| Initiator | Warehouse Operator |
| Receiver | Supplier |
| Preconditions | Supplier sends Delivery Instruction no 12345 to Warehouse Operator |
| Trigger | Warehouse Operator receives a Delivery Instruction |
| Step 1. | Warehouse Operator successfully posts the Delivery Instruction into their ERP. |
| Step 2. | A user checks the content of the Delivery Instruction and accepts that it can be executed. |
| Step 3. | Warehouse Operator sends a BusinessAcceptance to the Supplier specifying that the Delivery Instruction is accepted <ul style="list-style-type: none"> • BusinessAcceptanceStatus = "Accepted" • DocumentNumber = 12345 • DocumentName = "DeliveryInstruction" • DocumentType = "DeliveryInstruction" • DocumentDate • BusinessAcceptanceParty with Party and CommonContact |
| Results | The Supplier system marks the Delivery Instruction as accepted. |

Scenario B

| | |
|-------------------|--------------------|
| e-Document | BusinessAcceptance |
|-------------------|--------------------|

BusinessAcceptance
papiNet Standard - Version 2.31

| | |
|----------------------|---|
| Scenario | Supplier sends a Delivery Instruction to the Warehouse Operator. The Warehouse Operator rejects the Delivery Instruction |
| Outcome | Supplier records in the ERP system that the Delivery Instruction has been rejected. Manual actions are needed. |
| Initiator | Warehouse Operator |
| Receiver | Supplier |
| Preconditions | Supplier sends Delivery Instruction no 12346 to Warehouse Operator |
| Trigger | Warehouse Operator receives a Delivery Instruction |
| Step 1. | Warehouse Operator successfully posts the Delivery Instruction into their ERP. |
| Step 2. | A user checks the content of the Delivery Instruction and finds out that it can't be executed. The user rejects the Delivery Instruction. |
| Step 3. | Warehouse Operator sends a BusinessAcceptance to the Supplier specifying that the Delivery Instruction is rejected. Reject reasons are given in AdditionalText. <ul style="list-style-type: none"> • BusinessAcceptanceStatus = "Rejected" • DocumentNumber = 12346 • DocumentName = "DeliveryInstruction" • DocumentType = "DeliveryInstruction" • DocumentDate • BusinessAcceptanceParty with Party and CommonContact • Additionaltext = "explanation of reject reasons" |
| Results | The Supplier system marks the Delivery Instruction as rejected. The responsible organisation is notified and manual actions are taken to find a solution. |