



papiNet

ScaleTicket

papiNet Standard - Version 2.31

Documentation

**Global Standard for the Paper and Forest
Products Supply Chain**

Build V2R31_20211013

Date 2021-10-22

Production Release

ScaleTicket

papiNet Standard - Version 2.31

Copyright

Copyright 2000 - 2021 papiNet G.I.E ("papiNet") and International Digital Enterprise Alliance, Inc. ("IDEAlliance") collectively "Copyright Owner". All rights reserved by the Copyright Owner under the laws of the United States, Belgium, the European Economic Community, and all states, domestic and foreign. This document may be downloaded and copied provided that all copies retain and display the copyright and any other proprietary notices contained in this document. This document may not be sold, modified, edited, or taken out of context such that it creates a false or misleading statement or impression as to the purpose or use of the papiNet specification, which is an open standard. Use of this Standard, in accord with the foregoing limited permission, shall not create for the user any rights in or to the copyright, which rights are exclusively reserved to the Copyright Owner.

papiNet, IDEAlliance, and the members of all papiNet Groups (collectively and individually, "Presenters") make no representations or warranties, express or implied, including, but not limited to, warranties of merchantability, fitness for a particular purpose, title, or non-infringement. The presenters do not make any representation or warranty that the contents of this document are free from error, suitable for any purpose of any user, or that implementation of such contents will not infringe any third party patents, copyrights, trademarks or other rights. By making use of this document, the user assumes all risks and waives all claims against Presenters.

In no event shall Presenters be liable to user (or other person) for direct, indirect, special or consequential damages arising from or related to any use of this document, including, without limitation, lost profits, business interruption, loss of programs, or other data on your information handling system even if Presenters are expressly advised of the possibility of such damages.

Use of Documents in papiNet Implementations

Documents may be used as templates for a papiNet implementation. The Presenters grant the right to modify and edit them to fit an actual implementation project provided all copies display the copyright and any other proprietary notices contained in this document. Such modified documents must not be distributed beyond the trading partners implementing or maintaining a papiNet connection.

ScaleTicket

papiNet Standard - Version 2.31

Table of Contents

Copyright	2
Use of Documents in papiNet Implementations	2
Table of Contents	3
ScaleTicket Documentation	4
ScaleTicket e-Document Overview	4
The Scope of ScaleTicket e-Document	4
ScaleTicketAcceptance [attribute]	5
ScaleTicketRejectedType [attribute]	6
Business Rules for ScaleTicket	7
Processing the ScaleTicket e-Document	7
Understanding the Diagrams and Content	8
ScaleTicket Root Element	10
ScaleTicket	10
Primary Elements	14
ScaleTicketHeader	14
ScaleTicketLineItem	16
ScaleTicketSummary	18
ScaleTicket Business Scenarios	20
ScaleTicket Scenario Listing	20
Scenario A	20

ScaleTicket

papiNet Standard - Version 2.31

ScaleTicket Documentation

ScaleTicket e-Document Overview

The ScaleTicket e-Document provides wood or fibre suppliers with a means to electronically incorporate scale system receiving data into their accounting systems from buying entities' back office systems.

Mill scale houses generate a paper receiving ticket that is usually in multi-part form that is the only documentation that ever gets taken away with the delivering truck driver and back to the supplier's office. This paper ticket is the sole means of tracking production, proof of delivery, and reconciling a mill's weekly or monthly settlement statement against the supplier's records to audit accuracy of the settlement statement. The paper ticket in most cases is still required to be presented by law as the legal document of the transaction, however significant work process savings can be gained by electronically moving this receiving data from the buyer's back office systems directly into the supplier's accounting system – thus eliminating potentially thousands of tickets from having to be manually entered. The value proposition around adoption of this e-Document is all about supply chain information visibility, operational efficiencies for suppliers, and reduced errors and administrative burden on the buyer.

The ScaleTicket e-Document assumes that a previous agreement between buyer and seller has taken place (usually in the form of a wood purchase contract or purchase order).

Prior to implementing business processes that require a ScaleTicket, it is necessary for the parties involved to have already opened a dialogue and have reached a collaborative agreement including such items as:

- frequency of e-Documents,
- form of detail, whether by period, purchase order, or shipment.

content detail, such as

- the particular quality properties to be sent,
- which statistical values associated with the properties will be sent,
- level of aggregation, whether summary and/or detailed information
- rules for arriving at measurement values,
- rules for replacing and cancelling e-Documents, and
- units of measure.

A Supplier sends a ScaleTicket e-Document to another trading partner on a frequency or event basis agreed between them.

The degree of detail and extent of the information exchanged will vary between Suppliers and their trading partners. The ScaleTicket e-Document has been designed to support the majority of data fields in use today by the large wood-buying entities.

The Scope of ScaleTicket e-Document

The ScaleTicket e-Document must include:

ScaleTicket

papiNet Standard - Version 2.31

- Buyer Party (Sender) and Supplier Party (Receiver)
- Context of the data in the e-Document, i.e. purpose: original, changed, cancellation, replace
- Business type for the report, i.e. Timber, Recycling, Pulp, or Containerboard
- Product for which the data applies
- Scale data, Gross Weight and Net Weight or Volume

The ScaleTicket e-Document can include:

- Additional parties to the transaction
- Transport information including truck or rail car identification
- Information about the wood type, quality, age, grade, and wood culled from the load.

ScaleTicketAcceptance [attribute]

Defines the state of the goods received as compared to the DeliveryMessage specifications. The enumeration list is the list of choices that apply to the Goods Receipt header and line item.

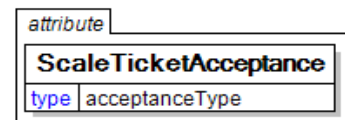

This item is restricted to the following list.

GoodsReceivedAsIs

The delivered goods were received without inspection, or checking of the goods for damage, or accuracy against the DeliveryMessage.

GoodsReceivedAsSpecified

Received goods agree completely with all DeliveryMessage specifications for all lines including item identifiers and item weights. There is no transit damage.

GoodsReceivedCancelled

Received goods notification is being cancelled. This value is only used when the GoodsReceiptStatusType is "Cancelled".

GoodsReceivedRejected

Received goods agree completely with all DeliveryMessage specifications for all lines including item identifiers and item weights; but there has been transit damage resulting in rejection of all goods.

GoodsReceivedWithDamage

Received goods agree completely with all DeliveryMessage specifications for all lines including item identifiers and item weights; but there has been transit damage of some items. All transit damages must be specified.

GoodsReceivedWithVariance

Received goods do not agree completely with the DeliveryMessage specifications. For those items at variance, actual received item identifiers and item weights must be specified.

Additionally, used with the VarianceType of "NotReceived" to indicate items that were on the DeliveryMessage but not in the Delivery as received.

ScaleTicket

papiNet Standard - Version 2.31

GoodsReceivedWithVarianceAndDamage

Received goods do not agree completely with all DeliveryMessage specifications for all lines including item identifiers and item weights and there has been transit damage of some items. For those items at variance or with transit damage, actual received item identifiers, item weights, and transit damages must be specified.

ScaleTicketRejectedType [attribute]

ScaleTicketRejectedType

This item is restricted to the following list.

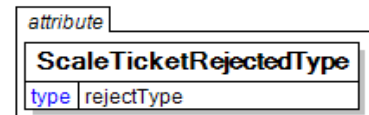

ExcessiveTransitDamage

The item(s) is/are damaged beyond acceptable use during transit.

ProductQuality

The delivery did not match the quality of the product ordered or requested.

TooEarly

The delivery has occurred prior to the agreed delivery date/time. For example, there is insufficient storage at the delivered time.

TooLate

The delivery has occurred after the agreed delivery date/time. For example, delivered after press date.

UnableToUnload

The delivered items cannot be unloaded. For example, damaged vehicle doors, load has shifted during transportation, or ShipTo requires reels to be palletised but they are delivered on the vehicle floor.

WrongBarCode

The barcode used to identify the product is incorrect.

WrongBasisWeight

The basis weight of the product is not what was ordered.

WrongDeliveryLocation

The product was delivered to the wrong location.

WrongDiameter

The diameter delivered is unusable. For example, a physical limitation on a reel stand is exceeded.

WrongLabel

The delivered item has incorrect or missing information, or incorrect label stock that would prevent its use. For example, insufficient peel-off barcode labels.

WrongProduct

The delivered item was not the product ordered or requested.

ScaleTicket

papiNet Standard - Version 2.31

WrongReelWidth

The width of the reel is incorrect.

WrongVehicleType

The items have been delivered in a vehicle that cannot be unloaded at the ShipTo facility. For example, the ShipTo requires side unloading vehicles, but the delivery vehicle can only be unloaded from the rear.

WrongWrap

The delivered item is wrapped in material that will prevent its use. For example, a hole is not present in the end cap for vacuum lifting.

Business Rules for ScaleTicket

General Business Rules

The following table lists the business rules that apply to the ScaleTicket e-Document.

Identifier	Business Rule
ST001	This e-Document is sent to communicate received weight information back to the Seller from the Buyer.
ST002	There is no expected response e-Document to the ScaleTicket e-Document.
ST003	ScaleTicketReference includes a Load ID Number
ST004	BuyerParty-contains the information for the party purchasing the goods.
ST005	SupplierParty-identifies the party selling the goods.
ST006	DeliveryInfo-contains information regarding Transport
ST007	Product contains information regarding the Load.
ST008	InformationalQuantity – contains Gross Weight, Culled Weight, and Net Weight

Processing the ScaleTicket e-Document

The ScaleTicket e-Document has an attribute (Purpose) to indicate if the e-Document is original, changed, cancellation or replaced ticket.

The ScaleTicket e-Document does not contain a TransactionHistoryNumber element as other e-Documents do. The purpose of this element was to ensure the transactions were processed in the correct order, and identify that an e-Document may be missing. In the case of the ScaleTicket e-Document, the order of processing is not relevant. ScaleTicket e-

ScaleTicket

papiNet Standard - Version 2.31

Document types of Original are independent of each other.

However, should a changed e-Document arrive before an original, it is safe to process the changed (pretending it is original) provided subsequent e-Documents referring to the same e-Document number are discarded if they have an older ScaleTicketIssueDate.

Status Values Used When Processing the ScaleTicket e-Document

e-Document processing depends on the value in the ScaleTicketStatusType field at the e-Document level. The e-Document can be sent with one of five values in the status field.

The ScaleTicket Status types used when processing the ScaleTicket e-Document are:

- Original – Indicates that this is the first transmission of the e-Document.
- Change – Indicates that the sender of the e-Document wishes to change a previously sent e-Document. The previous e-Document is identified using ScaleTicketReference of OriginalScaleTicketNumber.
- Cancellation – Indicates that the sender of the Original e-Document wishes to cancel a previously sent e-Document. The previous e-Document is identified using a ScaleTicketReference of OriginalScaleTicketNumber.
- Replace – This ScaleTicket is to replace the ScaleTicket identified in the ScaleTicketReference of OriginalScaleTicketNumber field.

No special status values or e-Documents are used to communicate acceptance of the ScaleTicket e-Document. This would normally be done using a BusinessAcknowledgement e-Document.

Understanding the Diagrams and Content

This section provides a graphical view of the schema structures, a discussion of the item's children. You can find additional information about papiNet and the standard at www.papiNet.org.

The graphics contain content model indicators, cardinality indicators, and data type information.

Associated with each graphic are the definitions for the parent item and any associated child items. All attributes are listed first, followed by the elements.

The following information should help you interpret and understand this standard. Please note the following:

- Content Model and Cardinality operate together to determine if the element or attribute are required in the instance document.
- The same attribute can never appear multiple times in the same element so, you will never see a multiple cardinality indicator.

Content model indicators:

There are three possible types of content: "sequence", "choice", and "all". The papiNet standard currently does not use the "all" construct.

- (sequence)

ScaleTicket

papiNet Standard - Version 2.31

The sequence of the items to the right of the graphic (or below the text) is required.

- (choice)

A choice of the items to the right of the graphic (or below the text) is permitted.

- (all)

All the items to the right of the graphic are required.

Cardinality indicators:

- Dotted line around element or attribute.

A single instance of the item can optionally exist.

- Dotted line around item with range indicated below.

Multiple instances of the item can optionally exist.

- Solid line around item.

A single instance of the item must exist.

- Solid line around item with range indicated below

At least one instance must exist; multiple instances can optionally exist.

Datatype indication:

When a data type is assigned to an element (either a simple type or complex type) the name of the data type is presented beneath the item name in the graphic.

- In some cases additional information about the data type is presented (the default value).

Elements can either have content that is textual/numeric in nature or content that is made up of additional elements and/or attributes.

- When the content is textual/numeric in nature "three straight horizontal lines" will appear in the upper left-hand corner of the graphic. Pay attention to these elements because they are where you will be entering your information.
- When the content is made up of additional elements and/or attributes a "gray-box" will appear on the right-hand side of the graphic.
- If the graphic shows both the horizontal lines and the gray-box then, in the papiNet standard, the content below the element are attributes.

ScaleTicket

papiNet Standard - Version 2.31

ScaleTicket Root Element

ScaleTicket

The ScaleTicket element is the root element for the ScaleTicket e-Document.

The ScaleTicket e-Document provides wood or fibre suppliers with a means to electronically incorporate scale system receiving data into their accounting systems from buying entities' back office systems.

ScaleTicketStatusType [attribute]

ScaleTicketStatusType is mandatory. A single instance is required.

ScaleTicket Status Type

This item is restricted to the following list.

Amended

The supplied information is changed.

Cancelled

The supplied information is cancelled. Items that have been cancelled are not included in totals on the summary levels of the e-Document.

Original

The supplied information is the first version of that information.

Replaced

The supplied information is replacing earlier supplied information. The receiver should revalidate the information in their system based upon the entire information received.

ScaleTicketRejectedType [attribute]

ScaleTicketRejectedType is optional. A single instance might exist.

ScaleTicketRejectedType

This item is restricted to the following list.

ExcessiveTransitDamage

The item(s) is/are damaged beyond acceptable use during transit.

ProductQuality

The delivery did not match the quality of the product ordered or requested.

TooEarly

The delivery has occurred prior to the agreed delivery date/time. For example, there is insufficient storage at the delivered time.

TooLate

The delivery has occurred after the agreed delivery date/time. For example, delivered after press date.

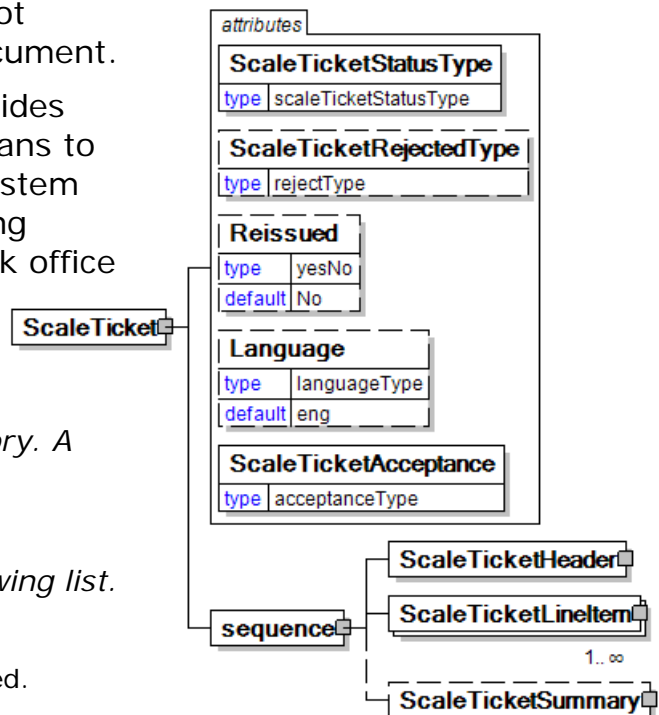

ScaleTicket

papiNet Standard - Version 2.31

UnableToUnload

The delivered items cannot be unloaded. For example, damaged vehicle doors, load has shifted during transportation, or ShipTo requires reels to be palletised but they are delivered on the vehicle floor.

WrongBarCode

The barcode used to identify the product is incorrect.

WrongBasisWeight

The basis weight of the product is not what was ordered.

WrongDeliveryLocation

The product was delivered to the wrong location.

WrongDiameter

The diameter delivered is unusable. For example, a physical limitation on a reel stand is exceeded.

WrongLabel

The delivered item has incorrect or missing information, or incorrect label stock that would prevent its use. For example, insufficient peel-off barcode labels.

WrongProduct

The delivered item was not the product ordered or requested.

WrongReelWidth

The width of the reel is incorrect.

WrongVehicleType

The items have been delivered in a vehicle that cannot be unloaded at the ShipTo facility. For example, the ShipTo requires side unloading vehicles, but the delivery vehicle can only be unloaded from the rear.

WrongWrap

The delivered item is wrapped in material that will prevent its use. For example, a hole is not present in the end cap for vacuum lifting.

Reissued [attribute]

Reissued is optional. A single instance might exist.

Either "Yes" or "No".

This item is restricted to the following list.

Yes

No

Language [attribute]

Language is optional. A single instance might exist.

The valid Alpha 2- and Alpha 3-character list of language codes in the ISO 639-1 and 639-2 international standards.

Information on the content of this attribute is available at:
https://www.loc.gov/standards/iso639-2/php/code_list.php

ScaleTicketAcceptance [attribute]

ScaleTicketAcceptance is mandatory. A single instance is required.

ScaleTicket

papiNet Standard - Version 2.31

Defines the state of the goods received as compared to the DeliveryMessage specifications. The enumeration list is the list of choices that apply to the Goods Receipt header and line item.

This item is restricted to the following list.

GoodsReceivedAsIs

The delivered goods were received without inspection, or checking of the goods for damage, or accuracy against the DeliveryMessage.

GoodsReceivedAsSpecified

Received goods agree completely with all DeliveryMessage specifications for all lines including item identifiers and item weights. There is no transit damage.

GoodsReceivedCancelled

Received goods notification is being cancelled. This value is only used when the GoodsReceiptStatusType is "Cancelled".

GoodsReceivedRejected

Received goods agree completely with all DeliveryMessage specifications for all lines including item identifiers and item weights; but there has been transit damage resulting in rejection of all goods.

GoodsReceivedWithDamage

Received goods agree completely with all DeliveryMessage specifications for all lines including item identifiers and item weights; but there has been transit damage of some items. All transit damages must be specified.

GoodsReceivedWithVariance

Received goods do not agree completely with the DeliveryMessage specifications. For those items at variance, actual received item identifiers and item weights must be specified.

Additionally, used with the VarianceType of "NotReceived" to indicate items that were on the DeliveryMessage but not in the Delivery as received.

GoodsReceivedWithVarianceAndDamage

Received goods do not agree completely with all DeliveryMessage specifications for all lines including item identifiers and item weights and there has been transit damage of some items. For those items at variance or with transit damage, actual received item identifiers, item weights, and transit damages must be specified.

(sequence)

The contents of (sequence) are mandatory. A single instance is required.

ScaleTicketHeader

ScaleTicketHeader is mandatory. A single instance is required.

Information that is common for the ScaleTicket e-Document.

ScaleTicketLineItem

ScaleTicketLineItem is mandatory. One instance is required, multiple instances might exist.

The details for each item reported on a ScaleTicket e-Document.

ScaleTicketSummary

ScaleTicketSummary is optional. A single instance might exist.

Summary information for the ScaleTicket e-Document.

ScaleTicket
papiNet Standard - Version 2.31

ScaleTicket

papiNet Standard - Version 2.31

Primary Elements

ScaleTicketHeader

Information that is common for the ScaleTicket e-Document.

(sequence)

The sequence of items below is mandatory. A single instance is required.

ScaleTicketNumber

ScaleTicketNumber is mandatory. A single instance is required.

Unique identifier for the ScaleTicket e-Document.

TransactionHistoryNumber

TransactionHistoryNumber is mandatory. A single instance is required.

A sequential number that keeps track of the version of a document being sent by the document originator. However when the document is a confirmation document, in which case the

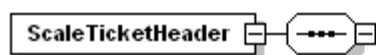

TransactionHistoryNumber refers to the trigger transaction for which the confirmation is being sent.

ScaleTicketIssueDate

ScaleTicketIssueDate is mandatory. A single instance is required.

The date and time when the ScaleTicket was issued.

ScaleTicketReference

ScaleTicketReference is optional. Multiple instances might exist.

An element that details the relevant references pertaining to the ScaleTicket.

- Identifies the previous unique document ID that this document replaces, if applicable.
- Mandatory if Purpose = Replace.

ScaleHouseInfo

ScaleHouseInfo is mandatory. A single instance is required.

Scale house information.

BuyerParty

BuyerParty is mandatory. A single instance is required.

The legal entity to which the product is sold. Also commonly referred to as the sold-to party or customer. If no OtherParty is defined as the Payer, the Buyer is the Payer.

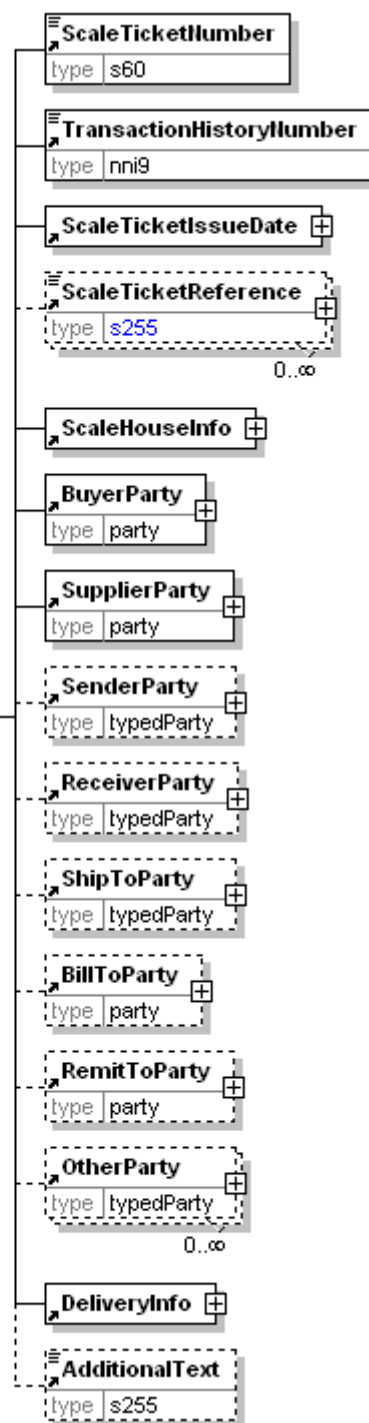

ScaleTicket

papiNet Standard - Version 2.31

SupplierParty

SupplierParty is mandatory. A single instance is required.

The organisation or business entity responsible for providing the product. SupplierParty is also the seller of the product, if Seller is not specified as OtherParty = Seller.

SenderParty

SenderParty is optional. A single instance might exist.

The business entity issuing the business document, the source of the document.

- The entity responsible for the content. If the sender party has out sourced the message service to a third party the SenderParty is the issuer of the e-Document and not the party performing the transmission service of the electronic message.

ReceiverParty

ReceiverParty is optional. A single instance might exist.

The business entity for whom the business document is intended, the destination of the document.

- The entity interested in the content. If the receiver party has outsourced the message service to a third party the ReceiverParty is the intended party for the e-Document and not the party performing the receiving service of the electronic message.

ShipToParty

ShipToParty is optional. A single instance might exist.

The name and/or address to which the goods should be delivered with the party type indicated by the PartyType attribute.

BillToParty

BillToParty is optional. A single instance might exist.

The address where the invoice is to be sent.

RemitToParty

RemitToParty is optional. A single instance might exist.

A group item containing details of the party to whom payment will be made. The RemitToParty contains all information related to remittance.

OtherParty

OtherParty is optional. Multiple instances might exist.

An organisation or business entity other than those specifically detailed within a business document.

DeliveryInfo

DeliveryInfo is mandatory. A single instance is required.

Information about the delivery.

AdditionalText

AdditionalText is optional. A single instance might exist.

A text field that is used to communicate information not previously defined or for special instructions. To be used only for circumstances not covered by specific elements.

ScaleTicket

papiNet Standard - Version 2.31

ScaleTicketLineItem

The details for each item reported on a ScaleTicket e-Document.

ScaleTicketRejectedType [attribute]

ScaleTicketRejectedType is optional. A single instance might exist.

ScaleTicketRejectedType

This item is restricted to the following list.

ExcessiveTransitDamage

The item(s) is/are damaged beyond acceptable use during transit.

ProductQuality

The delivery did not match the quality of the product ordered or requested.

TooEarly

The delivery has occurred prior to the agreed delivery date/time. For example, there is insufficient storage at the delivered time.

TooLate

The delivery has occurred after the agreed delivery date/time. For example, delivered after press date.

UnableToUnload

The delivered items cannot be unloaded. For example, damaged vehicle doors, load has shifted during transportation, or ShipTo requires reels to be palletised but they are delivered on the vehicle floor.

WrongBarcode

The barcode used to identify the product is incorrect.

WrongBasisWeight

The basis weight of the product is not what was ordered.

WrongDeliveryLocation

The product was delivered to the wrong location.

WrongDiameter

The diameter delivered is unusable. For example, a physical limitation on a reel stand is exceeded.

WrongLabel

The delivered item has incorrect or missing information, or incorrect label stock that would prevent its use. For example, insufficient peel-off barcode labels.

WrongProduct

The delivered item was not the product ordered or requested.

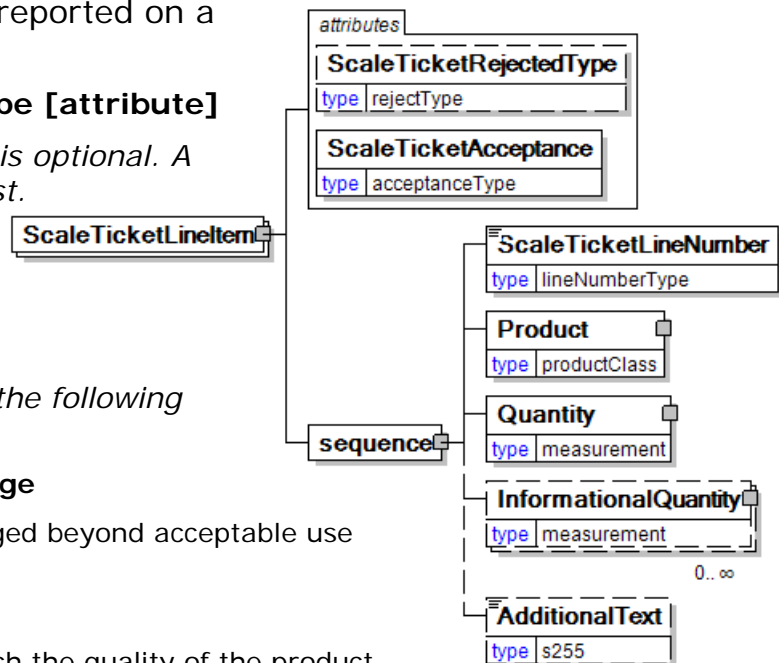

ScaleTicket

papiNet Standard - Version 2.31

WrongReelWidth

The width of the reel is incorrect.

WrongVehicleType

The items have been delivered in a vehicle that cannot be unloaded at the ShipTo facility. For example, the ShipTo requires side unloading vehicles, but the delivery vehicle can only be unloaded from the rear.

WrongWrap

The delivered item is wrapped in material that will prevent its use. For example, a hole is not present in the end cap for vacuum lifting.

ScaleTicketAcceptance [attribute]

ScaleTicketAcceptance is mandatory. A single instance is required.

Defines the state of the goods received as compared to the DeliveryMessage specifications. The enumeration list is the list of choices that apply to the Goods Receipt header and line item.

This item is restricted to the following list.

GoodsReceivedAsIs

The delivered goods were received without inspection, or checking of the goods for damage, or accuracy against the DeliveryMessage.

GoodsReceivedAsSpecified

Received goods agree completely with all DeliveryMessage specifications for all lines including item identifiers and item weights. There is no transit damage.

GoodsReceivedCancelled

Received goods notification is being cancelled. This value is only used when the GoodsReceiptStatusType is "Cancelled".

GoodsReceivedRejected

Received goods agree completely with all DeliveryMessage specifications for all lines including item identifiers and item weights; but there has been transit damage resulting in rejection of all goods.

GoodsReceivedWithDamage

Received goods agree completely with all DeliveryMessage specifications for all lines including item identifiers and item weights; but there has been transit damage of some items. All transit damages must be specified.

GoodsReceivedWithVariance

Received goods do not agree completely with the DeliveryMessage specifications. For those items at variance, actual received item identifiers and item weights must be specified.

Additionally, used with the VarianceType of "NotReceived" to indicate items that were on the DeliveryMessage but not in the Delivery as received.

GoodsReceivedWithVarianceAndDamage

Received goods do not agree completely with all DeliveryMessage specifications for all lines including item identifiers and item weights and there has been transit damage of some items. For those items at variance or with transit damage, actual received item identifiers, item weights, and transit damages must be specified.

(sequence)

ScaleTicket

papiNet Standard - Version 2.31

The contents of (sequence) are mandatory. A single instance is required.

ScaleTicketLineNumber

ScaleTicketLineNumber is mandatory. A single instance is required.

ScaleTicket Line Number

Product

Product is mandatory. A single instance is required.

Product is a group item defining the article and its characteristics. Product is used to specify product characteristics organized by ProductIdentifier, ProductDescription, and Classification. Book Manufacturing, Label Stock, Paper, Pulp, Recovered Paper, Wood Products, and Virgin Fibre market segments have defined their product characteristics and conversion features for implementation in papiNet.

Quantity

Quantity is mandatory. A single instance is required.

The Quantity element contains attributes that provide information about the type of quantity that is being communicated, the context in which the particular quantity is to be viewed, and (if the quantity represents an adjustment) an adjustment type.

The Quantity element contains three child elements that enable you to communicate a range of values for the quantity and a target or actual value. It is at this level (Value, RangeMin, and RangeMax) that the unit of measure is specified. This permits the range to be specified in a different unit of measure than the target.

InformationalQuantity

InformationalQuantity is optional. Multiple instances might exist.

A quantity given in a valid UOM used for information purposes only (not for calculation). For example, an ordered quantity was 100 reels as opposed to the invoice quantity of 20,000 pounds.

AdditionalText

AdditionalText is optional. A single instance might exist.

A text field that is used to communicate information not previously defined or for special instructions. To be used only for circumstances not covered by specific elements.

ScaleTicketSummary

Summary information for the ScaleTicket e-Document.

(sequence)

The



contents of (sequence) are mandatory. A single instance is required.

TotalNumberOfLineItems

TotalNumberOfLineItems is optional. A

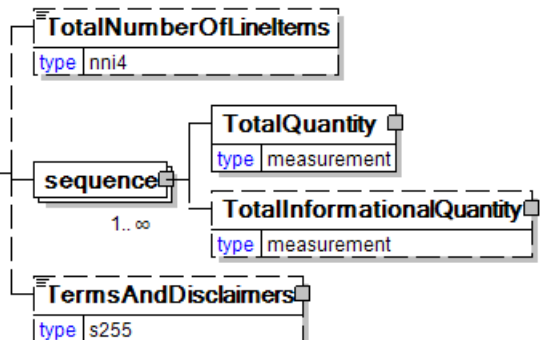

ScaleTicket

papiNet Standard - Version 2.31

single instance might exist.

The total number of individual line items in the document, regardless of the status or type.

(sequence)

The contents of (sequence) are mandatory. One instance is required, multiple instances might exist.

TotalQuantity

TotalQuantity is mandatory. A single instance is required.

The total quantity of similar items in the business document. TotalQuantity is primarily used in the summary section of documents where it is repeatable to permit totaling for different units of measure.

TotalInformationalQuantity

TotalInformationalQuantity is optional. A single instance might exist.

A quantity that is used to communicate related information about the parent element. This element represents a total that is derived from individual line items.

TermsAndDisclaimers

TermsAndDisclaimers is optional. A single instance might exist.

An element that contains legal information with an indication of what the Language is.

ScaleTicket
papiNet Standard - Version 2.31

ScaleTicket Business Scenarios

ScaleTicket Scenario Listing

Scenario A	Buyer communicate received weight information back to Seller
-------------------	--

Scenario A

e-Document	ScaleTicket
Type	Original
Scenario	Buyer communicate received weight information back to Seller
Outcome	Buyer's ScaleTicket Info is transmitted to Seller
Initiator	Buyer
Receiver	Seller
XML File	ScaleTicket_ScenarioA.xml
Preconditions	This Use Case assumes the Customer and Supplier have previously agreed the context and content of the e-Document. That is, context of the data is for a single load received by the Buyer; content includes business agreement information, transport information, product information including quality, grade, and type of wood, scale weight on arrival and departure of the transport vehicle, and the net weight.
Trigger	A shipment of timber arrives at a mill.
Step 1.	Buyer sends ScaleTicket e-Document to Seller. Attributes sent within the e-Document: <ul style="list-style-type: none"> • ScaleTicketStatusType = "Original" • Weight on delivery of 102,420 pounds. • Weight on departure of 0 pounds. Thus the weighing was done on the actual load, as opposed to being weighed with the truck. • Note that the shipment was overweight. • Product identification that the delivery includes 1 line item, of a grade code "46" for Hardwood logs. • The supplier (logger) has identified the shipment as number 104 and has marked the logs accordingly. There are 27 logs

ScaleTicket
papiNet Standard - Version 2.31

	<p>included in this</p> <ul style="list-style-type: none">• The gross weight of the logs delivered was 102,420 pounds.• The mill culled 2,000 pounds from the delivery as being unusable.• The net weight of the delivery is 100,420 pounds.
Step 2.	Seller processes the data contained in the e-Document into its information systems.