



papiNet

Preflight

papiNet Standard - Version 2.31

Documentation

**Global Standard for the Paper and Forest
Products Supply Chain**

Build V2R31_20220323

Date 2022-04-27

Production Release

Preflight

papiNet Standard – Version 2.31

Copyright

Copyright 2000 - 2022 papiNet G.I.E ("papiNet") and International Digital Enterprise Alliance, Inc. ("IDEAlliance") collectively "Copyright Owner". All rights reserved by the Copyright Owner under the laws of the United States, Belgium, the European Economic Community, and all states, domestic and foreign. This document may be downloaded and copied provided that all copies retain and display the copyright and any other proprietary notices contained in this document. This document may not be sold, modified, edited, or taken out of context such that it creates a false or misleading statement or impression as to the purpose or use of the papiNet specification, which is an open standard. Use of this Standard, in accord with the foregoing limited permission, shall not create for the user any rights in or to the copyright, which rights are exclusively reserved to the Copyright Owner.

papiNet, IDEAlliance, and the members of all papiNet Groups (collectively and individually, "Presenters") make no representations or warranties, express or implied, including, but not limited to, warranties of merchantability, fitness for a particular purpose, title, or non-infringement. The presenters do not make any representation or warranty that the contents of this document are free from error, suitable for any purpose of any user, or that implementation of such contents will not infringe any third party patents, copyrights, trademarks or other rights. By making use of this document, the user assumes all risks and waives all claims against Presenters.

In no event shall Presenters be liable to user (or other person) for direct, indirect, special or consequential damages arising from or related to any use of this document, including, without limitation, lost profits, business interruption, loss of programs, or other data on your information handling system even if Presenters are expressly advised of the possibility of such damages.

Use of Documents in papiNet Implementations

Documents may be used as templates for a papiNet implementation. The Presenters grant the right to modify and edit them to fit an actual implementation project provided all copies display the copyright and any other proprietary notices contained in this document. Such modified documents must not be distributed beyond the trading partners implementing or maintaining a papiNet connection.

Preflight

papiNet Standard – Version 2.31

Table of Contents

Copyright	2
Use of Documents in papiNet Implementations	2
Table of Contents	3
Preflight Documentation	4
Preflight e-Document Overview	4
The Scope of the Preflight	4
Business Rules for Preflight	5
Processing the Preflight	6
Understanding the Diagrams and Content	6
Preflight Root Element	8
Preflight	8
Primary Elements	10
PreflightHeader	10
PreflightByPrepContentFile	11
PreflightByProduct	12
PreflightByPurchaseOrder	13
Preflight Business Scenarios.....	15
Preflight Scenario Listing	15
Scenario A.....	17
Scenario B.....	18
Scenario C.....	21
Scenario D	21
Scenario E.....	22

Preflight

papiNet Standard – Version 2.31

Preflight Documentation

Preflight e-Document Overview

The Preflight e-Document permits the sender to report the status of prep content files separately, by product or by Purchase Order or to report status of multiple files based upon some specified criteria. The e-Document enables the sender to indicate a primary status as well as an additional secondary status as needed.

Prior to implementing a Preflight e-Document it is assumed that the parties involved have already opened a trading partner relationship and a collaborative agreement has been reached. Such an agreement might include frequency of communication, content details, etc.

A trading partner sends a Preflight e-Document to another trading partner based on a schedule or on an event basis agreed between them. Events that can trigger a Preflight e-Document would be the receipt of content files accompanied by the BookSpecification e-Document that contains the file metadata, different stages of preflight processing or the receipt of an InfoRequest e-Document.

The Scope of the Preflight

The Preflight e-Document includes:

- A specific Preflight number and date upon which the Preflight is generated.
- SenderParty, ReceiverParty and BuyerParty.
- One of three different detail formats which can have multiple occurrences but cannot be mixed in the same e-Document.
 - ByPrepContentFile
 - File Name and status information.
 - ByProduct
 - Product identification.
 - Status information either at the product level or at the individual prep content file level.
 - ByPurchaseOrder
 - Purchase Order Number.
 - Status information either at the order level or at the individual prep content file level.
- Status information consists of either a PrimaryStatus or by individual prep content file level for each respective detail level.

The Preflight e-Document may include:

- The Request Number from an InfoRequest.
- Additional information within the detail formats.
 - References such as ISBN10, ISBN13.
 - SupplierParty that could be different from the SupplierParty in the Preflight Header such as a compositor or different supplier locations.
 - Specific time period as agreed upon by trading partners or in response to an InfoRequest e-Document.
 - Price details such as the cover price for cover or jacket components.
 - Product information associated with the prep content file for the

Preflight

papiNet Standard – Version 2.31

ByPrepContentFile and ByPurchaseOrder formats.

Business Rules for Preflight

General Business Rules

Identifier	Business Rule
PF001	<p>Trading Partners will need to decide what type or types of Preflight status will be communicated which can be dependent on different workflow scenarios:</p> <p>PreflightByProduct includes the status for all prep content files by product regardless of receipt date unless constrained by a preceding InfoRequest.</p> <p>PreflightByPurchaseOrder includes the status for all prep content files for each product in the Purchase order unless constrained by a preceding InfoRequest.</p> <p>PreflightByPrepContentFile includes the status for all prep content files determined by trading partner agreement unless constrained by a preceding InfoRequest.</p>
PF002	<p>If the Preflight e-Document is in response to an InfoRequest e-Document, the RequestNumber must be included and reflect the RequestNumber of the InfoRequest.</p>
PF003	<p>If the InfoRequest e-Document indicates a PreflightRequestDetailType of "ByPrepContentFile", then the PreflightContentType must be "PreflightByPrepContentFile". Similarly for InfoRequest PreflightRequestDetailType of "ByProduct" and "ByPurchaseOrder" the PreflightContentType must be of "PreflightByProduct" and "PreflightByPurchaseOrder" respectively.</p>

Preflight papiNet Standard – Version 2.31

Identifier	Business Rule
PF004	<p>If the InfoRequest e-Document PreflightRequestDetail specifies a specific time period, then the Preflight e-Document must include the status of all prep content files received during that period depending on the type of detail requested.</p> <p>Example would be if the InfoRequest is ByProduct, then the Preflight response would include status for all files for each product received within the specified time period.</p>

Processing the Preflight

Preflight e-Document is the proper response to the receipt and preflighting of prep content files which are usually accompanied by the BookSpecification e-Document that contains the metadata required for preflighting. It may also be published on a previously agreed upon schedule based on time intervals or different preflight stages. The Preflight e-Document can also serve as a response to an InfoRequest e-Document containing an InfoRequestType of "Preflight".

There are different order workflows that can be supported with the Preflight processing:

- Prep content files, BookSpecification and PurchaseOrder e-Documents can be received at the same time which is when the PreflightByPurchaseOrder type would be used to report the status of the prep content files.
- Prep content files and the BookSpecification e-Document are received prior to the release of any purchase orders which would require the receipt and Processing of the Preflight e-Document by the recipient before generation of Purchase Orders could ensue; the Preflight type used would be PreflightByProduct.

The Preflight e-Document is an information-only e-Document. It does not alter the legal agreement between the parties regarding the order submission and fulfilment. If the Preflight e-Document indicates a serious problem or issue with the ability of the supplier to preflight the prep content files, then the parties involved must resolve the issue-

Understanding the Diagrams and Content

This section provides a graphical view of the schema structures, a discussion of the item's children. You can find additional information about papiNet and the standard at www.papiNet.org.

The graphics contain content model indicators, cardinality indicators, and

Preflight

papiNet Standard – Version 2.31

data type information.

Associated with each graphic are the definitions for the parent item and any associated child items. All attributes are listed first, followed by the elements.

The following information should help you interpret and understand this standard. Please note the following:

- Content Model and Cardinality operate together to determine if the element or attribute are required in the instance document.
- The same attribute can never appear multiple times in the same element so, you will never see a multiple cardinality indicator.

Content model indicators:

There are three possible types of content: "sequence", "choice", and "all". The papiNet standard currently does not use the "all" construct.

- (sequence)
The sequence of the items to the right of the graphic (or below the text) is required.
- (choice)
A choice of the items to the right of the graphic (or below the text) is permitted.
- (all)
All the items to the right of the graphic are required.

Cardinality indicators:

- Dotted line around element or attribute.
A single instance of the item can optionally exist.
- Dotted line around item with range indicated below.
Multiple instances of the item can optionally exist.
- Solid line around item.
A single instance of the item must exist.
- Solid line around item with range indicated below
At least one instance must exist; multiple instances can optionally exist.

Datatype indication:

When a data type is assigned to an element (either a simple type or complex type the name of the data type is presented beneath the item name in the graphic.

- In some cases additional information about the data type is presented (the default value).

Elements can either have content that is textual/numeric in nature or content that is made up of additional elements and/or attributes.

- When the content is textual/numeric in nature "three straight horizontal lines" will appear in the upper left-hand corner of the graphic. Pay attention to these elements because they are where you will be entering your information.
- When the content is made up of additional elements and/or attributes a "gray-box" will appear on the right-hand side of the graphic.
- If the graphic shows both the horizontal lines and the gray-box then, in the papiNet standard, the content below the element are attributes.

Preflight

papiNet Standard – Version 2.31

Preflight Root Element

Preflight

The Preflight element is the root element for the Preflight e-Document.

The Preflight e-Document reports the status of prep content files separately, by product or by Purchase Order or to report status of multiple files based upon some specified criteria. The e-Document enables the sender to indicate a primary status as well as an additional secondary status as needed.

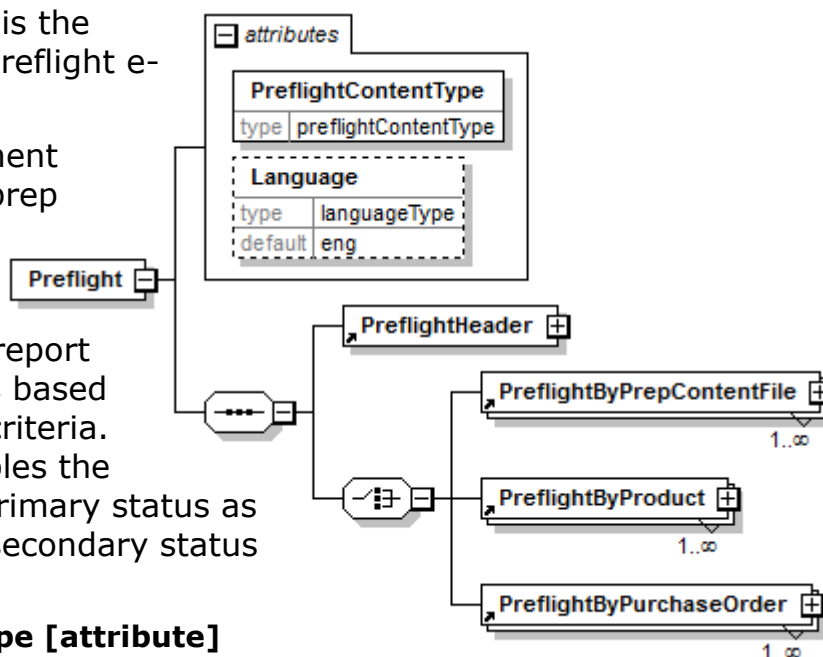

PreflightContentType [attribute]

PreflightContentType is mandatory. A single instance is required.

Communicates the method in which the Preflight detail status has been summarized.

This item is restricted to the following list.

PreflightByPrepContentFile

Indicates the Preflight status is by prep content file.

PreflightByProduct

Indicates the Preflight status is by product.

PreflightByPurchaseOrder

Indicates the Preflight status is by purchase order.

Language [attribute]

Language is optional. A single instance might exist.

The valid Alpha 2- and Alpha 3-character list of language codes in the ISO 639-1 and 639-2 international standards.

Information on the content of this attribute is available at:
https://www.loc.gov/standards/iso639-2/php/code_list.php

(sequence)

The sequence of items below is mandatory. A single instance is required.

PreflightHeader

PreflightHeader is mandatory. A single instance is required.

Information that applies to the entire Preflight e-Document.

(choice)

Preflight

papiNet Standard – Version 2.31

[choice] is mandatory. A single instance is required.

PreflightByPrepContentFile

PreflightByPrepContentFile is mandatory. One instance is required, multiple instances might exist.

A grouping element that contains information about the Preflight status by prep content file.

PreflightByProduct

PreflightByProduct is mandatory. One instance is required, multiple instances might exist.

A grouping element that contains information about the Preflight status by product.

PreflightByPurchaseOrder

PreflightByPurchaseOrder is mandatory. One instance is required, multiple instances might exist.

A grouping element that contains information about the Preflight status by purchase order.

Preflight

papiNet Standard – Version 2.31

Primary Elements

PreflightHeader

Information that applies to the entire Preflight e-Document.

(sequence)

The sequence of items below is mandatory. A single instance is required.

PreflightNumber

PreflightNumber is mandatory. A single instance is required.

The unique identifier for the Preflight e-Document.

PreflightIssueDate

PreflightIssueDate is mandatory. A single instance is required.

The date and time when the Preflight e-Document was issued.

RequestNumber

RequestNumber is optional. A single instance might exist.

A unique tracking number specifically identifying the InfoRequest e-Document to the originator. The tracking number is returned with the "information", the answer, to help match the answer to the request.

SenderParty

SenderParty is optional. A single instance might exist.

The business entity issuing the e-Document, the source of the document.

- The entity responsible for the content. If the sender party has outsourced the message service to a third party the SenderParty is the issuer of the e-Document and not the party performing the transmission service of the electronic message.

ReceiverParty

ReceiverParty is optional. Multiple instances might exist.

The business entity for whom the e-Document is intended, the destination of the document.

- The entity interested in the content. If the receiver party has outsourced the message service to a third party the ReceiverParty is the intended party for the e-Document and not the party performing the receiving service of the electronic message.

BuyerParty

BuyerParty is mandatory. A single instance is required.

The legal entity to which the product is sold. Also commonly referred to as the sold-to party or customer. If no OtherParty is defined as the Payer, the Buyer is the Payer.

PreflightReference

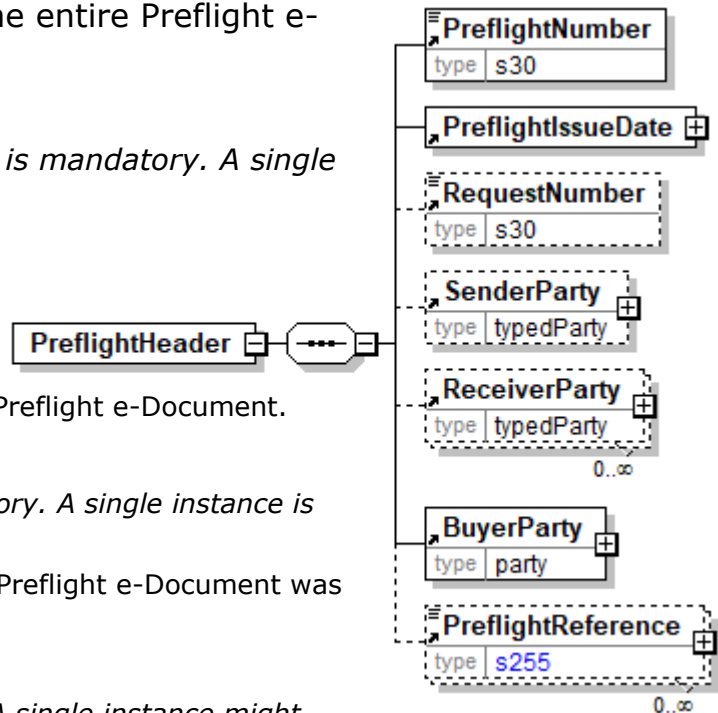

Preflight

papiNet Standard – Version 2.31

PreflightReference is optional. Multiple instances might exist.

An element detailing relevant references pertaining to the Preflight as indicated by PreflightReferenceType and AssignedBy.

PreflightByPrepContentFile

A grouping element that contains information about the Preflight status by prep content file.

(sequence)

The sequence of items below is mandatory. A single instance is required.

PrepContent

PrepContent is mandatory. A single instance is required.

A grouping element containing information about the prep content file.

PreflightReference

PreflightReference is optional. Multiple instances might exist.

An element detailing relevant references pertaining to the Preflight as indicated by PreflightReferenceType and AssignedBy.

Product

Product is optional. A single instance might exist.

Product is a group item defining the article and its characteristics. Product is used to specify product characteristics organized by ProductIdentifier, ProductDescription, and Classification. Book Manufacturing, Label Stock, Paper, Pulp, Recovered Paper, Wood Products, and Virgin Fibre market segments have defined their product characteristics and conversion features for implementation in papiNet.

SupplierParty

SupplierParty is optional. A single instance might exist.

The organisation or business entity responsible for providing the product. SupplierParty is also the seller of the product, if Seller is not specified as OtherParty = Seller.

TimePeriod

TimePeriod is optional. A single instance might exist.

The TimePeriod element is used to communicate a duration period of time as indicated in PeriodType.

PriceDetails

PriceDetails is optional. Multiple instances might exist.

An element that groups together price information.

AdditionalText

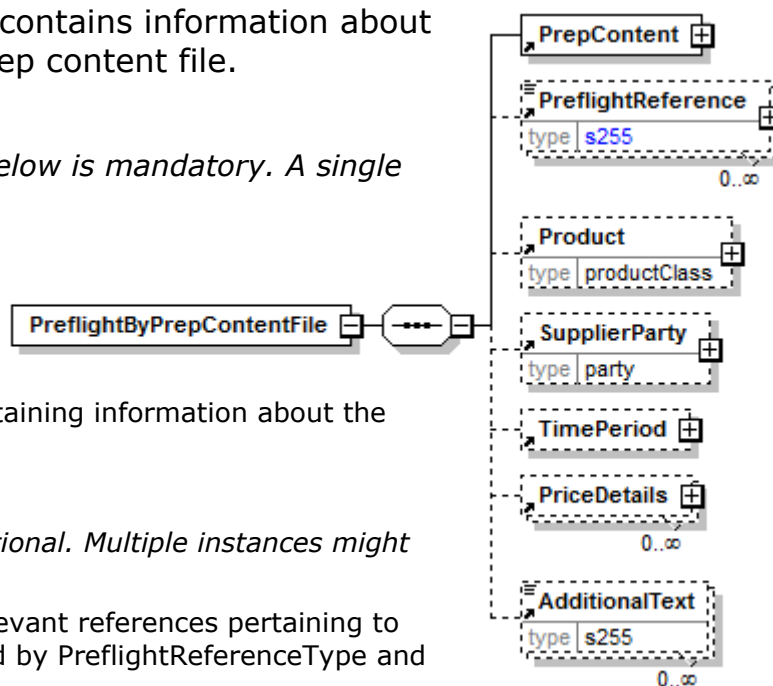

Preflight

papiNet Standard – Version 2.31

AdditionalText is optional. Multiple instances might exist.

A text field that is used to communicate information not previously defined or for special instructions. To be used only for circumstances not covered by specific elements.

PreflightByProduct

A grouping element that contains information about the Preflight status by product.

(sequence)

The sequence of items below is mandatory. A single instance is required.

Product

Product is mandatory. A single instance is required.

Product is a group item defining the article and its characteristics. Product is used to specify product characteristics organized by ProductIdentifier, ProductDescription, and Classification. Book Manufacturing, Label Stock, Paper, Pulp, Recovered Paper, Wood Products, and Virgin Fibre market segments have defined their product characteristics and conversion features for implementation in papiNet.

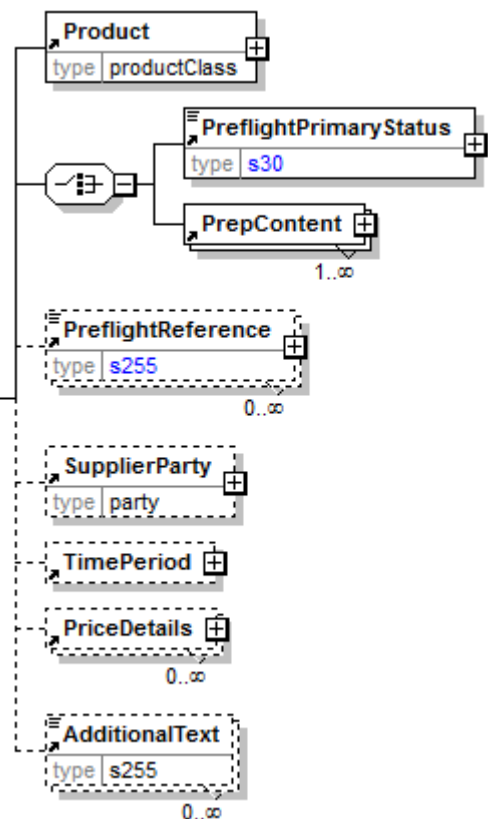
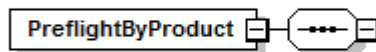

(choice)

[choice] is mandatory. A single instance is required.

PreflightPrimaryStatus

PreflightPrimaryStatus is mandatory. A single instance is required.

A description of the highest level status pertaining to the item being reported: content file, Product or Purchase Order.

PrepContent

PrepContent is mandatory. One instance is required, multiple instances might exist.

A grouping element containing information about the prep content file.

PreflightReference

PreflightReference is optional. Multiple instances might exist.

An element detailing relevant references pertaining to the Preflight as indicated by PreflightReferenceType and AssignedBy.

SupplierParty

SupplierParty is optional. A single instance might exist.

The organisation or business entity responsible for providing the product.

Preflight

papiNet Standard – Version 2.31

SupplierParty is also the seller of the product, if Seller is not specified as OtherParty = Seller.

TimePeriod

TimePeriod is optional. A single instance might exist.

The TimePeriod element is used to communicate a duration period of time as indicated in PeriodType.

PriceDetails

PriceDetails is optional. Multiple instances might exist.

An element that groups together price information.

AdditionalText

AdditionalText is optional. Multiple instances might exist.

A text field that is used to communicate information not previously defined or for special instructions. To be used only for circumstances not covered by specific elements.

PreflightByPurchaseOrder

A grouping element that contains information about the Preflight status by purchase order.

(sequence)

The sequence of items below is mandatory. A single instance is required.

PurchaseOrderInformation

PurchaseOrderInformation is mandatory. A single instance is required.

A group item containing information unique to this

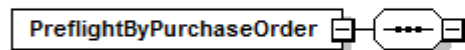

PurchaseOrder, which is provided by the buyer. PurchaseOrderInformation can be optional in the supply chain. Invoices are created without having a PurchaseOrder in Vendor Managed Inventory. Freight invoices also will not have a PurchaseOrder number.

PurchaseOrderLineItemNumber

PurchaseOrderLineItemNumber is optional. A single instance might exist.

The sequential number that uniquely identifies the PurchaseOrder line item.

(choice)

[choice] is mandatory. A single instance is required.

PreflightPrimaryStatus

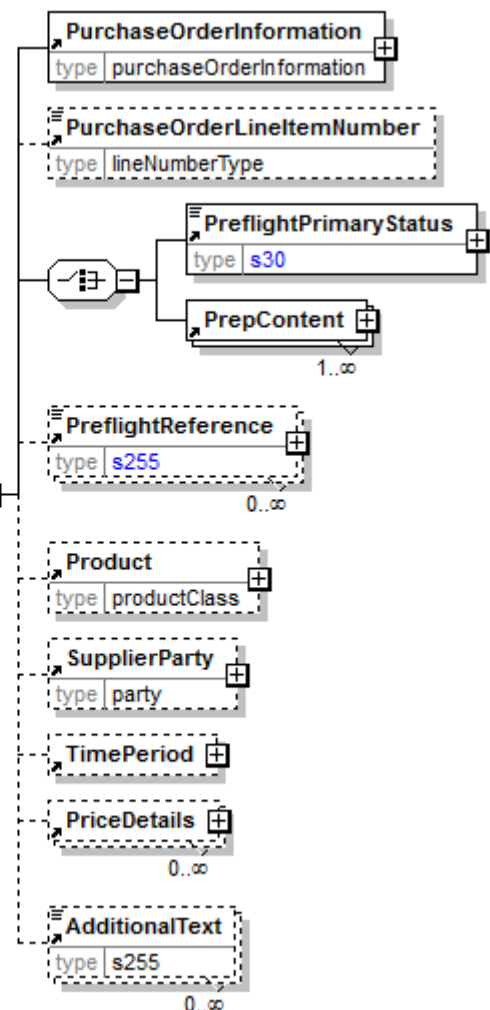

Preflight

papiNet Standard – Version 2.31

PreflightPrimaryStatus is mandatory. A single instance is required.

A description of the highest level status pertaining to the item being reported: content file, Product or Purchase Order.

PrepContent

PrepContent is mandatory. One instance is required, multiple instances might exist.

A grouping element containing information about the prep content file.

PreflightReference

PreflightReference is optional. Multiple instances might exist.

An element detailing relevant references pertaining to the Preflight as indicated by PreflightReferenceType and AssignedBy.

Product

Product is mandatory. A single instance is required.

Product is a group item defining the article and its characteristics. Product is used to specify product characteristics organized by ProductIdentifier, ProductDescription, and Classification. Book Manufacturing, Label Stock, Paper, Pulp, Recovered Paper, Wood Products, and Virgin Fibre market segments have defined their product characteristics and conversion features for implementation in papiNet.

SupplierParty

SupplierParty is optional. A single instance might exist.

The organisation or business entity responsible for providing the product. SupplierParty is also the seller of the product, if Seller is not specified as OtherParty = Seller.

TimePeriod

TimePeriod is optional. A single instance might exist.

The TimePeriod element is used to communicate a duration period of time as indicated in PeriodType.

PriceDetails

PriceDetails is optional. Multiple instances might exist.

An element that groups together price information.

AdditionalText

AdditionalText is optional. Multiple instances might exist.

A text field that is used to communicate information not previously defined or for special instructions. To be used only for circumstances not covered by specific elements.

Preflight

papiNet Standard – Version 2.31

Preflight Business Scenarios

Preflight Scenario Listing

Scenario A	Buyer/Publisher sends prep content files and the BookSpecification e-Document containing the metadata for a single book product to a Supplier. Prep content files included are for the text (interior) and cover of the book. The Preflight e-Document returned would be generated as the result of the preflight process and contain PreflightContentType and detail format of "PreflightByProduct" with status at the product level: PreflightPrimaryStatus is "ActiveFree" indicating both content files were preflighted successfully.
Scenario B	Buyer/Publisher sends prep content files and the BookSpecification e-Document containing the metadata for a single book product along with the PurchaseOrder to a Supplier. Prep content files included are for the text (interior) and cover of the book; the cover file is preflighted successfully but the text file is rejected because it does not contain the same number of pages specified in the metadata. The Preflight e-Document returned would be generated as the result of the preflight process and contain PreflightContentType and detail format of "PreflightByPurchaseOrder" with status at the prep content file level.
Scenario C	Buyer/Publisher requires a monthly status of all prep content files received during the month under a previously established trading partner agreement. The Preflight e-Document would contain PreflightContentType and detail format of "PreflightByPrepContentFile" with status at the prep content file level with various status values; all data would be from the supplier's system.

Preflight
papiNet Standard – Version 2.31

Scenario D	Buyer/Publisher sends an InfoRequest to a Supplier for the status of prep content files sent for a specific Product under a previous trading partner agreement that the detail would be at the product level; the InfoRequestType is "Preflight" and the PreflightRequestDetailType is "ByProduct". Prep content files previously preflighted are for the text (interior) and cover of the book; the text file had errors. The Preflight e-Document returned would contain PreflightContentType and detail format of "PreflightByProduct" with data from the supplier's system.
Scenario E	Buyer/Publisher sends an InfoRequest to a Supplier for the status of prep content files sent for a specific Purchase Order under a previous trading partner agreement that the detail would be at the prep content file level; the InfoRequestType is "Preflight" and the PreflightRequestDetailType is "ByPurchaseOrder". Prep content files previously preflighted are for the text (interior) and cover of the book; no errors were detected. The Preflight e-Document returned would contain PreflightContentType and detail format of "PreflightByPurchaseOrder" with data from the supplier's system.

Preflight papiNet Standard – Version 2.31

Scenario A

e-Document	Preflight
ContentType	PreflightByProduct
Scenario	Buyer/Publisher sends prep content files and the BookSpecification e-Document containing the metadata for a single book product to a Supplier. Prep content files included are for the text (interior) and cover of the book. The supplier preflights the prep content files with no errors detected.
Outcome	The Preflight e-Document is generated as the result of the supplier's preflight processing and contains PreflightContentType and detail format of "PreflightByProduct"; status is at the product level with a PreflightPrimaryStatus of "ActiveFree" indicating all content files were preflighted successfully.
Step 1	<p>Prep content files and BookSpecification e-Document are generated by the buyer and received into the supplier's system for preflighting.</p> <p>BookSpecification</p> <ul style="list-style-type: none"> • SpecType should have a value of either SpecContent or SpecOrder depending on what values will be included in the e-Document; SpecOrder should contain all data required for the prep content file processing and purchase orders but SpecContent values can be limited to just prep content file processing. • SpecificationNumber and SpecificationVersion values may need to be returned in the Preflight e-Document in support of different versions of printing requirements for a book such as different types of paper depending on type of manufacturing. • ProductIdentification in SpecGeneral must contain a value unique identifier for the book in ProductIdentifier. • A SpecComponent section must be specified for each printed book component <ul style="list-style-type: none"> • Must include a SpecReference with SpecReferenceType of "PrepContentName" containing the name of the associated prep content

Preflight papiNet Standard – Version 2.31

	<p>file.</p> <ul style="list-style-type: none"> • Additional metadata required for preflight processing must be supplied such as number of pages, number of ink colors, paper PPI, etc. (the requirements should be identified as part of the trading partner agreement).
Step 2	<p>The Preflight e-Document is generated that includes status of all files sent for the product:</p> <ul style="list-style-type: none"> • PreflightContentType = PreflightByProduct • SenderParty = Buyer/Publisher • ReceiverParty = Supplier • BuyerParty = Buyer/Publisher • Detail format = PreflightByProduct <ul style="list-style-type: none"> • ProductIdentifier = BookSpecification ProductIdentifier in SpecGeneral • PreflightPrimaryStatus = supplier description of preflight status • PreflightPrimaryStatusCode = "ActiveFree" • PreflightReference/PreflightReferenceType of SpecificationNumber = BookSpecification/SpecificationNumber • PreflightReference/PreflightReferenceType of SpecificationVersion = BookSpecification/SpecificationVersion

Scenario B

e-Document	Preflight
ContentType	PreflightByPurchaseOrder
Scenario	<p>Buyer/Publisher sends prep content files and the BookSpecification e-Document containing the content file metadata for a single book product along with the PurchaseOrder to the Supplier under a previously established trading partner agreement that the Preflight e-Document would be returned with PreflightContentType and detail level of "PreflightByPurchaseOrder". Prep content files included are for the text (interior) and cover of the book. The supplier preflights the prep content files: the cover file is preflighted successfully but the text file is rejected because it does not contain the correct number of pages according to the BookSpecification for the text SpecComponent.</p>
Outcome	The Preflight e-Document is generated as the result of

Preflight papiNet Standard – Version 2.31

	<p>the supplier's preflight processing and contains PreflightContentType and detail format of "PreflightByPurchaseOrder"; status is at the prep content file level with different status values.</p>
<p>Step 1</p>	<p>Prep content files, PurchaseOrder and BookSpecification e-Documents are generated by the buyer and received into the supplier's system for preflighting.</p> <p>PurchaseOrder</p> <p>Must include references of the associated BookSpecification in either the PurchaseOrderHeader or PurchaseOrderLineItem:</p> <ul style="list-style-type: none"> • PurchaseOrderReference with PurchaseOrderReferenceType of "SpecificationNumber" containing the value of the BookSpecification/SpecificationNumber. • PurchaseOrderReference with PurchaseOrderReferenceType of "SpecificationVersion" containing the value of the BookSpecification/SpecificationVersion. <p>BookSpecification</p> <ul style="list-style-type: none"> • SpecType should have a value of either SpecContent or SpecOrder depending on what values will be included in the e-Document; SpecOrder should contain all data required for the prep content file processing and purchase orders but SpecContent values can be limited to just prep content file processing. • SpecificationNumber and SpecificationVersion values may need to be returned in the Preflight e-Document in support of different versions of printing requirements for a book such as different types of paper depending on type of manufacturing. • ProductIdentification in SpecGeneral must contain a value unique identifier for the book in ProductIdentifier. • A SpecComponent section must be specified for each printed book component. <ul style="list-style-type: none"> • Must include a SpecReference with SpecReferenceType of "PrepContentName" containing the name of the associated prep content file.

Preflight papiNet Standard – Version 2.31

	<ul style="list-style-type: none"> • Additional metadata required for preflight processing must be supplied such as number of pages, number of ink colours, paper PPI, etc. (the requirements should be identified as part of the trading partner agreement). • SpecComponent for the text (interior) file includes page count.
Step 2	<p>The Preflight e-Document is generated that includes status of all files sent for the purchase order:</p> <ul style="list-style-type: none"> • PreflightContentType = PreflightByPurchaseOrder • SenderParty = Buyer/Publisher • ReceiverParty = Supplier • BuyerParty = Buyer/Publisher • Detail format = PreflightByPurchaseOrder <ul style="list-style-type: none"> • PurchaseOrderNumber = PurchaseOrder/PurchaseOrderNumber • PreflightReference/PreflightReferenceType of SpecificationNumber = BookSpecification/SpecificationNumber • PreflightReference/PreflightReferenceType of SpecificationVersion = BookSpecification/SpecificationVersion <p>Status of the cover prep content file:</p> <ul style="list-style-type: none"> • PrepContentName = name of file supplied in the BookSpecification for the cover component • PreflightStatusInformation <ul style="list-style-type: none"> • PreflightPrimaryStatus = supplier description of preflight status • PreflightPrimaryStatusCode = "ActiveFree" <p>Status of the text (interior) prep content file:</p> <ul style="list-style-type: none"> • PrepContentName = name of file supplied in the BookSpecification for the text (interior) component • PreflightStatusInformation <ul style="list-style-type: none"> • PreflightPrimaryStatus = supplier description of preflight status • PreflightPrimaryStatusCode = "Rejected" • PreflightSecondaryStatusCode = supplier description of preflight status for wrong page count • PreflightSecondaryStatusCode = "Incorrect" <p>Page count values</p> <ul style="list-style-type: none"> • PageCountDetail (1) <ul style="list-style-type: none"> • Quantity = value supplied in the BookSpecification • QuantityTypeContext = "Planned" • PageCountDetail (2) <ul style="list-style-type: none"> • Quantity = number of pages in the content file • QuantityTypeContext = "Delivered"

Preflight papiNet Standard – Version 2.31

Scenario C

e-Document	Preflight
ContentType	PreflightByPrepContentFile
Scenario	Buyer/Publisher requires a monthly status of all prep content files received during the month under a previously established trading partner agreement.
Outcome	The Preflight e-Document is generated with PreflightContentType and detail format of "PreflightByPrepContentFile" with status at the prep content file level with various status values.
Process	<p>The Preflight e-Document is generated that includes status of all files according to the trading partner rules previously established; the source of all data is from the supplier's system</p> <ul style="list-style-type: none"> • PreflightContentType = PreflightByPrepContentFile • SenderParty = Buyer/Publisher • ReceiverParty = Supplier • BuyerParty = Buyer/Publisher • Detail format = PreflightByPrepContentFile <ul style="list-style-type: none"> • PrepContentName = name of file stored in the supplier's system <p>PreflightStatusInformation</p> <ul style="list-style-type: none"> • PreflightPrimaryStatus = supplier description of Primary status • PreflightPrimaryStatusCode = Primary status code • PreflightSecondaryStatusCode = supplier description of Secondary status • PreflightSecondaryStatusCode = Secondary status code <p>Page count values if applicable</p> <ul style="list-style-type: none"> • PageCountDetail (1) <ul style="list-style-type: none"> • Quantity = number of pages specified by the Buyer • QuantityTypeContext = "Planned" • PageCountDetail (2) <ul style="list-style-type: none"> • Quantity = number of pages in the content file • QuantityTypeContext = "Delivered"

Scenario D

e-Document	Preflight
ContentType	PreflightByProduct
Scenario	Buyer/Publisher sends an InfoRequest to a Supplier for the status of prep content files sent for a specific

Preflight papiNet Standard – Version 2.31

	Product under a previous trading partner agreement that the detail would be at the product level; the InfoRequestType is "Preflight" and the PreflightRequestDetailType is "ByProduct"; Prep content files previously preflighted are for the text (interior) and cover of the book; the text file had errors.
Outcome	The Preflight e-Document is generated with data from the supplier's system and contains PreflightContentType and detail format of "PreflightByProduct"; status is at the product level.
Process	<p>The Preflight e-Document is generated that includes status of all files for the product; supplier's system is the source of all data</p> <ul style="list-style-type: none"> • PreflightContentType = PreflightByProduct • SenderParty = Buyer/Publisher • ReceiverParty = Supplier • BuyerParty = Buyer/Publisher • Detail format = PreflightByProduct <ul style="list-style-type: none"> • ProductIdentifier = ProductIdentifier stored in the supplier's system • PreflightPrimaryStatus = supplier description of preflight status • PreflightPrimaryStatusCode = "Rejected"

Scenario E

e-Document	Preflight
ContentType	PreflightByPurchaseOrder
Scenario	Buyer/Publisher sends an InfoRequest to a Supplier for the status of prep content files sent for a specific Purchase Order under a previous trading partner agreement that the detail would be at the prep content file level; the InfoRequestType is "Preflight" and the PreflightRequestDetailType is "ByPurchaseOrder". Prep content files previously preflighted are for the text (interior) and cover of the book; no errors were detected.
Outcome	The Preflight e-Document is generated with data from the supplier's system and contains PreflightContentType and detail format of "PreflightByPurchaseOrder"; status is at the prep content file level.

Preflight

papiNet Standard – Version 2.31

Process	<p>The Preflight e-Document is generated that includes status of all files for the product; supplier's system is the source of all data</p> <ul style="list-style-type: none">• PreflightContentType = PreflightByPurchaseOrder• SenderParty = Buyer/Publisher• ReceiverParty = Supplier• BuyerParty = Buyer/Publisher• Detail format = PreflightByPurchaseOrder<ul style="list-style-type: none">• PurchaseOrderNumber = Purchase Order Number stored in the supplier's system <p>Status of the cover prep content file:</p> <ul style="list-style-type: none">• PrepContentName = name of file stored in the supplier's system for the cover component• PreflightStatusInformation<ul style="list-style-type: none">• PreflightPrimaryStatus = supplier description of preflight status• PreflightPrimaryStatusCode = "ActiveFree" <p>Status of the text (interior) prep content file:</p> <ul style="list-style-type: none">• PrepContentName = name of file stored in the supplier's system for the text (interior) component• PreflightStatusInformation<ul style="list-style-type: none">• PreflightPrimaryStatus = supplier description of preflight status• PreflightPrimaryStatusCode = "ActiveFree"
----------------	---