



papiNet

MeasuringInstruction

papiNet Standard - Version 2.31

Documentation

**Global Standard for the Paper and Forest
Products Supply Chain**

Build V2R31_20250325

Date 2025-04-03

Production Release

MeasuringInstruction

papiNet Standard – Version 2.31

Copyright

Copyright 2000 – 2025 the Confederation of European Paper Industries AISBL (“papiNet”) the “Copyright Owner”. All rights reserved by the Copyright Owner under the laws of the United States, Belgium, the European Economic Community, and all states, domestic and foreign. This document may be downloaded and copied provided that all copies retain and display the copyright and any other proprietary notices contained in this document. This document may not be sold, modified, edited, or taken out of context such that it creates a false or misleading statement or impression as to the purpose or use of the papiNet specification, which is an open standard. Use of this Standard, in accord with the foregoing limited permission, shall not create for the user any rights in or to the copyright, which rights are exclusively reserved to the Copyright Owner.

papiNet, and the members of all papiNet Groups (collectively and individually, "Presenters") make no representations or warranties, express or implied, including, but not limited to, warranties of merchantability, fitness for a particular purpose, title, or non-infringement. The presenters do not make any representation or warranty that the contents of this document are free from error, suitable for any purpose of any user, or that implementation of such contents will not infringe any third party patents, copyrights, trademarks or other rights. By making use of this document, the user assumes all risks and waives all claims against Presenters.

In no event shall Presenters be liable to user (or other person) for direct, indirect, special or consequential damages arising from or related to any use of this document, including, without limitation, lost profits, business interruption, loss of programs, or other data on your information handling system even if Presenters are expressly advised of the possibility of such damages.

Use of Documents in papiNet Implementations

Documents may be used as templates for a papiNet implementation. The Presenters grant the right to modify and edit them to fit an actual implementation project provided all copies display the copyright and any other proprietary notices contained in this document. Such modified documents must not be distributed beyond the trading partners implementing or maintaining a papiNet connection.

MeasuringInstruction papiNet Standard – Version 2.31

Table of Contents

Copyright	2
Use of Documents in papiNet Implementations	2
Table of Contents	3
MeasuringInstruction Documentation	4
MeasuringInstruction e-Document Overview	4
The Scope of the MeasuringInstruction	4
MeasuringInstructionType [attribute]	4
MeasuringInstructionContentType [Attribute]	5
Business Rules for MeasuringInstruction	5
Processing the MeasuringInstruction	5
Understanding the Diagrams and Content	6
MeasuringInstruction Root Element.....	8
MeasuringInstruction.....	8
Primary Elements	10
MeasuringInstructionHeader.....	10
MeasuringInstructionSequence	12
MeasuringInstructionSequenceLineItem.....	14
MeasuringInstructionSummary	15
MeasuringInstruction Business Scenarios.....	17
MeasuringInstruction Scenario Listing	17
Scenario A	18
Scenario B	19
Scenario C	20
Scenario D	22
Scenario E	23

MeasuringInstruction papiNet Standard – Version 2.31

MeasuringInstruction Documentation

MeasuringInstruction e-Document Overview

The MeasuringInstruction e-Document can be used to instruct a measuring party what to measure and how to measure it. Packages and loads as well as individual items can be measured. The e-Document sets the parameters for various measuring properties, quantities, and products.

The MeasuringInstructionType controls the usage of the MeasuringInstruction e-Document. It can be used to instruct to measure a shipment (several packages, items or loads) or to measure samples.

The MeasuringInstruction e-Document is typically used by the Forest Wood Supply & Bioproducts business, but can also be used by other businesses.

The Scope of the MeasuringInstruction

The MeasuringInstruction e-Document includes:

- Information about measuring location, measuring equipment and the party responsible for carrying out the measuring
- Measuring Specification including measuring procedures that is a legal requirement in some countries
- What to measure
 - The source products (Packages and loads as well as individual items in packages and loads)
 - Specific properties
 - Samples
- The method for finding what item or items to be measured

The MeasuringInstruction e-Document can include

- Business partners as well as the contract party
- Products that should be classified and reported based on measured properties.
- The validity period for the instruction
- Ship to destination
- Safety and environmental information

MeasuringInstructionType [attribute]

MeasuringInstructionType defines the type of MeasuringInstruction e-Document.

This item is restricted to the following list.

MeasuringInstruction papiNet Standard – Version 2.31

MeasuringInstruction

An instruction to measure products. Normally a measurement includes both quantity and quality.

SampleMeasuringInstruction

An instruction to measure samples to check the original measurements or to measure specific properties in for example a laboratory.

MeasuringInstructionContentType [Attribute]

Specifies the method for finding what item or items to be measured.

This item is restricted to the following list.

ByDeliverySource

Deliveries with a reference to a delivery source number.

ByLoad

A delivery with a reference to a specific transport.

ByOrder

Deliveries with a reference to an order number.

ByRandomSample

A random sample having a random sample number and a reference to an order number or a specific transport.

BySample

A sample having a sample number and a reference to an order number or a specific transport.

Business Rules for MeasuringInstruction

General Business Rules

Identifier	Business Rule
MI001	MeasuringInstructionLineItem is mandatory for MeasuringInstructionType MeasuringInstruction, which is used when products are measured.
MI002	Maximum allowed size of DocumentNumber is 30 characters.

Processing the MeasuringInstruction

MeasuringInstruction processing depends on the value in the status field MeasuringInstructionStatusType at the e-Document root level. There is only one status field in the e-Document.

Status Values Used When Processing the MeasuringInstruction

MeasuringInstruction papiNet Standard – Version 2.31

The following status values of MeasuringInstructionStatusType are used at the Contract root level:

- Original - The supplied information is the first version of that information.
- Replaced - The supplied information is replacing earlier supplied information. The receiver should revalidate the information in their system based upon the entire information received.
- Cancelled - The supplied information is cancelled.

MeasuringInstruction e-Document versions must be processed in an ascending order to ensure the correct processing of replacements and/or cancellations. Versions of MeasuringInstruction are controlled by TransactionHistoryNumber when it is supplied in the e-document. Otherwise it is controlled by the issue date and time of the e-document (DocumentIssueDate). Use of TransactionHistoryNumber is recommended. When TransactionHistoryNumber is not used, then the sender has to secure that two versions don't get the same issue date and time.

Processing order of a new version is determined by

1. TransactionHistoryNumber is higher in the new version than in earlier processed versions of MeasuringInstruction with the same DocumentNumber and the same SenderParty.
2. If TransactionHistoryNumber isn't used, then the issue date of the new version has to be later than the issue date of earlier processed versions of MeasuringInstruction with the same DocumentNumber and the same SenderParty.

When a replaced e-document comes as the first e-document the receiving party must be able to accept a replace without having the original e-document.

E-document versions not fulfilling above rules have to be rejected.

E.g. the replaced e-document might be the first one that arrives and it is updated in the system. Then later the original e-document arrives. In this case the original e-document must be rejected.

Understanding the Diagrams and Content

This section provides a graphical view of the schema structures, a discussion of the item's children. You can find additional information about papiNet and the standard at www.papiNet.org.

The graphics contain content model indicators, cardinality indicators, and data type information.

Associated with each graphic are the definitions for the parent item and any associated child items. All attributes are listed first, followed by the elements.

The following information should help you interpret and understand this standard. Please note the following:

Measuring Instruction

papiNet Standard – Version 2.31

- Content Model and Cardinality operate together to determine if the element or attribute are required in the instance document.
- The same attribute can never appear multiple times in the same element so, you will never see a multiple cardinality indicator.

Content model indicators:

There are three possible types of content: “sequence”, “choice”, and “all”. The papiNet standard currently does not use the “all” construct.

- (sequence)
The sequence of the items to the right of the graphic (or below the text) is required.
- (choice)
A choice of the items to the right of the graphic (or below the text) is permitted.
- (all)
All the items to the right of the graphic are required.

Cardinality indicators:

- Dotted line around element or attribute.
A single instance of the item can optionally exist.
- Dotted line around item with range indicated below.
Multiple instances of the item can optionally exist.
- Solid line around item.
A single instance of the item must exist.
- Solid line around item with range indicated below
At least one instance must exist; multiple instances can optionally exist.

Datatype indication:

When a data type is assigned to an element (either a simple type or complex type the name of the data type is presented beneath the item name in the graphic.

- In some cases additional information about the data type is presented (the default value).

Elements can either have content that is textual/numeric in nature or content that is made up of additional elements and/or attributes.

- When the content is textual/numeric in nature “three straight horizontal lines” will appear in the upper left-hand corner of the graphic. Pay attention to these elements because they are where you will be entering your information.
- When the content is made up of additional elements and/or attributes a “gray-box” will appear on the right-hand side of the graphic.
- If the graphic shows both the horizontal lines and the gray-box then, in the papiNet standard, the content below the element are attributes.

MeasuringInstruction papiNet Standard – Version 2.31

MeasuringInstruction Root Element

MeasuringInstruction

The MeasuringInstruction element is the root element for the MeasuringInstruction e-Document.

The MeasuringInstruction e-Document can be used to instruct a measuring party what to measure and how to measure it. Packages and loads as well as individual items can be measured.

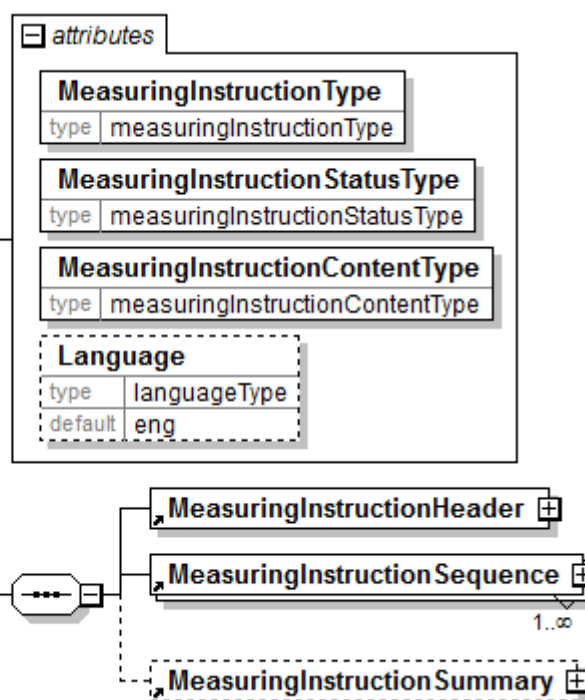
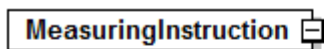

MeasuringInstructionType [attribute]

MeasuringInstructionType is mandatory. A single instance is required.

MeasuringInstructionType defines the type of MeasuringInstruction e-Document.

This item is restricted to the following list.

MeasuringInstruction

An instruction to measure products. Normally a measurement includes both quantity and quality.

SampleMeasuringInstruction

An instruction to measure samples to check the original measurements or to measure specific properties in for example a laboratory.

MeasuringInstructionStatusType [attribute]

MeasuringInstructionStatusType is mandatory. A single instance is required.

Identifies the status of the entire MeasuringInstruction e-Document.

This item is restricted to the following list.

Cancelled

The supplied information has been cancelled. Items that have been cancelled are not included in totals on the summary levels of the e-document.

Original

The supplied information is the first version of that information.

Replaced

The supplied information is replacing earlier supplied information. The receiver should revalidate the information in their system based upon the entire information received.

MeasuringInstructionContentType [attribute]

MeasuringInstruction

papiNet Standard – Version 2.31

MeasuringInstructionContentType is mandatory. A single instance is required.

Specifies the method for finding what item or items to be measured.

This item is restricted to the following list.

ByDeliverySource

Deliveries with a reference to a delivery source number.

ByLoad

A delivery with a reference to a specific transport.

ByOrder

Deliveries with a reference to an order number.

ByRandomSample

A random sample having a random sample number and a reference to an order number or a specific transport.

BySample

A sample having a sample number and a reference to an order number or a specific transport.

Language [attribute]

Language is optional. A single instance might exist.

The valid Alpha 2- and Alpha 3-character list of language codes in the ISO 639-1 and 639-2 international standards.

Information on the content of this attribute is available at:
https://www.loc.gov/standards/iso639-2/php/code_list.php

through the application of an addendum to the standard.

Refer to Language definition for any enumerations.

(sequence)

The sequence of items below is mandatory. A single instance is required.

MeasuringInstructionHeader

MeasuringInstructionHeader is mandatory. A single instance is required.

The MeasuringInstructionHeader contains information common to the entire MeasuringInstruction e-Document.

MeasuringInstructionSequence

MeasuringInstructionSequence is mandatory. One instance is required, multiple instances might exist.

A grouping element that contains information about a source product to be measured.

MeasuringInstructionSummary

MeasuringInstructionSummary is optional. A single instance might exist.

A grouping element that contains summary information that applies to the entire MeasuringInstruction e-Document.

MeasuringInstruction papiNet Standard – Version 2.31

Primary Elements

MeasuringInstructionHeader

The MeasuringInstructionHeader contains information common to the entire MeasuringInstruction e-Document.

(sequence)

The sequence of items below is mandatory. A single instance is required.

DocumentNumber

DocumentNumber mandatory. A single instance is required.

The unique identifier of a document.

DocumentIssueDate

DocumentIssueDate is mandatory. A single instance is required.

The date and time when the e-Document was issued.

TransactionHistoryNumber

TransactionHistoryNumber is optional. A single instance might exist.

A

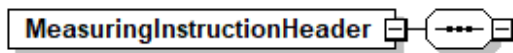

sequential number that keeps track of the version of a document.

However when the document is a confirmation document, in which case the TransactionHistoryNumber refers to the trigger transaction for the confirmation.

MeasuringInstructionTitle

MeasuringInstructionTitle is optional. Multiple instances might exist.

A text describing the context of the MeasuringInstruction.

SenderParty

SenderParty is optional. A single instance might exist.

The business entity issuing the e-Document, the source of the document.

- The entity responsible for the content. If the sender party has out sourced the message service to a third party the SenderParty is the issuer of the e-Document and not the party performing the transmission service of the electronic message.

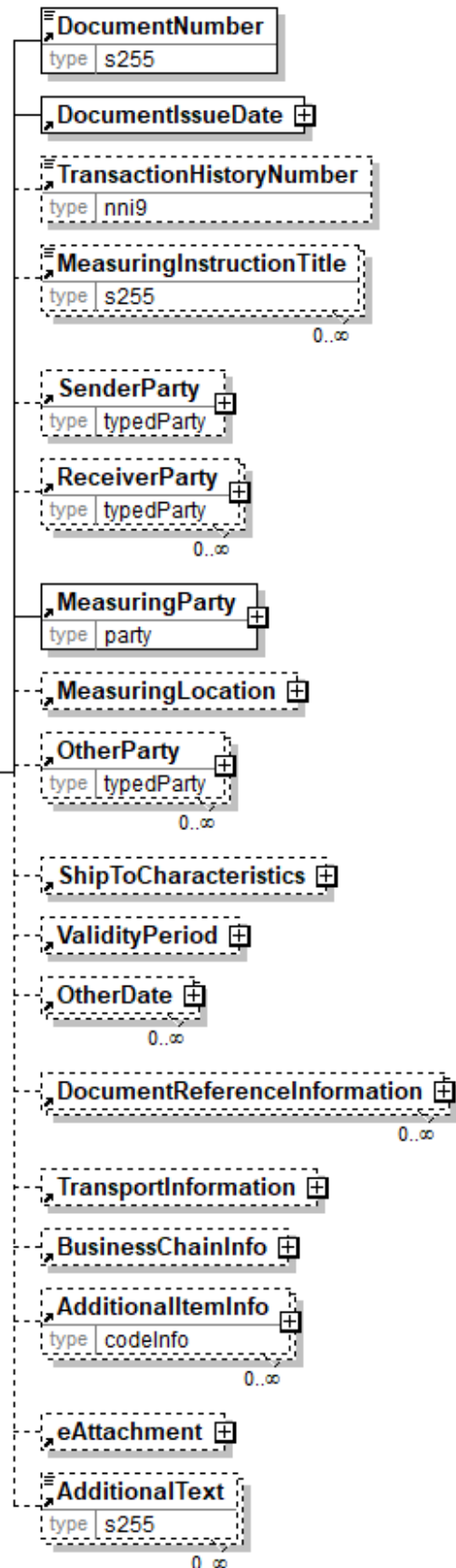

MeasuringInstruction

papiNet Standard – Version 2.31

ReceiverParty

ReceiverParty is optional. Multiple instances might exist.

The business entity for whom the e-Document is intended, the destination of the document.

- The entity interested in the content. If the receiver party has outsourced the message service to a third party the ReceiverParty is the intended party for the e-Document and not the party performing the receiving service of the electronic message.

MeasuringParty

MeasuringParty is mandatory. A single instance is required.

The party that is responsible for the measurements at the measuring location.

MeasuringLocation

ReceiverParty is optional. A single instance might exist.

A grouping element that contains information about where the measuring is taken place.

OtherParty

OtherParty is optional. Multiple instances might exist.

An organisation or business entity other than those specifically detailed within a e-Document.

ShipToCharacteristics

ShipToCharacteristics is optional. A single instance might exist.

A group item that provides information important for the Ship-To Party.

ValidityPeriod

ValidityPeriod is optional. A single instance might exist.

The validity period for a specific item, e.g. the validity period for an e-Document.

OtherDate

OtherDate is optional. Multiple instances might exist.

A date that may not be specifically detailed within a document (example: print date at the PurchaseOrderLineItem).

DocumentReferenceInformation

DocumentReferenceInformation is optional. Multiple instances might exist.

A group item containing reference information applicable to a document.

TransportInformation

TransportInformation is optional. A single instance might exist.

A grouping element for transport information.

BusinessChainInfo

BusinessChainInfo is optional. A single instance might exist.

A grouping element that contains information about parties in the business chain when products or services are traded in many levels.

The business chain starts at the sourcing end where products are provided when BusinessChainContextType = Product.

The business chain starts at the purchasing of a service from the

MeasuringInstruction

papiNet Standard – Version 2.31

OriginalLogisticsSupplier when BusinessChainContextType = LogisticsService.

AdditionalItemInfo

AdditionalItemInfo is optional. Multiple instances might exist.

A grouping element that contains information about additional items specified by an agency. Restricted use of this element is recommended.

eAttachment

eAttachment is optional. A single instance might exist.

eAttachment enables the sender to provide information about attachments to the document.

Note: An element "e-Attachment" also exists. papiNet will no longer use hyphens in our element and attribute names as this causes issues with BizTalk.

AdditionalText

AdditionalText is optional. Multiple instances might exist.

A text field that is used to communicate information not previously defined or for special instructions. To be used only for circumstances not covered by specific elements.

MeasuringInstructionSequence

A grouping element that contains information about a source product to be measured.

(sequence)

The sequence of items below is mandatory. A single instance is required.

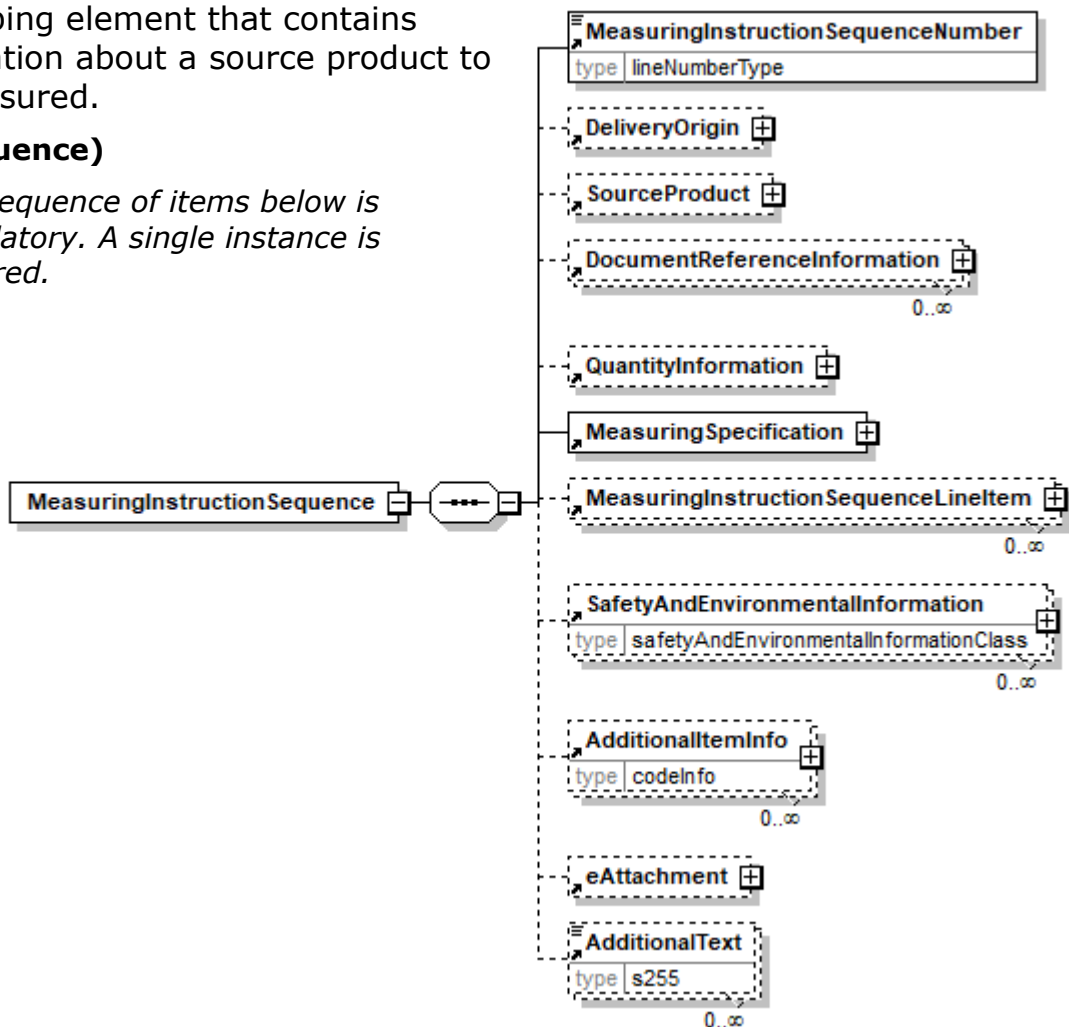

MeasuringInstruction papiNet Standard – Version 2.31

MeasuringInstructionSequenceNumber

MeasuringInstructionSequenceNumber is mandatory. A single instance is required.

A sequential number that uniquely identifies the sequence in a MeasuringInstruction e-Document.

DeliveryOrigin

DeliveryOrigin is optional. A single instance might exist.

A group item that represents the start of one leg in a route. Compare to DeliveryDestination.

- The DeliveryOrigin specifies the start of one leg of the delivery.
- In order to comply with the US Trade Act of 2002 you would use this element with a LocationParty/@PartyType of Port.

SourceProduct

SourceProduct is optional. A single instance might exist.

SourceProduct is a group element defining the product that is available for measuring.

The measuring of this product is done according to the measuring rules for the contracted product, which usually is the same product. But in some cases the product available for measuring is different from the contracted product. In these cases, the product available for measuring shall be measured according to the measuring rules for the MeasuringProduct specified in MeasuringSpecification.

For example, Pulpwood is produced but it is of very bad quality because of long time storage in the forest. This pulpwood will be sold as fire wood and shall when delivered be measured according to the measuring rules for firewood.

DocumentReferenceInformation

DocumentReferenceInformation is optional. Multiple instances might exist.

A group item containing reference information applicable to a document.

QuantityInformation

QuantityInformation is optional. A single instance might exist.

A group item containing information about quantity and informational quantity of similar items.

MeasuringSpecification

MeasuringSpecification is mandatory. A single instance is required.

A grouping element that contains a specification for measurement procedures for a measuring party at a measuring location.

MeasuringInstructionSequenceLineItem

MeasuringInstructionSequenceLineItem is optional. Multiple instances might exist.

A grouping element that contains information for a line item of the MeasuringInstructionSequence. The line item specifies detail information associated with a product.

SafetyAndEnvironmentalInformation

SafetyAndEnvironmentalInformation is optional. Multiple instances might exist.

A group element that contains safety and environmental information for the goods.

AdditionalItemInfo

AdditionalItemInfo is optional. Multiple instances might exist.

MeasuringInstruction

papiNet Standard – Version 2.31

A grouping element that contains information about additional items specified by an agency. Restricted use of this element is recommended.

eAttachment

eAttachment is optional. A single instance might exist.

eAttachment enables the sender to provide information about attachments to the document.

Note: An element "e-Attachment" also exists. papiNet will no longer use hyphens in our element and attribute names as this causes issues with BizTalk.

AdditionalText

AdditionalText is optional. Multiple instances might exist.

A text field that is used to communicate information not previously defined or for special instructions. To be used only for circumstances not covered by specific elements.

MeasuringInstructionSequenceLineItem

A grouping element that contains information for a line item of the

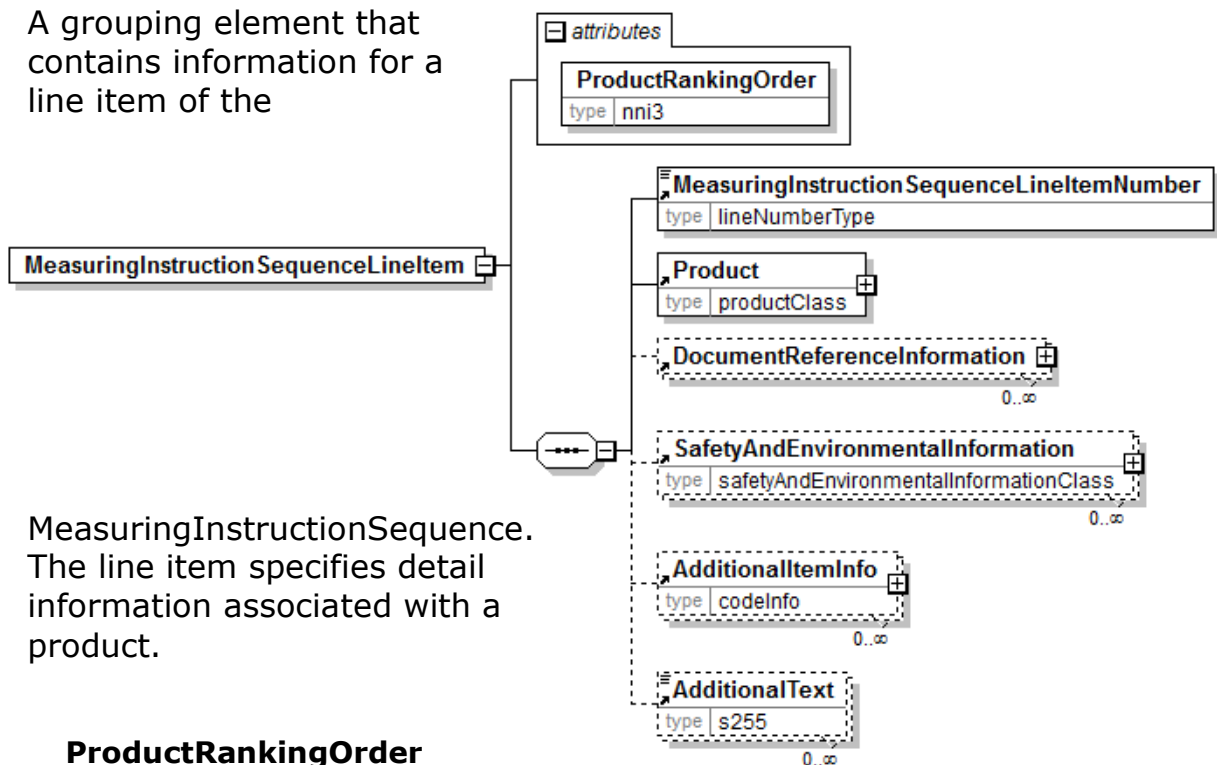

MeasuringInstructionSequence. The line item specifies detail information associated with a product.

ProductRankingOrder [Attribute]

ProductRankingOrder is mandatory. A single instance is required.

Defines the order of products to choose when available product properties are applicable to specifications of more than one product. ProductRankingOrder is a positive number. Value 1 has the highest rank.

(sequence)

The sequence of items below is mandatory. A single instance is required.

MeasuringInstructionSequenceLineItemNumber

MeasuringInstructionSequenceLineItemNumber is mandatory. A single instance is

MeasuringInstruction papiNet Standard – Version 2.31

required.

A sequential number that uniquely identifies the line item of the MeasuringInstructionSequence.

Product

Product is mandatory. A single instance is required.

Product is a group item defining the article and its characteristics. Product is used to specify product characteristics organized by ProductIdentifier, ProductDescription, and Classification. Book Manufacturing, Forest Wood, Label Stock, Paper, Pulp, Recovered Paper, Wood Products, and Virgin Fibre market segments have defined their product characteristics and conversion features for implementation in papiNet.

DocumentReferenceInformation

DocumentReferenceInformation is optional. Multiple instances might exist.

A group item containing reference information applicable to a document.

SafetyAndEnvironmentalInformation

SafetyAndEnvironmentalInformation is optional. Multiple instances might exist.

A group element that contains safety and environmental information for the goods.

AdditionalItemInfo

AdditionalItemInfo is optional. Multiple instances might exist.

A grouping element that contains information about additional items specified by an agency. Restricted use of this element is recommended.

AdditionalText

AdditionalText is optional. Multiple instances might exist.

A text field that is used to communicate information not previously defined or for special instructions. To be used only for circumstances not covered by specific elements.

MeasuringInstructionSummary

A grouping element that contains summary information that applies to the entire MeasuringInstruction e-Document.

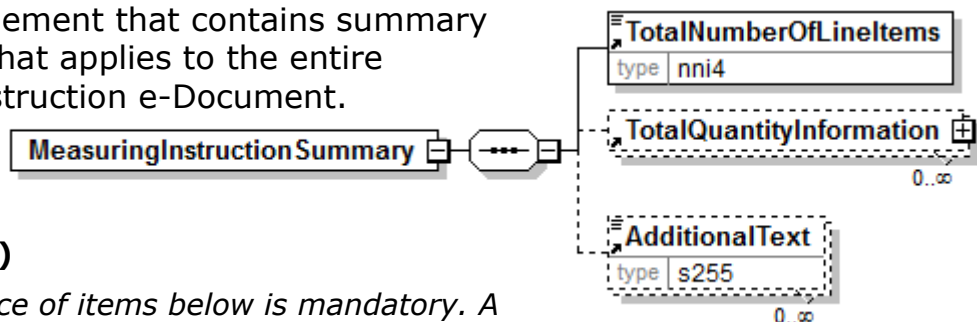

(sequence)

The sequence of items below is mandatory. A single instance is required.

TotalNumberOfLineItems

TotalNumberOfLineItems is optional. A single instance might exist.

The total number of individual line items in the document, regardless of the status or type.

TotalQuantityInformation

TotalQuantityInformation is optional. A single instance might exist.

MeasuringInstruction papiNet Standard – Version 2.31

A group item containing information about the total quantity and total informational quantity of similar items in the document.

TotalQuantityInformation is primarily used in the summary section of e-Documents where it is repeatable to permit totalling for different units of measure.

AdditionalText

AdditionalText is optional. Multiple instances might exist.

A text field that is used to communicate information not previously defined or for special instructions. To be used only for circumstances not covered by specific elements.

MeasuringInstruction papiNet Standard – Version 2.31

MeasuringInstruction Business Scenarios

MeasuringInstruction Scenario Listing

Scenario A	MeasuringInstruction for deliveries of pulp wood according to an order.
Scenario B	MeasuringInstruction for deliveries of pine saw timber according to an order.
Scenario C	MeasuringInstruction for a specific delivery of a bioproduct (for example Crude Tall Oil).
Scenario D	MeasuringInstruction to measure by item a random sample of pulp wood originally measured by package.
Scenario E	MeasuringInstruction to measure moisture in a sample taken from a delivery of chips (biofuel) .

MeasuringInstruction papiNet Standard – Version 2.31

Scenario A

E-document	MeasuringInstruction
Type	MeasuringInstruction
Scenario	<p>The buyer of pulp wood sends a MeasuringInstruction to the Measuring Party specifying how to measure deliveries that is part of the specified order.</p> <p>The deliveries are measured by package.</p>
Outcome	The Measuring Party knows how to measure deliveries of pulp wood that is a part of the specified order.
Initiator	Buyer
Receiver	Measuring Party
Preconditions	
Trigger	A purchase order sent from the buyer is confirmed by the supplier.
Step 1	<p>The buyer sends a MeasuringInstruction to the Measuring Party. The following information that is included in the MeasuringInstruction is particular to this scenario.</p> <p>Root:</p> <ul style="list-style-type: none"> • MeasuringInstructionType = MeasuringInstruction • MeasuringInstructionContentType = ByOrder <p>Header:</p> <ul style="list-style-type: none"> • SenderParty = Buyer • ReceiverParty = Measuring Party • MeasuringParty = Measuring Party • OtherParty = Supplier • MeasuringLocation • ShipToCharacteristics <p>Sequence:</p> <ul style="list-style-type: none"> • SourceProduct = The product to be measured • DocumentReferenceInformation = Reference to an OrderNumber • QuantityInformation = Quantity of the SourceProduct • MeasuringSpecification <ul style="list-style-type: none"> • MeasuringType = ByPackage

MeasuringInstruction papiNet Standard – Version 2.31

	<ul style="list-style-type: none"> • MeasuringCodeInfo = Details for measuring procedures • MeasurementSpecification = Details about what to measure <p>Line Item:</p> <ul style="list-style-type: none"> • ProductRankingOrder • Product = Product that should be classified and reported based on measured properties. <p>MeasuringInstructionSummary:</p> <ul style="list-style-type: none"> • Summary information for the whole e-Document.
Result	The Measuring Party knows how to measure deliveries that is part of this order.

Scenario B

E-document	MeasuringInstruction
Type	MeasuringInstruction
Scenario	<p>The buyer of pine saw timber sends a MeasuringInstruction to the Measuring Party specifying how to measure deliveries that is part of the specified order.</p> <p>The deliveries are measured log by log.</p>
Outcome	The Measuring Party knows how to measure deliveries of pine saw timber that is a part of the specified order.
Initiator	Buyer
Receiver	Measuring Party
Preconditions	
Trigger	A purchase order sent from the buyer is confirmed by the supplier.
Step 1	<p>The buyer sends a MeasuringInstruction to the Measuring Party. The following information that is included in the MeasuringInstruction is particular to this scenario.</p> <p>Root:</p> <ul style="list-style-type: none"> • MeasuringInstructionType = MeasuringInstruction • MeasuringInstructionContentType = ByOrder <p>Header:</p> <ul style="list-style-type: none"> • SenderParty = Buyer

MeasuringInstruction papiNet Standard – Version 2.31

	<ul style="list-style-type: none"> • ReceiverParty = Measuring Party • MeasuringParty = Measuring Party • OtherParty = Supplier • MeasuringLocation • ShipToCharacteristics <p>Sequence:</p> <ul style="list-style-type: none"> • SourceProduct = The product to be measured • DocumentReferenceInformation = Reference to a OrderNumber • QuantityInformation = Quantity of the SourceProduct • MeasuringSpecification <ul style="list-style-type: none"> • MeasuringType = ByItem • MeasuringCodeInfo = Details for measuring procedures • MeasurementSpecification = Details about what to measure <p>Line Item:</p> <ul style="list-style-type: none"> • ProductRankingOrder • Product = Product that should be classified and reported based on measured properties. <p>MeasuringInstructionSummary:</p> <ul style="list-style-type: none"> • Summary information for the whole e-Document.
Result	The Measuring Party knows how to measure deliveries that is part of this order.

Scenario C

E-document	MeasuringInstruction
Type	MeasuringInstruction
Scenario	<p>The buyer of a load of a specific bioproduct sends a MeasuringInstruction to the Measuring Party specifying how to measure this specific load delivered by a specific transport vehicle.</p> <p>The delivery is measured by package.</p>
Outcome	The Measuring Party knows how to measure this specific load of a bioproduct.
Initiator	Buyer
Receiver	Measuring Party
Precondi-	

MeasuringInstruction papiNet Standard – Version 2.31

tions	
Trigger	A purchase order sent from the buyer is confirmed by the supplier.
Step 1	<p>The buyer sends a MeasuringInstruction to the Measuring Party. The following information that is included in the MeasuringInstruction is particular to this scenario.</p> <p>Root:</p> <ul style="list-style-type: none"> • MeasuringInstructionType = MeasuringInstruction • MeasuringInstructionContentType = ByLoad <p>Header:</p> <ul style="list-style-type: none"> • SenderParty = Buyer • ReceiverParty = Measuring Party • MeasuringParty = Measuring Party • OtherParty = Supplier • MeasuringLocation • ShipToCharacteristics • DocumentReferenceInformation = Reference to the DeliveryMessageNumber for the delivery • TransportInformation <ul style="list-style-type: none"> • TransportModeType = Road • TransportVehicleIdentifier • TransportUnitIdentifier <p>Sequence:</p> <ul style="list-style-type: none"> • SourceProduct = The product to be measured • QuantityInformation = Quantity of the SourceProduct • MeasuringSpecification <ul style="list-style-type: none"> • MeasuringType = ByPackage • MeasuringCodeInfo = Details for measuring procedures • MeasurementSpecification = Details about what to measure <p>Line Item:</p> <ul style="list-style-type: none"> • ProductRankingOrder • Product = Product that should be classified and reported based on measured properties. <p>MeasuringInstructionSummary:</p> <ul style="list-style-type: none"> • Summary information for the whole e-Document.
Result	The Measuring Party knows how to measure this specific load.

MeasuringInstruction papiNet Standard – Version 2.31

Scenario D

E-document	MeasuringInstruction
Type	SampleMeasuringInstruction
Scenario	The buyer of pulp wood sends a MeasuringInstruction to the Measuring Party specifying how to measure random samples of pulp wood. The measuring system will randomly pick packages as random samples during measuring of packages that are part of deliveries of pulp wood on a specified order. A sample is assigned a RandomSampleNumber that is also reported on the package in the original measuring report (MeasuringTicket). Samples will be measured log by log to control the accuracy of the original measuring by package.
Outcome	To measure a sample by another measuring method to control the accuracy of the original measuring.
Initiator	Buyer
Receiver	Measuring Party
Preconditions	Processing of random samples should be agreed.
Trigger	A purchase order sent from the buyer is confirmed by the supplier. Processing of random samples is agreed for this order.
Step 1	<p>The buyer sends a MeasuringInstruction to the Measuring Party. The following information that is included in the MeasuringInstruction is particular to this scenario.</p> <p>Root:</p> <ul style="list-style-type: none"> • MeasuringInstructionType = SampleMeasuringInstruction • MeasuringInstructionContentType = ByRandomSample <p>Header:</p> <ul style="list-style-type: none"> • SenderParty = Buyer • ReceiverParty = Measuring Party • MeasuringParty = Measuring Party • OtherParty = Supplier • MeasuringLocation <p>Sequence:</p>

MeasuringInstruction papiNet Standard – Version 2.31

	<ul style="list-style-type: none"> • SourceProduct = The product to be measured • DocumentReferenceInformation = Reference to an OrderNumber • MeasuringSpecification <ul style="list-style-type: none"> • MeasuringType = ByItem • MeasuringCodeInfo = Details for measuring procedures • MeasurementSpecification = Details about what to measure <p>Line Item:</p> <ul style="list-style-type: none"> • ProductRankingOrder • Product = Product that should be classified and reported based on measured properties. <p>MeasuringInstructionSummary:</p> <ul style="list-style-type: none"> • Summary information for the whole e-Document.
Result	The sample will be measured by item to control the accuracy of by package measurement.

Scenario E

E-document	MeasuringInstruction
Type	SampleMeasuringInstruction
Scenario	A small sample is taken from every delivery to determine the moisture in the delivery. The sample is sent to a laboratory for measurement. A measuring instruction is sent to the laboratory.
Outcome	The laboratory knows what to do with the sample.
Initiator	Measuring Party for products
Receiver	Laboratory
Preconditions	
Trigger	A sample is taken that needs analysis in a laboratory.
Step 1	<p>The Measuring Party sends a MeasuringInstruction to the Laboratory. The following information that is included in the MeasuringInstruction is particular to this scenario.</p> <p>Root:</p> <ul style="list-style-type: none"> • MeasuringInstructionType = SampleMeasuringInstruction

MeasuringInstruction papiNet Standard – Version 2.31

	<ul style="list-style-type: none"> • MeasuringInstructionContentType = BySample <p>Header:</p> <ul style="list-style-type: none"> • SenderParty = Measuring Party for products • ReceiverParty = Laboratory • MeasuringParty = Laboratory • MeasuringSpecification <ul style="list-style-type: none"> • MeasuringType = Bypackage • MeasuringLocation • DocumentReferenceInformation = Reference to a SampleNumber • DocumentReferenceInformation = Reference to the DeliveryMessageNumber for the delivery • <p>Sequence:</p> <ul style="list-style-type: none"> • SourceProduct = The product of the sample. • DocumentReferenceInformation = Reference to a OrderNumber • MeasuringSpecification <ul style="list-style-type: none"> • MeasuringType = ByPackage • MeasuringCodeInfo = Details for measuring procedures • MeasurementSpecification = Details about what to measure
Result	The moisture in the sample will be measured by the laboratory.